

**ELECTROMAGNETIC EMISSIONS COMPLIANCE REPORT
INTENTIONAL RADIATOR CERTIFICATION TO
FCC PART 15 SUBPART C REQUIREMENT**

OF

LED TV

**Model No.: LE-40GCL-A, SE40FY19-O, SE40FY19T, CW40XXXXXXXXXX,
VR-XXXXXXXXXX, SEXXXXXXXXXX, ELXXXXXXXXXX, LE40GXXXXXXXXXX,
LE-40GXXXXXXXXXX (where X would be any Arabic number or English
letter or blank)**

FCC ID: 2ACWISE40FY19C

Trademark: THTF, Fluid, Westinghouse, Seiki, Element

Report No.: KAD141009004E

Issue Date: October 29, 2014

Prepared for

**Shenyang Tongfang Multimedia Technology Co., Limited
No.10 Nanping East Road HunNan New District Shenyang, LiaoNing
Province P.R .China**

Prepared by

**DONGGUAN EMTEK CO., LTD.
No.281, Guantai Road, Nancheng District,
Dongguan, Guangdong, China
TEL: 86-769-22807078
FAX: 86-769-22807079**

VERIFICATION OF COMPLIANCE

Applicant:	Shenyang Tongfang Multimedia Technology Co., Limited No.10 Nanping East Road Hunnan New District Shenyang, Liaoning Province P.R .China
Manufacturer:	Shenyang Tongfang Multimedia Technology Co., Limited No.10 Nanping East Road Hunnan New District Shenyang, Liaoning Province P.R .China
Product Description:	LED TV
Model Number:	LE-40GCL-A, SE40FY19-O, SE40FY19T, CW40XXXXXXXXXX, VR-XXXXXXXXXX, SEXXXXXXXXXXX, ELXXXXXXXXXX, LE40GXXXXXXXXXX, LE-40GXXXXXXXXXX (where X would be any Arabic number or English letter or blank)
File Number:	KAD141009004E
Date of Test:	October 09, 2014 to October 25, 2014

We hereby certify that:

The above equipment was tested by DONGGUAN EMTEK CO., LTD. The test data, data evaluation, test procedures, and equipment configurations shown in this report were made in accordance with the procedures given in ANSI C63.4 (2009) and the energy emitted by the sample EUT tested as described in this report is in compliance with conducted and radiated emission limits of FCC Rules Part 15.247(2013).

The test results of this report relate only to the tested sample identified in this report.

Approved By



**Sam Lv / Q.A. Manager
DONGGUAN EMTEK CO., LTD.**

Modified Information

Version	Summary	Revision Date	Report No.
Ver.1.0	Original Report	/	KAD141009004E

Table of Contents

1. GENERAL INFORMATION	6
1.1 PRODUCT DESCRIPTION	6
1.2 RELATED SUBMITTAL(S) / GRANT(S)	6
1.3 TEST METHODOLOGY	7
1.4 SPECIAL ACCESSORIES.....	7
1.5 EQUIPMENT MODIFICATIONS.....	7
1.6 TEST FACILITY.....	7
2. SYSTEM TEST CONFIGURATION	8
2.1 EUT CONFIGURATION.....	8
2.2 EUT EXERCISE	8
2.3 TEST PROCEDURE.....	8
2.4 CONFIGURATION OF TESTED SYSTEM	8
3. DESCRIPTION OF TEST MODES.....	9
4. SUMMARY OF TEST RESULTS.....	10
5. CONDUCTED EMISSIONS TEST	11
5.1 MEASUREMENT PROCEDURE	11
5.2 TEST SET-UP (BLOCK DIAGRAM OF CONFIGURATION)	11
5.3 MEASUREMENT EQUIPMENT USED	11
5.4 CONDUCTED EMISSION LIMIT	11
5.5 MEASUREMENT RESULT.....	12
6. RADIATED EMISSION TEST.....	14
6.1 MEASUREMENT PROCEDURE	14
6.2 TEST SET-UP (BLOCK DIAGRAM OF CONFIGURATION)	15
6.3 MEASUREMENT EQUIPMENT USED	16
6.4 RADIATED EMISSION LIMIT	16
6.5 MEASUREMENT RESULT.....	18
7. 6DB BANDWIDTH TEST	27
7.1 MEASUREMENT PROCEDURE	27
7.2 TEST SET-UP (BLOCK DIAGRAM OF CONFIGURATION)	27
7.3 MEASUREMENT EQUIPMENT USED	27
7.4 MEASUREMENT RESULTS.....	27
8. MAXIMUM PEAK OUTPUT POWER TEST	36
8.1 MEASUREMENT PROCEDURE	36
8.2 TEST SET-UP (BLOCK DIAGRAM OF CONFIGURATION)	36
8.3 MEASUREMENT EQUIPMENT USED	36
8.4 PEAK POWER OUTPUT LIMIT	36
8.5 MEASUREMENT RESULTS.....	36
9. BAND EDGE TEST	37
9.1 MEASUREMENT PROCEDURE	37
9.2 TEST SET-UP (BLOCK DIAGRAM OF CONFIGURATION)	38
9.3 MEASUREMENT EQUIPMENT USED	38
9.4 MEASUREMENT RESULTS.....	38
10. POWER DENSITY.....	51
10.1 TEST EQUIPMENT	51
10.2 MEASURING INSTRUMENTS AND SETTING.....	51
10.3 TEST PROCEDURES.....	51

10.4	BLOCK DIAGRAM OF TEST SETUP	51
10.5	LIMIT.....	51
10.6	TEST RESULT	52
11.	ANTENNA PORT EMISSION.....	60
11.1	TEST EQUIPMENT	60
11.2	MEASURING INSTRUMENTS AND SETTING.....	60
11.3	TEST PROCEDURES.....	60
11.4	BLOCK DIAGRAM OF TEST SETUP	60
11.5	TEST RESULT	60
12.	ANTENNA APPLICATION	67
12.1	ANTENNA REQUIREMENT	67
12.2	RESULT.....	67

APPENDIX I (PHOTOS OF EUT)(4 PAGES)

1. General Information

1.1 Product Description

A major technical descriptions of EUT is described as following:

- A). Operation Frequency: 2412-2462MHz for 802.11b/g/n(H20) ;
2422-2452MHz for 802.11n(H40)
- B). Modulation: OFDM with BPSK/QPSK/16QAM/64QAM for 802.11g/n,
DSSS with DBPSK/DQPSK/CCK for 802.11b;
- C). Number of Channel: 11 Channels for 802.11b/g/n(H20)
7 Channels for 802.11n(H40)
- D). Antenna Type: PCB antenna
- E). Antenna Gain: 2dBi
- F). Power Supply: AC 100V-240V, 50/60Hz, 90W

Channel	Frequency (MHz)	Channel	Frequency (MHz)	Channel	Frequency (MHz)
1	2412	5	2432	9	2452
2	2417	6	2437	10	2457
3	2422	7	2442	11	2462
4	2427	8	2447		

Note:

1. This device is included 802.11b, 802.11g and 802.11n(H20), 802.11n(H40) 2.4GHz transceiver function.
2. Test of channel was included the lowest middle and highest frequency in lowest data rate and to perform the test, then record on this report.

1.2 Related Submittal(s) / Grant(s)

This submittal(s) (test report) is intended for filing to comply with Section 15.247 of the FCC Part 15, Subpart C Rules. The composite system is compliance with Subpart B is authorized under a DOC procedure.

1.3 Test Methodology

All the test program has follow FCC new test procedure KDB558074 D01 v03r02, Both conducted and radiated testing was performed according to the procedures in ANSI C63.10 (2009). Radiated testing was performed at an antenna to EUT distance 3 meters.

1.4 Special Accessories

Not available for this EUT intended for grant.

1.5 Equipment Modifications

Not available for this EUT intended for grant.

1.6 Test Facility

Site Description

EMC Lab :

Accredited by FCC, June 18, 2014
The Certificate Number is 247565

Accredited by Industry Canada, February 19, 2014
The Certificate Number is 9444A

Name of Firm : DONGGUAN EMTEK CO., LTD.

Site Location : No.281, Guantai Road, Nancheng District,
Dongguan, Guangdong, China

2. System Test Configuration

2.1 EUT Configuration

The EUT configuration for testing is installed on RF field strength measurement to meet the Commissions requirement and operating in a manner which intends to maximize its emission characteristics in a continuous normal application.

2.2 EUT Exercise

The Transmitter was operated in the normal operating mode. The TX frequency was fixed which was for the purpose of the measurements.

2.3 Test Procedure

2.3.1 Conducted Emissions

The EUT is a placed on as turn table which is 0.8 m above ground plane. According to the requirements in Section 13.1.4.1 of ANSI C63.4-2009 Conducted emissions from the EUT measured in the frequency range between 0.15 MHz and 30 MHz using CISPR Quasi-Peak and average detector mode.

2.3.2 Radiated Emissions

The EUT is a placed on as turn table which is 0.8 m above ground plane. The turn table shall rotate 360 degrees to determine the position of maximum emission level. EUT is set 3m away from the receiving antenna which varied from 1m to 4m to find out the highest emission. And also, each emission was to be maximized by changing the polarization of receiving antenna both horizontal and vertical. In order to find out the max. Emission, the relative positions of this hand-held transmitter (EUT) was rotated through three orthogonal axes according to the requirements in Section 13.1.4.1 of ANSI C63.4-2009.

2.4 Configuration of Tested System

Fig. 2-1 Configuration of Tested System

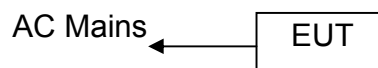

Table 2-1 Equipment Used in Tested System

Item	Equipment	Trademark	Model No.	FCC ID	Note
1.	LED TV	SEIKI	SE40FY19T	2ACWISE40FY19C	EUT

Note:

- (1) Unless otherwise denoted as EUT in 『Remark』 column, device(s) used in tested system is a support equipment.

3. Description of Test Modes

The Transmitter of EUT is an Internet Tablet and powered by host equipment; these is Digital Transmission system (DTS) and have modulation OFDM, DSSS, DBPSK, DQPSK, CCK, 16QAM, 64QAM. According exploratory test, EUT will have maximum output power in those data rate (802.11b: 1 Mbps; 802.11g: 6 Mbps; 802.11n : MCS0), so those data rate were used for all test.

For 802.11b/g/n(H20) :

1. For lowest channel : 2412MHz (Channel 1)
2. For middle channel : 2437MHz (Channel 6)
3. For highest channel: 2462MHz (Channel 11)

For 802.11n(H40):

1. For lowest channel : 2422MHz (Channel 3)
2. For middle channel : 2437MHz (Channel 6)
3. For highest channel: 2452MHz (Channel 9)

4. Summary of Test Results

FCC Rules	Description Of Test	Result
§15.247(a)(2)	6dB bandwidth	Pass
§15.247(b)(3)	Max Peak output Power test	Pass
§15.247(e)	Power density	Pass
§15.247(d)	Band edge test	Pass
§15.207	AC Power Conducted Emission	Pass
§15.247(d), §15.209	Radiated Emission	Pass
§15.247(d)	Antenna Port Emission	Pass
§15.247(b)&§15.203	Antenna Application	Pass

5. Conducted Emissions Test

5.1 Measurement Procedure

1. The EUT was placed on a table which is 0.8m above ground plane.
2. Maximum procedure was performed on the six highest emissions to ensure EUT compliance.
3. Repeat above procedures until all frequency measured were complete.

5.2 Test SET-UP (Block Diagram of Configuration)

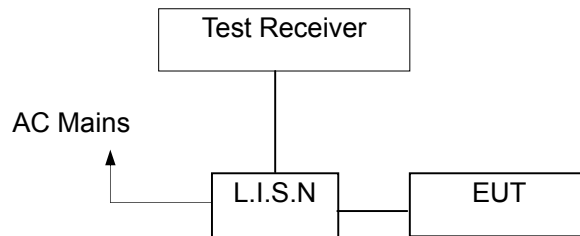

5.3 Measurement Equipment Used

Item	Equipment	Manufacturer	Model No.	Serial No.	Last Cal.	Cal. Interval
1.	Test Receiver	Rohde&Schwarz	ESCS30	100018	May 16, 2014	1 Year
2.	L.I.S.N.	Rohde&Schwarz	ENV216	100017	May 16, 2014	1Year
3.	RF Switching Unit	CDS	RSU-M2	38401	May 16, 2014	1Year

5.4 Conducted Emission Limit

Conducted Emission Frequency(MHz)	Quasi-peak	Average
0.15-0.5	66-56	56-46
0.5-5.0	56	46
5.0-30.0	60	50

- Note:** 1. The lower limit shall apply at the transition frequencies
 2. The limit decreases in line with the logarithm of the frequency in the range of 0.15 to 0.50MHz.

5.5 Measurement Result

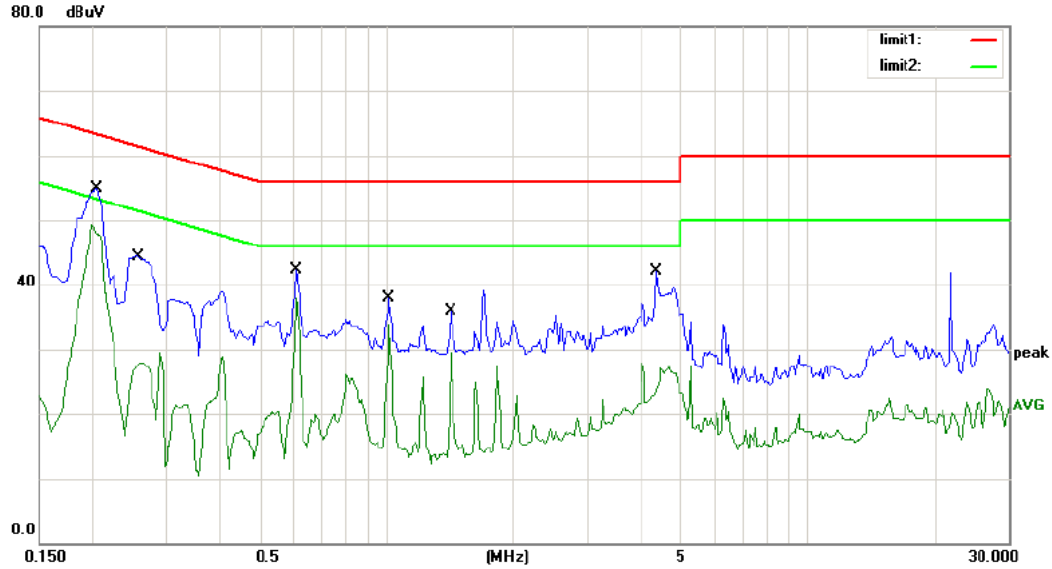

Site site #1 Phase: **L1** Temperature: 24
 Limit: (CE)FCC PART 15 class B_QP Power: AC 120V/60Hz Humidity: 55 %
 Mode: WIFI Link
 Note:

No.	Mk.	Freq. MHz	Reading Level dBuV	Correct Factor dB	Measure- ment dBuV	Limit dBuV	Over dB	Detector	Comment
1		0.2050	53.80	0.00	53.80	63.41	-9.61	QP	
2	*	0.2050	49.38	0.00	49.38	53.41	-4.03	AVG	
3		0.2600	42.40	0.00	42.40	61.43	-19.03	QP	
4		0.2600	27.99	0.00	27.99	51.43	-23.44	AVG	
5		0.6100	41.30	0.00	41.30	56.00	-14.70	QP	
6		0.6100	37.84	0.00	37.84	46.00	-8.16	AVG	
7		1.0200	35.90	0.00	35.90	56.00	-20.10	QP	
8		1.0200	33.95	0.00	33.95	46.00	-12.05	AVG	
9		1.4250	32.60	0.00	32.60	56.00	-23.40	QP	
10		1.4250	29.41	0.00	29.41	46.00	-16.59	AVG	
11		4.3800	40.70	0.00	40.70	56.00	-15.30	QP	
12		4.3800	27.97	0.00	27.97	46.00	-18.03	AVG	

*:Maximum data x:Over limit l:over margin Comment: Factor build in receiver.

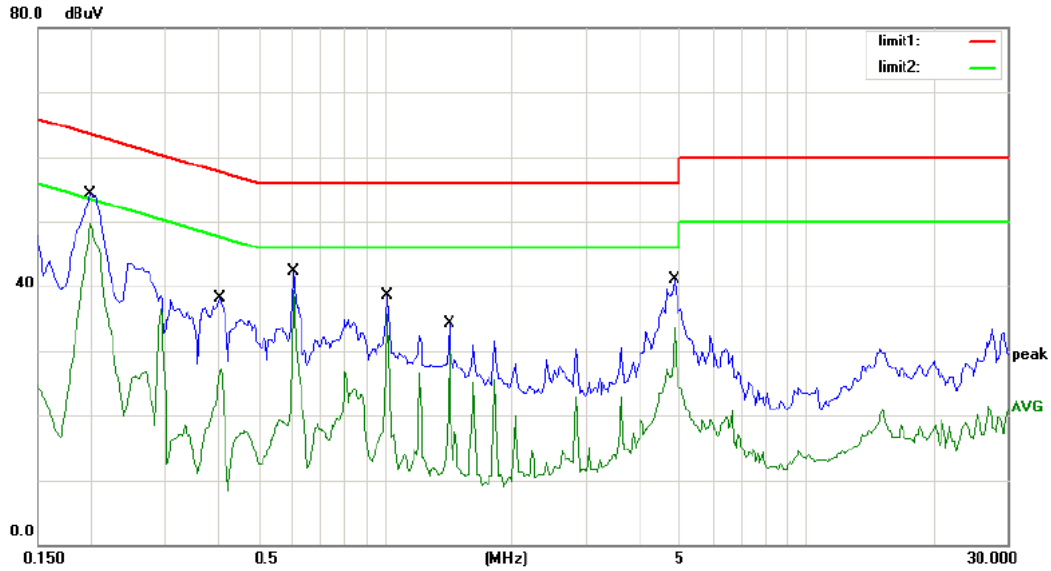

Site site #1 Phase: **N** Temperature: 24
 Limit: (CE)FCC PART 15 class B_QP Power: AC 120V/60Hz Humidity: 55 %
 Mode: WIFI Link
 Note:

No.	Mk.	Freq. MHz	Reading Level dBuV	Correct Factor dB	Measure- ment dBuV	Limit dBuV	Over dB	Detector	Comment
1		0.2000	52.40	0.00	52.40	63.61	-11.21	QP	
2	*	0.2000	49.77	0.00	49.77	53.61	-3.84	AVG	
3		0.4050	36.70	0.00	36.70	57.75	-21.05	QP	
4		0.4050	27.06	0.00	27.06	47.75	-20.69	AVG	
5		0.6050	41.30	0.00	41.30	56.00	-14.70	QP	
6		0.6050	39.40	0.00	39.40	46.00	-6.60	AVG	
7		1.0150	36.50	0.00	36.50	56.00	-19.50	QP	
8		1.0150	35.67	0.00	35.67	46.00	-10.33	AVG	
9		1.4200	33.20	0.00	33.20	56.00	-22.80	QP	
10		1.4200	30.14	0.00	30.14	46.00	-15.86	AVG	
11		4.8700	38.90	0.00	38.90	56.00	-17.10	QP	
12		4.8700	33.75	0.00	33.75	46.00	-12.25	AVG	

*:Maximum data x:Over limit !:over margin Comment: Factor build in receiver.

6. Radiated Emission Test

6.1 Measurement Procedure

1. The EUT was placed on a turn table which is 0.8m above ground plane.
2. Maximum procedure was performed on the six highest emissions to ensure EUT compliance.
3. And also, each emission was to be maximized by changing the polarization of receiving antenna both horizontal and vertical.
4. Repeat above procedures until all frequency measured was complete.

When spectrum scanned from 30MHz to 1GHz setting resolution bandwidth 120KHz and video bandwidth 300KHz:

EMI Test Receiver	Setting
Attenuation	Auto
RB	120KHz
VB	300KHz
Detector	QP
Trace	Max hold

When spectrum scanned above 1GHz setting resolution bandwidth 1MHz, video bandwidth 3MHz:

EMI Test Receiver	Setting
Attenuation	Auto
RB	1MHz
VB	3MHz
Detector	Peak
Trace	Max hold

When spectrum scanned above 1GHz setting resolution bandwidth 1MHz, video bandwidth 10Hz:

EMI Test Receiver	Setting
Attenuation	Auto
RB	1MHz
VB	10Hz
Detector	Peak
Trace	Max hold

6.2 Test SET-UP (Block Diagram of Configuration)

(A) Radiated Emission Test Set-Up, Frequency Below 30MHz

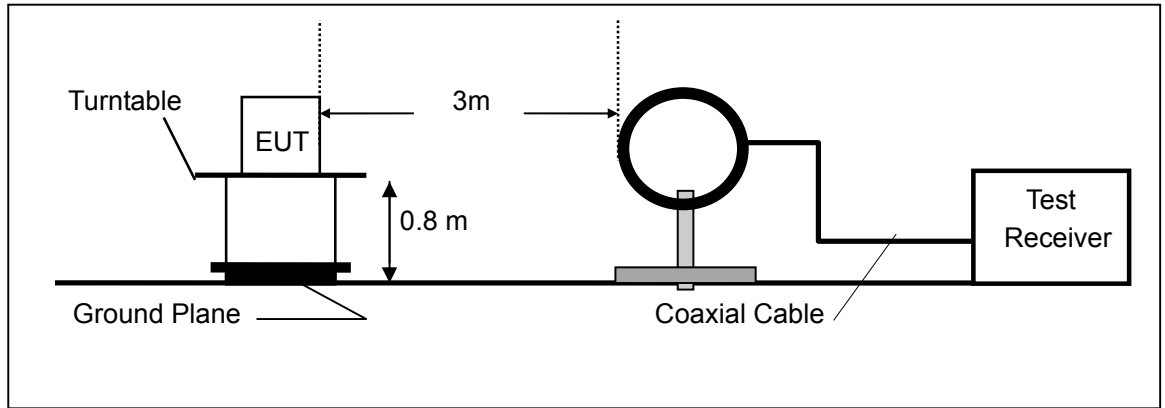

(B) Radiated Emission Test Set-Up, Frequency Below 1000MHz

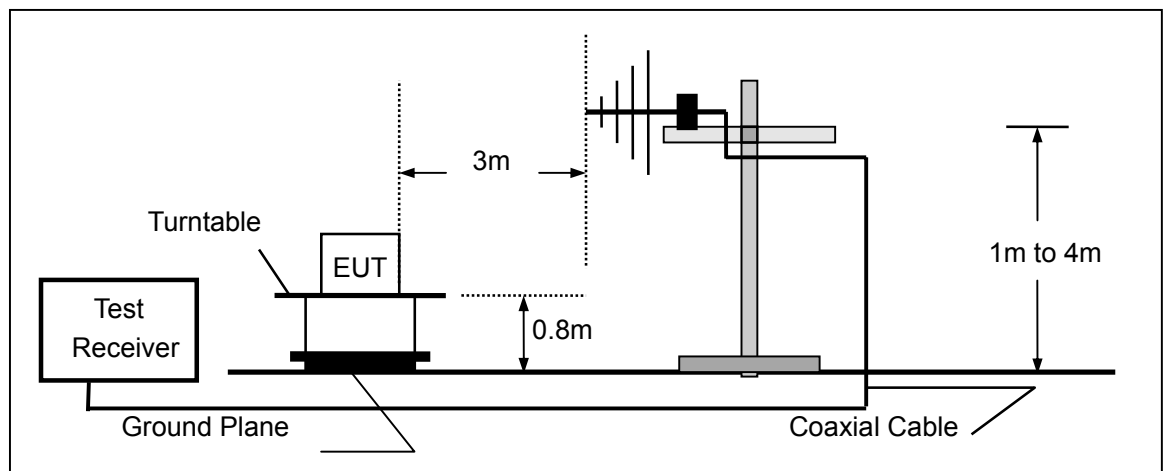

(C) Radiated Emission Test Set-Up, Frequency above 1000MHz

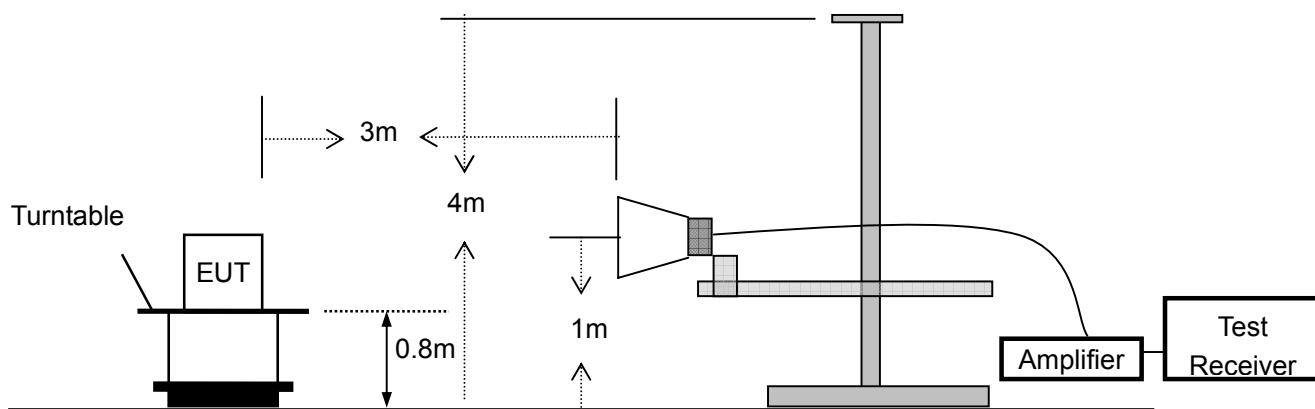

6.3 Measurement Equipment Used

EQUIPMENT TYPE	MFR	MODEL NUMBER	SERIAL NUMBER	LAST CAL.	CAL DUE.
Spectrum Analyzer	Rohde & Schwarz	FSV30	1321.3008K	05/16/2014	05/15/2015
Spectrum Analyzer	HP	E4407B	839840481	05/16/2014	05/15/2015
EMI Test Receiver	Rohde & Schwarz	ESU	1302.6005.26	05/16/2014	05/15/2015
Pre-Amplifier	HP	8447D	2944A07999	05/16/2014	05/15/2015
Bilog Antenna	Schwarzbeck	VULB9163	142	05/19/2014	05/18/2015
Loop Antenna	Schwarzbeck	FMZB 1519	012	05/19/2014	05/18/2015
Horn Antenna	Schwarzbeck	BBHA 9170	BBHA9170399	05/19/2014	05/18/2015
Horn Antenna	Schwarzbeck	BBHA 9120	D143	05/19/2014	05/18/2015
Spectrum Analyzer	Agilent	E4446A	US44300399	05/16/2014	05/15/2015

6.4 Radiated Emission Limit

The emissions from an intentional radiator shall not exceed the field strength levels specified in the following table 15.209(a):

Frequencies (MHz)	Field Strength (micorvolts/meter)	Measurement Distance (meters)
0.009~0.490	2400/F(KHz)	300
0.490~1.705	24000/F(KHz)	30
1.705~30.0	30	30
30~88	100	3
88~216	150	3
216~960	200	3
Above 960	500	3

Restricted bands of operation

MHz	MHz	MHz	GHz
0.090 - 0.110	16.42 - 16.423	399.9 - 410	4.5 - 5.15
¹ 0.495 - 0.505	16.69475 - 16.69525	608 - 614	5.35 - 5.46
2.1735 - 2.1905	16.80425 - 16.80475	960 - 1240	7.25 - 7.75
4.125 - 4.128	25.5 - 25.67	1300 - 1427	8.025 - 8.5
4.17725 - 4.17775	37.5 - 38.25	1435 - 1626.5	9.0 - 9.2
4.20725 - 4.20775	73 - 74.6	1645.5 - 1646.5	9.3 - 9.5
6.215 - 6.218	74.8 - 75.2	1660 - 1710	10.6 - 12.7
6.26775 - 6.26825	108 - 121.94	1718.8 - 1722.2	13.25 - 13.4
6.31175 - 6.31225	123 - 138	2200 - 2300	14.47 - 14.5
8.291 - 8.294	149.9 - 150.05	2310 - 2390	15.35 - 16.2
8.362 - 8.366	156.52475 - 156.52525	2483.5 - 2500	17.7 - 21.4
8.37625 - 8.38675	156.7 - 156.9	2690 - 2900	22.01 - 23.12
8.41425 - 8.41475	162.0125 - 167.17	3260 - 3267	23.6 - 24.0
12.29 - 12.293	167.72 - 173.2	3332 - 3339	31.2 - 31.8
12.51975 - 12.52025	240 - 285	3345.8 - 3358	36.43 - 36.5
12.57675 - 12.57725	322 - 335.4	3600 - 4400	(²)

- Remark 1. Emission level in dBuV/m=20 log (uV/m)
 : 2. Measurement was performed at an antenna to the closed point of EUT distance of meters.
 3. Only spurious frequency is permitted to locate within the Restricted Bands specified in provision of § 15.205, and the emissions located in restricted bands also comply with 15.209 limit.

6.5 Measurement Result

Below 30MHz:

All the modulation modes were tested the data of the test mode are recorded in the following pages.

Operation Mode: TX Mode Test Date : October 13, 2014
Frequency Range: 9KHz~30MHz Temperature : 28℃
Test Result: PASS Humidity : 60 %
Measured Distance: 3m Test By: WOLF

Freq. (MHz)	Ant.Pol. H/V	Emission Level (dBuV/m)	Limit 3m (dBuV/m)	Over (dB)
--	--	--	--	--

Note: the amplitude of spurious emission that is attenuated by more than 20dB below the permissible limit has no need to be reported.

Distance extrapolation factor = $40\log(\text{Specific distance/ test distance})$ (dB);

Limit line = Specific limits(dBuV) + distance extrapolation factor.

Below 1000MHz:

All the modulation modes were tested the data of the worst mode (TX 802.11b) are recorded in the following pages and the others modulation methods do not exceed the limits.

Please refer to the following test plots:

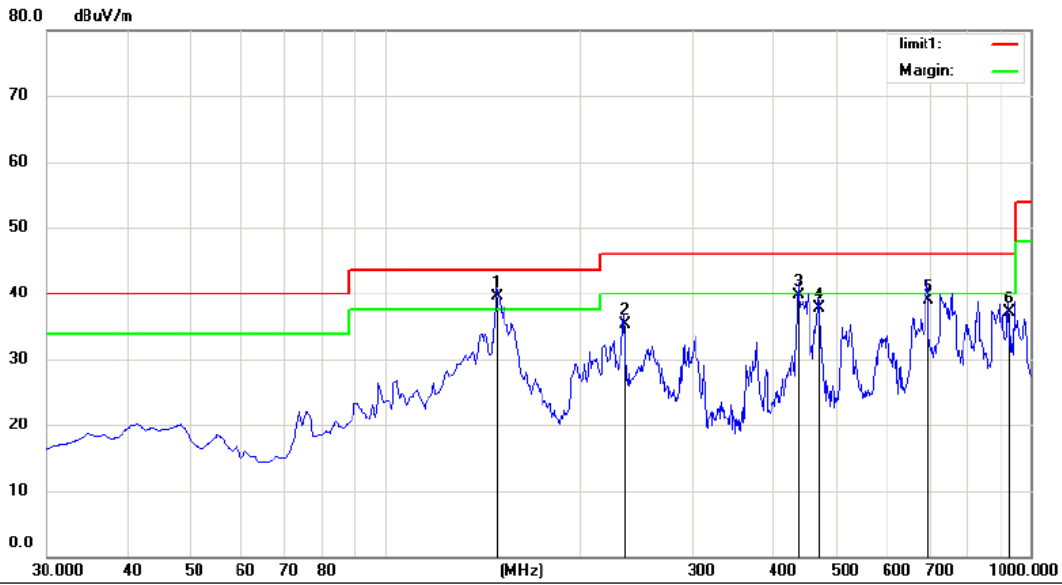

Site Chamber #1 Polarization: **Horizontal** Temperature: 26
 Limit: (RE)FCC PART 15 class B 3m Power: AC 120V/60Hz Humidity: 55 %
 Mode:TX2412
 Note:

No.	Mk.	Freq.	Reading Level	Correct Factor	Measurement	Limit	Over	Antenna Height	Table Degree	Comment
		MHz	dBuV	dB	dBuV/m	dBuV/m	dB	cm	degree	
1	*	149.3100	57.14	-17.68	39.46	43.50	-4.04	QP		
2		235.6400	51.25	-15.87	35.38	46.00	-10.62	QP		
3		438.3700	50.89	-11.28	39.61	46.00	-6.39	QP		
4		471.3500	48.44	-10.74	37.70	46.00	-8.30	QP		
5		693.4800	46.23	-7.36	38.87	46.00	-7.13	QP		
6		927.2500	39.74	-2.72	37.02	46.00	-8.98	QP		

*:Maximum data x:Over limit !:over margin

Operator: QIU

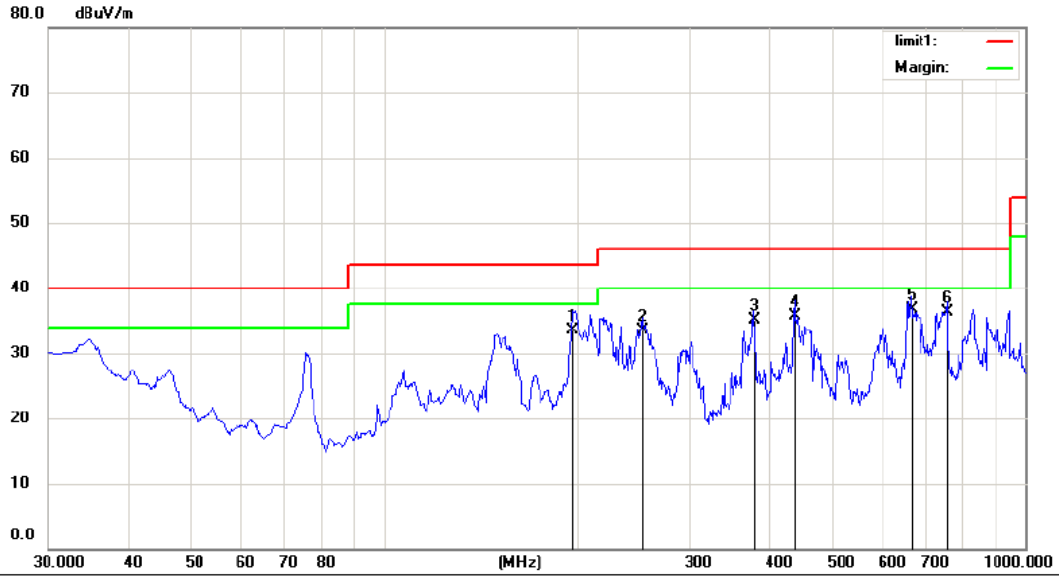

Site Chamber #1 Polarization: **Vertical** Temperature: 26
 Limit: (RE)FCC PART 15 class B 3m Power: AC 120V/60Hz Humidity: 55 %
 Mode: TX2412
 Note:

No.	Mk.	Freq.	Reading Level	Correct Factor	Measurement	Limit	Over	Antenna Height	Table Degree	
		MHz	dBuV	dB	dBuV/m	dBuV/m	dB	cm	degree	Comment
1		196.8400	51.28	-17.81	33.47	43.50	-10.03	QP		
2		253.1000	49.10	-15.56	33.54	46.00	-12.46	QP		
3		378.2300	47.26	-12.19	35.07	46.00	-10.93	QP		
4		437.4000	47.06	-11.41	35.65	46.00	-10.35	QP		
5	*	664.3800	44.53	-7.81	36.72	46.00	-9.28	QP		
6		757.5000	42.32	-6.00	36.32	46.00	-9.68	QP		

*:Maximum data x:Over limit !:over margin

Operator: QIU

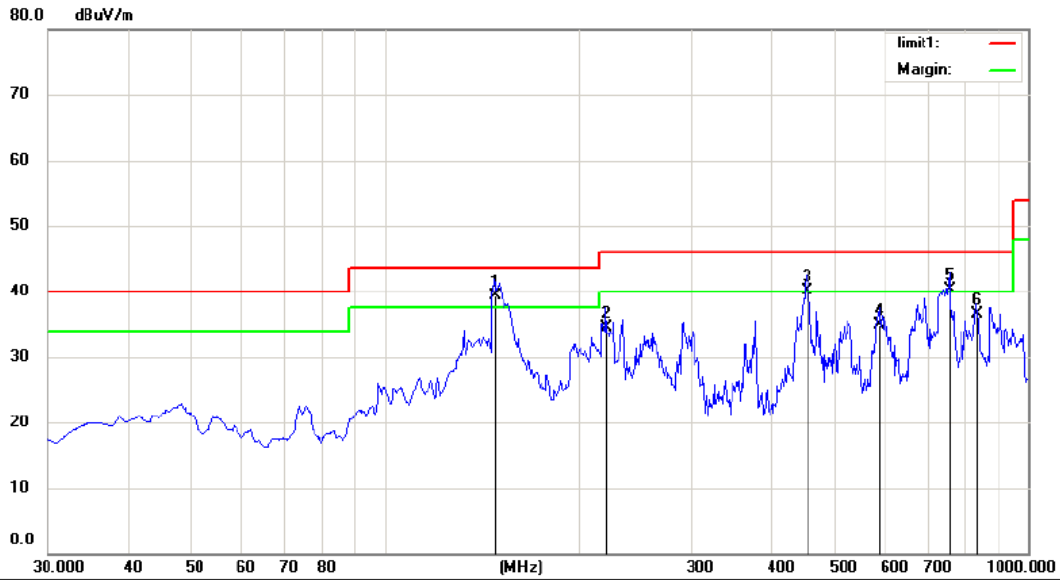

Site: Chamber #1 Polarization: **Horizontal** Temperature: 26
 Limit: (RE)FCC PART 15 class B 3m Power: AC 120V/60Hz Humidity: 55 %
 Mode: TX2437
 Note:

No.	Mk.	Freq.	Reading Level	Correct Factor	Measurement	Limit	Over	Antenna Height	Table Degree	Comment
		MHz	dBuV	dB	dBuV/m	dBuV/m	dB	cm	degree	
1	*	148.3400	56.93	-17.63	39.30	43.50	-4.20	QP		
2		221.0900	50.67	-16.15	34.52	46.00	-11.48	QP		
3	!	453.8900	51.15	-11.13	40.02	46.00	-5.98	QP		
4		588.7200	43.50	-8.55	34.95	46.00	-11.05	QP		
5	!	757.5000	46.04	-5.73	40.31	46.00	-5.69	QP		
6		832.1900	41.10	-4.50	36.60	46.00	-9.40	QP		

*:Maximum data x:Over limit !:over margin

Operator: QIU

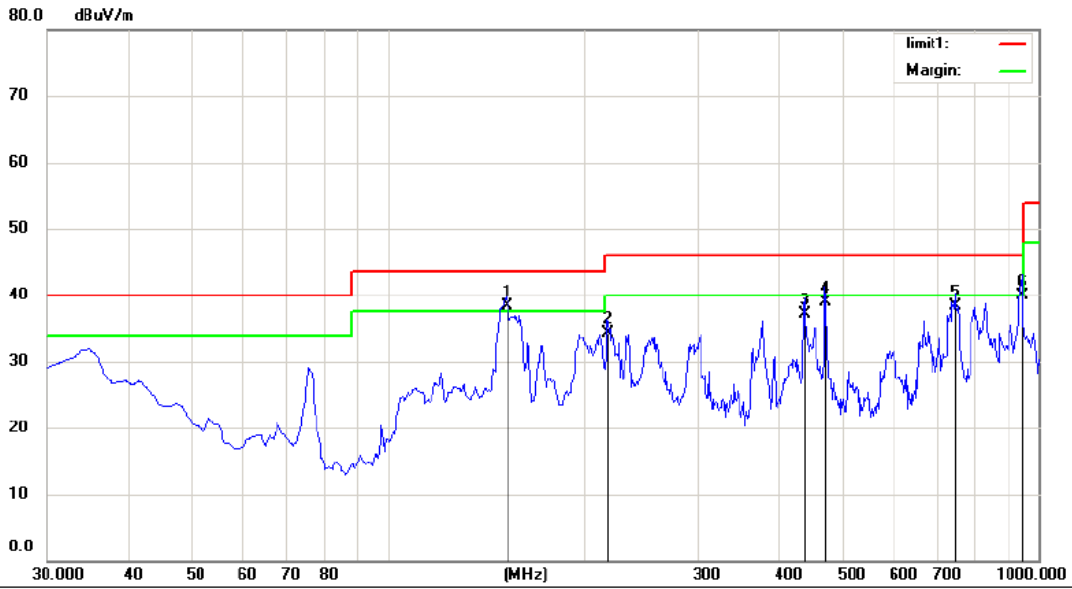

Site Chamber #1 Polarization: **Vertical** Temperature: 26
 Limit: (RE)FCC PART 15 class B 3m Power: AC 120V/60Hz Humidity: 55 %
 Mode:TX2437
 Note:

No.	Mk.	Freq.	Reading Level	Correct Factor	Measurement	Limit	Over	Antenna Height	Table Degree	
		MHz	dBuV	dB	dBuV/m	dBuV/m	dB	cm	degree	Comment
1	*	152.2200	56.16	-17.94	38.22	43.50	-5.28	QP		
2		218.1800	50.55	-16.27	34.28	46.00	-11.72	QP		
3		437.4000	48.50	-11.41	37.09	46.00	-8.91	QP		
4		471.3500	49.66	-10.76	38.90	46.00	-7.10	QP		
5		745.8600	44.34	-6.00	38.34	46.00	-7.66	QP		
6		945.6800	42.52	-2.52	40.00	46.00	-6.00	QP		

*:Maximum data x:Over limit !:over margin

Operator: QIU

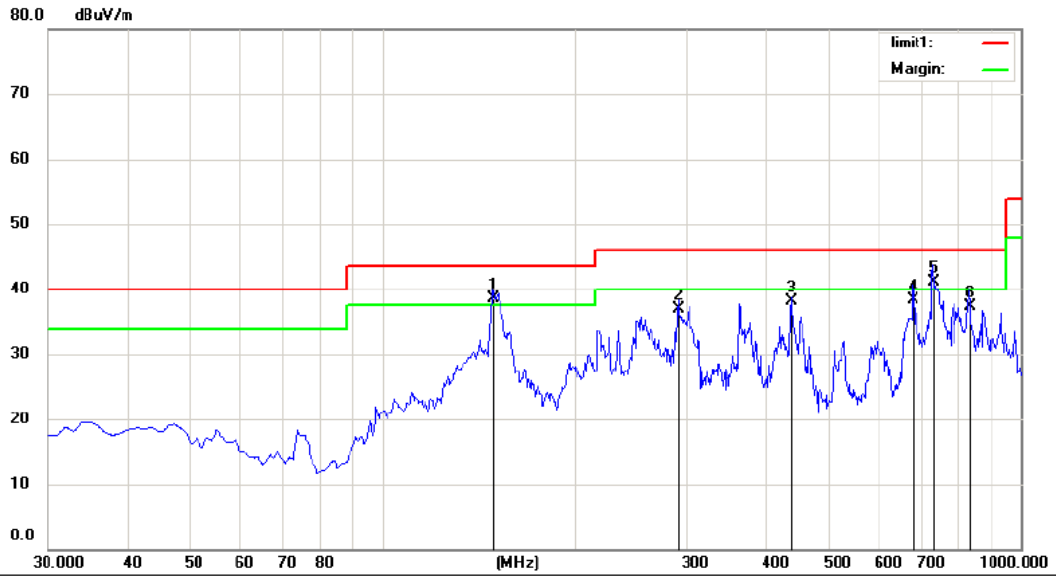

Site Chamber #1 Polarization: **Horizontal** Temperature: 26
 Limit: (RE)FCC PART 15 class B 3m Power: AC 120V/60Hz Humidity: 55 %
 Mode: TX2462
 Note:

No.	Mk.	Freq.	Reading Level	Correct Factor	Measurement	Limit	Over	Antenna Height	Table Degree	
		MHz	dBuV	dB	dBuV/m	dBuV/m	dB	cm	degree	Comment
1	!	149.3100	56.12	-17.68	38.44	43.50	-5.06	QP		
2		291.9000	51.53	-14.69	36.84	46.00	-9.16	QP		
3		438.3700	49.42	-11.28	38.14	46.00	-7.86	QP		
4		679.9000	45.81	-7.57	38.24	46.00	-7.76	QP		
5	*	730.3400	47.47	-6.33	41.14	46.00	-4.86	QP		
6		832.1900	41.83	-4.50	37.33	46.00	-8.67	QP		

*:Maximum data x:Over limit !:over margin

Operator: QIU

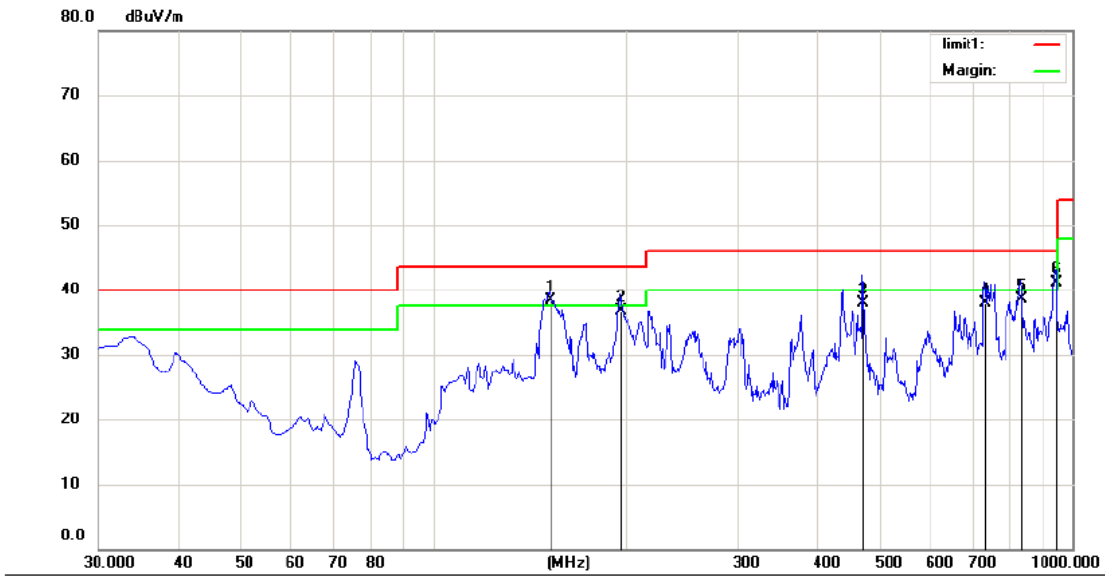

Site Chamber #1 Polarization: **Vertical** Temperature: 26
 Limit: (RE)FCC PART 15 class B 3m Power: AC 120V/60Hz Humidity: 55 %
 Mode: TX2462
 Note:

No.	Mk.	Freq.	Reading Level	Correct Factor	Measurement	Limit	Over	Antenna Height	Table Degree	
		MHz	dBuV	dB	dBuV/m	dBuV/m	dB	cm	degree	Comment
1	!	152.2200	56.16	-17.94	38.22	43.50	-5.28	QP		
2		195.8700	54.56	-17.85	36.71	43.50	-6.79	QP		
3		471.3500	48.66	-10.76	37.90	46.00	-8.10	QP		
4		731.3100	44.16	-6.29	37.87	46.00	-8.13	QP		
5		832.1900	43.07	-4.58	38.49	46.00	-7.51	QP		
6	*	942.7700	43.65	-2.50	41.15	46.00	-4.85	QP		

*:Maximum data x:Over limit !:over margin

Operator: QIU

Above 1000MHz:

Operation Mode: 802.11b Lowest Test Date : October 13, 2014

Freq. (MHz)	Ant.Pol H/V	Emission Level(dBuV/m)		Limit 3m(dBuV/m)		Over(dB)	
		PK	AV	PK	AV	PK	AV
4824	V	66.55	45.55	74	54	-7.45	-8.45
7236	V	63.59	44.13	74	54	-10.41	-9.87
9648	V	62.19	43.28	74	54	-11.81	-10.72
12060	V	61.85	42.65	74	54	-12.15	-11.35
14472	V	60.29	41.22	74	54	-13.71	-12.78
16884	V	59.48	40.28	74	54	-14.52	-13.72
4824	H	67.25	44.95	74	54	-6.75	-9.05
7236	H	66.95	43.56	74	54	-7.05	-10.44
9648	H	65.72	42.19	74	54	-8.28	-11.81
12060	H	64.95	41.28	74	54	-9.05	-12.72
14472	H	63.27	40.25	74	54	-10.73	-13.75
16884	H	62.72	39.56	74	54	-11.28	-14.44

Operation Mode: 802.11b Middle Test Date : October 13, 2014

Freq. (MHz)	Ant.Pol H/V	Emission Level(dBuV/m)		Limit 3m(dBuV/m)		Over(dB)	
		PK	AV	PK	AV	PK	AV
4874	V	67.86	45.85	74	54	-6.14	-8.15
7311	V	66.25	44.22	74	54	-7.75	-9.78
9688	V	65.13	43.18	74	54	-8.87	-10.82
12185	V	64.85	42.13	74	54	-9.15	-11.87
14622	V	63.72	41.85	74	54	-10.28	-12.15
17059	V	62.13	40.29	74	54	-11.87	-13.71
4874	H	66.55	44.23	74	54	-7.45	-9.77
7311	H	65.13	43.85	74	54	-8.87	-10.15
9688	H	64.85	42.18	74	54	-9.15	-11.82
12185	H	63.72	41.04	74	54	-10.28	-12.96
14622	H	62.85	40.87	74	54	-11.15	-13.13
17059	H	61.08	38.49	74	54	-12.92	-15.51

Operation Mode: 802.11b Highest

Test Date : October 13, 2014

Freq. (MHz)	Ant.Pol H/V	Emission Level(dBuV/m)		Limit 3m(dBuV/m)		Over(dB)	
		PK	AV	PK	AV	PK	AV
4924	V	68.11	46.23	74	54	-5.89	-7.77
7386	V	67.02	45.28	74	54	-6.98	-8.72
9848	V	66.33	44.11	74	54	-7.67	-9.89
12310	V	65.72	43.28	74	54	-8.28	-10.72
14772	V	64.85	42.95	74	54	-9.15	-11.05
17234	V	63.95	41.33	74	54	-10.05	-12.67
4924	H	67.69	45.95	74	54	-6.31	-8.05
7386	H	66.23	44.13	74	54	-7.77	-9.87
9848	H	65.85	42.85	74	54	-8.15	-11.15
12310	H	64.23	41.07	74	54	-9.77	-12.93
14772	H	63.85	40.28	74	54	-10.15	-13.72
17234	H	62.13	39.47	74	54	-11.87	-14.53

All emissions not reported were more than 20dB below the specified limit or in the noise floor.

- Note:**
- (1) All Readings are Peak Value and AV.
 - (2) Emission Level= Reading Level+Probe Factor +Cable Loss.
 - (3) Data of measurement within this frequency range shown " – " in the table above means the reading of emissions are attenuated more than 20Db below the permissible limits or the field strength is too small to be measured.

7. 6dB Bandwidth Test

7.1 Measurement Procedure

The EUT was operating in IEEE 802.11b, 802.11g, 802.11n(H20), 802.11n(H40) mode or could be controlled its channel. Printed out the test result from the spectrum by hard copy function.

1. Set resolution bandwidth (RBW) = 100 kHz.
2. Set the video bandwidth (VBW) $\geq 3 \times$ RBW.
3. Detector = Peak.
4. Trace mode = max hold.
5. Sweep = auto couple.
6. Allow the trace to stabilize.
7. Measure the maximum width of the emission that is constrained by the frequencies associated with the two outermost amplitude points (upper and lower frequency) that are attenuated by 6 dB relative to the maximum level measured in the fundamental emission.

7.2 Test SET-UP (Block Diagram of Configuration)

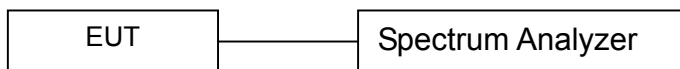

7.3 Measurement Equipment Used

EQUIPMENT TYPE	MFR	MODEL NUMBER	SERIAL NUMBER	LAST CAL.	CAL DUE.
Spectrum Analyzer	Agilent	FSV30	1321.3008K	05/16/2014	05/15/2015

7.4 Measurement Results

6 Bandwidth Test Data Chart:

Refer to attached data chart.

Spectrum Detector: PK Test Date : October 13, 2014
 Test By: Andy Temperature : 28°C
 Test Mode: 802.11b Humidity : 60%

Channel frequency (MHz)	Measurement level (KHz)	Required Limit (KHz)	Result
2412	9530	>500	Pass
2437	9271	>500	
2462	10150	>500	

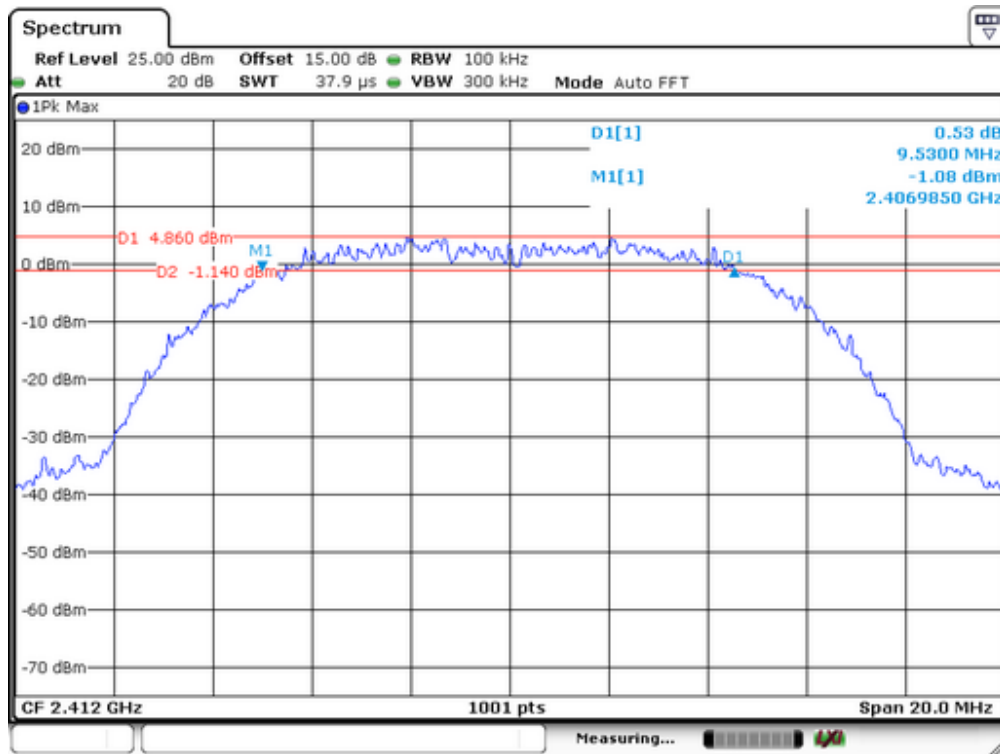

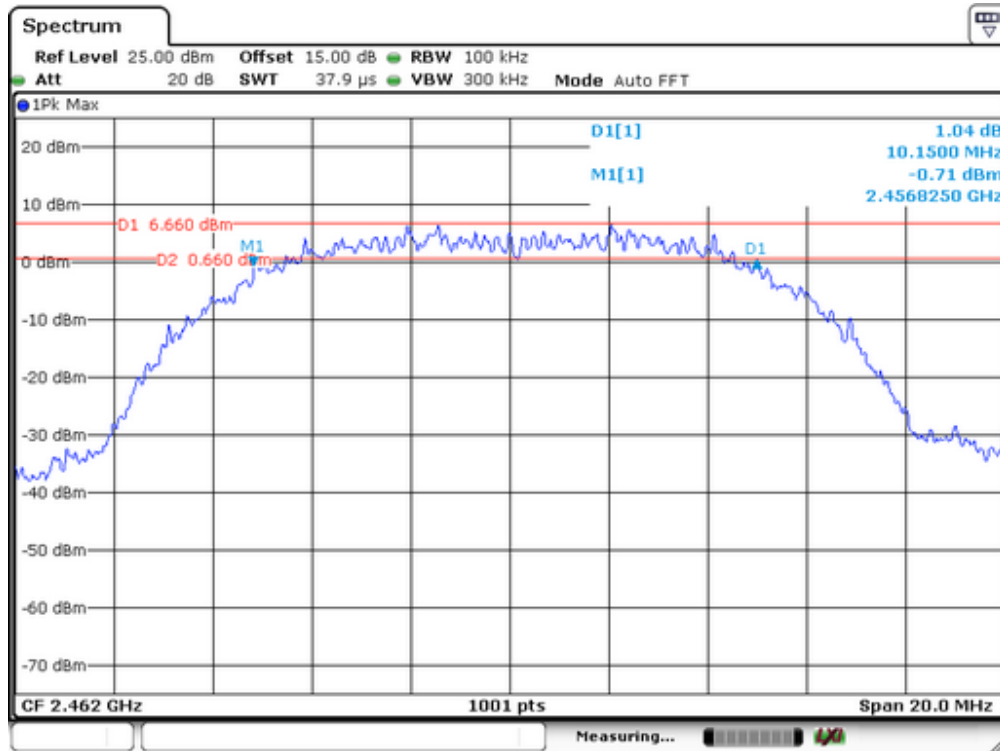
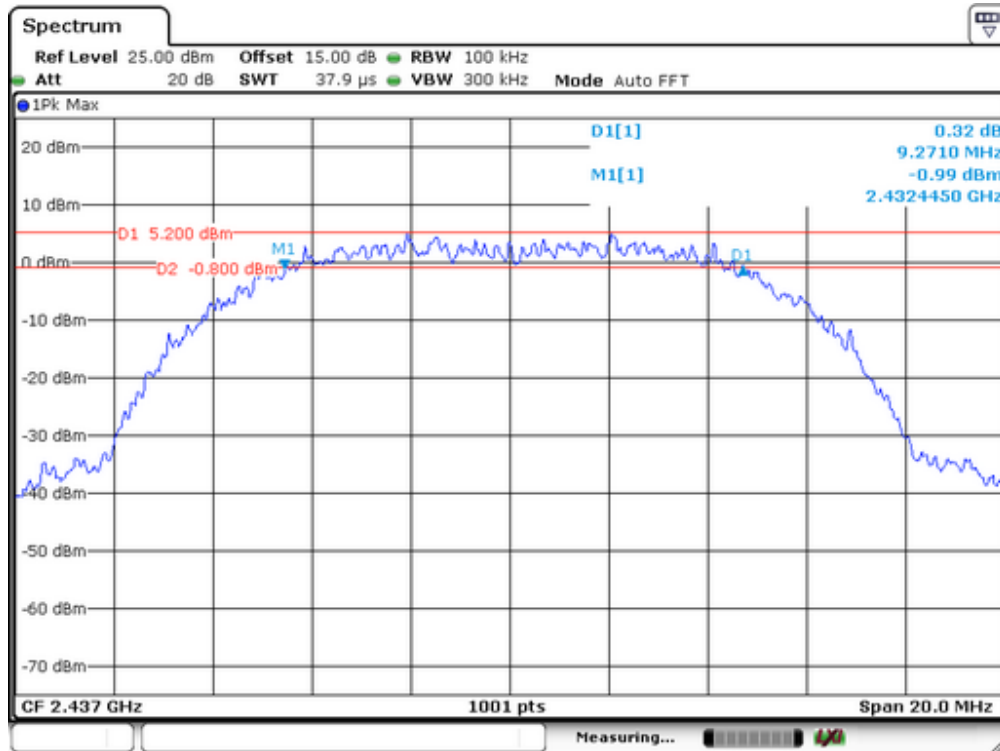

Spectrum Detector: PK Test Date : October 13, 2014
 Test By: Andy Temperature : 28°C
 Test Mode: 802.11g Humidity : 60%

Channel frequency (MHz)	Measurement level (KHz)	Required Limit (KHz)	Result
2412	16503	>500	Pass
2437	16503	>500	
2462	16484	>500	

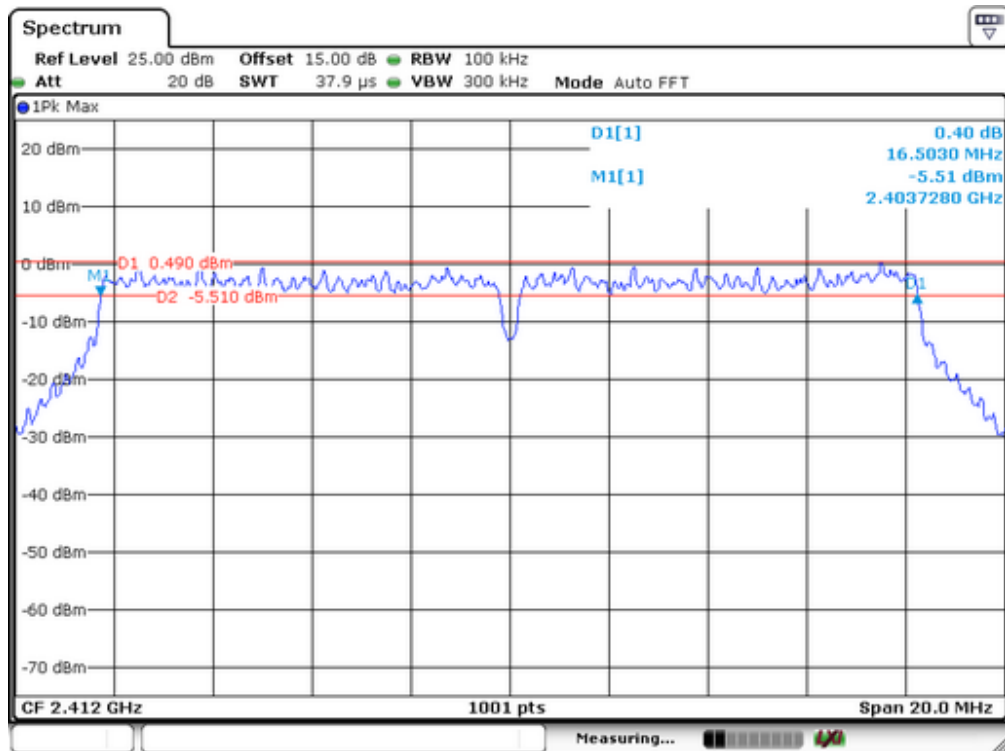

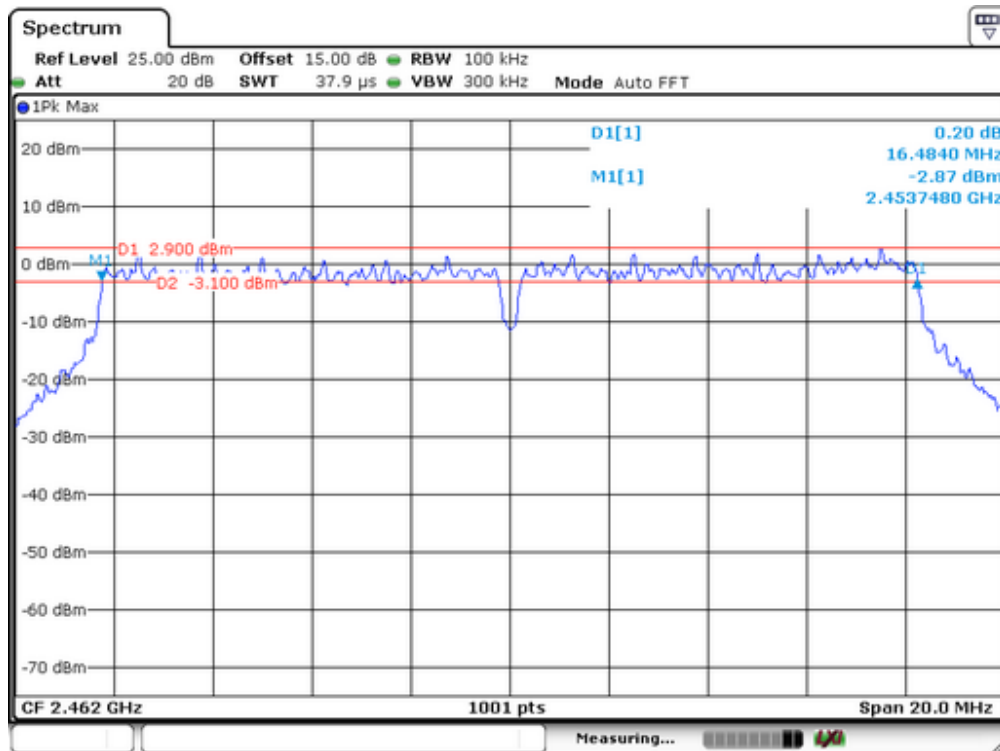
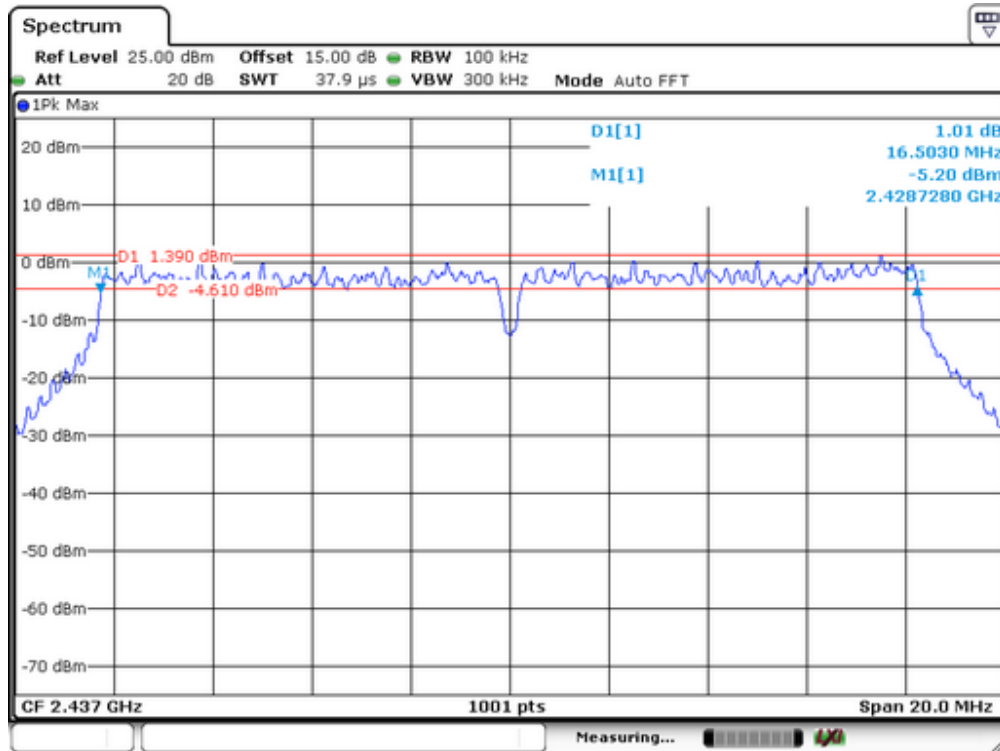

Spectrum Detector: PK Test Date : October 13, 2014
 Test By: Andy Temperature : 28°C
 Test Mode: 802.11n(H20) Humidity : 60%

Channel frequency (MHz)	Measurement level (KHz)	Required Limit (KHz)	Result
2412	17642	>500	Pass
2437	17622	>500	
2462	17622	>500	

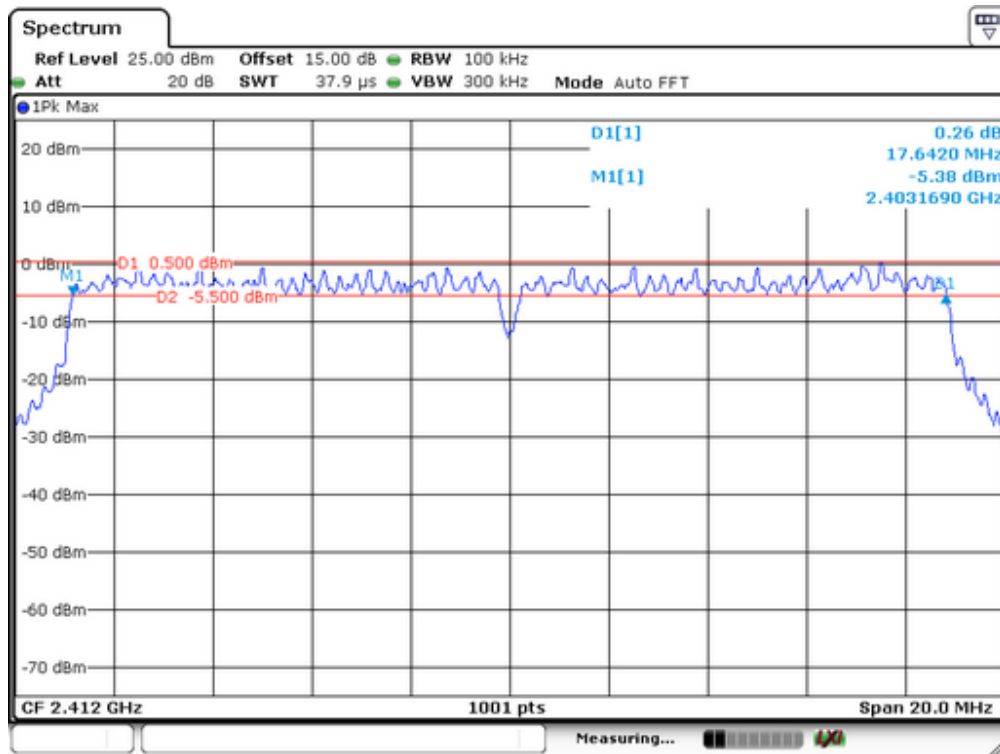

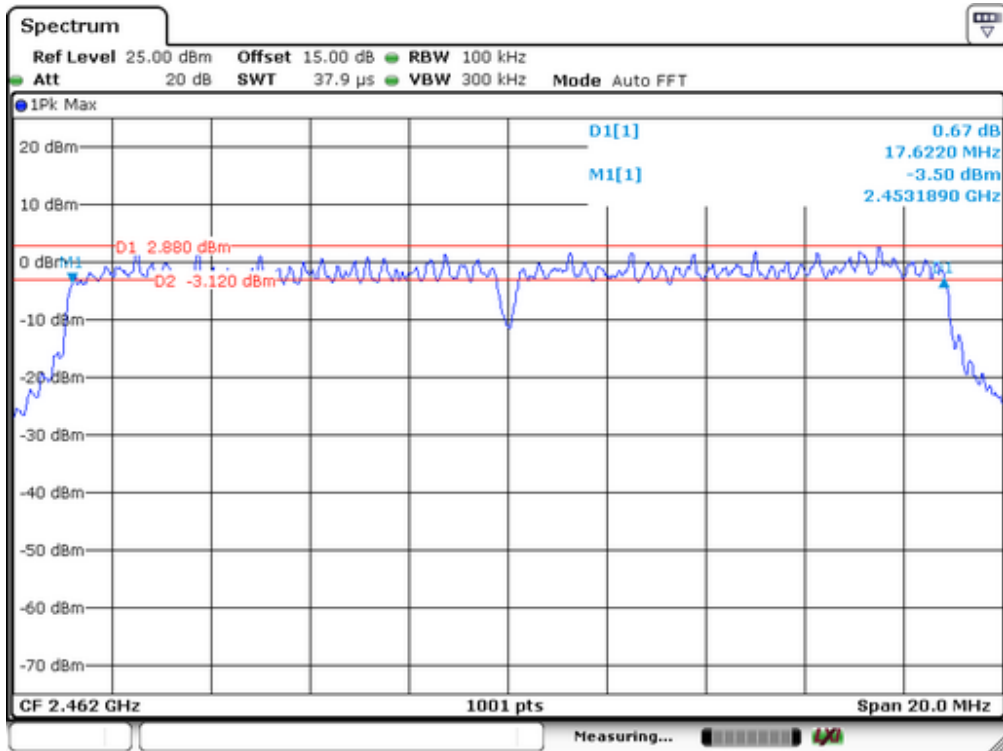
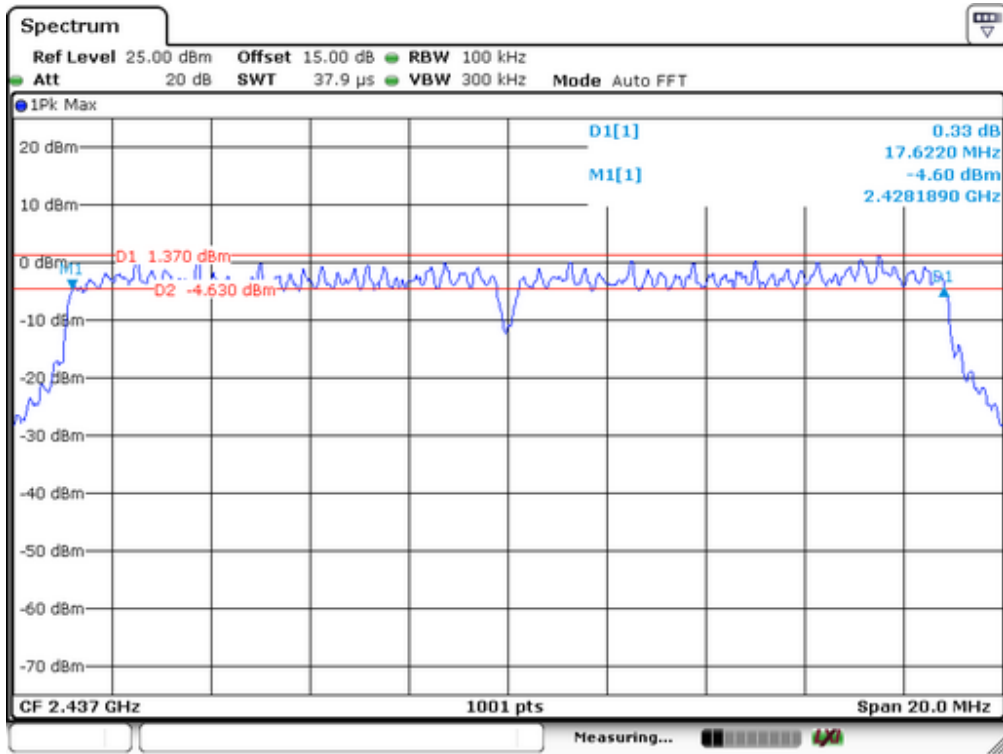

Spectrum Detector: PK Test Date : October 13, 2014
 Test By: Andy Temperature : 28°C
 Test Mode: 802.11n(H40) Humidity : 60%

Channel frequency (MHz)	Measurement level (KHz)	Required Limit (KHz)	Result
2422	36404	>500	Pass
2437	36404	>500	
2452	36404	>500	

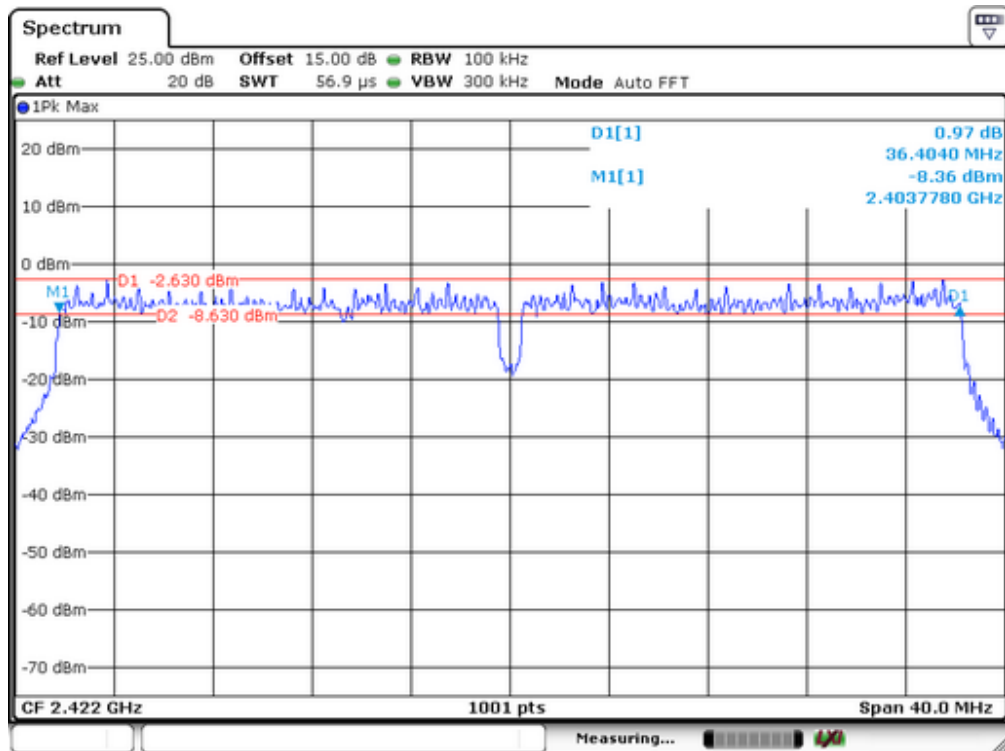

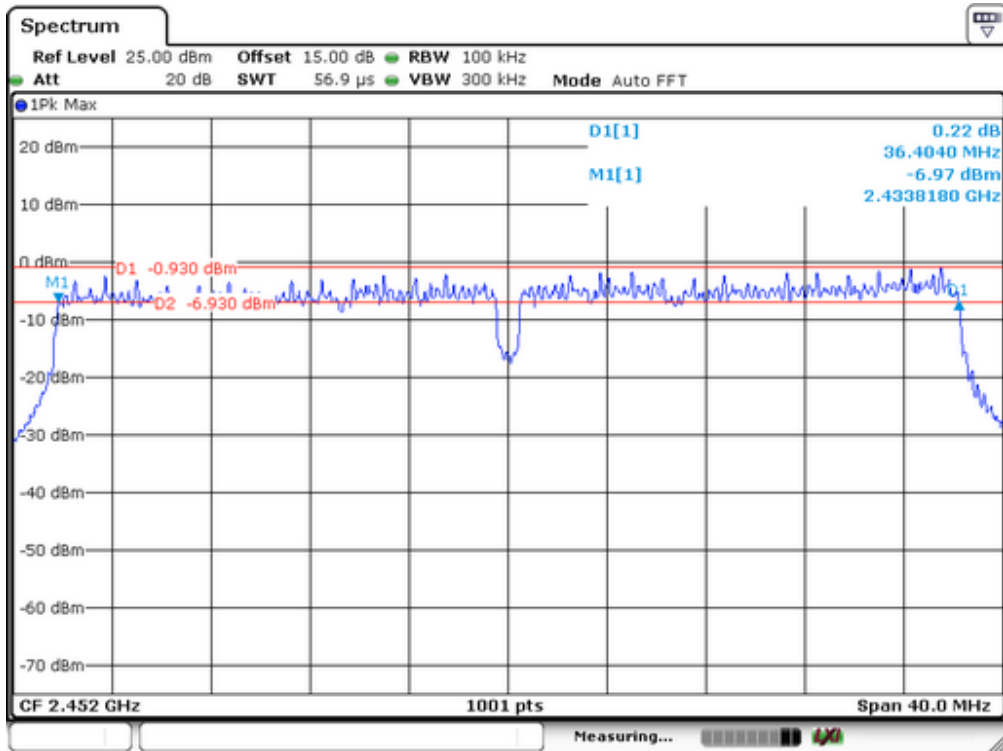
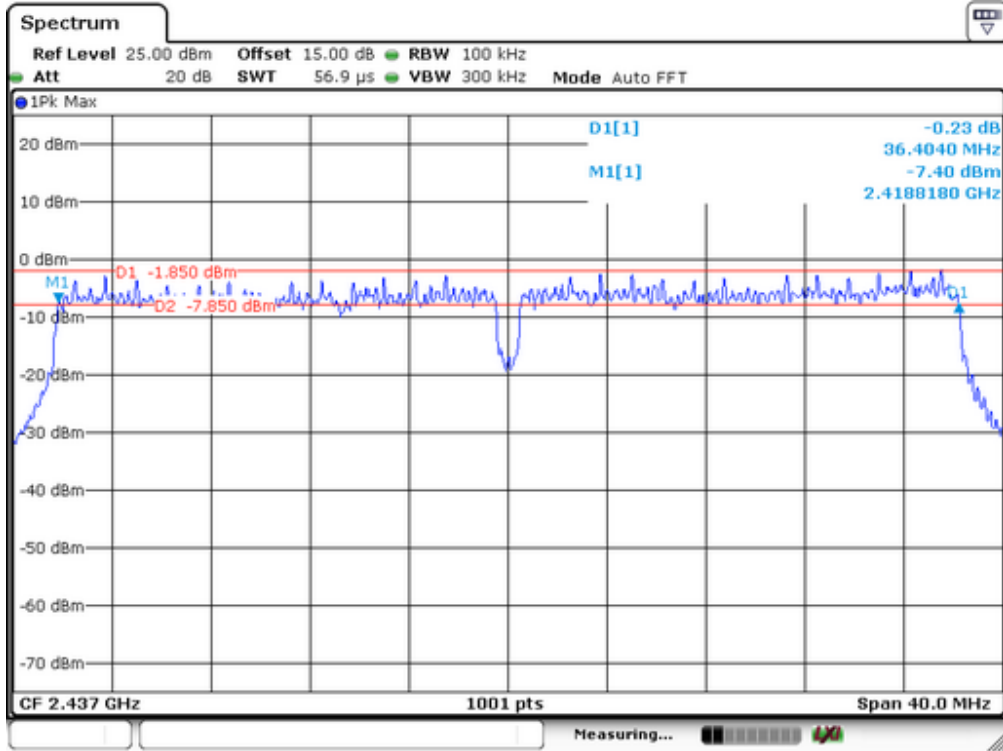

8. Maximum Peak Output Power Test

8.1 Measurement Procedure

The maximum peak conducted output power can be measured using a broadband peak RF power meter. The power meter must have a video bandwidth that is greater than or equal to the DTS bandwidth and shall utilize a fast, average-responding diode type sensor.

- a. The Transmitter output (antenna port) was connected to the power meter.
- b. Turn on the EUT and power meter and then record the peak power value.
- c. Repeat above procedures on all channels needed to be tested.

8.2 Test SET-UP (Block Diagram of Configuration)



8.3 Measurement Equipment Used

EQUIPMENT TYPE	MODEL NUMBER	SERIAL NUMBER	LAST CAL.	CAL DUE.
Power meter	ML2495A	0824006	05/16/2014	05/15/2015
Power sensor	MA2411B	0738172	05/16/2014	05/15/2015

8.4 Peak Power output limit

The maximum peak power shall be less 1Watt.

8.5 Measurement Results

Spectrum Detector:	PK	Test Date :	October 13, 2014
Test By:	Jack	Temperature :	28°C
Test Result:	PASS	Humidity :	60%

Test Channel	Average Output Power (dBm)				Limit(dBm)	Result
	802.11b	802.11g	802.11n(H20)	802.11n(H40)		
Lowest	19.64	20.44	20.16	19.86	30	Pass
Middle	20.30	20.97	20.79	20.26		
Highest	21.72	22.19	22.14	21.07		

9. Band Edge Test

9.1 Measurement Procedure

For Conducted Test

1. The testing follows FCC KDB Publication No. 558074 D01 DTS Meas. Guidance v03r02.
2. The RF output of EUT was connected to the spectrum analyzer by RF cable and attenuator. The path loss was compensated to the results for each measurement.
3. Set to the maximum power setting and enable the EUT transmit continuously.
4. Set RBW = 100 kHz, VBW=300 kHz, Peak Detector. Unwanted Emissions measured in any 100 kHz bandwidth outside of the authorized frequency band shall be attenuated by at least 20 dB relative to the maximum in-band peak PSD level in 100 kHz when maximum peak conducted output power procedure is used. Measure and record the results in the test report.
5. The RF fundamental frequency should be excluded against the limit line in the operating frequency band.

For Radiated emission Test

1. The testing follows FCC KDB Publication No. 558074 D01 DTS Meas. Guidance v03r02.
2. The EUT was arranged to its worst case and then tune the antenna tower (from 1 m to 4 m) and turntable (from 0 degree to 360 degrees) to find the maximum reading. A pre-amp and a high pass filter are used for the test in order to get better signal level.
3. The EUT was placed on a turntable with 0.8 meter above ground.
4. The EUT was set 3 meters from the interference receiving antenna, which was mounted on the top of a variable height antenna tower.
5. Corrected Reading: Antenna Factor + Cable Loss + Read Level - Preamp Factor = Level.
6. For measurement below 1GHz, If the emission level of the EUT measured by the peak detector is 3 dB lower than the applicable limit, the peak emission level will be reported. Otherwise, the emission measurement will be repeated using the quasi-peak detector and reported.
7. Repeat above procedures until all frequency measured were complete.

When spectrum scanned above 1GHz setting resolution bandwidth 1MHz, video bandwidth 3MHz.

EMI Test Receiver	Setting
Attenuation	Auto
RB	1MHz
VB	3MHz
Detector	Peak
Trace	Max hold

When spectrum scanned above 1GHz setting resolution bandwidth 1MHz, video bandwidth 10Hz.

EMI Test Receiver	Setting
Attenuation	Auto
RB	1MHz
VB	10Hz
Detector	Peak
Trace	Max hold

9.2 Test SET-UP (Block Diagram of Configuration)

As 6.2 Test set up (B) and (C)

9.3 Measurement Equipment Used

Same as 6.3 Radiated Emission Measurement.

9.4 Measurement Results

1. Conducted Test

Test Mode: 802.11b

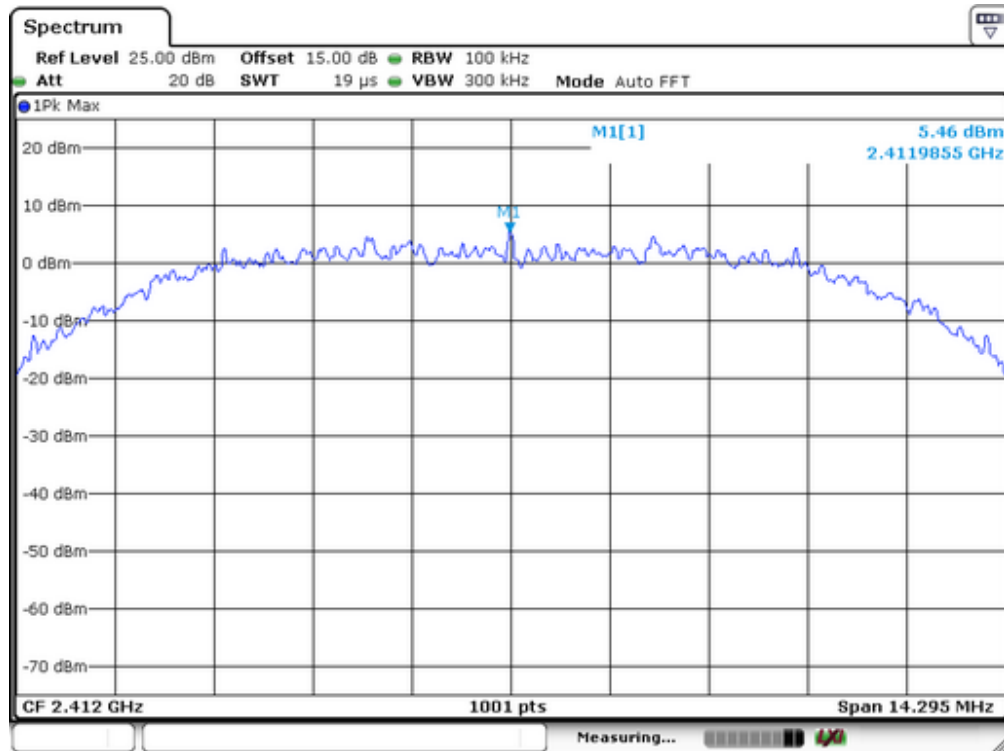

Lowest Channel

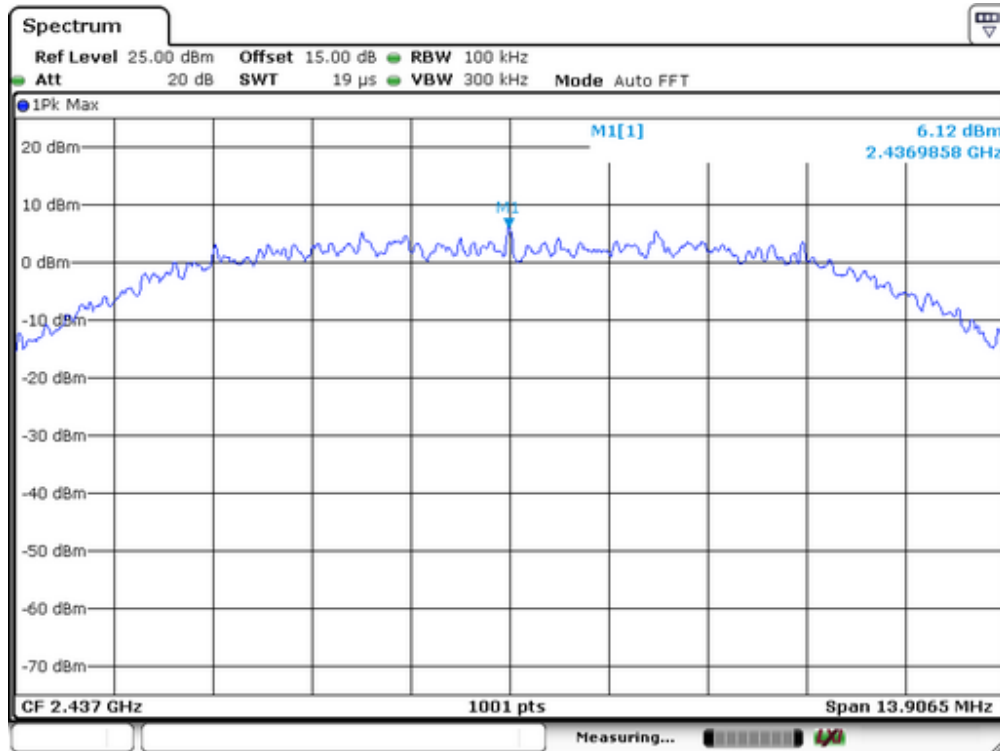

Middle Channel

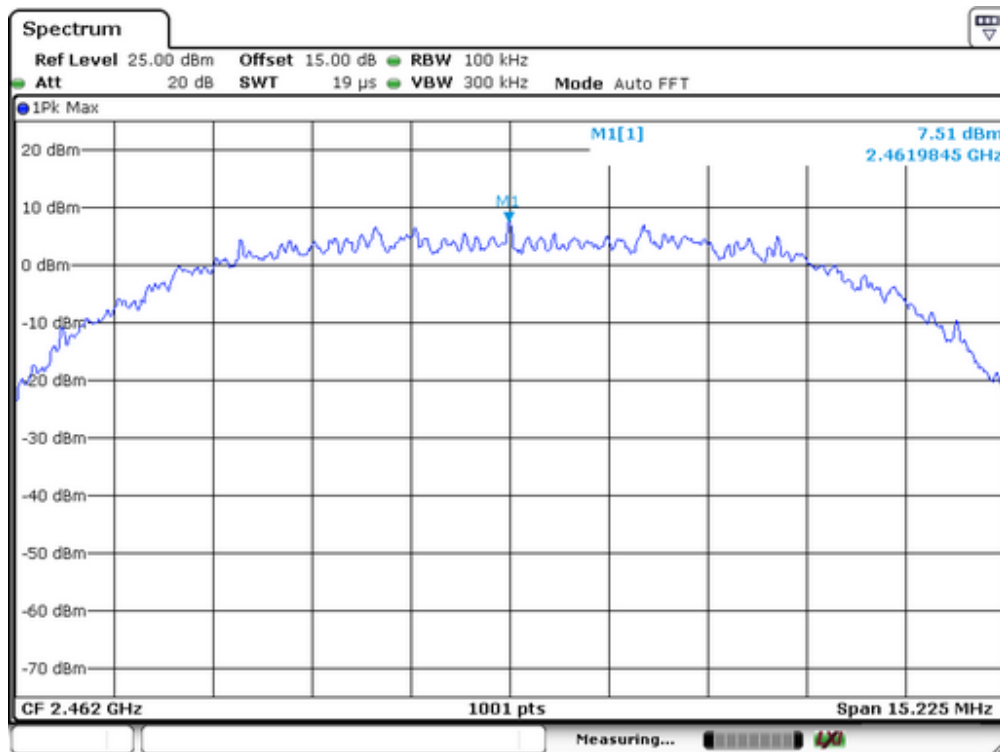

Highest Channel

Test Mode: 802.11g

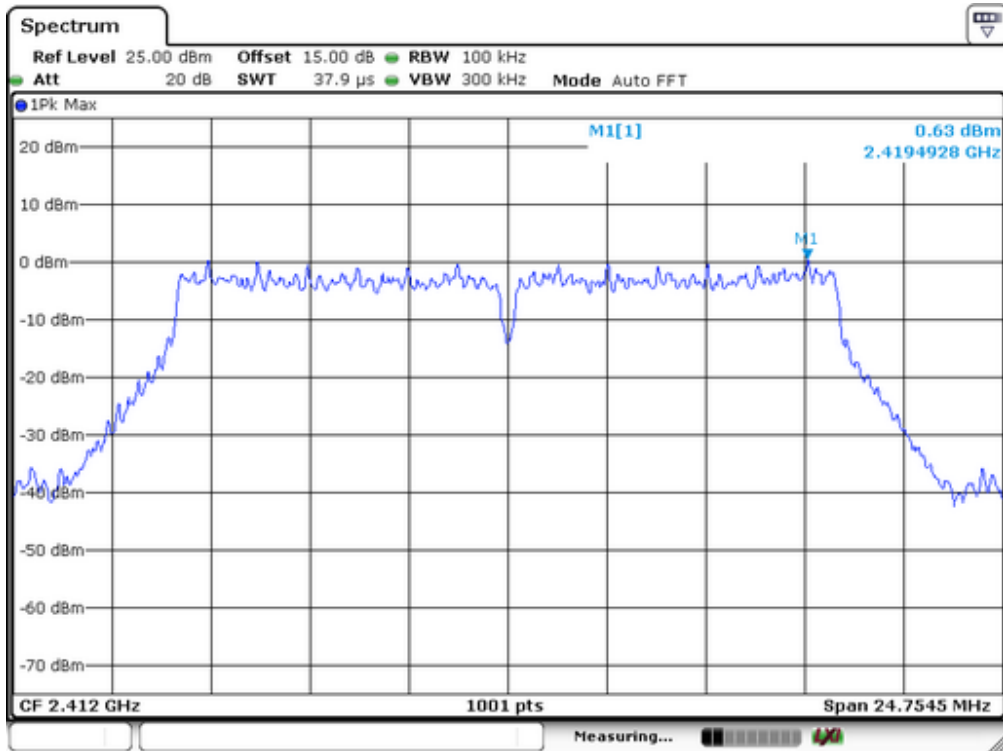

Lowest Channel

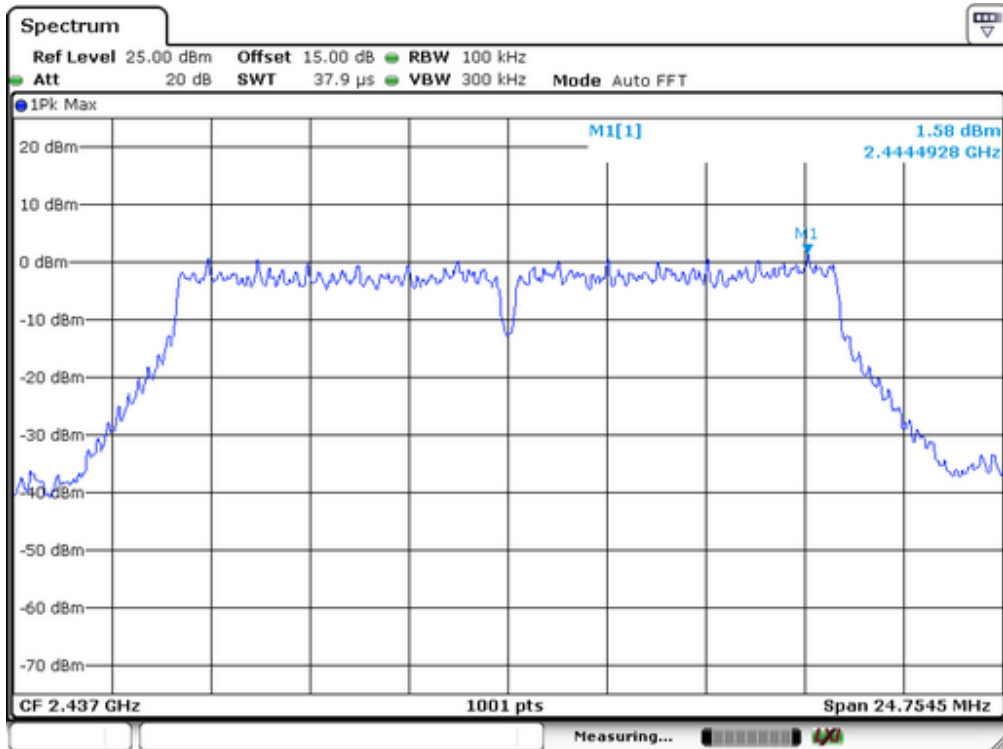

Middle Channel

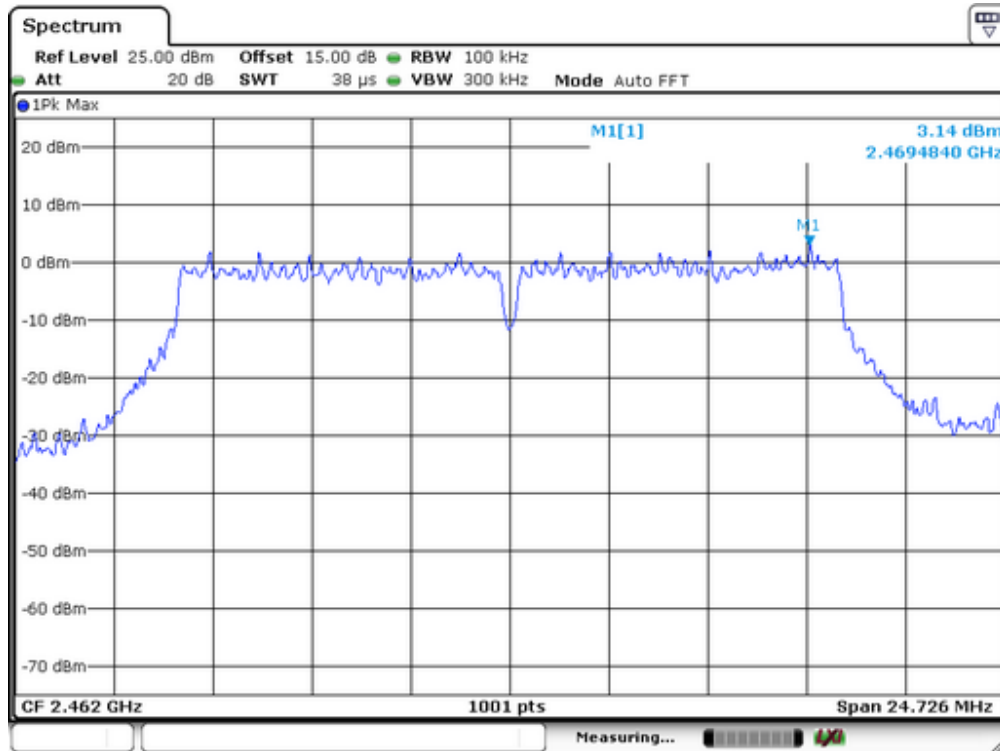

Highest Channel

Test Mode: 802.11n(H20)

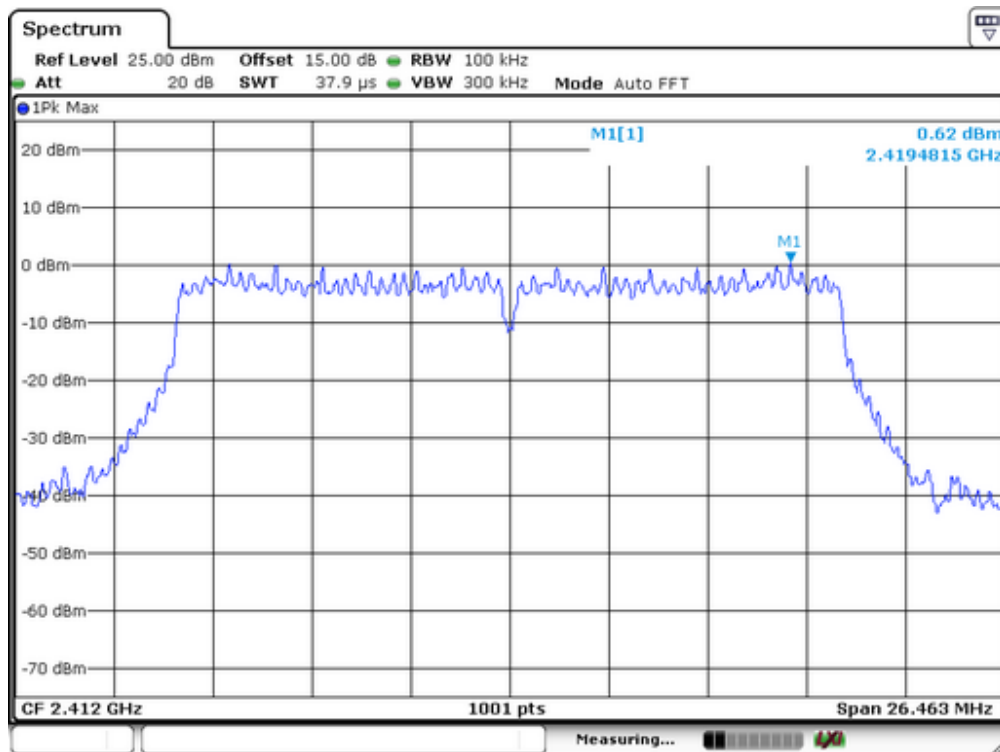

Lowest Channel

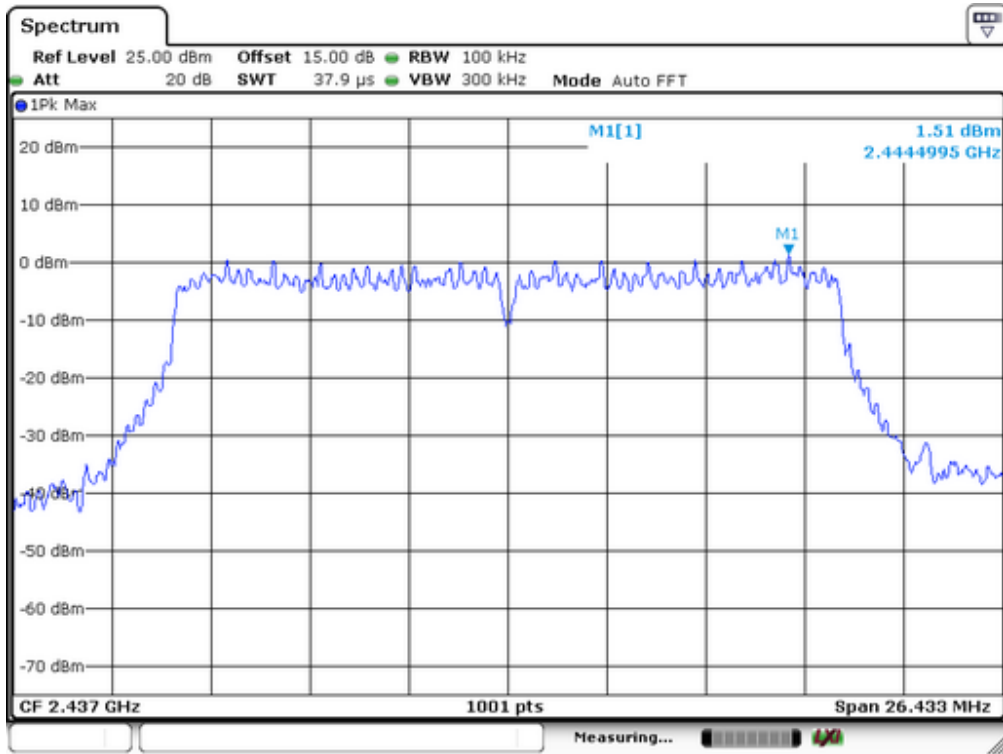

Middle Channel

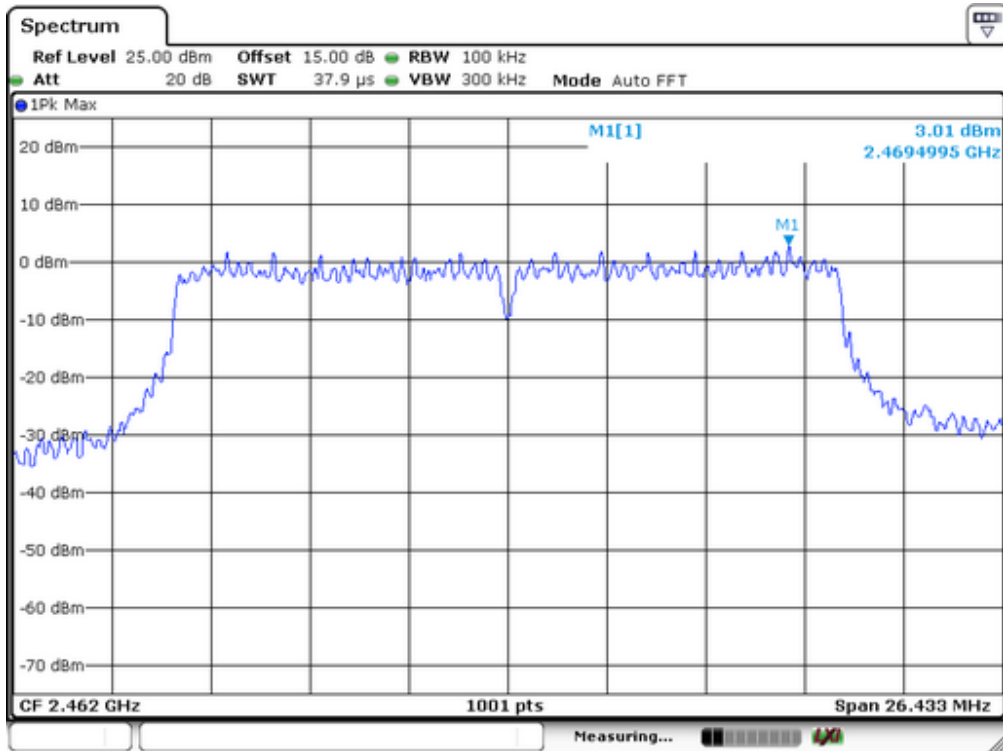

Highest Channel

Test Mode: 802.11n(H40)

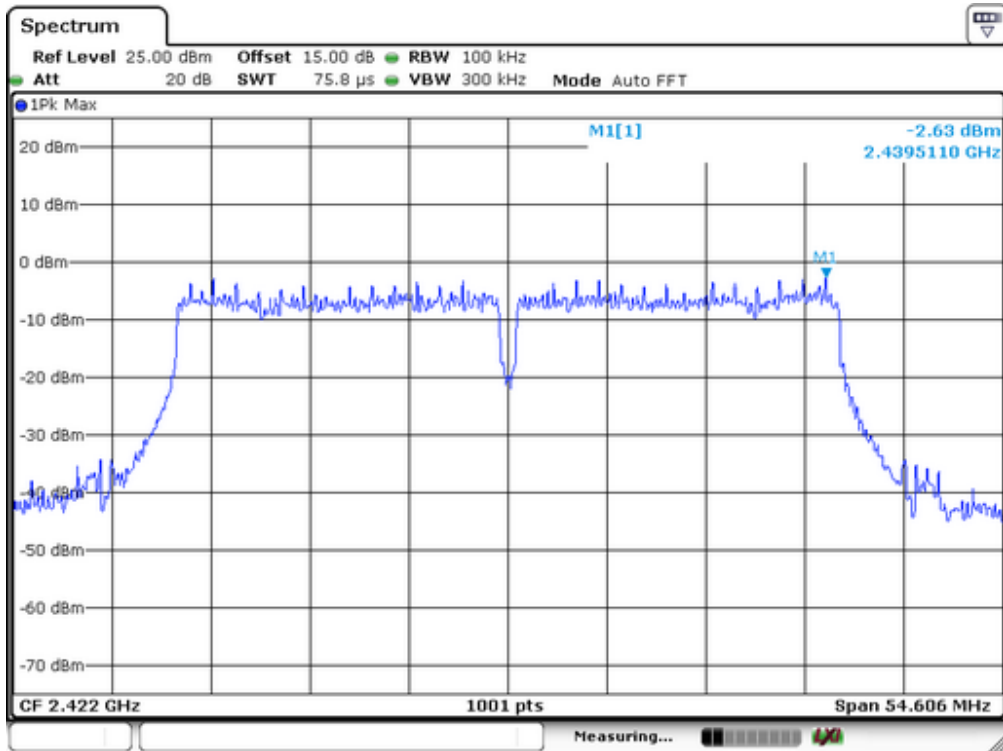

Lowest Channel

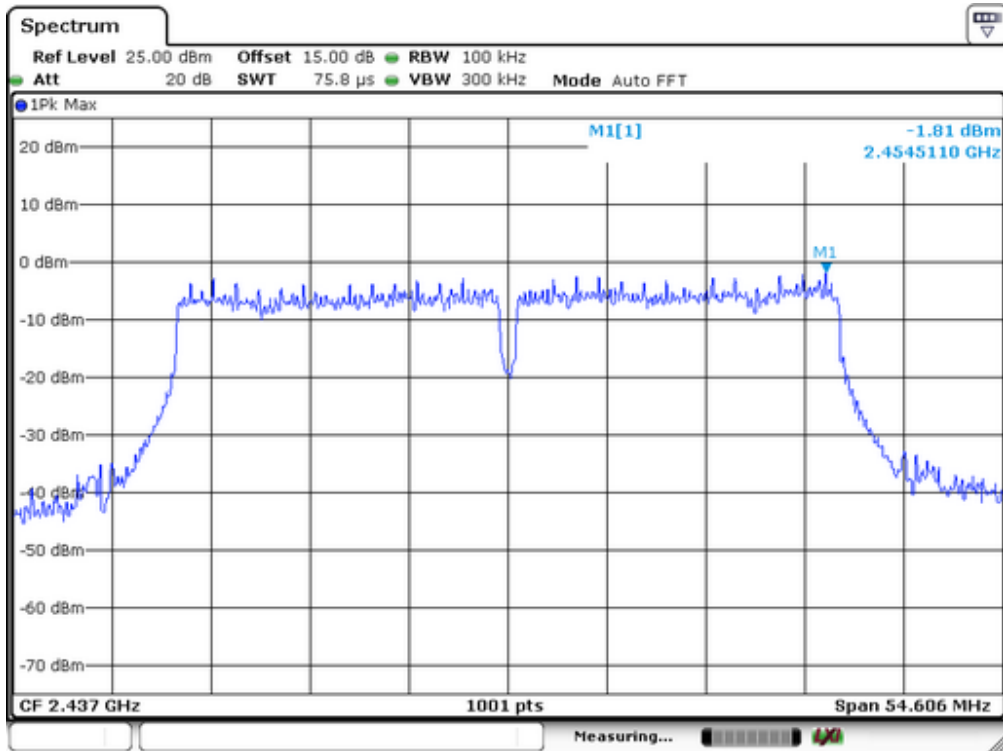

Middle Channel

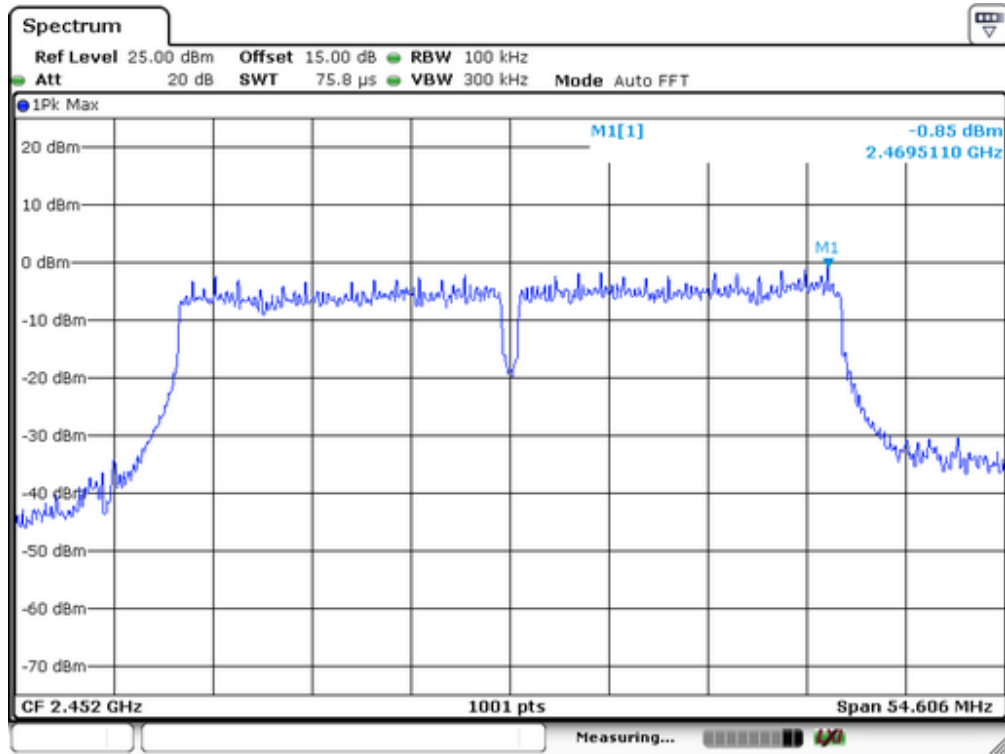

Highest Channel

Test mode: 802.11b

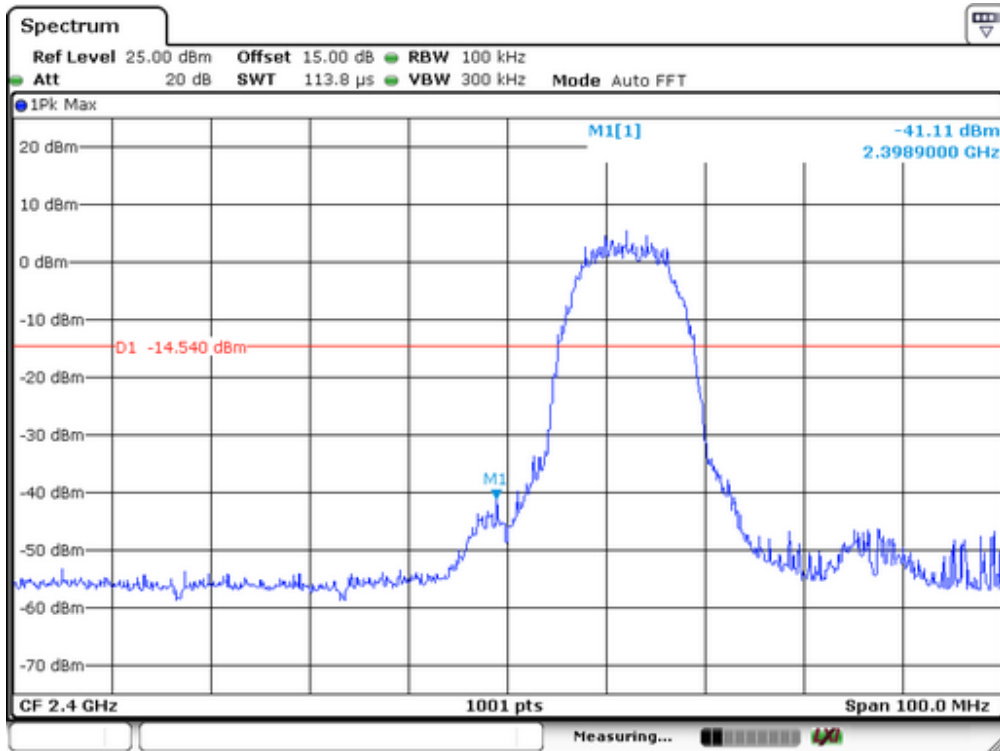

Lowest Channel

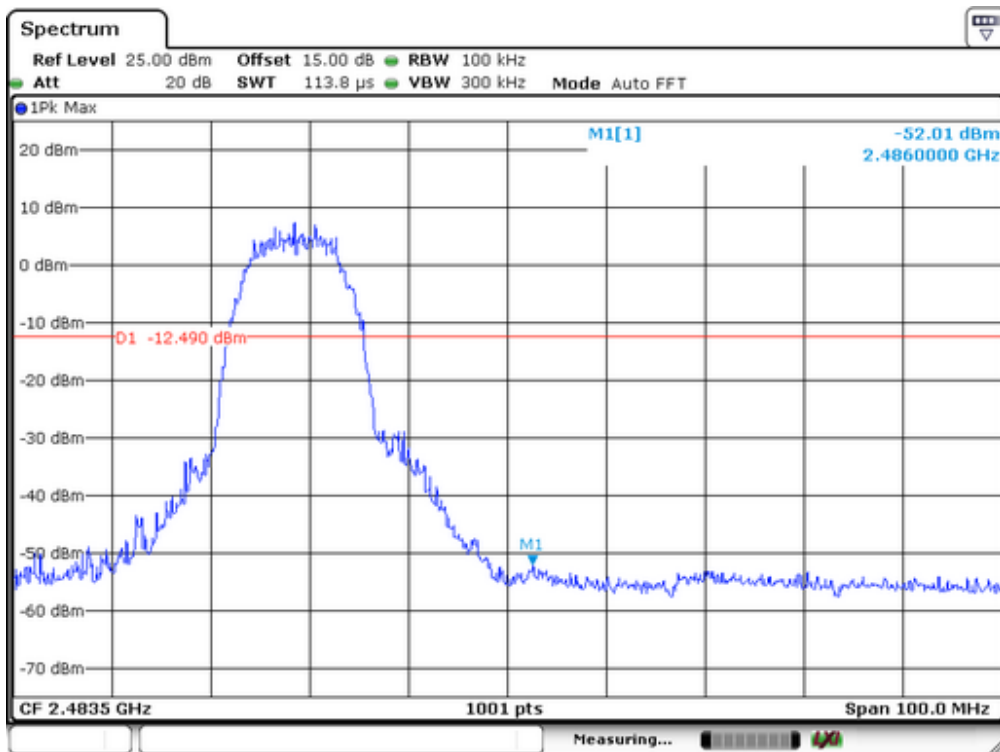

Highest Channel

Test mode: 802.11g

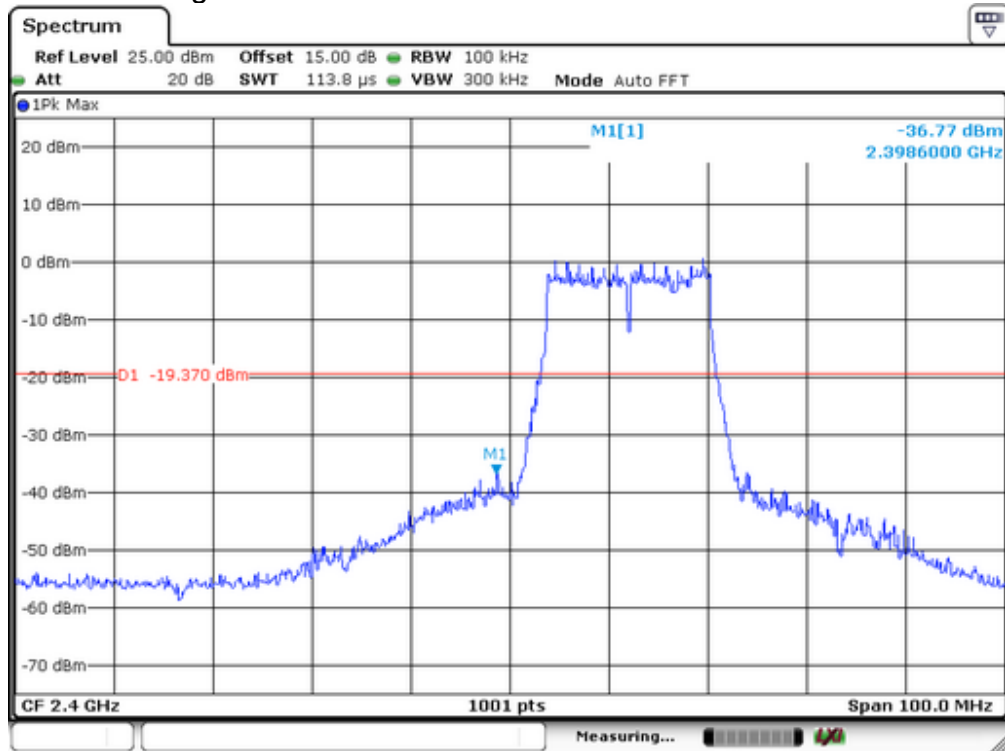

Lowest Channel

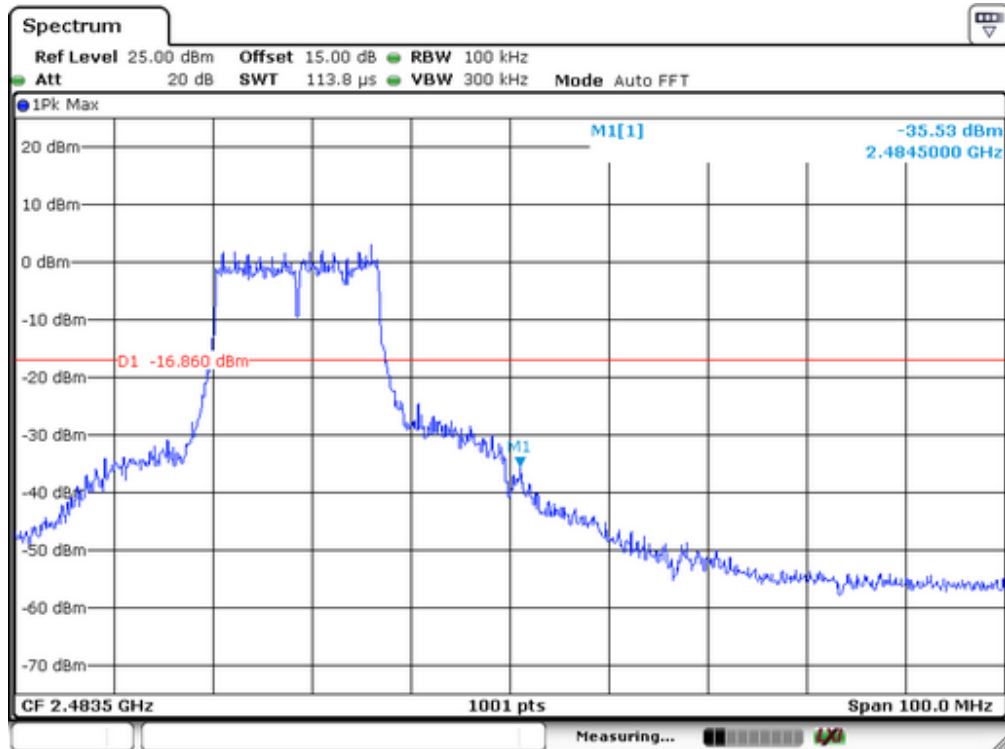

Highest Channel

Test mode: 802.11n(H20)

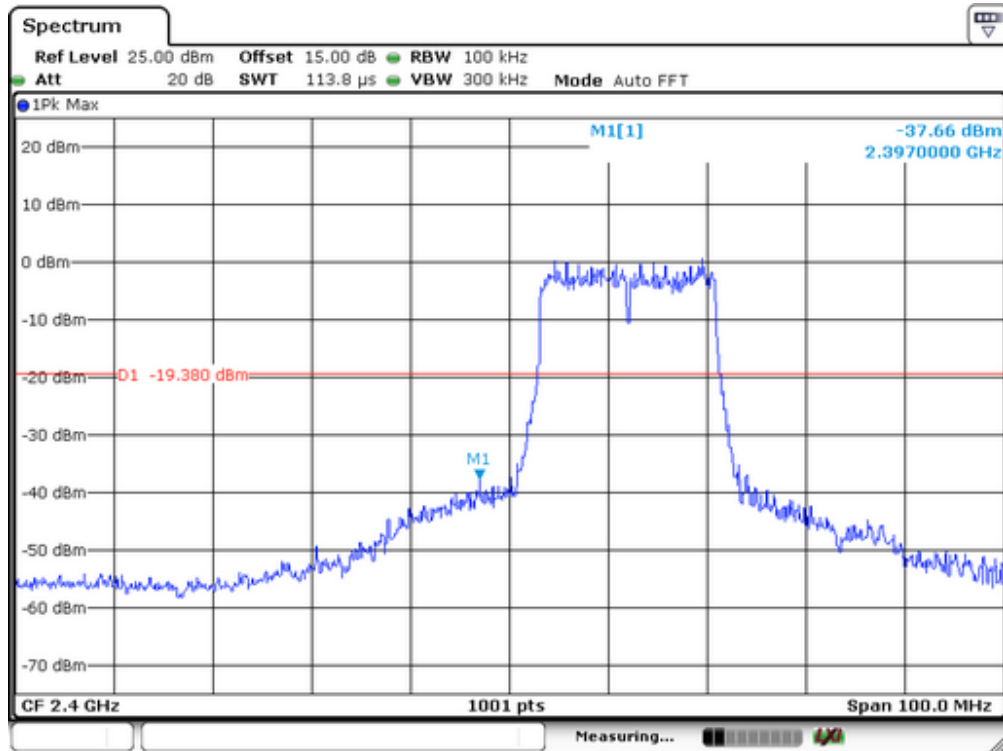

Lowest Channel

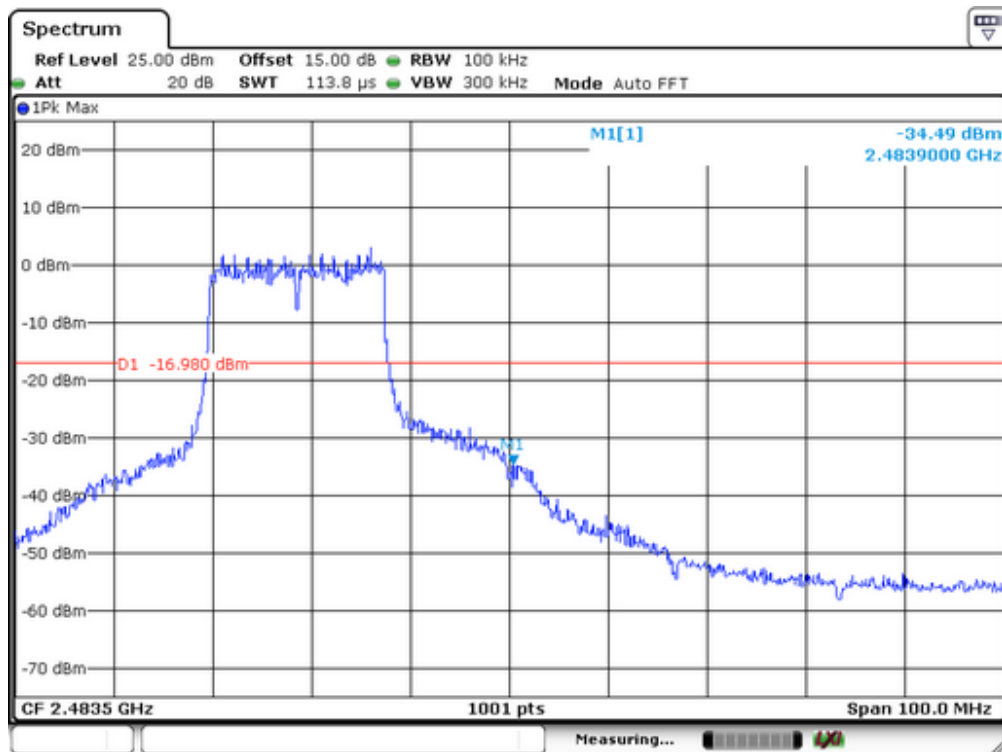

Highest Channel

Test mode: 802.11n(H40)

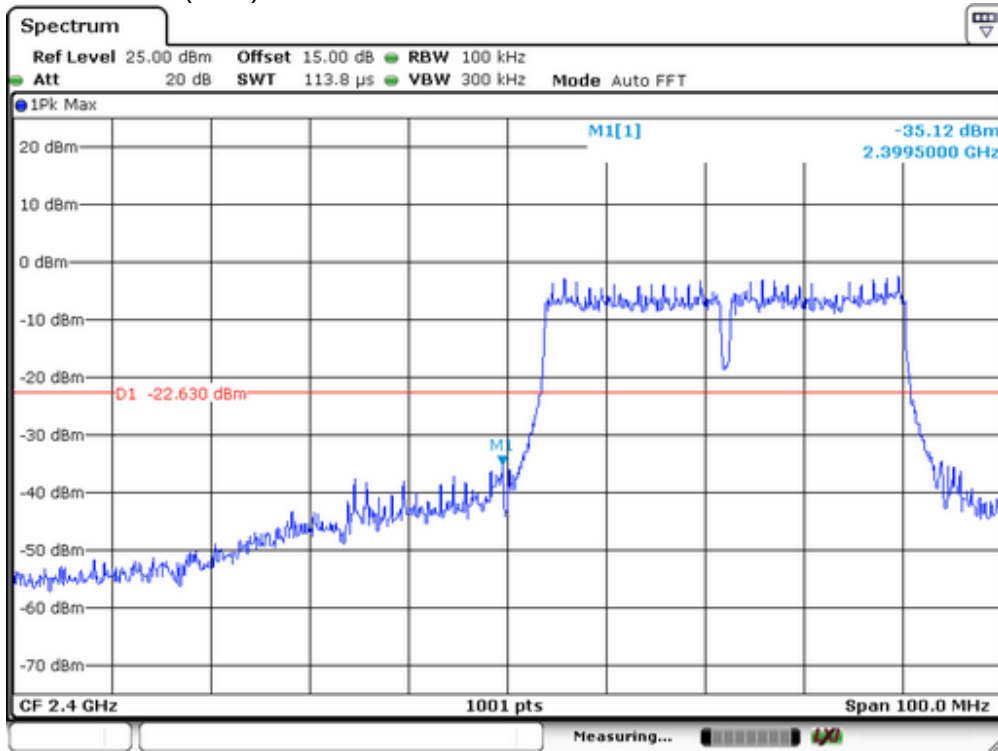

Lowest Channel

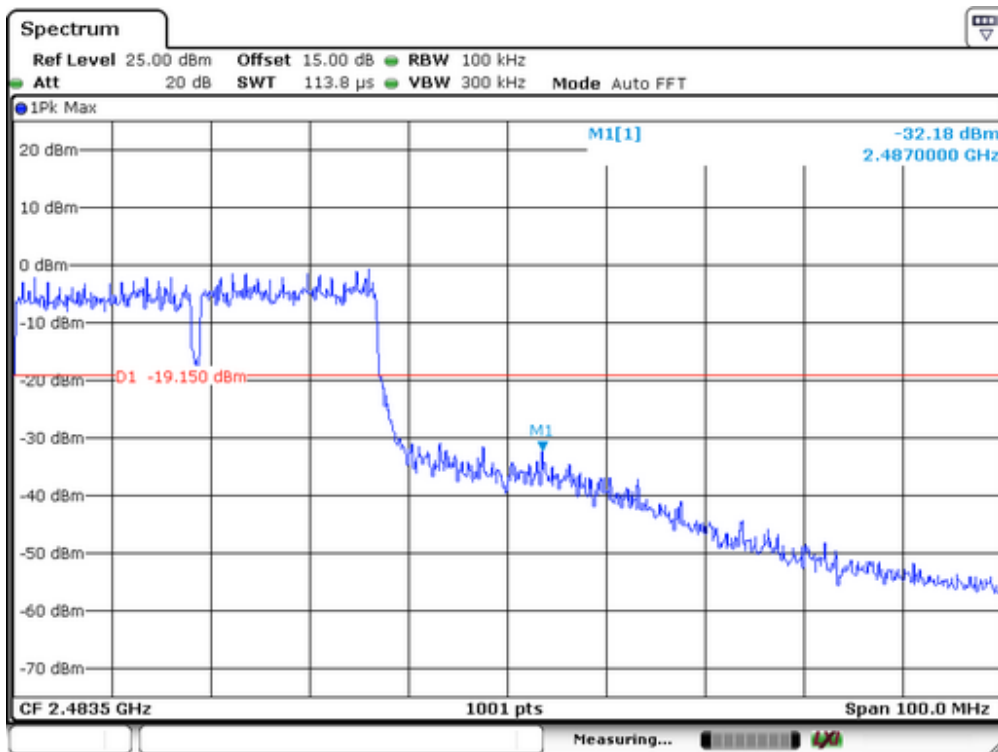

Highest Channel

2. Radiated emission Test

Spectrum Detector: PK/AV Test Date : October 13, 2014
 Test By: Andy Temperature : 28 °C
 Test mode: 802.11b Humidity : 65 %

Frequency (MHz)	Antenna polarization (H/V)	Emission (dBuV/m)		Band edge Limit (dBuV/m)	
		PK	AV	PK	AV
<2400	H	65.13	47.52	74.00	54.00
<2400	V	60.05	41.05	74.00	54.00
>2483.5	H	64.08	46.13	74.00	54.00
>2483.5	V	57.22	39.48	74.00	54.00

Spectrum Detector: PK/AV Test Date : October 13, 2014
 Test By: Andy Temperature : 28 °C
 Test mode: 802.11g Humidity : 65 %

Frequency (MHz)	Antenna polarization (H/V)	Emission (dBuV/m)		Band edge Limit (dBuV/m)	
		PK	AV	PK	AV
<2400	H	64.23	43.55	74.00	54.00
<2400	V	60.42	37.01	74.00	54.00
>2483.5	H	65.82	45.51	74.00	54.00
>2483.5	V	59.13	38.07	74.00	54.00

Spectrum Detector: PK/AV Test Date : October 13, 2014
 Test By: Andy Temperature : 28 °C
 Test mode: 802.11n(H20) Humidity : 65 %

Frequency (MHz)	Antenna polarization (H/V)	Emission (dBuV/m)		Band edge Limit (dBuV/m)	
		PK	AV	PK	AV
<2400	H	65.13	43.01	74.00	54.00
<2400	V	59.72	37.26	74.00	54.00
>2483.5	H	66.05	45.17	74.00	54.00
>2483.5	V	58.13	36.55	74.00	54.00

Spectrum Detector: PK/AV Test Date : October 13, 2014
 Test By: Andy Temperature : 28 °C
 Test mode: 802.11n(H40) Humidity : 65 %

Frequency (MHz)	Antenna polarization (H/V)	Emission (dBuV/m)		Band edge Limit (dBuV/m)	
		PK	AV	PK	AV
<2400	H	64.02	43.59	74.00	54.00
<2400	V	57.45	36.15	74.00	54.00
>2483.5	H	66.22	44.28	74.00	54.00
>2483.5	V	56.59	37.56	74.00	54.00

10. Power Density

10.1 Test Equipment

EQUIPMENT TYPE	MFR	MODEL NUMBER	SERIAL NUMBER	LAST CAL.	CAL DUE.
Spectrum Analyzer	Agilent	FSV30	1321.3008K	05/16/2014	05/15/2015

10.2 Measuring Instruments and Setting

The following table is the setting of spectrum analyzer.

Spectrum analyzer	Setting
Attenuation	Auto
Span Frequency	Set the span to 1.5 times the DTS bandwidth.
RB	3kHz
VB	10kHz
Detector	Peak
Trace	Max hold
Sweep Time	Automatic

10.3 Test Procedures

- The transmitter output (antenna port) was connected to the spectrum analyzer.
- Set analyzer center frequency to DTS channel center frequency.
- Set the analyzer span to a minimum of 1.5 times the DTS bandwidth.
- Set the RBW ≥ 3 kHz. Set the VBW $\geq 3 \times$ RBW.
- Detector = peak.
- Sweep time = auto couple.
- Trace mode = max hold.
- Allow trace to fully stabilize.
- Use the peak marker function to determine the maximum amplitude level.

10.4 Block Diagram of Test Setup

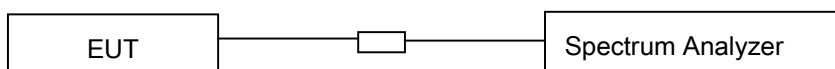

10.5 Limit

The transmitted power density averaged over any 1 second interval shall not be greater +8dBm in any 3 kHz bandwidth.

10.6 Test Result

Spectrum Detector: PK Test Date : October 13, 2014
 Test By: Andy Temperature : 28°C
 Test Mode: 802.11b Humidity : 60%

Channel frequency (MHz)	Measurement level (dBm)	Limit(dBm)	Result
2412	-9.15	8	Pass
2437	-8.88		
2462	-7.45		

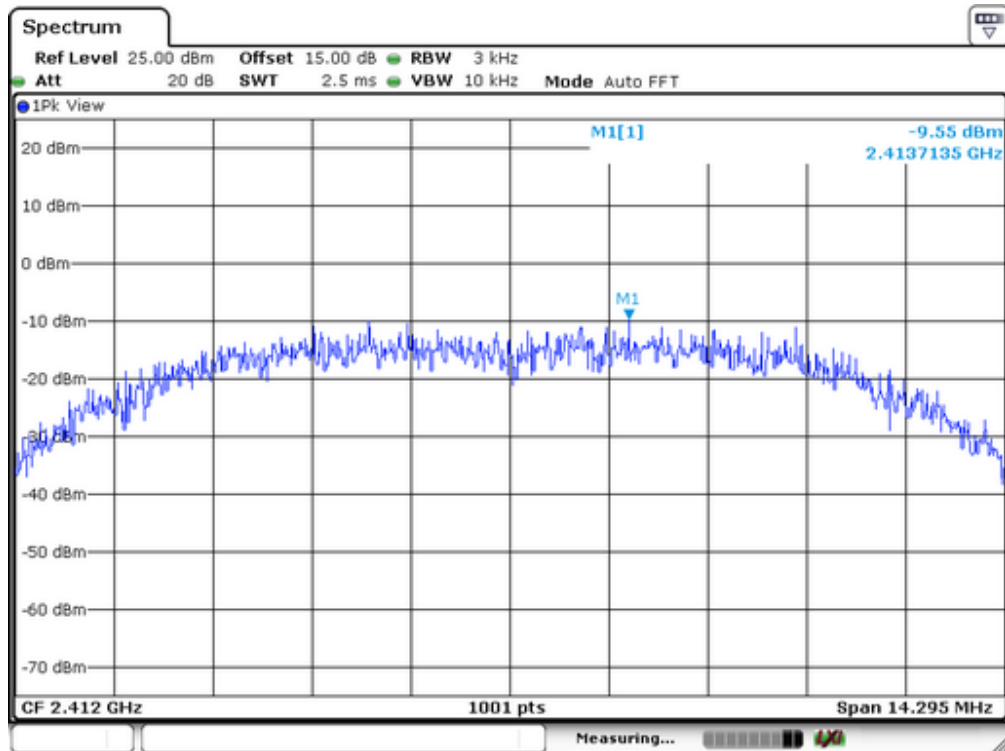

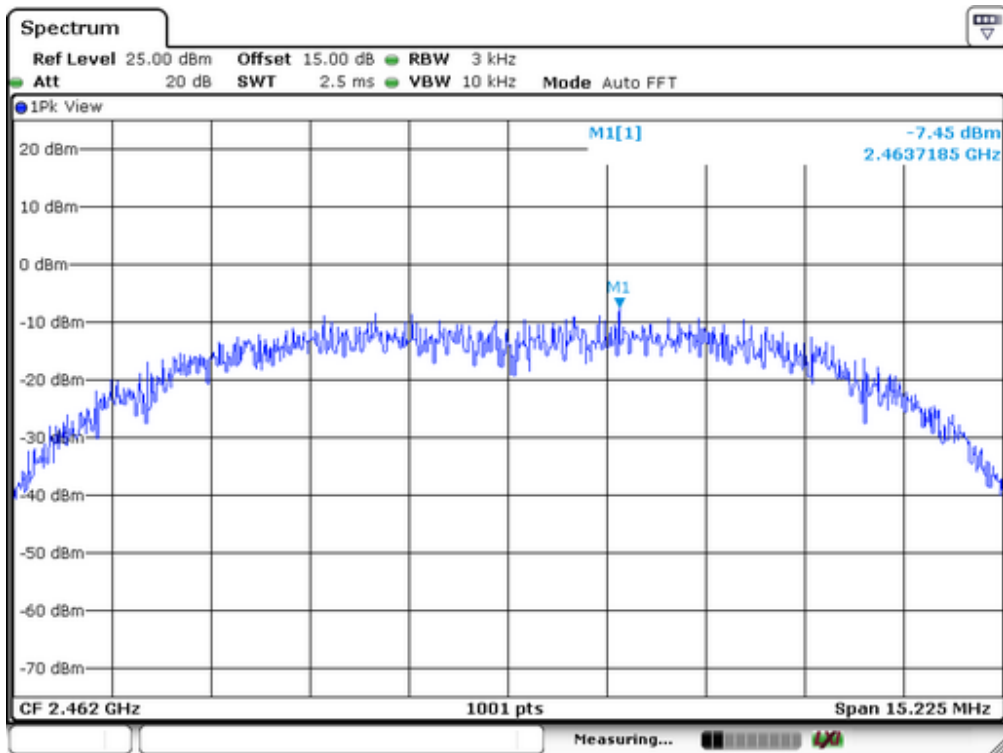
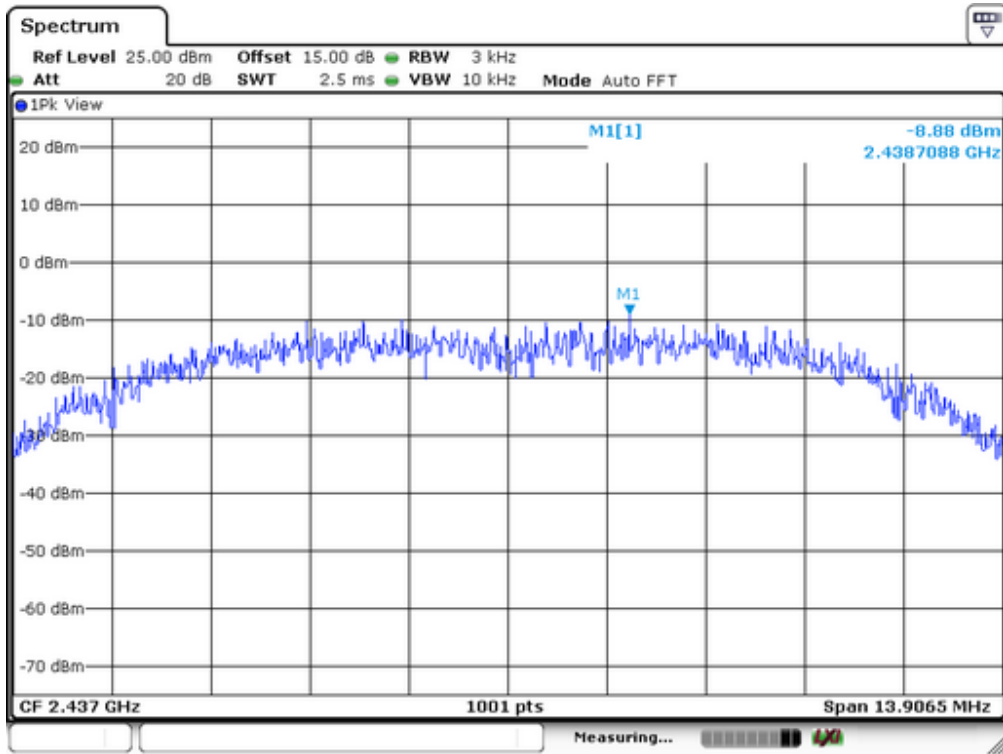

Spectrum Detector: PK Test Date : October 13, 2014
 Test By: Andy Temperature : 28°C
 Test Mode: 802.11g Humidity : 60%

Channel frequency (MHz)	Measurement level (dBm)	Limit(dBm)	Result
2412	-14.20	8	Pass
2437	-13.29		
2462	-11.96		

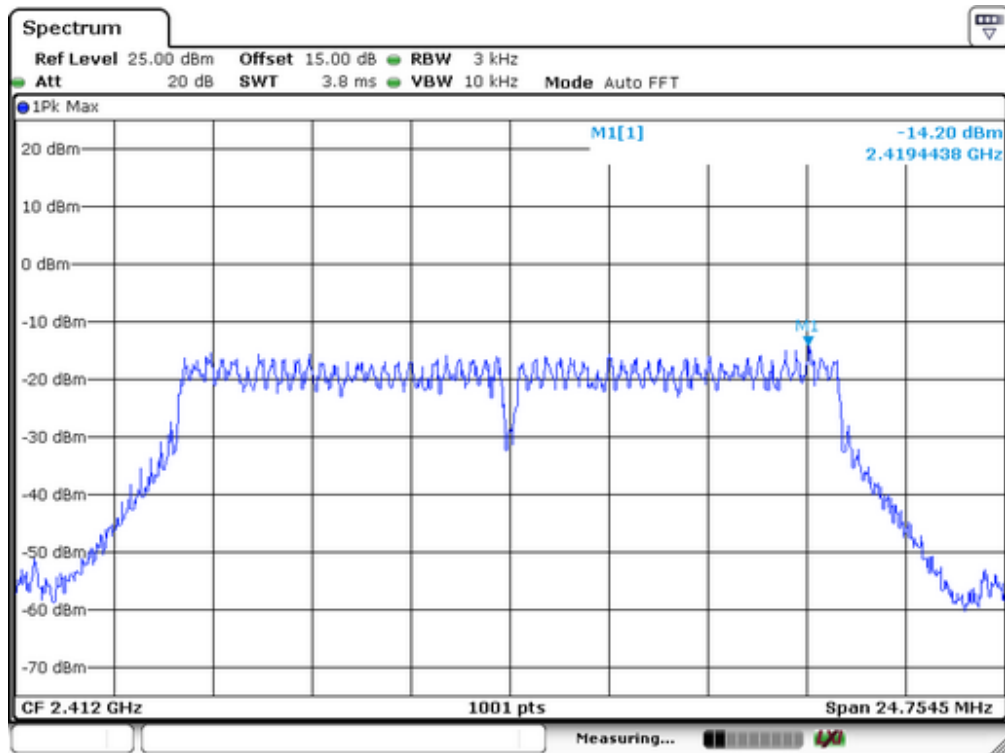

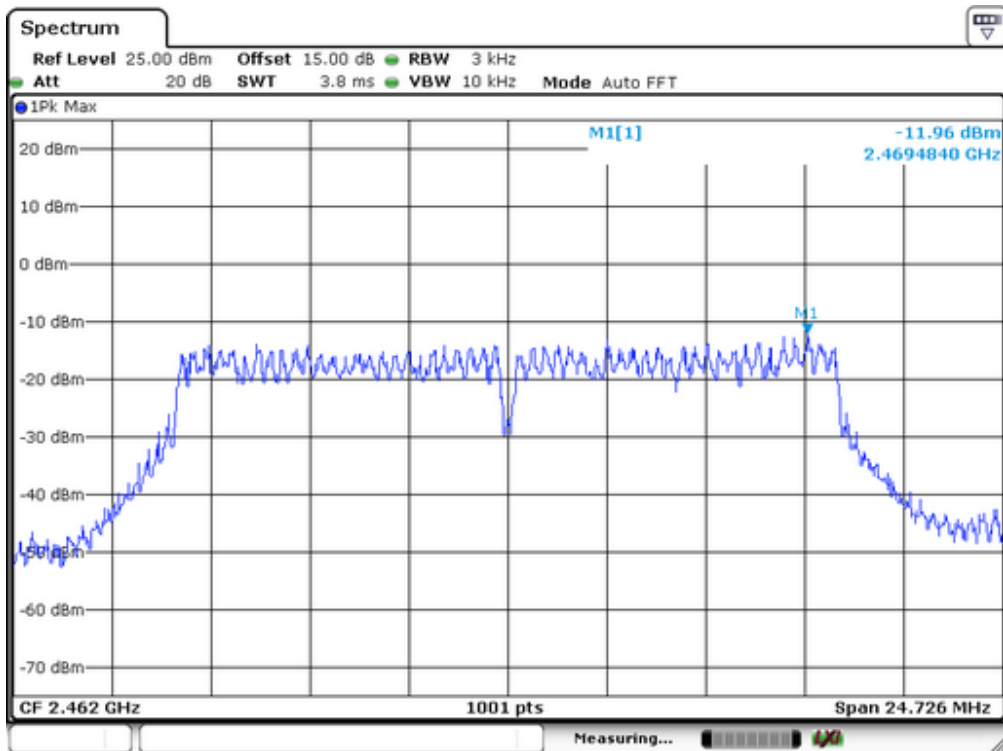
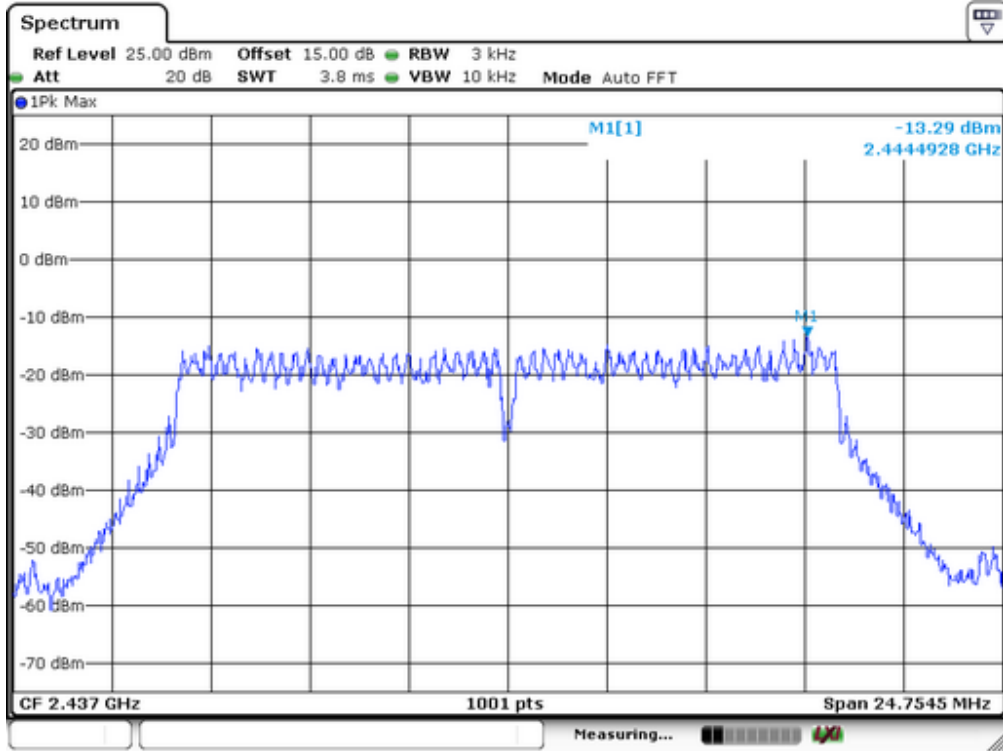

Spectrum Detector: PK Test Date : October 13, 2014
 Test By: Andy Temperature : 28°C
 Test Mode: 802.11n(H20) Humidity : 60%

Channel frequency (MHz)	Measurement level (dBm)	Limit(dBm)	Result
2412	-14.91	8	Pass
2437	-14.43		
2462	-13.08		

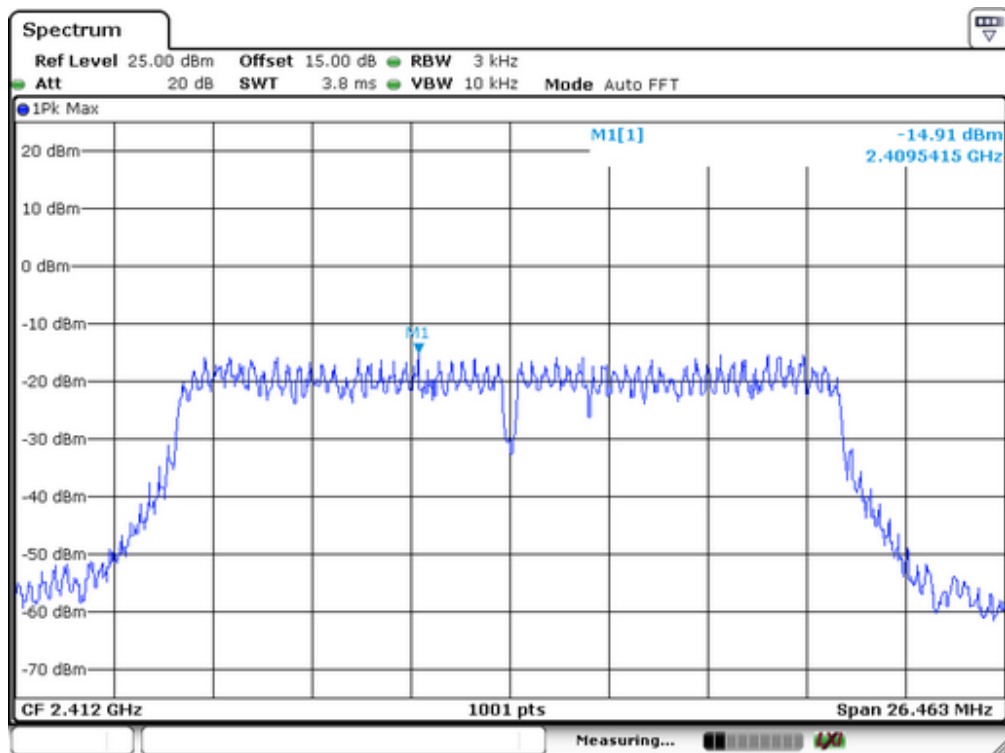

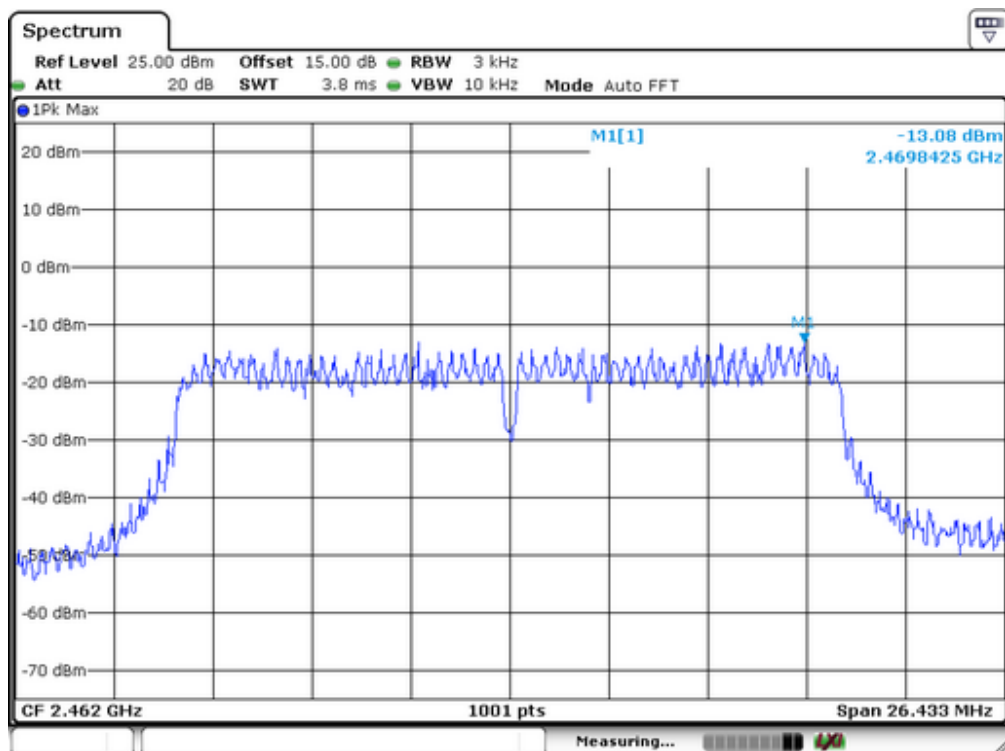
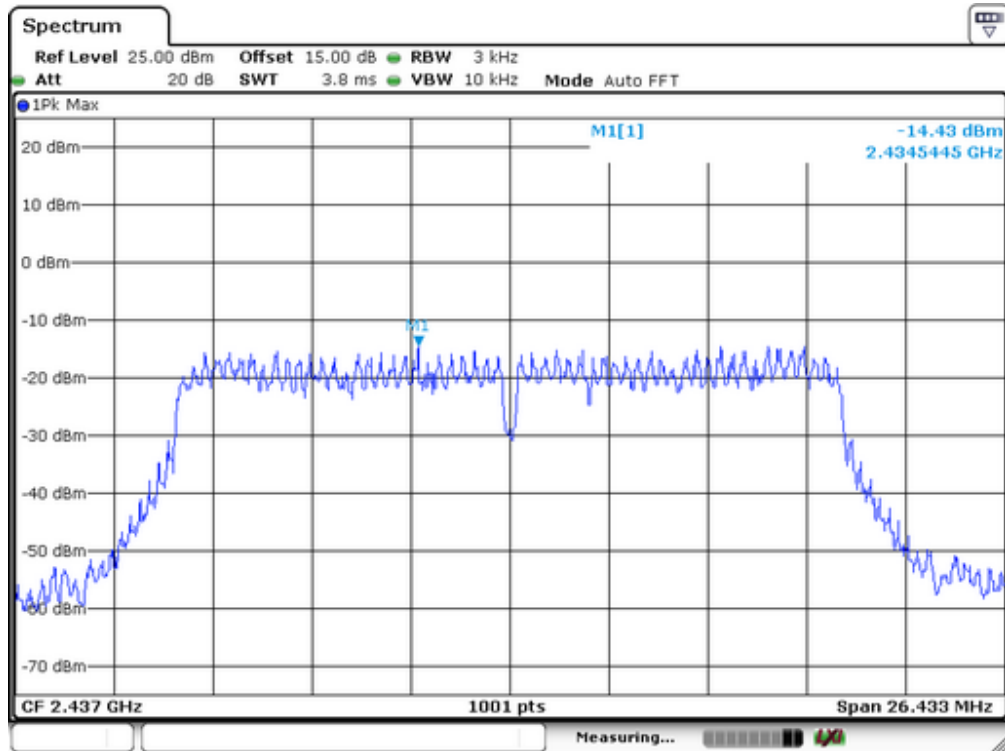

Spectrum Detector: PK Test Date : October 13, 2014
 Test By: Andy Temperature : 28°C
 Test Mode: 802.11n(H40) Humidity : 60%

Channel frequency (MHz)	Measurement level (dBm)	Limit(dBm)	Result
2422	-20.03	8	Pass
2437	-19.07		
2452	-18.18		

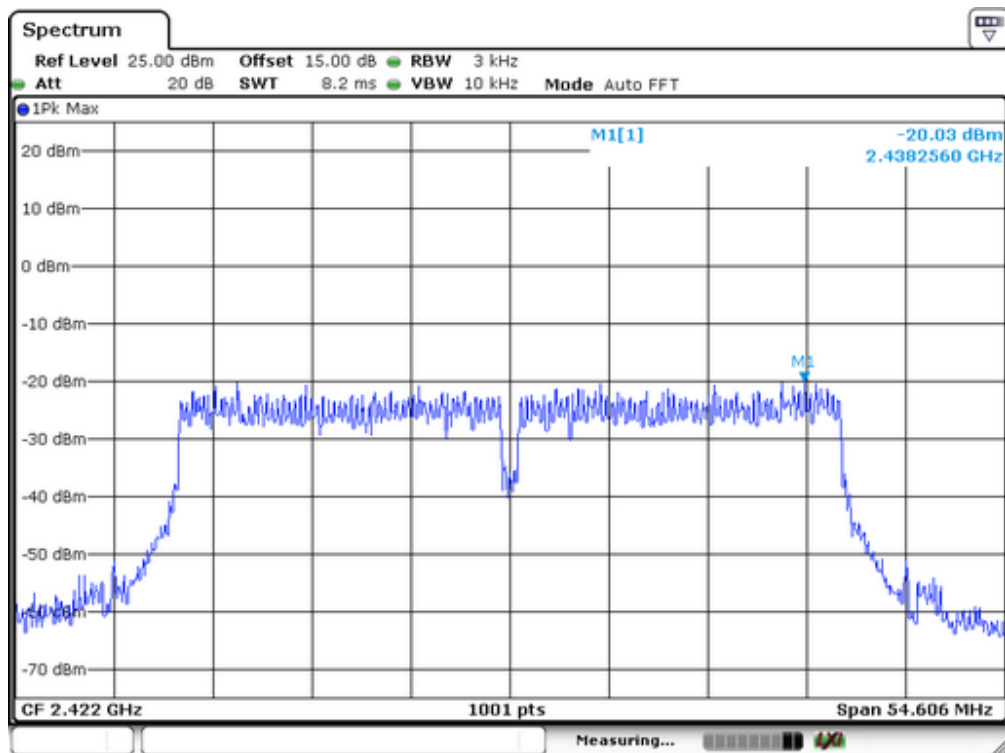

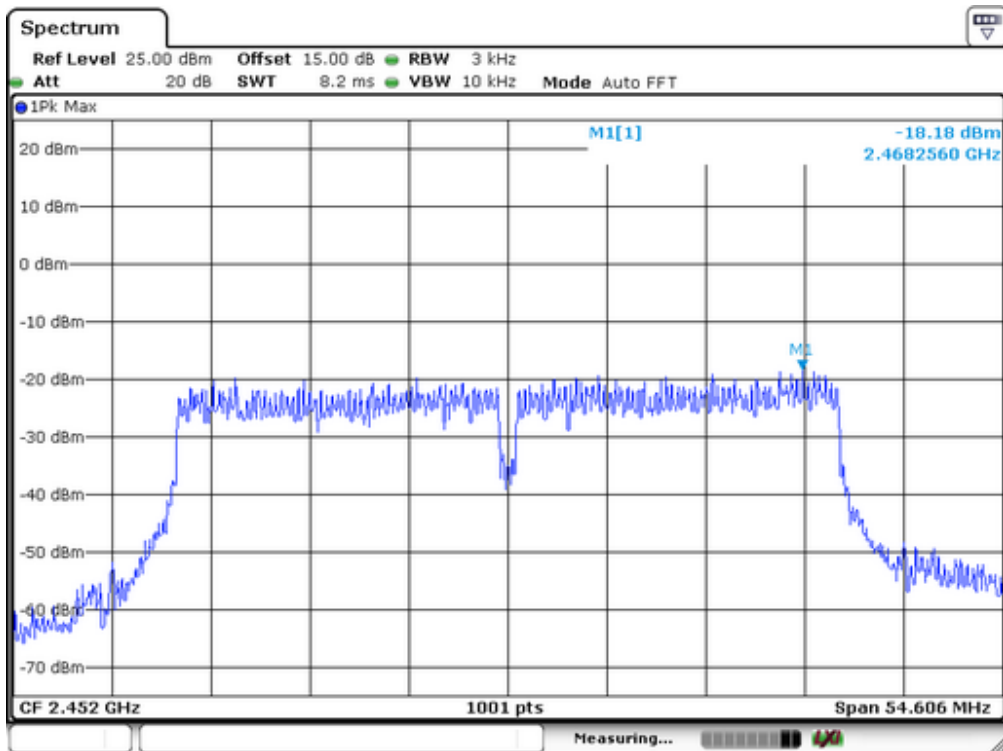
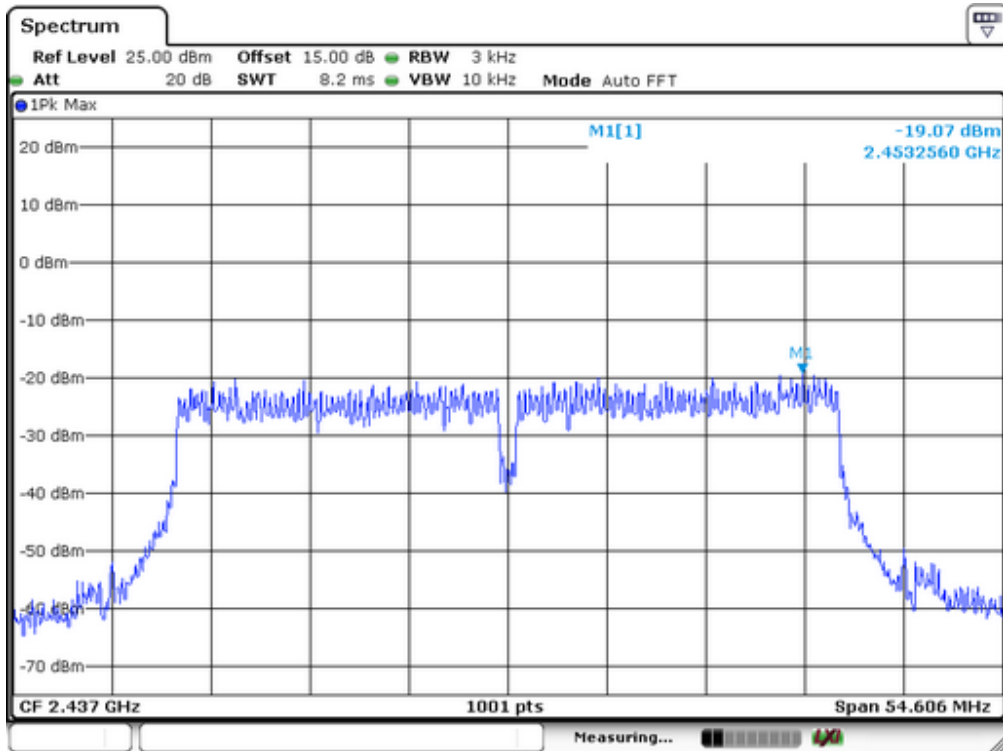

11. Antenna Port Emission

11.1 Test Equipment

EQUIPMENT TYPE	MFR	MODEL NUMBER	SERIAL NUMBER	LAST CAL.	CAL DUE.
Spectrum Analyzer	Agilent	FSV30	1321.3008K	05/16/2014	05/15/2015

11.2 Measuring Instruments and Setting

The following table is the setting of spectrum analyzer.

Spectrum analyzer	Setting
Attenuation	Auto
RB	100kHz
VB	300kHz
Detector	Peak
Trace	Max hold

11.3 Test Procedures

The conducted spurious emissions were measured conducted using a spectrum analyzer at low, Middle, and high channels, the limit was determined by attenuation 20dB of the RF peak power output.

11.4 Block Diagram of Test setup

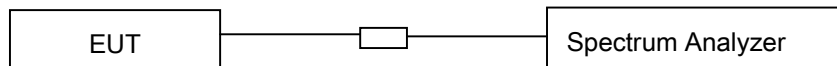

11.5 Test Result

PASS.

Test Mode: 802.11b

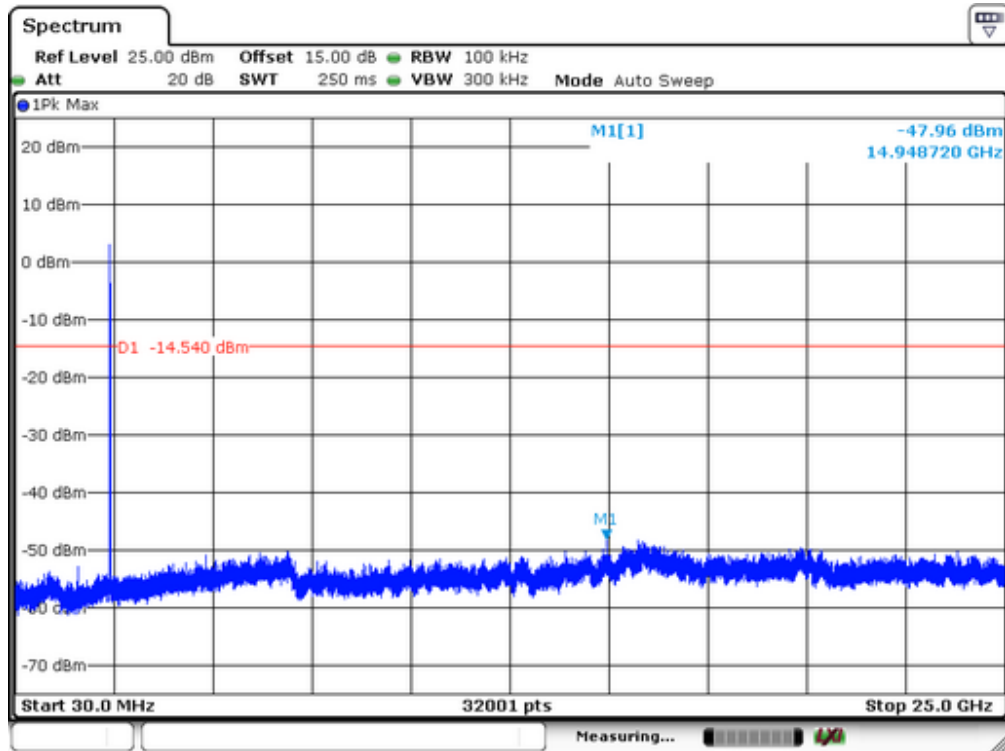

Lowest Channel

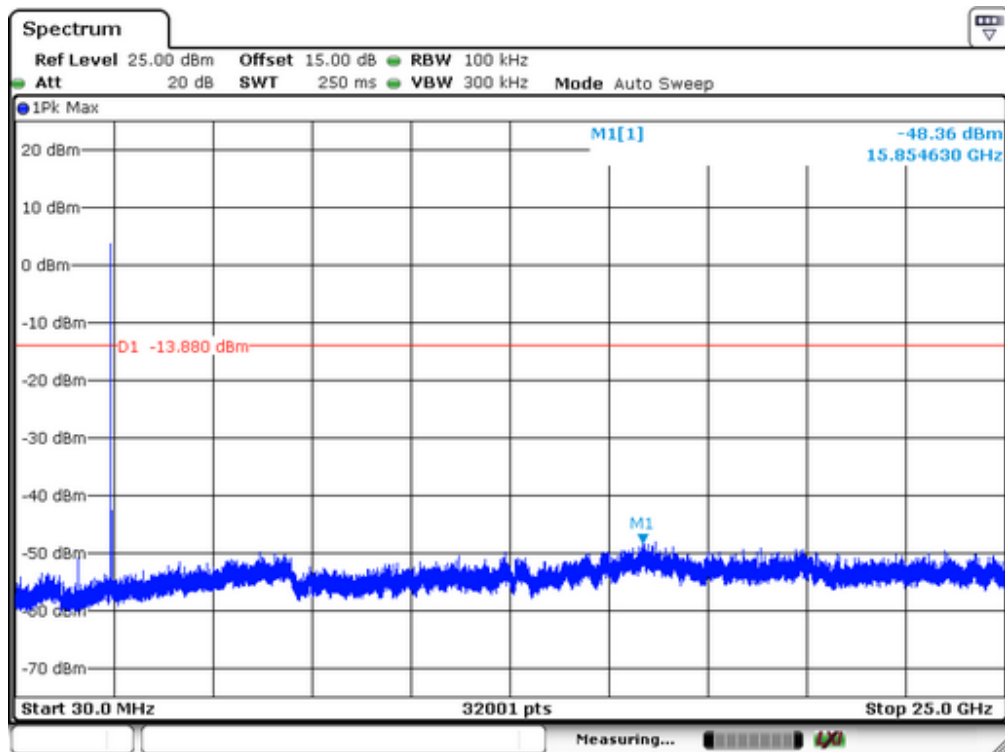

Middel Channel

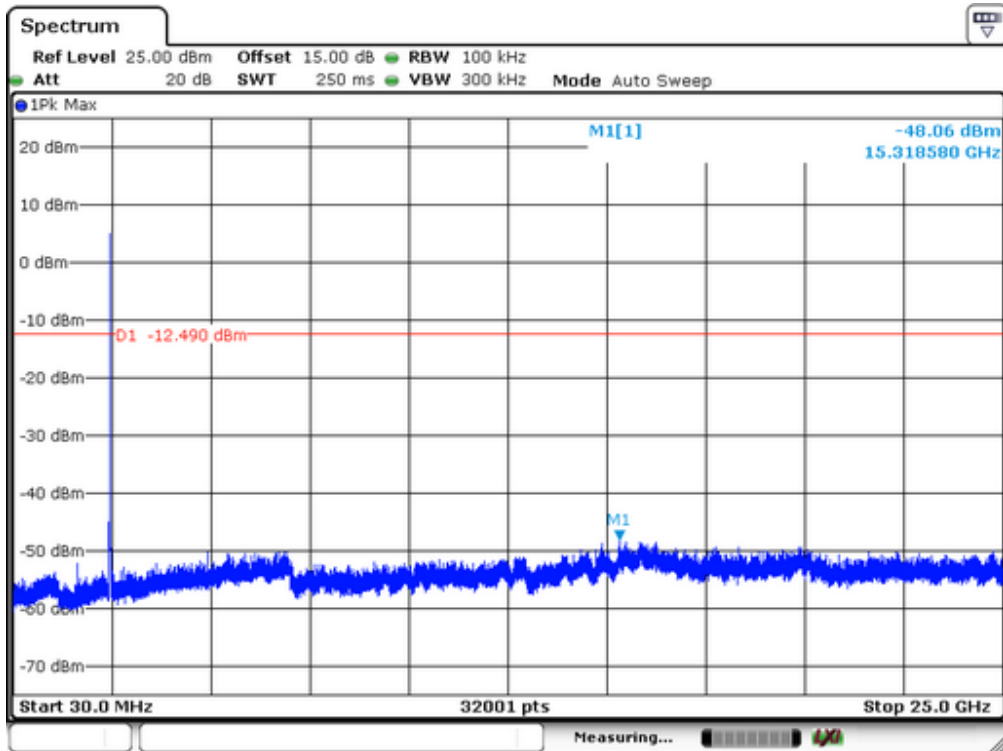

Highest Channel

Test Mode: 802.11g

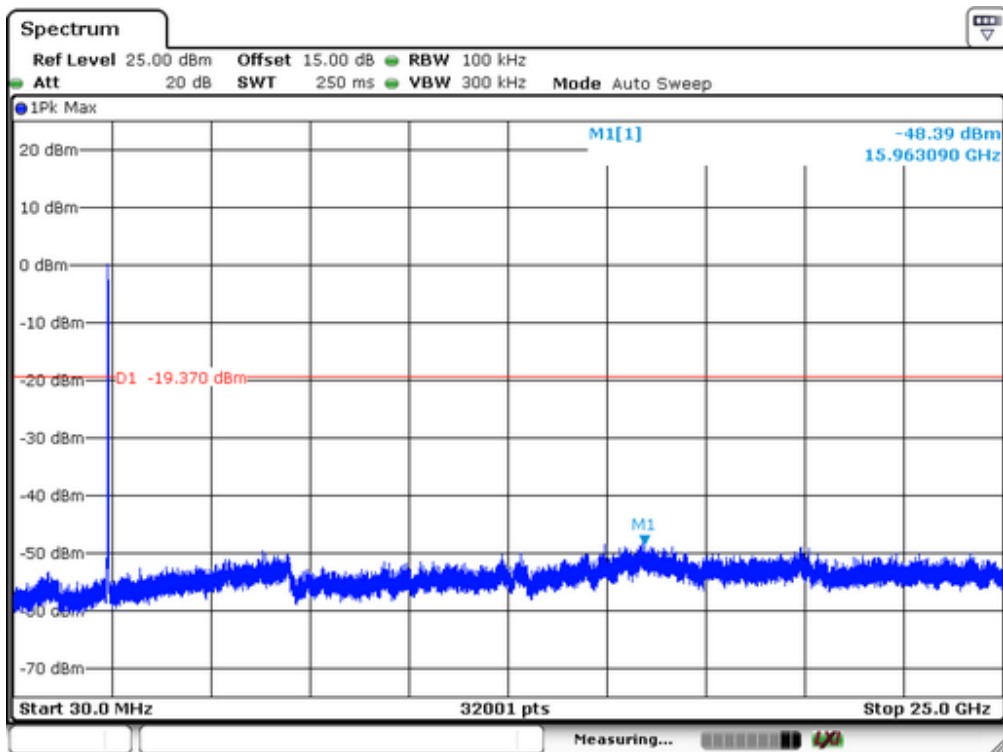

Lowest Channel

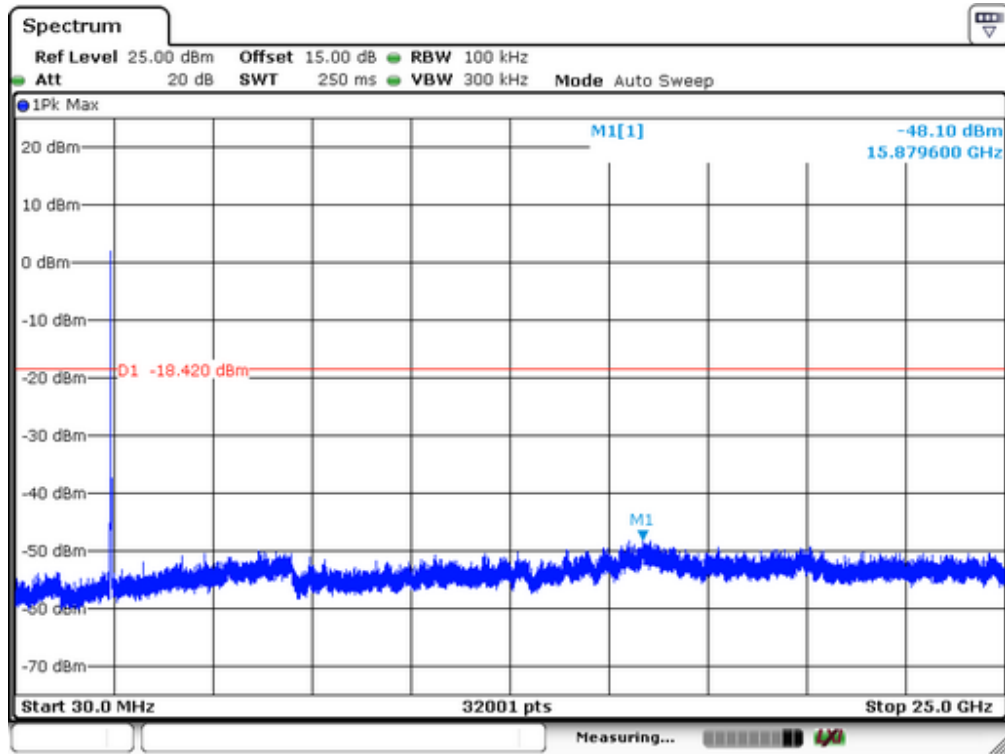

Middle Channel

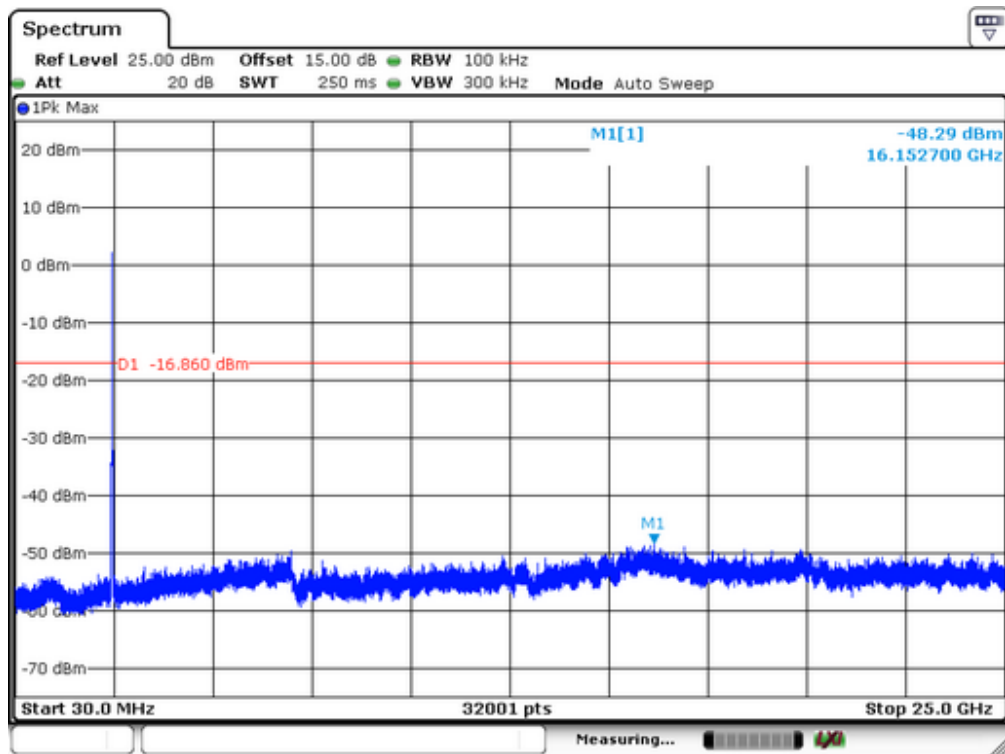

Highest Channel

Test Mode: 802.11n(H20)

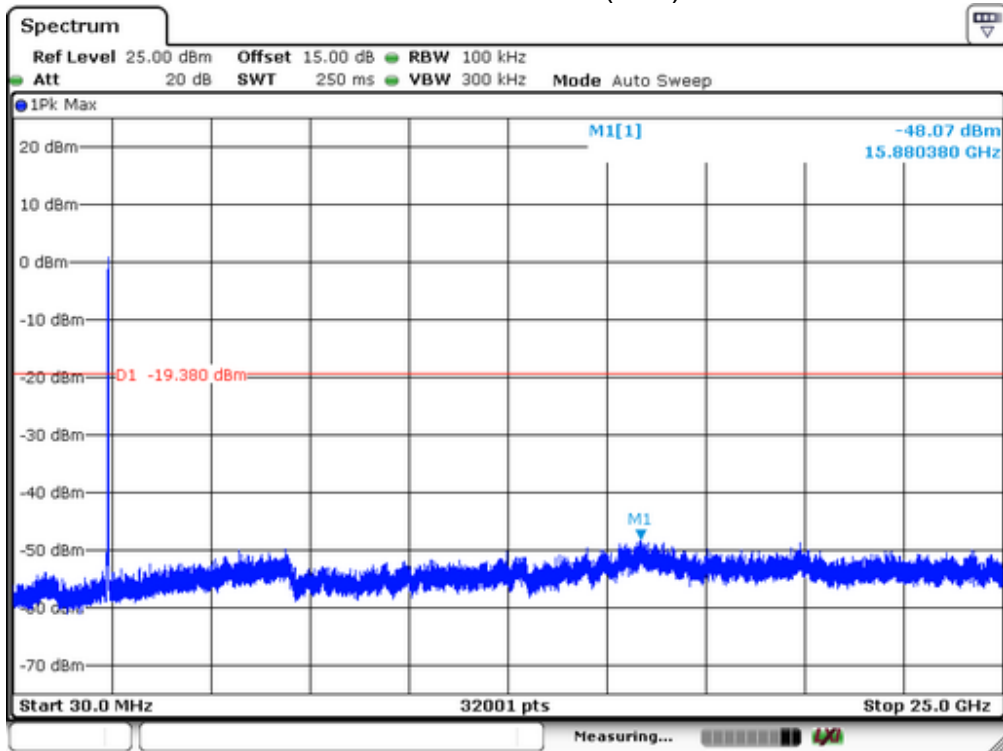

Lowest Channel

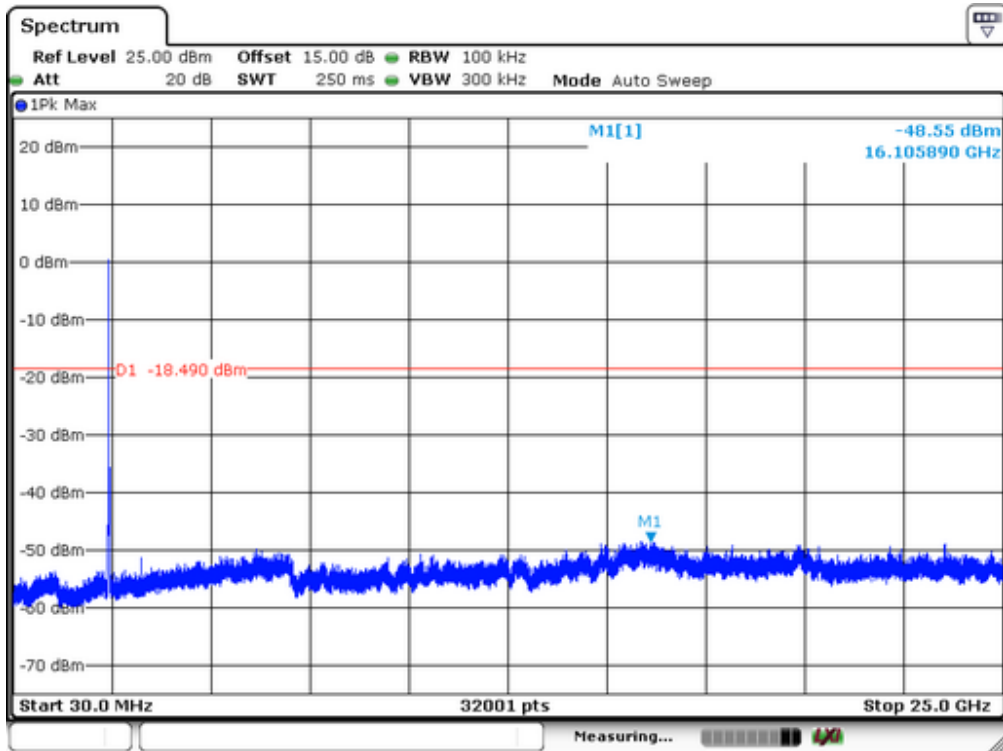

Middle Channel

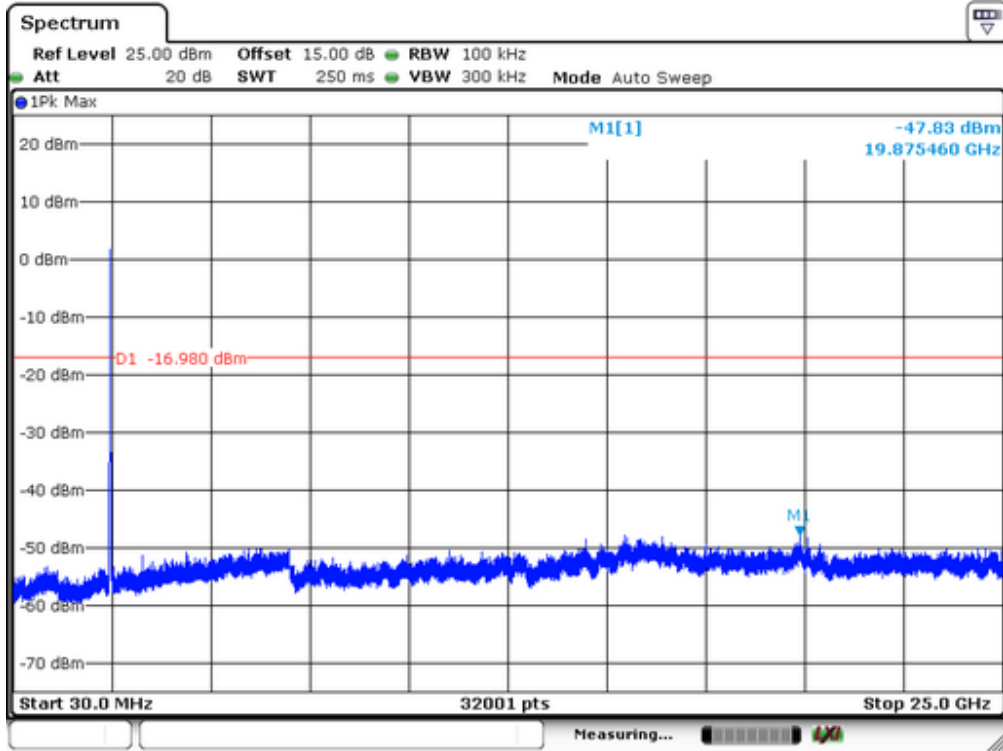

Highest Channel

Test Mode: 802.11n(H40)

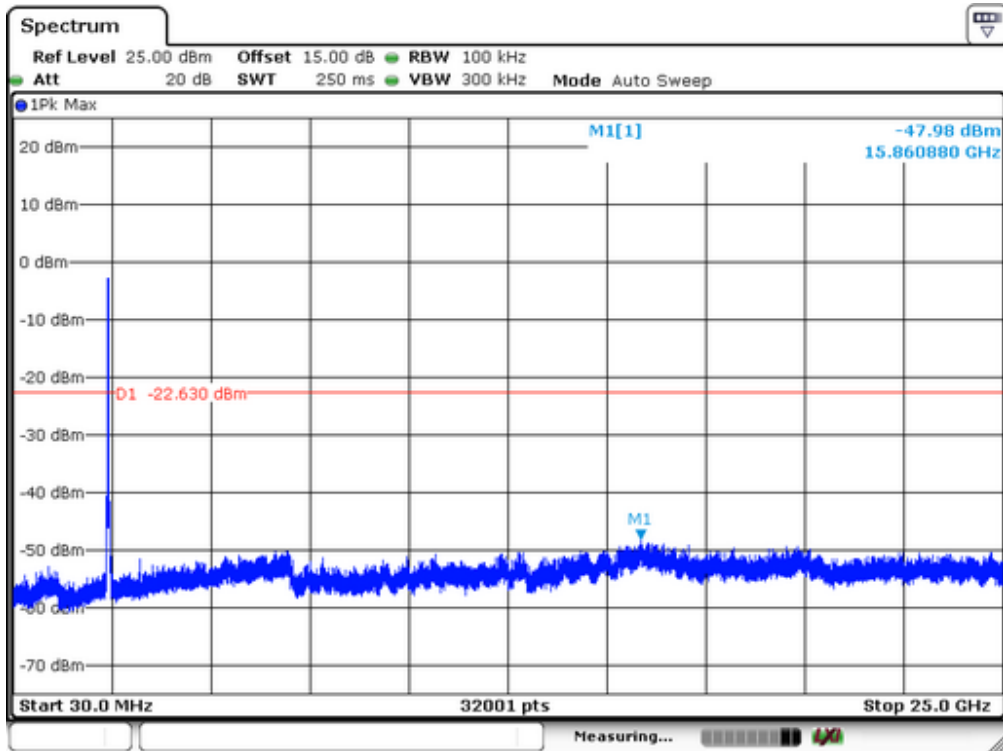

Lowest Channel

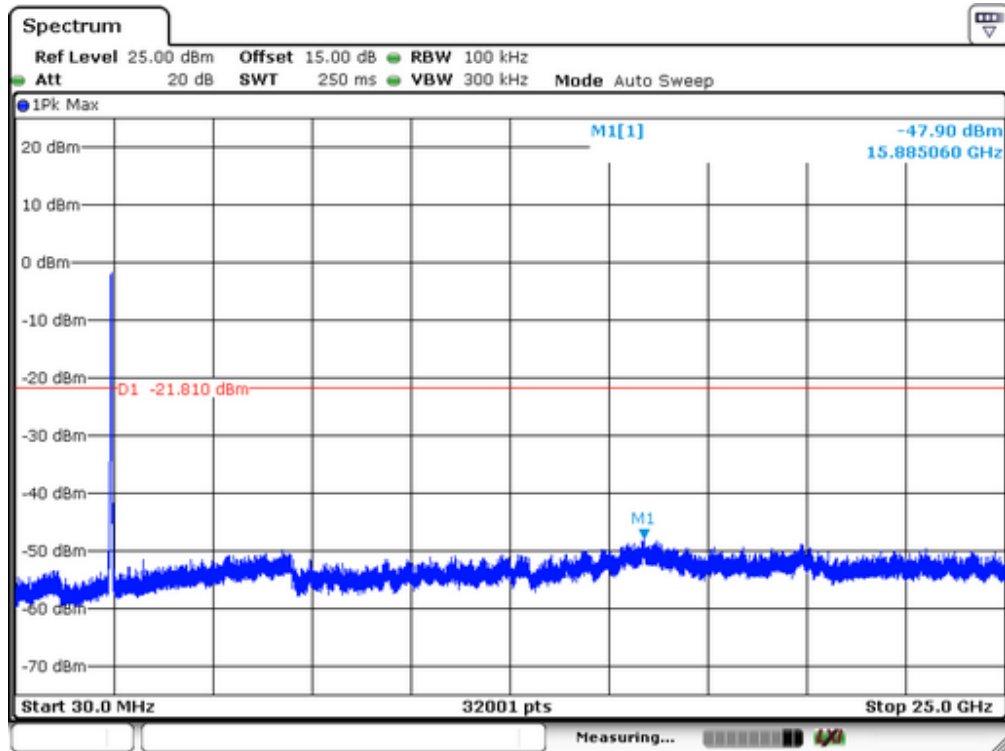

Middle Channel

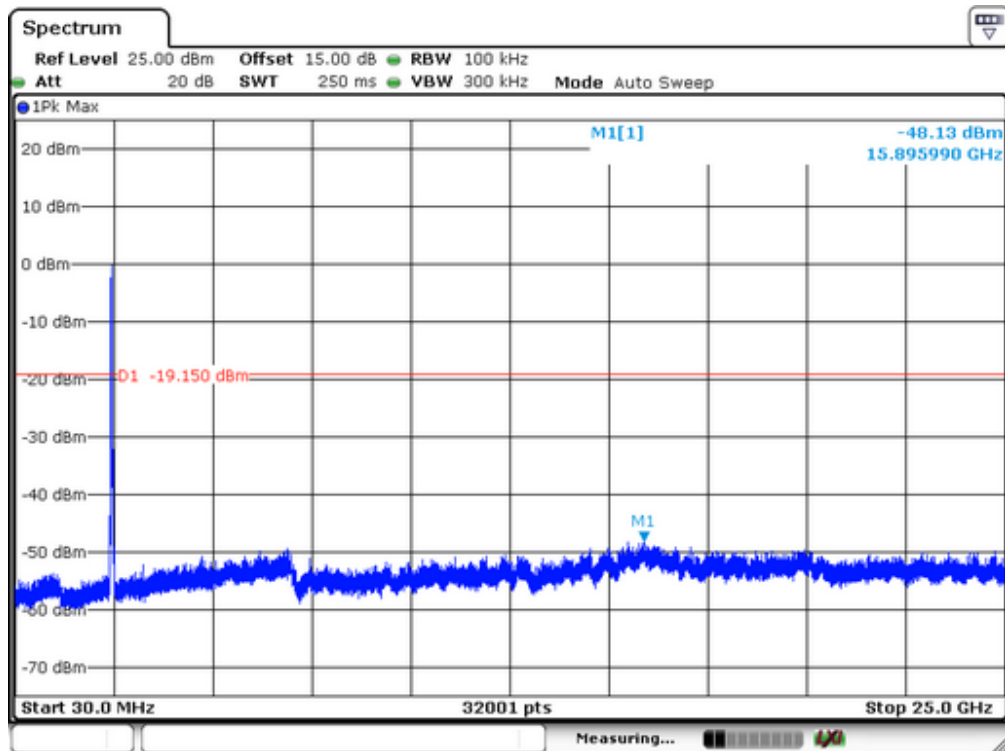

Highest Channel

12. Antenna Application

12.1 Antenna Requirement

For intentional device, according to FCC 47 CFR Section 15.203, an intentional radiator shall be designed to ensure that no antenna other than that furnished by the responsible party shall be used with the device. And according to FCC 47 CFR Section 15.247 (b), if transmitting antennas of directional gain greater than 6dBi are used, the power shall be reduced by the amount in dB that the directional gain of the antenna exceeds 6dBi.

12.2 Result

The EUT'S antenna is an internal antenna. The antenna's gain is 2 dBi and meets the requirement.

APPENDIX I (PHOTOS OF EUT)





