

# FCC RADIO TEST REPORT

## FCC 47 CFR PART 15 SUBPART C

<b>Test Standard</b>	<b>FCC Part 15.247</b>
<b>FCC ID</b>	<b>2ACWI-1204</b>
<b>Product name</b>	<b>Bluetooth Remote Control</b>
<b>Brand name</b>	<b>SEIKI, Westinghouse, element</b>
<b>Model name</b>	<b>PR_Pepper</b>
<b>Test Result</b>	<b>Pass</b>

The test Result was tested by Compliance Certification Services Inc. The test data, data evaluation, test procedures, and equipment configurations shown in this report were given in ANSI C63.10: 2013 and compliance standards.

The test results of this report relate only to the tested sample (EUT) identified in this report.

The test Report of full or partial shall not copy. Without written approval of Compliance Certification Services Inc. (Wugu Laboratory)

The sample selected for test was production product and was provided by manufacturer.



Approved by:

Handwritten signature of Sam Chuang in black ink.

Sam Chuang  
Manager

Tested by:

Handwritten signature of Jerry Chuang in black ink.

Jerry Chuang  
Engineer

## Revision History

Rev.	Issue Date	Revisions	Revised By
00	December 6, 2017	Initial Issue	May Lin

---

## Table of contents

<b>1. GENERAL INFORMATION .....</b>	<b>4</b>
<b>1.1 EUT INFORMATION .....</b>	<b>4</b>
<b>1.2 EUT CHANNEL INFORMATION .....</b>	<b>5</b>
<b>1.3 ANTENNA INFORMATION .....</b>	<b>5</b>
<b>1.4 MEASUREMENT UNCERTAINTY.....</b>	<b>6</b>
<b>1.5 FACILITIES AND TEST LOCATION .....</b>	<b>6</b>
<b>1.6 INSTRUMENT CALIBRATION .....</b>	<b>7</b>
<b>1.7 SUPPORT AND EUT ACCESSORIES EQUIPMENT .....</b>	<b>9</b>
<b>2. TEST SUMMERY .....</b>	<b>10</b>
<b>3. DESCRIPTION OF TEST MODES .....</b>	<b>11</b>
<b>3.1 THE WORST MODE OF OPERATING CONDITION .....</b>	<b>11</b>
<b>3.2 THE WORST MODE OF MEASUREMENT .....</b>	<b>12</b>
<b>3.3 EUT DUTY CYCLE.....</b>	<b>13</b>
<b>4. TEST RESULT .....</b>	<b>14</b>
<b>4.1 AC POWER LINE CONDUCTED EMISSION .....</b>	<b>14</b>
<b>4.2 20DB BANDWIDTH AND OCCUPIED BANDWIDTH(99%) .....</b>	<b>15</b>
<b>4.3 OUTPUT POWER MEASUREMENT .....</b>	<b>18</b>
<b>4.4 FREQUENCY SEPARATION .....</b>	<b>20</b>
<b>4.5 NUMBER OF HOPPING.....</b>	<b>22</b>
<b>4.6 CONDUCTED BANDEGE AND SPURIOUS EMISSION.....</b>	<b>24</b>
<b>4.7 TIME OF OCCUPANCY (DWELL TIME) .....</b>	<b>29</b>
<b>4.8 RADIATION BANDEGE AND SPURIOUS EMISSION .....</b>	<b>31</b>
<b>APPENDIX 1 - PHOTOGRAPHS OF EUT</b>	

## 1. GENERAL INFORMATION

### 1.1 EUT INFORMATION

Applicant	SHENYANG TONGFANG MULTIMEDIA TECHNOLOGY CO.,LTD
Applicant Address	No.10 NANPING EAST ROAD,HUNNAN NEW DISTRICT, SHENYANG,CHINA
Equipment	Bluetooth Remote Control
Model Name	PR_Pepper
Model Discrepancy	N/A
EUT Functions	BT2.1+EDR
Received Date	July 19, 2017
Date of Test	November 28 ~ December 1, 2017
Output Power(W)	GFSK : 0.00057 W 8DPSK : 0.00025W
Power Operation	Power from DC Battery

## 1.2 EUT CHANNEL INFORMATION

Frequency Range	2402MHz-2480MHz
Modulation Type	1. GFSK for BR-1Mbps 2. 8DPSK for EDR-3Mbps
Number of channel	79 Channels

**Remark:**

Refer as ANSI 63.10:2013 clause 5.6.1 Table 4 for test channels

Number of frequencies to be tested		
Frequency range in which device operates	Number of frequencies	Location in frequency range of operation
<input type="checkbox"/> 1 MHz or less	1	Middle
<input type="checkbox"/> 1 MHz to 10 MHz	2	1 near top and 1 near bottom
<input checked="" type="checkbox"/> More than 10 MHz	3	1 near top, 1 near middle, and 1 near bottom

## 1.3 ANTENNA INFORMATION

<b>Antenna Type</b>	<input type="checkbox"/> PIFA(Printed) <input checked="" type="checkbox"/> PCB <input type="checkbox"/> Dipole <input type="checkbox"/> Chip <input type="checkbox"/> Coils
<b>Antenna Gain</b>	1.95 dBi

## 1.4 MEASUREMENT UNCERTAINTY

PARAMETER	UNCERTAINTY
AC Powerline Conducted Emission	+/- 1.2575
Emission bandwidth, 20dB bandwidth	+/- 1.4003
RF output power, conducted	+/- 1.1372
Power density, conducted	+/- 1.4003
3M Semi Anechoic Chamber / 30M~200M	+/- 4.0138
3M Semi Anechoic Chamber / 200M~1000M	+/- 3.9483
3M Semi Anechoic Chamber / 1G~8G	+/- 2.5975
3M Semi Anechoic Chamber / 8G~18G	+/- 2.6112
3M Semi Anechoic Chamber / 18G~26G	+/- 2.7389
3M Semi Anechoic Chamber / 26G~40G	+/- 2.9683
3M Semi Anechoic Chamber / 40G~60G	+/- 1.8509
3M Semi Anechoic Chamber / 60G~75G	+/- 1.9869
3M Semi Anechoic Chamber / 75G~110G	+/- 2.9651
3M Semi Anechoic Chamber / 110G~170G	+/- 2.7807
3M Semi Anechoic Chamber / 170G~220G	+/- 3.6437
3M Semi Anechoic Chamber / 220G~325G	+/- 4.2982

**Remark:**

1. This uncertainty represents an expanded uncertainty expressed at approximately the 95% confidence level using a coverage factor of  $k=2$
2. ISO/IEC 17025 requires that an estimate of the measurement uncertainties associated with the emissions test results be included in the report.

## 1.5 FACILITIES AND TEST LOCATION

All measurement facilities used to collect the measurement data are located at No.11, Wugong 6th Rd., Wugu Dist., New Taipei City 24891, Taiwan. (R.O.C.)

Test site	Test Engineer	Remark
AC Conduction Room	N/A	
Radiation	Jerry Chuang	
RF Conducted	Jerry Chuang	

**Remark:** The sites are constructed in conformance with the requirements of ANSI C63.7, ANSI C63.4 and CISPR Publication 22.

## 1.6 INSTRUMENT CALIBRATION

RF Conducted Test Site					
Name of Equipment	Manufacturer	Model	Serial Number	Calibration Date	Calibration Due
Power Meter	Anritsu	ML2495A	1033009	04/11/2017	04/10/2018
Power Sensor	Anritsu	MA2411B	917072	07/03/2017	07/02/2018
Spectrum Analyzer	R&S	FSV 40	101073	10/02/2017	10/01/2018

Wugu 966 Chamber A					
Name of Equipment	Manufacturer	Model	Serial Number	Calibration Date	Calibration Due
Bilog Antenna	Sunol Sciences	JB3	A030105	06/20/2017	06/19/2018
Horn Antenna	EMCO	3117	00055165	02/20/2017	02/19/2018
Horn Antenna	ETS LINDGREN	3116	00026370	01/12/2017	01/11/2018
K Type Cable	Huber+Suhner	SUCOFLEX 102	29406/2	01/10/2017	01/09/2018
K Type Cable	Huber+Suhner	SUCOFLEX 102	22470/2	01/10/2017	01/09/2018
Pre-Amplifier	MITEQ	AMF-6F-2604 00-40-8P	985646	01/10/2017	01/09/2018
Pre-Amplifier	EMCI	EMC 012635	980151	08/01/2017	07/31/2018
Pre-Amplifier	EMEC	EM01M26G	60570	08/01/2017	07/31/2018
Pre-Amplifier	EMEC	EM330	060609	06/07/2017	06/06/2018
Spectrum Analyzer	Agilent	E4446A	US42510252	11/27/2017	11/26/2018
Loop Ant	COM-POWER	AL-130	121051	03/02/2017	03/01/2018
Antenna Tower	CCS	CC-A-1F	N/A	N.C.R	N.C.R
Controller	CCS	CC-C-1F	N/A	N.C.R	N.C.R
Turn Table	CCS	CC-T-1F	N/A	N.C.R	N.C.R
Wideband Radio Communication Tester	R&S	CMW 500	116875	04/25/2017	04/24/2018

Conducted Emission Room # B					
Name of Equipment	Manufacturer	Model	Serial Number	Calibration Date	Calibration Due
N/A					

**Remark:**

- 1. Each piece of equipment is scheduled for calibration once a year and Precision Dipole is scheduled for calibration once three years.*
- 2. N.C.R. = No Calibration Request.*



## 1.7 SUPPORT AND EUT ACCESSORIES EQUIPMENT

EUT Accessories Equipment					
No.	Equipment	Brand	Model	Series No.	FCC ID
	N/A				

Support Equipment					
No.	Equipment	Brand	Model	Series No.	FCC ID
1	NB(H)	Acer	Aspire 4320 series	N/A	QDS-BRCM1018

## 1.8 TEST METHODOLOGY AND APPLIED STANDARDS

The test methodology, setups and results comply with all requirements in accordance with ANSI C63.10:2013, FCC Part 2, FCC Part 15.247.

## 2. TEST SUMMERY

FCC Standard Sec.	Report Sec.	Test Item	Result
15.203	1.2	Antenna Requirement	Pass
15.207	4.1	AC Conducted Emission	Pass
15.247(a)(1)	4.2	20 dB Bandwidth	Pass
-	4.2	Occupied Bandwidth (99%)	-
15.247(b)(1)	4.3	Output Power Measurement	Pass
15.247(a)(1)	4.4	Frequency Separation	Pass
15.247(b)(1)	4.5	Number of Hopping	Pass
15.247(d)	4.6	Conducted Band Edge	Pass
15.247(d)	4.6	Conducted Emission	Pass
15.247(d)	4.8	Radiation Band Edge	Pass
15.247(d)	4.8	Radiation Spurious Emission	Pass

### 3. DESCRIPTION OF TEST MODES

#### 3.1 THE WORST MODE OF OPERATING CONDITION

Operation mode	GFSK for BR-1Mbps (DH5) 8DPSK for EDR-3Mbps (DH5)
Test Channel Frequencies	<p><b>GFSK for BR-1Mbps:</b>                      1.Lowest Channel : 2402MHz                      2.Middle Channel : 2441MHz                      3.Highest Channel : 2480MHz</p> <p><b>8DPSK for EDR-3Mbps:</b>                      1.Lowest Channel : 2402MHz                      2.Middle Channel : 2441MHz                      3.Highest Channel : 2480MHz</p>

*Remark:*

1. EUT pre-scanned data rate of output power for each mode, the worst data rate were recorded in this report.

### 3.2 THE WORST MODE OF MEASUREMENT

Radiated Emission Measurement Above 1G	
Test Condition	Band edge, Emission for Unwanted and Fundamental
DC Voltage	DC 5V
Test Mode	Mode 1: EUT power by Host System.
Worst Mode	<input checked="" type="checkbox"/> Mode 1 <input type="checkbox"/> Mode 2 <input type="checkbox"/> Mode 3 <input type="checkbox"/> Mode 4
Worst Position	<input type="checkbox"/> Placed in fixed position. <input checked="" type="checkbox"/> Placed in fixed position at X-Plane (E2-Plane) <input type="checkbox"/> Placed in fixed position at Y-Plane (E1-Plane) <input type="checkbox"/> Placed in fixed position at Z-Plane (H-Plane)
Worst Polarity	<input type="checkbox"/> Horizontal <input checked="" type="checkbox"/> Vertical

Radiated Emission Measurement Below 1G	
Test Condition	Radiated Emission Below 1G
DC Voltage	DC 5V
Test Mode	Mode 1: EUT power by Host System.
Worst Mode	<input checked="" type="checkbox"/> Mode 1 <input type="checkbox"/> Mode 2 <input type="checkbox"/> Mode 3 <input type="checkbox"/> Mode 4

*Remark:*

1. The worst mode was record in this test report.
2. EUT pre-scanned in three axis, X, Y, Z and two polarity, Horizontal and Vertical for radiated measurement. The worst case (X-Plane and Vertical) were recorded in this report

### 3.3 EUT DUTY CYCLE

Duty Cycle				
Configuration	TX ON (ms)	TX ALL (ms)	Duty Cycle (%)	Duty Factor(dB)
BR-1Mbps	1	1	100	0
EDR-3Mbps	1	1	100	0

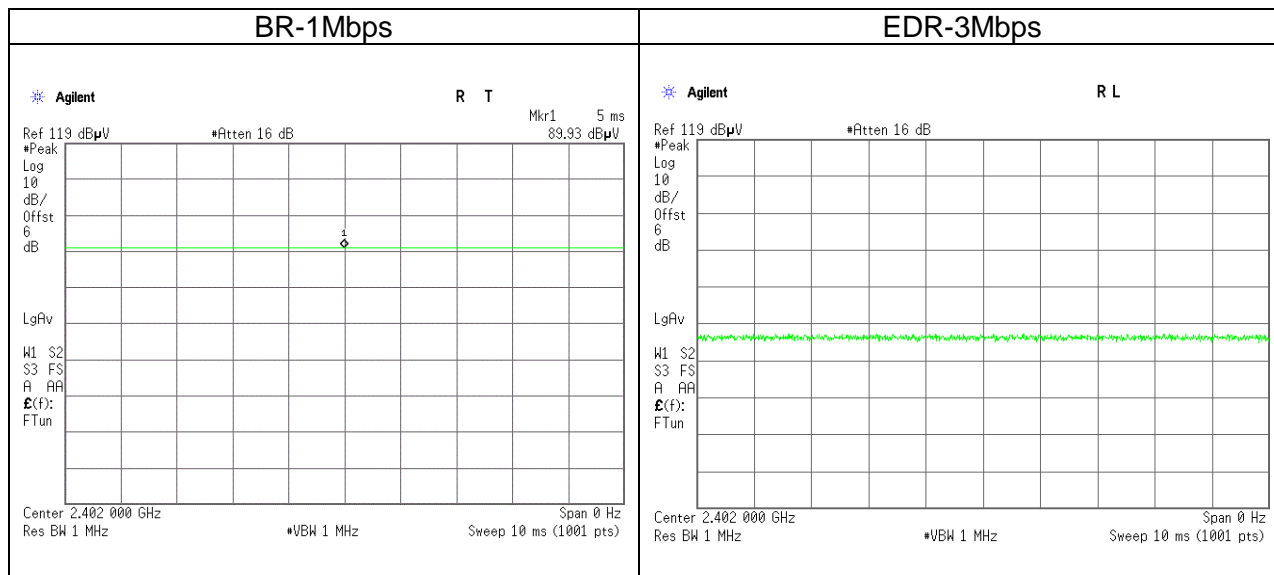

## 4. TEST RESULT

### 4.1 AC POWER LINE CONDUCTED EMISSION

#### 4.1.1 Test Limit

According to §15.207(a),

Frequency Range (MHz)	Limits(dBµV)	
	Quasi-peak	Average
0.15 to 0.50	66 to 56*	56 to 46*
0.50 to 5	56	46
5 to 30	60	50

\* Decreases with the logarithm of the frequency.

#### 4.1.2 Test Procedure

Test method Refer as ANSI 63.10:2013 clause 6.2,

1. The EUT was placed on a non-conducted table, which is 0.8m above horizontal ground plane and 0.4m above vertical ground plane.
2. EUT connected to the line impedance stabilization network (LISN)
3. Receiver set RBW of 9kHz and Detector Peak, and note as quasi-peak and average.
4. Maximum procedure was performed on the six highest emissions to ensure EUT compliance.
5. Recorded Line for Neutral and Line.

#### 4.1.3 Test Setup

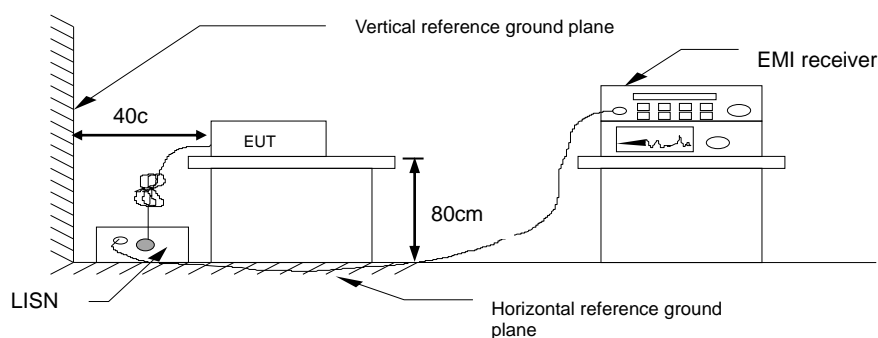

#### 4.1.4 Test Result

**Pass.**

#### **Test Data**

***Not applicable, because EUT not connect to AC Main Source direct.***

## 4.2 20DB BANDWIDTH AND OCCUPIED BANDWIDTH (99%)

### 4.2.1 Test Limit

According to §15.247(a)(1)

**20 dB Bandwidth** : For reporting purposes only.

**Occupied Bandwidth(99%)** : For reporting purposes only.

### 4.2.2 Test Procedure

Test method Refer as ANSI 63.10:2013 clause 6.9.2,

1. The EUT RF output connected to the spectrum analyzer by RF cable.
2. Setting maximum power transmit of EUT
3. SA set RBW = 30kHz, VBW = 100kHz and Detector = Peak, to measurement 20 dB Bandwidth and 99% Bandwidth.
4. Measure and record the result of 20 dB Bandwidth and 99% Bandwidth. in the test report.

### 4.2.3 Test Setup

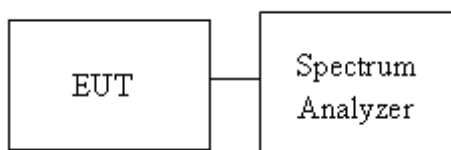

### 4.2.4 Test Result

Test mode: GFSK_BR-1Mbps mode / 2402-2480 MHz			
Channel	Frequency (MHz)	OBW (99%) (MHz)	20dB BW (MHz)
Low	2402	0.8769	0.9565
Mid	2440	0.8769	0.9565
High	2480	0.8769	0.9565

Test mode: 8DPSK_EDR-3Mbps mode / 2402-2480 MHz			
Channel	Frequency (MHz)	OBW (99%) (MHz)	20dB BW (MHz)
Low	2402	1.2243	1.3608
Mid	2440	1.2243	1.3565
High	2480	1.2373	1.4826

**Test Data**

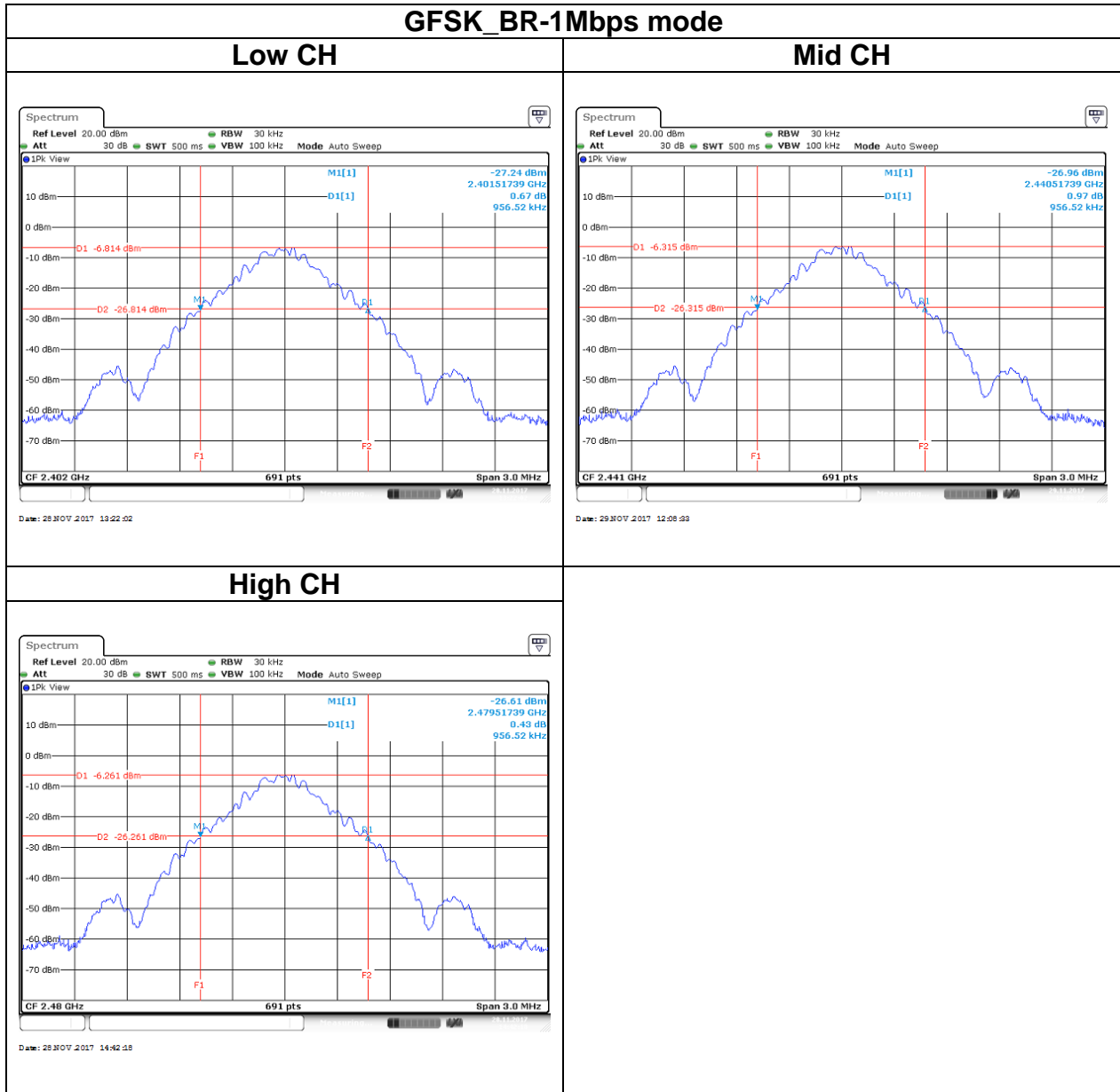



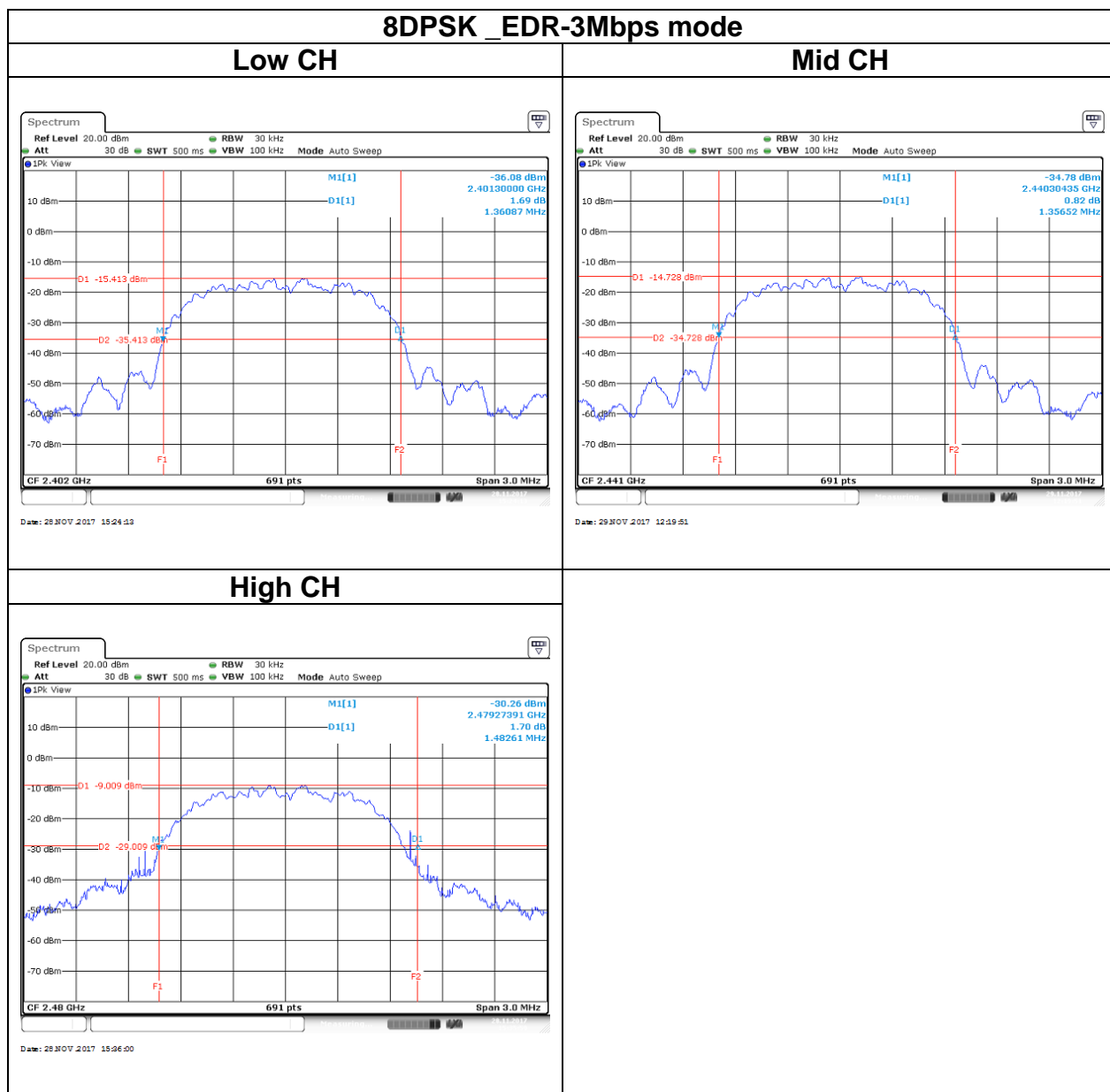

### 4.3 OUTPUT POWER MEASUREMENT

#### 4.3.1 Test Limit

According to §15.247(b)(1),

**Peak output power :**

For frequency hopping systems operating in the 2400-2483.5 MHz band employing at least 75 non-overlapping hopping channels, and all frequency hopping systems in the 5725-5850 MHz band: 1 watt. For all other frequency hopping systems in the 2400-2483.5 MHz band: 0.125 watts.

Limit	<input checked="" type="checkbox"/> Antenna not exceed 6 dBi : 21dBm <input type="checkbox"/> Antenna with DG greater than 6 dBi : [ Limit = 30 – (DG – 6)]
-------	---

**Average output power :** For reporting purposes only.

#### 4.3.2 Test Procedure

1. The EUT RF output connected to the power meter by RF cable.
2. Setting maximum power transmit of EUT.
3. The path loss was compensated to the results for each measurement.
4. Measure and record the result of Peak output power and Average output power. in the test report.

#### 4.3.3 Test Setup

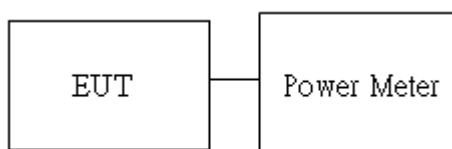

### 4.3.4 Test Result

**Peak output power :**

**For GFSK / DH5**

Channel	Frequency (MHz)	Output Power (dBm)	Output Power (W)	Limit (W)	Result
Low	2402	-2.42	<b>*0.00057</b>	0.125	PASS
Mid	2441	-2.82	0.00052		PASS
High	2480	-3.02	0.00050		PASS

**For 8DPSK / DH5**

Channel	Frequency (MHz)	Output Power (dBm)	Output Power (W)	Limit (W)	Result
Low	2402	-6.12	0.00024	0.125	PASS
Mid	2441	-6.01	<b>*0.00025</b>		PASS
High	2480	-6.98	0.00020		PASS

**Average output power :**

**For GFSK / DH5**

Channel	Frequency (MHz)	Output Power (dBm)	Output Power (W)
Low	2402	-2.68	0.00054
Mid	2441	-2.35	0.00058
High	2480	-2.30	0.00059

**For 8DPSK / DH5**

Channel	Frequency (MHz)	Output Power (dBm)	Output Power (W)
Low	2402	-9.52	0.00011
Mid	2441	-9.68	0.00011
High	2480	-10.16	0.00010

## 4.4 FREQUENCY SEPARATION

### 4.4.1 Test Limit

According to §15.247(a)(1)

Frequency hopping systems shall have hopping channel carrier frequencies separated by a minimum of 25 kHz or the 20 dB bandwidth of the hopping channel, whichever is greater.

Alternatively, frequency hopping systems operating in the 2400-2483.5 MHz band may have hopping channel carrier frequencies that are separated by 25 kHz or two-thirds of the 20 dB bandwidth of the hopping channel, whichever is greater, provided the systems operate with an output power no greater than 125 mW.

Limit	> two-thirds of the 20 dB bandwidth
-------	-------------------------------------

### 4.4.2 Test Procedure

1. Place the EUT on the table and set it in transmitting mode.
2. EUT RF output port connected to the SA by RF cable.
3. Set the spectrum analyzer as RBW = 100kHz, VBW = 300kHz, Sweep = auto.  
Max hold, mark 3 peaks of hopping channel and record the 3 peaks frequency

### 4.4.3 Test Setup

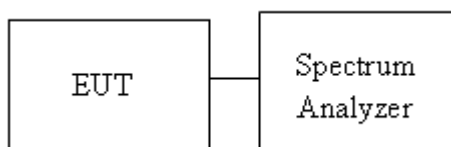

### 4.4.4 Test Result

Test mode: GFSK_BR-1Mbps mode / 2402-2480 MHz				
Channel	Frequency (MHz)	Channel Separation (MHz)	Channel Separation Limits (MHz)	Result
Low	2402	0.9986	0.638	PASS
Mid	2441	0.9986	0.638	PASS
High	2480	0.9986	0.638	PASS

Test mode: 8DPSK_EDR-3Mbps mode / 2402-2480 MHz				
Channel	Frequency (MHz)	Channel Separation (MHz)	Channel Separation Limits (MHz)	Result
Low	2402	0.9986	0.907	PASS
Mid	2441	0.9986	0.904	PASS
High	2480	0.9986	0.988	PASS

## Test Data

### GFSK\_BR-1Mbps mode

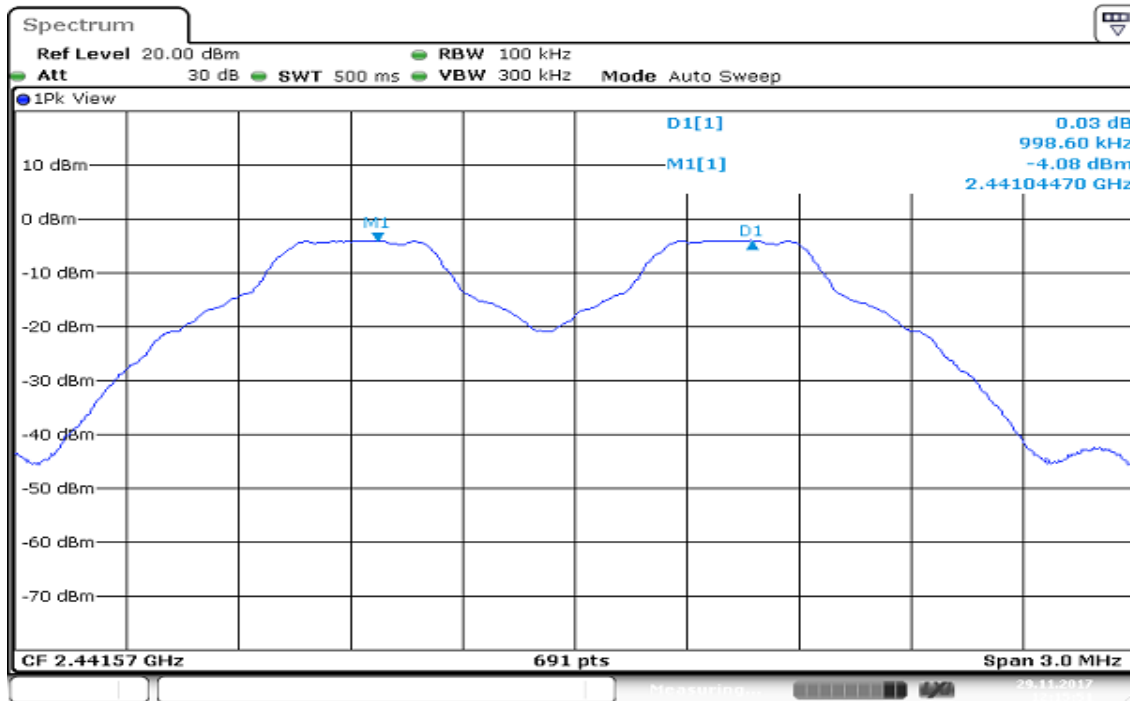

### 8DPSK\_EDR-3Mbps mode

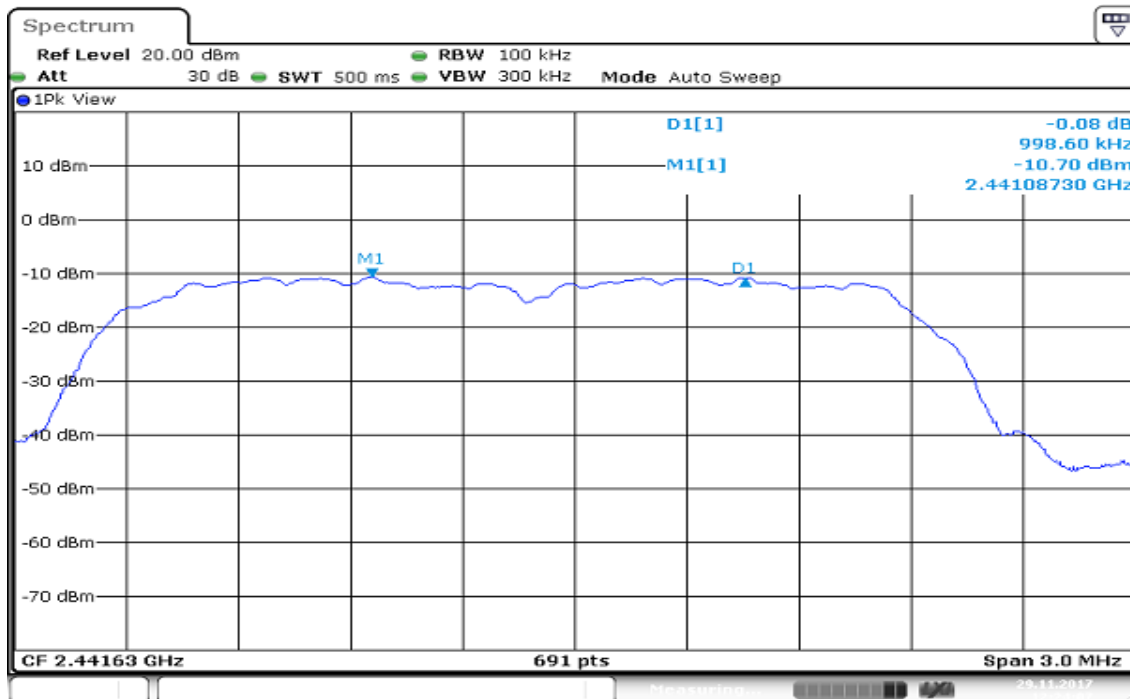

## 4.5 NUMBER OF HOPPING

### 4.5.1 Test Limit

According to §15.247(a)(1)(iii),

For frequency hopping systems operating in the 2400-2483.5 MHz band employing at least 75 non-overlapping hopping channels

### 4.5.2 Test Procedure

Test method Refer as ANSI 63.10:2013 clause 7.8.3,

1. Place the EUT on the table and set it in transmitting mode.
2. EUT RF output port connected to the SA by RF cable.
3. Set spectrum analyzer Start Freq. = 2400 MHz, Stop Freq. = 2483.5 MHz, RBW=100KHz, VBW = 300KHz.Sweep Time = 1s
4. Max hold, view and count how many channel in the band.

### 4.5.3 Test Setup

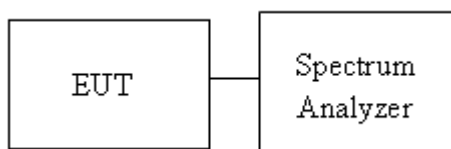

### 4.5.4 Test Result

Number of Hopping				
Mode	Frequency (MHz)	Hopping Channel Number	Hopping Channel Number Limits	Result
BR-1Mbps	2402-2480	79	15	Pass
EDR-3Mbps	2402-2480	79	15	

**REMARK:**

*The frequency spectrum was broken up in to two sub-range to clearly show all of the hopping frequencies. In the AFH mode, this device operation was using 20 channels, so the requirement for minimum number of hopping channels is satisfied*

**Test Data**

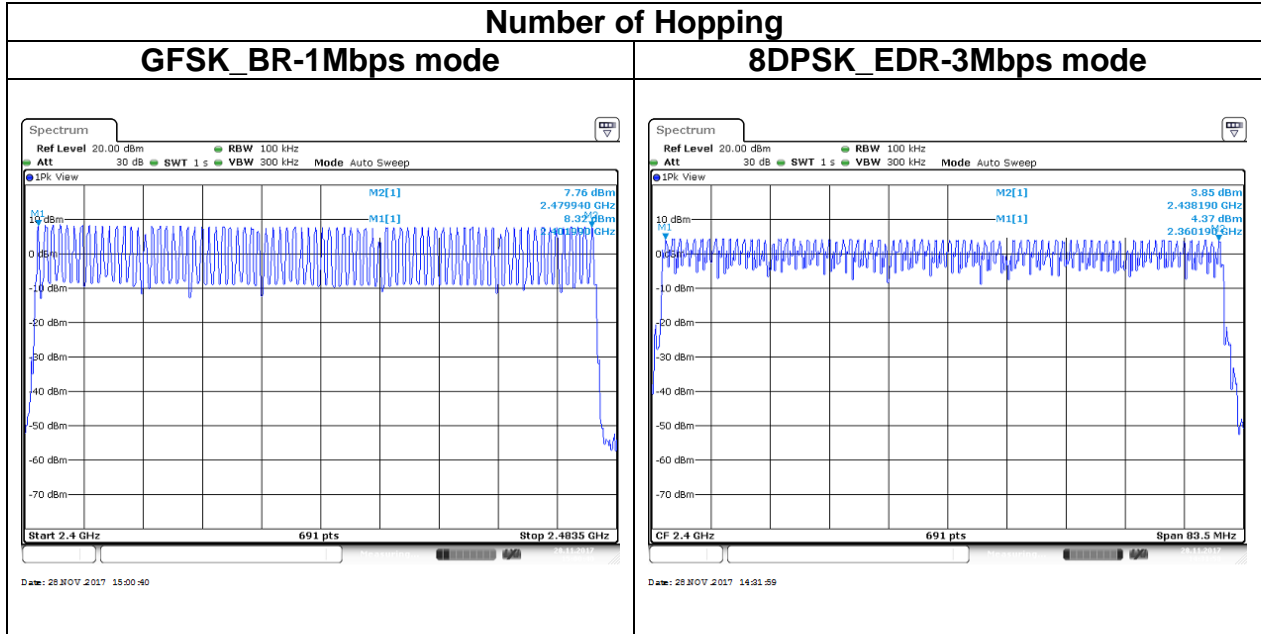

## 4.6 CONDUCTED BANDEDGE AND SPURIOUS EMISSION

### 4.6.1 Test Limit

According to §15.247(d),

Limit	-20 dBc
-------	---------

### 4.6.2 Test Procedure

1. EUT RF output port connected to the SA by RF cable, and the path loss was compensated to result.
2. SA setting, RBW=100kHz, VBW=300kHz, Detector=Peak, Trace mode = max hold, SWT = Auto.
3. The Band Edge at 2.4GHz and 2.4835GHz are investigated with normal hopping mode.

### 4.6.3 Test Setup

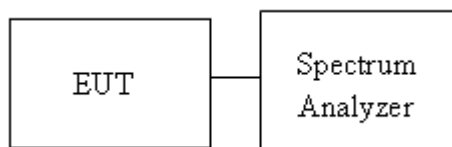



### 4.6.4 Test Result

#### Test Data

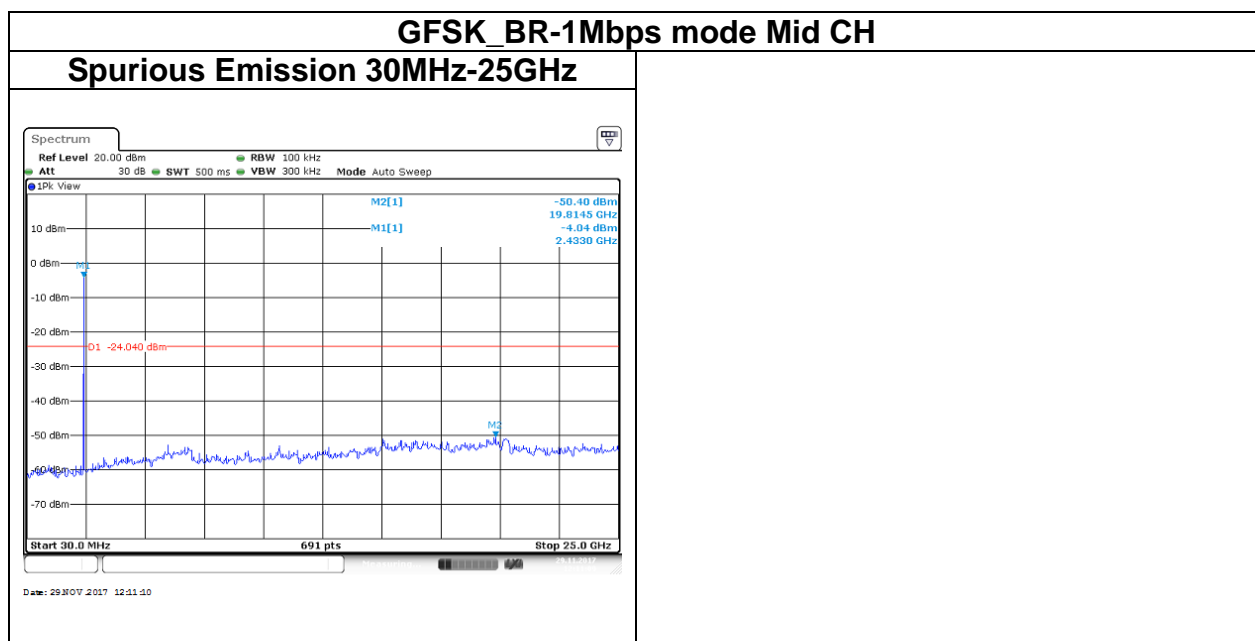
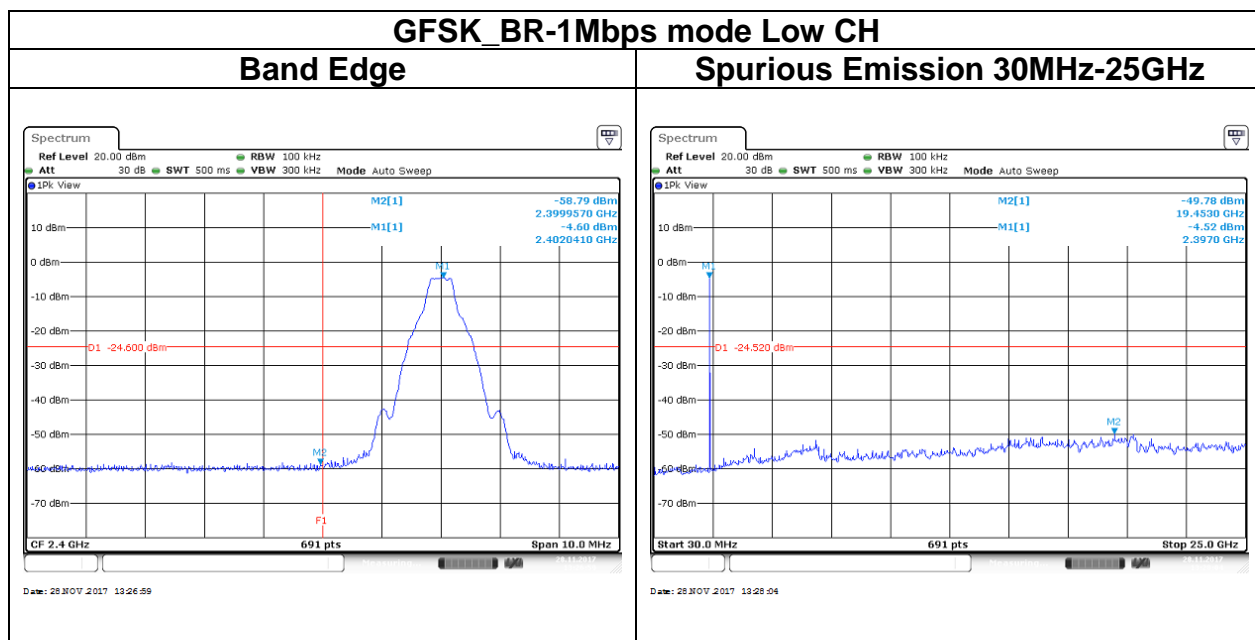

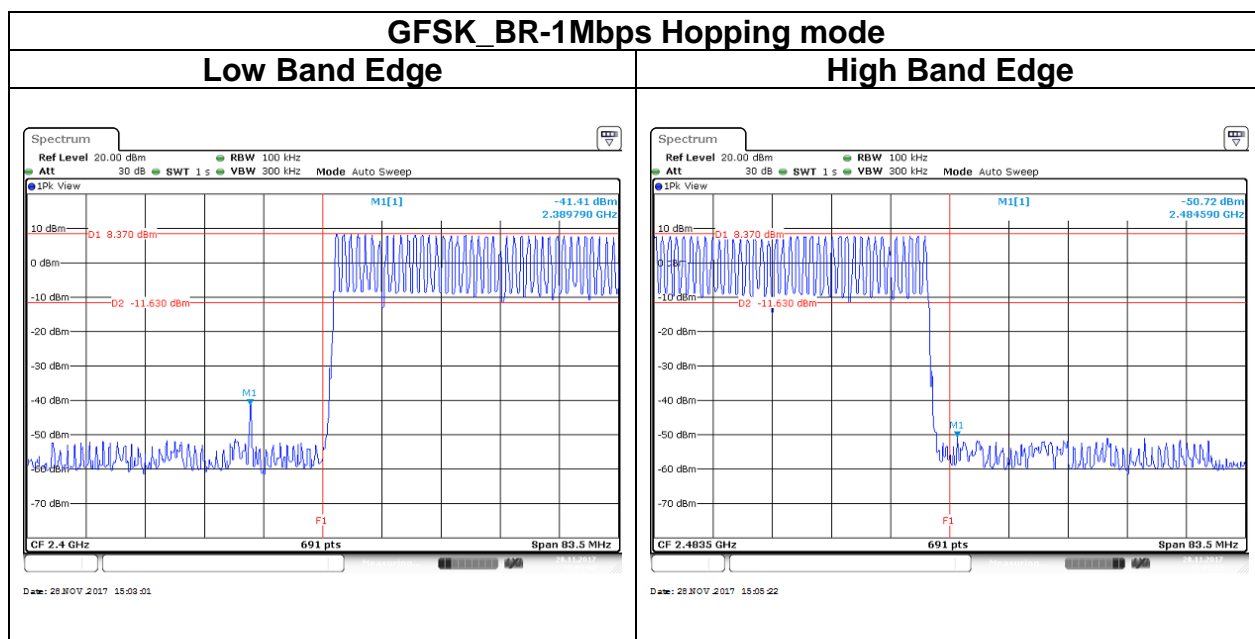
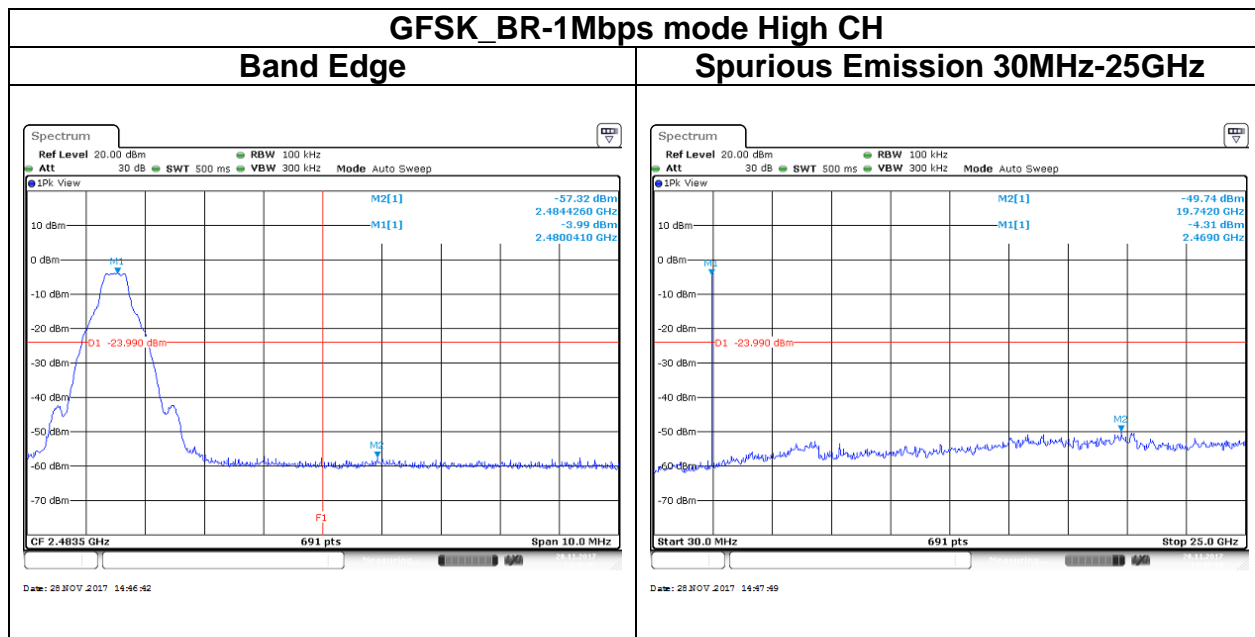

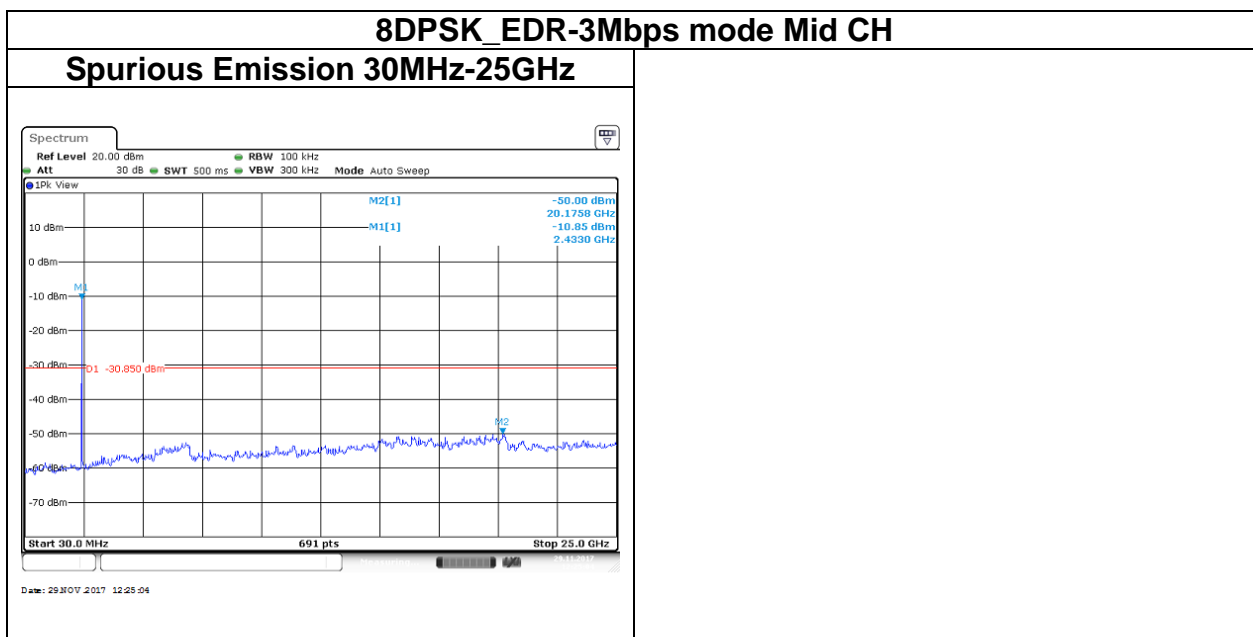
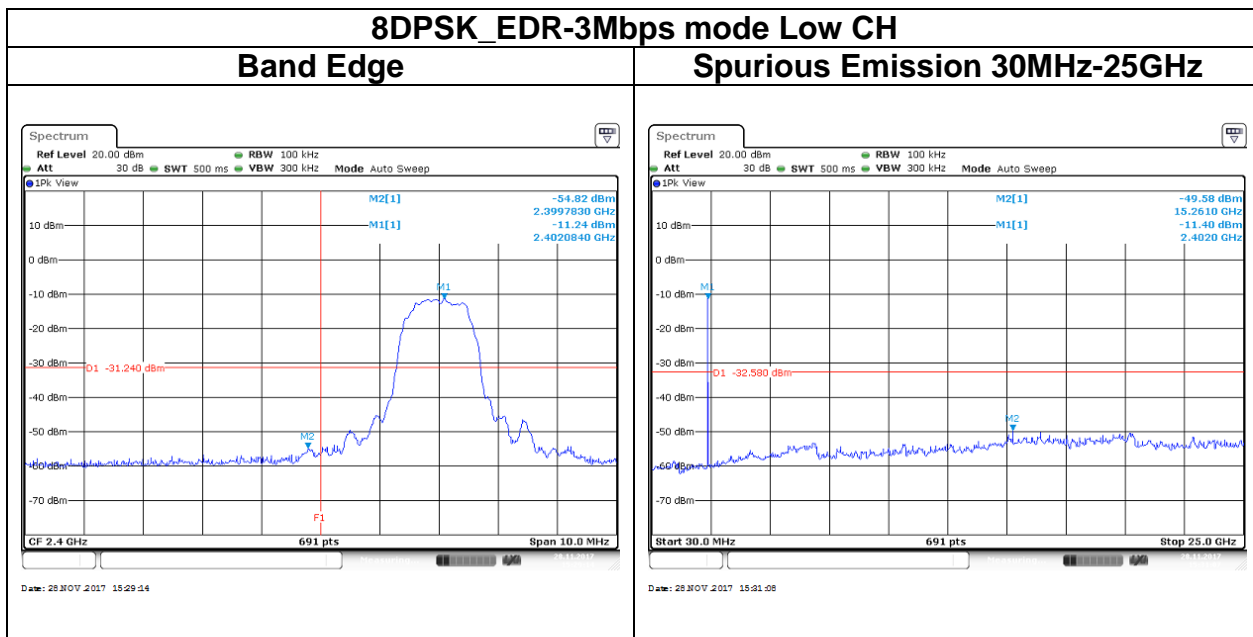

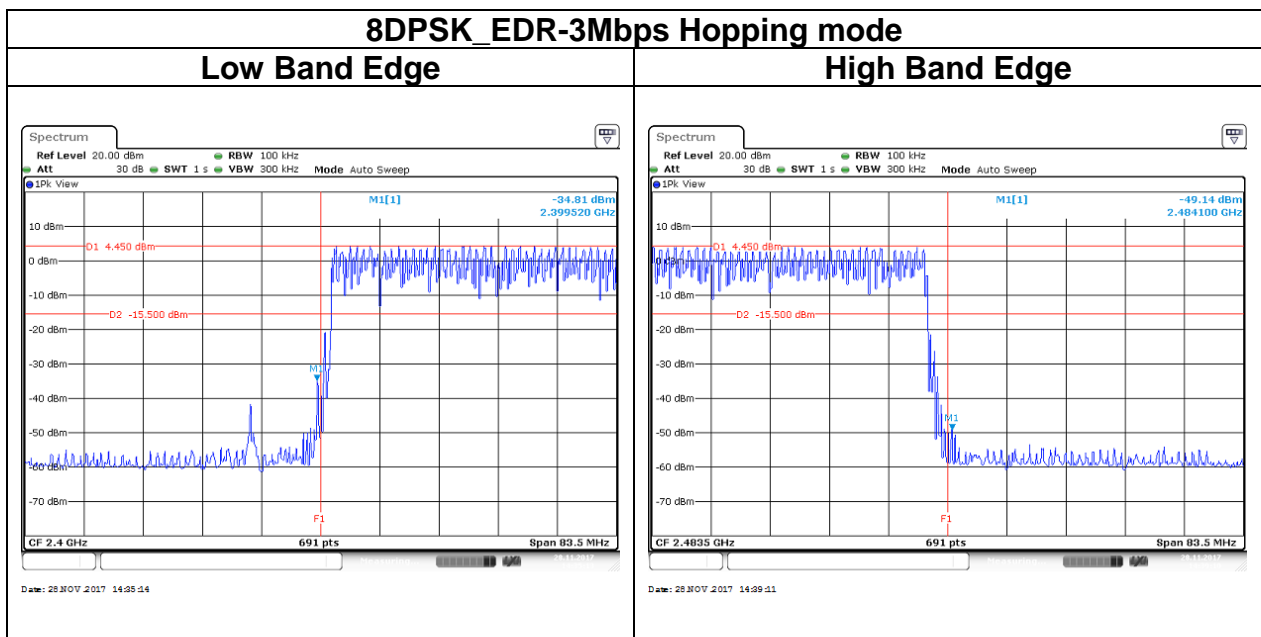
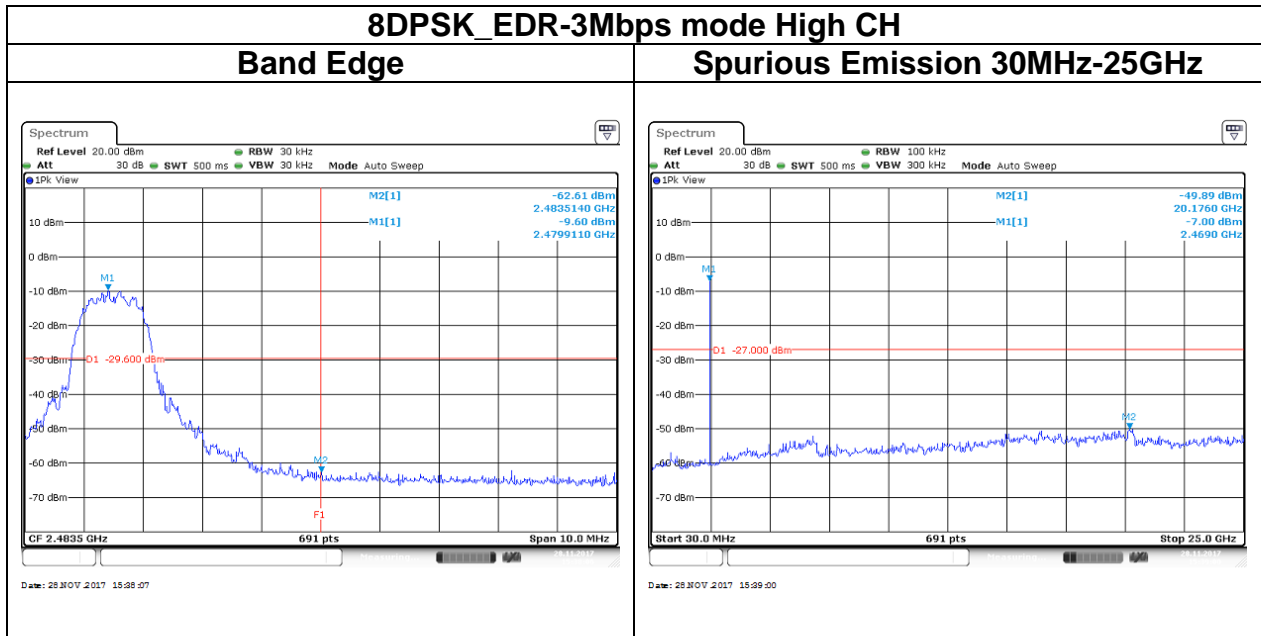

## 4.7 TIME OF OCCUPANCY (DWELL TIME)

### 4.7.1 Test Limit

According to §15.247(a)(1)(iii),

The average time of occupancy on any channel shall not be greater than 0.4 seconds within a period of 0.4 seconds multiplied by the number of hopping channels employed.

### 4.7.2 Test Procedure

1. EUT RF output port connected to the SA by RF cable.
2. Set center frequency of spectrum analyzer = operating frequency.
3. Set the spectrum analyzer as RBW, VBW=1MHz, Sweep = 1 ms

### 4.7.3 Test Setup

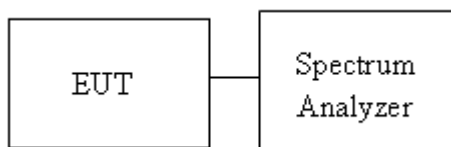

### 4.7.4 Test Result

Time of Occupancy (Dwell Time)							
Mode	Frequency (MHz)	Pulse Time Per Hopping (ms)	Minimum Number of Hopping Freq.	Number of pulse in	Dwell Time IN	Dwell Time Limits (s)	Result
				(0.4 * N sec)	(0.4 * N sec)		
BR-1Mbps	2441	0.4493	79	106.67	0.0479	0.4	Pass
EDR-3Mbps	2441	0.3188	79	106.67	0.0340	0.4	
Non-AFH: DH5 Packet permit maximum 1600/ 79 / 6 = 3.37 hops per second in each channel (5 time slots RX, 1 time slot TX). So, the dwell time is the time duration of the pulse times 3.37 * 0.4 *79 = 106.6							
AFH: DH5 Packet permit maximum 800/ 20 / 6 = 6.666 hops per second in each channel (5 time slots RX, 1 time slot TX). So, the dwell time is the time duration of the pulse times 6.666*0.4*20 = 53.33							

**Test Data**

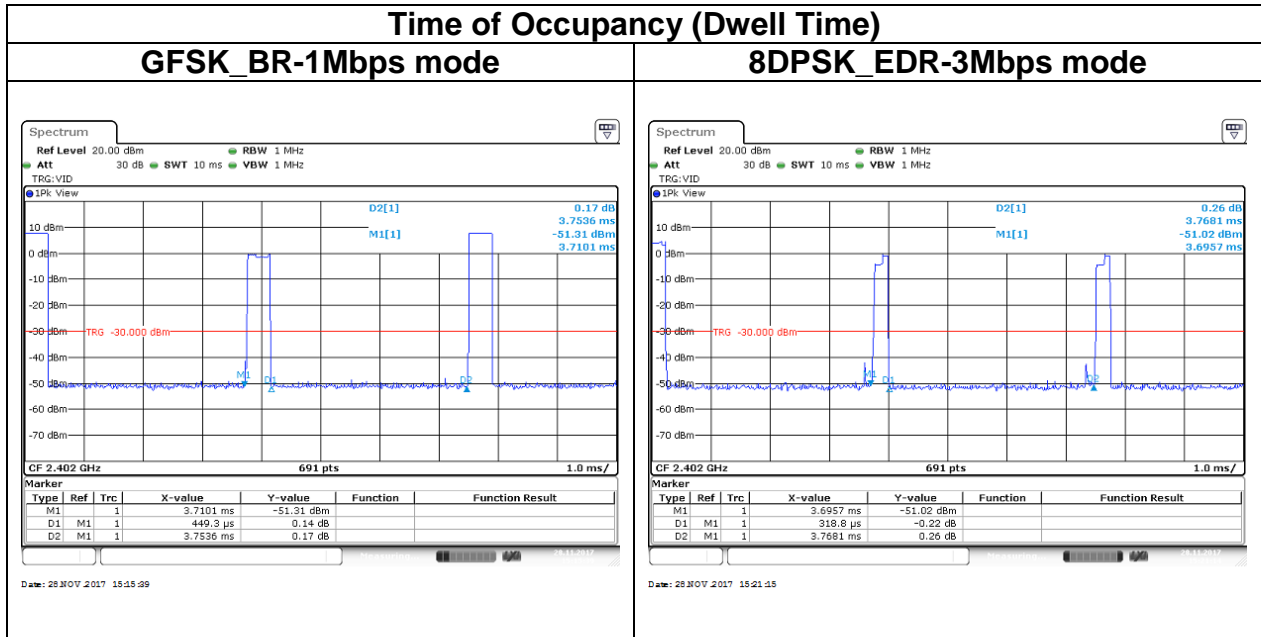

## 4.8 RADIATION BANDEGE AND SPURIOUS EMISSION

### 4.8.1 Test Limit

According to §15.247(d), §15.209 and §15.205,

In any 100 kHz bandwidth outside the authorized frequency band, all harmonic and spurious must be least 20 dB below the highest emission level with the authorized frequency band. Radiation emission which fall in the restricted bands must also follow the FCC section 15.209 as below limit in table.

#### Below 30 MHz

Frequency	Field Strength (microvolts/m)	Magnetic H-Field (microamperes/m)	Measurement Distance (metres)
9-490 kHz	2,400/F (F in kHz)	2,400/F (F in kHz)	300
490-1,705 kHz	24,000/F (F in kHz)	24,000/F (F in kHz)	30
1.705-30 MHz	30	N/A	30

#### Above 30 MHz

Frequency (MHz)	Field Strength microvolts/m at 3 metres (watts, e.i.r.p.)	
	Transmitters	Receivers
30-88	100 (3 nW)	100 (3 nW)
88-216	150 (6.8 nW)	150 (6.8 nW)
216-960	200 (12 nW)	200 (12 nW)
Above 960	500 (75 nW)	500 (75 nW)

### 4.8.2 Test Procedure

Test method Refer as ANSI C63.10:2013.

1. The EUT is placed on a turntable, Above 1 GHz is 1.5m and below 1 GHz is 0.8m above ground plane. The EUT Configured un accordance with ANSI C63.10, and the EUT set in a continuous mode.
2. The turntable shall be rotated for 360 degrees to determine the position of maximum emission level. And EUT is set 3m away from the receiving antenna, which is scanned from 1m to 4m above the ground plane to find out the highest emissions. Measurement are made polarized in both the vertical and the horizontal positions with antenna.
3. Span shall wide enough to full capture the emission measured. The SA from 30MHz to 26.5GHz set to the low, Mid and High channels with the EUT transmit.
4. For harmonic, the worst case of output power was BR-1Mbps. Therefore only BR-1Mbps record in the report.
5. The SA setting following :
  - (1) Below 1G : RBW = 100kHz, VBW  $\geq$  3 RBW, Sweep = Auto, Detector = Peak, Trace = Max hold.
  - (2) Above 1G :
    - (2.1) For Peak measurement : RBW = 1MHz, VBW  $\geq$  3 RBW, Sweep = Auto, Detector = Peak, Trace = Max hold.
    - (2.2) For Average measurement : RBW = 1MHz, VBW
      - If Duty Cycle  $\geq$  98%, VBW=10Hz.
      - If Duty Cycle < 98%, VBW=1/T.

Configuration	Duty Cycle (%)	VBW
GFSK_BR-1Mbps	100%	10 Hz
8DPSK_EDR-3Mbps	100%	10 Hz



### 4.8.3 Test Setup

#### 9kHz ~ 30MHz

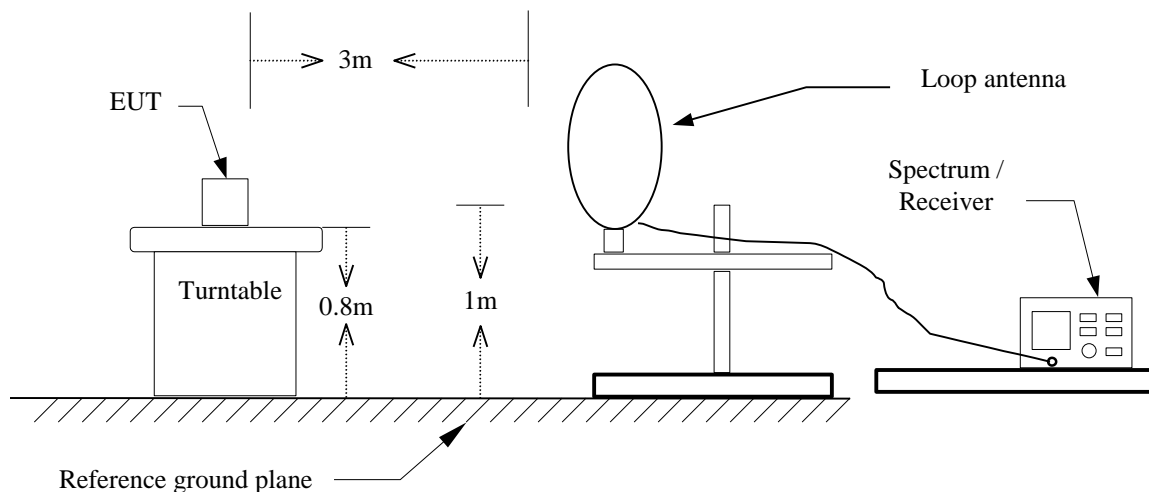

#### 30MHz ~ 1GHz

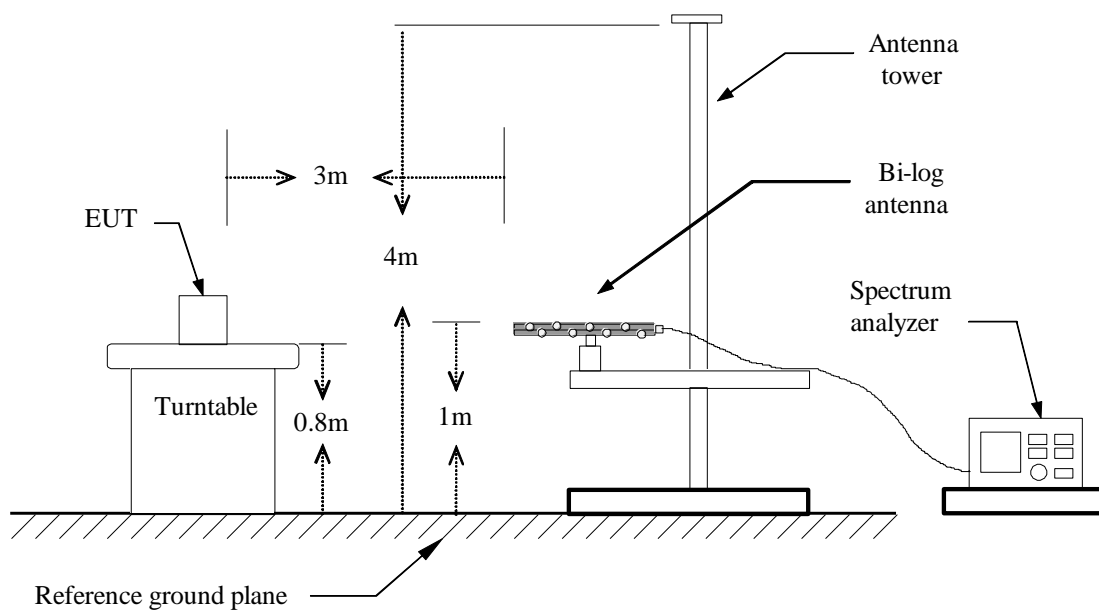

**Above 1 GHz**

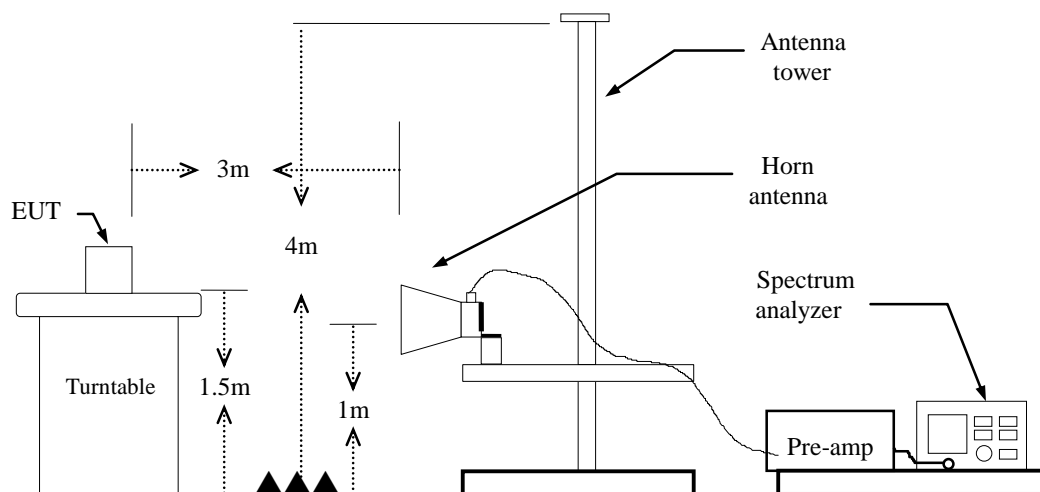

### 4.8.4 Test Result

#### Band Edge Test Data

Test Mode	GFSK_BR-1Mbps Low CH	Temp/Hum	24(°C)/ 33%RH
Test Item	Band Edge	Test Date	November 30, 2017
Polarize	Vertical	Test Engineer	Jerry Chuang
Detector	Peak	Test Voltage	DC 5V

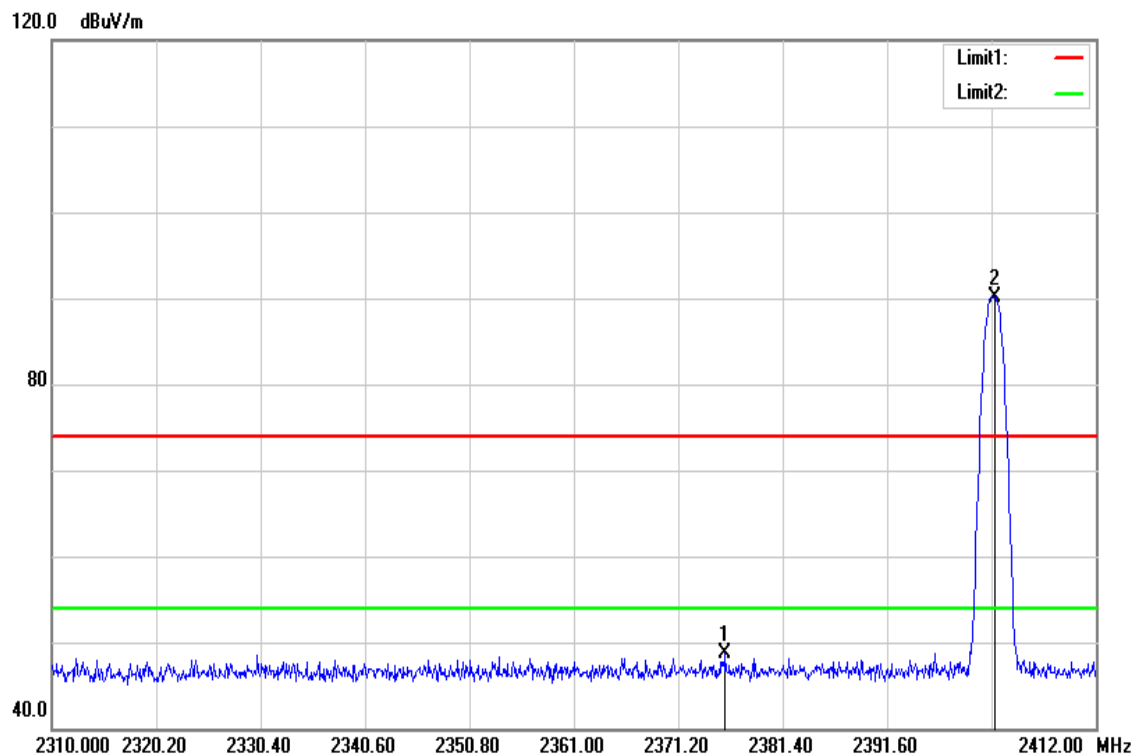

Frequency (MHz)	Reading (dBuV)	Correct Factor(dB/m)	Result (dBuV/m)	Limit (dBuV/m)	Margin (dB)	Remark
2375.790	51.76	-3.02	48.74	74.00	-25.26	peak
2402.106	93.05	-2.95	90.10	-	-	peak

Test Mode	GFSK_BR-1Mbps Low CH	Temp/Hum	24(°C)/ 33%RH
Test Item	Band Edge	Test Date	November 30, 2017
Polarize	Vertical	Test Engineer	Jerry Chuang
Detector	Average	Test Voltage	DC 5V

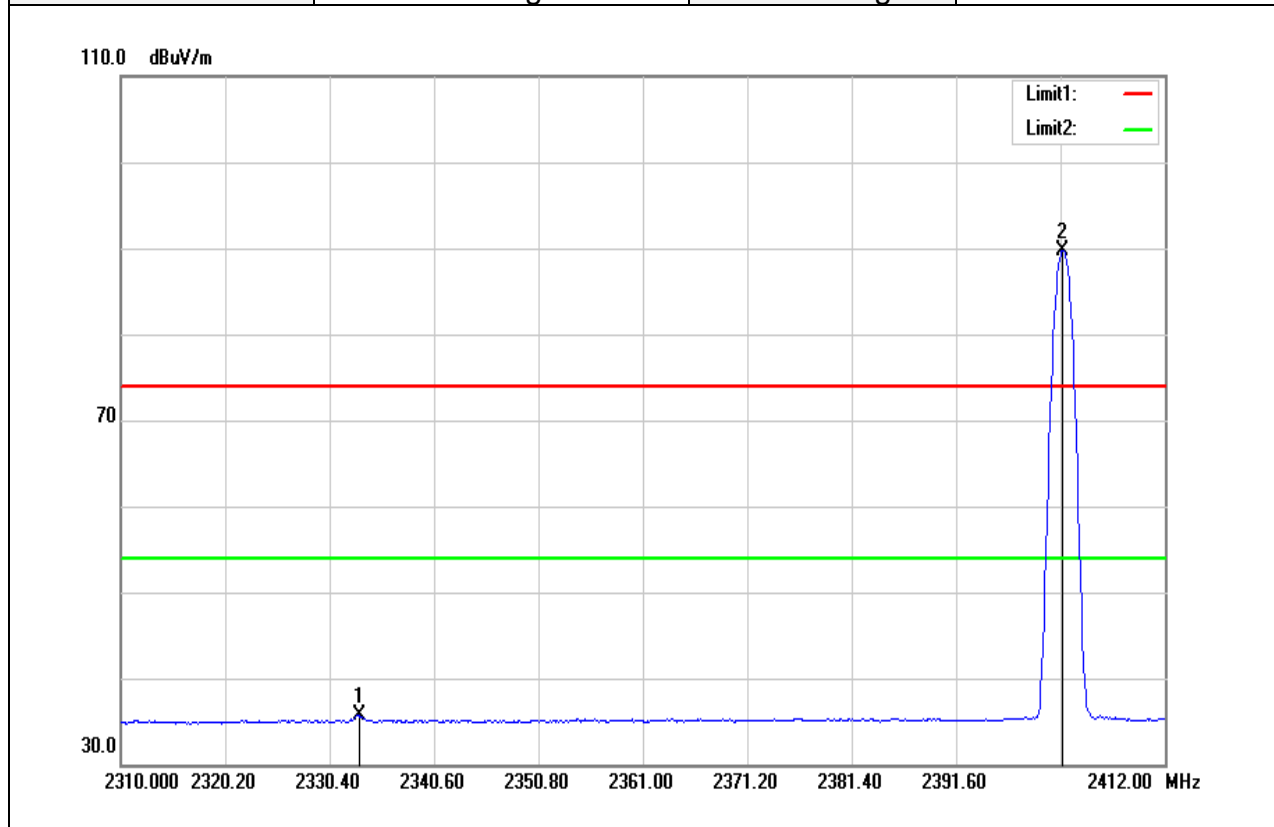

Frequency (MHz)	Reading (dBuV)	Correct Factor(dB/m)	Result (dBuV/m)	Limit (dBuV/m)	Margin (dB)	Remark
2333.256	38.80	-3.16	35.64	54.00	-18.36	AVG
2402.004	92.71	-2.95	89.76	-	-	AVG

Test Mode	GFSK_BR-1Mbps High CH	Temp/Hum	24(°C)/ 33%RH
Test Item	Band Edge	Test Date	December 1, 2017
Polarize	Vertical	Test Engineer	Jerry Chuang
Detector	Peak	Test Voltage	DC 5V

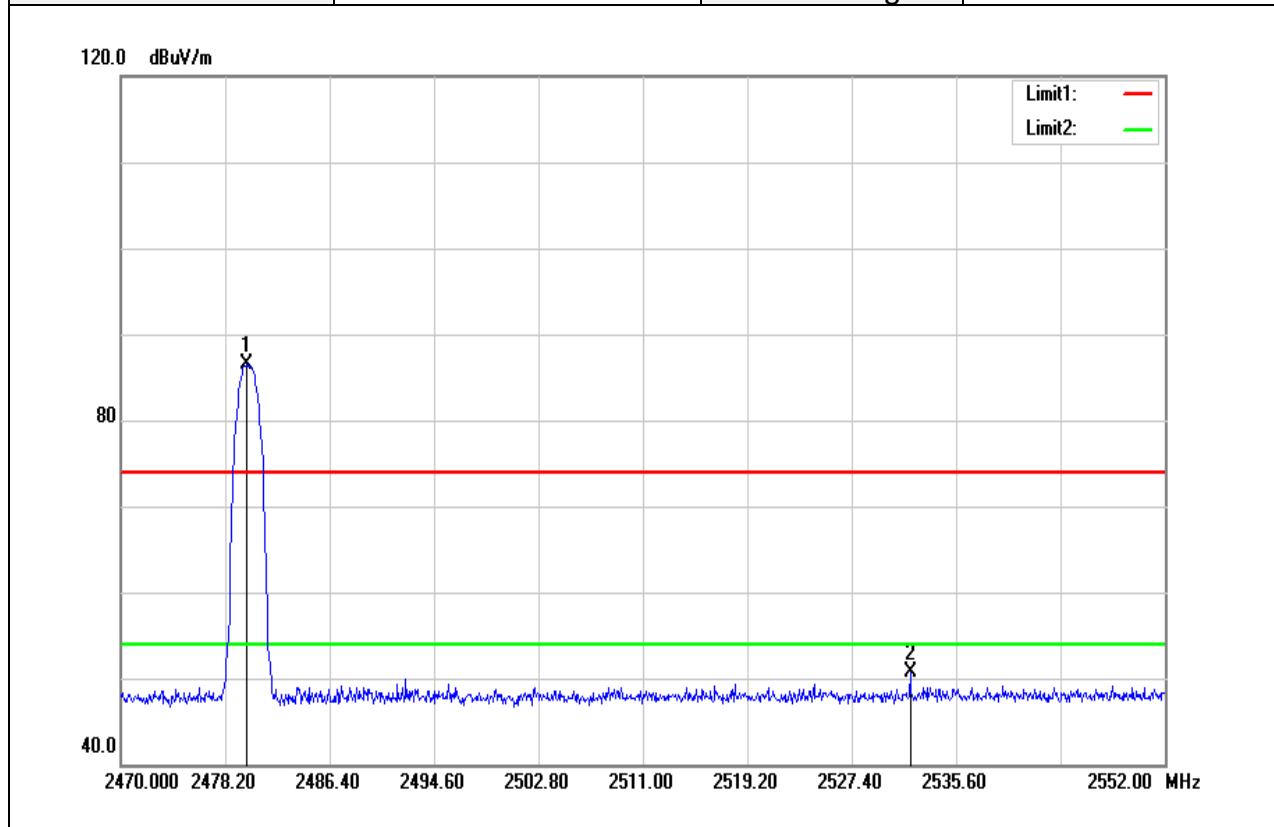

Frequency (MHz)	Reading (dBuV)	Correct Factor(dB/m)	Result (dBuV/m)	Limit (dBuV/m)	Margin (dB)	Remark
2479.840	89.10	-2.70	86.40	-	-	peak
2531.992	53.24	-2.57	50.67	74.00	-23.33	peak

Test Mode	GFSK_BR-1Mbps High CH	Temp/Hum	24(°C)/ 33%RH
Test Item	Band Edge	Test Date	December 1, 2017
Polarize	Vertical	Test Engineer	Jerry Chuang
Detector	Average	Test Voltage	DC 5V

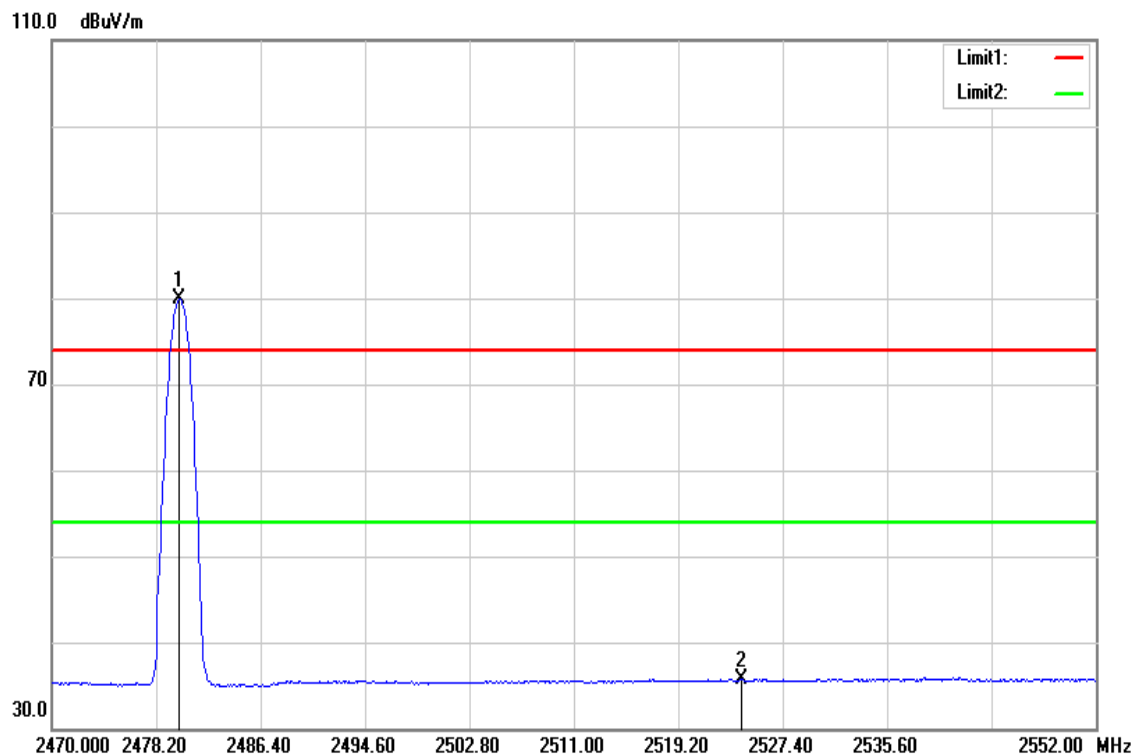

Frequency (MHz)	Reading (dBuV)	Correct Factor(dB/m)	Result (dBuV/m)	Limit (dBuV/m)	Margin (dB)	Remark
2480.004	82.52	-2.70	79.82	-	-	AVG
2524.202	38.35	-2.59	35.76	54.00	-18.24	AVG

Test Mode	8DPSK_EDR-3Mbps Low CH	Temp/Hum	24(°C)/ 33%RH
Test Item	Band Edge	Test Date	December 1, 2017
Polarize	Vertical	Test Engineer	Jerry Chuang
Detector	Peak	Test Voltage	DC 5V

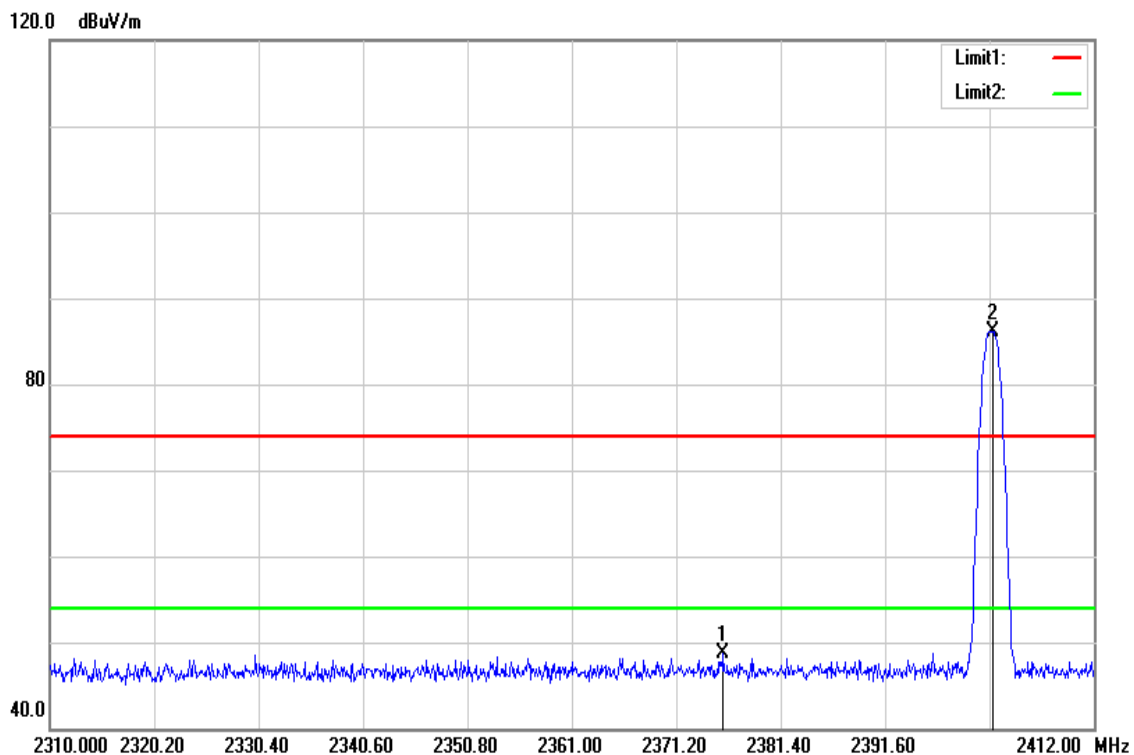

Frequency (MHz)	Reading (dBuV)	Correct Factor(dB/m)	Result (dBuV/m)	Limit (dBuV/m)	Margin (dB)	Remark
2375.790	51.76	-3.02	48.74	74.00	-25.26	peak
2402.106	89.05	-2.95	86.10	-	-	peak

Test Mode	8DPSK_EDR-3Mbps Low CH	Temp/Hum	24(°C)/ 33%RH
Test Item	Band Edge	Test Date	December 1, 2017
Polarize	Vertical	Test Engineer	Jerry Chuang
Detector	Average	Test Voltage	DC 5V

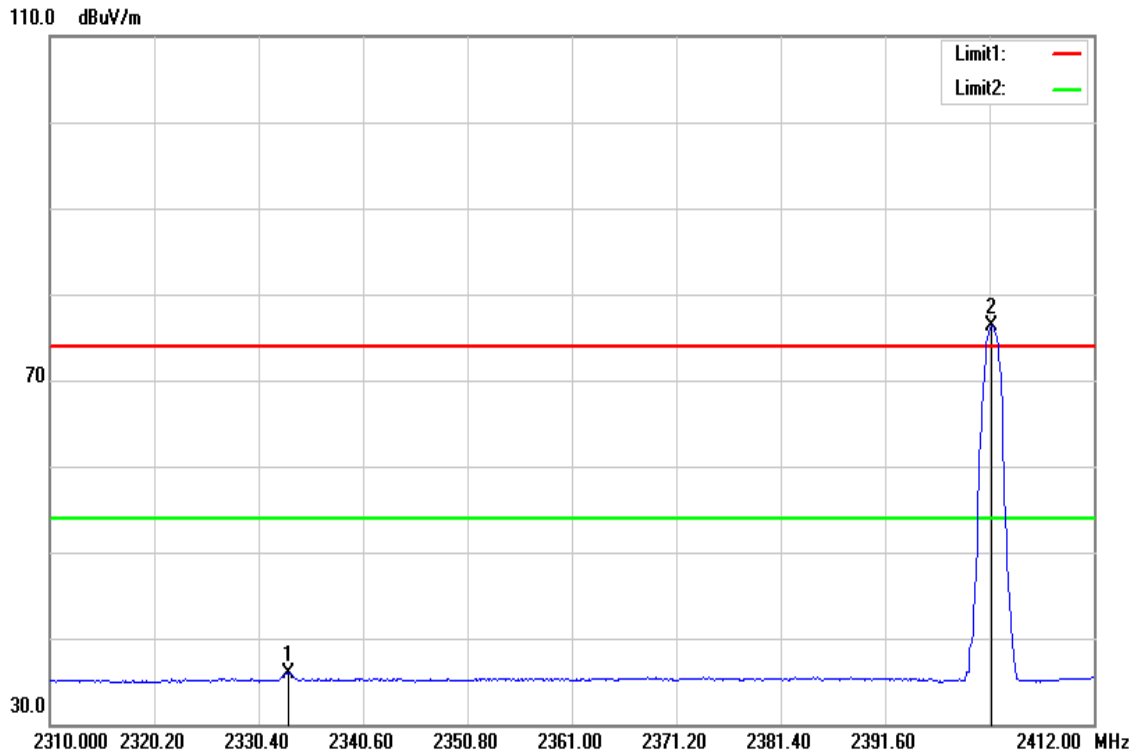

Frequency (MHz)	Reading (dBuV)	Correct Factor(dB/m)	Result (dBuV/m)	Limit (dBuV/m)	Margin (dB)	Remark
2333.358	39.08	-3.16	35.92	54.00	-18.08	AVG
2402.004	79.24	-2.95	76.29	-	-	AVG



Test Mode	8DPSK_EDR-3Mbps High CH	Temp/Hum	24(°C)/ 33%RH
Test Item	Band Edge	Test Date	December 1, 2017
Polarize	Vertical	Test Engineer	Jerry Chuang
Detector	Peak	Test Voltage	DC 5V

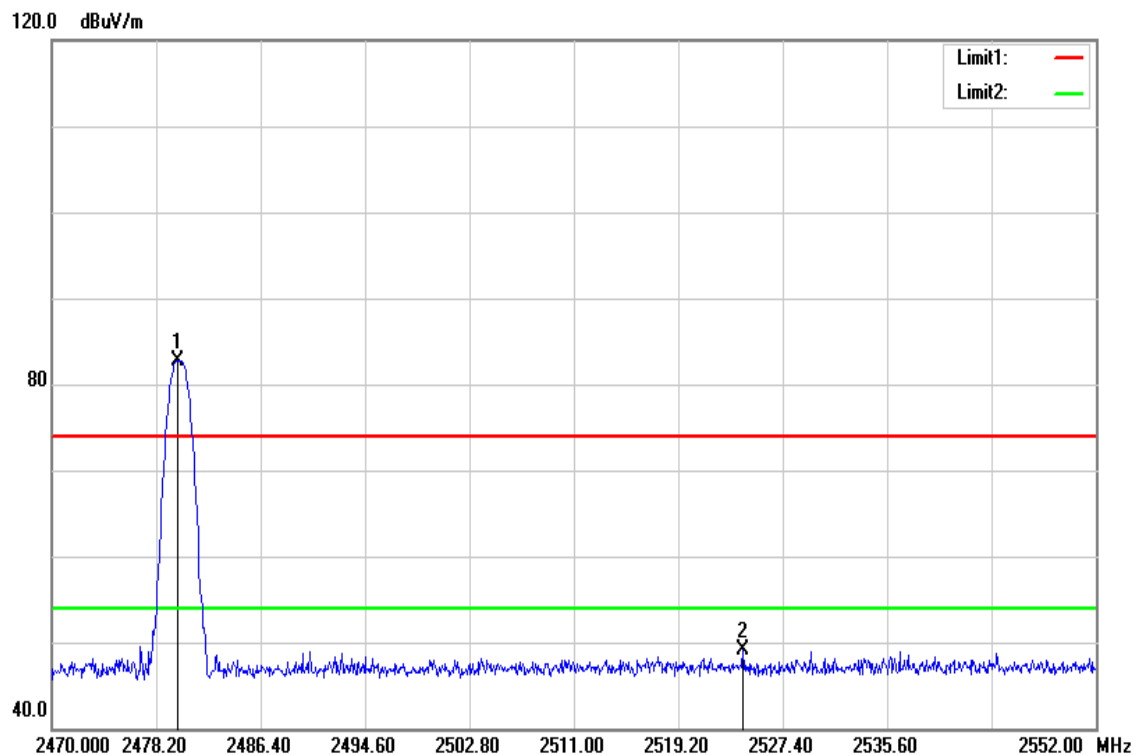

Frequency (MHz)	Reading (dBuV)	Correct Factor(dB/m)	Result (dBuV/m)	Limit (dBuV/m)	Margin (dB)	Remark
2479.840	85.44	-2.70	82.74	-	-	peak
2524.284	51.62	-2.59	49.03	74.00	-24.97	peak

Test Mode	8DPSK_EDR-3Mbps High CH	Temp/Hum	24(°C)/ 33%RH
Test Item	Band Edge	Test Date	December 1, 2017
Polarize	Vertical	Test Engineer	Jerry Chuang
Detector	Average	Test Voltage	DC 5V

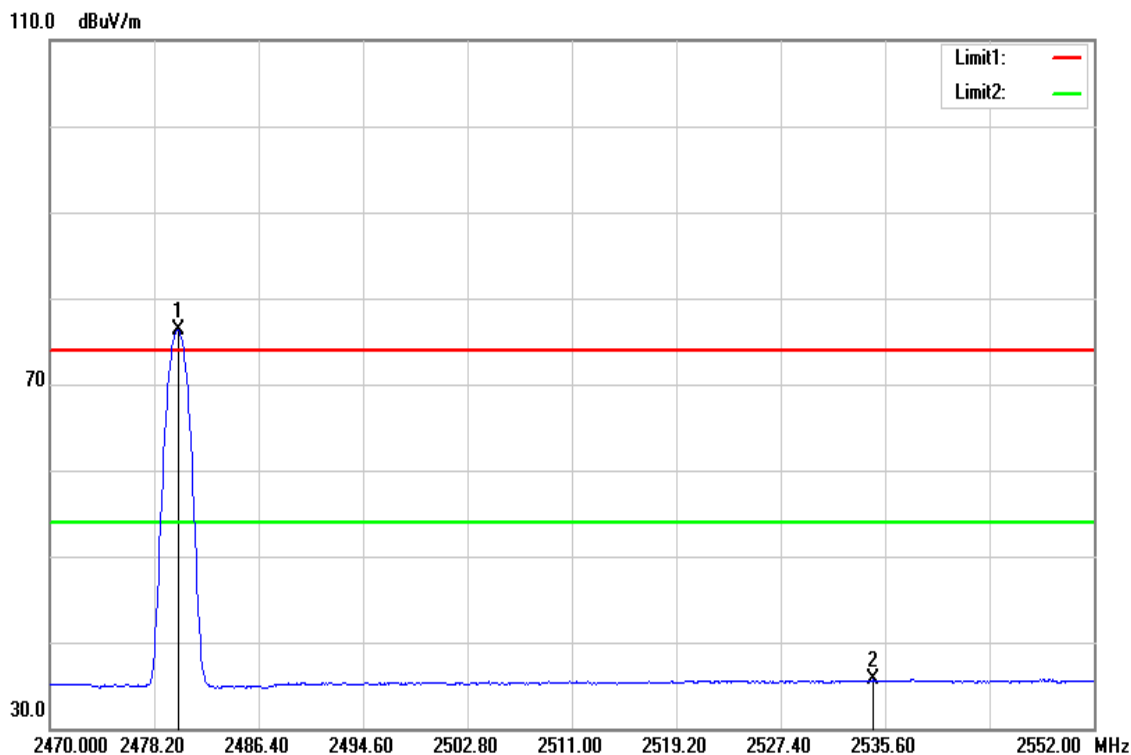

Frequency (MHz)	Reading (dBuV)	Correct Factor(dB/m)	Result (dBuV/m)	Limit (dBuV/m)	Margin (dB)	Remark
2480.086	78.97	-2.70	76.27	-	-	AVG
2534.698	38.18	-2.56	35.62	54.00	-18.38	AVG

**Below 1G Test Data**

Test Mode	Mode 1	Temp/Hum	24(°C)/ 33%RH
Test Item	30MHz-1GHz	Test Date	December 1, 2017
Polarize	Vertical	Test Engineer	Jerry Chuang
Detector	Peak	Test Voltage	DC 5V

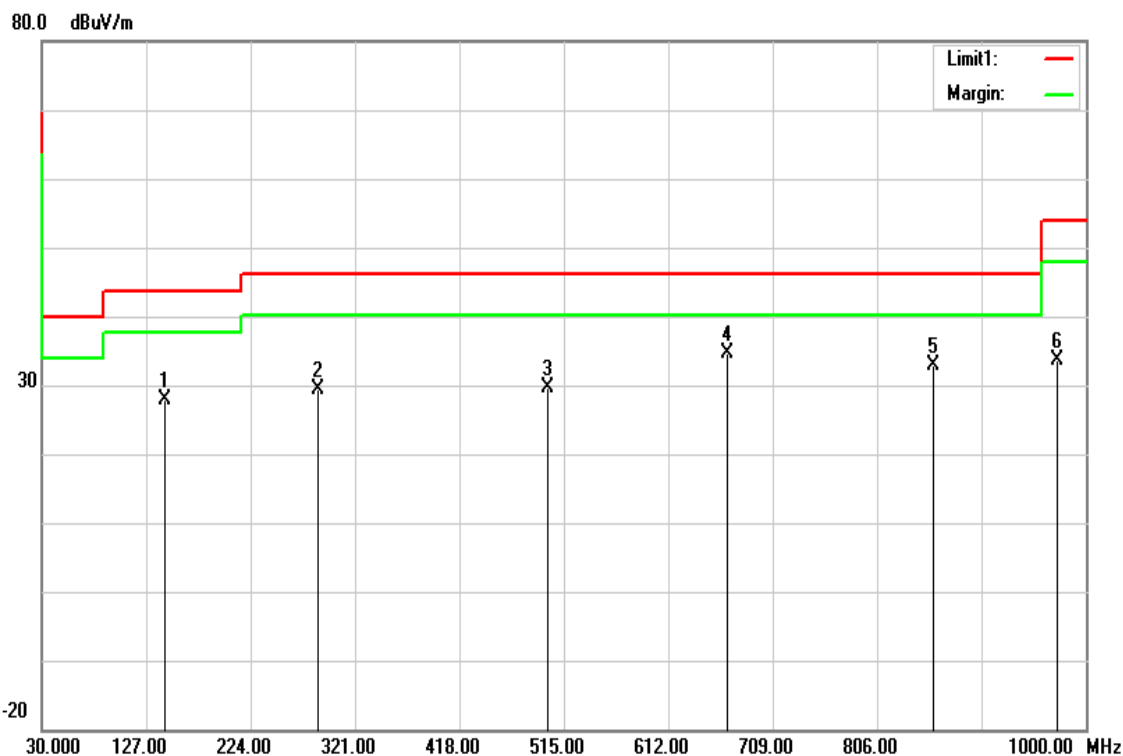

Frequency (MHz)	Reading (dBuV)	Correct Factor(dB/m)	Result (dBuV/m)	Limit (dBuV/m)	Margin (dB)	Remark
144.4600	43.63	-15.63	28.00	43.52	-15.52	peak
286.0800	43.53	-14.21	29.32	46.02	-16.70	peak
500.4500	38.12	-8.48	29.64	46.02	-16.38	peak
666.3200	39.90	-5.34	34.56	46.02	-11.46	peak
858.3800	35.71	-2.71	33.00	46.02	-13.02	peak
973.8100	34.54	-0.93	33.61	54.00	-20.39	peak

Note: No emission found between lowest internal used/generated frequency to 30MHz(9KHz~30MHz)

Test Mode	Mode 1	Temp/Hum	24(°C)/ 33%RH
Test Item	30MHz-1GHz	Test Date	December 1, 2017
Polarize	Horizontal	Test Engineer	Jerry Chuang
Detector	Peak	Test Voltage	DC 5V

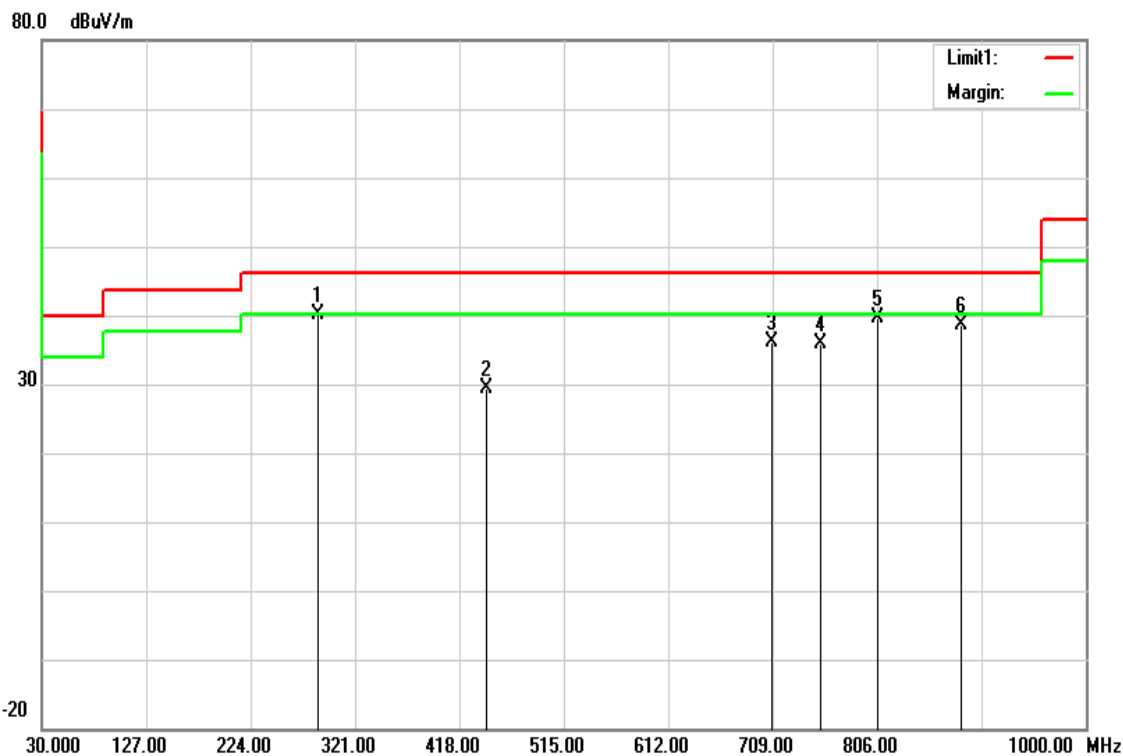

Frequency (MHz)	Reading (dBuV)	Correct Factor(dB/m)	Result (dBuV/m)	Limit (dBuV/m)	Margin (dB)	Remark
286.0800	54.35	-14.21	40.14	46.02	-5.88	peak
443.2200	39.15	-9.84	29.31	46.02	-16.71	peak
708.0300	40.83	-4.80	36.03	46.02	-9.99	peak
753.6200	40.11	-4.23	35.88	46.02	-10.14	peak
806.0000	42.90	-3.31	39.59	46.02	-6.43	peak
883.6000	40.87	-2.29	38.58	46.02	-7.44	peak

Note: No emission found between lowest internal used/generated frequency to 30MHz(9KHz~30MHz)

**Above 1G Test Data**

Test Mode	GFSK_BR-1Mbps Low CH	Temp/Hum	24(°C)/ 33%RH
Test Item	Harmonic	Test Date	December 1, 2017
Polarize	Vertical	Test Engineer	Jerry Chuang
Detector	Peak and Average	Test Voltage	DC 5V

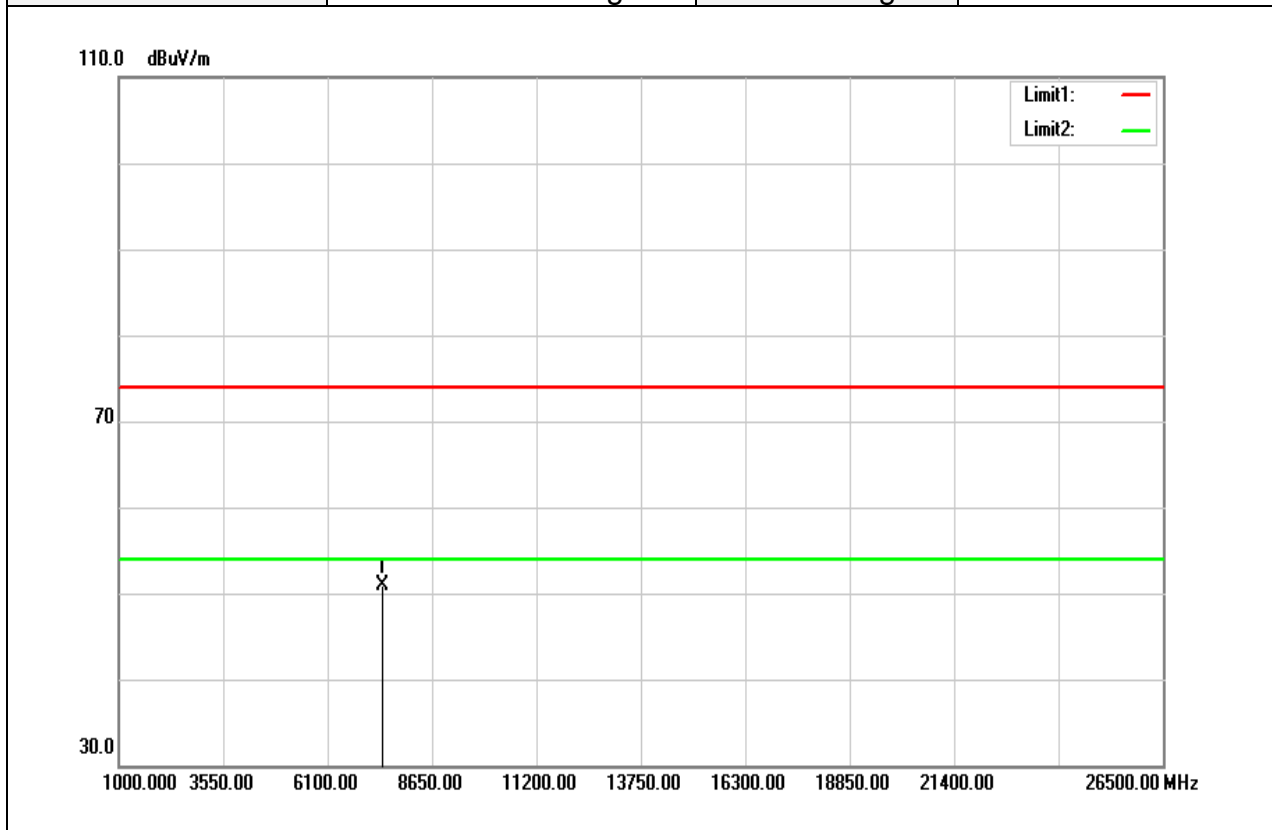

Frequency (MHz)	Reading (dBuV)	Correct Factor(dB/m)	Result (dBuV/m)	Limit (dBuV/m)	Margin (dB)	Remark
7438.000	40.49	10.51	51.00	74.00	-23.00	peak
N/A						

**Remark:**

1. Measuring frequencies from 1 GHz to the 10th harmonic of highest fundamental frequency.
2. For above 1GHz, the EUT peak value was under average limit, therefore the Average value compliance with the average limit

Test Mode	GFSK_BR-1Mbps Low CH	Temp/Hum	24(°C)/ 33%RH
Test Item	Harmonic	Test Date	December 1, 2017
Polarize	Horizontal	Test Engineer	Jerry Chuang
Detector	Peak and Average	Test Voltage	DC 5V

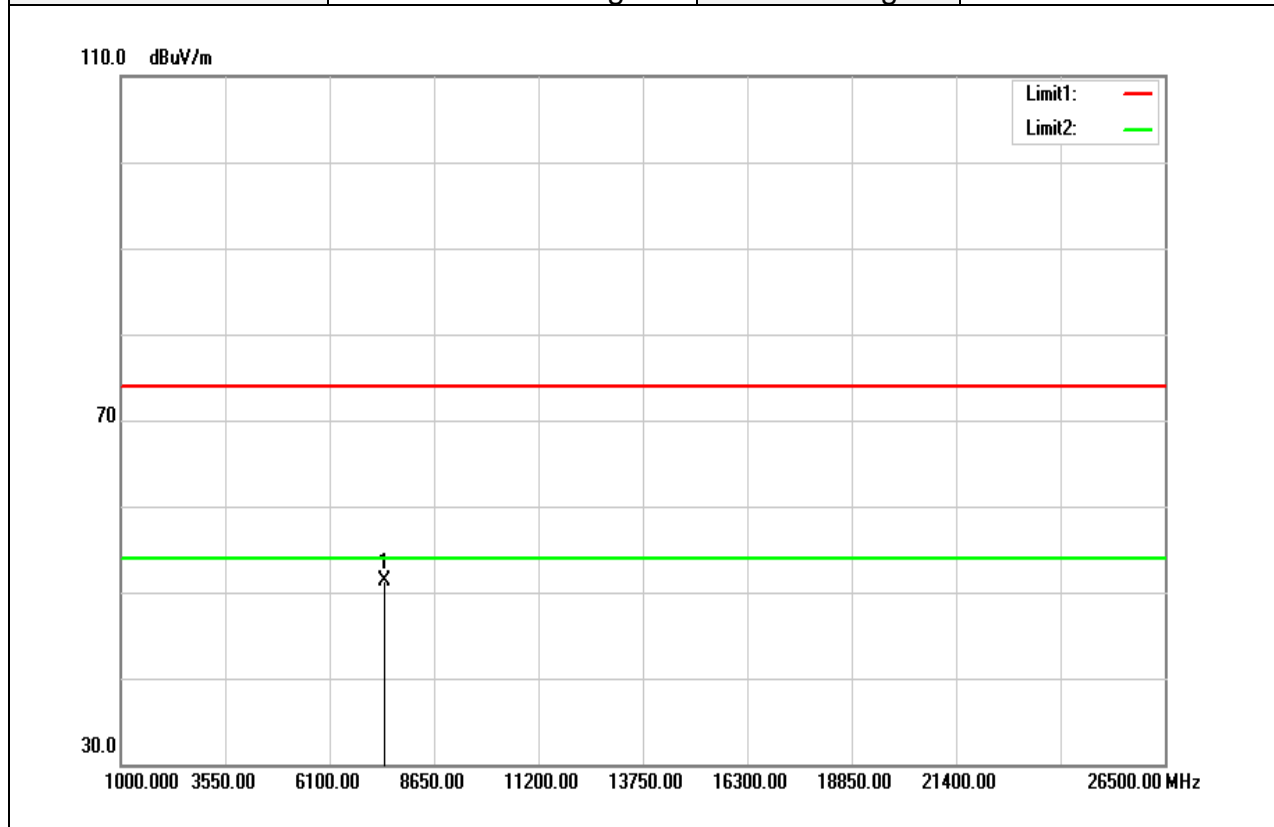

Frequency (MHz)	Reading ( BuV)	Correct Factor(dB/m)	Result (dBuV/m)	Limit (dBuV/m)	Margin (dB)	Remark
7438.000	40.75	10.51	51.26	74.00	-22.74	peak
N/A						

**Remark:**

1. Measuring frequencies from 1 GHz to the 10th harmonic of highest fundamental frequency.
2. For above 1GHz, the EUT peak value was under average limit, therefore the Average value compliance with the average limit

Test Mode	GFSK_BR-1Mbps Mid CH	Temp/Hum	24(°C)/ 33%RH
Test Item	Harmonic	Test Date	December 1, 2017
Polarize	Vertical	Test Engineer	Jerry Chuang
Detector	Peak and Average	Test Voltage	DC 5V

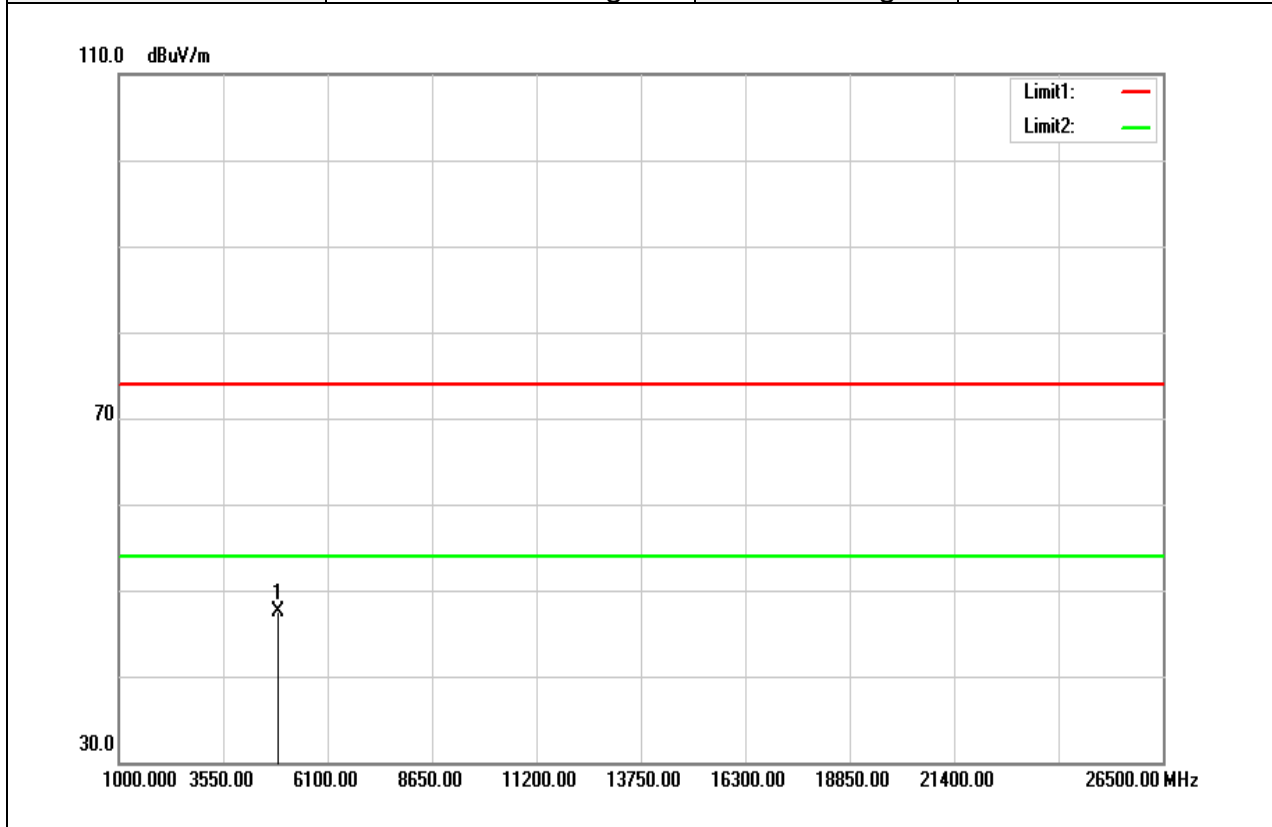

Frequency (MHz)	Reading (dBuV)	Correct Factor(dB/m)	Result (dBuV/m)	Limit (dBuV/m)	Margin (dB)	Remark
4883.000	43.09	4.49	47.58	74.00	-26.42	peak
N/A						

**Remark:**

1. Measuring frequencies from 1 GHz to the 10th harmonic of highest fundamental frequency.
2. For above 1GHz, the EUT peak value was under average limit, therefore the Average value compliance with the average limit

Test Mode	GFSK_BR-1Mbps Mid CH	Temp/Hum	24(°C)/ 33%RH
Test Item	Harmonic	Test Date	December 1, 2017
Polarize	Horizontal	Test Engineer	Jerry Chuang
Detector	Peak and Average	Test Voltage	DC 5V

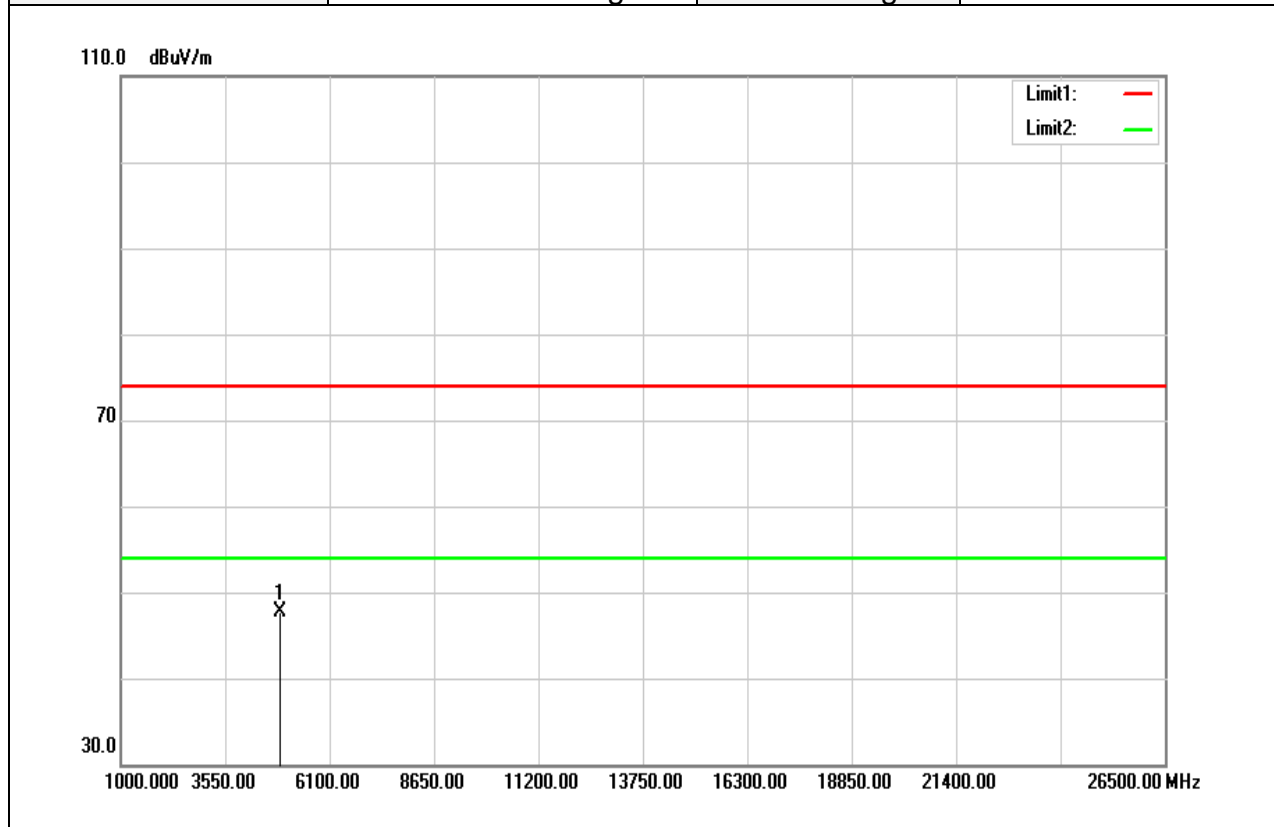

Frequency (MHz)	Reading (dBuV)	Correct Factor(dB/m)	Result (dBuV/m)	Limit (dBuV/m)	Margin (dB)	Remark
4883.000	43.15	4.49	47.64	74.00	-26.36	peak
N/A						

**Remark:**

1. Measuring frequencies from 1 GHz to the 10th harmonic of highest fundamental frequency.
2. For above 1GHz, the EUT peak value was under average limit, therefore the Average value compliance with the average limit



Test Mode	GFSK_BR-1Mbps High CH	Temp/Hum	24(°C)/ 33%RH
Test Item	Harmonic	Test Date	December 1, 2017
Polarize	Vertical	Test Engineer	Jerry Chuang
Detector	Peak and Average	Test Voltage	DC 5V

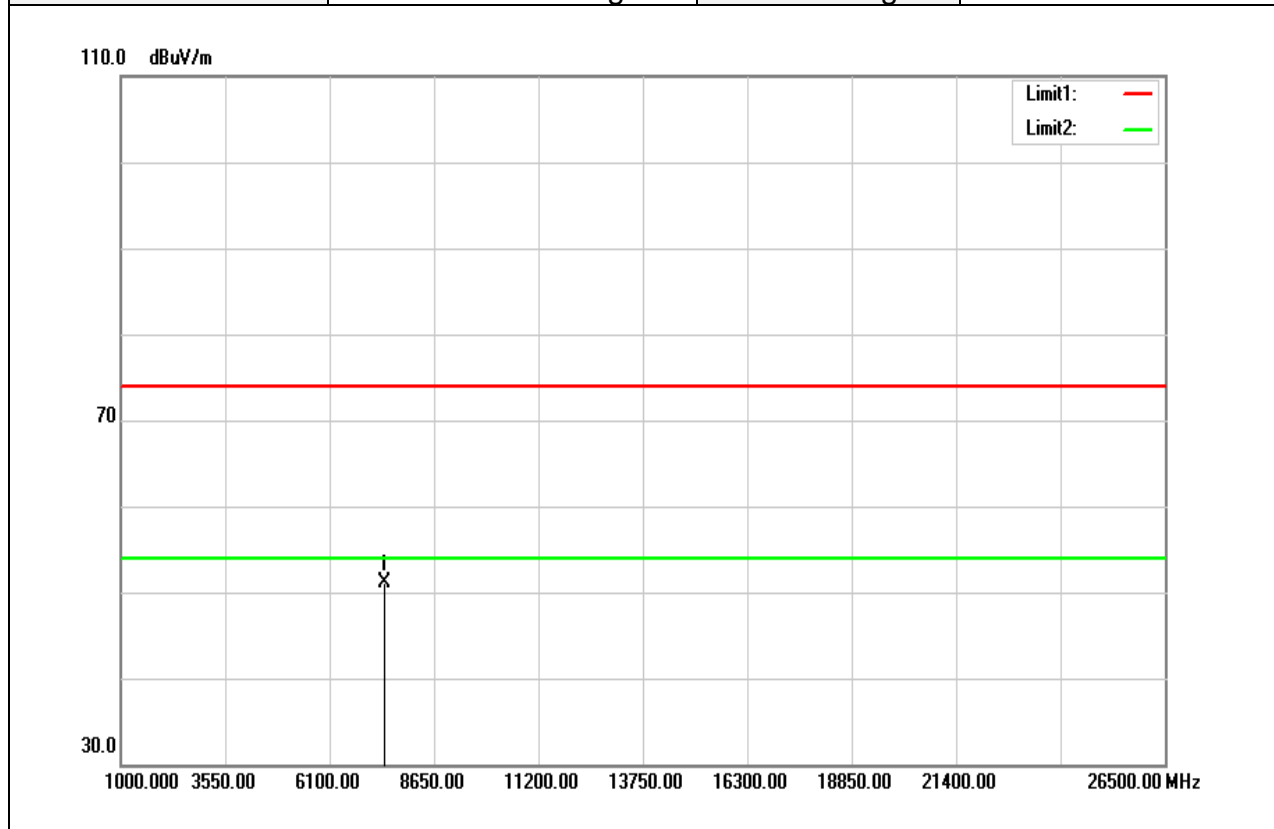

Frequency (MHz)	Reading (dBuV)	Correct Factor(dB/m)	Result (dBuV/m)	Limit (dBuV/m)	Margin (dB)	Remark
7438.000	40.55	10.51	51.06	74.00	-22.94	peak
N/A						

**Remark:**

1. Measuring frequencies from 1 GHz to the 10th harmonic of highest fundamental frequency.
2. For above 1GHz, the EUT peak value was under average limit, therefore the Average value compliance with the average limit

Test Mode	GFSK_BR-1Mbps High CH	Temp/Hum	24(°C)/ 33%RH
Test Item	Harmonic	Test Date	December 1, 2017
Polarize	Horizontal	Test Engineer	Jerry Chuang
Detector	Peak and Average	Test Voltage	DC 5V

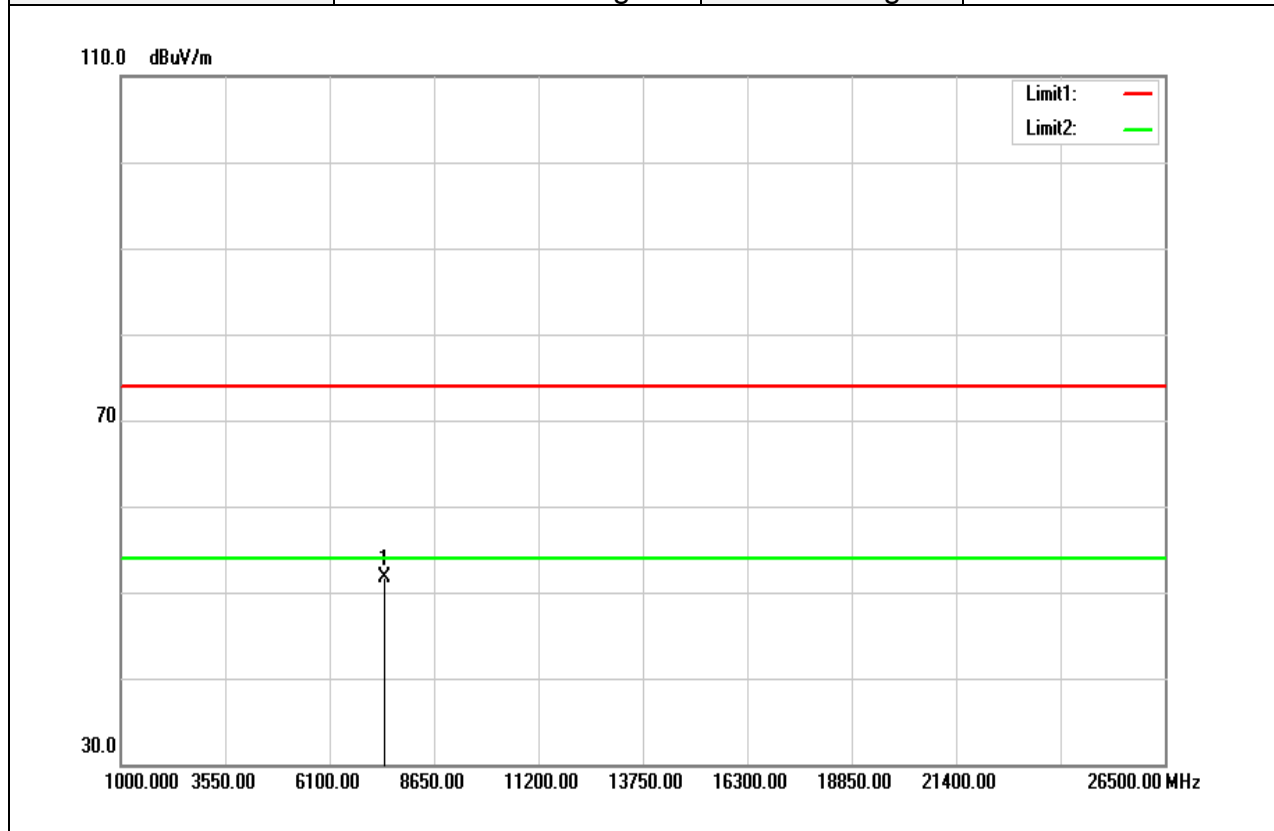

Frequency (MHz)	Reading (dBuV)	Correct Factor(dB/m)	Result (dBuV/m)	Limit (dBuV/m)	Margin (dB)	Remark
7438.000	41.18	10.51	51.69	74.00	-22.31	peak
N/A						

**Remark:**

1. Measuring frequencies from 1 GHz to the 10th harmonic of highest fundamental frequency.
2. For above 1GHz, the EUT peak value was under average limit, therefore the Average value compliance with the average limit

Test Mode	8DPSK_EDR-3Mbps Low CH	Temp/Hum	24(°C)/ 33%RH
Test Item	Harmonic	Test Date	December 1, 2017
Polarize	Vertical	Test Engineer	Jerry Chuang
Detector	Peak and Average	Test Voltage	DC 5V

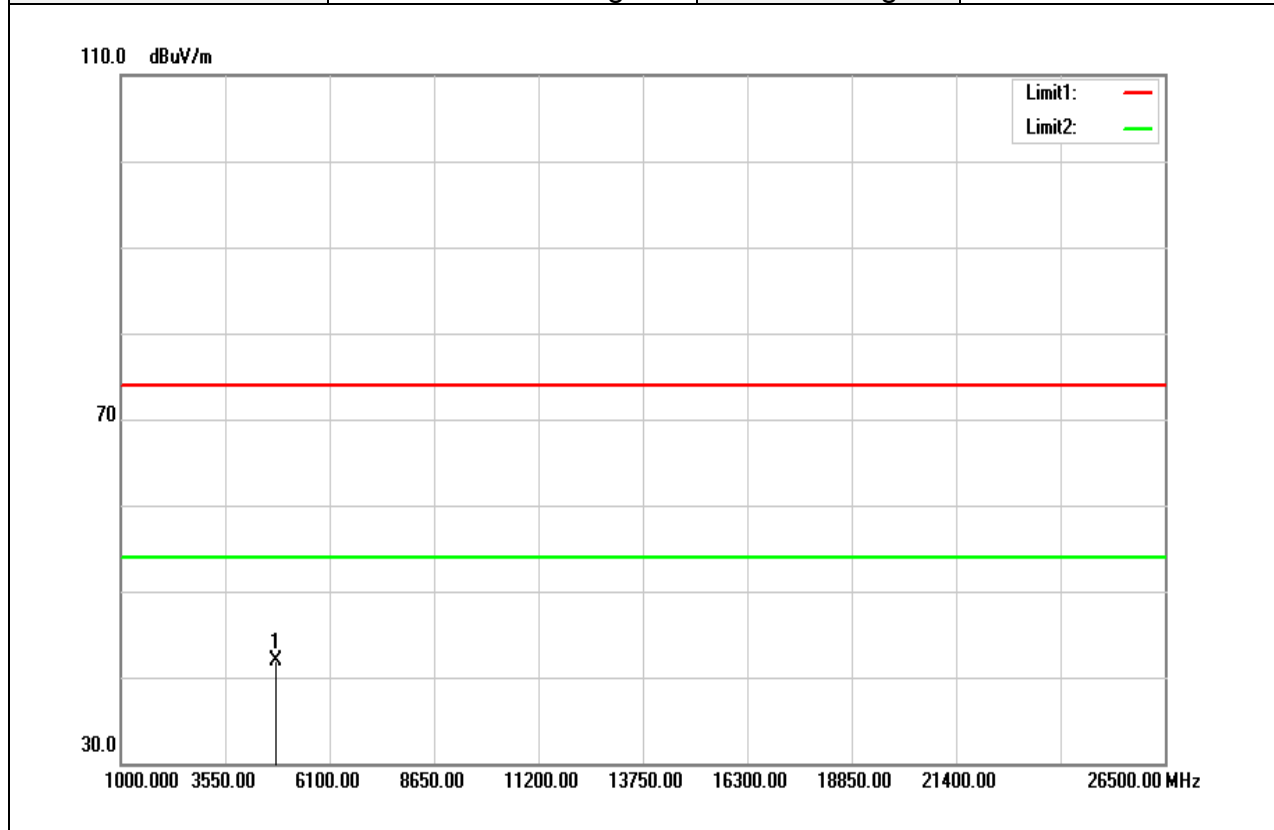

Frequency (MHz)	Reading (dBuV)	Correct Factor(dB/m)	Result (dBuV/m)	Limit (dBuV/m)	Margin (dB)	Remark
4804.000	37.49	4.34	41.83	74.00	-32.17	peak
N/A						

**Remark:**

1. Measuring frequencies from 1 GHz to the 10th harmonic of highest fundamental frequency.
2. For above 1GHz, the EUT peak value was under average limit, therefore the Average value compliance with the average limit

Test Mode	8DPSK_EDR-3Mbps Low CH	Temp/Hum	24(°C)/ 33%RH
Test Item	Harmonic	Test Date	December 1, 2017
Polarize	Horizontal	Test Engineer	Jerry Chuang
Detector	Peak and Average	Test Voltage	DC 5V

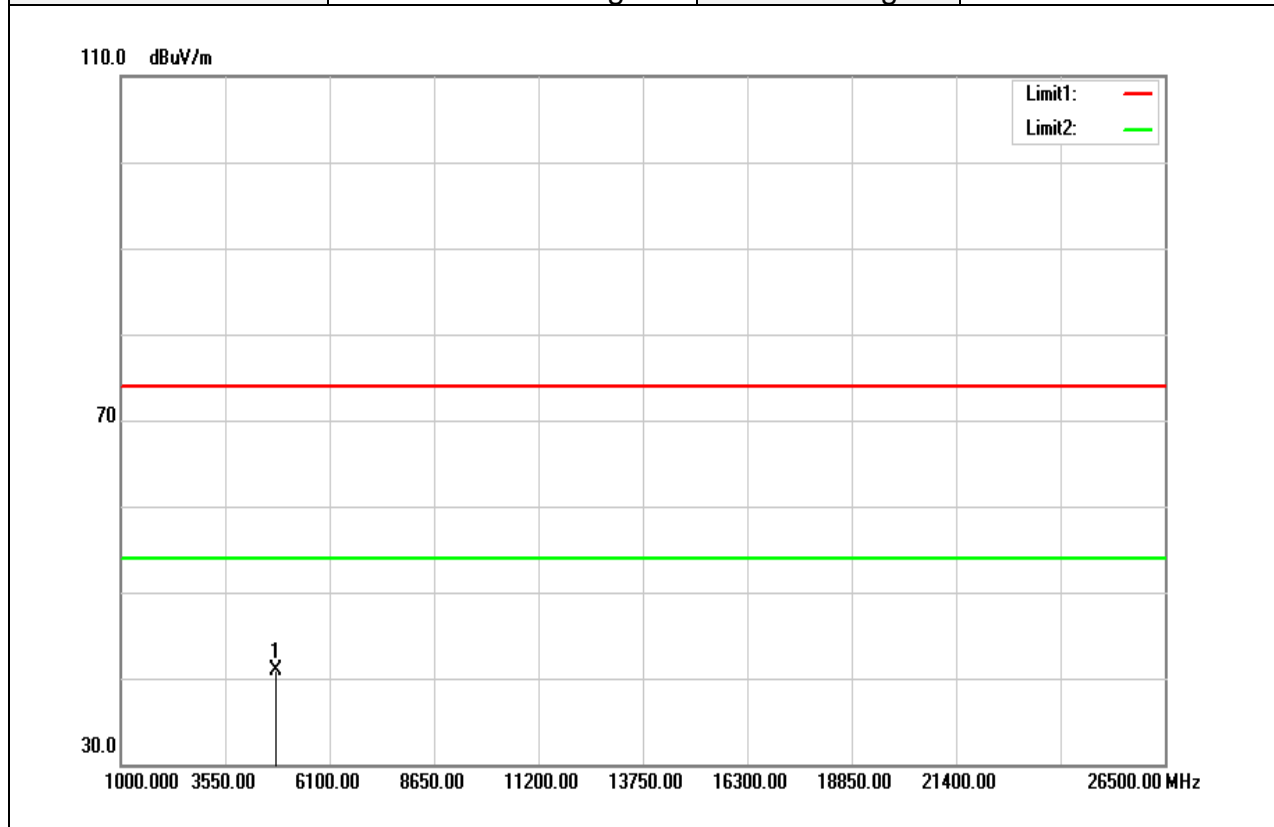

Frequency (MHz)	Reading (dBuV)	Correct Factor(dB/m)	Result (dBuV/m)	Limit (dBuV/m)	Margin (dB)	Remark
4804.000	36.56	4.34	40.90	74.00	-33.10	peak
N/A						

**Remark:**

1. Measuring frequencies from 1 GHz to the 10th harmonic of highest fundamental frequency.
2. For above 1GHz, the EUT peak value was under average limit, therefore the Average value compliance with the average limit

Test Mode	8DPSK_EDR-3Mbps Mid CH	Temp/Hum	24(°C)/ 33%RH
Test Item	Harmonic	Test Date	December 1, 2017
Polarize	Vertical	Test Engineer	Jerry Chuang
Detector	Peak and Average	Test Voltage	DC 5V

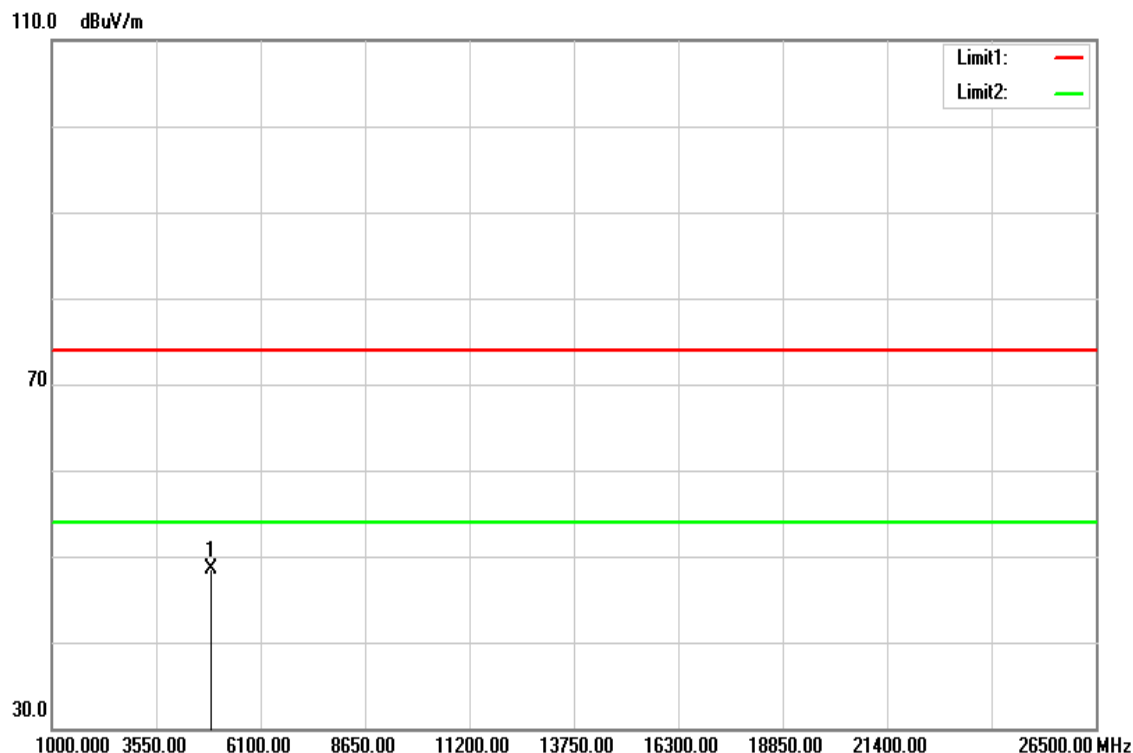

Frequency (MHz)	Reading (dBuV)	Correct Factor(dB/m)	Result (dBuV/m)	Limit (dBuV/m)	Margin (dB)	Remark
4883.000	43.96	4.49	48.45	74.00	-25.55	peak
N/A						

**Remark:**

1. Measuring frequencies from 1 GHz to the 10th harmonic of highest fundamental frequency.
2. For above 1GHz,the EUT peak value was under average limit, therefore the Average value compliance with the average limit

Test Mode	8DPSK_EDR-3Mbps Mid CH	Temp/Hum	24(°C)/ 33%RH
Test Item	Harmonic	Test Date	December 1, 2017
Polarize	Horizontal	Test Engineer	Jerry Chuang
Detector	Peak and Average	Test Voltage	DC 5V

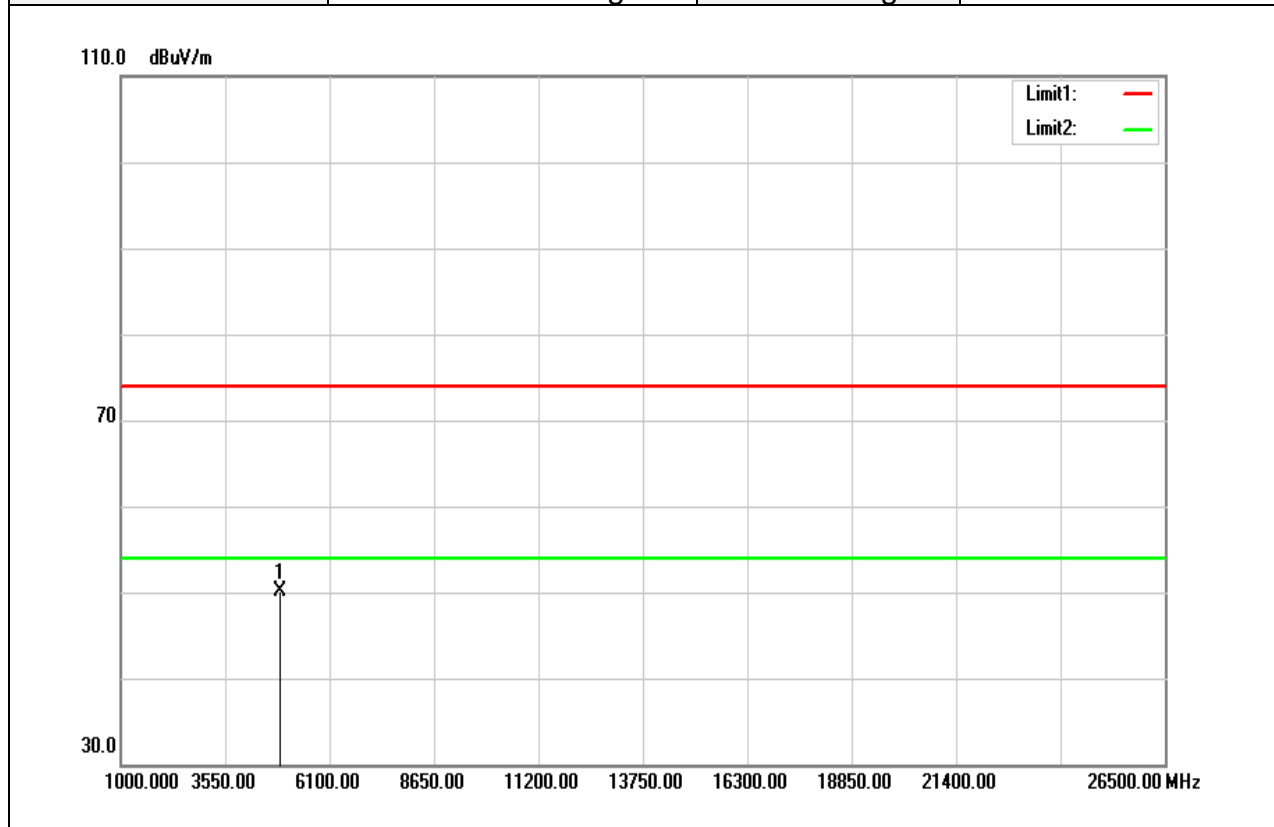

Frequency (MHz)	Reading (dBuV)	Correct Factor(dB/m)	Result (dBuV/m)	Limit (dBuV/m)	Margin (dB)	Remark
4883.000	45.66	4.49	50.15	74.00	-23.85	peak
N/A						

**Remark:**

1. Measuring frequencies from 1 GHz to the 10th harmonic of highest fundamental frequency.
2. For above 1GHz, the EUT peak value was under average limit, therefore the Average value compliance with the average limit

Test Mode	8DPSK_EDR-3Mbps High CH	Temp/Hum	24(°C)/ 33%RH
Test Item	Harmonic	Test Date	December 1, 2017
Polarize	Vertical	Test Engineer	Jerry Chuang
Detector	Peak and Average	Test Voltage	DC 5V

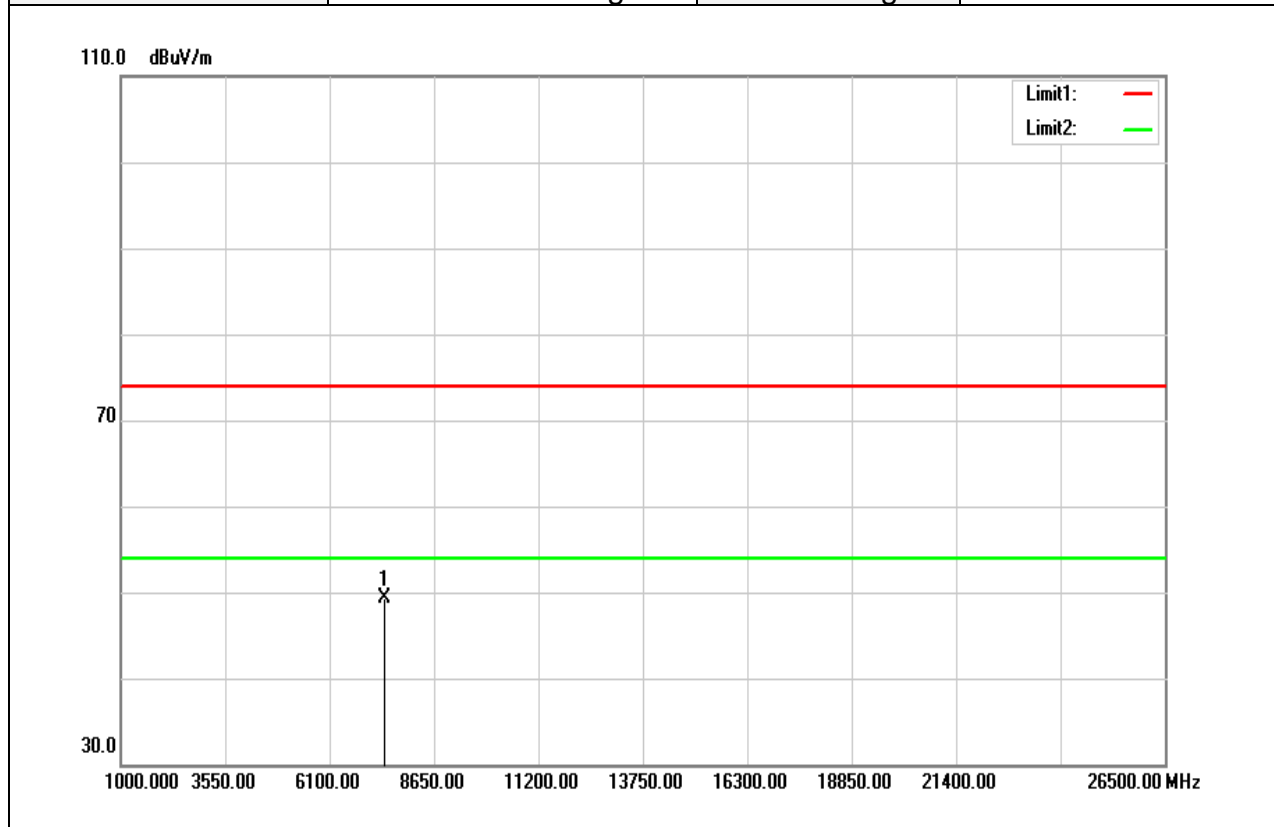

Frequency (MHz)	Reading (dBuV)	Correct Factor(dB/m)	Result (dBuV/m)	Limit (dBuV/m)	Margin (dB)	Remark
7438.000	38.83	10.51	49.34	74.00	-24.66	peak
N/A						

**Remark:**

1. Measuring frequencies from 1 GHz to the 10th harmonic of highest fundamental frequency.
2. For above 1GHz, the EUT peak value was under average limit, therefore the Average value compliance with the average limit

Test Mode	8DPSK_EDR-3Mbps High CH	Temp/Hum	24(°C)/ 33%RH
Test Item	Harmonic	Test Date	December 1, 2017
Polarize	Horizontal	Test Engineer	Jerry Chuang
Detector	Peak and Average	Test Voltage	DC 5V

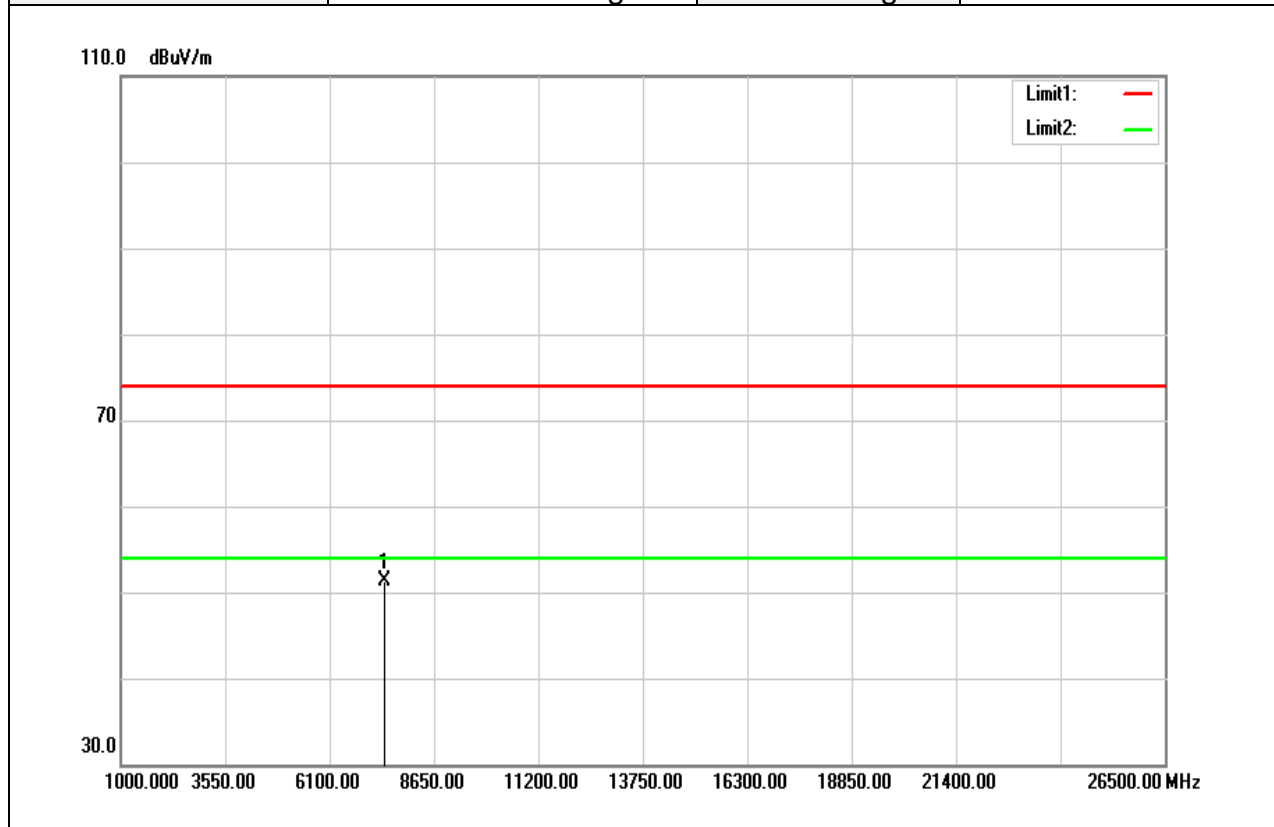

Frequency (MHz)	Reading (dBuV)	Correct Factor(dB/m)	Result (dBuV/m)	Limit (dBuV/m)	Margin (dB)	Remark
7438.000	40.80	10.51	51.31	74.00	-22.69	peak
N/A						

**Remark:**

1. Measuring frequencies from 1 GHz to the 10th harmonic of highest fundamental frequency.
2. For above 1GHz, the EUT peak value was under average limit, therefore the Average value compliance with the average limit