

TEST REPORT

Report No.: BCTC2103677008-1E

Applicant: mophie LLC

Product Name: mophie Universal Wireless Charging Hub

Model/Type Ref.: WRLS-CHG-HUB

Tested Date: 2021-03-26 to 2021-04-10

Issued Date: 2021-04-10

Shenzhen BCTC Testing Co., Ltd.



FCC ID: 2ACWB-MOPHUB

Product Name: mophie Universal Wireless Charging Hub
Trademark: mophie
Model/Type Ref.: WRLS-CHG-HUB
Prepared For: mophie LLC
Address: 6244 Technology Ave. Kalamazoo, Michigan 49009 United States
Manufacturer: mophie LLC
Address: 6244 Technology Ave. Kalamazoo, Michigan 49009 United States
Prepared By: Shenzhen BCTC Testing Co., Ltd.
Address: 1-2/F., Building B, Pengzhou Industrial Park, No.158, Fuyuan 1st Road, Tangwei, Fuhai Subdistrict, Bao'an District, Shenzhen, Guangdong, China
Sample Received Date: 2021-03-26
Sample tested Date: 2021-03-26 to 2021-04-10
Issue Date: 2021-04-10
Report No.: BCTC2103677008-1E
Test Standards: FCC Part15.209
ANSI C63.10-2013
Test Results: PASS

Tested by:

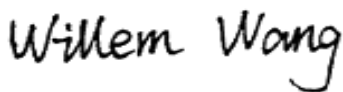

Willem Wang/Project Handler

Approved by:



Zero Zhou/Reviewer

The test report is effective only with both signature and specialized stamp. This result(s) shown in this report refer only to the sample(s) tested. Without written approval of Shenzhen BCTC Testing Co., Ltd, this report can't be reproduced except in full. The tested sample(s) and the sample information are provided by the client.

TABLE OF CONTENT

Test Report Declaration	Page
1. VERSION	4
2. TEST SUMMARY	5
3. MEASUREMENT UNCERTAINTY	6
4. PRODUCT INFORMATION AND TEST SETUP	7
4.1 Product Information	7
4.2 Test Setup Configuration	7
4.3 Support Equipment	8
4.4 Test Mode	8
4.5 Copy of marking plate	9
5. TEST FACILITY AND TEST INSTRUMENT USED	10
5.1 Test Facility	10
5.2 Test Instrument Used	10
6. CONDUCTED EMISSIONS	12
6.1 Block Diagram Of Test Setup	12
6.2 Limit	12
6.3 Test procedure	12
6.4 EUT operating Conditions	12
6.5 Test Result	13
7. RADIATED EMISSIONS	15
7.1 Block Diagram Of Test Setup	15
7.2 Limit	16
7.3 Test procedure	16
7.4 Test Result	18
8. EUT PHOTOGRAPHS	21
9. EUT TEST SETUP PHOTOGRAPHS	23

(Note: N/A means not applicable)

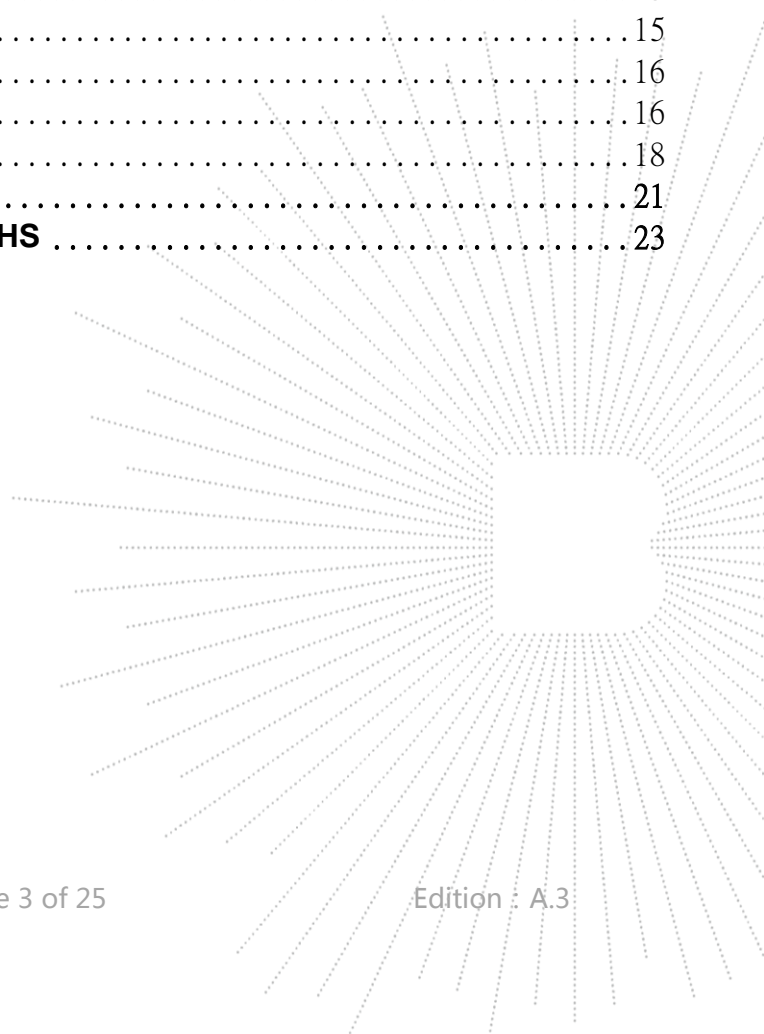

1. VERSION

Report No.	Issue Date	Description	Approved
BCTC2103677008-1E	2021-04-10	Original	Valid

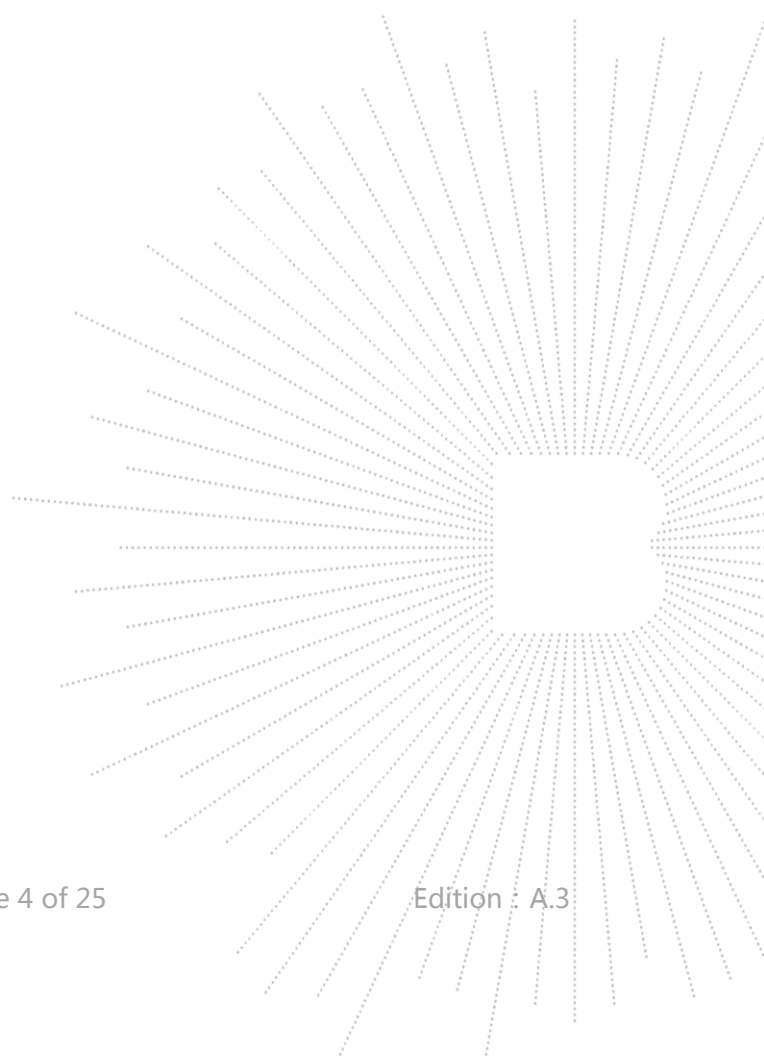

2. TEST SUMMARY

The Product has been tested according to the following specifications:

No.	Test Parameter	Clause No	Results
1	Conducted Emission	15.207	PASS
2	Radiated Emission	15.209	PASS
3	Antenna Requirement	15.203	PASS

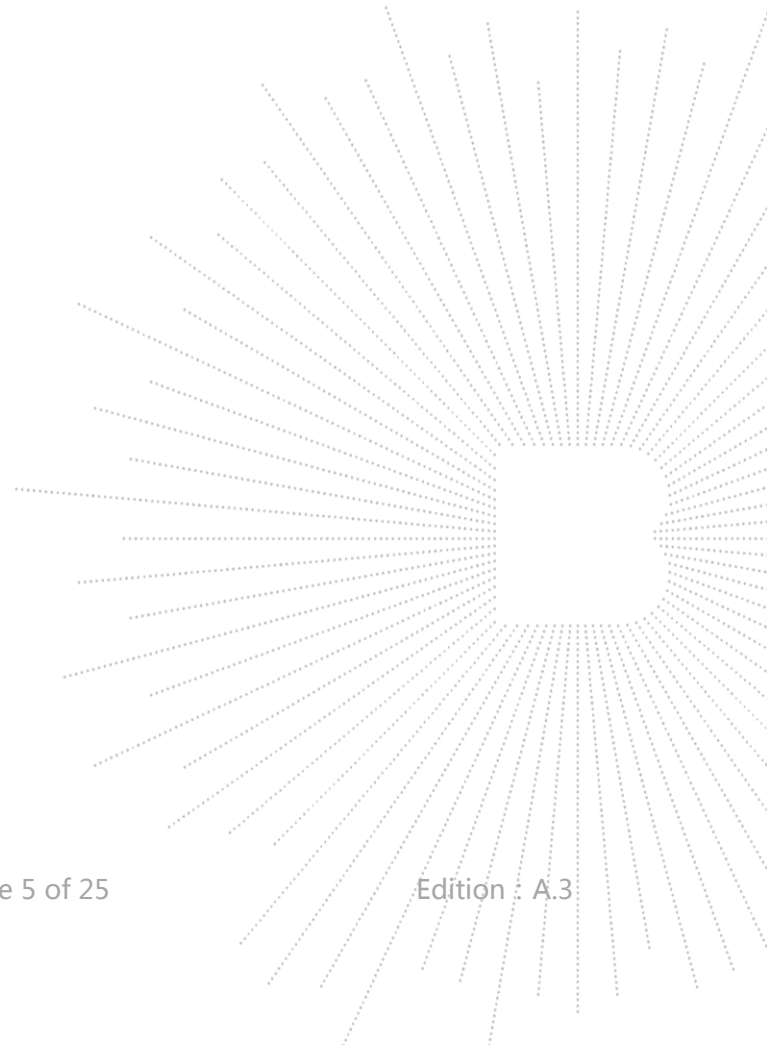

3. MEASUREMENT UNCERTAINTY

Where relevant, the following measurement uncertainty levels have been estimated for tests performed on the Product as specified in CISPR 16-4-2. This uncertainty represents an expanded uncertainty expressed at approximately the 95% confidence level using a coverage factor of $k=2$.

No.	Item	Uncertainty
1	3m camber Radiated spurious emission(30MHz-1GHz)	U=4.3dB
2	Conducted Emission (150kHz-30MHz)	U=3.2dB
3	humidity uncertainty	U=5.3%
4	Temperature uncertainty	U=0.59°C

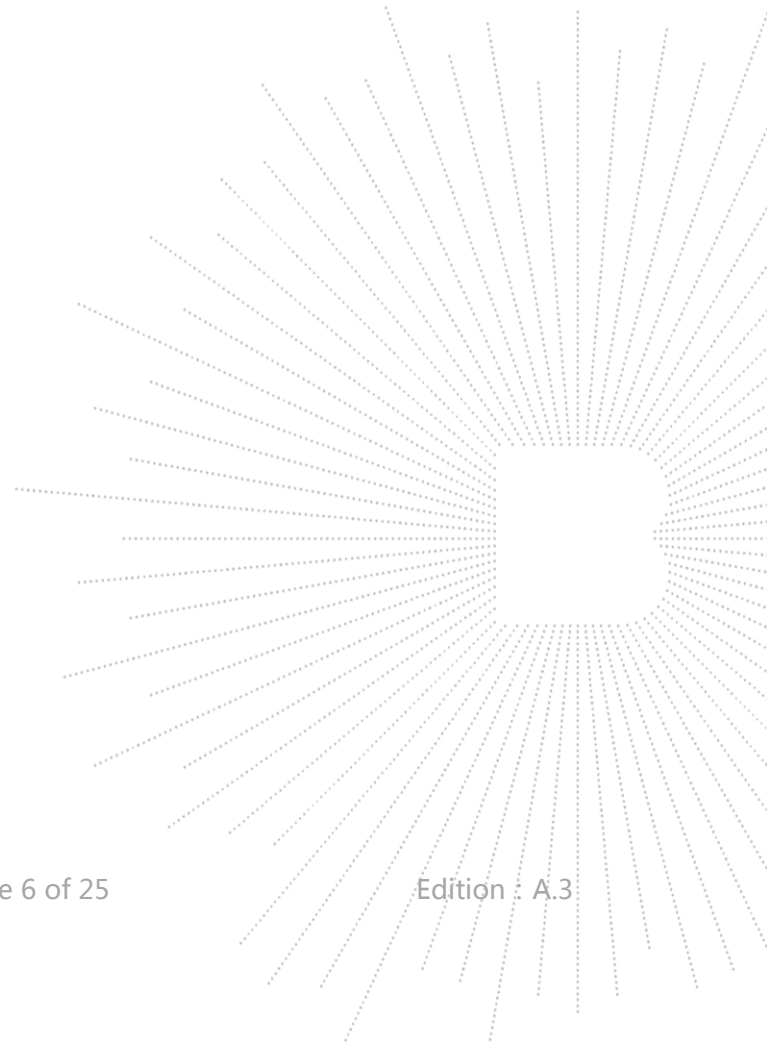

4. PRODUCT INFORMATION AND TEST SETUP

4.1 Product Information

Model/Type Ref.:	WRLS-CHG-HUB
Model differences:	N/A
Product Description:	mophie Universal Wireless Charging Hub
Operation Frequency:	115kHz-205kHz
Antenna installation:	Inductive loop coil antenna
Ratings:	Input: DC 15V 4A Output(Qi): 10W Max Output (USB-C): DC 5V 3A;DC 9V 2.22A; DC 12V 1.67A Output (USB-A1): DC 5V 3A;DC 9V 2A; DC 12V 1.5A Output (USB-A2): DC 5V 2.4A Output (USB-A1+ USB-A2): DC 5V 3A 15W
Adapter	Model No.: PYS-000215 Input: AC 100-240V 50/60Hz 1.6A Output: DC 15V 4A
Hardware Version:	V4
Software Version:	V1

4.2 Test Setup Configuration

See test photographs attached in *EUT TEST SETUP PHOTOGRAPHS* for the actual connections between Product and support equipment.

Conducted Emission/Radiated Spurious Emission:

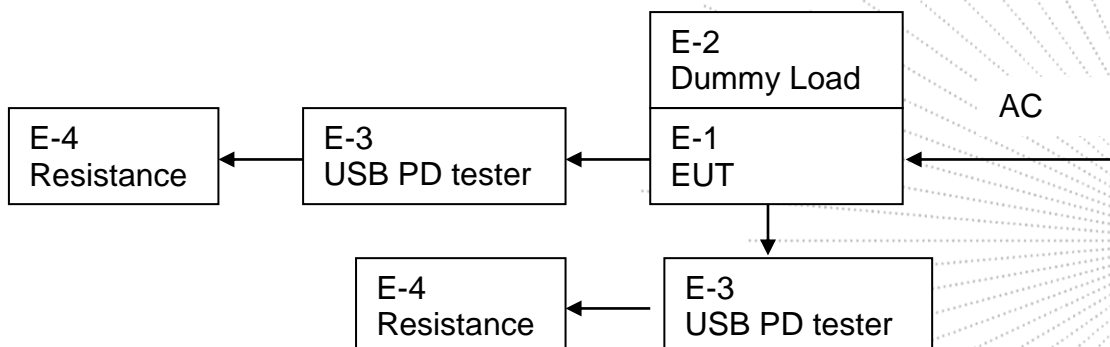

4.3 Support Equipment

No.	Device Type	Brand	Model	Series No.	Data Cable	Remark
E-1	mophie Universal Wireless Charging Hub	mophie	WRLS-CHG- HUB	N/A	N/A	EUT
E-2	Dummy load	N/A	DL01	N/A	N/A	Auxiliary
E-3	USB PD tester	N/A	KT001	N/A	N/A	Auxiliary
E-4	Resistance	N/A	N/A	N/A	N/A	Auxiliary

Notes:

1. All the equipment/cables were placed in the worst-case configuration to maximize the emission during the test.
2. Grounding was established in accordance with the manufacturer's requirements and conditions for the intended use.

4.4 Test Mode

To investigate the maximum EMI emission characteristics generates from EUT, the test system was pre-scanning tested base on the consideration of following EUT operation mode or test configuration mode which possible have effect on EMI emission level. Each of these EUT operation mode(s) or test configuration mode(s) mentioned above was evaluated respectively.

Test Modes 1	Wireless 10W
--------------	--------------

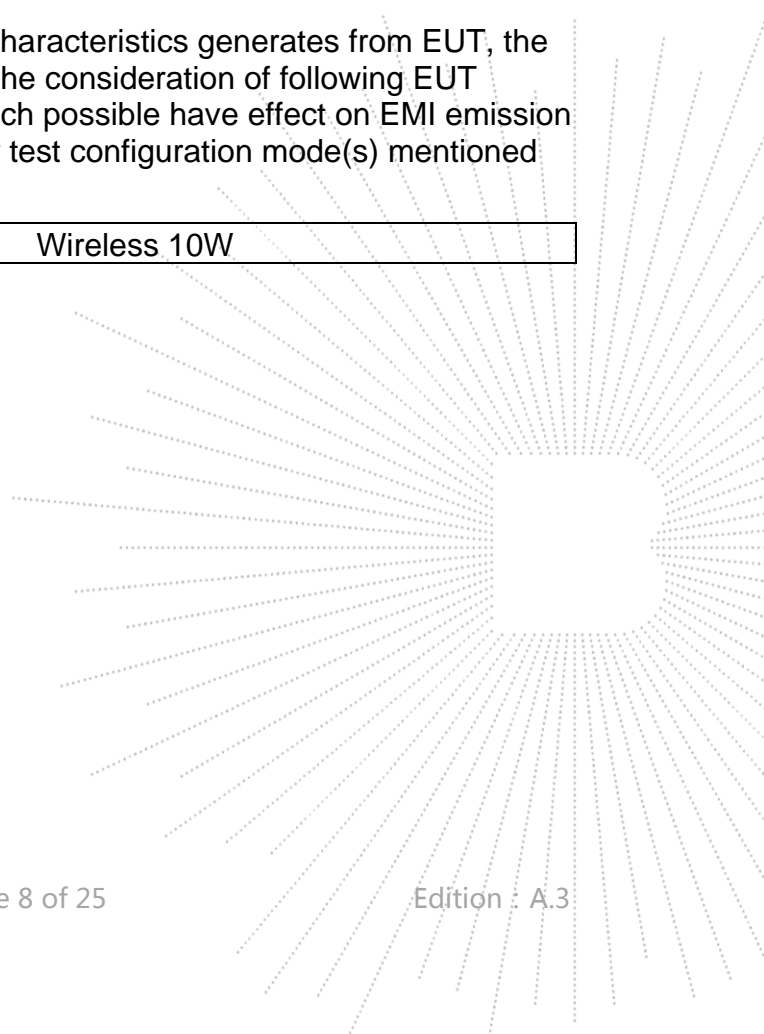

4.5 Copy of marking plate

mophie **Universal Wireless Charging Hub**
M/N: WRLS-CHG-HUB
Input: 15V \equiv 4A MAX Output (Qi): 10W Max
Output (USB-C): 5V \equiv 3A; 9V \equiv 2.22A; 12V \equiv 1.67A (PD20W)
Output (USB-A1): 5V \equiv 3A; 9V \equiv 2A; 12V \equiv 1.5A (QC18W)
Output (USB-A2): 5V \equiv 2.4A
Output (USB-A1+ USB-A2): 5V \equiv 3A 15W
FCC ID: 2ACWB-MOPHUB IC: 10465A-MOPHUB
© 2021 mophie inc. Made in China 110-08054-A
ZAGG Inc | 910 Legacy Center Way, Ste. 500 Midvale, Utah 84047
ZAGG International | 103 Shannon Industrial Estate, Shannon Co.
Clare, V14PH121, Ireland

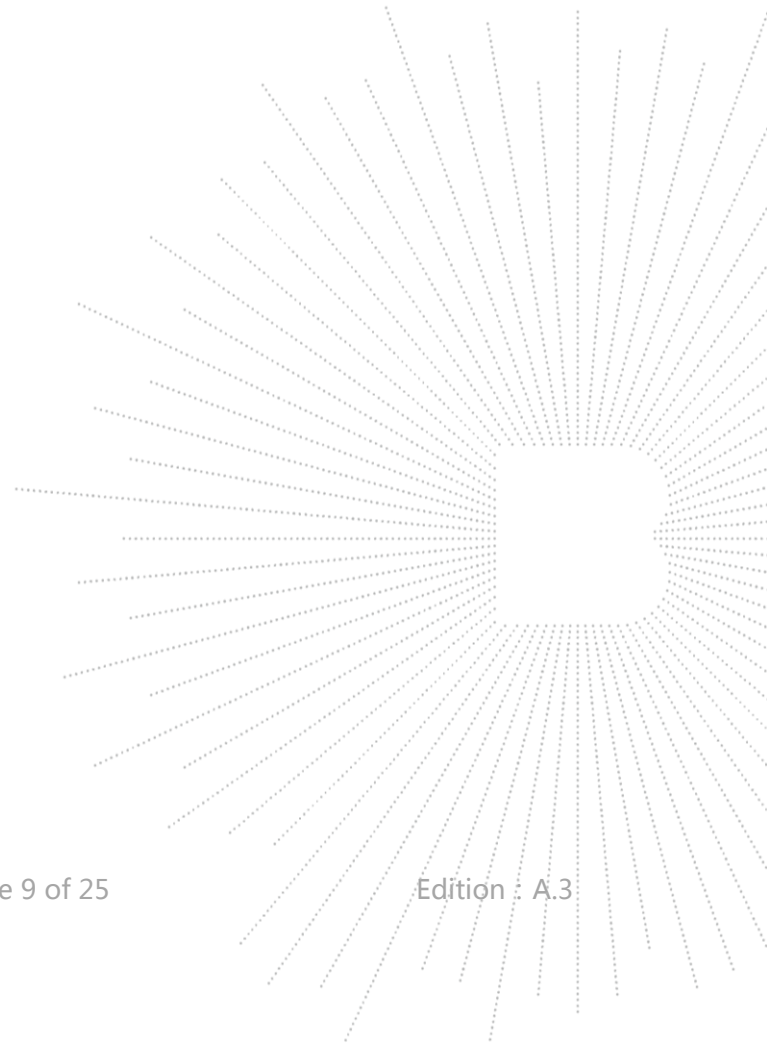

5. TEST FACILITY AND TEST INSTRUMENT USED

5.1 Test Facility

All measurement facilities used to collect the measurement data are located at Shenzhen BCTC Testing Co., Ltd. Address: 1-2/F., Building B, Pengzhou Industrial Park, No.158, Fuyuan 1st Road, Tangwei, Fuhai Subdistrict, Bao'an District, Shenzhen, Guangdong, China. The site and apparatus are constructed in conformance with the requirements of ANSI C63.4 and CISPR 16-1-1 other equivalent standards.

FCC Test Firm Registration Number: 712850

IC Registered No.: 23583

5.2 Test Instrument Used

Conducted emissions Test					
Equipment	Manufacturer	Model#	Serial#	Last Cal.	Next Cal.
Receiver	R&S	ESR3	102075	Jun. 08, 2020	Jun. 07, 2021
LISN	R&S	ENV216	101375	Jun. 04, 2020	Jun. 03, 2021
ISN	HPX	ISN T800	S1509001	Jun. 04, 2020	Jun. 03, 2021
Software	Frad	EZ-EMC	EMC-CON 3A1	\	\

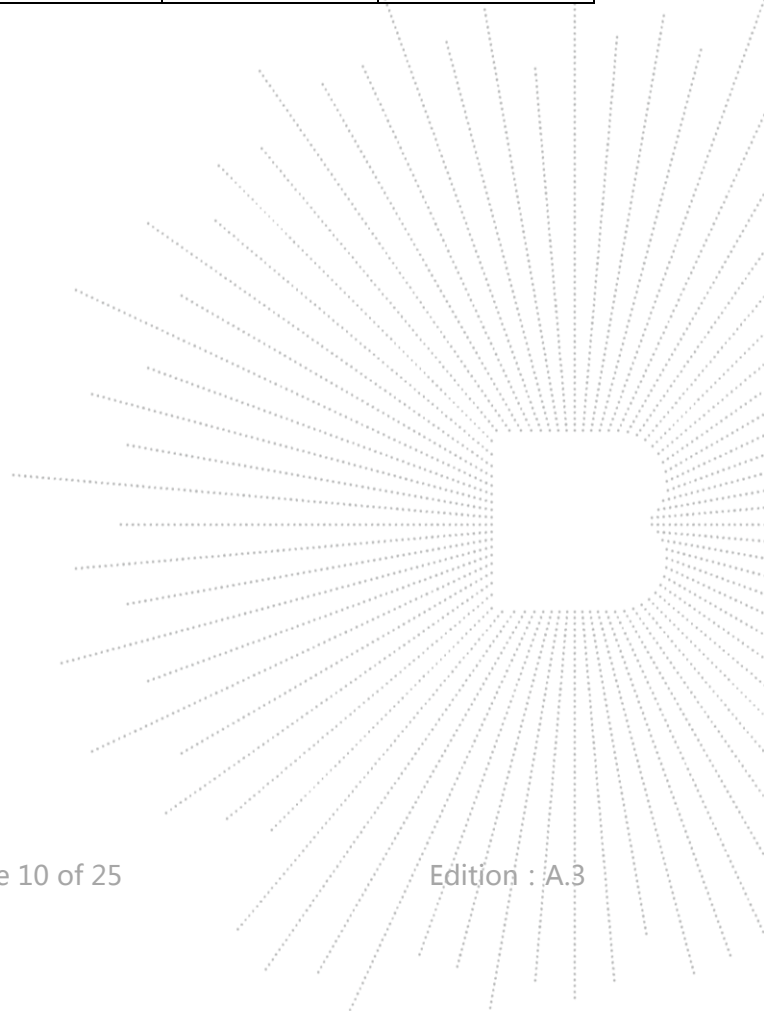

Radiated emissions Test (966 chamber)					
Equipment	Manufacturer	Model#	Serial#	Last Cal.	Next Cal.
966 chamber	ChengYu	966 Room	966	Jun. 06. 2020	Jun. 05, 2023
Receiver	R&S	ESR3	102075	Jun. 08, 2020	Jun. 07, 2021
Receiver	R&S	ESRP	101154	Jun. 08, 2020	Jun. 07, 2021
Amplifier	Schwarzbeck	BBV9718	9718-309	Jun. 04, 2020	Jun. 03, 2021
Amplifier	Schwarzbeck	BBV9744	9744-0037	Jun. 04, 2020	Jun. 03, 2021
TRILOG Broadband Antenna	schwarzbeck	VULB 9163	VULB9163-942	Jun. 08, 2020	Jun. 07, 2021
Horn Antenna	SCHWARZBECK	BBHA9120 D	1201	Jun. 10, 2020	Jun. 09, 2021
Horn Antenna (18GHz-40 GHz)	SCHWARZBECK	BBHA9170	822	Jun. 10, 2020	Jun. 09, 2021
Amplifier (18GHz-40 GHz)	MITEQ	TTA1840-3 5-HG	2034381	Jun. 08, 2020	Jun. 07, 2021
Loop Antenna (9kHz-30M Hz)	SCHWARZBECK	FMZB1519 B	014	Jun. 08, 2020	Jun. 07, 2021
RF cables1 (9kHz-30MHz)	Huber+Suhnar	9kHz-30M Hz	B1702988-0008	Jun. 08, 2020	Jun. 07, 2021
RF cables2 (30MHz-1G Hz)	Huber+Suhnar	30MHz-1G Hz	1486150	Jun. 08, 2020	Jun. 07, 2021
RF cables3 (1GHz-40G Hz)	Huber+Suhnar	1GHz-40G Hz	1607106	Jun. 08, 2020	Jun. 07, 2021
Power Metter	Keysight	E4419B	\	Jun. 08, 2020	Jun. 07, 2021
Power Sensor (AV)	Keysight	E9 300A	\	Jun. 08, 2020	Jun. 07, 2021
Signal Analyzer 20kHz-26.5 GHz	KEYSIGHT	N9020A	MY491000 60	Jun. 04, 2020	Jun. 03, 2021
Spectrum Analyzer 9kHz-40G Hz	Agilent	FSP40	100363	Jun. 08, 2020	Jun. 07, 2021
Software	Frad	EZ-EMC	FA-03A2 RE	\	\

6. CONDUCTED EMISSIONS

6.1 Block Diagram Of Test Setup

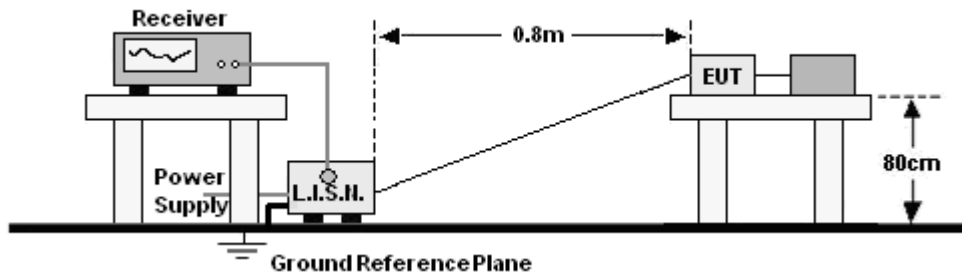

6.2 Limit

FREQUENCY (MHz)	Limit (dBuV)	
	Quas-peak	Average
0.15 -0.5	66 - 56 *	56 - 46 *
0.50 -5.0	56.00	46.00
5.0 -30.0	60.00	50.00

Notes:

- *Decreasing linearly with logarithm of frequency.
- The lower limit shall apply at the transition frequencies.

6.3 Test procedure

Receiver Parameters	Setting
Attenuation	10 dB
Start Frequency	0.15 MHz
Stop Frequency	30 MHz
IF Bandwidth	9 kHz

a. The Product was placed on a nonconductive table 0.8 m above the horizontal ground reference plane, and 0.4 m from the vertical ground reference plane, and connected to the main through Line Impedance Stability Network (L.I.S.N).

b. The RBW of the receiver was set at 9 kHz in 150 kHz ~ 30MHz with Peak and AVG detector in Max Hold mode. Run the receiver's pre-scan to record the maximum disturbance generated from Product in all power lines in the full band.

c. For each frequency whose maximum record was higher or close to limit, measure its QP and AVG values and record.

6.4 EUT operating Conditions

The EUT was configured for testing in a typical fashion (as a customer would normally use it). The EUT has been programmed to continuously transmit during test. This operating condition was tested and used to collect the included data.

6.5 Test Result

Temperature :	26 °C	Relative Humidity :	54%
Pressure :	101kPa	Phase :	L
Test Voltage :	AC 120V/60Hz	Test Mode :	Mode 1

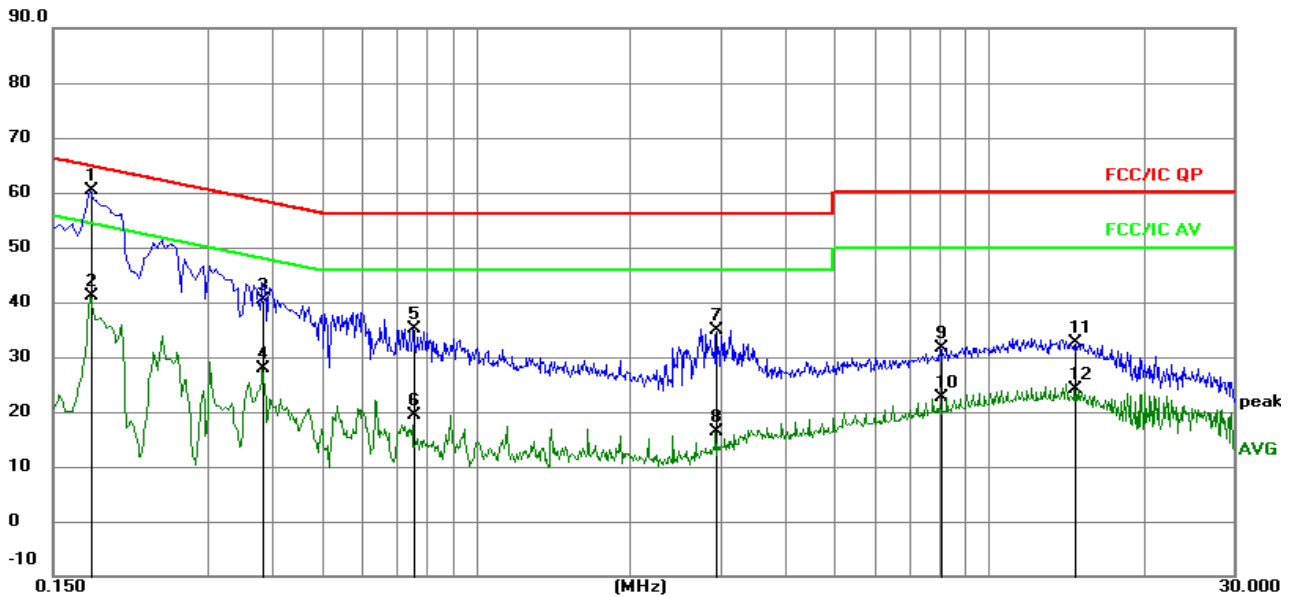

Remark:

1. All readings are Quasi-Peak and Average values.
2. Factor = Insertion Loss + Cable Loss.

No.	Mk.	Freq.	Reading Level	Correct Factor	Measurement	Limit	Over	Detector
		MHz		dB	dBuV	dBuV	dB	
1	*	0.1770	50.87	9.49	60.36	64.63	-4.27	QP
2		0.1770	31.62	9.49	41.11	54.63	-13.52	AVG
3		0.3840	30.84	9.51	40.35	58.19	-17.84	QP
4		0.3840	18.48	9.51	27.99	48.19	-20.20	AVG
5		0.7575	25.46	9.64	35.10	56.00	-20.90	QP
6		0.7575	9.65	9.64	19.29	46.00	-26.71	AVG
7		2.9400	25.20	9.66	34.86	56.00	-21.14	QP
8		2.9400	6.63	9.66	16.29	46.00	-29.71	AVG
9		8.0520	21.86	9.71	31.57	60.00	-28.43	QP
10		8.0520	12.89	9.71	22.60	50.00	-27.40	AVG
11		14.6985	23.04	9.70	32.74	60.00	-27.26	QP
12		14.6985	14.53	9.70	24.23	50.00	-25.77	AVG

Temperature :	26 °C	Relative Humidity :	54%
Pressure :	101kPa	Phase :	N
Test Voltage :	AC 120V/60Hz	Test Mode :	Mode 1

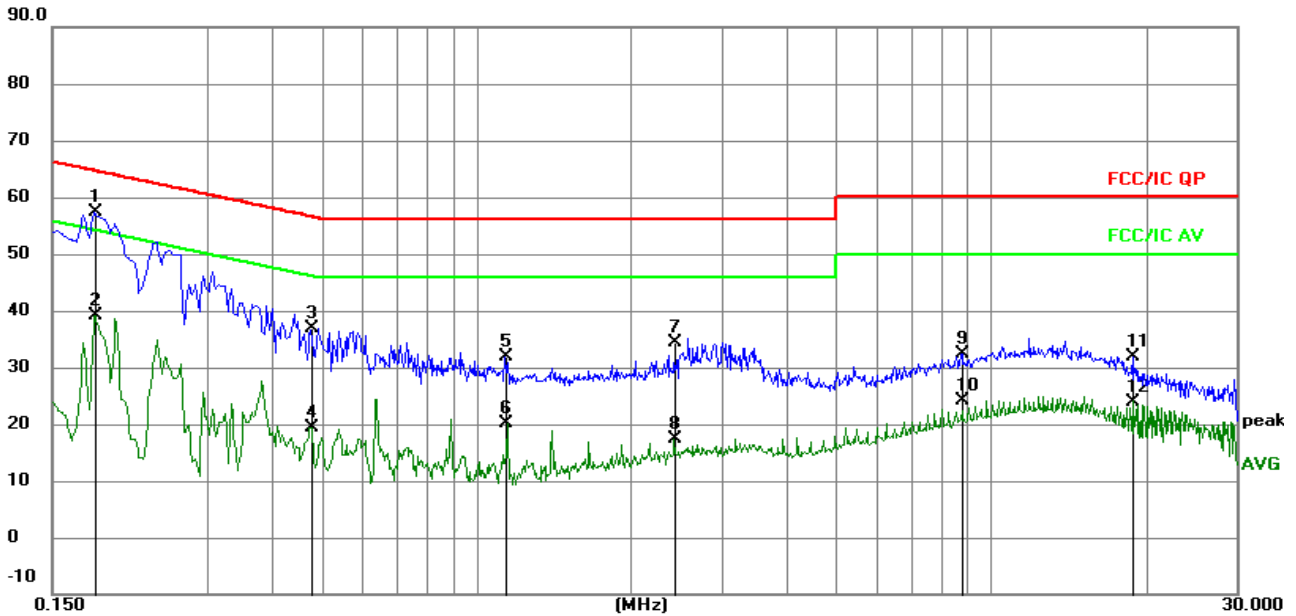

Remark:

1. All readings are Quasi-Peak and Average values.
2. Factor = Insertion Loss + Cable Loss.

No.	Mk.	Freq.	Reading Level	Correct Factor	Measurement	Limit	Over	Detector
		MHz		dB	dBuV	dBuV	dB	
1	*	0.1815	47.89	9.48	57.37	64.42	-7.05	QP
2		0.1815	29.68	9.48	39.16	54.42	-15.26	AVG
3		0.4785	27.30	9.57	36.87	56.37	-19.50	QP
4		0.4785	9.85	9.57	19.42	46.37	-26.95	AVG
5		1.1355	22.35	9.57	31.92	56.00	-24.08	QP
6		1.1355	10.47	9.57	20.04	46.00	-25.96	AVG
7		2.4270	24.86	9.62	34.48	56.00	-21.52	QP
8		2.4270	7.78	9.62	17.40	46.00	-28.60	AVG
9		8.8170	22.62	9.70	32.32	60.00	-27.68	QP
10		8.8170	14.53	9.70	24.23	50.00	-25.77	AVG
11		18.9150	22.08	9.77	31.85	60.00	-28.15	QP
12		18.9150	14.23	9.77	24.00	50.00	-26.00	AVG

7. RADIATED EMISSIONS

7.1 Block Diagram Of Test Setup

(A) Radiated Emission Test-Up Frequency Below 30MHz

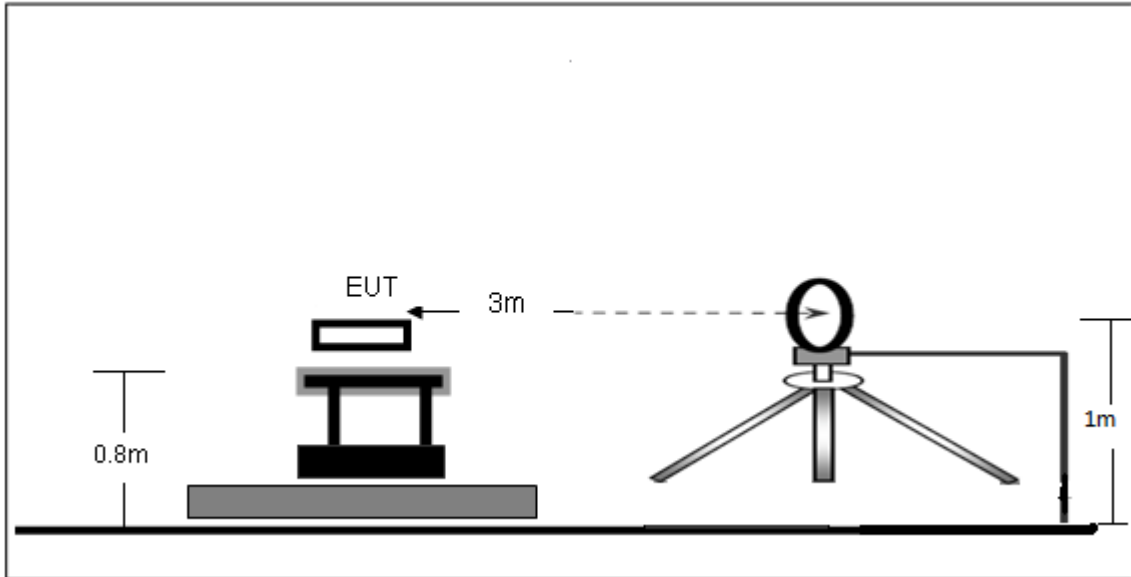

(B) Radiated Emission Test-Up Frequency 30MHz~1GHz

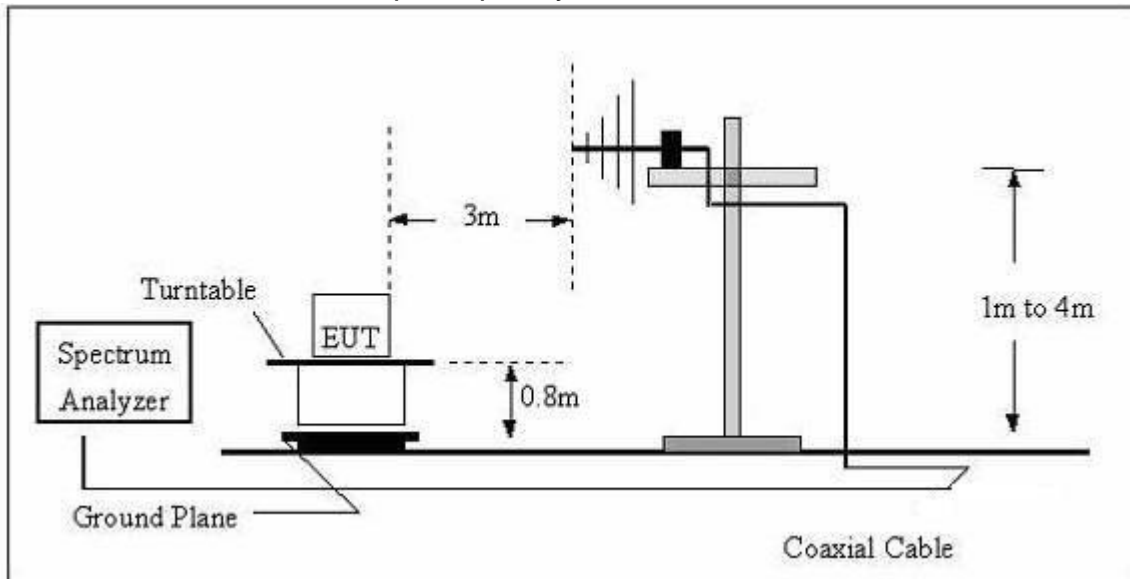

7.2 Limit

FCC §15.209; §15.205.

Test Standard	FCC Part15 C Section 15.209 and 15.205				
Test Limit	Frequency (MHz)	Field strength (microvolt/meter)	Limit (dBuV/m)	Remark	Measurement distance (m)
	0.009MHz~0.490MHz	2400/F(kHz)	-	-	300
	0.490MHz~1.705MHz	24000/F(kHz)	-	-	30
	1.705MHz~30MHz	30	-	-	30
	30MHz~88MHz	100	40.0	Quasi-peak	3
	88MHz~216MHz	150	43.5	Quasi-peak	3
	216MHz~960MHz	200	46.0	Quasi-peak	3
	960MHz~1000MHz	500	54.0	Quasi-peak	3
	Above 1000MHz	500	54.0	Average	3
-		74.0	Peak	3	

7.3 Test procedure

Receiver Parameter	Setting
Attenuation	Auto
9kHz~150kHz	RBW 200Hz for QP
150kHz~30MHz	RBW 9kHz for QP
30MHz~1000MHz	RBW 120kHz for QP

Below 1GHz test procedure as below:

- The EUT was placed on the top of a rotating table 0.8 meters above the ground at a 3 meter semi-anechoic chamber. The table was rotated 360 degrees to determine the position of the highest radiation.
- The EUT was set 3 meters away from the interference-receiving antenna, which was mounted on the top of a variable-height antenna tower.
- The antenna height is varied from one meter to four meters above the ground to determine the maximum value of the field strength. Both horizontal and vertical polarizations of the antenna are set to make the measurement.
- For each suspected emission, the EUT was arranged to its worst case and then the antenna was tuned to heights from 1 meter to 4 meters (for the test frequency of below 30MHz, the antenna was tuned to heights 1 meter) and the rotatable table was turned from 0 degrees to 360 degrees to find the maximum reading.

e. The test-receiver system was set to Peak Detect Function and Specified Bandwidth with Maximum Hold Mode.

f. If the emission level of the EUT in peak mode was 10dB lower than the limit specified, then testing could be stopped and the peak values of the EUT would be reported. Otherwise the emissions that did not have 10dB margin would be re-tested one by one using peak, quasi-peak or average method as specified and then reported in a data sheet.

Above 1GHz test procedure as below:

g. Different between above is the test site, change from Semi- Anechoic Chamber to fully Anechoic Chamber and change form table 0.8 metre to 1.5 metre(Above 18GHz the distance is 1 meter and table is 1.5 metre).

h. Test the EUT in the lowest channel ,the middle channel ,the Highest channel.

Note:

Both horizontal and vertical antenna polarities were tested and performed pretest to three orthogonal axis. The worst case emissions were reported.

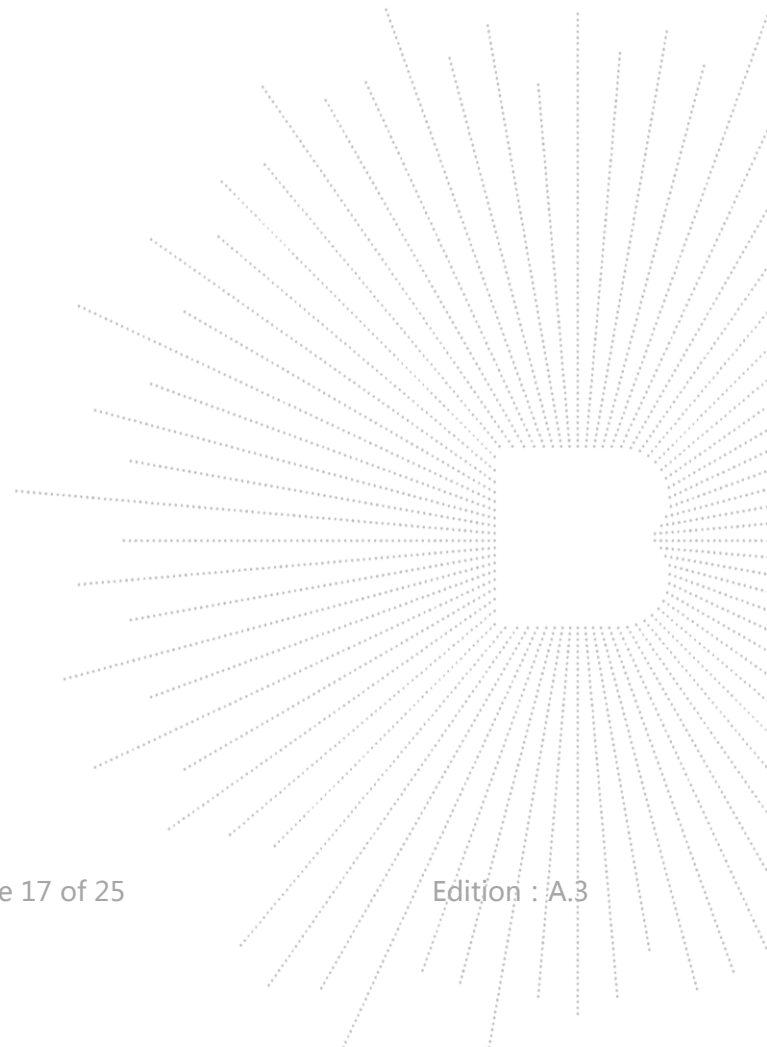

7.4 Test Result

9kHz-30MHz

Temperature:	26°C	Relative Humidity:	24%
Pressure:	101 kPa	Test Voltage :	AC 120V/60Hz
Test Mode :	Mode 1	Polarization :	--

Frequency (kHz)	Meter Reading (dB μ V)	Factor (dB)	Emission Level (dB μ V/m)	Limits (dB μ V/m)	Margin (dB)	Detector Type
24.7000	36.47	20.15	56.62	139.75	-83.13	PK
24.7000	32.35	20.15	52.50	119.75	-67.25	AV
65.6000	49.59	20.33	69.92	131.71	-61.79	PK
65.6000	44.34	20.33	64.67	111.71	-47.04	AV
123.7000	58.66	20.55	79.21	125.76	-46.55	PK
123.7000	53.78	20.55	74.33	105.76	-31.43	AV
649.2000	31.39	20.64	52.03	71.36	-19.33	QP
964.8000	34.03	21.26	55.29	67.92	-12.63	QP
1287.8300	25.65	22.32	47.97	65.41	-17.44	QP

Note:

Pre-scan in the all of mode, the worst case in of was recorded.

Factor = antenna factor + cable loss – pre-amplifier.

Margin = Emission Level- Limit.

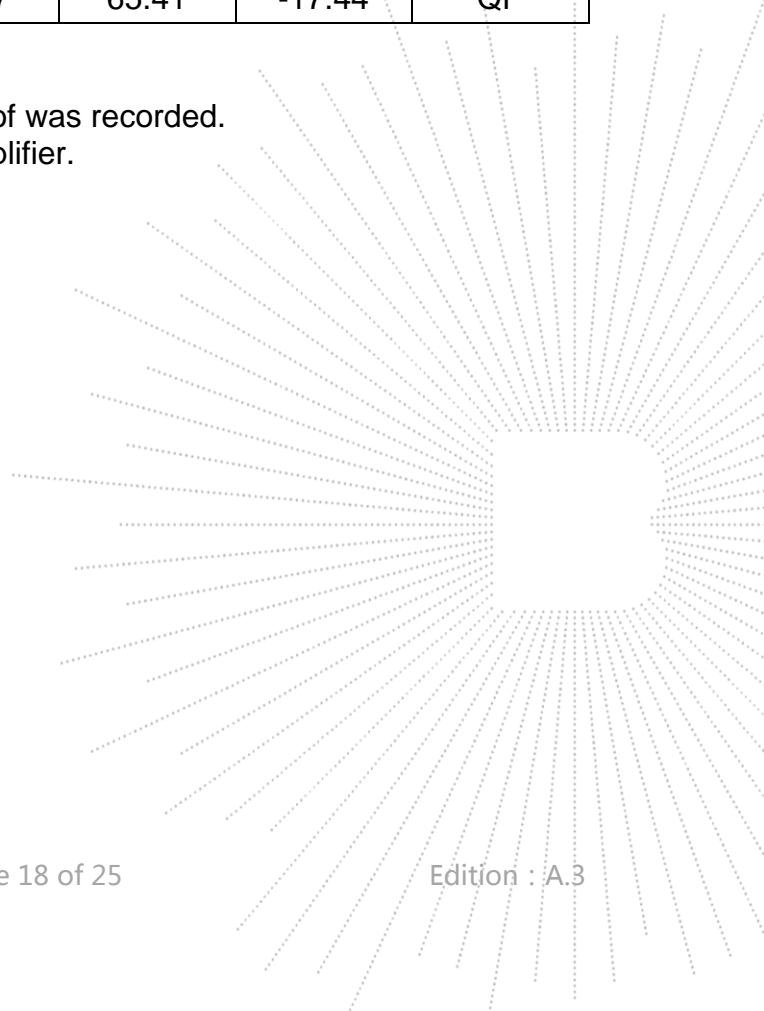

Between 30MHz – 1GHz

Temperature:	26°C	Relative Humidity:	54%
Pressure:	101 kPa	Test Voltage :	AC 120V/60Hz
Test Mode :	Mode 1	Polarization :	Horizontal

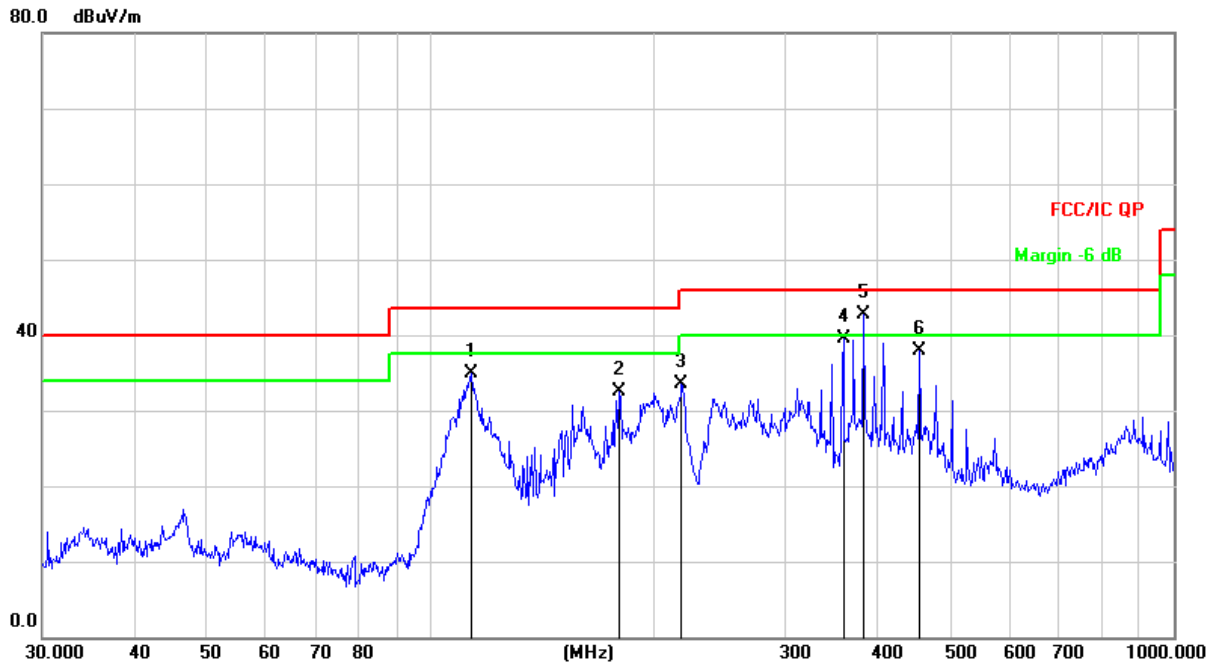

Remark:

Factor = Antenna Factor + Cable Loss – Pre-amplifier.

No.	Mk.	Freq.	Reading Level	Correct Factor	Measurement	Limit	Over	Detector
		MHz	dBuV	dB	dBuV/m	dB/m	dB	
1		113.3163	51.28	-16.33	34.95	43.50	-8.55	QP
2		179.3863	49.28	-16.68	32.60	43.50	-10.90	QP
3		217.5443	48.32	-14.90	33.42	46.00	-12.58	QP
4		359.1860	50.24	-10.81	39.43	46.00	-6.57	QP
5	*	382.5879	52.86	-10.16	42.70	46.00	-3.30	QP
6		454.3100	46.40	-8.53	37.87	46.00	-8.13	QP

Temperature:	26°C	Relative Humidity:	54%
Pressure:	101 kpa	Test Voltage :	AC 120V/60Hz
Test Mode :	Mode 1	Polarization :	Vertical

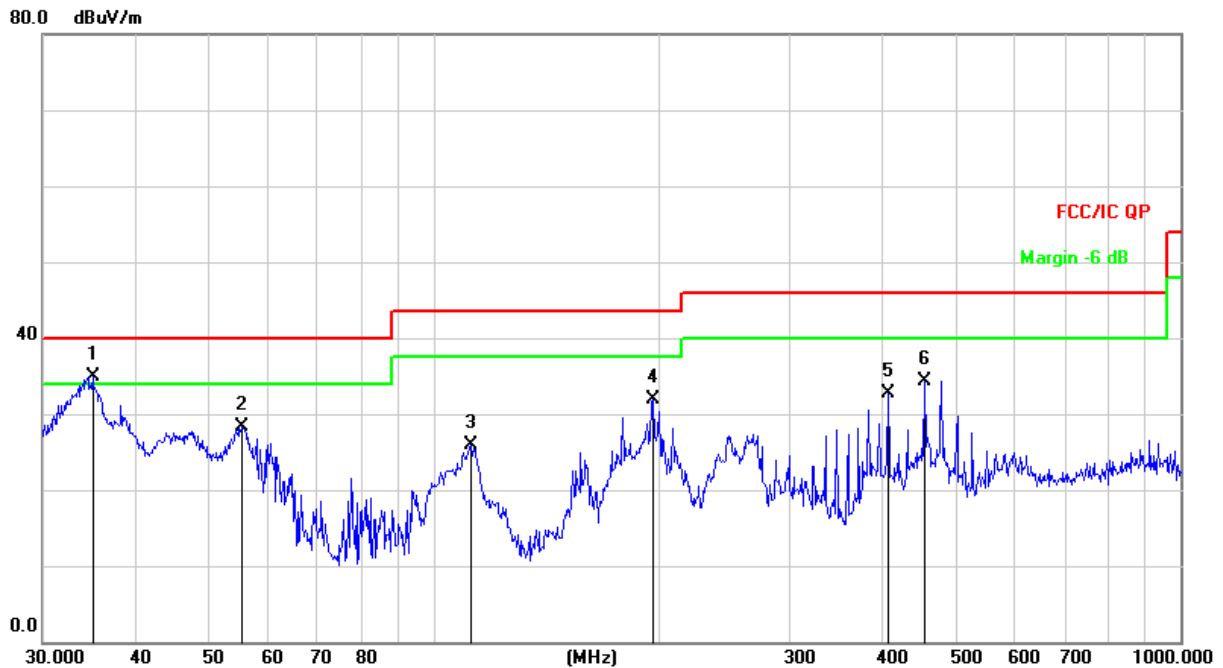

Remark:

Factor = Antenna Factor + Cable Loss – Pre-amplifier.

No.	Mk.	Freq. MHz	Reading Level dBuV	Correct Factor dB	Measure- ment dBuV/m	Limit dB/m	Over dB	Detector
1	*	35.0048	50.36	-15.52	34.84	40.00	-5.16	QP
2		55.4147	42.75	-14.39	28.36	40.00	-11.64	QP
3		112.5244	42.27	-16.28	25.99	43.50	-17.51	QP
4		197.2001	47.36	-15.45	31.91	43.50	-11.59	QP
5		406.0880	42.27	-9.55	32.72	46.00	-13.28	QP
6		454.3100	42.80	-8.53	34.27	46.00	-11.73	QP

8. EUT PHOTOGRAPHS

EUT Photo 1



EUT Photo 2



EUT Photo 3



EUT Photo 4



9. EUT TEST SETUP PHOTOGRAPHS

Conducted emissions

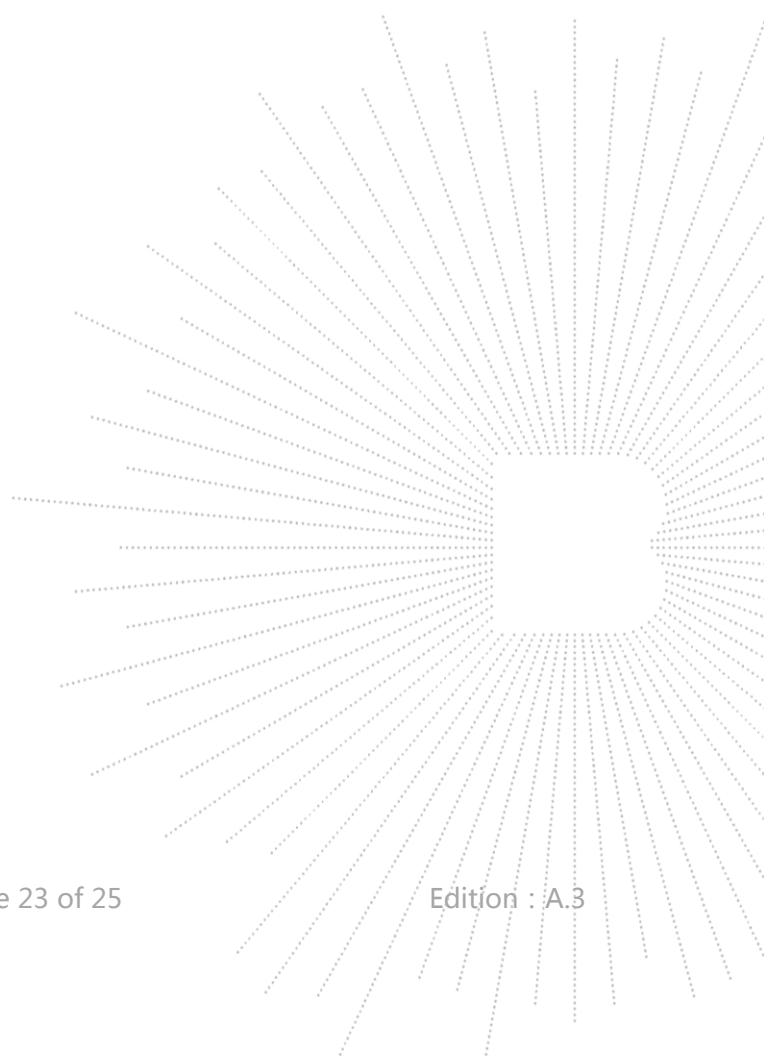

Radiated Measurement Photos

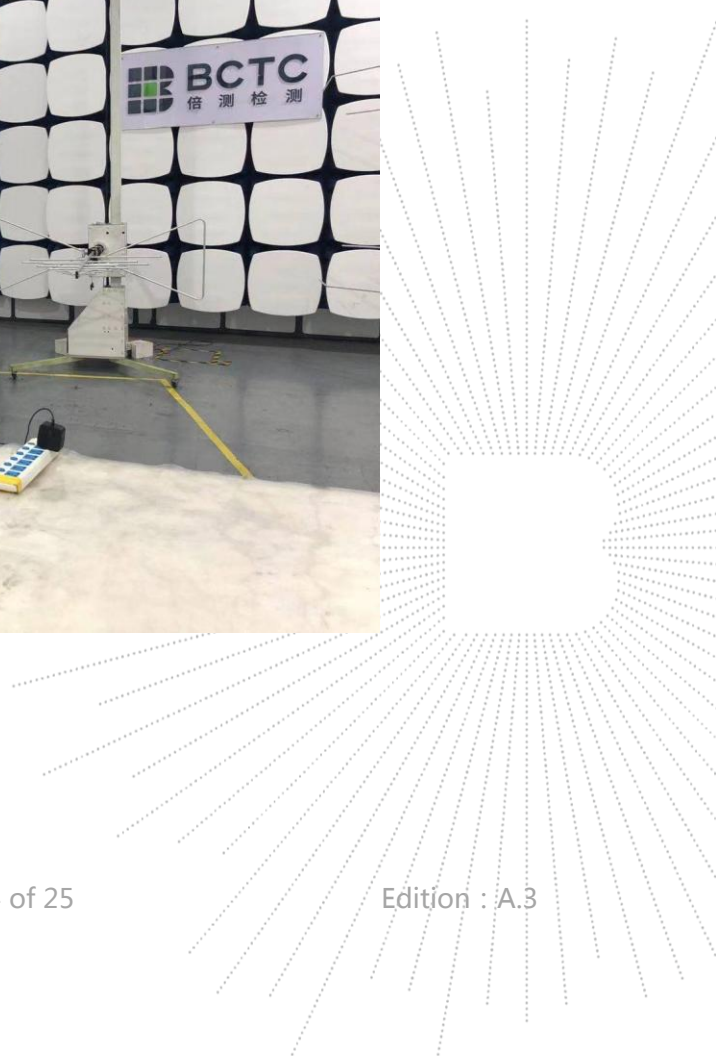
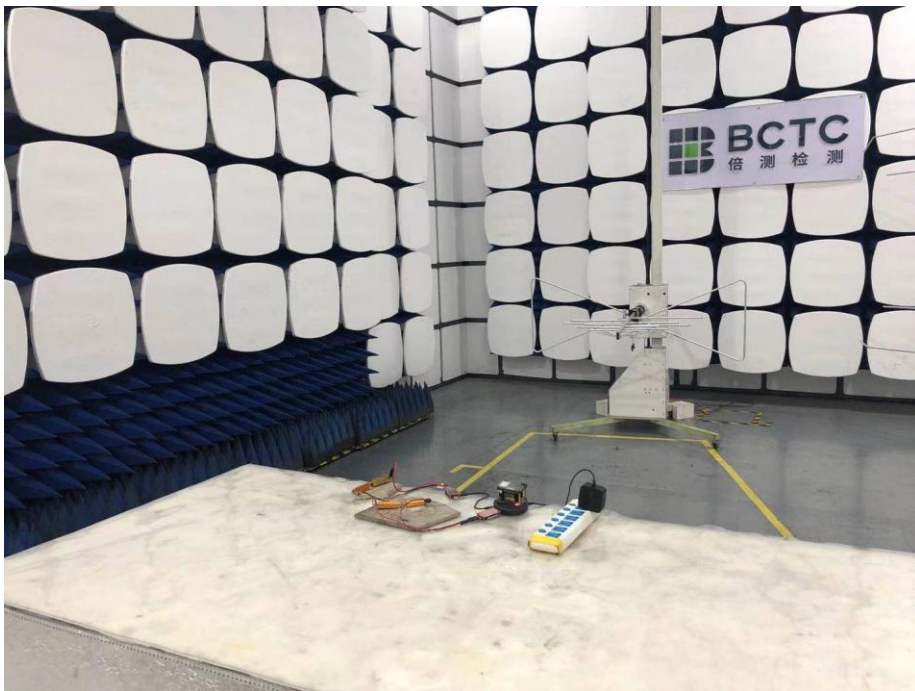

STATEMENT

- 1.The equipment lists are traceable to the national reference standards.
- 2.The test report can not be partially copied unless prior written approval is issued from our lab.
- 3.The test report is invalid without stamp of laboratory.
- 4.The test report is invalid without signature of person(s) testing and authorizing.
- 5.The test process and test result is only related to the Unit Under Test.
- 6.The quality system of our laboratory is in accordance with ISO/IEC17025.
- 7.If there is any objection to report, the client should inform issuing laboratory within 15 days from the date of receiving test report.

Address:

1-2/F., Building B, Pengzhou Industrial Park, No.158, Fuyuan 1st Road, Tangwei, Fuhai Subdistrict, Bao'an District, Shenzhen, Guangdong, China

TEL : 400-788-9558

P.C.: 518103

FAX : 0755-33229357

Website : <http://www.bctc-lab.com>

E-Mail : bctc@bctc-lab.com.cn

***** END *****

