



SAR (Specific Absorption Rate) Evaluation Report

Report No.: 14-12-MAS-081



Client: **Keysight Technologies Malaysia Sdn. Bhd.**
 Product: **Remote Logging Display**
 Model: **U1115A**
 FCC ID: **2ACWAU1115A**
 Manufacturer/supplier: **Keysight Technologies Malaysia Sdn. Bhd.**
 Standard: **FCC CFR 47 Part 2.1093.**
 IEEE 1528-2013
 ANSI/IEEE C95.1-2005

Date test item received: 2014/12/09
 Date test campaign completed: 2015/03/19
 Date of issue: 2015/03/20
 Test Result: Compliance Not Compliance

Statement of Compliance:
 The SAR values measured for the test sample are below the maximum recommended level of 1.6 W/kg averaged over any 1g tissue according to FCC KDB 447498 SAR Measurement .

The test result only corresponds to the tested sample. It is not permitted to copy this report, in part or in full, without the permission of the test laboratory.

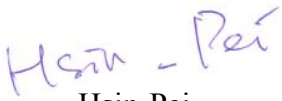
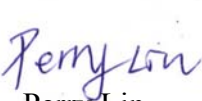
Total number of pages of this test report: 63 pages
Total number of pages of photos: Construction photos 9 pages

Test Engineer	Checked by	Approved by
 Hsin-Pei	 Perry Lin	 James Cheng

The testing described in this report has been carried out to the best of our knowledge and ability, and our responsibility is limited to the exercise of reasonable care. This certification is not intended to believe the sellers from their legal and/or contractual obligations.

Applicant Information

Client : Keysight Technologies Malaysia Sdn. Bhd.
Address : Bayan Lepas Free Industrial Zone, 11900 Penang, Malaysia
Manufacturer : Keysight Technologies Malaysia Sdn. Bhd.
Address : Bayan Lepas Free Industrial Zone, 11900 Penang, Malaysia
EUT : Remote Logging Display
Model No. : U1115A
Standard Applied : IEEE 1528 - 2013 IEEE Recommended Practices for Determining the Peak Spatial - Average Specific Absorption Rate(SAR) in the Human Head from Wireless Communications Devices :Measurement Techniques
Title 47 – Telecommunication : Part 2.1093 Radiofrequency radiation exposure evaluation : portable devices.
FCC KDB 447498 D01 General Exposure Guidance v05r02
FCC KDB 865664 D01 SAR Measurement 100MHz to 6 GHz v01r03
Test Location : Electronics Testing Center, Taiwan (www.etc.org.tw)
No.8, Lane 29, Wenming Rd. Guishan Dist. Taoyuan City 33383, Taiwan R.O.C.

Table of Contents

STATEMENT OF COMPLIANCE 5

1 GENERAL INFORMATION 6

1.1 Description of Equipment Under Test 6

1.2 Photograph of EUT 6

1.3 Environment Conditions 7

1.4 Test Standards 7

 1.4.1 RF Exposure Limits (According to ECR 1999/519/EC)..... 7

1.5 The SAR Measurement Procedure for Portable..... 8

 1.5.1 General Requirements 8

 1.5.2 Phantom Requirements 8

 1.5.3 Test Positions 8

 1.5.4 Test Procedures 8

2 DESCRIPTION OF THE TEST EQUIPMENT 9

2.1 Test Equipment List 9

2.2 DASY4 Measurement System Diagram 10

2.3 DASY4 Measurement Server..... 12

2.4 DAE (Data Acquisition Electronics)..... 13

2.5 Phantom..... 14

2.6 Device Holder 15

2.7 Specifications of Probes 15

2.8 Measurement Procedures in DASY4 16

2.9 Simulating Liquids 16

2.10 System Performance Check 17

 2.10.1 Purpose..... 17

 2.10.2 System Performance Check Setup 17

 2.10.3 Result of System Performance Check 17

 2.10.4 Conducted Average Power Results 18

3 RESULTS 19

3.1 The maximum of the SAR numbers..... 19

3.2 2450 MHz Body Test Results(DH 5)..... 19

3.3 Measurement Position 20

 3.3.1 The front of EUT position..... 20

 3.3.2 The side of EUT position 20

 3.3.3 The top of EUT position 21

4 DESCRIPTION OF THE TEST PROCEDURE 22

4.1 Scan Procedure..... 22

4.2 SAR Averaging Methods 22

4.3 Data Storage 22

4.4 Data Evaluation..... 23

5 MEASUREMENT UNCERTAINTY (300MHz~3GHz) 25

6 REFERENCES 26

7 ANNEX : TEST RESULTS OF DASY4 (REFER TO ANNEX)ANNEX..... 27

Statement of Compliance

The maximum results of Specific Absorption Rate (SAR) found during testing for Keysight Technologies Malaysia Sdn. Bhd.;DUT: Remote Logging Display; Model Name: U1115A are as follows.

<Highest Reported standalone SAR Summary>

Exposure Position	Frequency Band	Highest Reported 1g-SAR (W/kg)	Equipment Class
Body (0 cm Gap)	Bluetooth 2.4GHz	0.319	DSS

Remark:

The highest simultaneous transmission is scalar summation of reported standalone SAR per FCC KDB 690783 D01 v01r03, and scalar SAR summation of all possible simultaneous transmission scenarios are <1.6W/kg.

This device is in compliance with Specific Absorption Rate (SAR) for general population/uncontrolled exposure limits (1.6 W/kg) specified in FCC 47 CFR part 2 (2.1093) and ANSI/IEEE C95.1-2005, and had been tested in accordance with the measurement methods and procedures specified in IEEE 1528-2013.

The measurements according to FCC KDB447498 [Reference 4] for evaluating compliance with requirements of FCC Report and Order 96-326 [Reference 3].

1 General Information

1.1 Description of Equipment Under Test

ID EUT Type	Remote Logging Display
IC EUT Type	Remote Logging Display
Model Name	U1115A
Hardware version	N/A
Software version	N/A
Tx Frequency	2402 ~ 2480 MHz
Rx Frequency	2402 ~ 2480 MHz
Antenna Type	Chip antenna
Conducted Average Power	15.86 dBm
Device Category	Portable
RF Exposure Environment	General Population / Uncontrolled
Power supply	4.5V dc (2A Battery * 3)
Crest Factor	1
Uplink Modulations	Bluetooth BDR (1Mbps) : GFSK Bluetooth EDR (2Mbps) : $\pi/4$ -DQPSK Bluetooth EDR (3Mbps) : 8-DPSK

1.2 Photograph of EUT

Please refer to Appendix A

1.3 Environment Conditions

Item	Target	Measured
Ambient Temperature (°C)	15 ~ 30	24 ± 1
Temperature of Simulant (°C)	20 ~ 24	24 ± 1
Relative Humidity(% RH)	30 ~ 70	60 ~ 70

1.4 Test Standards

The Specific Absorption Rate (SAR) testing specification, method, and procedure for this device is in accordance with the following standards:

- FCC 47 CFR Part 2 (2.1093)
- ANSI/IEEE C95.1-2005
- IEEE 1528-2013
- FCC KDB 447498 D01 v05r02
- FCC KDB 865664 D01 v01r03
- FCC KDB 865664 D02 v01r01

According to the FCC order “Guidelines for Evaluating the Environmental Effects of RF Radiation”, for consumer products, the SAR limit is **1.6W/kg** for an uncontrolled environment and **8.0W/kg** for an occupational/controlled environment. The equipment under test should be evaluated at maximum output power (radiated from the antenna) under “worst-case” conditions for intended or normal operation, incorporating normal antenna operating positions, equipment under test peak performance frequencies and positions for maximum RF power coupling.

1.4.1 RF Exposure Limits (According to ECR 1999/519/EC)

	Whole-Body	Partial-Body	Arms and Legs
Population/Uncontrolled Environments (W/kg)	0.08	1.6	4.0
Occupational/Controlled Environments (W/kg)	0.4	8.0	20.0

Notes:

1. Population/Uncontrolled Environments: Locations where there is the exposure of individuals who have no sense or control of their exposure.
2. Occupational/Controlled Environments: Locations where there is exposure that may be incurred by people who have knowledge of the potential for exposure.
3. Whole-Body: SAR is averaged over the entire body.
4. Partial-Body: SAR is averaged over any 1g of tissue volume as defined in specification.
5. Arms and Legs: SAR is averaged over 10g of tissue volume as defined in specification.

1.5 The SAR Measurement Procedure for Portable

1.5.1 General Requirements

The test should be performance in a laboratory without influence on SAR measurements by ambient RF sources and any reflection from the environment inside. The ambient temperature should be kept in the range of 18°C to 25°C with a maximum variation within $\pm 2^\circ\text{C}$ during the test.

1.5.2 Phantom Requirements

The phantoms used in test are simplified representations of the human head and body as a specific shaped container for the head or body simulating liquids. The physical characteristics of the phantom models should resemble the head and the body of a mobile user since the shape is a dominant parameter for exposure. The shell of the phantom should be made of low loss and low permittivity material and the thickness tolerance should be less than 0.2 mm. In addition, the phantoms should provide simulations of both right and left hand operations.

1.5.3 Test Positions

Due to there are basically six planes in the base unit under test. There are front side, back side, right side, left side and bottom side respectively.

1.5.4 Test Procedures

The SAR test should be performed with five test positions as mentioned above. To use the center frequency of each available operating band to apply SAR measurements on six test positions via a data package connection set-up with a bluetooth simulator.

During Bluetooth SAR testing EUT is configured with the Bluetooth continuous TX tool, and the transmission duty factor was monitored on the spectrum analyzer with zero-span setting Duty factor observed as below:

For Bluetooth SAR testing, Bluetooth engineering testing software installed on the EUT can provide continuous transmitting RF signal.

2 Description of the Test Equipment

The measurements were performed using an automated near-field scanning system, DASY4 software, manufactured by Schmid & Partner Engineering AG (SPEAG) in Switzerland. The SAR extrapolation algorithm used in all measurements on the test device was the ‘worst case extrapolation’ algorithm.

2.1 Test Equipment List

Equipment	Manufacturer	Model No.	S/N	Calibration Date	Next Calibration Date
Robot	Staubli	RX90B L	F03/5W16A1/A/01	(not necessary)	(not necessary)
Robot Controller	Staubli	CS7MB	F03/5W16A1/C/01	(not necessary)	(not necessary)
Teach Pendant	Staubli	----	D221340061	(not necessary)	(not necessary)
DAE4	Schmid & Partner Engineering AG	----	629	2015-01-26	2016-01-25
E-field Probe	Schmid & Partner Engineering AG	EX3DV4	3578	2014-06-24	2015-06-23
Dipole Validation Kit	Schmid & Partner Engineering AG	D2450V2	869	2014-06-13	2016-06-12
CBT Bluetooth Test	Rohde & Schwarz	CBT	13059403-001	2014-04-29	2015-04-28
Universal Radio Communication Tester	Rohde & Schwarz	CMU200	13059401-001	2013-05-09	2015-05-08
Directional Coupler	Amplifier Research	DC7420	310569	2014-09-15	2015-09-14
DASY4 Software	Schmid & Partner Engineering AG	----	Version 4.6B23	To automatically control the robot and perform the SAR measurement	To automatically control the robot and perform the SAR measurement
SEMCAD Software	Schmid & Partner Engineering AG	----	Version 1.8B160	Post-processing and report management	Post-processing and report management
Signal Generator	Agilent	83640B	3844A01143	2014-09-17	2015-09-16
Amplifier	Mini-Circuits	ZHL-42W	D111704-01-02	2014-09-22	2015-09-21
Power Meter	BOONTON	4532-0102	136601	2014-06-20	2015-06-19
S-Parameter Network Analyzer	Agilent	8753ES	MY40001340	2014-04-03	2015-04-02
Calibration Kit	Agilent	85033C	2920A03287	(not necessary)	(not necessary)
Dielectric Probe Kit	Agilent	85070E	MY44300101	(not necessary)	(not necessary)

2.2 DASY4 Measurement System Diagram

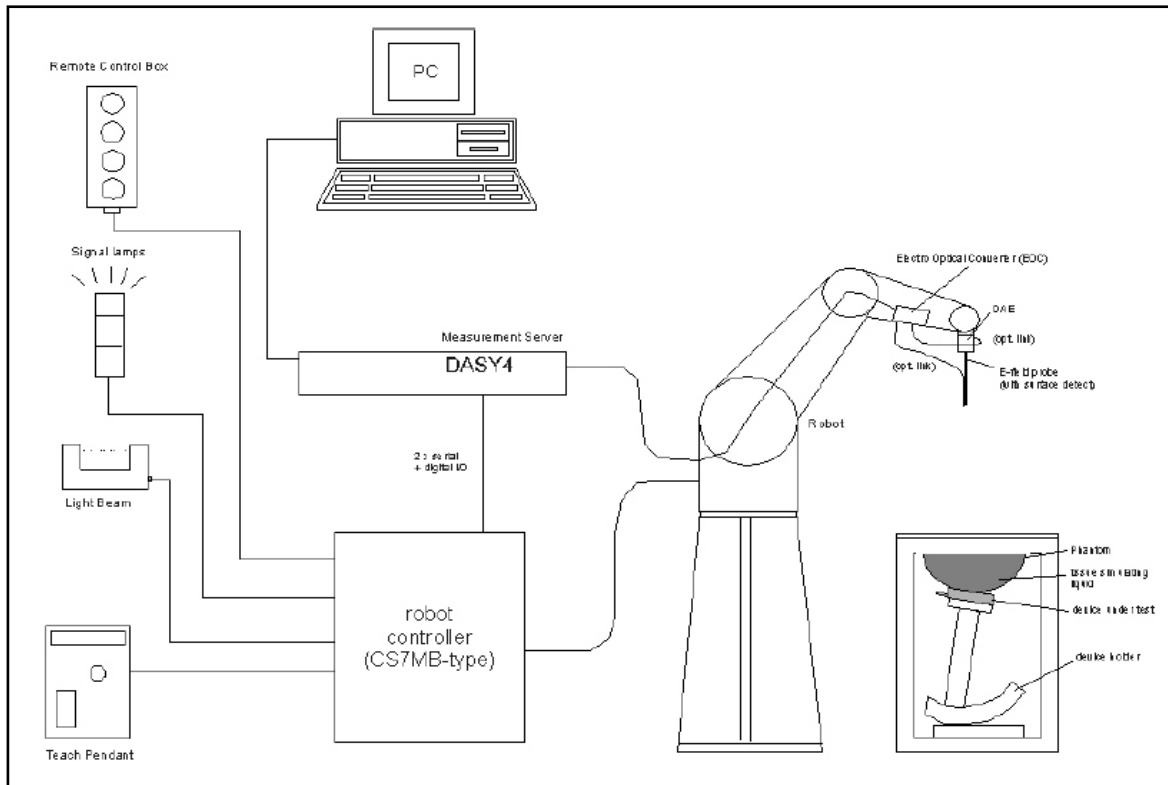

Fig. 4 The DASY4 Measurement System



Fig. 5 The DASY4 System Photo

The DASY4 system consists of the following items:

- A fixed-on-ground high precision 6-axis robot with controller and software and an arm extension for moving the Data Acquisition Electronics (DAE) and Probe.
- A dosimetric probe, an isotropic E-field probe optimized and calibrated for usage in head or body tissue simulating liquids. Some of the probes are equipped with an optical surface detector system.
- A Data Acquisition Electronic (DAE) performing the signal amplification, signal multiplexing, AD-conversion, offset measurements, mechanical surface detection, collision detection, etc. DAE is powered with standard or rechargeable batteries. The signal is optically transmitted to the EOC.
- A unit to operate the optical surface detector which is connected to Electro-Optical Coupler (EOC).
- The EOC performs the conversion from the optical into a digital electric signal of the DAE. The EOC is connected to the DASY4 measurement server.
- The DASY4 measurement server performing all real-time data evaluation for field measurements and surface detection, controlling robot movements and handling safety operation. A computer with operating Windows 2000 is used for server.
- DASY4 software and SEMCAD data evaluation software are installed in PC.
- Remote control with teach panel and additional circuitry for robot safety such as warning lamps, etc.
- The generic twin phantom enabling the testing of left-hand and right-hand usage.
- The device holder for handheld mobile phones.
- Tissue simulating liquid mixed well according to the given recipes.
- System validation dipoles is used to validate the proper functioning of the system

2.3 DASY4 Measurement Server



Fig. 6 DASY4 Measurement Server

The DASY4 measurement server is based on a PC/104 CPU board with a 166MHz low-power pentium, 32MB chipdisk and 64MB RAM. The necessary circuits for communication with either the DAE4 (or DAE3) electronic box as well as the 16-bit AD-converter system for optical detection and digital I/O interface are contained on the DASY4 I/O-board, which is directly connected to the PC/104 bus of the CPU board.

The measurement server performs all real-time data evaluation for field measurements and surface detection, controls robot movements and handles safety operation. The PC-operating system cannot interfere with these time critical processes. All connections are supervised by a watchdog, and disconnection of any of the cables to the measurement server will automatically disarm the robot and disable all program-controlled robot movements. Furthermore, the measurement server is equipped with two expansion slots which are reserved for future applications. Please note that the expansion slots do not have a standardized pinout and therefore only the expansion cards provided by SPEAG can be inserted. Expansion cards from any other supplier could seriously damage the measurement server.

2.4 DAE (Data Acquisition Electronics)



Fig. 7 DAE Photo

Some probes are equipped with an optical multifiber line, ending at the front of the probe tip. This line is connected to the EOC box on the robot arm and provides automatic detection of the phantom surface. Half of the fibers are connected to a pulsed infrared transmitter, the other half to a synchronized receiver. If the probe approaches the surface, the reflection from the surface produces a coupling from the transmitting to the receiving fibers. This reflection increases during the approach, reaches a maximum and then decreases. If the probe perpendicularly touches the surface, the coupling is zero. The distance of the coupling maximum to the surface is independent of the surface reflectivity and largely independent of the surface to probe angle. The DASY4 software reads the reflection during a software approach and looks for the maximum using a 2nd order fitting. The approach is stopped upon reaching the maximum.

The optical surface detection works in transparent liquids and on diffuse reflecting surfaces with a repeatability of better than ± 0.1 mm. The distance of the maximum depends on the fiber and the surrounding media. It is typically 1.0mm to 2.0mm in tissue simulating mixtures. The distance can be measured with the surface check job (described in the reference guide).

2.5 Phantom

SAM Twin Phantom V4.0:

The phantom used for all tests i.e. for both system performances was checking and device testing was the twinheaded "SAM Twin Phantom V4.0", manufactured by SPEAG. The phantom conforms to the requirements of IEEE 1528 - 2013.

SAM Phantom ELI4:

Phantom for compliance testing of handheld and body mounted wireless devices in the frequency range of 30 MHz to 6 GHz. ELI4 is fully compatible with the latest draft of the standard IEC 62209-2. ELI4 has been optimized regarding its performance and can be integrated into our standard phantom tables. A cover prevents evaporation of the liquid.



Fig. 8 SAM Twin Phantom and ELI4 Phantom

2.6 Device Holder

The device was placed in the device holder (illustrated below) that is supplied by SPEAG as an integrated part of the Dasy system.



Fig. 9 Device holder supplied by SPEAG

2.7 Specifications of Probes

The E-Field Probes EX3DV4, manufactured and calibrated annually by Schmid & Partner Engineering AG with following specification are used for the dosimetric measurements.

EX3DV4:

- Dynamic range: $10 \mu\text{W/g} \sim 100 \text{mW/g}$
- Tip diameter: 2.5 mm
- Probe linearity: $\pm 0.2 \text{ dB}$ (30MHz to 3 GHz)
- Axial isotropy: $\pm 0.2 \text{ dB}$
- Spherical isotropy: $\pm 0.4 \text{ dB}$
- Distance from probe tip to dipole centers: 1.0 mm
- Calibration range: 900MHz/1750MHz/1900MHz/2000MHz/2450MHz for head simulating liquid and 5200MHz/5800MHz for head and body simulating liquids.

2.8 Measurement Procedures in DASY4

Step 1

Establish a call in EUT at the maximum power level with a base station simulator via air interface.

Step 2

To measure the local E-field value at a fixed location which value will be taken as a reference value for calculating a possible power drift.

Step 3

To measure the SAR distribution with a grid with spacing of 15 mm x 15 mm and kept with a constant distance to the inner surface of the phantom. Additional all peaks within 3 dB of the maximum SAR are searched.

Step 4

At these points (maximum number of SAR peaks is two), a cube of 32 mm x 32 mm x 30 mm is applied to and measured with 5 x 5 x 7 points. With these measured data, a peak spatial-average SAR value can be calculated by SEMCAD software.

Step 5

Repetition of the E-field measurement at the fixed location mentioned in Step 1 to make sure the two results differ by less than ± 0.2 dB.

2.9 Simulating Liquids

Liquid Recipe for this test report is as following:

2450 MHz band

Ingredient	% by weight
Water	73.2
Diethylene Glycol Butyl Ether(DGBE)	26.7
Salt	0.1
Sugar	0.0

2.10 System Performance Check

2.10.1 Purpose

1. To verify the simulating liquids are valid for testing.
2. To verify the performance of testing system is valid for testing.

2.10.2 System Performance Check Setup

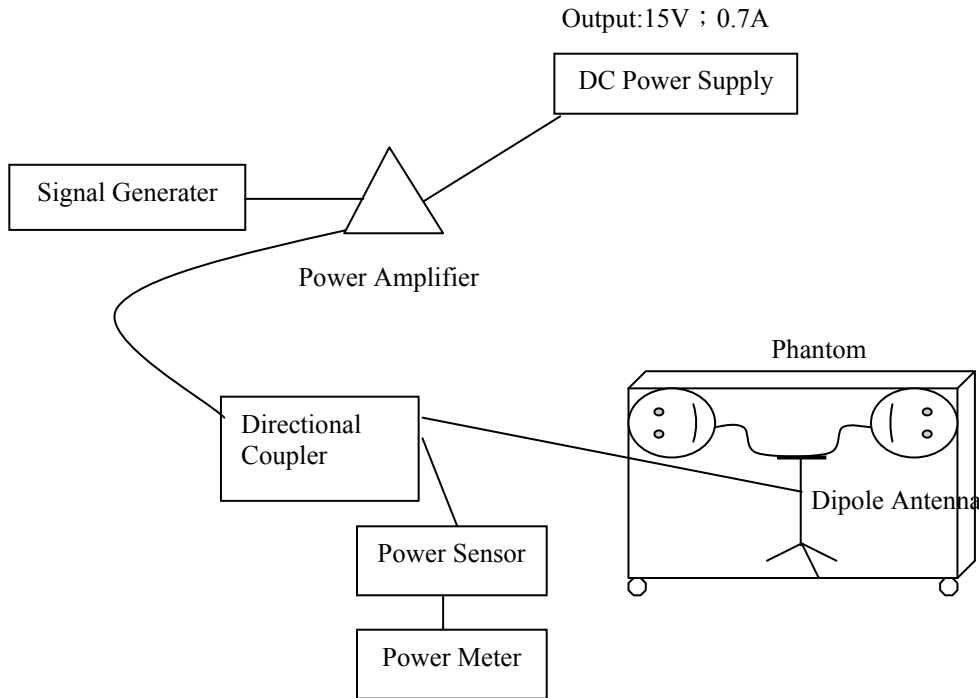

Note :

1. Power Meter is used to make sure whether the input power is 250mW for reference signal.
2. Power Amplifier is used to input the measured power to dipole antenna.

2.10.3 Result of System Performance Check

Diepole Antenna: D2450V2 (S/N: 869)

Date of Measurement And Reference Value	SAR@1g [W/kg]	Dielectric Parameters		Temperature [°C]
		ϵ_r	σ [S/m]	
Body 2450MHz Recommended Value	13.1 ± 10% [11.79~14.41]	51 ± 5% [48.45~53.55]	2.01 ± 5% [1.9095~2.1105]	22.0 ± 2 [20 ~ 24]
2015/3/18	12.9	50.7	2.02	22

2.10.4 Conducted Average Power Results

Modulation type \ Bit rate		Channel	Frequency	Power(dBm)
GFSK \ 1Mbps	DH1	00	2402	10.56
		39	2441	11.78
		78	2480	11.03
	DH3	00	2402	13.60
		39	2441	14.80
		78	2480	14.10
	DH5	00	2402	14.16
		39	2441	15.86
		78	2480	15.11
$\pi/4$ DQPSK \ 2Mbps	2DH1	00	2402	1.88
		39	2441	2.86
		78	2480	1.71
	2DH3	00	2402	4.57
		39	2441	5.54
		78	2480	4.42
	2DH5	00	2402	5.11
		39	2441	6.09
		78	2480	4.92
8DPSK \ 3Mbps	3DH1	00	2402	1.88
		39	2441	2.83
		78	2480	1.78
	3DH3	00	2402	4.60
		39	2441	5.51
		78	2480	4.34
	3DH5	00	2402	5.14
		39	2441	6.09
		78	2480	4.93

Note: The test data reported are the worst-case SAR values according to test procedures specified in IEEE 1528-2013, FCC KDB Procedure.

3 Results

3.1 The maximum of the SAR numbers

Frequency		Measurement Position (Flat)	Conducted Power (dBm)			SAR@1g [W/kg]	Power Drift (dB)	Note
CH	MHz		Before	After	Drift			
39	2441	Front	15.86	15.88	0.2	0.123	0.014	

No deviations from the technical specification(s) were ascertained in the course of the tests performed.	<input checked="" type="checkbox"/>
The deviations as specified in this chapter were ascertained in the course of the tests performed.	<input type="checkbox"/>

3.2 2450 MHz Body Test Results(DH 5)

Frequency		Measurement Position (Flat)	Conducted Power (dBm)			SAR@1g [W/kg]	Power Drift (dB)	Note
CH	MHz		Before	After	Drift			
39	2441	Top	15.86	15.87	0.1	0.00954	0.016	
39	2441	Bottom	15.86	15.87	0.1	0.079	0.019	
39	2441	Front	15.86	15.88	0.2	0.123	0.014	Worst
39	2441	Back	15.86	15.85	-0.1	0.052	0.013	
39	2441	Right	15.86	15.86	0.0	0.015	0.011	
39	2441	Left	15.86	15.87	0.1	0.056	0.016	

Average power measurement result for the scaled

Frequency	EMC Power	SAR Power	Tune up					Measured SAR	Scaled SAR
			Target	Tolerance		Maximum	Minimum		
				+	-				
2441	15.86	15.86	17.00	3.00	3.00	20.00	14.00	0.123	0.319

The Max Body SAR@2441MHz@1g was **0.319 W/kg**, less than limitation of 1.6 W/kg. According to KDB 447498 D01 v05r02 section 4.3_SAR test reduction considerations: The Max Body SAR@2441MHz was 0.319 W/kg for 1-g ≤ 0.4 W/kg for 1-g Therefore, it's not necessary to test other frequencies.

3.3 Measurement Position

3.3.1 The front of EUT position

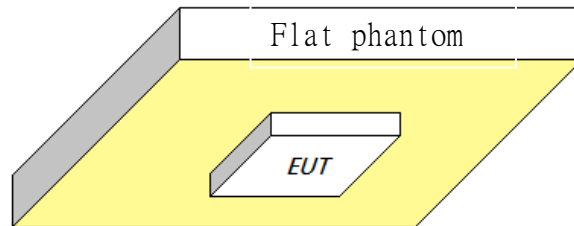

3.3.2 The side of EUT position

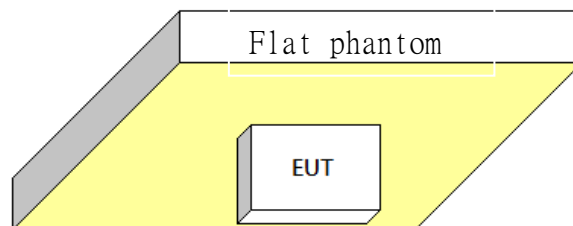

3.3.3 The top of EUT position

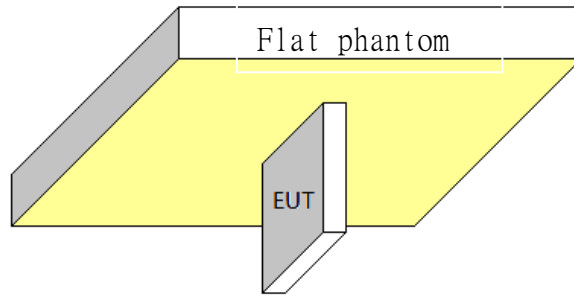

4 Description of the Test Procedure

4.1 Scan Procedure

First coarse scans were used for determination of the field distribution. Next a cube scan, 5x5x7 points covering a volume of 32x32x30mm was performed around the highest E-field value to determine the averaged SAR value. Drift was determined by measuring the same point at the start of the coarse scan and again at the end of the cube scan.

According to the test standard, the recommended procedure for assessing the peak spatial-average SAR value consists of the following steps:

- (a) Power reference measurement
- (b) Area scan
- (c) Zoom scan
- (d) Power drift measurement
- (e) Z-Scan

4.2 SAR Averaging Methods

The maximum SAR value was averaged over a cube of tissue using interpolation and extrapolation. The interpolation, extrapolation and maximum search routines within Dasy4 are all based on the modified Quadratic Shepard's method (Robert J. Renka, "Multivariate Interpolation Of Large Sets Of Scattered Data", University of North Texas ACM Transactions on Mathematical Software, vol. 14, no. 2, June 1988, pp. 139-148).

The interpolation scheme combines a least-square fitted function method with a weighted average method. A trivariate 3-D / bivariate 2-D quadratic function is computed for each measurement point and fitted to neighboring points by a least-square method. For the cube scan, inverse distance weighting is incorporated to fit distant points more accurately. The interpolating function is finally calculated as a weighted average of the quadratics. In the cube scan, the interpolation function is used to extrapolate the Peak SAR from the deepest measurement points to the inner surface of the phantom.

4.3 Data Storage

The DASY4 software stores the assessed data from the data acquisition electronics as raw data (in microvolt readings from the probe sensors), together with all the necessary software parameters for the data evaluation (probe calibration data, liquid parameters and device frequency and modulation data) in measurement files with the extension .DA4. The postprocessing software evaluates the desired unit and format for output each time the data is visualized or exported. This allows verification of the complete software setup even after the measurement and allows correction of erroneous parameter settings.

The measured data can be visualized or exported in different units or formats, depending on the selected probe type (e.g., [V/m], [A/m] or [W/kg]). Some of these units are not available in certain situations or give meaningless results, e.g., a SAR-output in a lossless media will always be zero. Raw data can also be exported to perform the evaluation with other software packages.

4.4 Data Evaluation

The DASY4 postprocessing software (SEMCAD) automatically executes the following procedures to calculate the field units from the microvolt readings at the probe connector. The parameters used in the evaluation are stored in the configuration modules of the software:

Probe parameters:	- Sensitivity	$Norm_i, a_{i0}, a_{i1}, a_{i2}$
	- Conversion factor	$ConvF_i$
	- Diode compression point	dcp_i
Device parameters:	- Frequency	f
	- Crest factor	cf
Media parameters:	- Conductivity	σ
	- Density	ρ

These parameters must be set correctly in the software. They can be found in the component documents or they can be imported into the software from the configuration files issued for the DASY components. In the direct measuring mode of the multimeter option, the parameters of the actual system setup are used. In the scan visualization and export modes, the parameters stored in the corresponding document files are used.

The first step of the evaluation is a linearization of the filtered input signal to account for the compression characteristics of the detector diode. The compensation depends on the input signal, the diode type and the DC-transmission factor from the diode to the evaluation electronics. If the exciting field is pulsed, the crest factor of the signal must be known to correctly compensate for peak power. The formula for each channel can be given as:

$$V_i = U_i + U_i^2 \cdot \frac{cf}{dcp_i} \quad (20.1)$$

with V_i	= compensated signal of channel i	(i = x, y, z)
U_i	= input signal of channel i	(i = x, y, z)
cf	= crest factor of exciting field	(DASY parameter)
dcp_i	= diode compression point	(DASY parameter)

From the compensated input signals the primary field data for each channel can be evaluated:

$$\begin{aligned} \text{E - fieldprobes :} \quad E_i &= \sqrt{\frac{V_i}{Norm_i \cdot ConvF}} \\ \text{H - fieldprobes :} \quad H_i &= \sqrt{V_i} \cdot \frac{a_{i0} + a_{i1}f + a_{i2}f^2}{f} \end{aligned}$$

with	V_i	= compensated signal of channel i	(i = x, y, z)
	$Norm_i$	= sensor sensitivity of channel i	(i = x, y, z)
		$\mu\text{V}/(\text{V}/\text{m})^2$ for E-field Probes	
	$ConvF$	= sensitivity enhancement in solution	
	a_{ij}	= sensor sensitivity factors for H-field probes	
	f	= carrier frequency [GHz]	
	E_i	= electric field strength of channel i in V/m	
	H_i	= magnetic field strength of channel i in A/m	

The RSS value of the field components gives the total field strength (Hermitian magnitude):

$$E_{tot} = \sqrt{E_x^2 + E_y^2 + E_z^2}$$

The primary field data are used to calculate the derived field units.

$$SAR = E_{tot}^2 \cdot \frac{\sigma}{\rho \cdot 1'000}$$

with	SAR	= local specific absorption rate in mW/g
	E_{tot}	= total field strength in V/m
	σ	= conductivity in [mho/m] or [Siemens/m]
	ρ	= equivalent tissue density in g/cm ³

Note that the density is set to 1, to account for actual head tissue density rather than the density of the tissue simulating liquid.

5 Measurement Uncertainty (300MHz~3GHz)

According to KDB 865664 D01 SAR Measurement 100 MHz to 6 GHz, when the highest measured 1-g SAR within a frequency band is < 1.5 W/kg, the extensive SAR measurement uncertainty analysis described in IEEE Std 1528-2013 is not required in SAR reports.

6 References

1. [IEEE Std C95.1-2005]

Safety Levels with Respect to Human Exposure to Radio Frequency Electromagnetic Fields, 3 kHz to 300 GHz. The Institute of Electrical and Electronics Engineers, Inc. (IEEE), 2005.

2. [IEEE Std C95.3-1992]

Recommended Practice for the Measurement of Potentially Hazardous Electromagnetic Fields - RF and Microwave". The Institute of Electrical and Electronics Engineers, Inc. (IEEE), 1992.

3. [FCC Report and Order 96-326]

Federal Communications Commission, "Report and order: Guidelines for evaluating the environmental effects of radiofrequency radiation", Tech. Rep. FCC 96-326, 1996.

4. [FCC KDB 447498 D01 General RF Exposure Guidance v05r002]

Additional Information for Evaluating Compliance of Mobile and Portable Device with FCC Limits for Human Exposure to Radiofrequency Emissions. KDB 447498v05r02 SAR Measurement. Federal Communications Commission (FCC), Office of Engineering & Technology. (OET)

5. [DASY 4]

Schmid & Partner Engineering AG: DASY 4 Manual, September 2005.

6. [IEEE 1528-2013]

IEEE Std 1528-2013: IEEE Recommended Practice for Determining the Peak Spatial-Average Specific Absorption Rate (SAR) in the Human Head from Wireless Communications Devices: Measurement Techniques. IEEE Std 1528-2013, The Institute of Electrical and Electronics Engineers, Inc. (IEEE).

7. [RSS-102, Issue 4]

Radio Standards Specification 102, Radio Frequency Exposure Compliance of Radiocommunication Apparatus (All Frequency Bands) sets out the requirements and measurement techniques used to evaluate radio frequency (RF) exposure compliance of radiocommunication apparatus designed to be used within the vicinity of the human body. March, 2010. Industry Canada.

8. [Health Canada Safety Code 6]

Canada's Safety Code 6: Limits of Human Exposure to Radiofrequency Electromagnetic Fields in the Frequency Range from 3 kHz to 300 GHz (99-EHD-237)

10. [e-CFR title 47 Telecommunication]

Title 47 – Telecommunication : Part 2.1093 Radiofrequency radiation exposure evaluation : portable devices.

7 Annex : Test Results of DAS4 (Refer to ANNEX)ANNEX

Index of Annex

ANNEX A: SAR RESULTS.....	28
ANNEX B: DIPOLE CERTIFICATE.....	40
ANNEX C: PROBE CERTIFICATE.....	48

ANNEX A: SAR RESULTS

System Performance Check Body

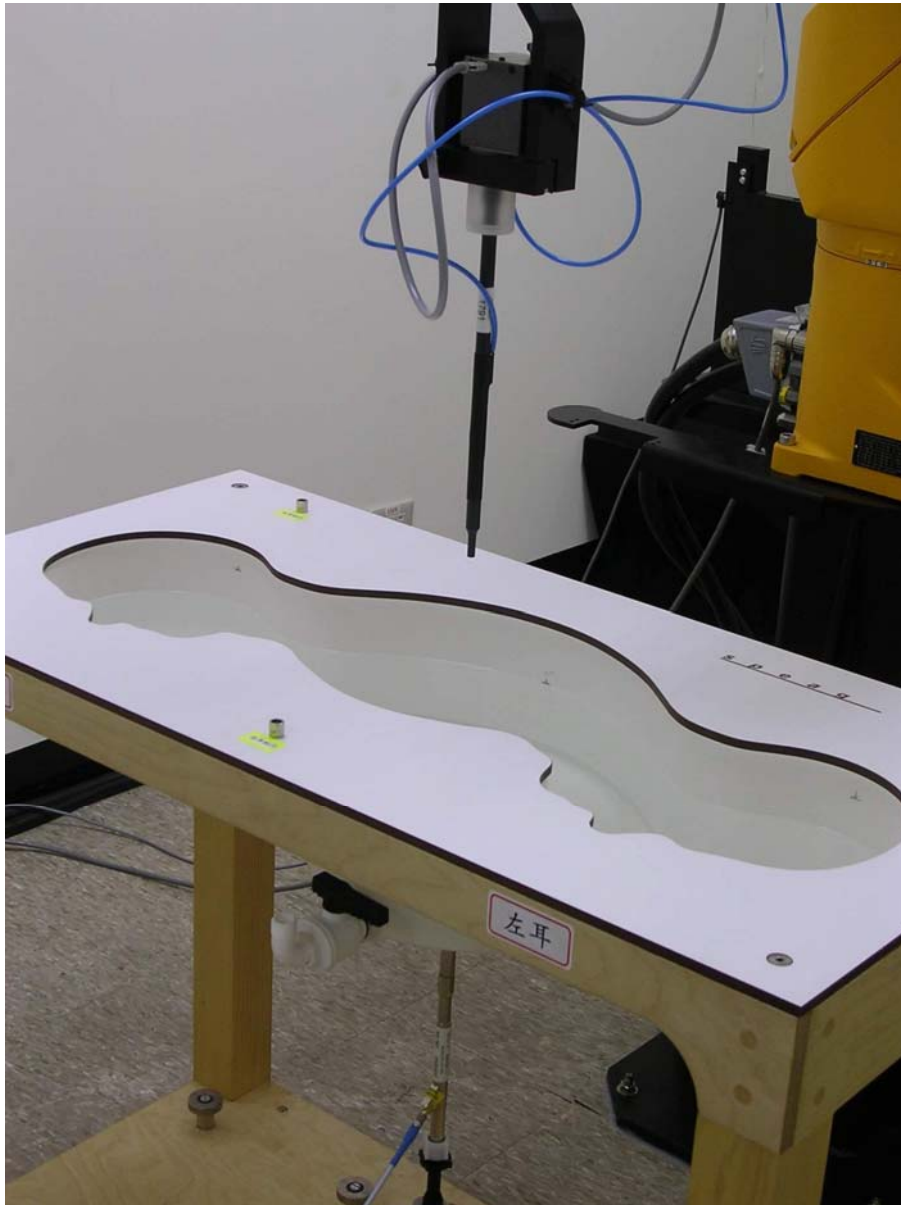

Date/Time: 2015/3/18 08:45:43

Test Laboratory: Electronics Testing Center, Taiwan
File Name: [SPC22.da4](#)**DUT: Dipole 2450 MHz; Type: D2450V2; Serial: D2450V2 - SN:764**

Communication System: CW; Frequency: 2450 MHz; Duty Cycle: 1:1

Medium parameters used: $f = 2450$ MHz; $\sigma = 2.02$ mho/m; $\epsilon_r = 50.7$; $\rho = 1000$ kg/m³

Phantom section: Flat Section

DASY4 Configuration:

- Probe: EX3DV4 - SN3578; ConvF(6.42, 6.42, 6.42); Calibrated: 2014/6/24
- Sensor-Surface: 4mm (Mechanical Surface Detection) Sensor-Surface: 0mm (Fix Surface)
- Electronics: DAE4 Sn629; Calibrated: 2015/1/26
- Phantom: SAM 12-2; Type: SAM4.0; Serial: TP-1347
- Measurement SW: DASY4, V4.7 Build 80; Postprocessing SW: SEMCAD, V1.8 Build 186

SPC 2/Zoom Scan (7x7x7)/Cube 0: Measurement grid: dx=5mm, dy=5mm, dz=5mm

Reference Value = 85.4 V/m; Power Drift = 0.013 dB

Peak SAR (extrapolated) = 28.2 W/kg

SAR(1 g) = 12.9 mW/g; SAR(10 g) = 5.83 mW/g

Maximum value of SAR (measured) = 14.9 mW/g

SPC 2/Area Scan (31x81x1): Measurement grid: dx=12mm, dy=12mm

Maximum value of SAR (interpolated) = 18.2 mW/g

SPC 2/Z Scan (1x1x21): Measurement grid: dx=20mm, dy=20mm, dz=5mm

Maximum value of Total (measured) = 68.1 V/m

Maximum value of SAR (measured) = 9.36 mW/g

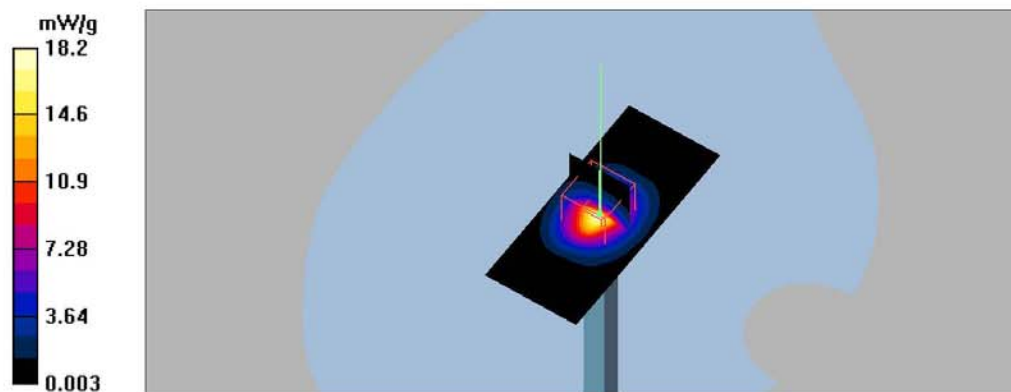

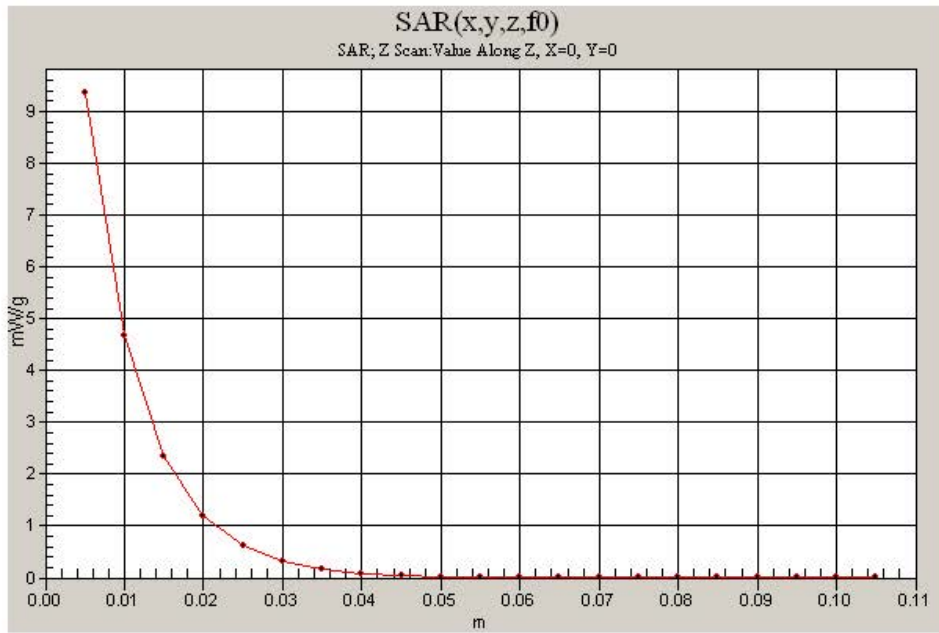

Body

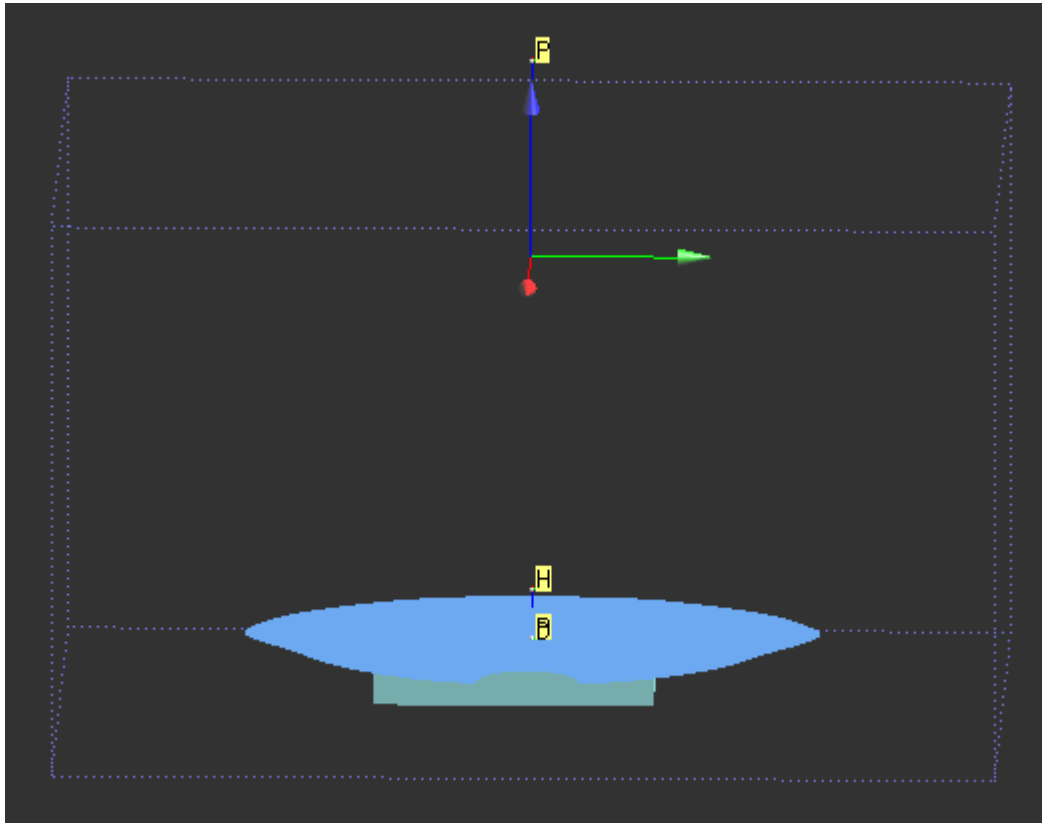

Date/Time: 2015/3/18 15:23:36

Test Laboratory: Electronics Testing Center, Taiwan
File Name: [Top + Bottom22.da4](#)

Communication System: BT; Frequency: 2441 MHz; Duty Cycle: 1:1
Medium parameters used: $f = 2441$ MHz; $\sigma = 1.91$ mho/m; $\epsilon_r = 49.5$; $\rho = 1000$ kg/m³
Phantom section: Flat Section

DASY4 Configuration:

- Probe: EX3DV4 - SN3578; ConvF(6.42, 6.42, 6.42); Calibrated: 2014/6/24
- Sensor-Surface: 4mm (Mechanical Surface Detection) Sensor-Surface: 0mm (Fix Surface)
- Electronics: DAE4 Sn629; Calibrated: 2015/1/26
- Phantom: SAM 12-2; Type: SAM4.0; Serial: TP-1347
- Measurement SW: DASY4, V4.7 Build 80; Postprocessing SW: SEMCAD, V1.8 Build 186

Top/Zoom Scan (7x7x7)/Cube 0: Measurement grid: dx=5mm, dy=5mm, dz=5mm

Reference Value = 1.08 V/m; Power Drift = 0.016 dB

Peak SAR (extrapolated) = 0.017 W/kg

SAR(1 g) = 0.00954 mW/g; SAR(10 g) = 0.00467 mW/g

Maximum value of SAR (measured) = 0.011 mW/g

Top/Z Scan (1x1x21): Measurement grid: dx=20mm, dy=20mm, dz=5mm

Maximum value of Total (measured) = 1.93 V/m

Top/Area Scan (91x101x1): Measurement grid: dx=12mm, dy=12mm

Maximum value of SAR (interpolated) = 0.023 mW/g

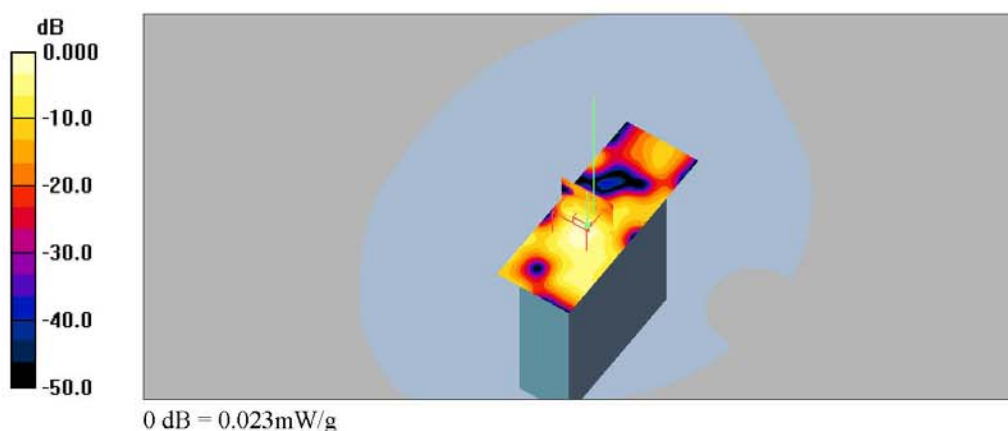

Date/Time: 2015/3/18 15:45:44

Test Laboratory: Electronics Testing Center, Taiwan
File Name: [Top + Bottom22.da4](#)

Communication System: BT; Frequency: 2441 MHz; Duty Cycle: 1:1
Medium parameters used: $f = 2441$ MHz; $\sigma = 1.91$ mho/m; $\epsilon_r = 49.5$; $\rho = 1000$ kg/m³
Phantom section: Flat Section

DASY4 Configuration:

- Probe: EX3DV4 - SN3578; ConvF(6.42, 6.42, 6.42); Calibrated: 2014/6/24
- Sensor-Surface: 4mm (Mechanical Surface Detection) Sensor-Surface: 0mm (Fix Surface)
- Electronics: DAE4 Sn629; Calibrated: 2015/1/26
- Phantom: SAM 12-2; Type: SAM4.0; Serial: TP-1347
- Measurement SW: DASY4, V4.7 Build 80; Postprocessing SW: SEMCAD, V1.8 Build 186

Bottom/Zoom Scan (7x7x7)/Cube 0: Measurement grid: dx=5mm, dy=5mm, dz=5mm
Reference Value = 4.11 V/m; Power Drift = 0.019 dB
Peak SAR (extrapolated) = 0.180 W/kg
SAR(1 g) = 0.079 mW/g; SAR(10 g) = 0.038 mW/g
Maximum value of SAR (measured) = 0.086 mW/g

Bottom/Z Scan (1x1x21): Measurement grid: dx=20mm, dy=20mm, dz=5mm
Maximum value of Total (measured) = 3.52 V/m

Bottom/Area Scan (41x101x1): Measurement grid: dx=12mm, dy=12mm
Maximum value of SAR (interpolated) = 0.084 mW/g

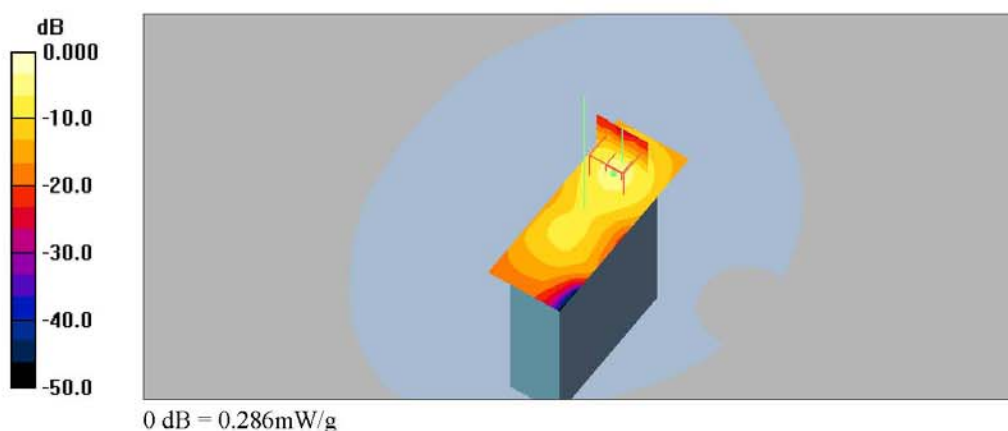

Date/Time: 2015/3/18 11:15:44

Test Laboratory: Electronics Testing Center,Taiwan
File Name: [Front+Back22.da4](#)

Communication System: BT; Frequency: 2441 MHz;Duty Cycle: 1:1
Medium parameters used: $f = 2441$ MHz; $\sigma = 1.91$ mho/m; $\epsilon_r = 49.5$; $\rho = 1000$ kg/m³
Phantom section: Flat Section

DASY4 Configuration:

- Probe: EX3DV4 - SN3578; ConvF(6.42, 6.42, 6.42); Calibrated: 2014/6/24
- Sensor-Surface: 4mm (Mechanical Surface Detection)Sensor-Surface: 0mm (Fix Surface)
- Electronics: DAE4 Sn629; Calibrated: 2015/1/26
- Phantom: SAM 12-2; Type: SAM4.0; Serial: TP-1347
- Measurement SW: DASY4, V4.7 Build 80; Postprocessing SW: SEMCAD, V1.8 Build 186

Front Medium/Zoom Scan (7x7x7)/Cube 0: Measurement grid: dx=5mm, dy=5mm, dz=5mm
Reference Value = 3.45 V/m; Power Drift = 0.014 dB
Peak SAR (extrapolated) = 0.242 W/kg
SAR(1 g) = 0.123 mW/g; SAR(10 g) = 0.063 mW/g
Maximum value of SAR (measured) = 0.132 mW/g

Front Medium/Z Scan (1x1x21): Measurement grid: dx=20mm, dy=20mm, dz=5mm
Maximum value of Total (measured) = 3.02 V/m

Front Medium/Area Scan (91x101x1): Measurement grid: dx=12mm, dy=12mm
Maximum value of SAR (interpolated) = 0.152 mW/g

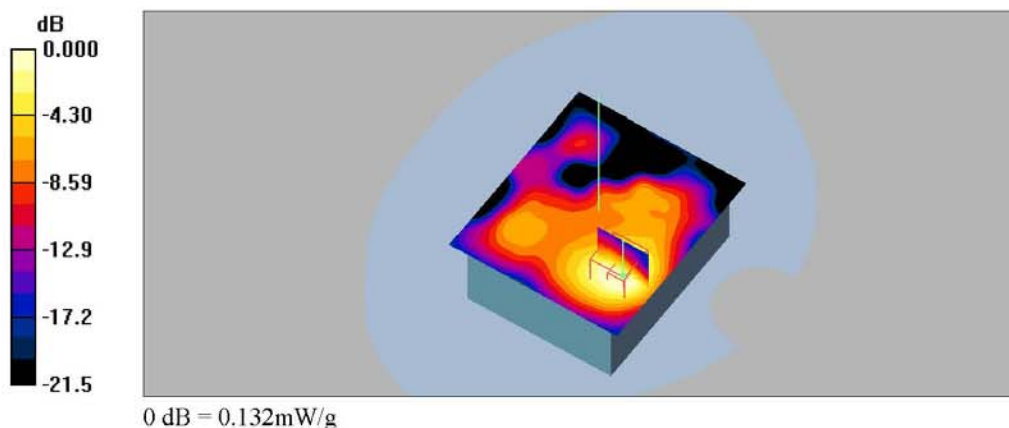

Date/Time: 2015/1/5 13:44:54

Test Laboratory: Electronics Testing Center,Taiwan
File Name: Front+Back22.da4

Communication System: BT; Frequency: 2441 MHz;Duty Cycle: 1:1
Medium parameters used: $f = 2441$ MHz; $\sigma = 1.91$ mho/m; $\epsilon_r = 49.5$; $\rho = 1000$ kg/m³
Phantom section: Flat Section

DASY4 Configuration:

- Probe: EX3DV4 - SN3578; ConvF(6.42, 6.42, 6.42); Calibrated: 2014/6/24
- Sensor-Surface: 4mm (Mechanical Surface Detection)Sensor-Surface: 0mm (Fix Surface)
- Electronics: DAE4 Sn629; Calibrated: 2015/1/26
- Phantom: SAM 12-2; Type: SAM4.0; Serial: TP-1347
- Measurement SW: DASY4, V4.7 Build 80; Postprocessing SW: SEMCAD, V1.8 Build 186

Back/Area Scan (91x101x1): Measurement grid: dx=12mm, dy=12mm
Maximum value of SAR (interpolated) = 0.059 mW/g

Back/Z Scan (1x1x21): Measurement grid: dx=20mm, dy=20mm, dz=5mm
Maximum value of Total (measured) = 2.15 V/m

Back/Zoom Scan (7x7x7)/Cube 0: Measurement grid: dx=5mm, dy=5mm, dz=5mm
Reference Value = 2.06 V/m; Power Drift = 0.013 dB
Peak SAR (extrapolated) = 0.103 W/kg
SAR(1 g) = 0.052 mW/g; SAR(10 g) = 0.026 mW/g
Maximum value of SAR (measured) = 0.057 mW/g

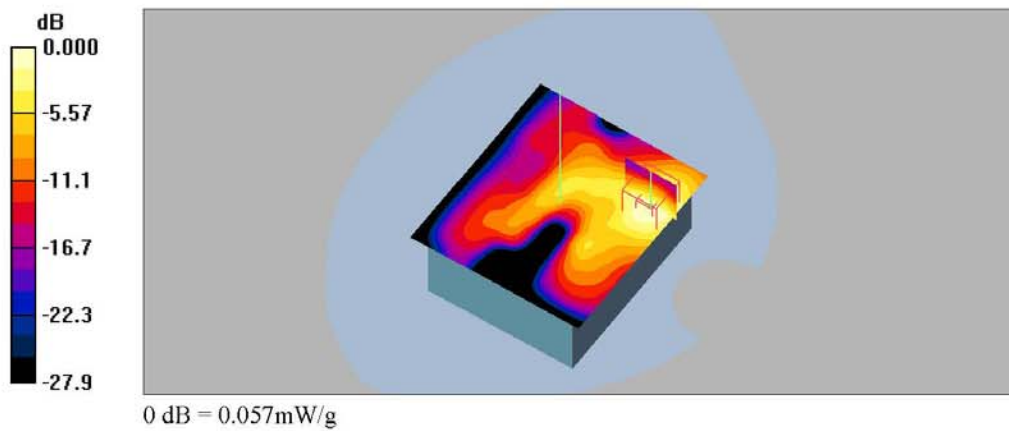

Date/Time: 2015/3/18 16:25:03

Test Laboratory: Electronics Testing Center, Taiwan
File Name: [Side22.da4](#)

Communication System: BT; Frequency: 2441 MHz; Duty Cycle: 1:1
Medium parameters used: $f = 2441$ MHz; $\sigma = 1.91$ mho/m; $\epsilon_r = 49.5$; $\rho = 1000$ kg/m³
Phantom section: Flat Section

DASY4 Configuration:

- Probe: EX3DV4 - SN3578; ConvF(6.42, 6.42, 6.42); Calibrated: 2014/6/24
- Sensor-Surface: 0mm (Fix Surface) Sensor-Surface: 4mm (Mechanical Surface Detection)
- Electronics: DAE4 Sn629; Calibrated: 2015/1/26
- Phantom: SAM 12-2; Type: SAM4.0; Serial: TP-1347
- Measurement SW: DASY4, V4.7 Build 80; Postprocessing SW: SEMCAD, V1.8 Build 186

Right Side/Z Scan (1x1x21): Measurement grid: dx=20mm, dy=20mm, dz=5mm
Maximum value of Total (measured) = 1.60 V/m

Right Side/Area Scan (41x11x1): Measurement grid: dx=12mm, dy=12mm
Maximum value of SAR (interpolated) = 0.019 mW/g

Right Side/Zoom Scan (7x7x7)/Cube 0: Measurement grid: dx=5mm, dy=5mm, dz=5mm
Reference Value = 1.74 V/m; Power Drift = 0.011 dB
Peak SAR (extrapolated) = 0.023 W/kg
SAR(1 g) = 0.015 mW/g; SAR(10 g) = 0.00747 mW/g

Maximum value of SAR (measured) = 0.017 mW/g

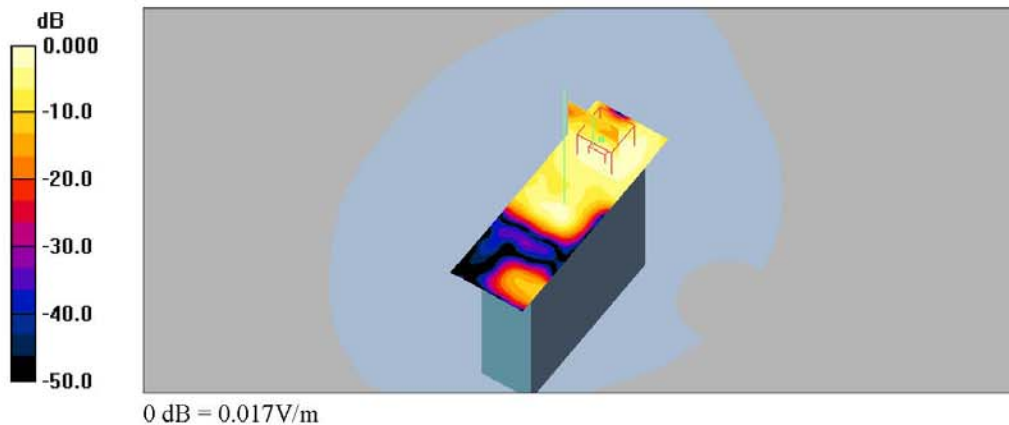

Date/Time: 2015/3/18 16:58:50

Test Laboratory: Electronics Testing Center, Taiwan
File Name: [Side22.da4](#)

Communication System: BT; Frequency: 2441 MHz; Duty Cycle: 1:1
Medium parameters used: $f = 2441$ MHz; $\sigma = 1.91$ mho/m; $\epsilon_r = 49.5$; $\rho = 1000$ kg/m³
Phantom section: Flat Section

DASY4 Configuration:

- Probe: EX3DV4 - SN3578; ConvF(6.42, 6.42, 6.42); Calibrated: 2014/6/24
- Sensor-Surface: 0mm (Fix Surface) Sensor-Surface: 4mm (Mechanical Surface Detection)
- Electronics: DAE4 Sn629; Calibrated: 2015/1/26
- Phantom: SAM 12-2; Type: SAM4.0; Serial: TP-1347
- Measurement SW: DASY4, V4.7 Build 80; Postprocessing SW: SEMCAD, V1.8 Build 186

Left Side/Z Scan (1x1x21): Measurement grid: dx=20mm, dy=20mm, dz=5mm
Maximum value of Total (measured) = 3.27 V/m

Left Side/Zoom Scan (7x7x7)/Cube 0: Measurement grid: dx=5mm, dy=5mm, dz=5mm
Reference Value = 3.53 V/m; Power Drift = 0.016 dB
Peak SAR (extrapolated) = 0.109 W/kg
SAR(1 g) = 0.056 mW/g; SAR(10 g) = 0.028 mW/g
Maximum value of SAR (measured) = 0.065 mW/g

Left Side/Area Scan (41x111x1): Measurement grid: dx=12mm, dy=12mm
Maximum value of SAR (interpolated) = 0.063 mW/g

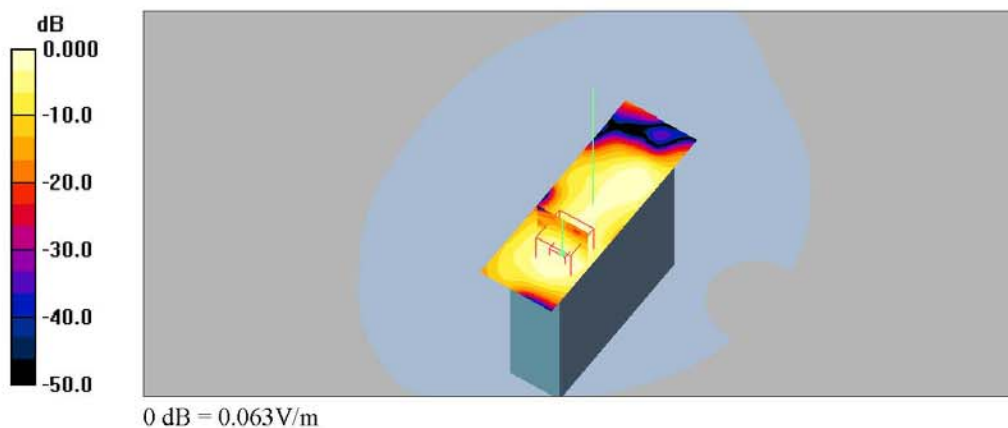

Date/Time: 2015/3/18 17:38:36

Test Laboratory: Electronics Testing Center, Taiwan
File Name: [Front+Back22.da4](#)

Communication System: BT; Frequency: 2402 MHz; Duty Cycle: 1:1
Medium parameters used: $f = 2402$ MHz; $\sigma = 1.9$ mho/m; $\epsilon_r = 49.7$; $\rho = 1000$ kg/m³
Phantom section: Flat Section

DASY4 Configuration:

- Probe: EX3DV4 - SN3578; ConvF(6.42, 6.42, 6.42); Calibrated: 2014/6/24
- Sensor-Surface: 0mm (Fix Surface) Sensor-Surface: 4mm (Mechanical Surface Detection)
- Electronics: DAE4 Sn629; Calibrated: 2015/1/26
- Phantom: SAM 12-2; Type: SAM4.0; Serial: TP-1347
- Measurement SW: DASY4, V4.7 Build 80; Postprocessing SW: SEMCAD, V1.8 Build 186

Front Low/Z Scan (1x1x21): Measurement grid: dx=20mm, dy=20mm, dz=5mm
Maximum value of Total (measured) = 4.21 V/m

Front Low/Area Scan (91x101x1): Measurement grid: dx=12mm, dy=12mm
Maximum value of SAR (interpolated) = 0.220 mW/g

Front Low/Zoom Scan (7x7x7)/Cube 0: Measurement grid: dx=5mm, dy=5mm, dz=5mm
Reference Value = 4.84 V/m; Power Drift = -0.016 dB
Peak SAR (extrapolated) = 0.344 W/kg
SAR(1 g) = 0.176 mW/g; SAR(10 g) = 0.092 mW/g
Maximum value of SAR (measured) = 0.192 mW/g

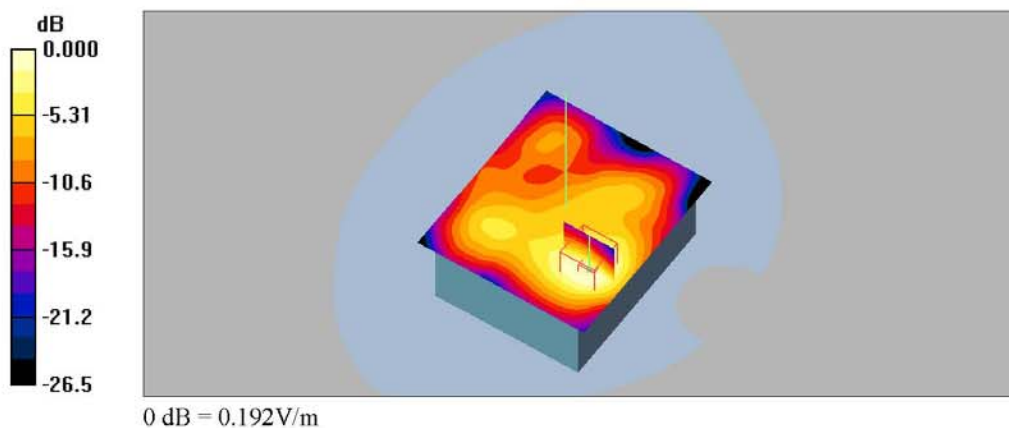

Date/Time: 2015/3/18 18:17:18

Test Laboratory: Electronics Testing Center, Taiwan
File Name: [Front + Back22.da4](#)

Communication System: BT; Frequency: 2480 MHz; Duty Cycle: 1:1
Medium parameters used: $f = 2480$ MHz; $\sigma = 1.91$ mho/m; $\epsilon_r = 49.3$; $\rho = 1000$ kg/m³
Phantom section: Flat Section

DASY4 Configuration:

- Probe: EX3DV4 - SN3578; ConvF(6.42, 6.42, 6.42); Calibrated: 2014/6/24
- Sensor-Surface: 4mm (Mechanical Surface Detection) Sensor-Surface: 0mm (Fix Surface)
- Electronics: DAE4 Sn629; Calibrated: 2015/1/26
- Phantom: SAM 12-2; Type: SAM4.0; Serial: TP-1347
- Measurement SW: DASY4, V4.7 Build 80; Postprocessing SW: SEMCAD, V1.8 Build 186

Front High/Area Scan (81x101x1): Measurement grid: dx=12mm, dy=12mm
Maximum value of SAR (interpolated) = 0.100 mW/g

Front High/Zoom Scan (7x7x7)/Cube 0: Measurement grid: dx=5mm, dy=5mm, dz=5mm
Reference Value = 1.98 V/m; Power Drift = 0.017 dB
Peak SAR (extrapolated) = 0.184 W/kg
SAR(1 g) = 0.091 mW/g; SAR(10 g) = 0.046 mW/g
Maximum value of SAR (measured) = 0.098 mW/g

Front High/Z Scan (1x1x21): Measurement grid: dx=20mm, dy=20mm, dz=5mm
Maximum value of Total (measured) = 1.57 V/m

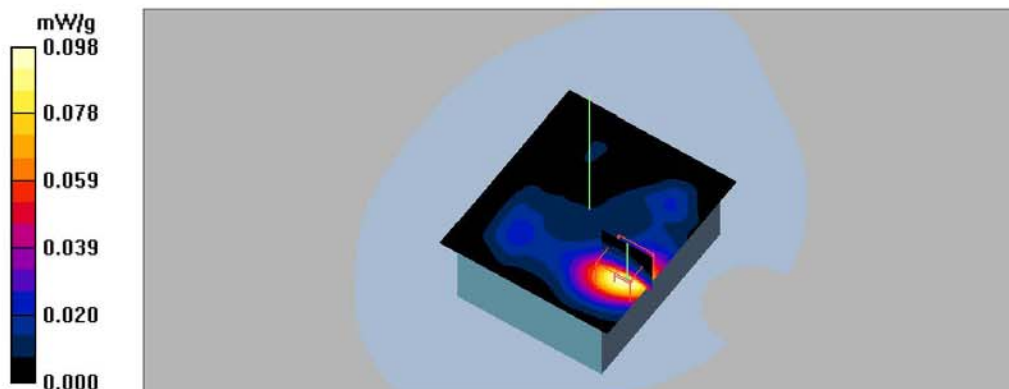

ANNEX B: DIPOLE CERTIFICATE

**Calibration Laboratory of
Schmid & Partner
Engineering AG**
Zeughausstrasse 43, 8004 Zurich, Switzerland



S Schweizerischer Kalibrierdienst
C Service suisse d'étalonnage
S Servizio svizzero di taratura
S Swiss Calibration Service

Accredited by the Swiss Accreditation Service (SAS)
The Swiss Accreditation Service is one of the signatories to the EA
Multilateral Agreement for the recognition of calibration certificates

Accreditation No.: **SCS 108**

Client **Auden**

Certificate No: **D2450V2-869_Jun14**

CALIBRATION CERTIFICATE																																															
Object	D2450V2 - SN: 869																																														
Calibration procedure(s)	QA CAL-05.v9 Calibration procedure for dipole validation kits above 700 MHz																																														
Calibration date:	June 13, 2014																																														
<p>This calibration certificate documents the traceability to national standards, which realize the physical units of measurements (SI). The measurements and the uncertainties with confidence probability are given on the following pages and are part of the certificate.</p> <p>All calibrations have been conducted in the closed laboratory facility: environment temperature (22 ± 3)°C and humidity < 70%.</p> <p>Calibration Equipment used (M&TE critical for calibration)</p> <table border="1" style="width: 100%; border-collapse: collapse;"> <thead> <tr> <th style="width: 30%;">Primary Standards</th> <th style="width: 15%;">ID #</th> <th style="width: 30%;">Cal Date (Certificate No.)</th> <th style="width: 25%;">Scheduled Calibration</th> </tr> </thead> <tbody> <tr> <td>Power meter EPM-442A</td> <td>GB37480704</td> <td>09-Oct-13 (No. 217-01827)</td> <td>Oct-14</td> </tr> <tr> <td>Power sensor HP 8481A</td> <td>US37292783</td> <td>09-Oct-13 (No. 217-01827)</td> <td>Oct-14</td> </tr> <tr> <td>Power sensor HP 8481A</td> <td>MY41092317</td> <td>09-Oct-13 (No. 217-01828)</td> <td>Oct-14</td> </tr> <tr> <td>Reference 20 dB Attenuator</td> <td>SN: 5058 (20k)</td> <td>03-Apr-14 (No. 217-01918)</td> <td>Apr-15</td> </tr> <tr> <td>Type-N mismatch combination</td> <td>SN: 5047.2 / 06327</td> <td>03-Apr-14 (No. 217-01921)</td> <td>Apr-15</td> </tr> <tr> <td>Reference Probe ES3DV3</td> <td>SN: 3205</td> <td>30-Dec-13 (No. ES3-3205_Dec13)</td> <td>Dec-14</td> </tr> <tr> <td>DAE4</td> <td>SN: 601</td> <td>30-Apr-14 (No. DAE4-601_Apr14)</td> <td>Apr-15</td> </tr> </tbody> </table> <table border="1" style="width: 100%; border-collapse: collapse;"> <thead> <tr> <th style="width: 30%;">Secondary Standards</th> <th style="width: 15%;">ID #</th> <th style="width: 30%;">Check Date (in house)</th> <th style="width: 25%;">Scheduled Check</th> </tr> </thead> <tbody> <tr> <td>RF generator R&S SMT-06</td> <td>100005</td> <td>04-Aug-99 (in house check Oct-13)</td> <td>In house check: Oct-16</td> </tr> <tr> <td>Network Analyzer HP 8753E</td> <td>US37390585 S4206</td> <td>18-Oct-01 (in house check Oct-13)</td> <td>In house check: Oct-14</td> </tr> </tbody> </table>				Primary Standards	ID #	Cal Date (Certificate No.)	Scheduled Calibration	Power meter EPM-442A	GB37480704	09-Oct-13 (No. 217-01827)	Oct-14	Power sensor HP 8481A	US37292783	09-Oct-13 (No. 217-01827)	Oct-14	Power sensor HP 8481A	MY41092317	09-Oct-13 (No. 217-01828)	Oct-14	Reference 20 dB Attenuator	SN: 5058 (20k)	03-Apr-14 (No. 217-01918)	Apr-15	Type-N mismatch combination	SN: 5047.2 / 06327	03-Apr-14 (No. 217-01921)	Apr-15	Reference Probe ES3DV3	SN: 3205	30-Dec-13 (No. ES3-3205_Dec13)	Dec-14	DAE4	SN: 601	30-Apr-14 (No. DAE4-601_Apr14)	Apr-15	Secondary Standards	ID #	Check Date (in house)	Scheduled Check	RF generator R&S SMT-06	100005	04-Aug-99 (in house check Oct-13)	In house check: Oct-16	Network Analyzer HP 8753E	US37390585 S4206	18-Oct-01 (in house check Oct-13)	In house check: Oct-14
Primary Standards	ID #	Cal Date (Certificate No.)	Scheduled Calibration																																												
Power meter EPM-442A	GB37480704	09-Oct-13 (No. 217-01827)	Oct-14																																												
Power sensor HP 8481A	US37292783	09-Oct-13 (No. 217-01827)	Oct-14																																												
Power sensor HP 8481A	MY41092317	09-Oct-13 (No. 217-01828)	Oct-14																																												
Reference 20 dB Attenuator	SN: 5058 (20k)	03-Apr-14 (No. 217-01918)	Apr-15																																												
Type-N mismatch combination	SN: 5047.2 / 06327	03-Apr-14 (No. 217-01921)	Apr-15																																												
Reference Probe ES3DV3	SN: 3205	30-Dec-13 (No. ES3-3205_Dec13)	Dec-14																																												
DAE4	SN: 601	30-Apr-14 (No. DAE4-601_Apr14)	Apr-15																																												
Secondary Standards	ID #	Check Date (in house)	Scheduled Check																																												
RF generator R&S SMT-06	100005	04-Aug-99 (in house check Oct-13)	In house check: Oct-16																																												
Network Analyzer HP 8753E	US37390585 S4206	18-Oct-01 (in house check Oct-13)	In house check: Oct-14																																												
Calibrated by:	Name Israe El-Naouq	Function Laboratory Technician	Signature 																																												
Approved by:	Name Katja Pokovic	Technical Manager																																													
Issued: June 13, 2014																																															
This calibration certificate shall not be reproduced except in full without written approval of the laboratory.																																															

Calibration Laboratory of
Schmid & Partner
Engineering AG
Zeughausstrasse 43, 8004 Zurich, Switzerland



S Schweizerischer Kalibrierdienst
C Service suisse d'étalonnage
S Servizio svizzero di taratura
S Swiss Calibration Service

Accredited by the Swiss Accreditation Service (SAS)
The Swiss Accreditation Service is one of the signatories to the EA
Multilateral Agreement for the recognition of calibration certificates

Accreditation No.: **SCS 108**

Glossary:

TSL tissue simulating liquid
ConvF sensitivity in TSL / NORM x,y,z
N/A not applicable or not measured

Calibration is Performed According to the Following Standards:

- a) IEEE Std 1528-2013, "IEEE Recommended Practice for Determining the Peak Spatial-Averaged Specific Absorption Rate (SAR) in the Human Head from Wireless Communications Devices: Measurement Techniques", June 2013
- b) IEC 62209-1, "Procedure to measure the Specific Absorption Rate (SAR) for hand-held devices used in close proximity to the ear (frequency range of 300 MHz to 3 GHz)", February 2005
- c) KDB 865664, "SAR Measurement Requirements for 100 MHz to 6 GHz"

Additional Documentation:

- d) DAS4/5 System Handbook

Methods Applied and Interpretation of Parameters:

- *Measurement Conditions:* Further details are available from the Validation Report at the end of the certificate. All figures stated in the certificate are valid at the frequency indicated.
- *Antenna Parameters with TSL:* The dipole is mounted with the spacer to position its feed point exactly below the center marking of the flat phantom section, with the arms oriented parallel to the body axis.
- *Feed Point Impedance and Return Loss:* These parameters are measured with the dipole positioned under the liquid filled phantom. The impedance stated is transformed from the measurement at the SMA connector to the feed point. The Return Loss ensures low reflected power. No uncertainty required.
- *Electrical Delay:* One-way delay between the SMA connector and the antenna feed point. No uncertainty required.
- *SAR measured:* SAR measured at the stated antenna input power.
- *SAR normalized:* SAR as measured, normalized to an input power of 1 W at the antenna connector.
- *SAR for nominal TSL parameters:* The measured TSL parameters are used to calculate the nominal SAR result.

The reported uncertainty of measurement is stated as the standard uncertainty of measurement multiplied by the coverage factor $k=2$, which for a normal distribution corresponds to a coverage probability of approximately 95%.

Measurement Conditions

DASY system configuration, as far as not given on page 1.

DASY Version	DASY5	V52.8.8
Extrapolation	Advanced Extrapolation	
Phantom	Modular Flat Phantom	
Distance Dipole Center - TSL	10 mm	with Spacer
Zoom Scan Resolution	dx, dy, dz = 5 mm	
Frequency	2450 MHz \pm 1 MHz	

Head TSL parameters

The following parameters and calculations were applied.

	Temperature	Permittivity	Conductivity
Nominal Head TSL parameters	22.0 °C	39.2	1.80 mho/m
Measured Head TSL parameters	(22.0 \pm 0.2) °C	38.4 \pm 6 %	1.84 mho/m \pm 6 %
Head TSL temperature change during test	< 0.5 °C	----	----

SAR result with Head TSL

SAR averaged over 1 cm ³ (1 g) of Head TSL	Condition	
SAR measured	250 mW input power	13.4 W/kg
SAR for nominal Head TSL parameters	normalized to 1W	52.8 W/kg \pm 17.0 % (k=2)

SAR averaged over 10 cm ³ (10 g) of Head TSL	condition	
SAR measured	250 mW input power	6.25 W/kg
SAR for nominal Head TSL parameters	normalized to 1W	24.8 W/kg \pm 16.5 % (k=2)

Body TSL parameters

The following parameters and calculations were applied.

	Temperature	Permittivity	Conductivity
Nominal Body TSL parameters	22.0 °C	52.7	1.95 mho/m
Measured Body TSL parameters	(22.0 \pm 0.2) °C	51.1 \pm 6 %	2.03 mho/m \pm 6 %
Body TSL temperature change during test	< 0.5 °C	----	----

SAR result with Body TSL

SAR averaged over 1 cm ³ (1 g) of Body TSL	Condition	
SAR measured	250 mW input power	12.9 W/kg
SAR for nominal Body TSL parameters	normalized to 1W	50.3 W/kg \pm 17.0 % (k=2)

SAR averaged over 10 cm ³ (10 g) of Body TSL	condition	
SAR measured	250 mW input power	6.00 W/kg
SAR for nominal Body TSL parameters	normalized to 1W	23.6 W/kg \pm 16.5 % (k=2)

Appendix (Additional assessments outside the scope of SCS108)**Antenna Parameters with Head TSL**

Impedance, transformed to feed point	$53.4 \Omega + 5.1 j\Omega$
Return Loss	- 24.5 dB

Antenna Parameters with Body TSL

Impedance, transformed to feed point	$49.5 \Omega + 6.9 j\Omega$
Return Loss	- 23.1 dB

General Antenna Parameters and Design

Electrical Delay (one direction)	1.160 ns
----------------------------------	----------

After long term use with 100W radiated power, only a slight warming of the dipole near the feedpoint can be measured.

The dipole is made of standard semirigid coaxial cable. The center conductor of the feeding line is directly connected to the second arm of the dipole. The antenna is therefore short-circuited for DC-signals. On some of the dipoles, small end caps are added to the dipole arms in order to improve matching when loaded according to the position as explained in the "Measurement Conditions" paragraph. The SAR data are not affected by this change. The overall dipole length is still according to the Standard.

No excessive force must be applied to the dipole arms, because they might bend or the soldered connections near the feedpoint may be damaged.

Additional EUT Data

Manufactured by	SPEAG
Manufactured on	August 18, 2010

DASY5 Validation Report for Head TSL

Date: 13.06.2014

Test Laboratory: SPEAG, Zurich, Switzerland

DUT: Dipole 2450 MHz; Type: D2450V2; Serial: D2450V2 - SN: 869

Communication System: UID 0 - CW; Frequency: 2450 MHz

Medium parameters used: $f = 2450$ MHz; $\sigma = 1.84$ S/m; $\epsilon_r = 38.4$; $\rho = 1000$ kg/m³

Phantom section: Flat Section

Measurement Standard: DASY5 (IEEE/IEC/ANSI C63.19-2011)

DASY52 Configuration:

- Probe: ES3DV3 - SN3205; ConvF(4.53, 4.53, 4.53); Calibrated: 30.12.2013;
- Sensor-Surface: 3mm (Mechanical Surface Detection)
- Electronics: DAE4 Sn601; Calibrated: 30.04.2014
- Phantom: Flat Phantom 5.0 (front); Type: QD000P50AA; Serial: 1001
- DASY52 52.8.8(1222); SEMCAD X 14.6.10(7331)

Dipole Calibration for Head Tissue/Pin=250 mW, d=10mm/Zoom Scan (7x7x7)/Cube 0:

Measurement grid: dx=5mm, dy=5mm, dz=5mm

Reference Value = 100.7 V/m; Power Drift = 0.03 dB

Peak SAR (extrapolated) = 27.6 W/kg

SAR(1 g) = 13.4 W/kg; SAR(10 g) = 6.25 W/kg

Maximum value of SAR (measured) = 17.2 W/kg

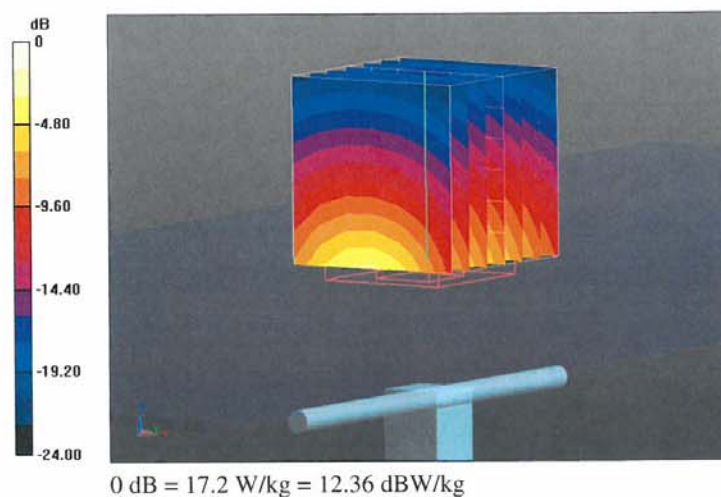

Impedance Measurement Plot for Head TSL

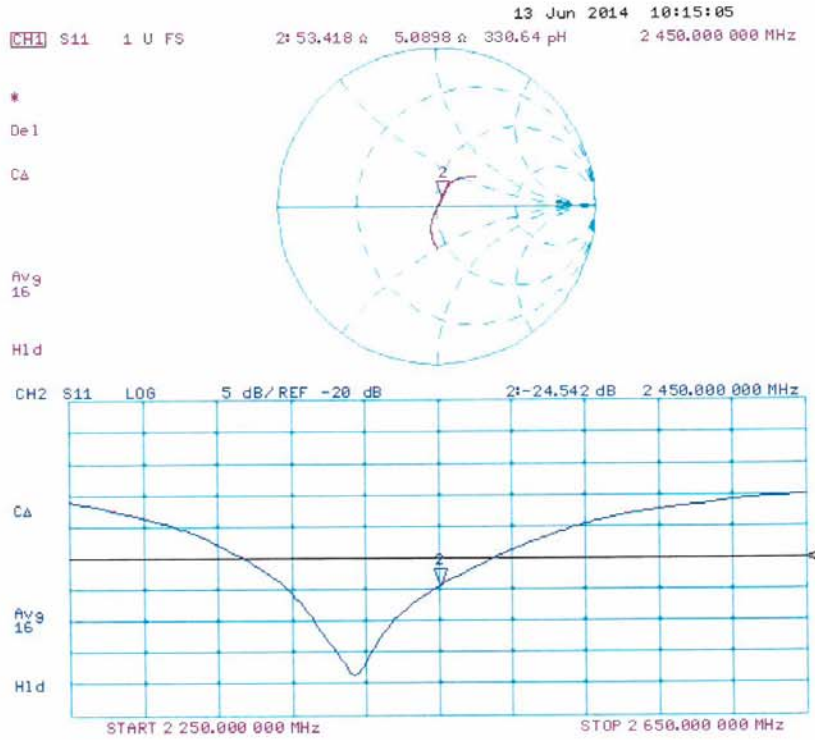

DASY5 Validation Report for Body TSL

Date: 13.06.2014

Test Laboratory: SPEAG, Zurich, Switzerland

DUT: Dipole 2450 MHz; Type: D2450V2; Serial: D2450V2 - SN: 869

Communication System: UID 0 - CW; Frequency: 2450 MHz

Medium parameters used: $f = 2450$ MHz; $\sigma = 2.03$ S/m; $\epsilon_r = 51.1$; $\rho = 1000$ kg/m³

Phantom section: Flat Section

Measurement Standard: DASY5 (IEEE/IEC/ANSI C63.19-2011)

DASY52 Configuration:

- Probe: ES3DV3 - SN3205; ConvF(4.35, 4.35, 4.35); Calibrated: 30.12.2013;
- Sensor-Surface: 3mm (Mechanical Surface Detection)
- Electronics: DAE4 Sn601; Calibrated: 30.04.2014
- Phantom: Flat Phantom 5.0 (back); Type: QD000P50AA; Serial: 1002
- DASY52 52.8.8(1222); SEMCAD X 14.6.10(7331)

Dipole Calibration for Body Tissue/Pin=250 mW, d=10mm/Zoom Scan (7x7x7)/Cube 0:

Measurement grid: dx=5mm, dy=5mm, dz=5mm

Reference Value = 93.93 V/m; Power Drift = 0.04 dB

Peak SAR (extrapolated) = 26.7 W/kg

SAR(1 g) = 12.9 W/kg; SAR(10 g) = 6 W/kg

Maximum value of SAR (measured) = 17.0 W/kg

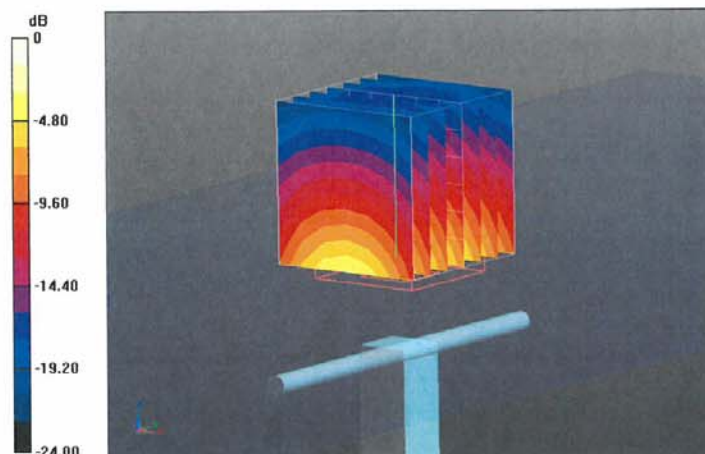

Impedance Measurement Plot for Body TSL

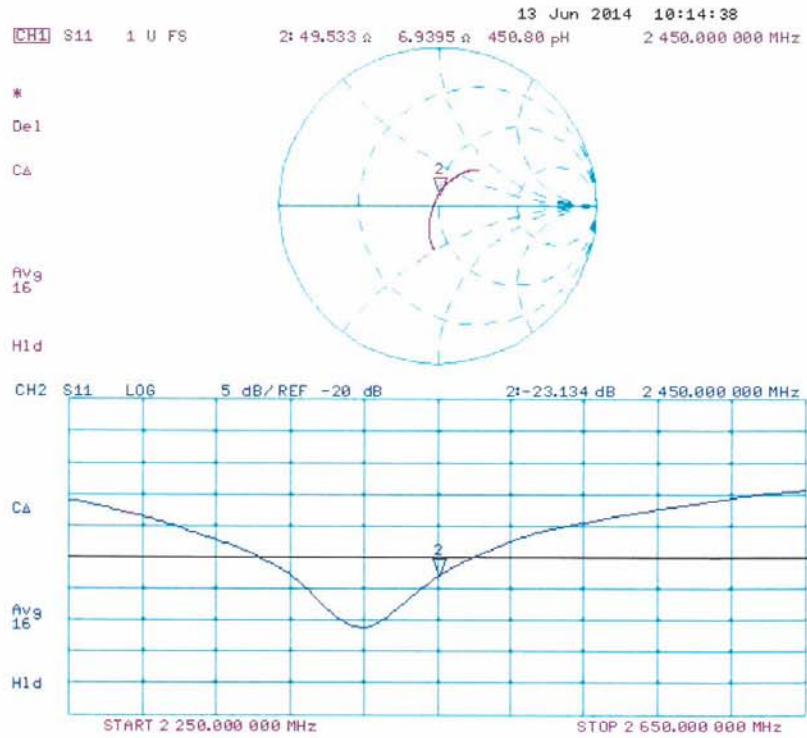

ANNEX C: PROBE CERTIFICATE

**Calibration Laboratory of
Schmid & Partner
Engineering AG**
Zeughausstrasse 43, 8004 Zurich, Switzerland



S Schweizerischer Kalibrierdienst
C Service suisse d'étalonnage
S Servizio svizzero di taratura
S Swiss Calibration Service

Accredited by the Swiss Accreditation Service (SAS)
The Swiss Accreditation Service is one of the signatories to the EA
Multilateral Agreement for the recognition of calibration certificates

Accreditation No.: **SCS 108**

Client **Auden**

Certificate No: **EX3-3578_Jun14**

CALIBRATION CERTIFICATE

Object	EX3DV4 - SN:3578
Calibration procedure(s)	QA CAL-01.v9, QA CAL-14.v4, QA CAL-23.v5, QA CAL-25.v6 Calibration procedure for dosimetric E-field probes
Calibration date:	June 24, 2014
<p>This calibration certificate documents the traceability to national standards, which realize the physical units of measurements (SI). The measurements and the uncertainties with confidence probability are given on the following pages and are part of the certificate.</p> <p>All calibrations have been conducted in the closed laboratory facility: environment temperature (22 ± 3)°C and humidity < 70%.</p> <p>Calibration Equipment used (M&TE critical for calibration)</p>	

Primary Standards	ID	Cal Date (Certificate No.)	Scheduled Calibration
Power meter E4419B	GB41293874	03-Apr-14 (No. 217-01911)	Apr-15
Power sensor E4412A	MY41498087	03-Apr-14 (No. 217-01911)	Apr-15
Reference 3 dB Attenuator	SN: S5054 (3c)	03-Apr-14 (No. 217-01915)	Apr-15
Reference 20 dB Attenuator	SN: S5277 (20x)	03-Apr-14 (No. 217-01919)	Apr-15
Reference 30 dB Attenuator	SN: S5129 (30b)	03-Apr-14 (No. 217-01920)	Apr-15
Reference Probe ES3DV2	SN: 3013	30-Dec-13 (No. ES3-3013_Dec13)	Dec-14
DAE4	SN: 660	13-Dec-13 (No. DAE4-660_Dec13)	Dec-14
Secondary Standards	ID	Check Date (in house)	Scheduled Check
RF generator HP 8648C	US3642U01700	4-Aug-99 (in house check Apr-13)	In house check: Apr-16
Network Analyzer HP 8753E	US37390585	18-Oct-01 (in house check Oct-13)	In house check: Oct-14

Calibrated by:	Name Claudio Leubler	Function Laboratory Technician	Signature
Approved by:	Name Katja Pokovic	Technical Manager	
			Issued: June 24, 2014
This calibration certificate shall not be reproduced except in full without written approval of the laboratory.			

Calibration Laboratory of
Schmid & Partner
Engineering AG
Zeughausstrasse 43, 8004 Zurich, Switzerland



S Schweizerischer Kalibrierdienst
C Service suisse d'étalonnage
S Servizio svizzero di taratura
S Swiss Calibration Service

Accredited by the Swiss Accreditation Service (SAS)

Accreditation No.: **SCS 108**

The Swiss Accreditation Service is one of the signatories to the EA
Multilateral Agreement for the recognition of calibration certificates

Glossary:

TSL	tissue simulating liquid
NORM _{x,y,z}	sensitivity in free space
ConvF	sensitivity in TSL / NORM _{x,y,z}
DCP	diode compression point
CF	crest factor (1/duty_cycle) of the RF signal
A, B, C, D	modulation dependent linearization parameters
Polarization ϕ	ϕ rotation around probe axis
Polarization ϑ	ϑ rotation around an axis that is in the plane normal to probe axis (at measurement center), i.e., $\vartheta = 0$ is normal to probe axis
Connector Angle	information used in DASY system to align probe sensor X to the robot coordinate system

Calibration is Performed According to the Following Standards:

- IEEE Std 1528-2013, "IEEE Recommended Practice for Determining the Peak Spatial-Averaged Specific Absorption Rate (SAR) in the Human Head from Wireless Communications Devices: Measurement Techniques", June 2013
- IEC 62209-1, "Procedure to measure the Specific Absorption Rate (SAR) for hand-held devices used in close proximity to the ear (frequency range of 300 MHz to 3 GHz)", February 2005

Methods Applied and Interpretation of Parameters:

- NORM_{x,y,z}**: Assessed for E-field polarization $\vartheta = 0$ ($f \leq 900$ MHz in TEM-cell; $f > 1800$ MHz: R22 waveguide). NORM_{x,y,z} are only intermediate values, i.e., the uncertainties of NORM_{x,y,z} does not affect the E²-field uncertainty inside TSL (see below ConvF).
- NORM(f)_{x,y,z}** = NORM_{x,y,z} * frequency_response (see Frequency Response Chart). This linearization is implemented in DASY4 software versions later than 4.2. The uncertainty of the frequency response is included in the stated uncertainty of ConvF.
- DCP_{x,y,z}**: DCP are numerical linearization parameters assessed based on the data of power sweep with CW signal (no uncertainty required). DCP does not depend on frequency nor media.
- PAR**: PAR is the Peak to Average Ratio that is not calibrated but determined based on the signal characteristics
- A_{x,y,z}; B_{x,y,z}; C_{x,y,z}; D_{x,y,z}; VR_{x,y,z}**: A, B, C, D are numerical linearization parameters assessed based on the data of power sweep for specific modulation signal. The parameters do not depend on frequency nor media. VR is the maximum calibration range expressed in RMS voltage across the diode.
- ConvF and Boundary Effect Parameters**: Assessed in flat phantom using E-field (or Temperature Transfer Standard for $f \leq 800$ MHz) and inside waveguide using analytical field distributions based on power measurements for $f > 800$ MHz. The same setups are used for assessment of the parameters applied for boundary compensation (alpha, depth) of which typical uncertainty values are given. These parameters are used in DASY4 software to improve probe accuracy close to the boundary. The sensitivity in TSL corresponds to NORM_{x,y,z} * ConvF whereby the uncertainty corresponds to that given for ConvF. A frequency dependent ConvF is used in DASY version 4.4 and higher which allows extending the validity from ± 50 MHz to ± 100 MHz.
- Spherical isotropy (3D deviation from isotropy)**: in a field of low gradients realized using a flat phantom exposed by a patch antenna.
- Sensor Offset**: The sensor offset corresponds to the offset of virtual measurement center from the probe tip (on probe axis). No tolerance required.
- Connector Angle**: The angle is assessed using the information gained by determining the NORM_x (no uncertainty required).

EX3DV4 – SN:3578

June 24, 2014

Probe EX3DV4

SN:3578

Manufactured: November 4, 2005
Calibrated: June 24, 2014

Calibrated for DASY/EASY Systems
(Note: non-compatible with DASY2 system!)

EX3DV4- SN:3578

June 24, 2014

DASY/EASY - Parameters of Probe: EX3DV4 - SN:3578**Basic Calibration Parameters**

	Sensor X	Sensor Y	Sensor Z	Unc (k=2)
Norm ($\mu\text{V}/(\text{V}/\text{m})^2$) ^A	0.53	0.50	0.56	± 10.1 %
DCP (mV) ^B	97.7	100.4	101.2	

Modulation Calibration Parameters

UID	Communication System Name		A dB	B dB $\sqrt{\mu\text{V}}$	C	D dB	VR mV	Unc ^E (k=2)
0	CW	X	0.0	0.0	1.0	0.00	167.4	±3.8 %
		Y	0.0	0.0	1.0		162.3	
		Z	0.0	0.0	1.0		171.0	

The reported uncertainty of measurement is stated as the standard uncertainty of measurement multiplied by the coverage factor k=2, which for a normal distribution corresponds to a coverage probability of approximately 95%.

^A The uncertainties of NormX,Y,Z do not affect the E²-field uncertainty inside TSL (see Pages 5 and 6).

^B Numerical linearization parameter: uncertainty not required.

^E Uncertainty is determined using the max. deviation from linear response applying rectangular distribution and is expressed for the square of the field value.

EX3DV4- SN:3578

June 24, 2014

DASY/EASY - Parameters of Probe: EX3DV4 - SN:3578

Calibration Parameter Determined in Head Tissue Simulating Media

f (MHz) ^C	Relative Permittivity ^F	Conductivity (S/m) ^F	ConvF X	ConvF Y	ConvF Z	Alpha ^G	Depth ^G (mm)	Unct. (k=2)
750	41.9	0.89	8.95	8.95	8.95	0.27	1.18	± 12.0 %
835	41.5	0.90	8.59	8.59	8.59	0.44	0.83	± 12.0 %
900	41.5	0.97	8.42	8.42	8.42	0.33	1.02	± 12.0 %
1450	40.5	1.20	7.71	7.71	7.71	0.38	0.95	± 12.0 %
1750	40.1	1.37	7.71	7.71	7.71	0.78	0.62	± 12.0 %
1900	40.0	1.40	7.35	7.35	7.35	0.77	0.62	± 12.0 %
2000	40.0	1.40	7.25	7.25	7.25	0.74	0.63	± 12.0 %
2300	39.5	1.67	6.93	6.93	6.93	0.34	0.90	± 12.0 %
2450	39.2	1.80	6.50	6.50	6.50	0.43	0.84	± 12.0 %
2600	39.0	1.96	6.25	6.25	6.25	0.54	0.77	± 12.0 %
5200	36.0	4.66	4.49	4.49	4.49	0.35	1.80	± 13.1 %
5300	35.9	4.76	4.24	4.24	4.24	0.35	1.80	± 13.1 %
5500	35.6	4.96	4.06	4.06	4.06	0.40	1.80	± 13.1 %
5600	35.5	5.07	4.00	4.00	4.00	0.40	1.80	± 13.1 %
5800	35.3	5.27	3.86	3.86	3.86	0.45	1.80	± 13.1 %

^C Frequency validity above 300 MHz of ± 100 MHz only applies for DASY v4.4 and higher (see Page 2), else it is restricted to ± 50 MHz. The uncertainty is the RSS of the ConvF uncertainty at calibration frequency and the uncertainty for the indicated frequency band. Frequency validity below 300 MHz is ± 10, 25, 40, 50 and 70 MHz for ConvF assessments at 30, 64, 128, 150 and 220 MHz respectively. Above 5 GHz frequency validity can be extended to ± 110 MHz.

^F At frequencies below 3 GHz, the validity of tissue parameters (ϵ and σ) can be relaxed to ± 10% if liquid compensation formula is applied to measured SAR values. At frequencies above 3 GHz, the validity of tissue parameters (ϵ and σ) is restricted to ± 5%. The uncertainty is the RSS of the ConvF uncertainty for indicated target tissue parameters.

^G Alpha/Depth are determined during calibration. SPEAG warrants that the remaining deviation due to the boundary effect after compensation is always less than ± 1% for frequencies below 3 GHz and below ± 2% for frequencies between 3-6 GHz at any distance larger than half the probe tip diameter from the boundary.

EX3DV4- SN:3578

June 24, 2014

DASY/EASY - Parameters of Probe: EX3DV4 - SN:3578**Calibration Parameter Determined in Body Tissue Simulating Media**

f (MHz) ^C	Relative Permittivity ^F	Conductivity (S/m) ^F	ConvF X	ConvF Y	ConvF Z	Alpha ^G	Depth ^G (mm)	Unct. (k=2)
750	55.5	0.96	8.59	8.59	8.59	0.80	0.64	± 12.0 %
835	55.2	0.97	8.48	8.48	8.48	0.25	1.26	± 12.0 %
900	55.0	1.05	8.40	8.40	8.40	0.80	0.67	± 12.0 %
1450	54.0	1.30	7.56	7.56	7.56	0.47	0.87	± 12.0 %
1750	53.4	1.49	7.32	7.32	7.32	0.77	0.66	± 12.0 %
1900	53.3	1.52	6.86	6.86	6.86	0.70	0.70	± 12.0 %
2000	53.3	1.52	6.96	6.96	6.96	0.67	0.71	± 12.0 %
2300	52.9	1.81	6.65	6.65	6.65	0.80	0.59	± 12.0 %
2450	52.7	1.95	6.42	6.42	6.42	0.76	0.61	± 12.0 %
2600	52.5	2.16	6.22	6.22	6.22	0.80	0.50	± 12.0 %
5200	49.0	5.30	3.95	3.95	3.95	0.45	1.90	± 13.1 %
5300	48.9	5.42	3.63	3.63	3.63	0.50	1.90	± 13.1 %
5500	48.6	5.65	3.42	3.42	3.42	0.50	1.90	± 13.1 %
5600	48.5	5.77	3.20	3.20	3.20	0.55	1.90	± 13.1 %
5800	48.2	6.00	3.39	3.39	3.39	0.55	1.90	± 13.1 %

^C Frequency validity above 300 MHz of ± 100 MHz only applies for DASY v4.4 and higher (see Page 2), else it is restricted to ± 50 MHz. The uncertainty is the RSS of the ConvF uncertainty at calibration frequency and the uncertainty for the indicated frequency band. Frequency validity below 300 MHz is ± 10, 25, 40, 50 and 70 MHz for ConvF assessments at 30, 64, 128, 150 and 220 MHz respectively. Above 5 GHz frequency validity can be extended to ± 110 MHz.

^F At frequencies below 3 GHz, the validity of tissue parameters (ϵ and σ) can be relaxed to ± 10% if liquid compensation formula is applied to measured SAR values. At frequencies above 3 GHz, the validity of tissue parameters (ϵ and σ) is restricted to ± 5%. The uncertainty is the RSS of the ConvF uncertainty for indicated target tissue parameters.

^G Alpha/Depth are determined during calibration. SPEAG warrants that the remaining deviation due to the boundary effect after compensation is always less than ± 1% for frequencies below 3 GHz and below ± 2% for frequencies between 3-6 GHz at any distance larger than half the probe tip diameter from the boundary.

EX3DV4- SN:3578

June 24, 2014

Frequency Response of E-Field (TEM-Cell:ifi110 EXX, Waveguide: R22)

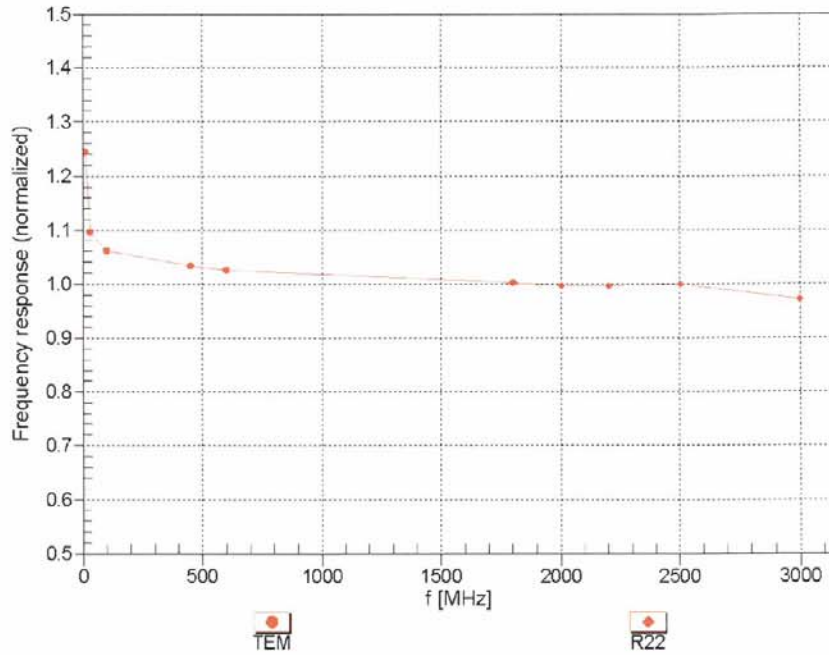

Uncertainty of Frequency Response of E-field: $\pm 6.3\%$ (k=2)

EX3DV4- SN:3578

June 24, 2014

Receiving Pattern (ϕ), $\theta = 0^\circ$

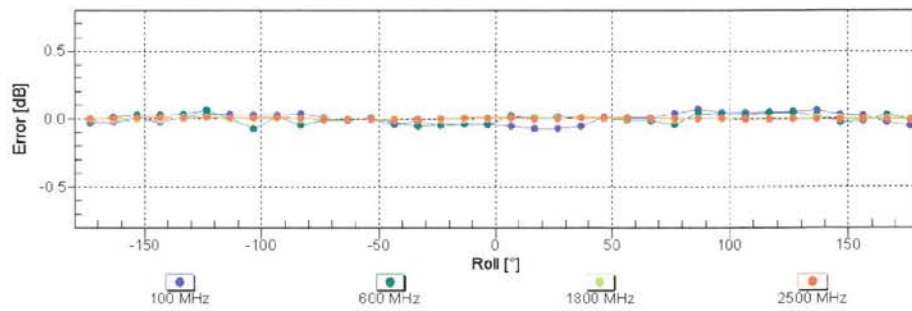
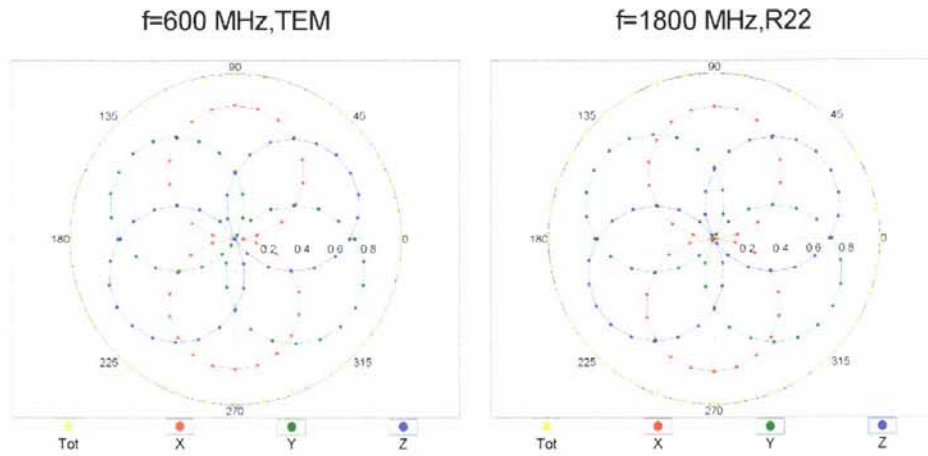

Uncertainty of Axial Isotropy Assessment: $\pm 0.5\%$ (k=2)

EX3DV4- SN:3578

June 24, 2014

Dynamic Range $f(SAR_{head})$ (TEM cell , $f_{eval} = 1900$ MHz)

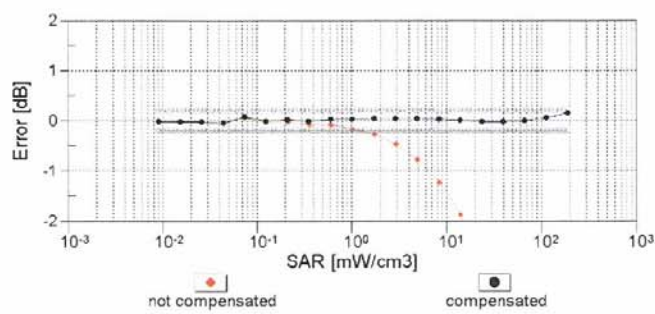
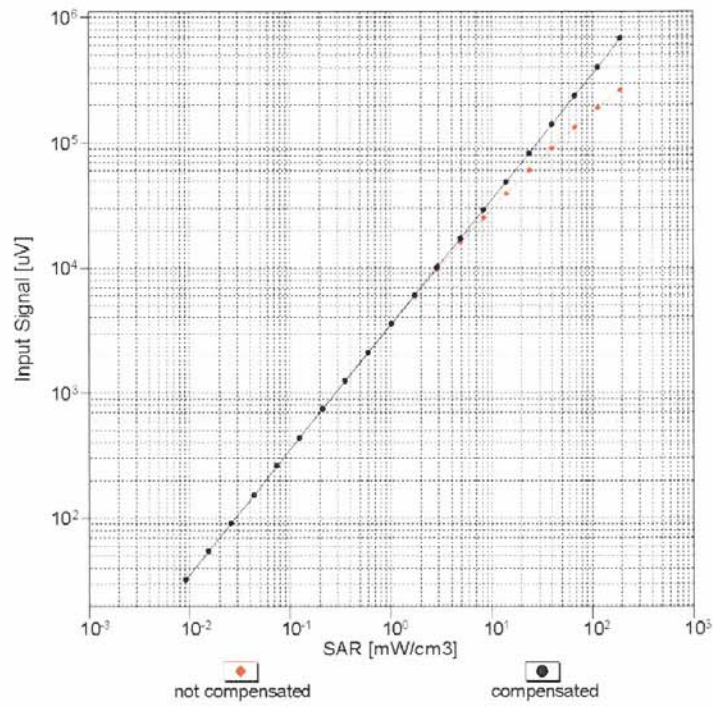

Uncertainty of Linearity Assessment: $\pm 0.6\%$ (k=2)

EX3DV4- SN:3578

June 24, 2014

Conversion Factor Assessment

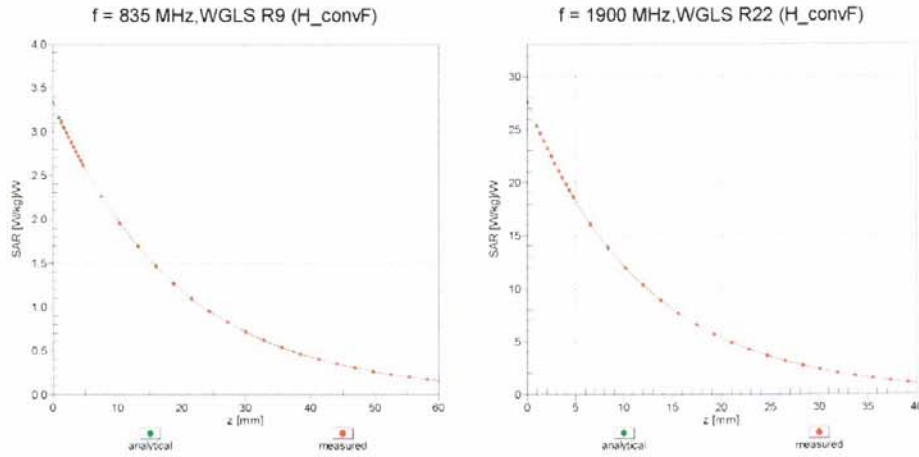

Deviation from Isotropy in Liquid Error (ϕ, θ), f = 900 MHz

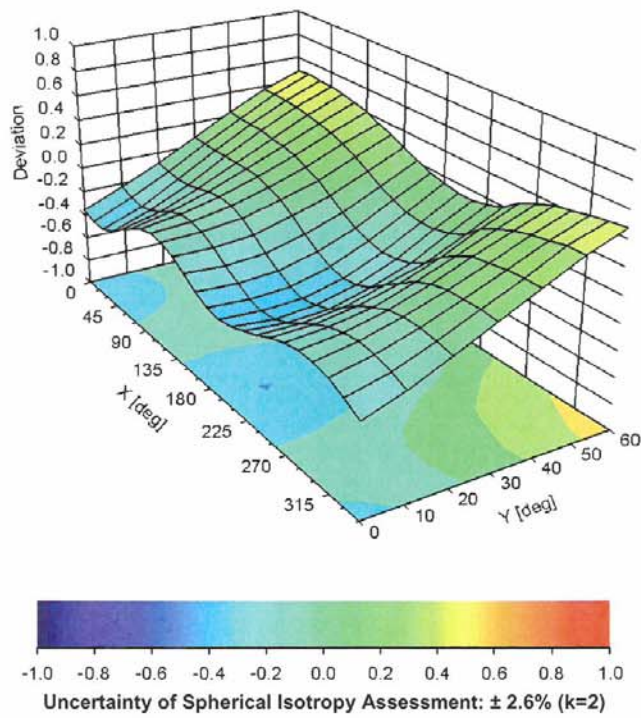

EX3DV4- SN:3578

June 24, 2014

DASY/EASY - Parameters of Probe: EX3DV4 - SN:3578**Other Probe Parameters**

Sensor Arrangement	Triangular
Connector Angle (°)	-113.3
Mechanical Surface Detection Mode	enabled
Optical Surface Detection Mode	disabled
Probe Overall Length	337 mm
Probe Body Diameter	10 mm
Tip Length	9 mm
Tip Diameter	2.5 mm
Probe Tip to Sensor X Calibration Point	1 mm
Probe Tip to Sensor Y Calibration Point	1 mm
Probe Tip to Sensor Z Calibration Point	1 mm
Recommended Measurement Distance from Surface	1.4 mm

**Calibration Laboratory of
Schmid & Partner
Engineering AG**
Zeughausstrasse 43, 8004 Zurich, Switzerland



S Schweizerischer Kalibrierdienst
C Service suisse d'étalonnage
S Servizio svizzero di taratura
S Swiss Calibration Service

Accredited by the Swiss Accreditation Service (SAS)
The Swiss Accreditation Service is one of the signatories to the EA
Multilateral Agreement for the recognition of calibration certificates

Accreditation No.: **SCS 0108**

Client **ETC (Auden)**

Certificate No: **DAE4-629_Jan15**

CALIBRATION CERTIFICATE

Object	DAE4 - SD 000 D04 BJ - SN: 629																						
Calibration procedure(s)	QA CAL-06.v29 Calibration procedure for the data acquisition electronics (DAE)																						
Calibration date:	January 26, 2015																						
<p>This calibration certificate documents the traceability to national standards, which realize the physical units of measurements (SI). The measurements and the uncertainties with confidence probability are given on the following pages and are part of the certificate.</p> <p>All calibrations have been conducted in the closed laboratory facility: environment temperature (22 ± 3)°C and humidity < 70%.</p> <p>Calibration Equipment used (M&TE critical for calibration)</p> <table border="1"> <thead> <tr> <th>Primary Standards</th> <th>ID #</th> <th>Cal Date (Certificate No.)</th> <th>Scheduled Calibration</th> </tr> </thead> <tbody> <tr> <td>Keithley Multimeter Type 2001</td> <td>SN: 0810278</td> <td>03-Oct-14 (No:15573)</td> <td>Oct-15</td> </tr> <tr> <th>Secondary Standards</th> <th>ID #</th> <th>Check Date (in house)</th> <th>Scheduled Check</th> </tr> <tr> <td>Auto DAE Calibration Unit</td> <td>SE UWS 053 AA 1001</td> <td>06-Jan-15 (in house check)</td> <td>In house check: Jan-16</td> </tr> <tr> <td>Calibrator Box V2.1</td> <td>SE UMS 006 AA 1002</td> <td>06-Jan-15 (in house check)</td> <td>In house check: Jan-16</td> </tr> </tbody> </table>				Primary Standards	ID #	Cal Date (Certificate No.)	Scheduled Calibration	Keithley Multimeter Type 2001	SN: 0810278	03-Oct-14 (No:15573)	Oct-15	Secondary Standards	ID #	Check Date (in house)	Scheduled Check	Auto DAE Calibration Unit	SE UWS 053 AA 1001	06-Jan-15 (in house check)	In house check: Jan-16	Calibrator Box V2.1	SE UMS 006 AA 1002	06-Jan-15 (in house check)	In house check: Jan-16
Primary Standards	ID #	Cal Date (Certificate No.)	Scheduled Calibration																				
Keithley Multimeter Type 2001	SN: 0810278	03-Oct-14 (No:15573)	Oct-15																				
Secondary Standards	ID #	Check Date (in house)	Scheduled Check																				
Auto DAE Calibration Unit	SE UWS 053 AA 1001	06-Jan-15 (in house check)	In house check: Jan-16																				
Calibrator Box V2.1	SE UMS 006 AA 1002	06-Jan-15 (in house check)	In house check: Jan-16																				
Calibrated by:	Name Dominique Steffen	Function Technician	Signature 																				
Approved by:	Fin Bomholt	Deputy Technical Manager																					
			Issued: January 26, 2015																				
This calibration certificate shall not be reproduced except in full without written approval of the laboratory.																							

Calibration Laboratory of
Schmid & Partner
Engineering AG
Zeughausstrasse 43, 8004 Zurich, Switzerland



S Schweizerischer Kalibrierdienst
C Service suisse d'étalonnage
S Servizio svizzero di taratura
S Swiss Calibration Service

Accredited by the Swiss Accreditation Service (SAS)
The Swiss Accreditation Service is one of the signatories to the EA
Multilateral Agreement for the recognition of calibration certificates

Accreditation No.: **SCS 0108**

Glossary

DAE data acquisition electronics
Connector angle information used in DASY system to align probe sensor X to the robot coordinate system.

Methods Applied and Interpretation of Parameters

- *DC Voltage Measurement:* Calibration Factor assessed for use in DASY system by comparison with a calibrated instrument traceable to national standards. The figure given corresponds to the full scale range of the voltmeter in the respective range.
- *Connector angle:* The angle of the connector is assessed measuring the angle mechanically by a tool inserted. Uncertainty is not required.
- The following parameters as documented in the Appendix contain technical information as a result from the performance test and require no uncertainty.
 - *DC Voltage Measurement Linearity:* Verification of the Linearity at +10% and -10% of the nominal calibration voltage. Influence of offset voltage is included in this measurement.
 - *Common mode sensitivity:* Influence of a positive or negative common mode voltage on the differential measurement.
 - *Channel separation:* Influence of a voltage on the neighbor channels not subject to an input voltage.
 - *AD Converter Values with inputs shorted:* Values on the internal AD converter corresponding to zero input voltage
 - *Input Offset Measurement:* Output voltage and statistical results over a large number of zero voltage measurements.
 - *Input Offset Current:* Typical value for information; Maximum channel input offset current, not considering the input resistance.
 - *Input resistance:* Typical value for information: DAE input resistance at the connector, during internal auto-zeroing and during measurement.
 - *Low Battery Alarm Voltage:* Typical value for information. Below this voltage, a battery alarm signal is generated.
 - *Power consumption:* Typical value for information. Supply currents in various operating modes.

DC Voltage Measurement

A/D - Converter Resolution nominal

High Range: 1LSB = 6.1 μ V , full range = -100...+300 mV
 Low Range: 1LSB = 61nV , full range = -1.....+3mV

DASY measurement parameters: Auto Zero Time: 3 sec; Measuring time: 3 sec

Calibration Factors	X	Y	Z
High Range	404.312 \pm 0.02% (k=2)	404.175 \pm 0.02% (k=2)	404.045 \pm 0.02% (k=2)
Low Range	3.96490 \pm 1.50% (k=2)	3.96872 \pm 1.50% (k=2)	3.97781 \pm 1.50% (k=2)

Connector Angle

Connector Angle to be used in DASY system	151.5 $^{\circ}$ \pm 1 $^{\circ}$
---	-------------------------------------

Appendix (Additional assessments outside the scope of SCS108)**1. DC Voltage Linearity**

High Range	Reading (μV)	Difference (μV)	Error (%)
Channel X + Input	200034.74	2.48	0.00
Channel X + Input	20005.36	1.04	0.01
Channel X - Input	-20002.31	2.48	-0.01
Channel Y + Input	200031.99	-5.91	-0.00
Channel Y + Input	20002.82	-1.39	-0.01
Channel Y - Input	-20004.54	0.35	-0.00
Channel Z + Input	200031.93	-5.56	-0.00
Channel Z + Input	20003.27	-0.82	-0.00
Channel Z - Input	-20003.59	1.37	-0.01

Low Range	Reading (μV)	Difference (μV)	Error (%)
Channel X + Input	2000.33	-0.62	-0.03
Channel X + Input	201.29	0.24	0.12
Channel X - Input	-198.52	0.35	-0.17
Channel Y + Input	2001.42	0.60	0.03
Channel Y + Input	200.85	-0.13	-0.07
Channel Y - Input	-200.17	-1.09	0.55
Channel Z + Input	2000.89	0.06	0.00
Channel Z + Input	199.89	-1.05	-0.52
Channel Z - Input	-199.90	-0.78	0.39

2. Common mode sensitivity

DASY measurement parameters: Auto Zero Time: 3 sec; Measuring time: 3 sec

	Common mode Input Voltage (mV)	High Range Average Reading (μV)	Low Range Average Reading (μV)
Channel X	200	-0.95	-1.75
	- 200	2.91	1.73
Channel Y	200	2.14	1.93
	- 200	-2.86	-3.19
Channel Z	200	1.07	0.46
	- 200	-2.14	-1.93

3. Channel separation

DASY measurement parameters: Auto Zero Time: 3 sec; Measuring time: 3 sec

	Input Voltage (mV)	Channel X (μV)	Channel Y (μV)	Channel Z (μV)
Channel X	200	-	1.76	-2.90
Channel Y	200	7.50	-	1.84
Channel Z	200	8.25	6.07	-

4. AD-Converter Values with inputs shorted

DASY measurement parameters: Auto Zero Time: 3 sec; Measuring time: 3 sec

	High Range (LSB)	Low Range (LSB)
Channel X	15987	17153
Channel Y	15977	16301
Channel Z	16291	14609

5. Input Offset Measurement

DASY measurement parameters: Auto Zero Time: 3 sec; Measuring time: 3 sec

Input 10M Ω

	Average (μ V)	min. Offset (μ V)	max. Offset (μ V)	Std. Deviation (μ V)
Channel X	1.28	0.36	2.79	0.43
Channel Y	0.14	-0.93	1.23	0.47
Channel Z	-0.33	-1.44	0.82	0.42

6. Input Offset Current

Nominal Input circuitry offset current on all channels: <25fA

7. Input Resistance (Typical values for information)

	Zeroing (kOhm)	Measuring (MOhm)
Channel X	200	200
Channel Y	200	200
Channel Z	200	200

8. Low Battery Alarm Voltage (Typical values for information)

Typical values	Alarm Level (VDC)
Supply (+ Vcc)	+7.9
Supply (- Vcc)	-7.6

9. Power Consumption (Typical values for information)

Typical values	Switched off (mA)	Stand by (mA)	Transmitting (mA)
Supply (+ Vcc)	+0.01	+6	+14
Supply (- Vcc)	-0.01	-8	-9