

KREAFUNK™

CREATIVE FUNCTION

2.0CH WOODEN SPEAKER



bshelf model 1.1

User manual

WARNINGS AND PRECAUTIONS

Warnings

- This appliance is for household, indoor use only.
- To reduce the risk of fire or electric shock, do not expose this apparatus to rain or moisture.
- The warranty for this product is invalidated if the product has been tampered with in any way. There are no user serviceable parts inside this product.
- Do not place this unit directly onto furniture surfaces or soft, porous, or sensitive finish. As with any rubber compound made with oils, the feet could cause marks or staining where the feet reside. We recommend using a protective barrier such as a cloth or a piece of glass between the unit and the surface to reduce the risk of damage and/or staining.
- Use of this unit near fluorescent lighting may cause interference regarding use of the remote. If the unit is displaying erratic behavior move away from any fluorescent lighting, as it may be the cause.
- The battery, batteries, and battery pack shall not be exposed to excessive heat such as sunshine, fire, or the like.
- Lithium batteries, like all rechargeable batteries are recyclable and should be recycled or disposed of in normal household waste. Contact your local government for disposal or recycling practices in your area. They should never be incinerated since they might explode.
- Shock hazard - Do Not Open.

FCC Warnings

Warning: Changes or modifications to this unit not expressly approved by the party responsible for compliance could void the user's authority to operate the equipment.

NOTE: This equipment has been tested and found to comply with the limits for a Class B digital device, pursuant to Part 15 of the FCC Rules. These limits are designed to provide reasonable protection against harmful interference in a residential installation.

This equipment generates, uses, and can radiate radio frequency energy and, if not installed and used in accordance with the instructions, may cause harmful interference to radio communications. However, there is no guarantee that interference will not occur in a particular installation. If this equipment does cause harmful interference to radio or television reception, which can be determined by turning the equipment off and on, the user is encouraged to try to correct the interference by one or more of the following measures:

- Reorient or relocate the receiving antenna.
- Increase the separation between the equipment and receiver.
- Connect the equipment into an outlet on a circuit different from that to which the receiver is connected.
- Consult the dealer or an experienced radio/TV technician for help.



This device complies with Part 15 of the FCC Rules. Operation is subject to the following two conditions: (1) This device may not cause harmful interference. (2) This device must accept any interference received, including interference that may cause undesired operation.

FCC Radiation Exposure Statement

This equipment complied with FCC radiation exposure limits set forth for an uncontrolled environment. This equipment should be installed and operated with minimum distance 20cm between the radiator & your body.

Cautions

- To prevent electric shock, match wide blade of plug to wide slot, make sure it is fully inserted.
- Always unplug the appliance from the power outlet when it is not in use and before cleaning. Only use this product with the adapter provided.
- Use of any controls or adjustments or performance of procedures other than those herein specified may result in hazardous radiation exposure.
- Danger of explosion if battery is incorrectly replaced. Replace only with the same or equivalent type.

	WARNING: TO REDUCE THE RISK OF ELECTRIC SHOCK, DO NOT REMOVE COVER (OR BACK). NO USER SERVICEABLE PARTS INSIDE. REFER SERVICING TO QUALIFIED SERVICE PERSONNEL.
	The lightning flash with arrowhead symbol, within an equilateral triangle, is intended to alert the user to the presence of uninsulated "dangerous voltage" within the product's enclosure that may be of sufficient magnitude to constitute a risk of electric shock to persons.
	The exclamation point within an equilateral triangle is intended to alert the user to the presence of important operating and maintenance (servicing) instructions in the literature accompanying the appliance.

IMPORTANT SAFETY INSTRUCTIONS

1. Read these Instructions.
2. Keep these Instructions.
3. Heed all warnings.
4. Follow all instructions.
5. Do not use this apparatus near water.
6. Clean only with a dry cloth.
7. Do not block any ventilation openings. Install in accordance with the manufacturer's instructions.
8. Do not install near any heat sources such as radiators, heat registers, stoves, or other apparatus (including amplifiers) that produce heat.
9. Do not defeat the safety purpose of the polarized or grounding - type plug. A polarized plug has two blades with one wider than the other. A grounding type plug has two blades and a third grounding prong. The wide blade or the third prong is provided for your safety. When the provided plug does not fit into your outlet, consult an electrician for replacement of the obsolete outlet.
10. Protect the power cord from being stepped on or pinched particularly at plugs, convenience receptacles, and the point where they exit from the apparatus.
11. Only use attachments/ accessories specified by the manufacturer.
12. Unplug this apparatus during lightning storms or when unused for long periods.
13. Refer all servicing to qualified service personnel. Servicing is required when the apparatus has been damaged in any way, such as power-supply cord or plug is damaged, liquid has been spilled or objects have fallen into the apparatus, the apparatus has been exposed to moisture, does not operate normally, or has been dropped.
14. Do not use the product for any purpose other than its intended use.

DISPOSAL



Batteries, electrical and electronic equipment (EEE) contain materials, parts and substances, which can be dangerous to the environment and harmful to human health if waste of electrical and electronic equipment (WEEE) are not disposed of correctly. Batteries, electrical and electronic equipment, which are marked with the WEEE logo (as shown on the left), should not be thrown away with your household waste. Contact your Local Authority Waste Disposal Department, as they will be able to provide details of the recycling options available in your area.



Battery safety:
Do not burn. Risk of explosion.
Do not recharge non-recharge-able batteries.
If swallowed seek immediately medical advice.
Ensure correct polarity.
If not used for extended period remove battery.

SPECIFICATIONS

- Supports Bluetooth v2.1
- Supports Enhanced Data Rate (EDR)
- Supports profile A2DP (Advanced Audio Distribution Profile)
- Digital volume control
- Remote
- 3.5 mm audio input
- LED pairing indicator
- LED power indicator
- Wall mountable
- Wireless range: 33 feet
- Built-in stereo speakers
- AC power input: requires an AC/DC power adapter (included)

SETUP

Power

AC power input: Requires an AC/DC power adapter (included)

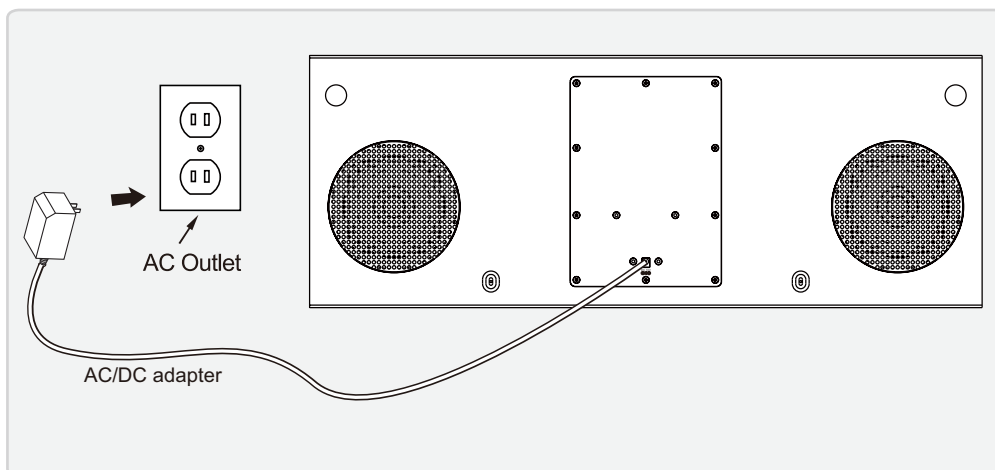

LED indicators

Status	Indicators
Power off	Red light
Line in mode	Green light
Bluetooth ready	Flashing light
Bluetooth connected	Blue light

Remote control

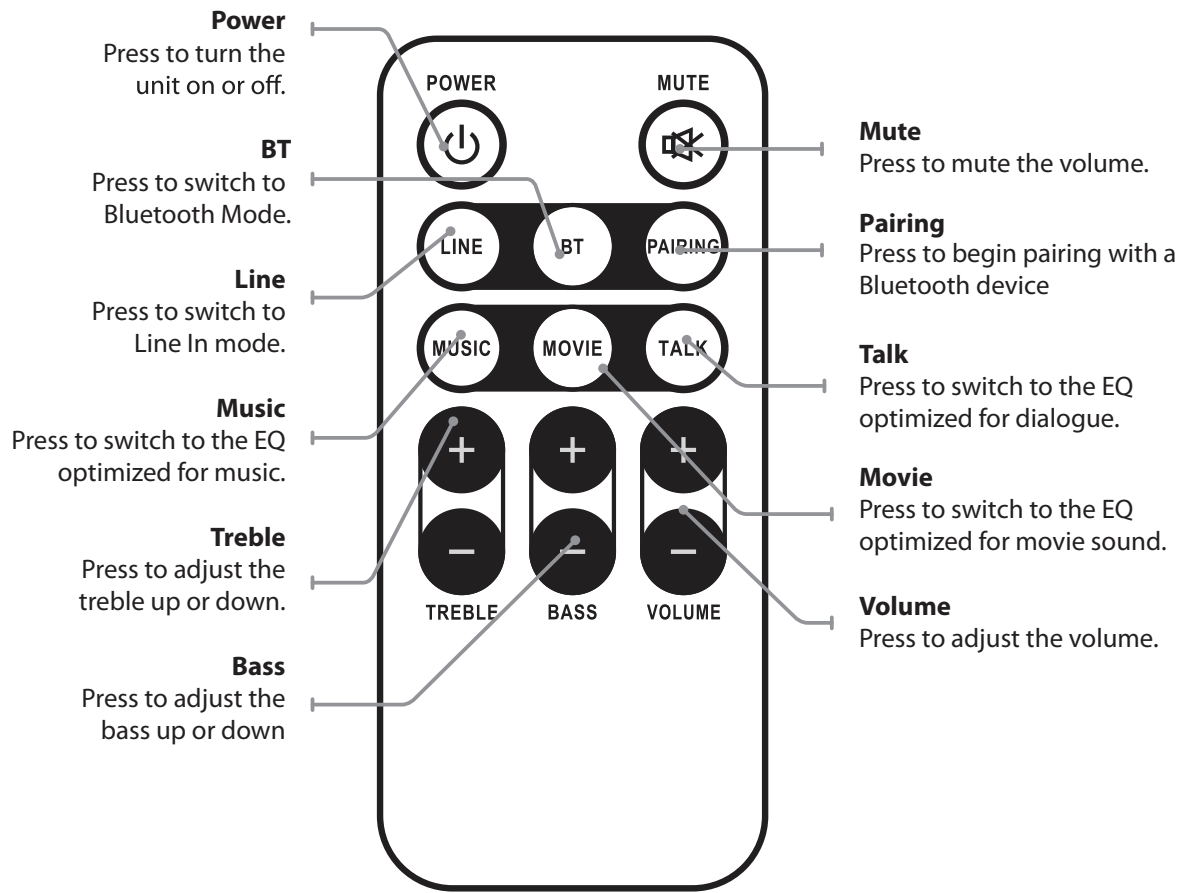

Requires a CR2025 battery (pre-installed)

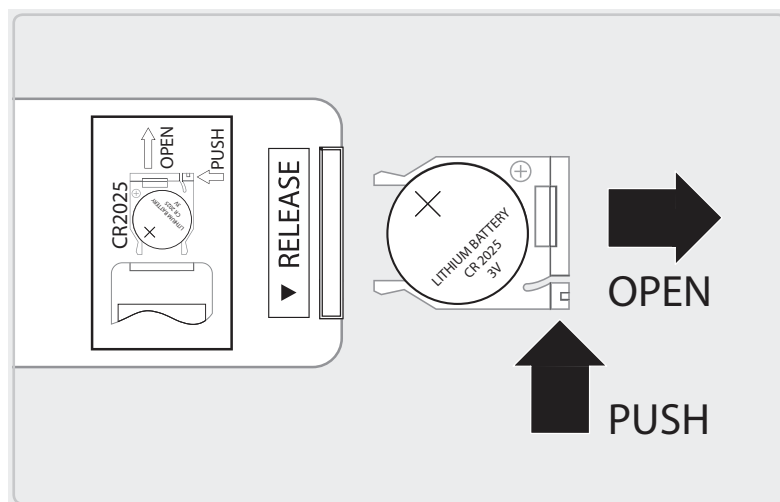

LINE IN

Using the Line In

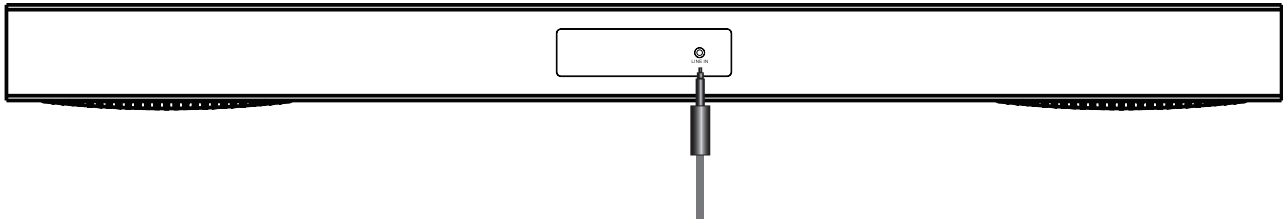

1. Plug one end of a 3.5 mm audio input cable (included) into the **Line In** on the unit.
2. Plug the other end of the cable into the audio output/headphone output on an MP3 Player or other audio source.
3. Press the **Power** button on the remote control to power on the unit.
4. Press **LINE** on the remote control to enter Line In Mode, indicated by a green light.
5. Audio played through the connected device will now be heard through the speakers.

BLUETOOTH CONNECTION

Pairing a Bluetooth Device for the First Time

1. Power on the unit by pressing the **Power** button on the remote control.
2. Press the **Bluetooth** icon on the remote control to enter Bluetooth mode, indicated by a blue light.
3. Press the **Pairing** button on the remote control.
*The **Pairing Indicator** will flash blue quickly. When pairing, remain within 3 feet of the unit.*
4. Using the native controls on your Bluetooth device, select the " KREAFUNK " in your Bluetooth settings to pair. *If your device requests a password, enter the default "0000".*
5. When successfully paired and connected, a beep will issue from the unit and the **Pairing Indicator** will display a solid blue light. After initial pairing, the unit will stay paired unless unpaired manually by the user, or until it is erased due to a reset of the device.
If your device should become unpaired or you find it is unable to connect, repeat the above steps.

Playing Audio Wirelessly

1. Follow the instructions for **Pairing a Bluetooth Device**.
2. Use the native controls on the connected Bluetooth Device to select a track.
3. To play, pause or skip the selected track, use the native controls on the connected Bluetooth Device.
4. Audio played through the connected Bluetooth device will now be heard through the speakers.