

FCC PART 15 SUBPART C MEASUREMENT AND TEST REPORT

For

KREAFUNK ApS

Industrivej 29, 7430 Ikast, Denmark

E.U.T.: 2.0CH WOODEN SPEAKER

Model Name: bshelf model 1.1

Brand Name: 

FCC ID: 2ACVCLF31BT

Report Number: NTC1411640F

Test Date(s): November 27, 2014 to May 20, 2015

Report Date(s): May 27, 2015

Prepared by

Dongguan Nore Testing Center Co., Ltd.

**Building D, Gaosheng Science & Technology Park, Zhouxi Longxi Road,
Nancheng District, Dongguan, Guangdong, China.**

Tel: +86-769-22022444

Fax: +86-769-22022799

Prepared By

Approved & Authorized Signer



Rose Hu / Engineer



Sunm Lv / Q.A. Director

Note: This test report is for the customer shown above and their specific product only. It may not be duplicated or used in part without prior written consent from Dongguan Nore Testing Center Co., Ltd. The test results referenced from this report are relevant only to the sample tested.

Table of Contents

1. GENERAL INFORMATION	4
1.1 PRODUCT DESCRIPTION FOR EQUIPMENT UNDER TEST	4
1.2 RELATED SUBMITTAL(S) / GRANT (S).....	5
1.3 TEST METHODOLOGY.....	5
1.4 EQUIPMENT MODIFICATIONS	5
1.5 TEST FACILITY AND LOCATION.....	5
1.6 SUMMARY OF TEST RESULTS	6
2. SYSTEM TEST CONFIGURATION.....	7
2.1 EUT CONFIGURATION	7
2.2 SPECIAL ACCESSORIES.....	7
2.3 DESCRIPTION OF TEST MODES	7
2.4 EUT EXERCISE.....	7
2.5 SUPPORT DEVICE	7
3. CONDUCTED EMISSIONS TEST	8
3.1 TEST SET-UP (BLOCK DIAGRAM OF CONFIGURATION).....	8
3.2 TEST CONDITION	8
3.3 MEASUREMENT RESULTS.....	8
4. RADIATED EMISSION TEST.....	11
4.1 TEST SET-UP (BLOCK DIAGRAM OF CONFIGURATION).....	11
4.2 MEASUREMENT PROCEDURE	12
4.3 LIMIT.....	12
4.4 MEASUREMENT RESULTS.....	13
5. CHANNEL SEPARATION TEST.....	17
5.1 MEASUREMENT PROCEDURE	17
5.2 TEST SET-UP (BLOCK DIAGRAM OF CONFIGURATION).....	17
5.3 MEASUREMENT RESULTS.....	17
6. 20DB BANDWIDTH.....	23
6.1 MEASUREMENT PROCEDURE	23
6.2 TEST SET-UP (BLOCK DIAGRAM OF CONFIGURATION).....	23
6.3 MEASUREMENT RESULTS.....	23
7. HOPPING CHANNEL NUMBER.....	29
7.1 MEASUREMENT PROCEDURE	29
7.2 TEST SET-UP (BLOCK DIAGRAM OF CONFIGURATION).....	29
7.3 MEASUREMENT RESULTS.....	29

8. TIME OF OCCUPANCY (DWELL TIME)	31
8.1 MEASUREMENT PROCEDURE	31
8.2 MEASUREMENT RESULTS.....	31
9. MAXIMUM PEAK OUTPUT POWER	37
9.1 MEASUREMENT PROCEDURE	37
9.2 MEASUREMENT RESULTS.....	37
10. BAND EDGE	43
10.1 MEASUREMENT PROCEDURE	43
10.2 LIMIT.....	43
10.3 MEASUREMENT RESULTS.....	44
11. ANTENNA APPLICATION	45
11.1 ANTENNA REQUIREMENT	51
11.2 MEASUREMENT RESULTS.....	51
12. CONDUCTED SPURIOUS EMISSIONS	52
12.1 MEASUREMENT PROCEDURE	52
12.2 MEASUREMENT RESULTS.....	52
13. TEST EQUIPMENT LIST	56

1. GENERAL INFORMATION

1.1 Product Description for Equipment under Test

This device is a multifunction Bluetooth speaker. It's powered by DC 18V come from Adapter. For more details features, please refer to User's Manual.

Manufacturer	: Guoguang Electric (Zhongshan) Ltd.
Address	: #18 Chigang Road, YongNing Estate, XiaoLan Town, ZhoingShan, GuangDong, China
Power Supply	: DC 18V Come from adapter Adapter M/N: GFP451DA-1825B-1 Input: AC 100-240V 50-60Hz 1.2A Output: DC 18V 2.5A
Model name	: bshelf model 1.1
Product HW version	: 1.1
Product SW version	: N/A
Radio HW version	: APB8202 V1.2
Radio SW version	: 2.1+EDR
Test SW version	: CSR Bluesuite_V3.0
RF Power setting in test SW	: For GFSK: 0, 63; For $\pi/4$ -DQPSK, 8DPSK: 0, 105
Frequency:	: 2402-2480MHz
Modulation	: GFSK, $\pi/4$ -DQPSK, 8DPSK
Number of Channel	: 79
Channel space	: 1MHz
Antenna Type	: PCB
Antenna Gain	: 0 dBi (declared by manufacturer)

1.2 Related Submittal(s) / Grant (s)

This submittal(s) (test report) is intended for FCC ID: 2ACVCLF31BT filing to comply with Section 15.247 of the FCC Part 15 (2014), Subpart C Rule.

1.3 Test Methodology

Both AC mains line-conducted and radiated emission measurements were performed according to the procedures in ANSI C63.10 (2013) and DA 00-705. Radiated emission measurement was performed in semi-anechoic chamber and conducted emission measurement was performed in shield room. For radiated emission measurement, preliminary scans were performed in the semi-anechoic chamber only to determine the worst case modes. All radiated tests were performed at an antenna to EUT distance of 3 meters.

1.4 Equipment Modifications

Not available for this EUT intended for grant.

1.5 Test Facility and Location

Listed by FCC, August 02, 2011
The Certificate Registration Number is 665078.

Listed by Industry Canada, July 01, 2011
The Certificate Registration Number is 9743A-1.

Dongguan NTC Co., Ltd.

Building D, Gaosheng Science and Technology Park,
Hongtu Road, Nancheng District, Dongguan City,
Guangdong Province, China

1.6 Summary of Test Results

FCC Rules	Description Of Test	Result
§15.247(a)(1)	Channel Separation test	Compliant
§15.247(a)(1)	20dB Bandwidth	Compliant
§15.247(a)(1)(iii)	Hopping Channel Number	Compliant
§15.247(a)(1)(iii)	Time of Occupancy (Dwell Time)	Compliant
§15.247(b)	Max Peak output Power test	Compliant
§15.247(d)	Band edge test	Compliant
§15.207 (a)	AC Power Conducted Emission	Compliant
§15.247(d), §15.209, §15.205	Radiated Emission	Compliant
§15.203	Antenna Requirement	Compliant
§15.247(d)	Conducted Spurious Emission	Compliant

2. System Test Configuration

2.1 EUT Configuration

The EUT configuration for testing is installed on RF field strength measurement to meet the Commissions requirement and operating in a manner which intends to maximize its emission characteristics in a continuous normal application.

2.2 Special Accessories

Not available for this EUT intended for grant.

2.3 Description of test modes

The EUT has been tested under operating condition. Test program used to control the EUT for staying in continuous transmitting and normal mode is programmed. The Lowest, middle and highest channel were chosen for testing, and all packets DH1, DH3 and DH5 mode in all modulation type GFSK, $\pi/4$ -DQPSK, 8DPSK were tested.

2.4 EUT Exercise

The EUT was operated in the engineering mode to fix the Tx frequency that was for the purpose of the measurements.

2.5 Support Device

None

3. Conducted Emissions Test

3.1 Test SET-UP (Block Diagram of Configuration)

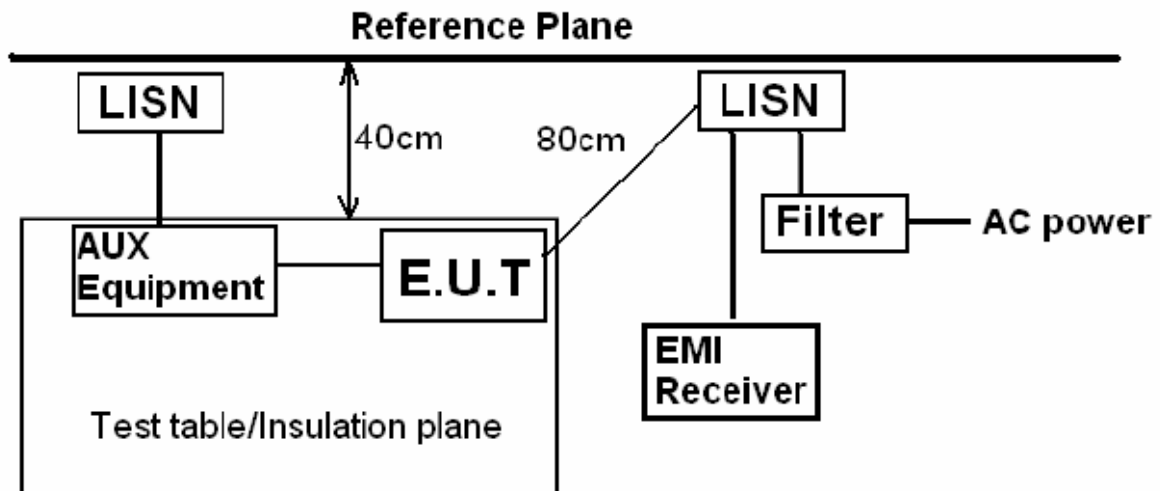

3.2 Test Condition

Test Requirement: FCC 15.207

Frequency Range: 150KHz ~ 30MHz

Detector: RBW 9KHz, VBW 30KHz

Operation Mode: BT Mode

3.3 Measurement Results

Please refer to following plots.

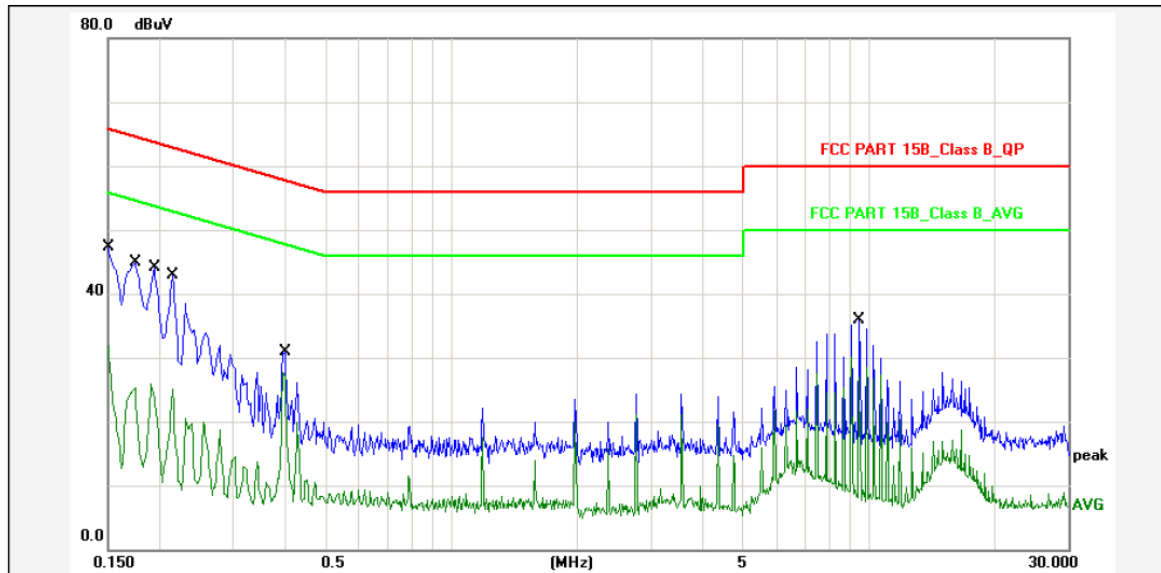

Report No.: bshelf model 1.1
 Test Standard: FCC PART 15B_Class B_QP
 Test item: Conducted Emission Phase: L1
 Applicant: KREAFUNK Temp.()/Hum.(%): 26(C) / 60 %
 Product: 2.0CH WOODEN SPEAKER Power Rating: AC 120V/60Hz
 Model No.: bshelf model 1.1 Test Engineer: Lecdon
 Test Mode: BT Mode
 Remark:

No.	Frequency (MHz)	Factor (dBuV)	Reading (dBuV)	Level (dBuV)	Limit (dBuV)	Margin (dB)	Detector	P/F	Remark
1	0.1500	10.80	34.40	45.20	65.99	-20.79	QP	P	
2	0.1500	10.80	19.10	29.90	55.99	-26.09	AVG	P	
3	0.1740	10.80	32.00	42.80	64.76	-21.96	QP	P	
4	0.1740	10.80	12.30	23.10	54.76	-31.66	AVG	P	
5	0.1940	10.80	31.50	42.30	63.86	-21.56	QP	P	
6	0.1940	10.80	13.10	23.90	53.86	-29.96	AVG	P	
7	0.2140	10.80	30.00	40.80	63.04	-22.24	QP	P	
8	0.2140	10.80	12.30	23.10	53.04	-29.94	AVG	P	
9	0.3980	10.80	18.00	28.80	57.89	-29.09	QP	P	
10	0.3980	10.80	14.80	25.60	47.89	-22.29	AVG	P	
11	9.4900	10.80	23.10	33.90	60.00	-26.10	QP	P	
12	9.4900	10.80	17.30	28.10	50.00	-21.90	AVG	P	

Note: Level=Reading+Factor.

Margin=Limit-Level.

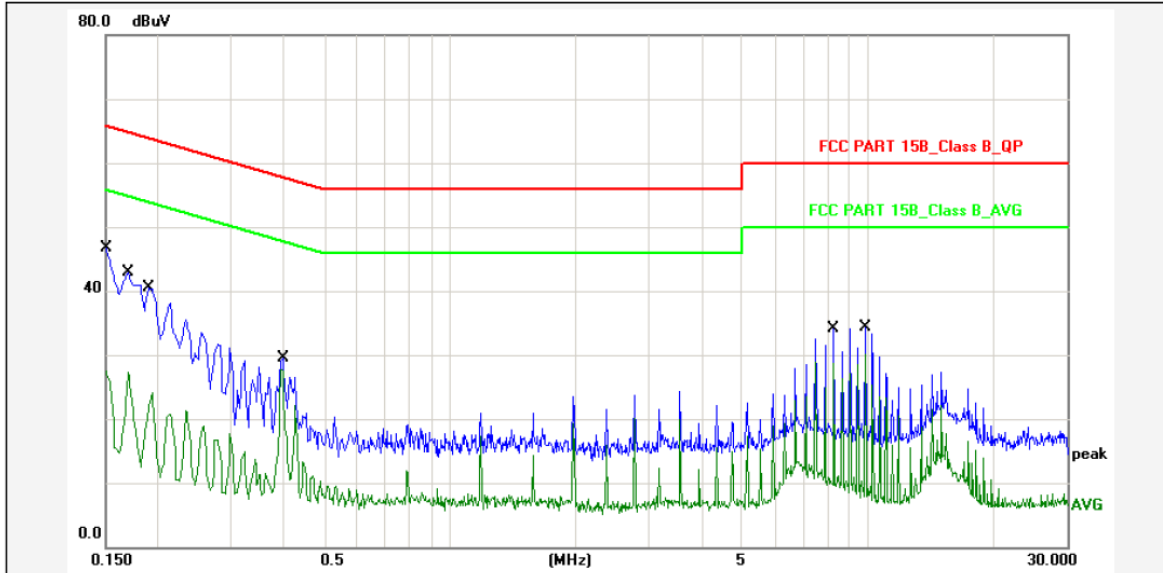

Report No.: bshelf model 1.1
 Test Standard: FCC PART 15B_Class B_QP
 Test item: Conducted Emission
 Applicant: KREAFUNK
 Product: 2.0CH WOODEN SPEAKER
 Model No.: bshelf model 1.1
 Phase: N
 Temp.()/Hum.(%): 26(C) / 60 %
 Power Rating: AC 120V/60Hz
 Test Engineer: Lecdon
 Test Mode: BT Mode
 Remark:

No.	Frequency (MHz)	Factor (dBuV)	Reading (dBuV)	Level (dBuV)	Limit (dBuV)	Margin (dB)	Detector	P/F	Remark
1	0.1500	10.80	33.90	44.70	65.99	-21.29	QP	P	
2	0.1500	10.80	14.60	25.40	55.99	-30.59	AVG	P	
3	0.1700	10.80	30.00	40.80	64.96	-24.16	QP	P	
4	0.1700	10.80	14.50	25.30	54.96	-29.66	AVG	P	
5	0.1900	10.80	27.60	38.40	64.03	-25.63	QP	P	
6	0.1900	10.80	11.30	22.10	54.03	-31.93	AVG	P	
7	0.3980	10.80	16.70	27.50	57.89	-30.39	QP	P	
8	0.3980	10.80	15.10	25.90	47.89	-21.99	AVG	P	
9	8.3059	10.80	21.30	32.10	60.00	-27.90	QP	P	
10	8.3059	10.80	16.20	27.00	50.00	-23.00	AVG	P	
11	9.8817	10.80	21.40	32.20	60.00	-27.80	QP	P	
12	9.8817	10.80	17.40	28.20	50.00	-21.80	AVG	P	

Note: Level=Reading+Factor.

Margin=Limit-Level.

4. Radiated Emission Test

4.1 Test SET-UP (Block Diagram of Configuration)

Radiated Emission Test Set-Up, Frequency Below 30MHz

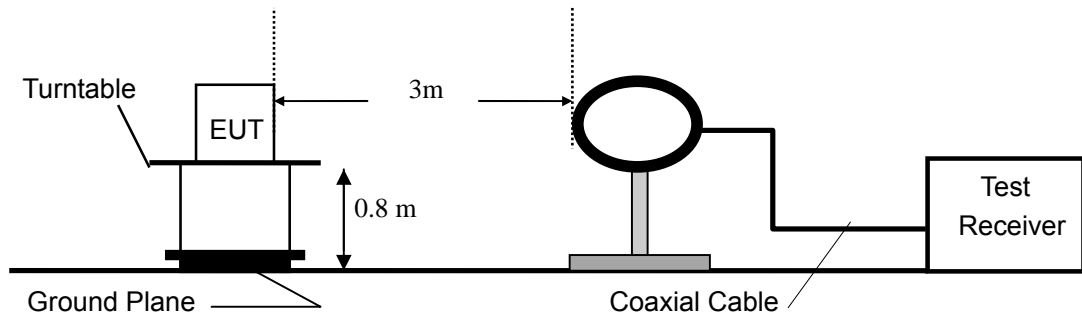

Radiated Emission Test Set-Up, Frequency Below 1GHz

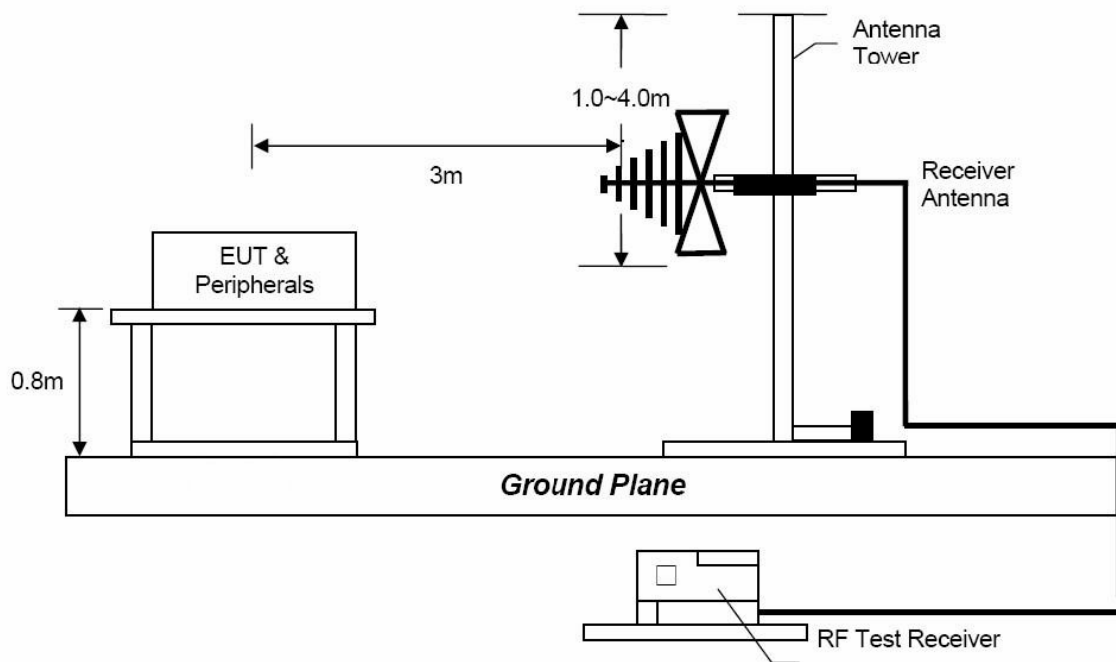

Radiated Emission Test Set-Up, Frequency above 1GHz

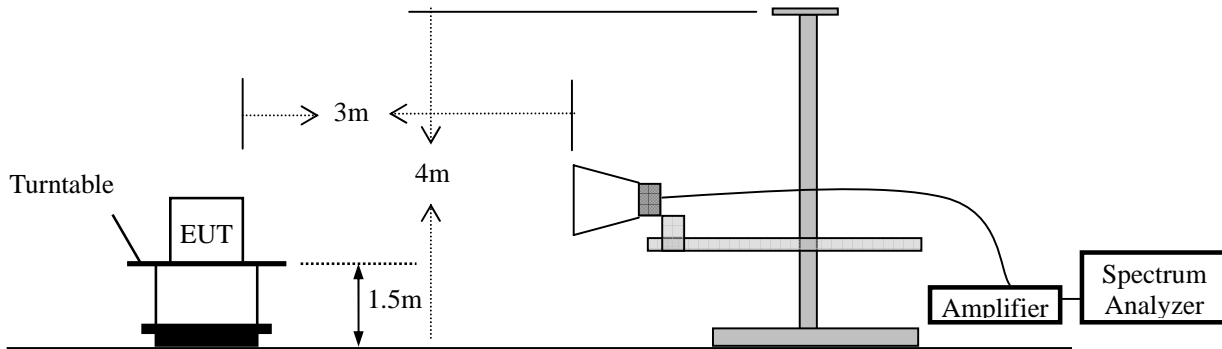

4.2 Measurement Procedure

- Below 1GHz, the EUT was placed on the top of a rotating table 0.8 meters above the ground at a 3 meter semi- anechoic chamber room. Above 1GHz, the EUT was placed on the top of a rotating table 1.5 meters above the ground at a 3 meter semi- anechoic chamber room. The table was rotated 360 degrees to determine the position of the highest radiation.
- The EUT was set 3 meters away from the interference-receiving antenna, which was mounted on the top of a variable-height antenna tower.
- The height of antenna is varied from one meter to four meters above the ground to determine the maximum value of the field strength. Both horizontal and vertical polarizations of the antenna are set to make the measurement.
- For each suspected emission, the EUT was arranged to its worst case and then the antenna was tuned to heights from 1 meter to 4 meters and the rotatable table was turned from 0 degrees to 360 degrees to find the maximum reading. The test-receiver system was set to peak detect function and specified bandwidth with maximum hold mode.
- A Quasi-peak measurement was then made for that frequency point for below 1GHz test. PK and AV for above 1GHz emission test.

For 30MHz to 1GHz:

Set the spectrum analyzer as: RBW=120kHz, VBW=300kHz, Detector=Quasi-Peak

For Above 1GHz:

Set the spectrum analyzer as: RBW=1MHz, VBW=3MHz, Detector=Peak.

Set the spectrum analyzer as: RBW=1MHz, VBW=10Hz, Detector=Peak.

During the radiated emission test, the spectrum analyzer was set with the following configurations:

Frequency Band (MHz)	Level	Resolution Bandwidth	Video Bandwidth
30 to 1000	QP	120 kHz	300 kHz
Above 1000	Peak	1 MHz	3 MHz
	Average	1 MHz	10 Hz

4.3 Limit

Frequency range MHz	Distance Meters	Field Strengths Limit
		$\mu\text{V/m}$
0.009 ~ 0.490	300	2400/F(kHz)
0.490 ~ 1.705	30	24000/F(kHz)
1.705 ~ 30	30	30
30 ~ 88	3	100
88 ~ 216	3	150
216 ~ 960	3	200
Above 960	3	500

- Remark :
- (1) Emission level (dB) μV = 20 log Emission level $\mu\text{V/m}$
 - (2) The smaller limit shall apply at the cross point between two frequency bands.
 - (3) For frequencies above 1000MHz, the field strength limits are based on average detector, however, the peak field strength of any emission shall not exceed the maximum permitted average limits, specified above by more than 20dB under any condition of modulation.
 - (4) The frequency range scanned is from the lowest radio frequency signal generated in the device which is greater than 9 kHz to the tenth harmonic of the highest fundamental frequency or 40 GHz, whichever is lower.

4.4 Measurement Results

PASS

Please refer to the following pages.

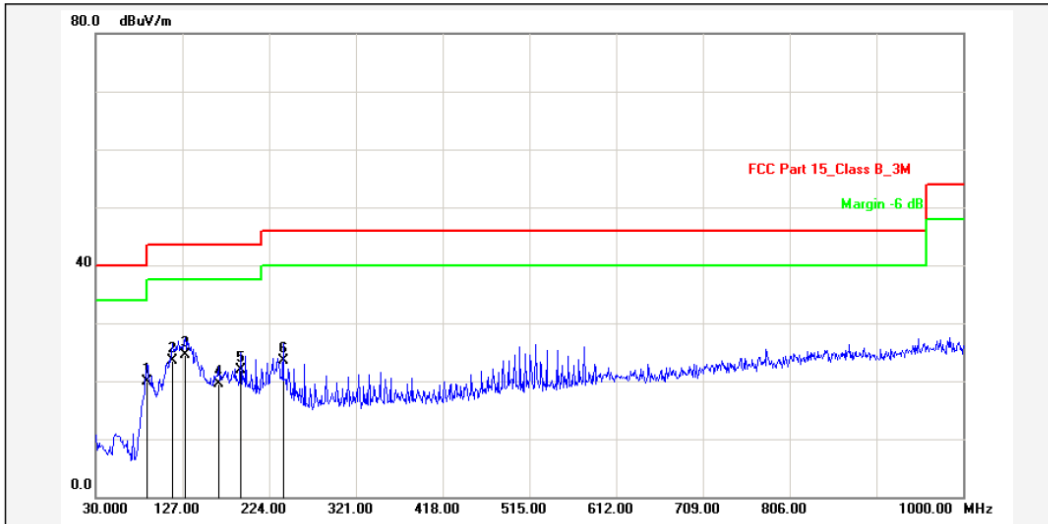

Report No.: bshelf model 1.1
 Test Standard: FCC Part 15_Class B_3M
 Test item: Radiation Emission
 Applicant: KREAFUNK
 Product: 2.0CH WOODEN SPEAKER
 Model No.: bshelf model 1.1
 Test Mode: TX(BT 2.1)
 Remark:

Test Distance:
 Ant. Polarization: Horizontal
 Temp.(C)/Hum.(%): 21(C) / 55 %
 Power Rating: AC 120V/60Hz
 Test Engineer: Jason

No.	Frequency (MHz)	Factor (dB/m)	Reading (dBuV)	Level (dBuV/m)	Limit (dBuV/m)	Margin (dB)	Detector	Height (cm)	Azimuth (deg.)	P/F	Remark
1	87.2300	-14.61	34.42	19.81	40.00	-20.19	QP			P	
2	115.3600	-13.04	36.46	23.42	43.50	-20.08	QP			P	
3	129.9100	-15.15	39.74	24.59	43.50	-18.91	QP			P	
4	167.7400	-14.89	34.39	19.50	43.50	-24.00	QP			P	
5	191.9900	-13.51	35.35	21.84	43.50	-21.66	QP			P	
6	239.5200	-12.06	35.61	23.55	46.00	-22.45	QP			P	

Note: Level=Reading+Factor.
 Margin=Limit-Level.

Below 30MHz, the emissions are lower than 20dB below the allowable limit.

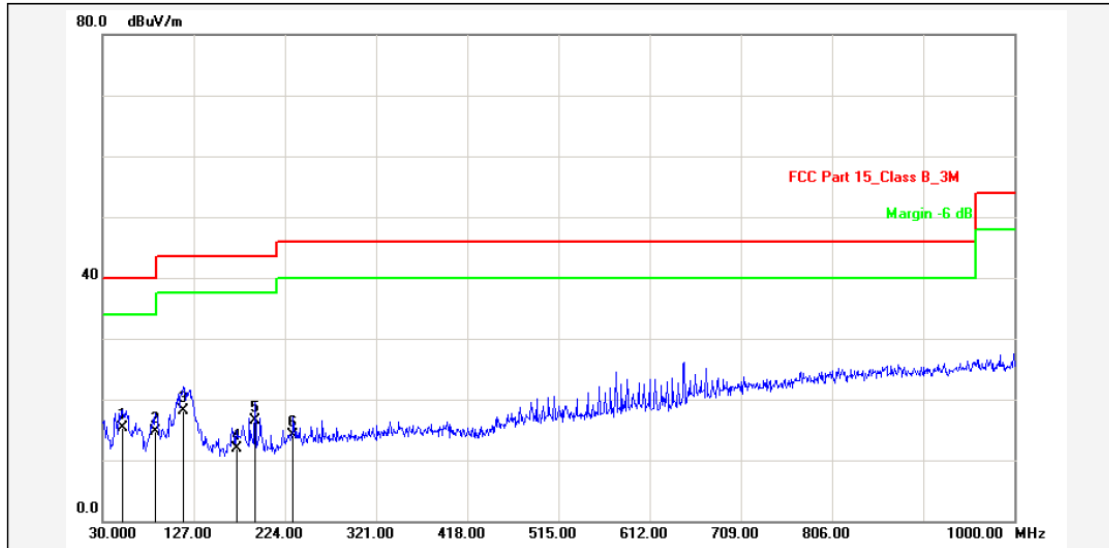

Report No.:	bshelf model 1.1	Test Standard:	FCC Part 15_Class B_3M	Test Distance:	
Test item:	Radiation Emission	Ant. Polarization:	Vertical	Temp.(C)/Hum.(%):	21(C) / 55 %
Applicant:	KREAFUNK	Power Rating:	AC 120V/60Hz	Test Engineer:	Jason
Product:	2.0CH WOODEN SPEAKER				
Model No.:	bshelf model 1.1				
Test Mode:	TX(BT 2.1)				
Remark:					

No.	Frequency (MHz)	Factor (dB/m)	Reading (dBuV)	Level (dBuV/m)	Limit (dBuV/m)	Margin (dB)	Detector	Height (cm)	Azimuth (deg.)	P/F	Remark
1	51.3400	-13.46	28.80	15.34	40.00	-24.66	QP			P	
2	86.2600	-17.87	32.54	14.67	40.00	-25.33	QP			P	
3	115.3600	-16.04	34.23	18.19	43.50	-25.31	QP			P	
4	172.5900	-17.65	29.47	11.82	43.50	-31.68	QP			P	
5	191.9900	-16.51	33.10	16.59	43.50	-26.91	QP			P	
6	232.7300	-15.33	29.38	14.05	46.00	-31.95	QP			P	

Note: Level=Reading+Factor.

Margin=Limit-Level.

Below 30MHz, the emissions are lower than 20dB below the allowable limit.



Modulation: 8DPSK (the worst case)
 Frequency Range: 1-25GHz Test Date : December 05, 2014
 Test Result: PASS Temperature : 24 °C
 Measured Distance: 3m Humidity : 53 %
 Test By: Sance

Freq. (MHz)	Ant.Pol. (H/V)	Reading Level(dBuV)		Factor (dB/m)	Emission Level (dBuV)		Limit 3m (dBuV/m)		Margin (dB)	
		PK	AV		PK	AV	PK	AV	PK	AV
Operation Mode: TX Mode (Low)										
4804	V	47.74	28.24	14.63	62.37	42.87	74.00	54.00	-11.63	-11.13
7206	V	39.52	20.93	20.68	60.20	41.61	74.00	54.00	-13.80	-12.39

4804	H	49.47	30.83	14.63	64.10	45.46	74.00	54.00	-9.90	-8.54
7206	H	39.37	25.13	20.68	60.05	45.81	74.00	54.00	-13.95	-8.19

Operation Mode: TX Mode (Mid)										
4882	V	48.95	30.24	14.97	63.92	45.21	74.00	54.00	-10.08	-8.79
7323	V	39.52	21.59	20.91	60.43	42.50	74.00	54.00	-13.57	-11.50

4882	H	47.69	27.27	14.97	62.66	42.24	74.00	54.00	-11.34	-11.76
7323	H	37.90	19.63	20.91	58.81	40.54	74.00	54.00	-15.19	-13.46

Operation Mode: TX Mode (High)										
4960	V	47.20	34.77	15.30	62.50	50.07	74.00	54.00	-11.50	-3.93
7440	V	39.53	25.58	21.16	60.69	46.74	74.00	54.00	-13.31	-7.26

4960	H	49.27	34.04	15.30	64.57	49.34	74.00	54.00	-9.43	-4.66
7440	H	39.94	25.43	21.16	61.10	46.59	74.00	54.00	-12.90	-7.41

- Note:**
- (1) All Readings are Peak Value and AV.
 - (2) Emission Level= Reading Level + Factor
 - (3) Factor= Antenna Gain + Cable Loss – Amplifier Gain
 - (4) Data of measurement within this frequency range shown “ ---” in the table above means the reading of emissions are attenuated more than 10dB below the permissible limits.
 - (5) Measurement uncertainty : ±3.7dB.
 - (6) Horn antenna used for the emission over 1000MHz.

5. Channel Separation test

5.1 Measurement Procedure

Minimum Hopping Channel Carrier Frequency Separation, FCC Rule 15.247(a)(1):

Connect EUT antenna terminal to the spectrum analyzer with a low loss cable, and using the MARKER and Max-Hold function to record the separation of two adjacent channels.

5.2 Test SET-UP (Block Diagram of Configuration)

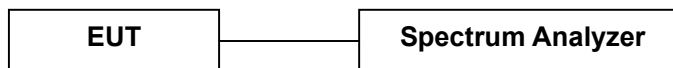

5.3 Measurement Results

Modulation:	GFSK, $\pi/4$ -DQPSK, 8DPSK		
RBW:	100KHz	VBW:	300KHz
Packet:	DH5	Spectrum Detector:	PK
Test By:	Sance	Test Date :	Dec. 05, 2014
Temperature :	21 °C	Humidity :	55 %
Test Result:	PASS		

Channel number	Channel frequency (MHz)	Separation Read Value (KHz)	Separation Limit (KHz)
GFSK			
Lowest	2402	1000	>659
Middle	2441	1000	>659
Highest	2480	1000	>659
$\pi/4$ -DQPSK			
Lowest	2402	1000	>842.7
Middle	2441	1005	>833.3
Highest	2480	1005	>833.3
8DPSK			
Lowest	2402	1005	>830.1
Middle	2441	1005	>846.0
Highest	2480	1000	>842.7

GFSK Lowest Channel

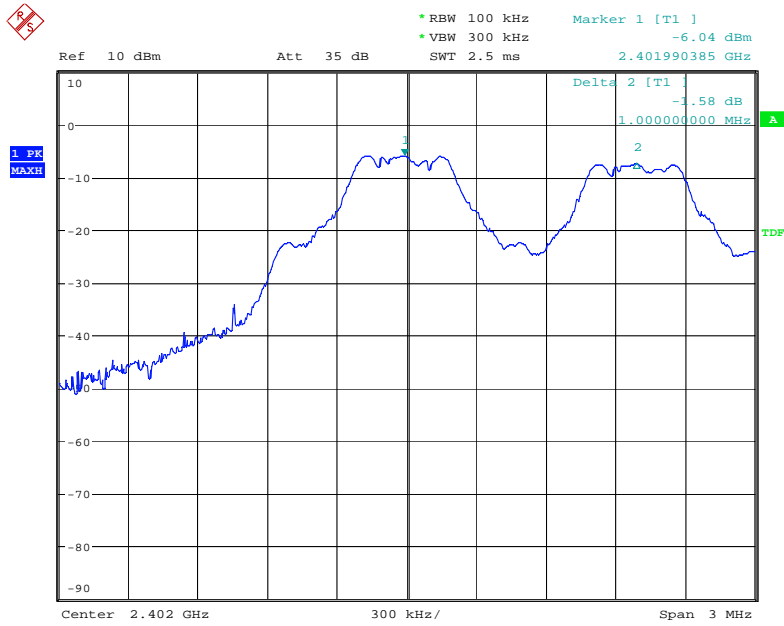

Date: 5.DEC.2014 14:07:23

GFSK Middle Channel

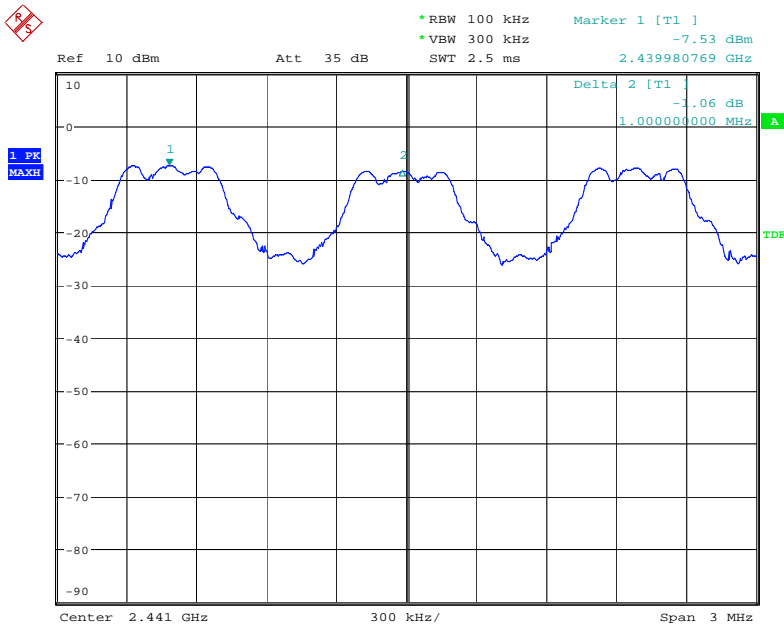

Date: 5.DEC.2014 14:08:46

GFSK Highest Channel

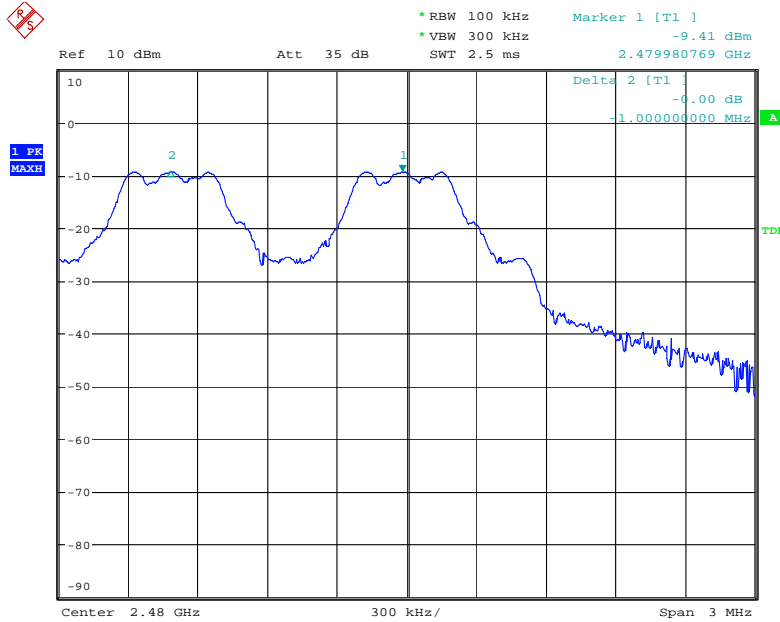

Date: 5.DEC.2014 14:09:55

$\pi/4$ -DQPSK Lowest Channel

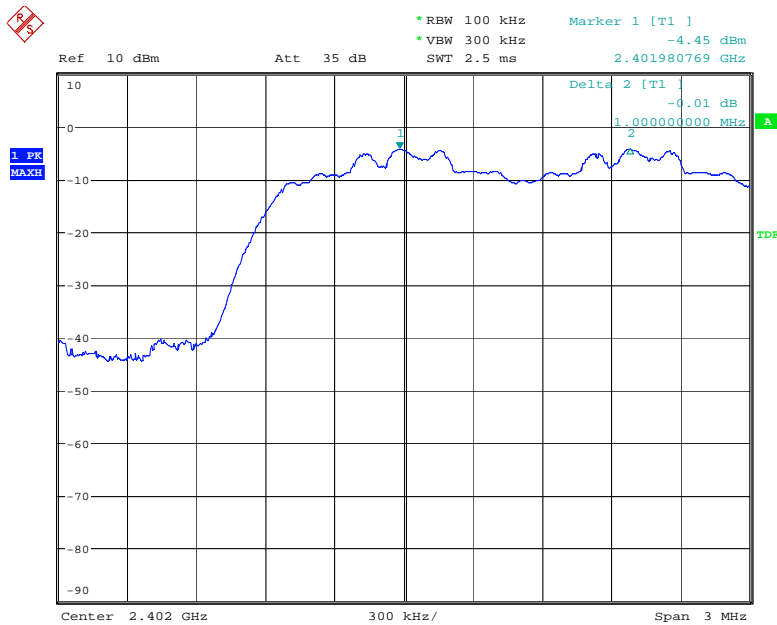

Date: 5.DEC.2014 18:42:06

$\pi/4$ -DQPSK Middle Channel

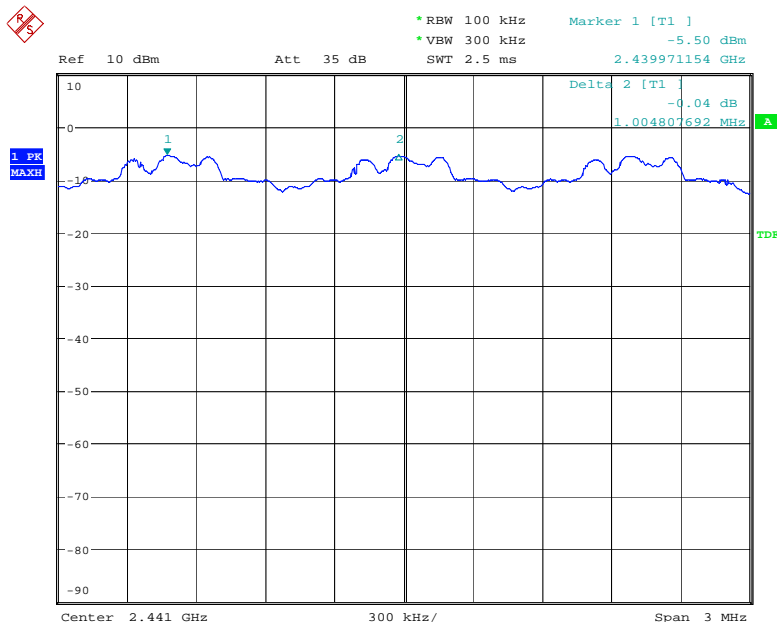

Date: 5.DEC.2014 18:44:05

$\pi/4$ -DQPSK Highest Channel

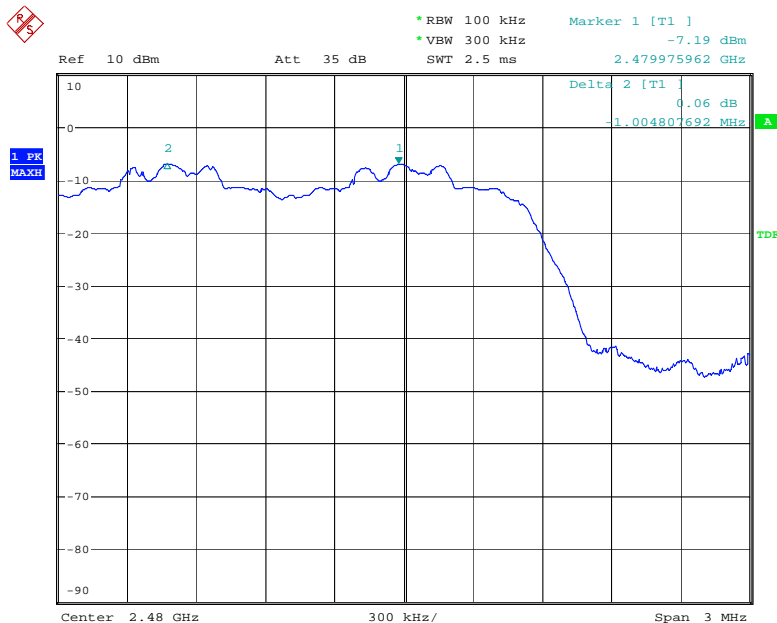

Date: 5.DEC.2014 18:45:15

8DPSK Lowest Channel

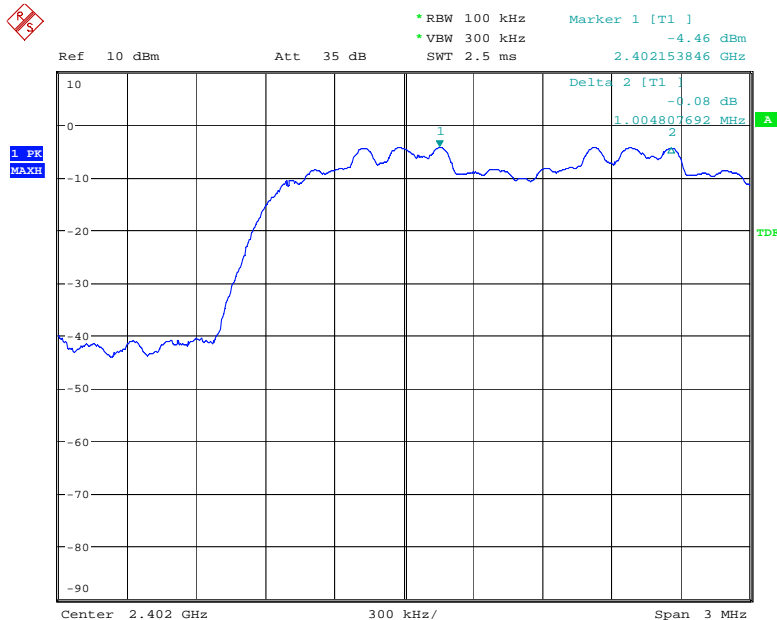

Date: 5.DEC.2014 18:53:36

8DPSK Middle Channel

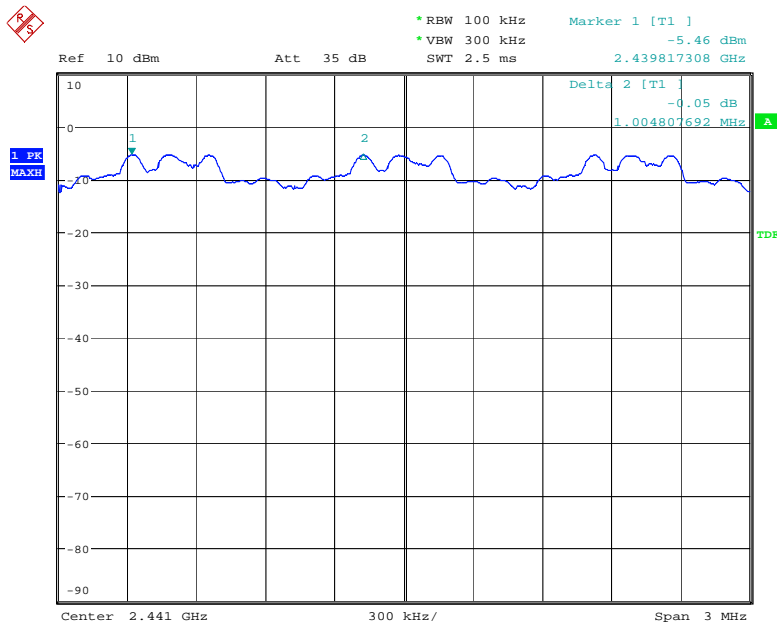

Date: 5.DEC.2014 18:55:35

8DPSK Highest Channel

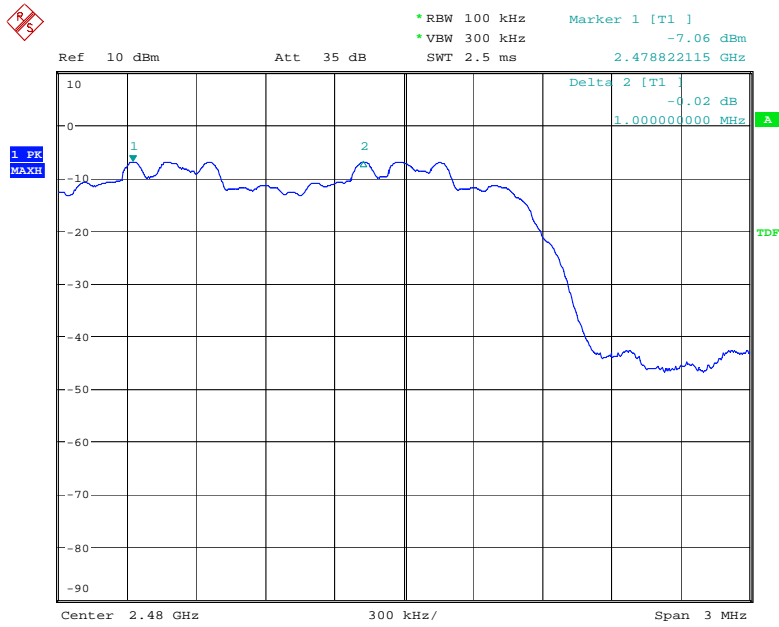

Date: 5.DEC.2014 18:57:02

6. 20dB Bandwidth

6.1 Measurement Procedure

Maximum 20dB RF Bandwidth, FCC Rule 15.247(a)(1):

The antenna port of the EUT was connected to the input of a spectrum analyzer. Analyzer RBW was chosen so that the display was a result of the hopping channel modulation. For each RF output channel investigated, the spectrum analyzer center frequency was set to the channel carrier. Use the spectrum 20dB down delta function to measure the bandwidth.

6.2 Test SET-UP (Block Diagram of Configuration)

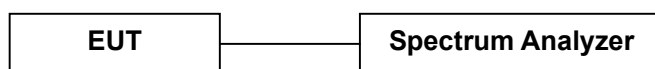

6.3 Measurement Results

Refer to attached data chart.

Modulation:	GFSK, $\pi/4$ -DQPSK, 8DPSK		
RBW:	30KHz	VBW:	100KHz
Packet:	DH5	Spectrum Detector:	PK
Test By:	Sance	Test Date :	Dec. 05, 2014
Temperature :	21 °C	Humidity :	52 %
Test Result:	PASS		

Channel frequency (MHz)	20dB Down BW(kHz)
GFSK	
2402	659
2441	659
2480	659
$\pi/4$-DQPSK	
2402	1264
2441	1250
2480	1250
8DPSK	
2402	1245
2441	1269
2480	1264

GFSK Lowest Channel



Date: 5.DEC.2014 13:20:37

GFSK Middle Channel

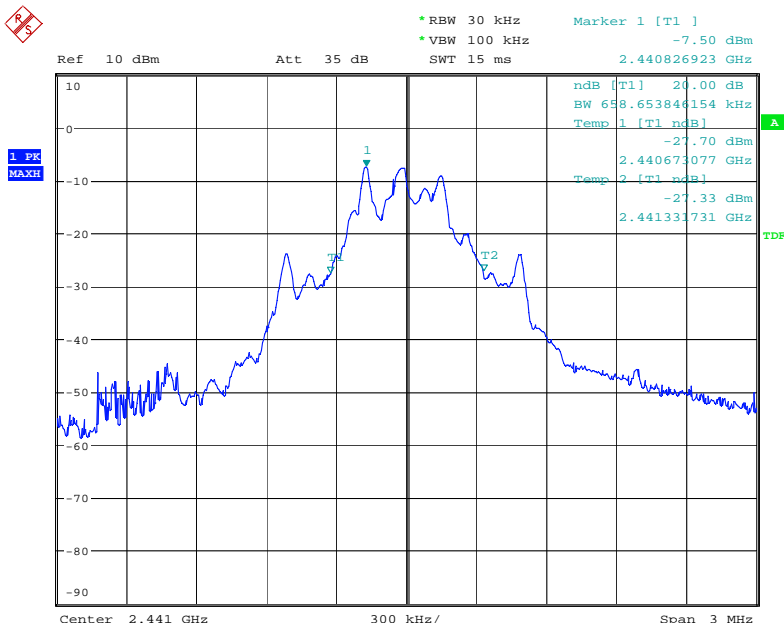

Date: 5.DEC.2014 13:21:31

GFSK Highest Channel

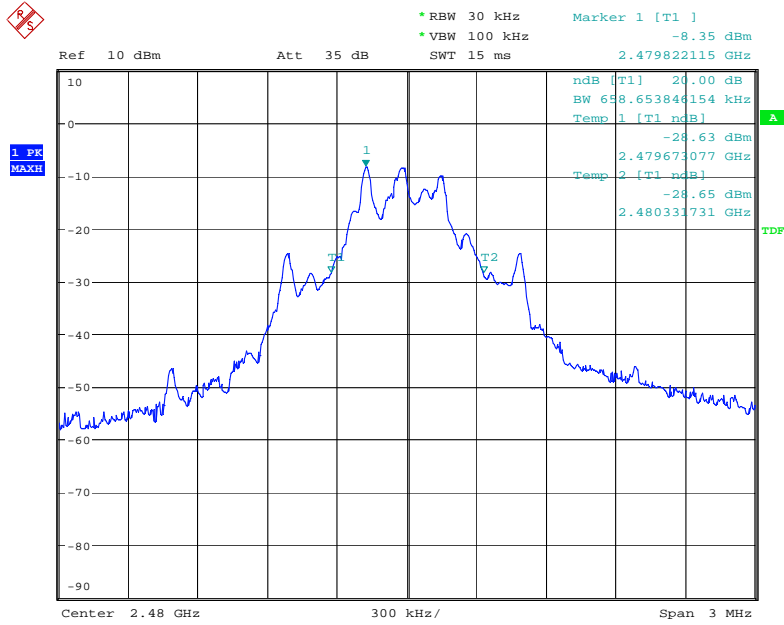

Date: 5.DEC.2014 13:22:22

$\pi/4$ -DQPSK Lowest Channel

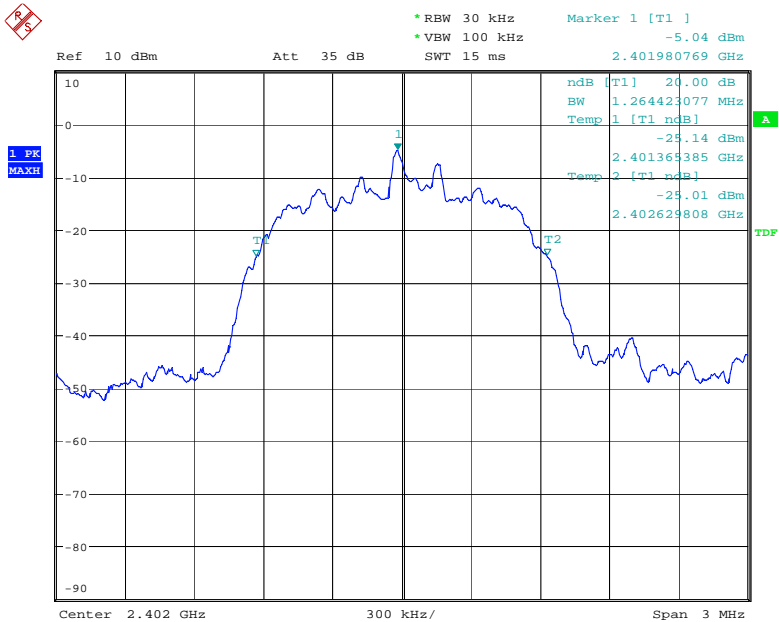

Date: 5.DEC.2014 18:35:49

$\pi/4$ -DQPSK Middle Channel

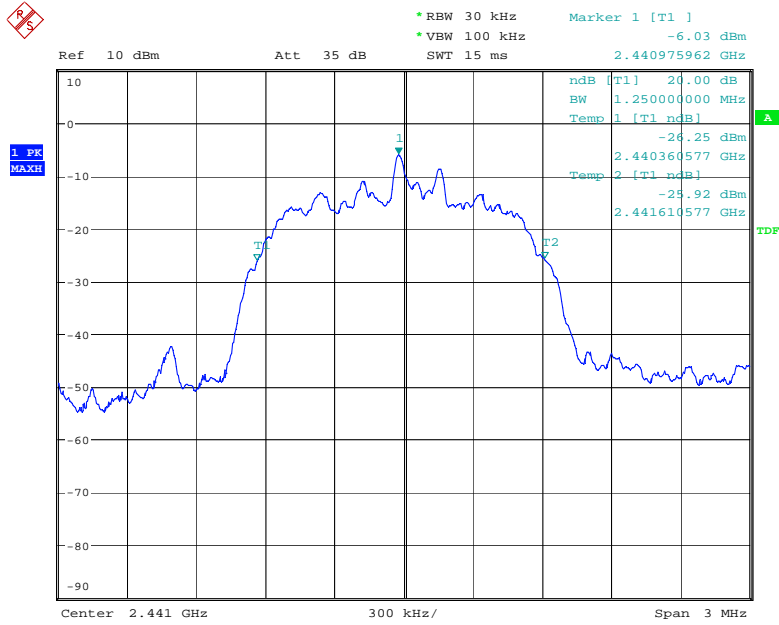

Date: 5.DEC.2014 18:36:42

$\pi/4$ -DQPSK Highest Channel

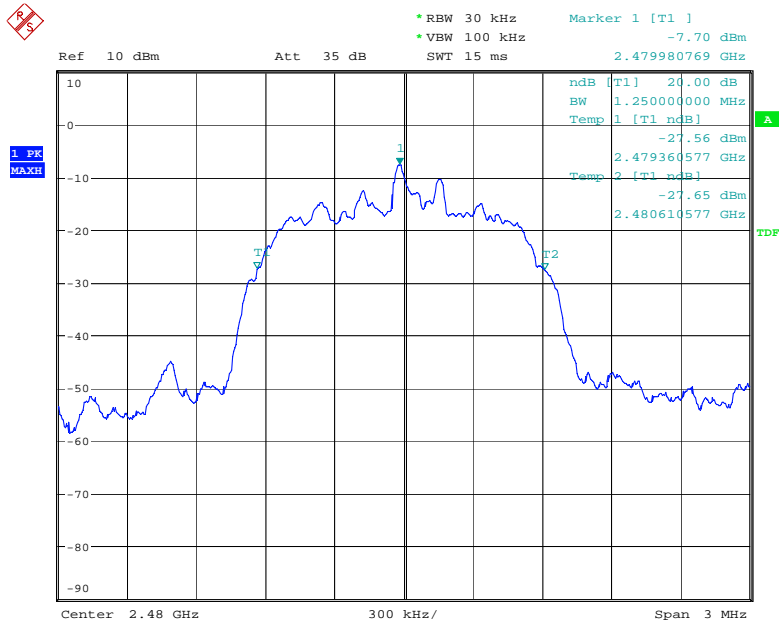

Date: 5.DEC.2014 18:37:30

8DPSK Lowest Channel

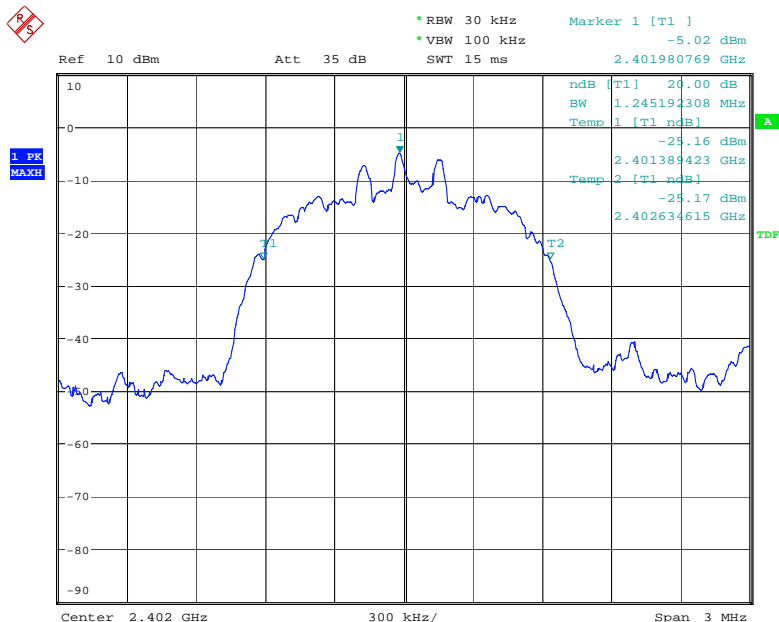

Date: 5.DEC.2014 18:50:17

8DPSK Middle Channel

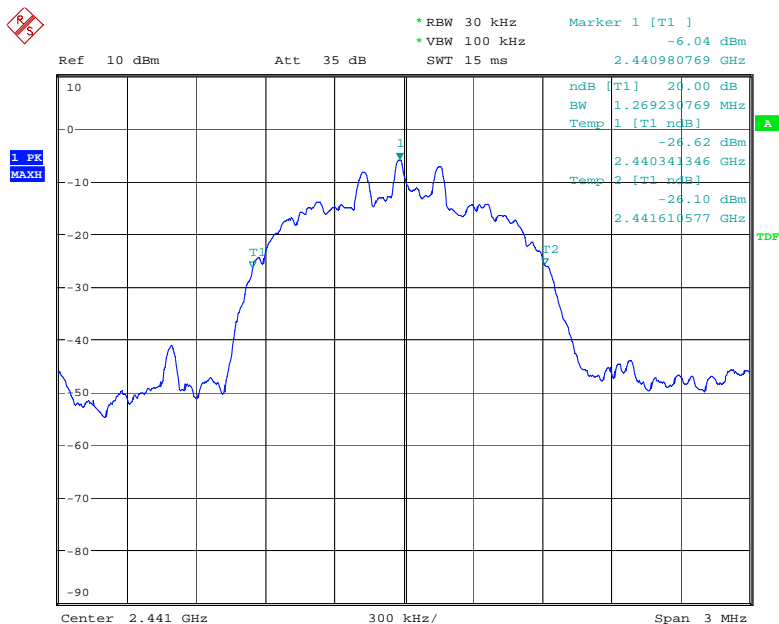

Date: 5.DEC.2014 18:51:24

8DPSK Highest Channel

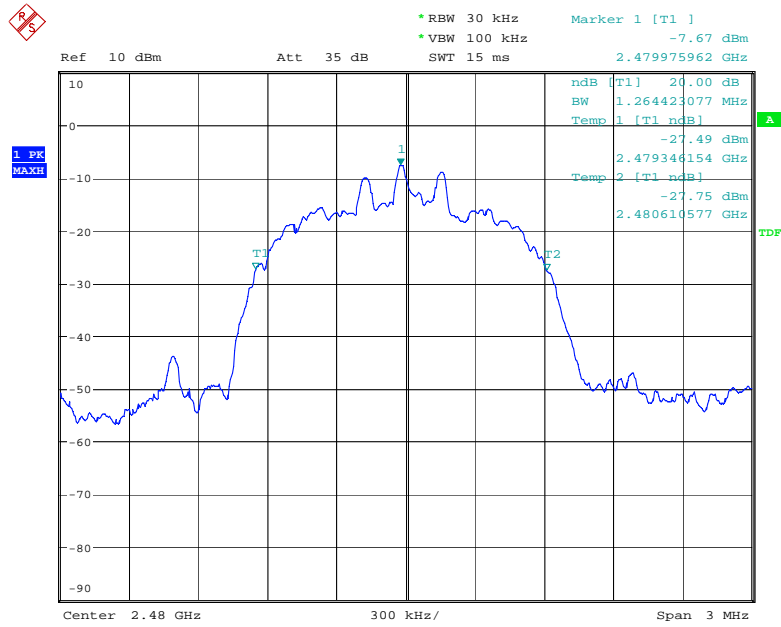

Date: 5.DEC.2014 18:52:11

7. Hopping Channel Number

7.1 Measurement Procedure

Minimum Number of Hopping Frequencies, FCC Rule 15.247(a)(1)(iii):

Remove the antenna from the EUT and then connect a low RF cable from the antenna port to the spectrum, and the spectrum analyzer set to MAX HOLD readings were taken for 3-5 minutes. The channel peaks so recorded were added together, and the total number compared to the minimum number of channels required in the regulation.

7.2 Test SET-UP (Block Diagram of Configuration)

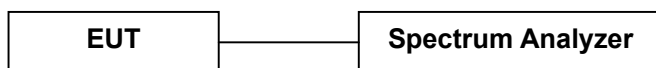

7.3 Measurement Results

Modulation	GFSK, $\pi/4$ -DQPSK, 8DPSK		
RBW:	100KHz	VBW:	300KHz
Packet:	DH5	Spectrum Detector:	PK
Test By:	Sance	Test Date :	Dec. 05, 2014
Temperature :	21 °C	Humidity :	52 %
Test Result:	PASS		

Hopping Channel Frequency Range	Number of Hopping Channels	Limit
2402-2480	79	≥ 15

The worst case: 8DPSK

8DPSK

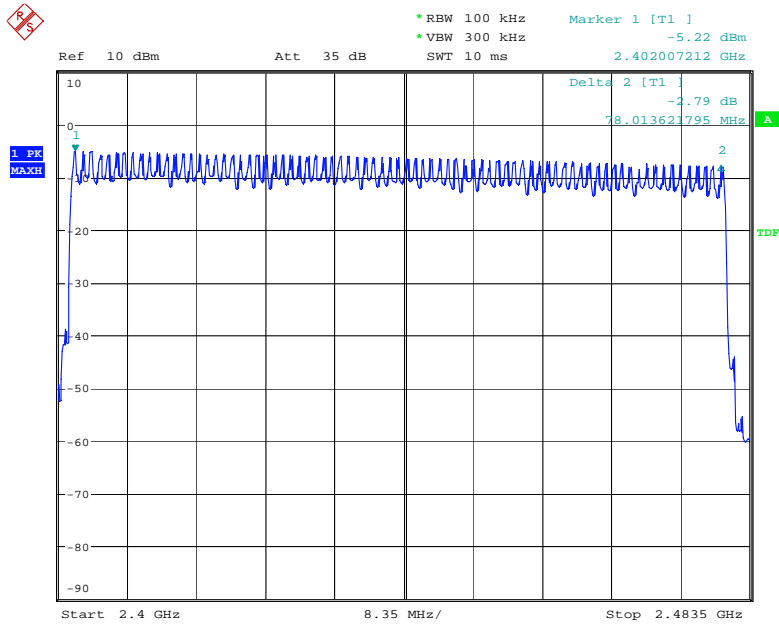

Date: 5.DEC.2014 19:19:29

8. Time of Occupancy (Dwell Time)

8.1 Measurement Procedure

Average Channel Occupancy Time, FCC Ref:15.247(a)(1)(iii):

Connect EUT antenna terminal to the spectrum analyzer with a low loss cable. The spectrum analyzer center frequency was set to one of the known hopping channels. The Sweep was set to 10 ms, the SPAN was set to Zero SPAN. The time duration of the transmissions so captured was measured with the Marker Delta function

8.2 Measurement Results

The maximum number of hopping channels in 31.6s (0.4s/Channel x 79 Channel)

Refer to attached data chart.

Modulation :	GFSK, $\pi/4$ -DQPSK, 8DPSK		
RBW :	1MHz	VBW :	3MHz
Spectrum Detector:	PK	Test By:	Sance
Test Date :	Dec. 05, 2014	Temperature :	21°C
Test Result:	PASS	Humidity :	52 %

Packet	Frequency (MHz)	Result (msec)	Limit (msec)
GFSK			
DH1	2441	$0.497 \text{ (ms)} * (1600 / (2 * 79)) * 31.6 = 159.0$	400
DH3	2441	$1.751 \text{ (ms)} * (1600 / (4 * 79)) * 31.6 = 280.2$	400
DH5	2441	$2.933 \text{ (ms)} * (1600 / (6 * 79)) * 31.6 = 312.9$	400
$\pi/4$-DQPSK			
2-DH1	2441	$0.509 \text{ (ms)} * (1600 / (2 * 79)) * 31.6 = 162.9$	400
2-DH3	2441	$1.759 \text{ (ms)} * (1600 / (4 * 79)) * 31.6 = 281.4$	400
2-DH5	2441	$2.997 \text{ (ms)} * (1600 / (6 * 79)) * 31.6 = 319.7$	400
8DPSK			
3-DH1	2441	$0.509 \text{ (ms)} * (1600 / (2 * 79)) * 31.6 = 162.9$	400
3-DH3	2441	$1.751 \text{ (ms)} * (1600 / (4 * 79)) * 31.6 = 280.2$	400
3-DH5	2441	$3.013 \text{ (ms)} * (1600 / (6 * 79)) * 31.6 = 321.4$	400

GFSK DH1

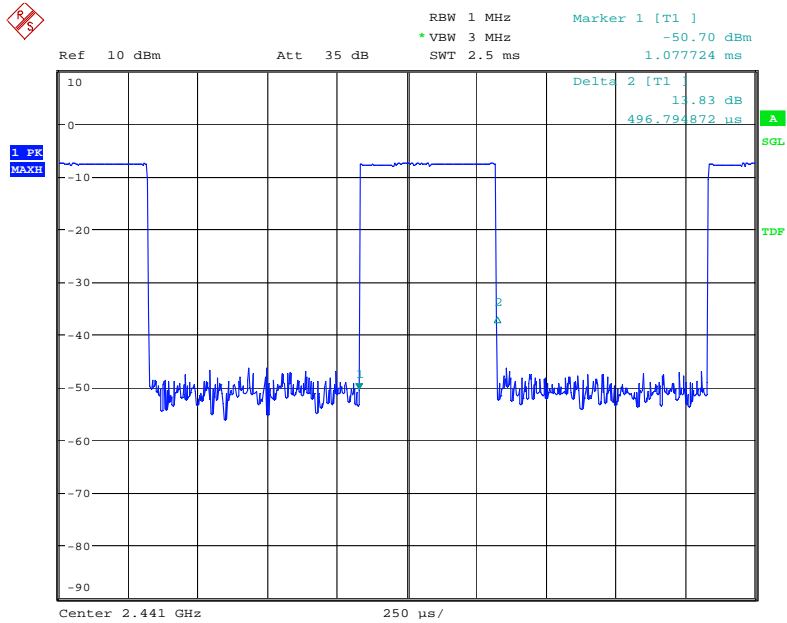

Date: 5.DEC.2014 14:46:19

GFSK DH3

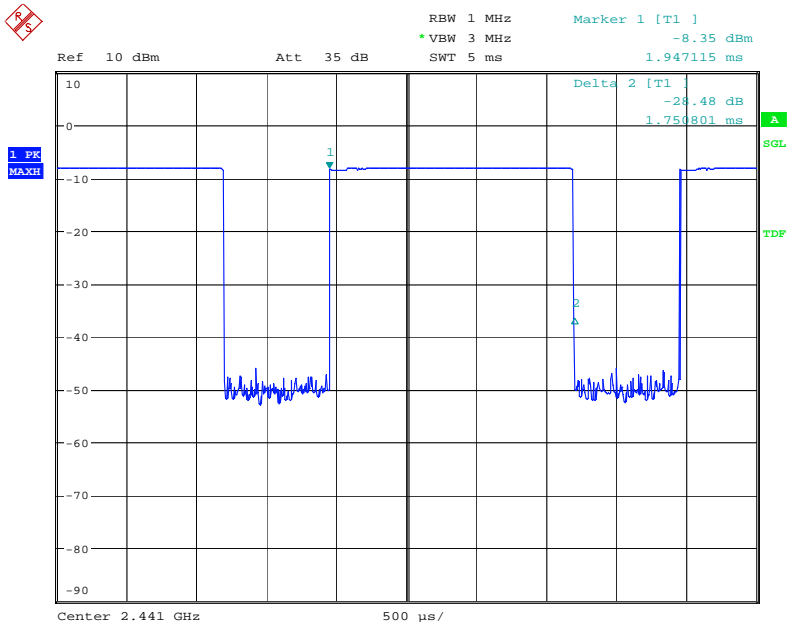

Date: 5.DEC.2014 14:46:44

GFSK DH5

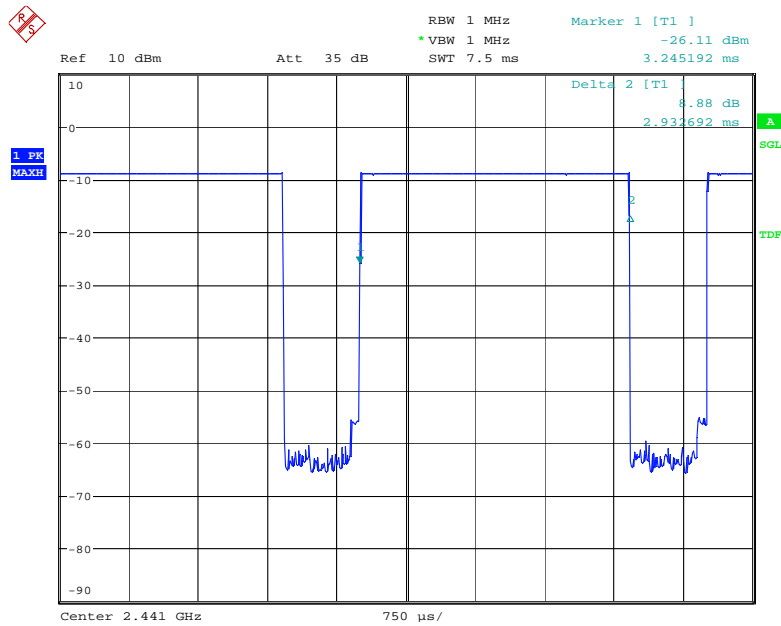

Date: 5.DEC.2014 18:43:49

$\pi/4$ -DQPSK 2-DH1

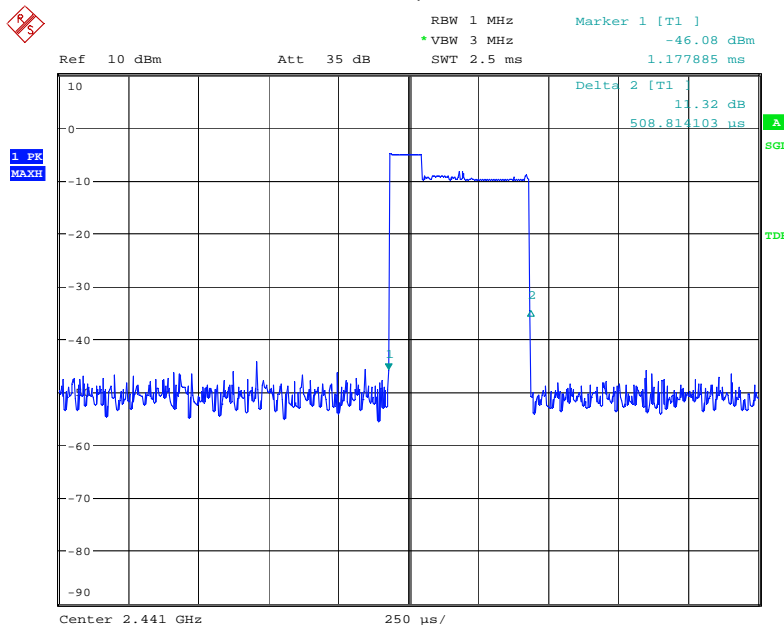

Date: 5.DEC.2014 14:47:41

$\pi/4$ -DQPSK 2-DH3

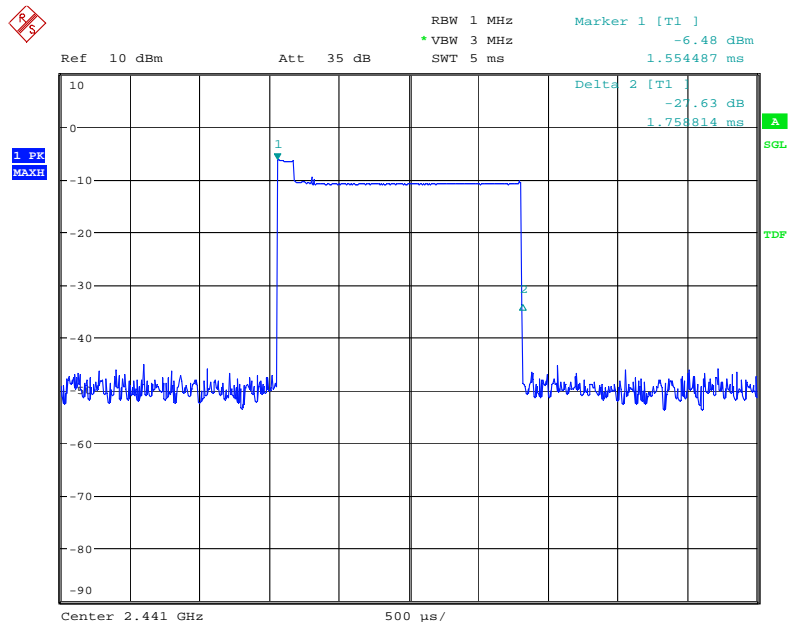

Date: 5.DEC.2014 14:48:05

$\pi/4$ -DQPSK 2-DH5

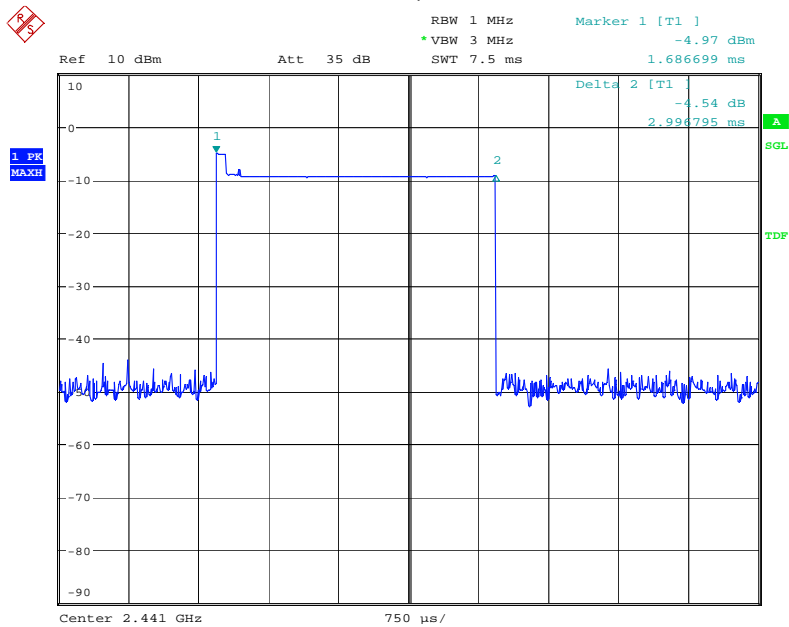

Date: 5.DEC.2014 14:48:26

8DPSK 3-DH1

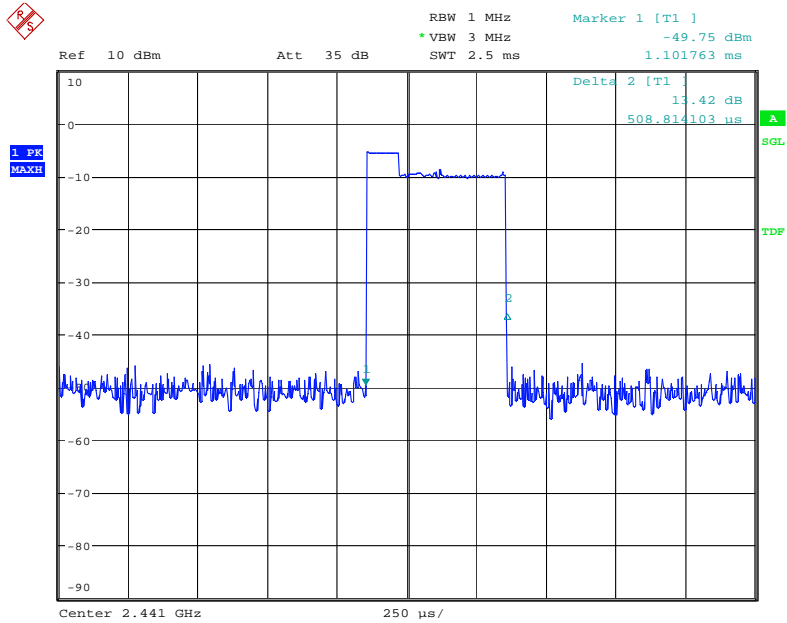

Date: 5.DEC.2014 14:48:54

8DPSK 3-DH3

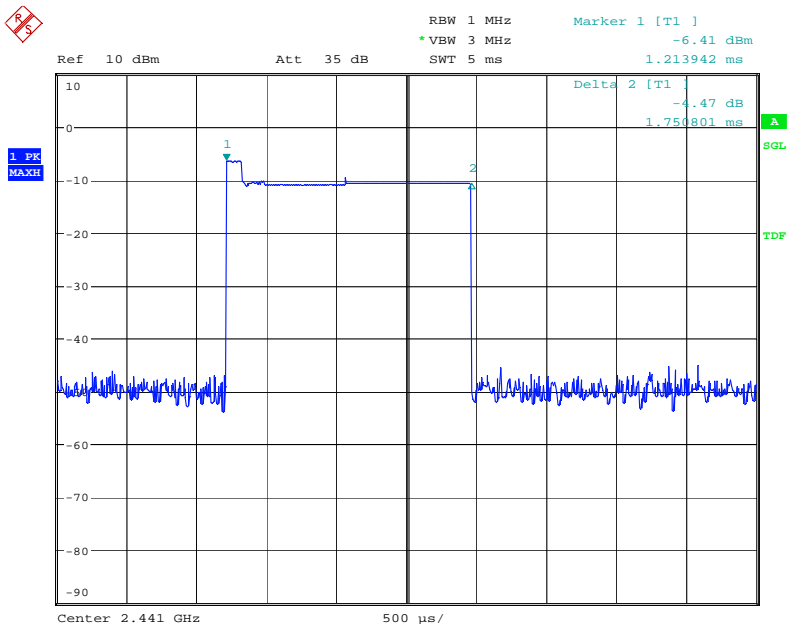

Date: 5.DEC.2014 14:49:18

8DPSK 3-DH5

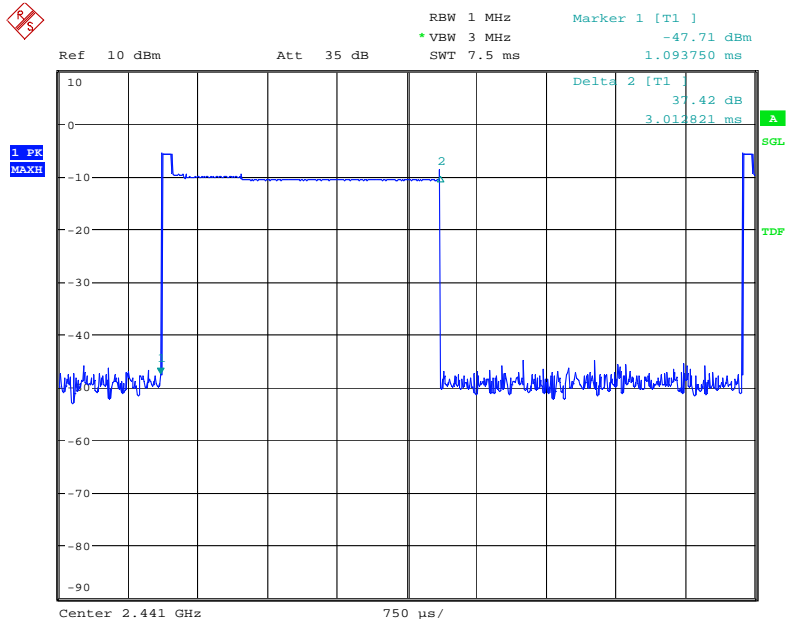

Date: 5.DEC.2014 14:49:43

9. MAXIMUM PEAK OUTPUT POWER

9.1 Measurement Procedure

Maximum Conducted Output Power at Antenna Terminals, FCC Rules 15.247(b)(1):

Remove the antenna from the EUT and then connect a low RF cable from the antenna port to the spectrum. The analyzer was set for RBW > 20dB bandwidth and power was read directly in dBm. Cable loss was considered during this measurement.

9.2 Measurement Results

Refer to attached data chart.

Modulation :	GFSK, $\pi/4$ -DQPSK, 8DPSK		
RBW :	3MHz	VBW :	3MHz
Spectrum Detector:	PK	Test Date :	Dec. 05, 2014
Test By:	Sance	Temperature :	21 °C
Test Result:	PASS	Humidity :	52 %

Channel Frequency (MHz)	Cable Loss dB	Peak Power output(mW)	Peak Power output(dBm)	Peak Power Limit(dBm)	Pass/Fail
GFSK					
2402.00	1.5	0.27	-5.71	30	PASS
2441.00	1.5	0.19	-7.20	30	PASS
2480.00	1.5	0.13	-8.82	30	PASS
$\pi/4$-DQPSK					
2402.00	1.5	0.44	-3.56	21	PASS
2441.00	1.5	0.36	-4.46	21	PASS
2480.00	1.5	0.25	-6.03	21	PASS
8DPSK					
2402.00	1.5	0.50	-3.05	21	PASS
2441.00	1.5	0.38	-4.24	21	PASS
2480.00	1.5	0.27	-5.76	21	PASS

GFSK Lowest Channel

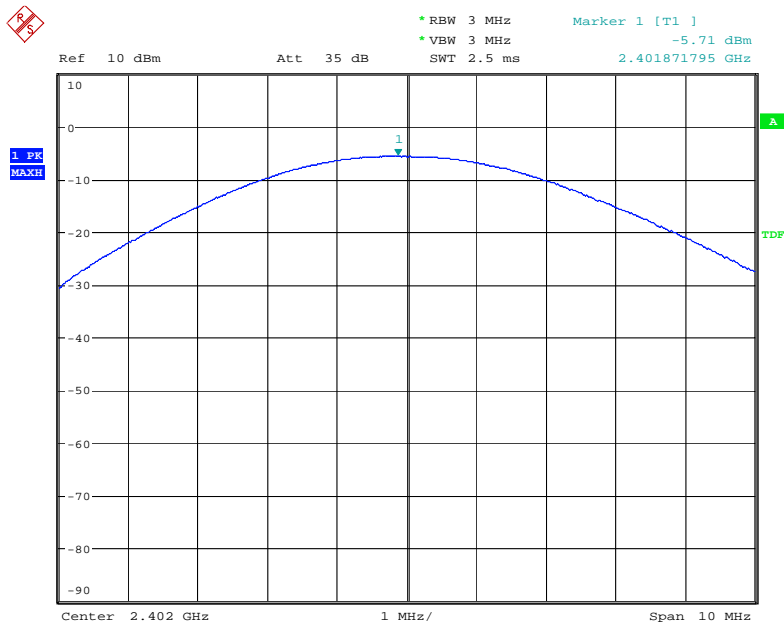

Date: 5.DEC.2014 15:38:11

GFSK Middle Channel

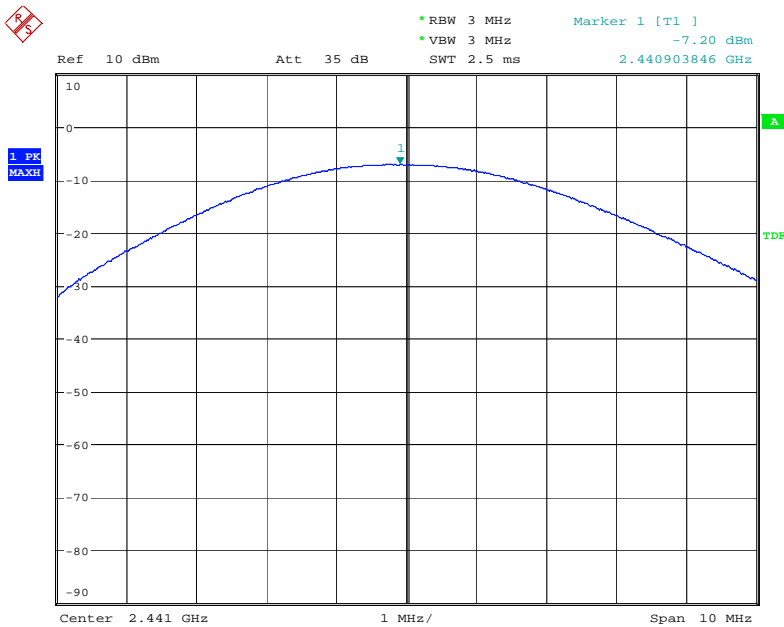

Date: 5.DEC.2014 15:38:24

GFSK Highest Channel

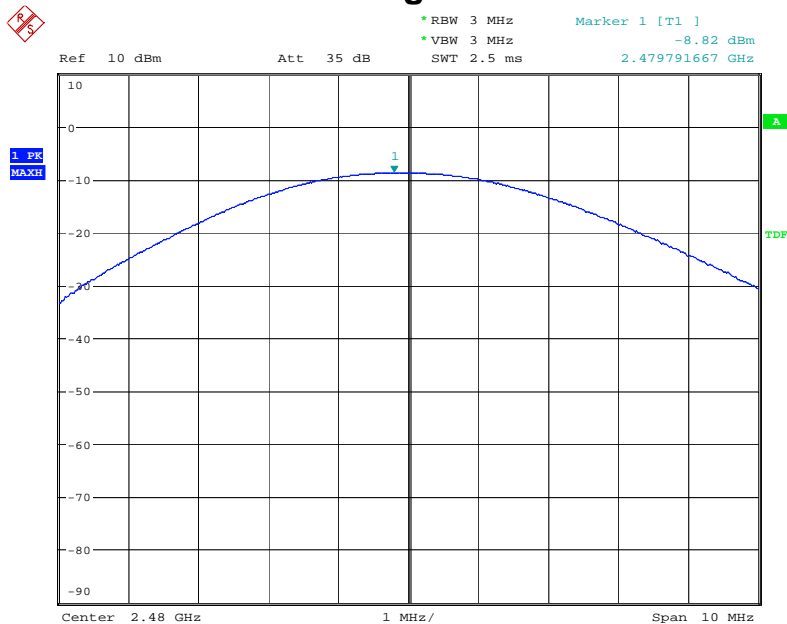

Date: 5.DEC.2014 15:38:38

$\pi/4$ -DQPSK Lowest Channel

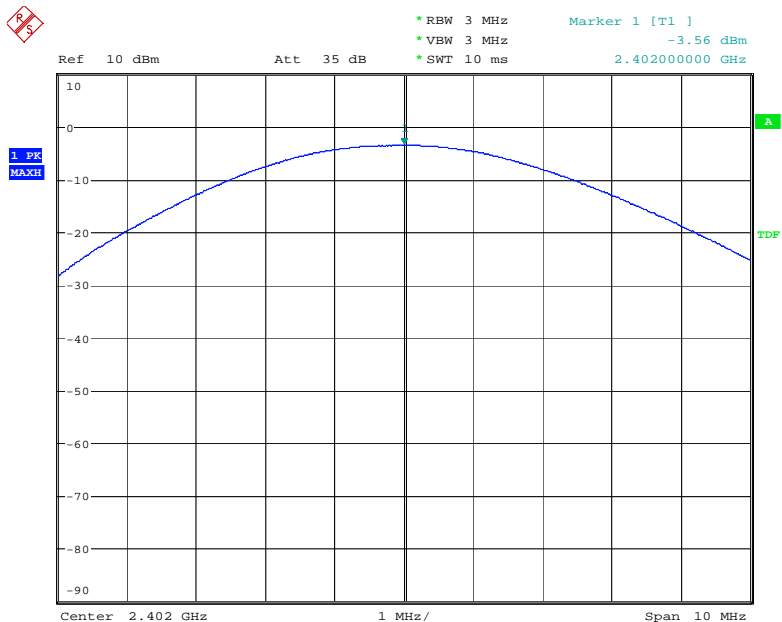

Date: 5.DEC.2014 18:35:48

$\pi/4$ -DQPSK Middle Channel

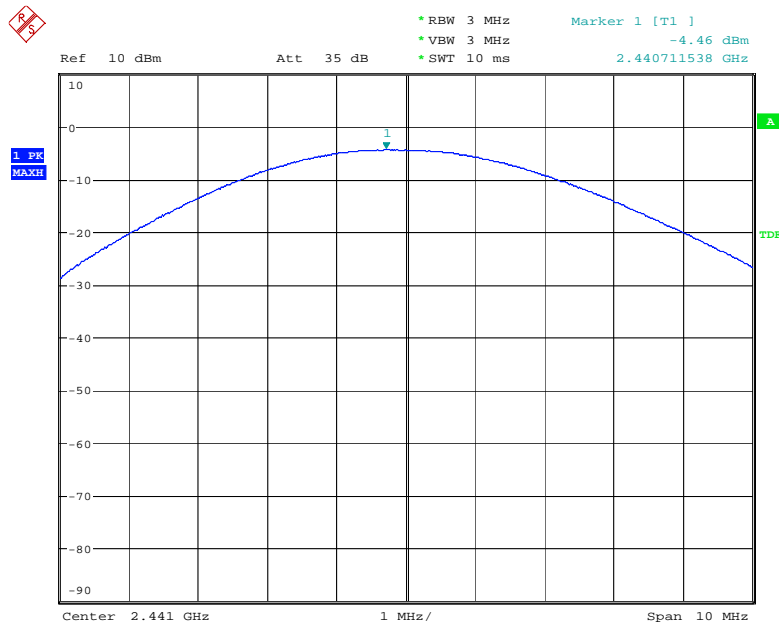

Date: 5.DEC.2014 18:36:00

$\pi/4$ -DQPSK Highest Channel

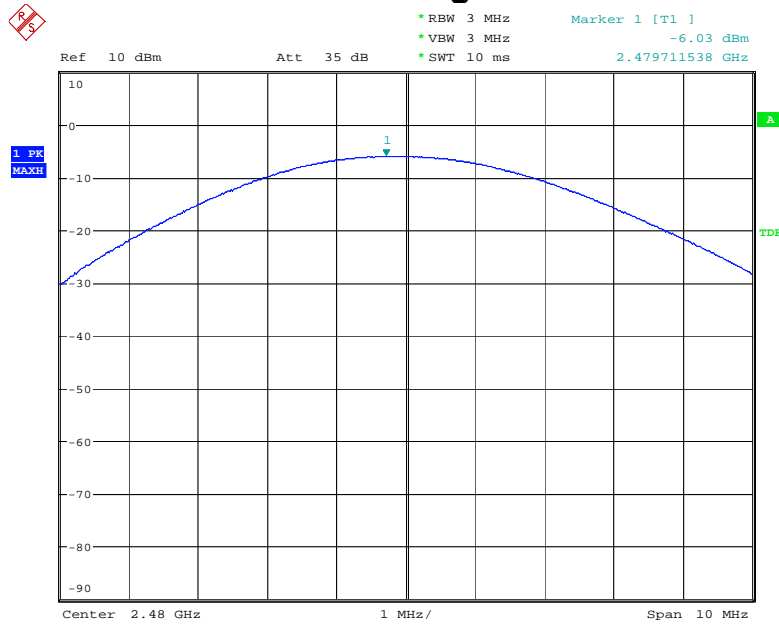

Date: 5.DEC.2014 18:36:12

8DPSK Lowest Channel

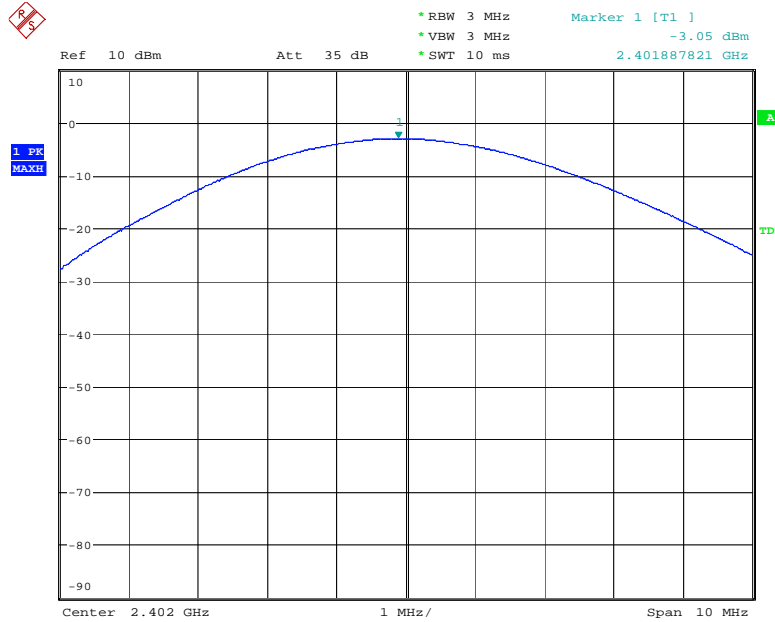

Date: 5.DEC.2014 18:36:37

8DPSK Middle Channel

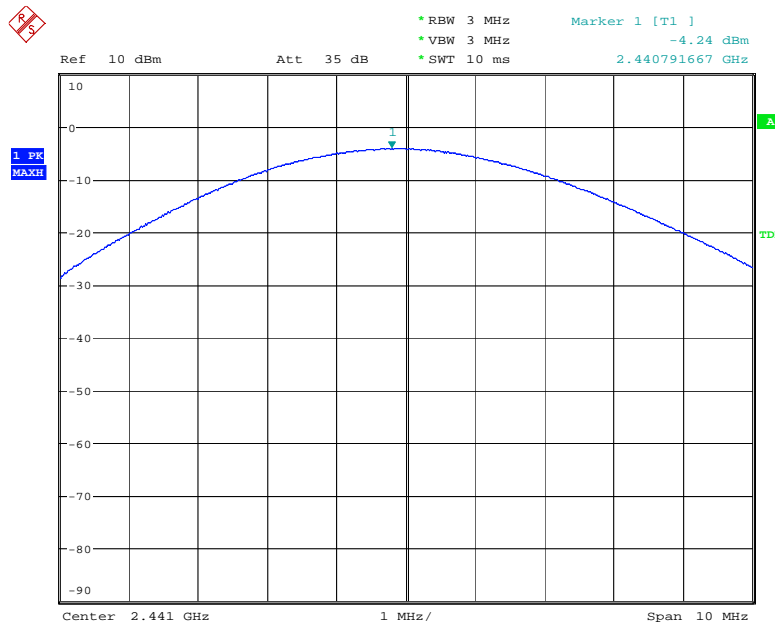

Date: 5.DEC.2014 18:36:52

8DPSK Highest Channel

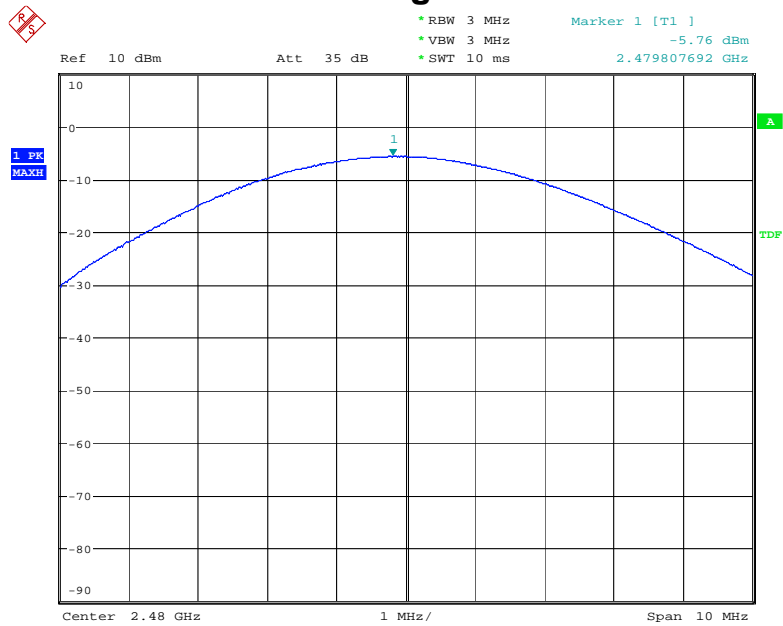

Date: 5.DEC.2014 18:37:04

10. Band Edge

10.1 Measurement Procedure

Out of Band Conducted Emissions, FCC Rule 15.247(d):

The transmitter output is connected to spectrum analyzer. The resolution bandwidth is set to 100KHz, and the video bandwidth set to 300KHz.

A Quasi-peak measurement was then made for that frequency point for below 1GHz test. PK and AV for above 1GHz emission test.

For 30MHz to 1GHz:

Set the spectrum analyzer as: RBW=120kHz, VBW=300kHz, Detector=Quasi-Peak

For Above 1GHz:

Set the spectrum analyzer as: RBW=1MHz, VBW=3MHz, Detector=Peak.

Set the spectrum analyzer as: RBW=1MHz, VBW=10Hz, Detector=Peak.

During the radiated emission test, the spectrum analyzer was set with the following configurations:

Frequency Band (MHz)	Level	Resolution Bandwidth	Video Bandwidth
30 to 1000	QP	120 kHz	300 kHz
Above 1000	Peak	1 MHz	3 MHz
	Average	1 MHz	10 Hz

10.2 Limit

In any 100KHz bandwidth outside the frequency band in which the spread spectrum or digitally modulated intentional radiator is operating, the radio frequency power that is produced by the intentional radiator shall be at least 20dB below that in the 100KHz bandwidth within the band that contains the highest level of the desired power, based on either an RF conducted or a radiated measurement.

10.3 Measurement Results

Please see below test table and plots.
 For Radiated Emission
 The worst case: GFSK

Freq. (MHz)	Ant.Pol. (H/V)	Reading Level(dBuV)		Factor (dB/m)	Emission Level (dBuV)		Limit 3m (dBuV/m)		Margin (dB)	
		PK	AV		PK	AV	PK	AV	PK	AV
2398.423	H	42.04	32.36	8.09	50.13	40.45	74.00	54.00	-23.87	-13.55
2398.423	V	42.46	33.27	8.09	50.55	41.36	74.00	54.00	-23.45	-12.64
2485.220	H	50.26	35.42	8.38	58.64	43.80	74.00	54.00	-15.36	-10.20
2485.272	V	48.95	34.17	8.38	57.33	42.55	74.00	54.00	-16.67	-11.45

- Note:**
- (1) Emission Level= Reading Level + Factor
 - (2) Factor= Antenna Gain + Cable Loss – Amplifier Gain
 - (3) Horn antenna used for the emission over 1000MHz.

For RF Conducted

GFSK Lowest Channel

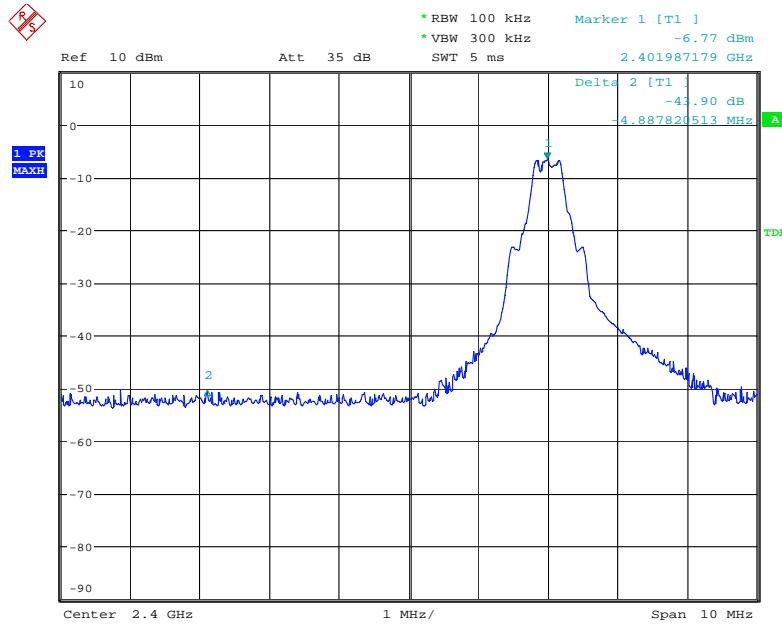

Date: 5.DEC.2014 14:51:52

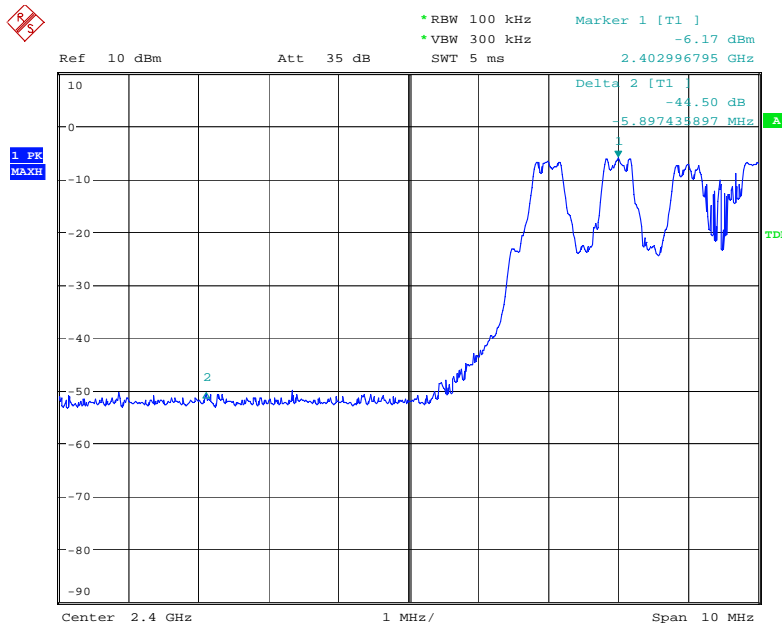

Date: 5.DEC.2014 14:52:45

GFSK Highest Channel

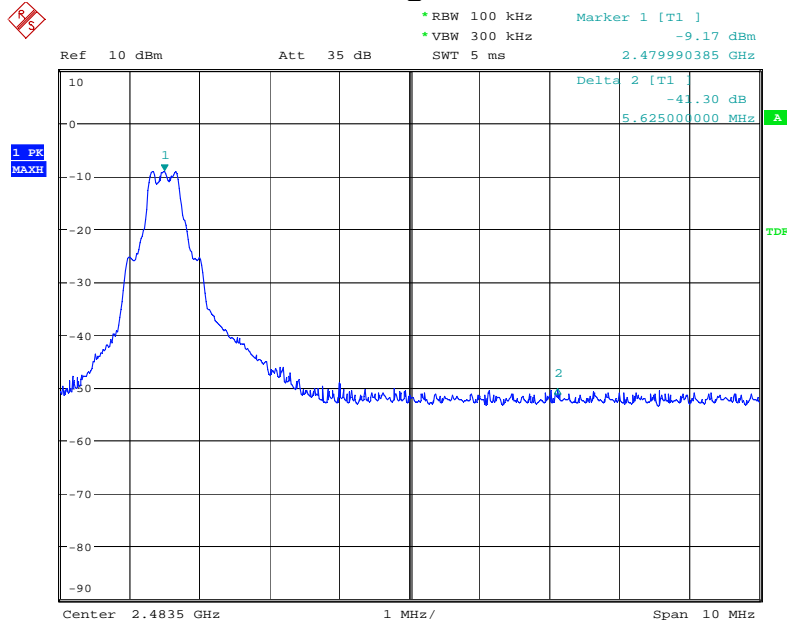

Date: 5.DEC.2014 14:54:33

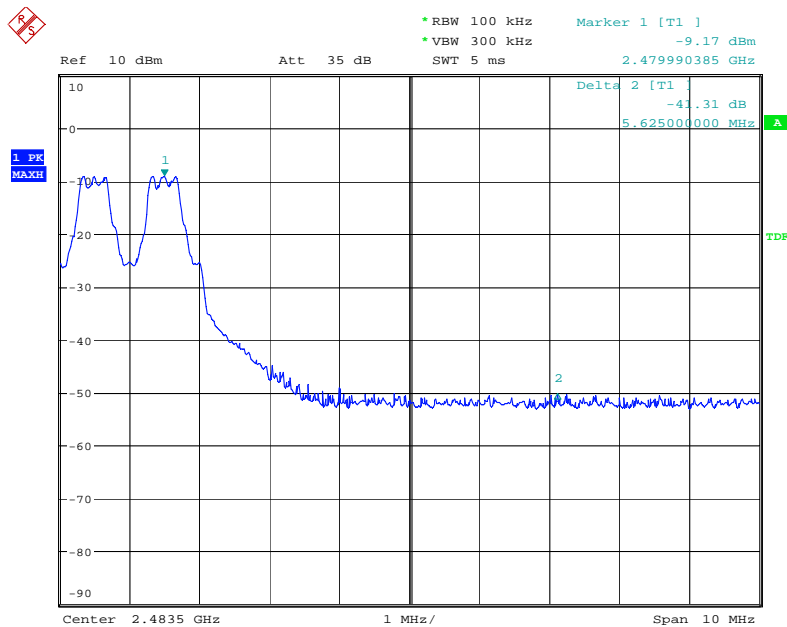

Date: 5.DEC.2014 14:55:03

$\pi/4$ -DQPSK Lowest Channel

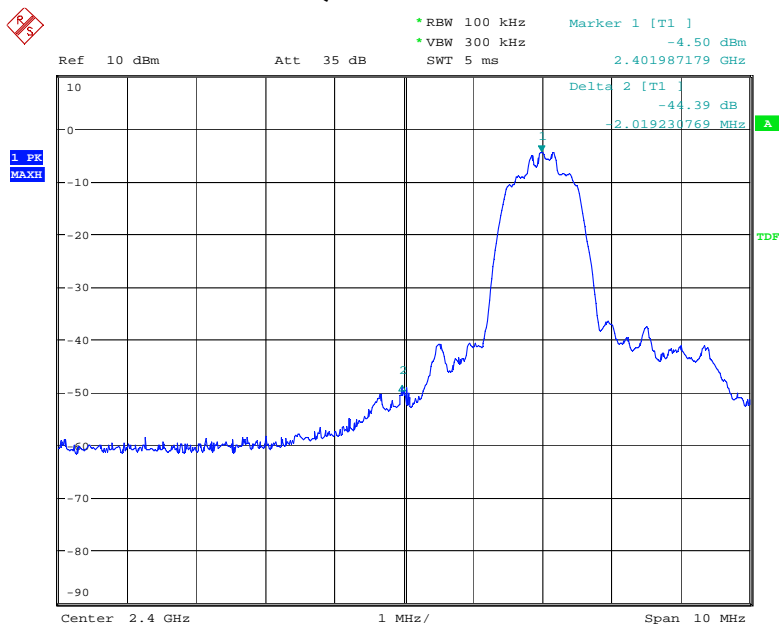

Date: 5.DEC.2014 18:46:05

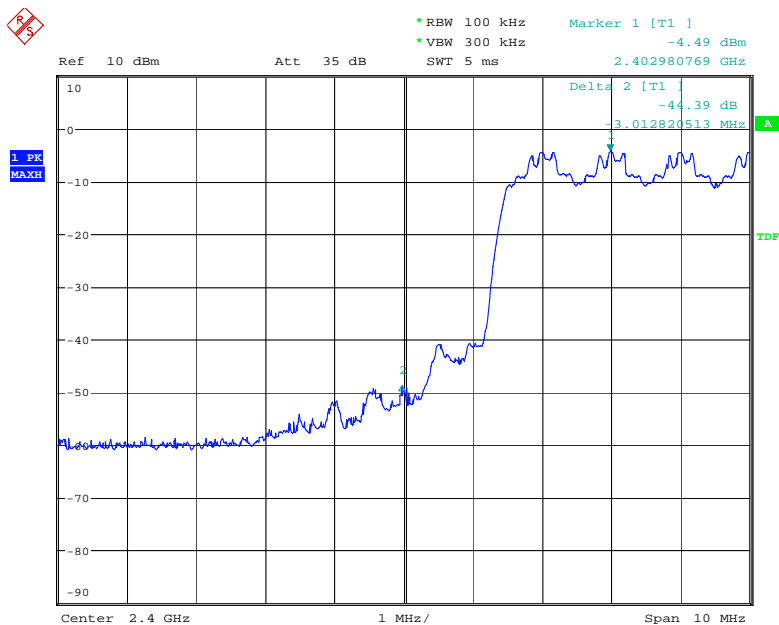

Date: 5.DEC.2014 18:47:23

$\pi/4$ -DQPSK Highest Channel

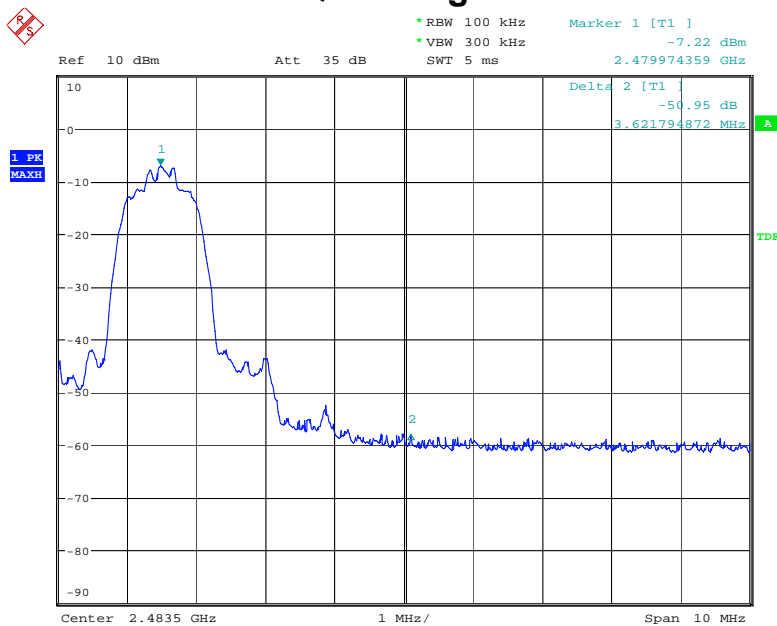

Date: 5.DEC.2014 18:48:04

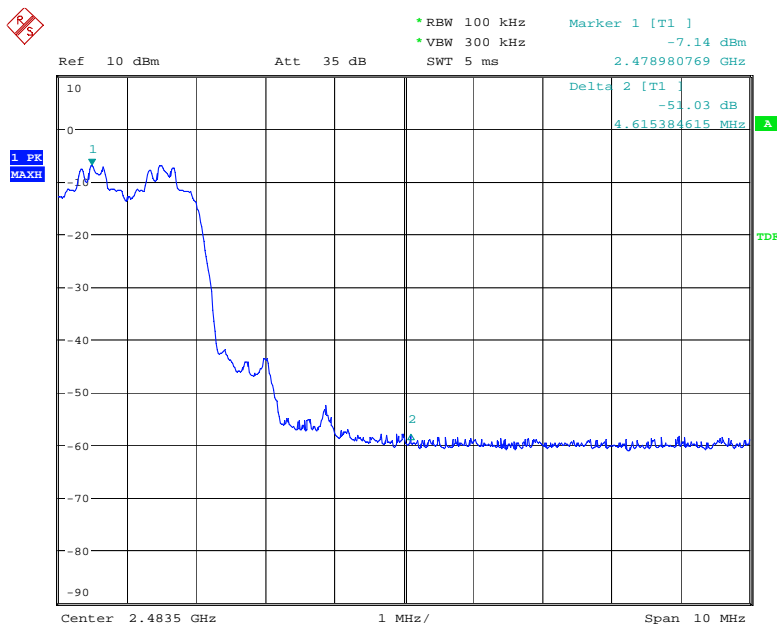

Date: 5.DEC.2014 18:48:49

8DPSK Lowest Channel

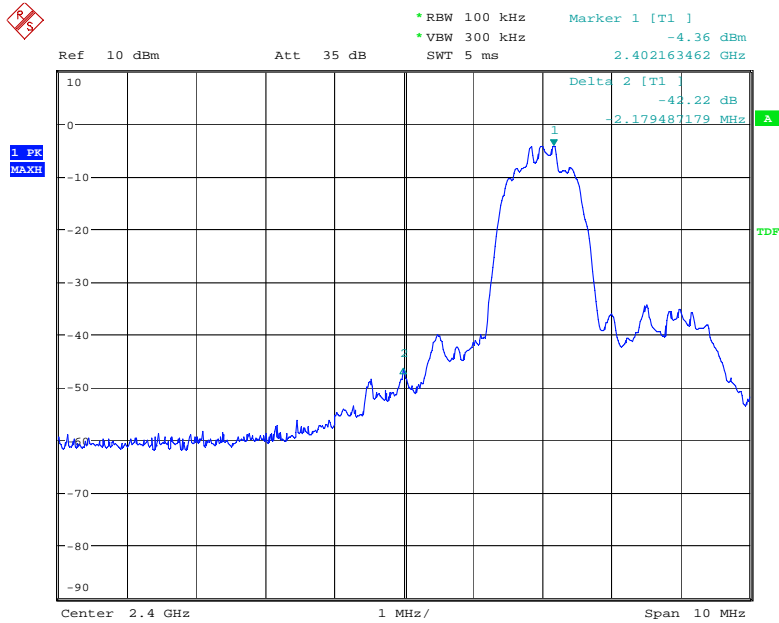

Date: 5.DEC.2014 18:57:47

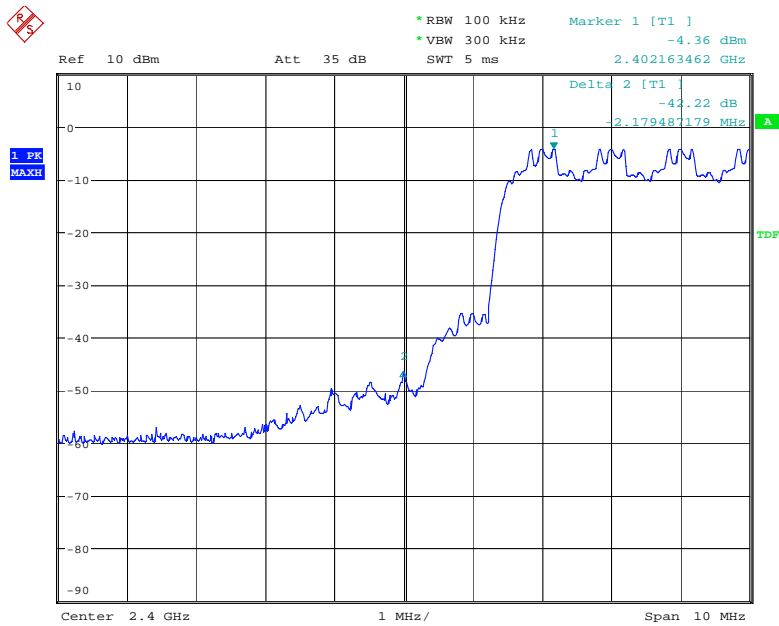

Date: 5.DEC.2014 19:08:05

8DPSK Highest Channel

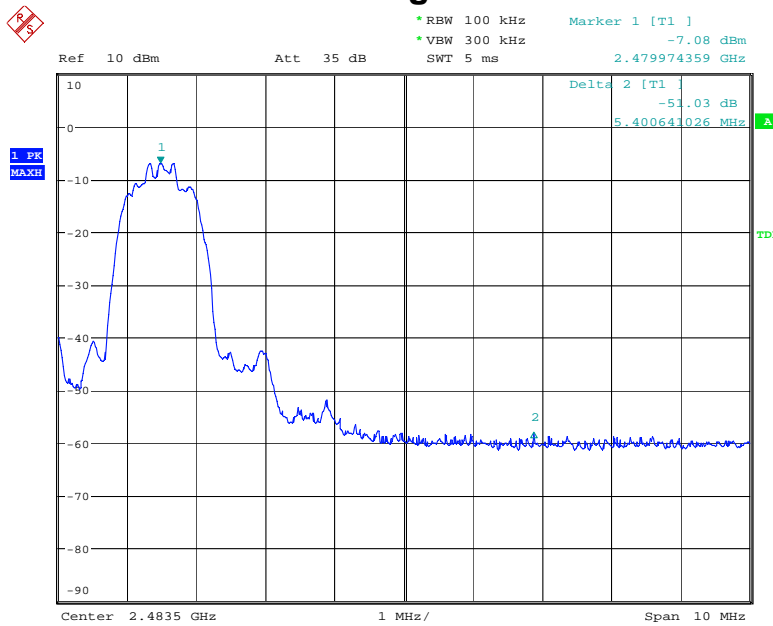

Date: 5.DEC.2014 19:08:58

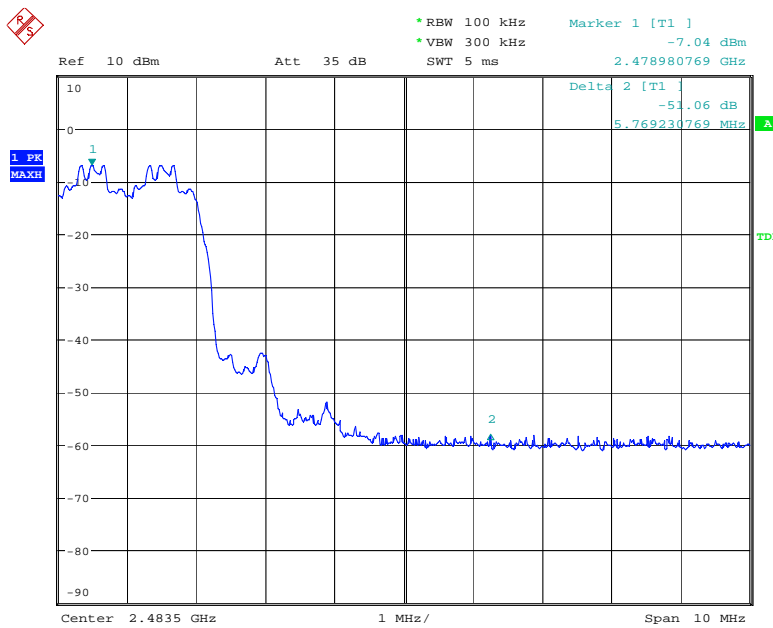

Date: 5.DEC.2014 19:09:37

11. Antenna Application

11.1 Antenna requirement

According to of FCC part 15C section 15.203 and 15.240:

An intentional radiator shall be designed to ensure that no antenna other than that furnished by the responsible party shall be used with the device. The use of a permanently attached antenna or of an antenna that uses a unique coupling to the intentional radiator, the manufacturer may design the unit so that a broken antenna can be replaced by the user, but the use of a standard antenna jack or electrical connector is prohibited.

Systems operating in the 2400-2483.5MHz band that are used exclusively for fixed, point-to-point operations may employ transmitting antennas with directional gain greater than 6dBi provided the maximum peak output power of the intentional radiator is reduced by 1dB for every 3dB that the directional gain of the antenna exceeds 6dBi.

11.2 Measurement Results

The antenna is integrated on the main PCB and no consideration of replacement, and the best case gain of the antenna is 0dBi. So, the antenna is considered meet the requirement.

12. Conducted Spurious Emissions

12.1 Measurement Procedure

Out of Band Conducted Spurious Emissions, FCC Rule 15.247(d):

The transmitter output is connected to spectrum analyzer. All spurious emission and up to the tenth harmonic was measured and they were found to be at least 20dB below the highest level of the desired power in the passband.

12.2 Measurement Results

Please refer to following plots, the worst case (8DPSK) was shown.

Lowest Channel

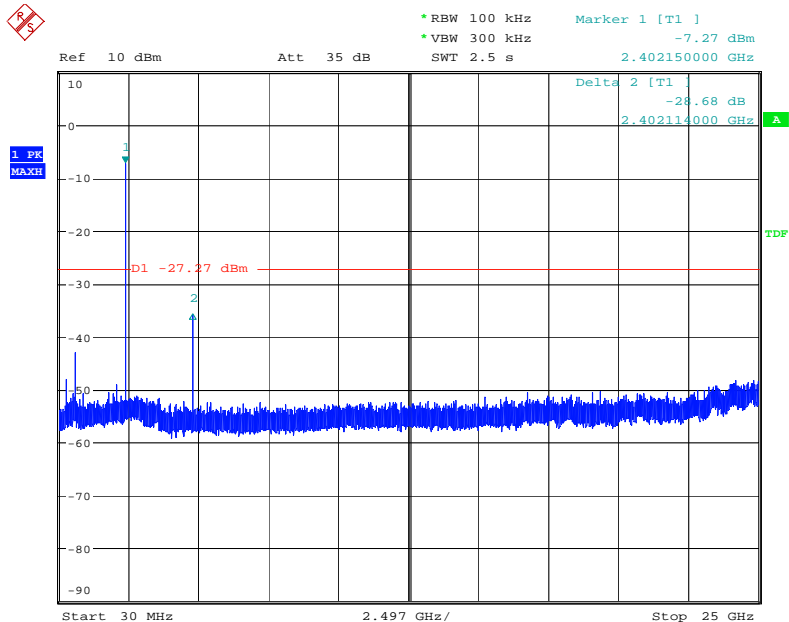

Date: 5.DEC.2014 15:42:12

Note: Sweep points=30001pts

Middle Channel

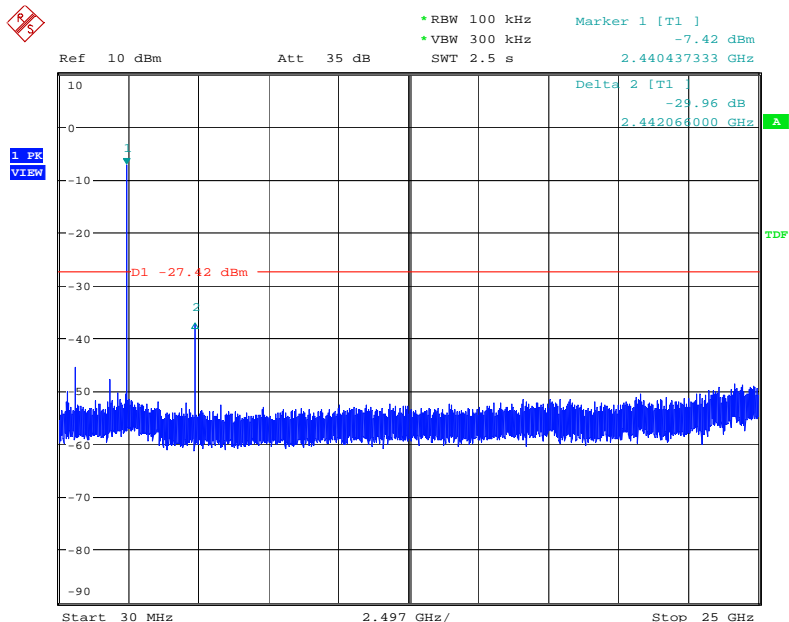

Date: 5.DEC.2014 15:42:44

Dongguan Nore Testing Center Co., Ltd.
Report No.: NTC1411640F
FCC ID: 2ACVCLF31BT



Note: Sweep points=30001pts

Highest Channel

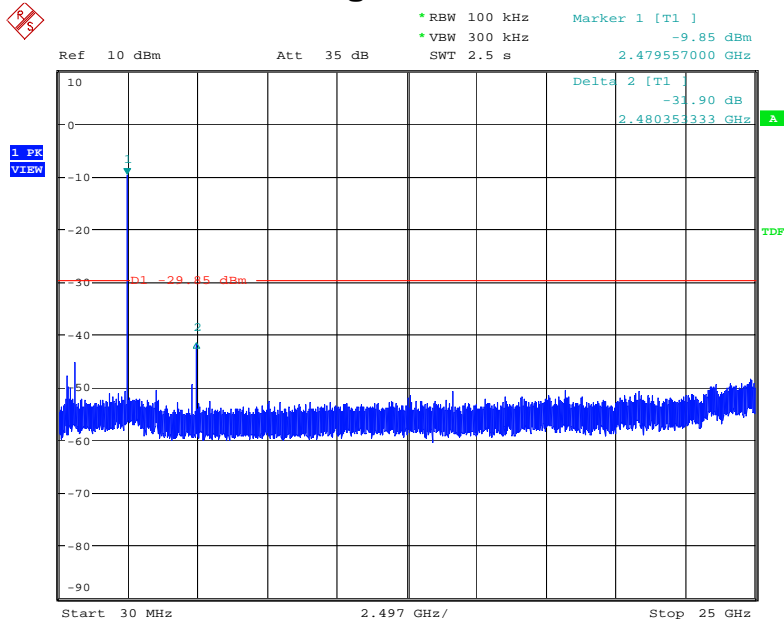

Date: 5.DEC.2014 15:43:17

Note: Sweep points=30001pts

13. Test Equipment List

Description	Manufacturer	Model Number	Serial Number	Characteristics	Calibration Date	Calibration Due Date
Test Receiver	Rohde & Schwarz	ESCI7	100837	9KHz~7GHz	Nov. 24, 2014	Nov. 23, 2015
Antenna	Schwarzbeck	VULB9162	9162-010	30MHz~7GHz	Nov. 27, 2014	Nov. 26, 2015
Positioning Controller	UC	UC 3000	N/A	0~360° , 1-4m	N/A	N/A
Color Monitor	SUNSPO	SP-140A	N/A	N/A	N/A	N/A
Single Phase Power Line Filter	SAEMC	PF201A-32	110210	32A	N/A	N/A
3 Phase Power Line Filter	SAEMC	PF401A-200	110318	200A	N/A	N/A
DC Power Filter	SAEMC	PF301A-200	110245	200A	N/A	N/A
Cable	Huber+Suhner	CBL2-NN-1M	22390001	9KHz~7GHz	Nov. 08, 2014	Nov. 07, 2015
Cable	Huber+Suhner	CIL02	N/A	9KHz~7GHz	Nov. 08, 2014	Nov. 07, 2015
RF Cable	Huber+Suhner	SF-104	MY16559/4	9KHz~25GHz	Mar. 07, 2015	Mar. 06, 2016
Power Amplifier	HP	HP 8447D	1145A00203	100KHz~1.3GHz	Nov. 08, 2014	Nov. 07, 2015
Horn Antenna	Schwarzbeck	BBHA9170	9170-372	15GHz~26.5GHz	Oct.24, 2014	Oct.23, 2015
Horn Antenna	Com-Power	AH-118	071078	1GHz~18GHz	Nov. 06, 2014	Nov. 05, 2015
Loop antenna	Daze	ZA30900A	0708	9KHz~30MHz	Oct.11, 2014	Oct.10, 2015
Spectrum Analyzer	Rohde & Schwarz	FSU26	200409/026	20Hz~26.5GHz	Sep. 02, 2014	Sep. 01, 2015
Pre-Amplifier	Agilent	8449B	3008A02964	1GHz~26.5GHz	Nov. 04, 2014	Nov. 03, 2015
L.I.S.N.	Rohde & Schwarz	ENV 216	101317	9KHz~30MHz	Nov. 08, 2014	Nov. 07, 2015
Temporary antenna connector	TESCOM	SS402	N/A	1G-18GHz	N/A	N/A

---End---