



FCC CERTIFICATION TEST REPORT

Applicant	:	KREAFUNK APS
Address of Applicant	:	Klamsagervej 35 A, st.8230 Abyhoj,Denmark
Manufacturer	:	Shen Zhen Lighkeep Co., Ltd.
Address of Manufacturer	:	3&4 Floor, No.19 Plant, Baotong South Road, XikengCommunity, Yuanshan Street, Longgang DistrictShenzhen
Equipment under Test	:	Safe Audio Headphone
Model No.	:	Buzz junior
FCC ID	:	2ACVC-BUZZJUNIOR
Test Standard(s)	:	FCC Rules and Regulations Part 15 Subpart C, ANSI C63.10:2013
Report No.	:	DDT-RE24010331-3E03
Issue Date	:	2024/03/19
Issue By	:	Guangdong Dongdian Testing Service Co., Ltd. Unit 2, Building 1, No. 17, Zongbu 2nd Road, Songshan Lake Park, Dongguan, Guangdong, China, 523808

REPORT

Table of Contents

1.	Summary of Test Results	7
2.	General Test Information	8
2.1.	Description of EUT	8
2.2.	Accessories of EUT	9
2.3.	Block diagram of EUT configuration for test.....	9
2.4.	Decision of final test mode	9
2.5.	Deviations of test standard	10
2.6.	Test environment conditions.....	10
2.7.	Test laboratory	10
2.8.	Measurement uncertainty	11
3.	Equipment Used During Conductive Test	12
4.	20 dB Bandwidth.....	13
4.1.	Block diagram of test setup	13
4.2.	Limits.....	13
4.3.	Test procedure.....	13
4.4.	Test result	14
4.5.	Test graphs	15
5.	99% Bandwidth	18
5.1.	Block diagram of test setup	18
5.2.	Limits.....	18
5.3.	Test procedure.....	18
5.4.	Test result	19
5.5.	Test graphs	20
6.	Maximum Peak Output Power.....	23
6.1.	Block diagram of test setup	23
6.2.	Limits.....	23
6.3.	Test procedure.....	23
6.4.	Test result	24
6.5.	Test graphs	25
7.	Carrier Frequency Separation	28
7.1.	Block diagram of test setup	28
7.2.	Limits.....	28
7.3.	Test procedure.....	28
7.4.	Test result	29
7.5.	Test graphs	30
8.	Dwell Time	31

8.1.	Block diagram of test setup	31
8.2.	Limits.....	31
8.3.	Test procedure.....	31
8.4.	Test result	32
8.5.	Test graphs.....	33
9.	Number of Hopping Channel.....	39
9.1.	Block diagram of test setup	39
9.2.	Limits.....	39
9.3.	Test procedure.....	39
9.4.	Test result	40
9.5.	Test graphs.....	41
10.	Band Edge Compliance (Conducted Method).....	42
10.1.	Block diagram of test setup	42
10.2.	Limit.....	42
10.3.	Test procedure.....	42
10.4.	Test result	43
10.5.	Test graphs.....	44
11.	RF Conducted Spurious Emissions.....	48
11.1.	Block diagram of test setup	48
11.2.	Limits.....	48
11.3.	Test procedure.....	48
11.4.	Test result	49
11.5.	Test graphs.....	50
12.	Duty cycle	59
12.1.	Block diagram of test setup	59
12.2.	Limit.....	59
12.3.	Test procedure.....	59
12.4.	Test result	60
12.5.	Test graphs.....	61
13.	Radiated Emission.....	64
13.1.	Test equipment.....	64
13.2.	Block diagram of test setup	64
13.3.	Limits.....	65
13.4.	Assistant equipment used for test	66
13.5.	Test procedure.....	66
13.6.	Test result	68
13.7.	Test data	69
14.	Band Edge Compliance.....	89

14.1.	Test equipment	89
14.2.	Block diagram of test setup	89
14.3.	Limits.....	89
14.4.	Assistant equipment used for test	89
14.5.	Test procedure.....	89
14.6.	Test result	89
14.7.	Test data	90
15.	Power Line Conducted Emissions.....	102
15.1.	Test equipment	102
15.2.	Block diagram of test setup	102
15.3.	Limits.....	102
15.4.	Assistant equipment used for test	102
15.5.	Test procedure.....	102
15.6.	Test result	103
15.7.	Test data	104
16.	Test Setup Photograph.....	106
17.	Photos of the EUT	108

Test Report Declare

Applicant	:	KREAFUNK APS
Address of Applicant	:	Klamsagervej 35 A, st.8230 Abyhoj,Denmark
Equipment under Test	:	Safe Audio Headphone
Model No.	:	Buzz junior
Manufacturer	:	Shen Zhen Lighkeep Co., Ltd.
Address of Manufacturer	:	3&4 Floor, No.19 Plant, Baotong South Road, XikengCommunity, Yuanshan Street, Longgang DistrictShenzhen

Test Standard Used:

FCC Rules and Regulations Part 15 Subpart C,
ANSI C63.10:2013

We Declare:

The equipment described above is tested by Guangdong Dongdian Testing Service Co., Ltd. and in the configuration tested the equipment complied with the standards specified above. The test results are contained in this test report and Guangdong Dongdian Testing Service Co., Ltd. is assumed of full responsibility for the accuracy and completeness of these tests.

Report No.:	DDT-RE24010331-3E03		
Date of Receipt:	2024/01/26	Date of Test:	2024/01/26~2024/03/18

Prepared By:

Tiger Mo

Tiger Mo/Engineer

Approved By:



Damon Hu/EMC Manager

Note: This report applies to above tested sample only. This report shall not be reproduced in parts without written approval of Guangdong Dongdian Testing Service Co., Ltd.

Revision History

Rev.	Revisions	Issue Date	Revised By
---	Initial issue	2024/03/19	

1. Summary of Test Results

No.	Test Parameter	Clause No.	Condition	Result
1	Maximum Peak Output Power	FCC Part 15: 15.247(b)(1)	/	Pass
2	20 dB Bandwidth	FCC Part 15: 15.247(a)(1)	/	Pass
3	Carrier Frequency Separation	FCC Part 15: 15.247(a)(1)	/	Pass
4	Number of Hopping Channel	FCC Part 15: 15.247(a)(1)(iii)	/	Pass
5	Dwell Time	FCC Part 15: 15.247(a)(1)(iii)	/	Pass
6	RF Conducted Spurious Emissions	FCC Part 15: 15.247(d)	/	Pass
7	Radiated Emission	FCC Part 15: 15.205, FCC Part 15: 15.209, FCC Part 15: 15.247(d)	/	Pass
8	Band Edge Compliance	FCC Part 15: 15.205, FCC Part 15: 15.209, FCC Part 15: 15.247(d)	/	Pass
9	Power Line Conducted Emissions	FCC Part 15: 15.207(a)	/	Pass
10	Antenna Requirement	FCC Part 15: 15.203	/	Pass

Note: N/A is an abbreviation for Not Applicable, and means this item is not applicable for this device or no need to test according to standard.

2. General Test Information

2.1. Description of EUT

EUT Name	: Safe Audio Headphone
Model Number	: Buzz junior
EUT Function Description	: Please reference user manual of this device
Power Supply	: DC 5V by external AC Adapter or 3.7V built-in lithium battery

Note: This EUT support Bluetooth BR/EDR,NFC, this report only for Bluetooth BR/EDR.

Radio Specification	: Bluetooth BR/EDR
Operation Frequency	: 2402 MHz-2480 MHz
Modulation	: GFSK, $\pi/4$ -DQPSK, 8DPSK

Antenna information	
Antenna Type	: PCB
Max Antenna Gain(dBi)	: 0

Channel information					
Channel	Frequency (MHz)	Channel	Frequency (MHz)	Channel	Frequency (MHz)
0	2402	27	2429	54	2456
1	2403	28	2430	55	2457
2	2404	29	2431	56	2458
3	2405	30	2432	57	2459
4	2406	31	2433	58	2460
5	2407	32	2434	59	2461
6	2408	33	2435	60	2462
7	2409	34	2436	61	2463
8	2410	35	2437	62	2464
9	2411	36	2438	63	2465
10	2412	37	2439	64	2466
11	2413	38	2440	65	2467
12	2414	39	2441	66	2468
13	2415	40	2442	67	2469
14	2416	41	2443	68	2470
15	2417	42	2444	69	2471
16	2418	43	2445	70	2472
17	2419	44	2446	71	2473
18	2420	45	2447	72	2474
19	2421	46	2448	73	2475
20	2422	47	2449	74	2476
21	2423	48	2450	75	2477

22	2424	49	2451	76	2478
23	2425	50	2452	77	2479
24	2426	51	2453	78	2480
25	2427	52	2454		
26	2428	53	2455		

Note: The above EUT information is declared by manufacturer and for more detailed features description please refer to the manufacturer's specifications or User's Manual. The above Antenna information is declared by manufacturer and for more detailed features description please refer to the manufacturer's specifications, the laboratory shall not be held responsible.

“☒” means to be chosen or applicable; “☐” means don't to be chosen or not applicable; This note applies to entire report.

2.2. Accessories of EUT

Accessories	Manufacturer	Model number	Description
/	/	/	/

2.3. Block diagram of EUT configuration for test

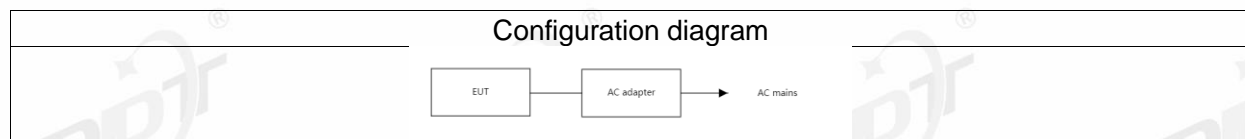

2.4. Decision of final test mode

According pre-test, the worst test modes were reported as below:

Test software: FCC_assist_1.0.2.2.exe

The test software was used to control EUT work in Continuous Tx mode, and select test channel, wireless mode as below table.

The pathloss of external cable: 0.5 dB (According to the manufacturer's claims)

Tested mode, channel, information			
Mode	Setting Tx Power	Channel	Frequency (MHz)
GFSK hopping on Tx mode	10	CH0 to CH78	2402 to 2480
p/4-DQPSK hopping on Tx mode	10	CH0 to CH78	2402 to 2480
8DPSK hopping on Tx mode	10	CH0 to CH78	2402 to 2480
GFSK hopping off Tx mode	10	CH0	2402
	10	CH39	2441
	10	CH78	2480
	10	CH0	2402

p/4-DQPSK hopping off Tx mode	10	CH39	2441
	10	CH78	2480
8DPSK hopping off Tx mode	10	CH0	2402
	10	CH39	2441
	10	CH78	2480
Worst-case data rates were: GFSK mode: DH5, p/4-DQPSK mode: 2DH5, 8DPSK mode: 3DH5			

2.5. Deviations of test standard

No deviation.

2.6. Test environment conditions

During the measurement the environmental conditions were within the listed ranges:

Temperature range:	+15°C to +35 °C
Humidity range:	20% to 75%
Pressure range:	86 kPa to 106 kPa

Note: The specific temperature and humidity information of each test item refers to the temperature and humidity record in the corresponding test data.

2.7. Test laboratory

Guangdong Dongdian Testing Service Co., Ltd.

Add.: Unit 2, Building 1, No. 17, Zongbu 2nd Road, Songshan Lake Park, Dongguan, Guangdong, China, 523808.

Tel.: +86-0769-38826678, <http://www.dgddt.com>, Email: ddt@dgddt.com.

CNAS Accreditation No. L6451; A2LA Accreditation Number: 3870.01

FCC Designation Number: CN1182, Test Firm Registration Number: 540522

Innovation, Science and Economic Development Canada Site Registration Number: 10288A

Conformity Assessment Body identifier: CN0048

VCCI facility registration number: C-20087, T-20088, R-20123, R-20155, G-20118

2.8. Measurement uncertainty

Test Item	Uncertainty
Bandwidth	1.1%
Peak Output Power (Conducted) (Spectrum analyzer)	0.86 dB (10 MHz ≤ f < 3.6 GHz);
	1.38 dB (3.6 GHz ≤ f < 8 GHz)
Peak Output Power (Conducted) (Power Sensor)	0.74 dB
Power Spectral Density	0.74 dB (10 MHz ≤ f < 3.6 GHz);
	1.38 dB (3.6 GHz ≤ f < 8 GHz)
Frequencies Stability	6.7 x 10 ⁻⁸ (Antenna couple method)
	5.5 x 10 ⁻⁸ (Conducted method)
Conducted spurious emissions	0.86 dB (10 MHz ≤ f < 3.6 GHz);
	1.40 dB (3.6 GHz ≤ f < 8 GHz)
	1.66 dB (8 GHz ≤ f < 26.5 GHz)
Uncertainty for radio frequency (RBW < 20 kHz)	3x10 ⁻⁸
Temperature	0.4 °C
Humidity	2 %
Uncertainty for Radiation Emission test (9 kHz – 30 MHz)	3.44 dB
Uncertainty for Radiation Emission test (30 MHz - 1 GHz)	4.70 dB (Antenna Polarize: V)
	4.84 dB (Antenna Polarize: H)
Uncertainty for Radiation Emission test (1 GHz - 40 GHz)	4.10 dB (1 - 6 GHz)
	4.40 dB (6 GHz - 18 GHz)
	3.54 dB (18 GHz - 26 GHz)
	4.30 dB (26 GHz - 40 GHz)
Uncertainty for Power line conduction emission test	3.34dB (150KHz-30MHz)
	3.72dB (9KHz-150KHz)

Note: This uncertainty represents an expanded uncertainty expressed at approximately the 95% confidence level using a coverage factor of k=2.

3. Equipment Used During Conductive Test

Equipment	Manufacturer	Model No.	Serial Number	Due Date
<input checked="" type="checkbox"/> RF Connected Test (RF Measurement System 2#)				
SPECTRUM ANALYZER	R&S	FSU26	201124	2024/07/11
Power Sensor	R&S	NRP-Z22	101254	2024/07/11
Test Software	Tonscend	JS1120-3	Ver.3.2.22	N/A

4. 20 dB Bandwidth

4.1. Block diagram of test setup

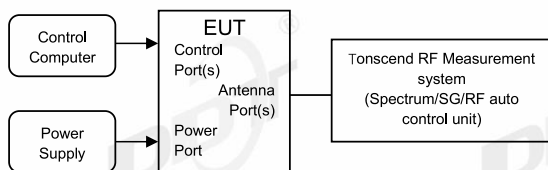

4.2. Limits

Intentional radiators operating under the alternative provisions to the general emission limits, as contained in § 15.217 through 15.257 and in Subpart E of this part, must be designed to ensure that the 20 dB bandwidth of the emission, or whatever bandwidth may otherwise be specified in the specific rule section under which the equipment operates, is contained within the frequency band designated in the rule section under which the equipment is operated.

4.3. Test procedure

- (1) The test according to ANSI C63.10-2013 clause 6.9.2.
- (2) Connect EUT's antenna output to spectrum analyzer by RF cable, the path loss was compensated to the results
- (3) Set the EUT as maximum power setting and enable the EUT transmit continuously
- (4) Use the following spectrum analyzer settings for the 20 dB bandwidth measurement:

RBW:	1% to 5% of the OBW
VBW:	approximately three times RBW
Span:	between 2 times and 5 times the OBW
Detector Mode:	Peak
Sweep time:	Auto
Trace mode:	Max hold

- (5) Measure and record the results in the report.

4.4. Test result

Test Engineer:	Zoe	Test Site:	RF Measurement System 2#
Ambient Condition:	24.3°C,46.1%RH	Test Date:	2024.02.21
Test Power Supply:	Battery	EUT:	Safe Audio Headphone
Sample Number:	S24010331-011	Model No.:	Buzz junior

Test Mode	Antenna	Frequency [MHz]	20dB EBW[MHz]
DH5	Ant1	2402	0.95
		2441	0.95
		2480	0.96
2DH5	Ant1	2402	1.29
		2441	1.29
		2480	1.31
3DH5	Ant1	2402	1.30
		2441	1.30
		2480	1.30

4.5. Test graphs

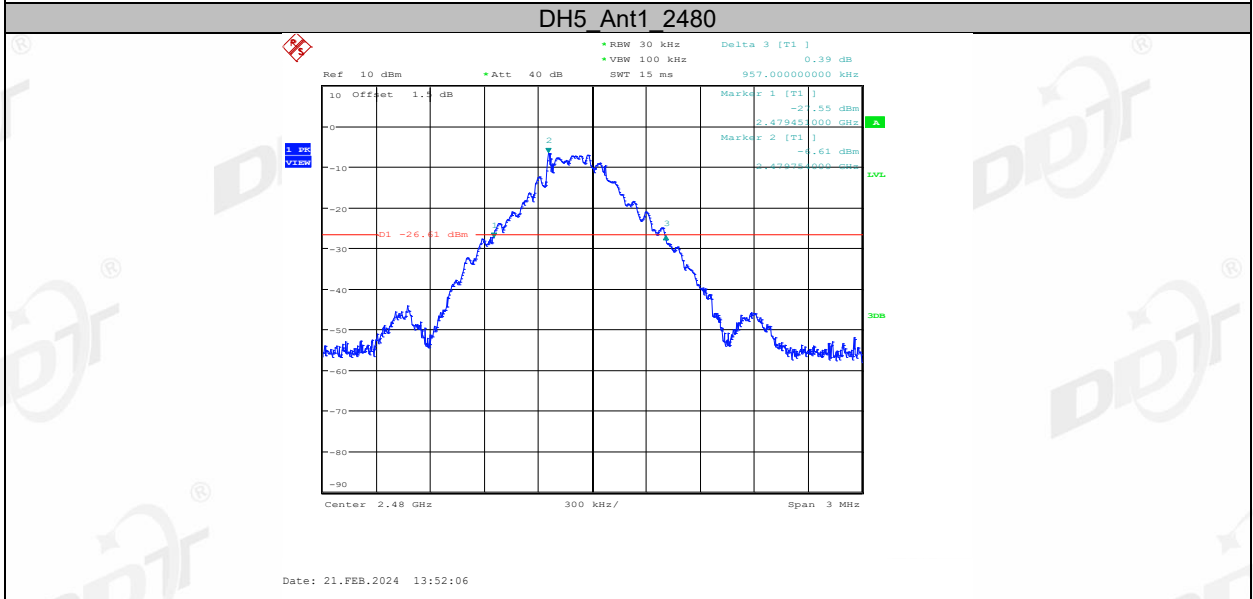
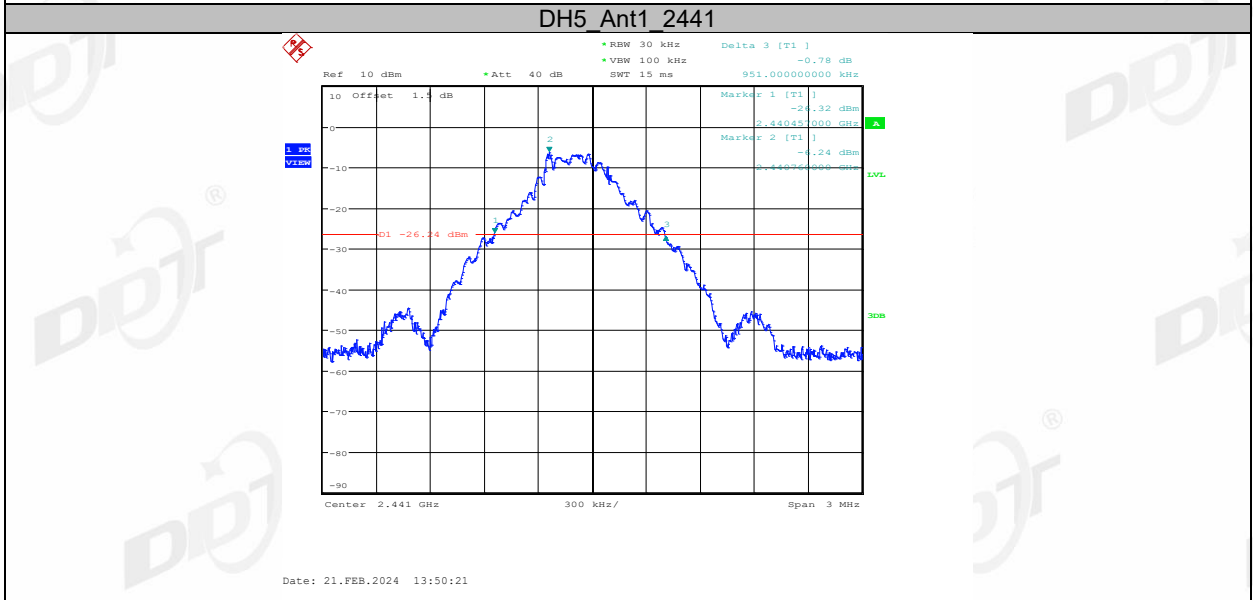
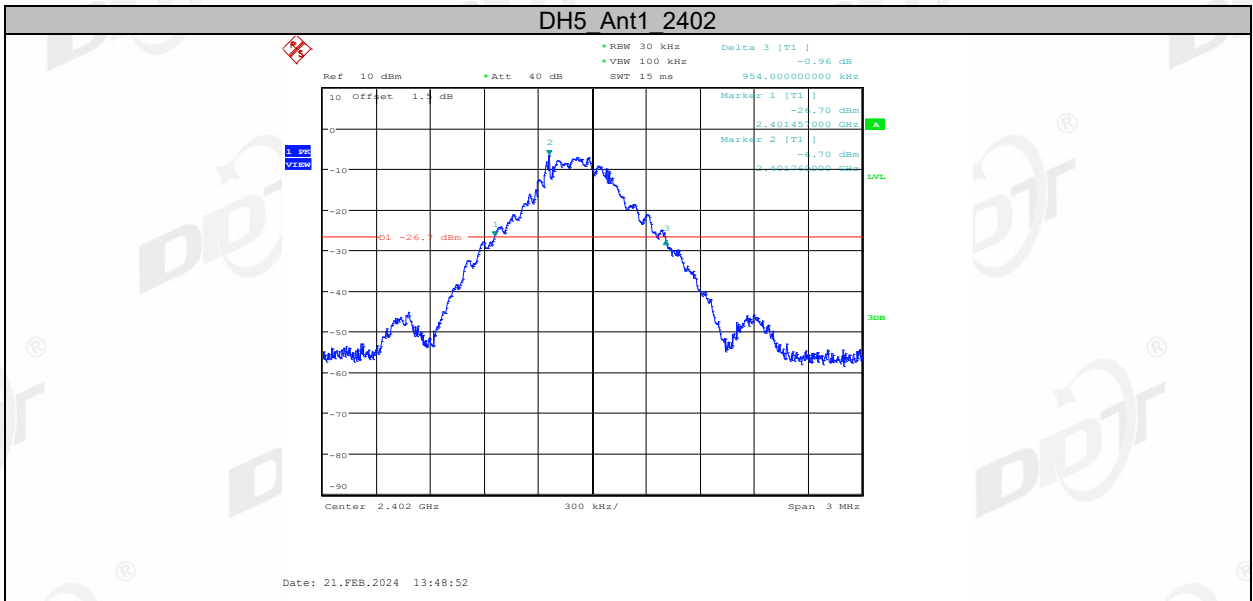

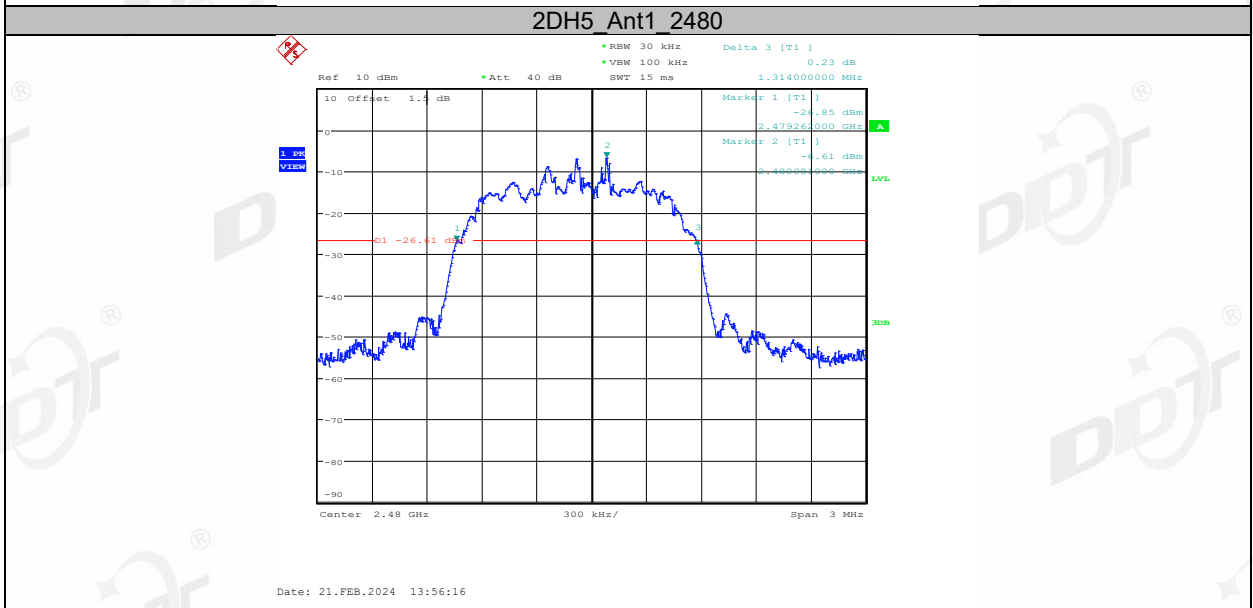
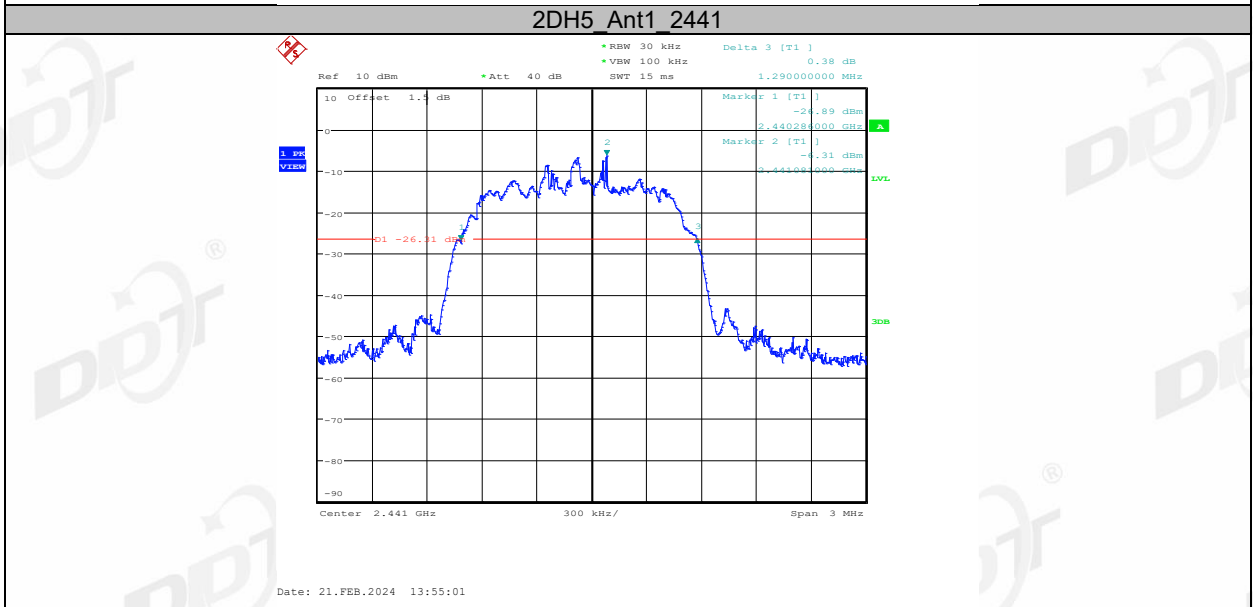
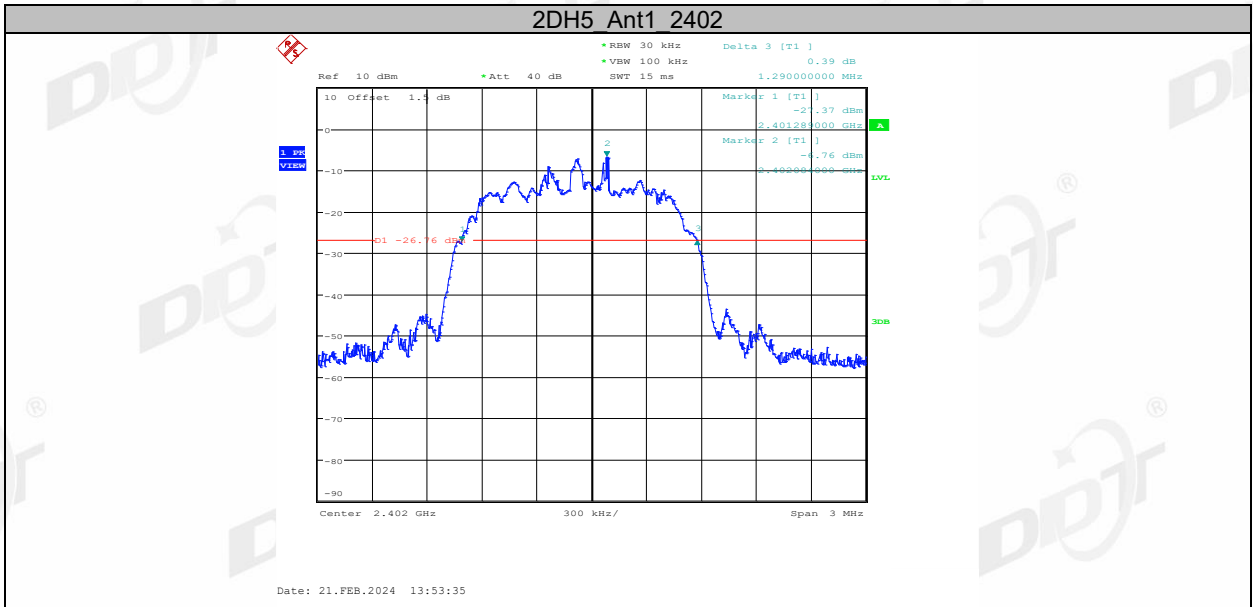

3DH5_Ant1_2402

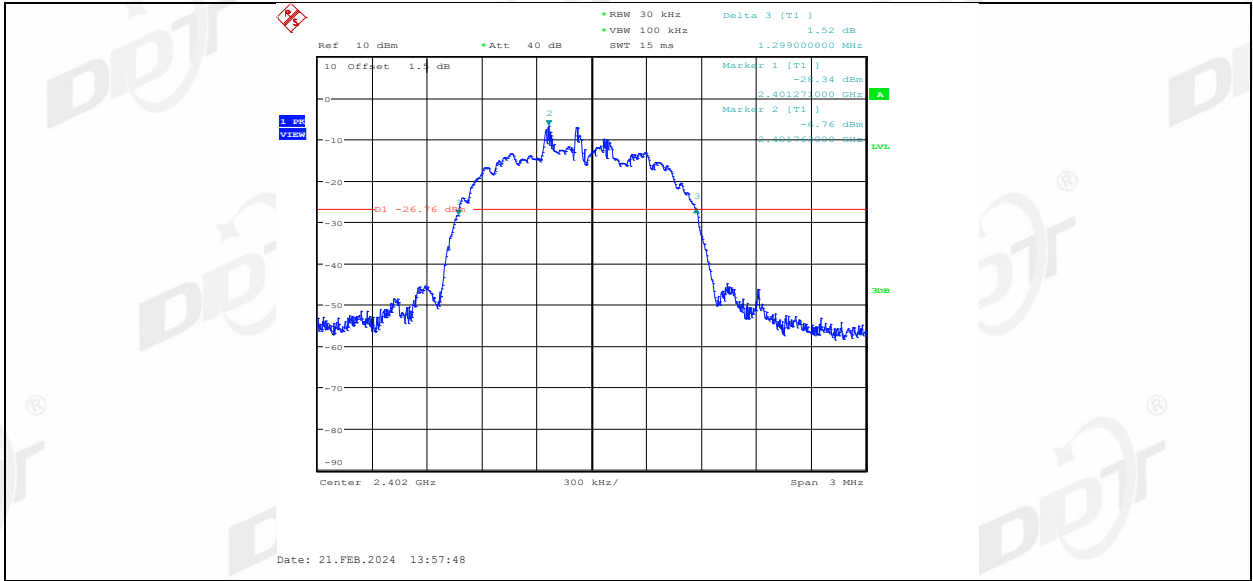

3DH5 Ant1_2441

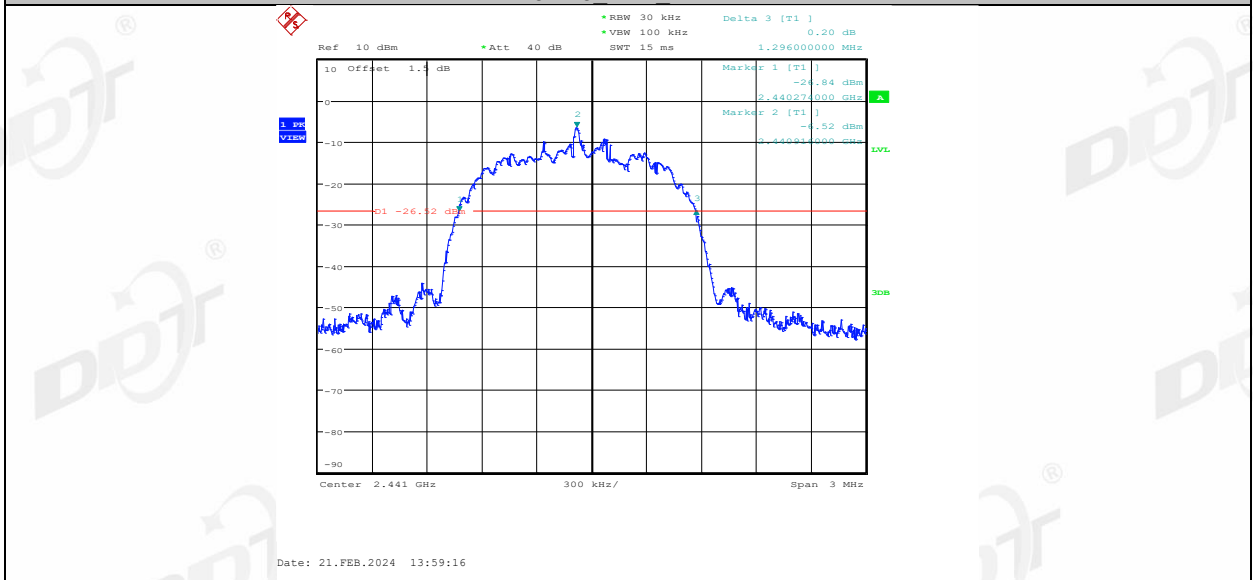

3DH5 Ant1_2480

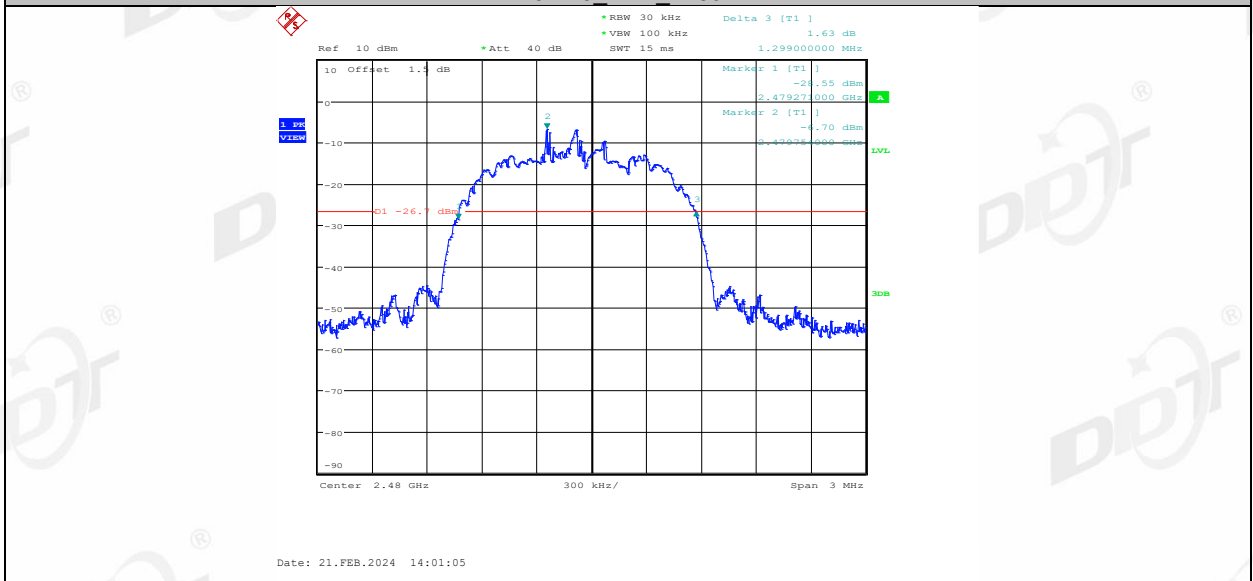

5. 99% Bandwidth

5.1. Block diagram of test setup

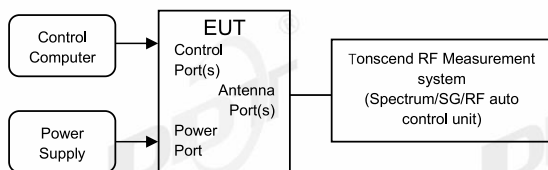

5.2. Limits

Just for Report.

5.3. Test procedure

- (1) The test according to ANSI C63.10-2013 clause 6.9.3.
- (2) Connect EUT's antenna output to spectrum analyzer by RF cable, the path loss was compensated to the results
- (3) Set the EUT as maximum power setting and enable the EUT transmit continuously
- (4) Use the following spectrum analyzer settings for the 99% bandwidth measurement:

RBW:	1% to 5% of the OBW
VBW:	approximately three times RBW
Span:	between 1.5 times and 5.0 times the OBW
Detector Mode:	Peak
Sweep time:	Auto
Trace mode:	Max hold
- (5) Measure and record the results in the report.

5.4. Test result

Test Engineer:	Zoe	Test Site:	RF Measurement System 2#
Ambient Condition:	24.3°C,46.1%RH	Test Date:	2024.02.21
Test Power Supply:	Battery	EUT:	Safe Audio Headphone
Sample Number:	S24010331-011	Model No.:	Buzz junior

Test Mode	Antenna	Frequency [MHz]	OCB [MHz]	FL[MHz]	FH[MHz]
DH5	Ant1	2402	0.867	2401.4870	2402.3540
		2441	0.873	2440.4810	2441.3540
		2480	0.873	2479.4810	2480.3540
2DH5	Ant1	2402	1.182	2401.3310	2402.5130
		2441	1.182	2440.3280	2441.5100
		2480	1.182	2479.3280	2480.5100
3DH5	Ant1	2402	1.182	2401.3310	2402.5130
		2441	1.182	2440.3280	2441.5100
		2480	1.191	2479.3250	2480.5160

5.5. Test graphs

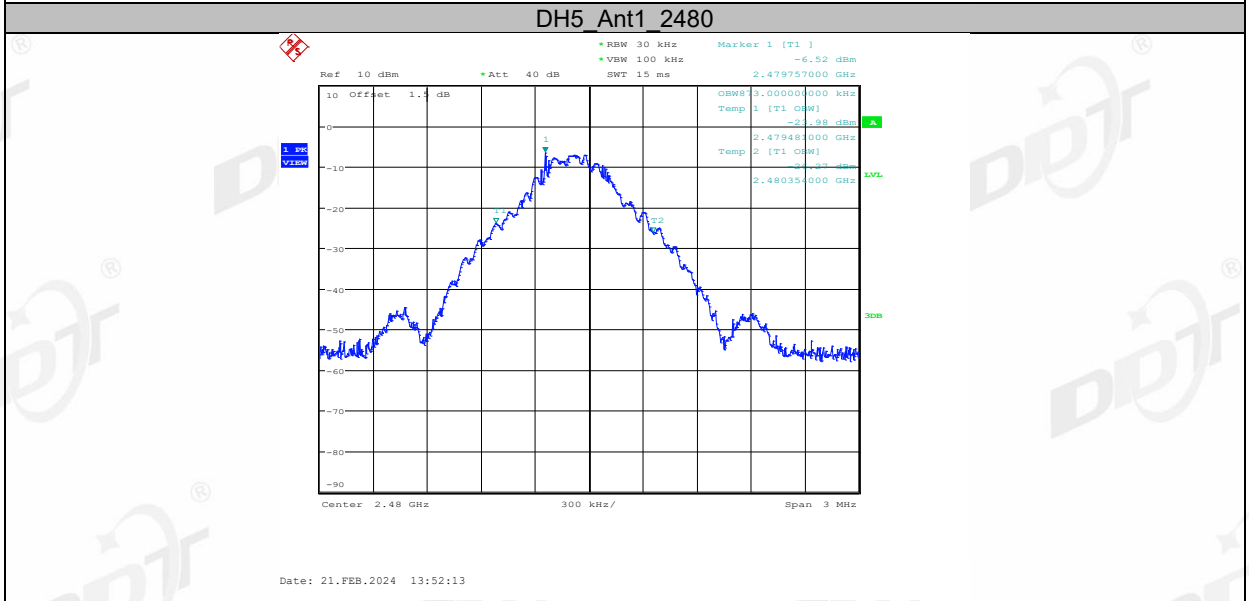
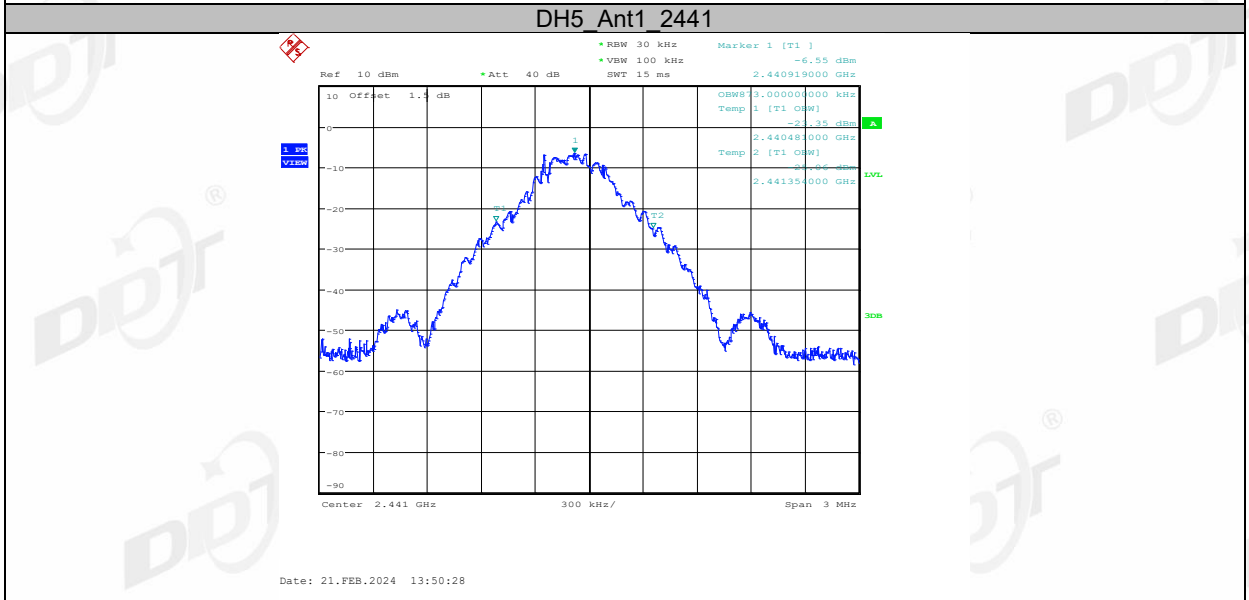
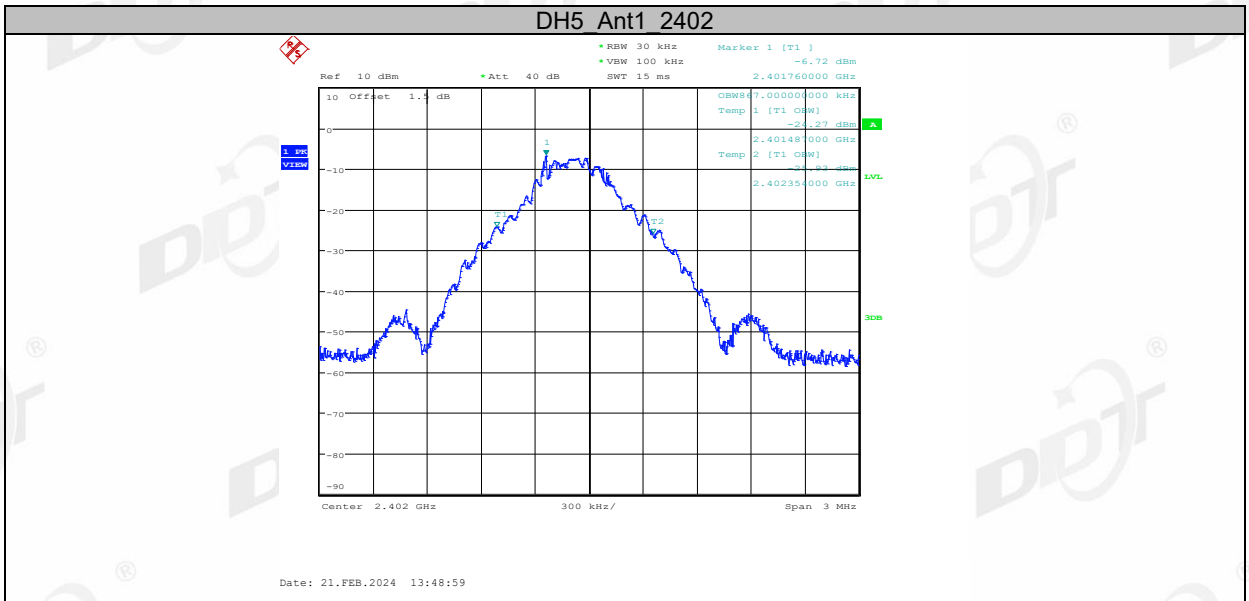

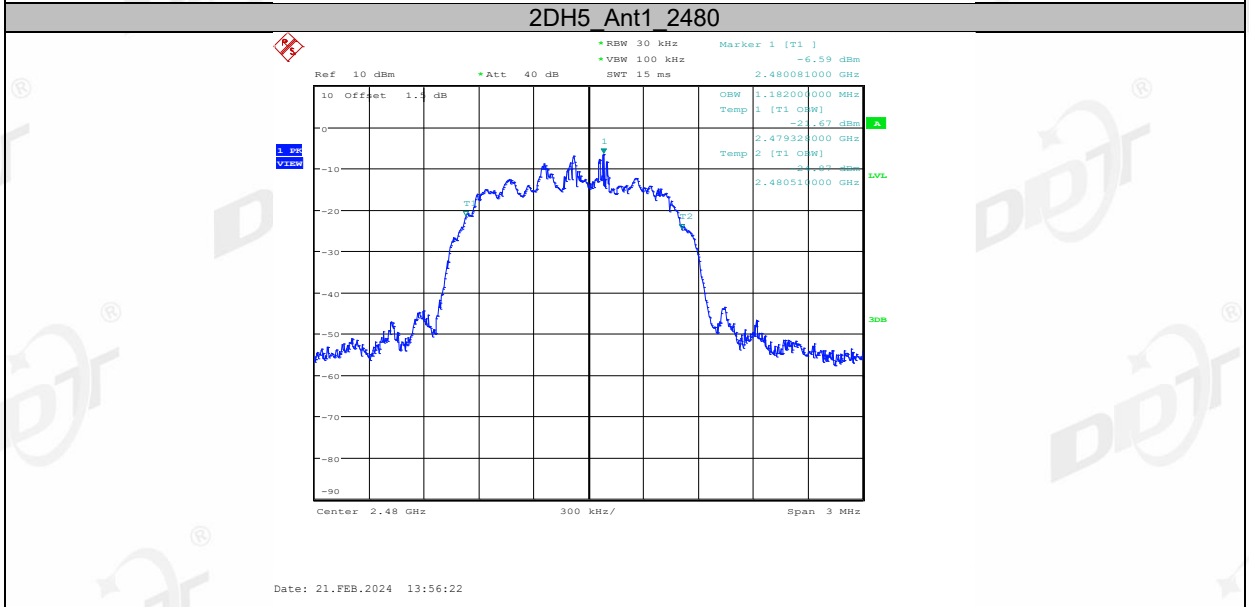
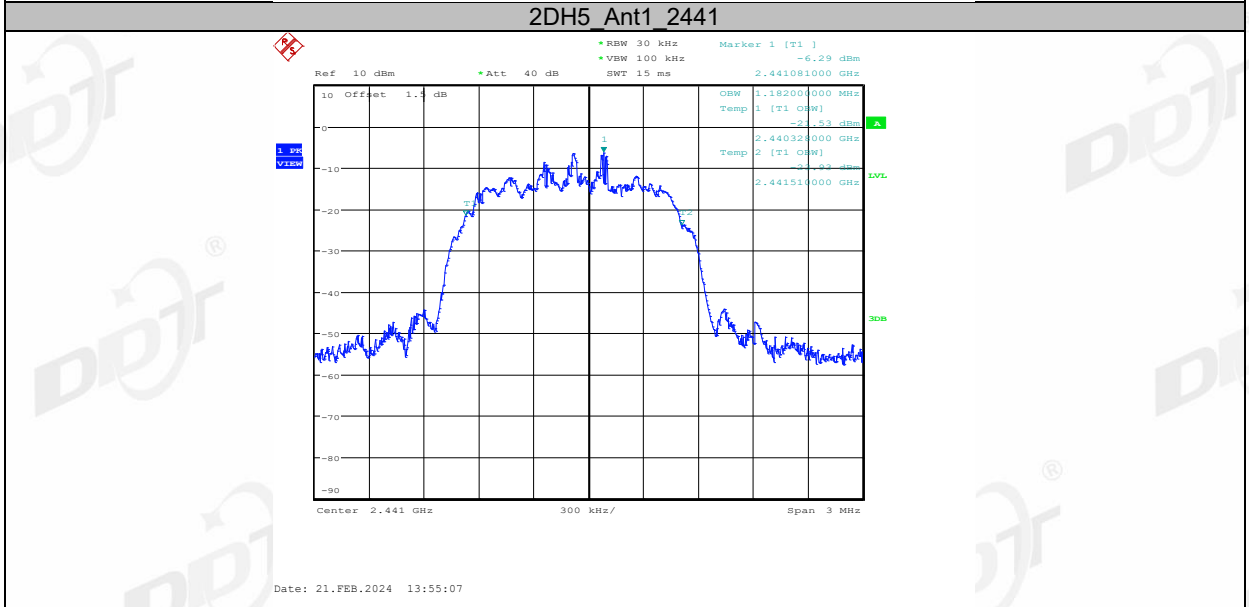
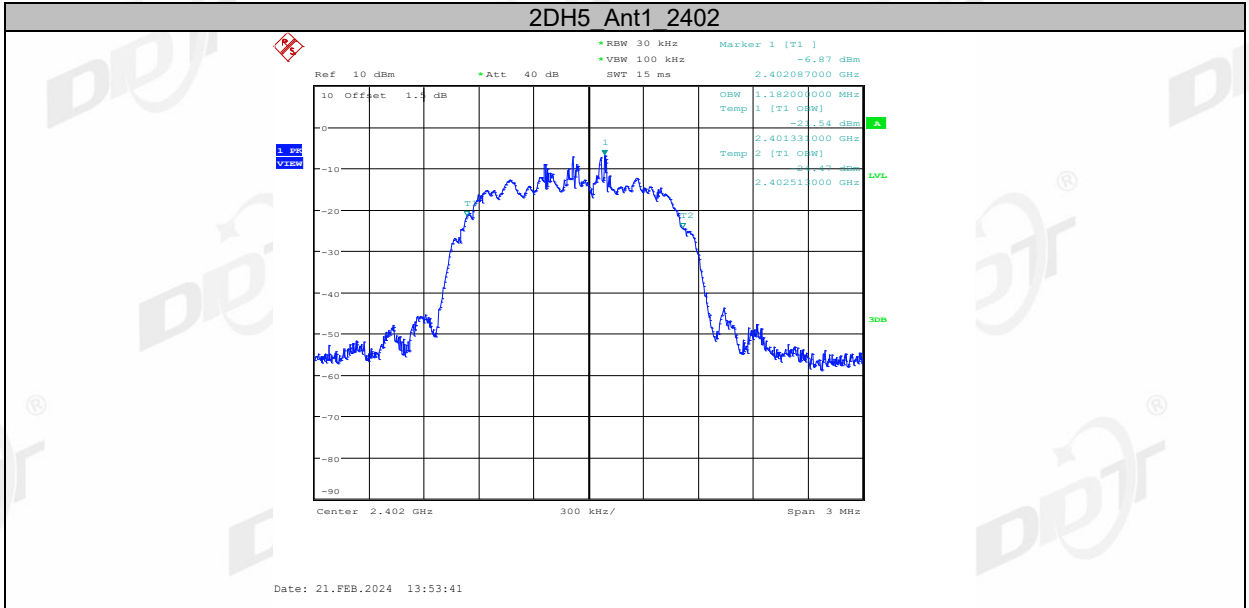

3DH5 Ant1 2402



3DH5 Ant1 2441

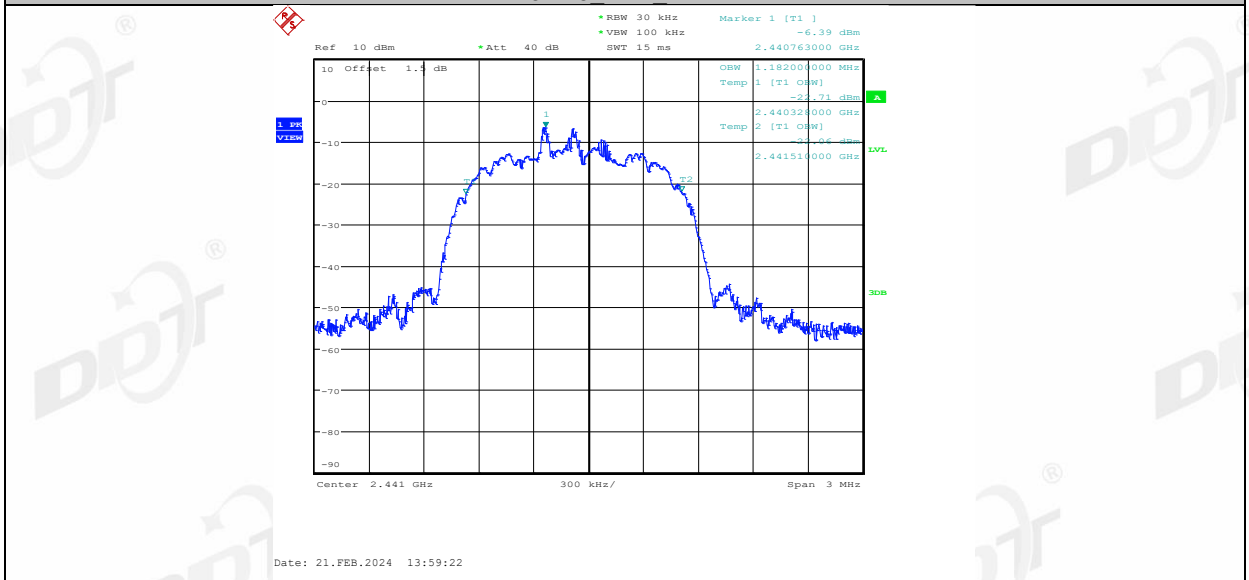

3DH5 Ant1 2480



6. Maximum Peak Output Power

6.1. Block diagram of test setup

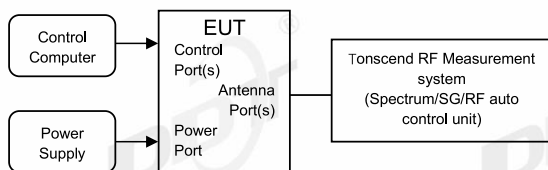

6.2. Limits

For frequency hopping systems operating in the 2400-2483.5 MHz band employing at least 75 non-overlapping hopping channels, and all frequency hopping systems in the 5725-5850 MHz band: 1 watt. For all other frequency hopping systems in the 2400-2483.5 MHz band: 0.125 watts, the e.i.r.p shall not exceed 4W.

6.3. Test procedure

- (1) The test according to ANSI C63.10-2013 clause 7.8.5.
- (2) Connect EUT's antenna output to spectrum analyzer by RF cable, the path loss was compensated to the results.
- (3) Set the EUT as maximum power setting and enable the EUT transmit continuously.
- (4) Use the following spectrum analyzer settings for the maximum peak output power measurement:

RBW:	> 20 dB bandwidth of the emission being measured.
VBW:	$VBW \geq RBW$.
Span:	Approximately five times the 20 dB bandwidth, centered on a hopping channel.
Detector Mode:	Peak
Sweep time:	Auto
Trace mode:	Max hold
- (5) Use the marker-to-peak function to set the marker to the peak of the emission and record the results in the report.

6.4. Test result

Test Engineer:	Zoe	Test Site:	RF Measurement System 2#
Ambient Condition:	24.3°C,46.1%RH	Test Date:	2024.02.21
Test Power Supply:	Battery	EUT:	Safe Audio Headphone
Sample Number:	S24010331-011	Model No.:	Buzz junior

Test Mode	Antenna	Frequency [MHz]	Conducted Peak Power[dBm]	Conducted Limit[dBm]	EIRP[dBm]	EIRP Limit[dBm]	Verdict
DH5	Ant1	2402	-3.90	≤20.97	-3.90	≤30	PASS
		2441	-3.41	≤20.97	-3.41	≤30	PASS
		2480	-3.65	≤20.97	-3.65	≤30	PASS
2DH5	Ant1	2402	-3.30	≤20.97	-3.30	≤30	PASS
		2441	-2.79	≤20.97	-2.79	≤30	PASS
		2480	-3.12	≤20.97	-3.12	≤30	PASS
3DH5	Ant1	2402	-2.79	≤20.97	-2.79	≤30	PASS
		2441	-2.27	≤20.97	-2.27	≤30	PASS
		2480	-2.66	≤20.97	-2.66	≤30	PASS

6.5.Test graphs

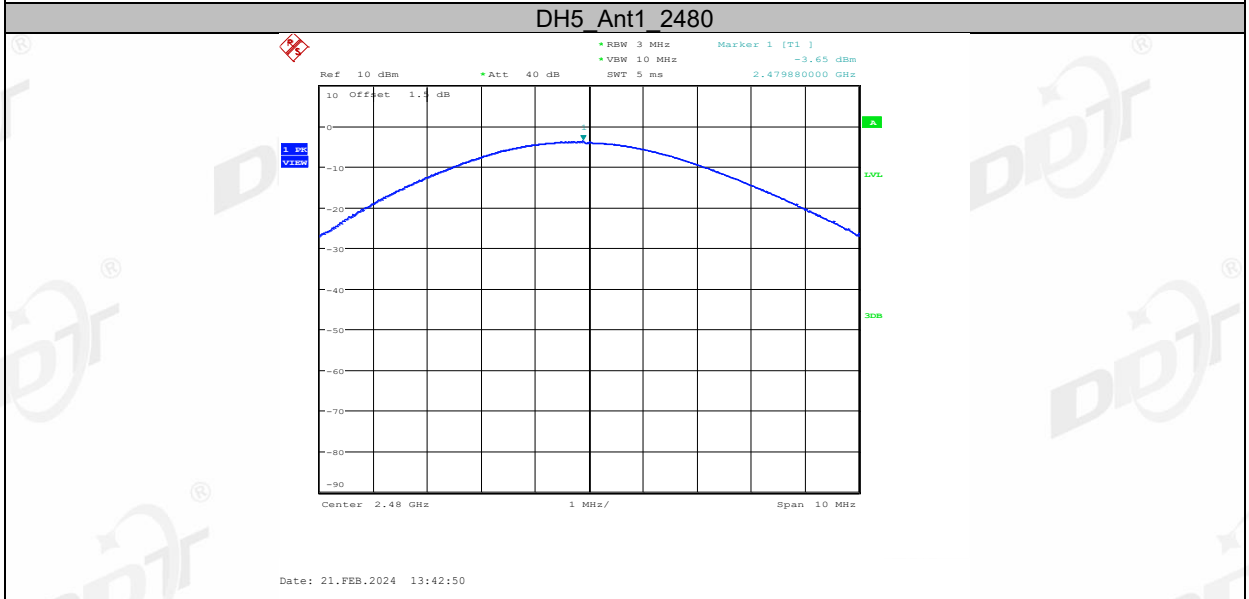
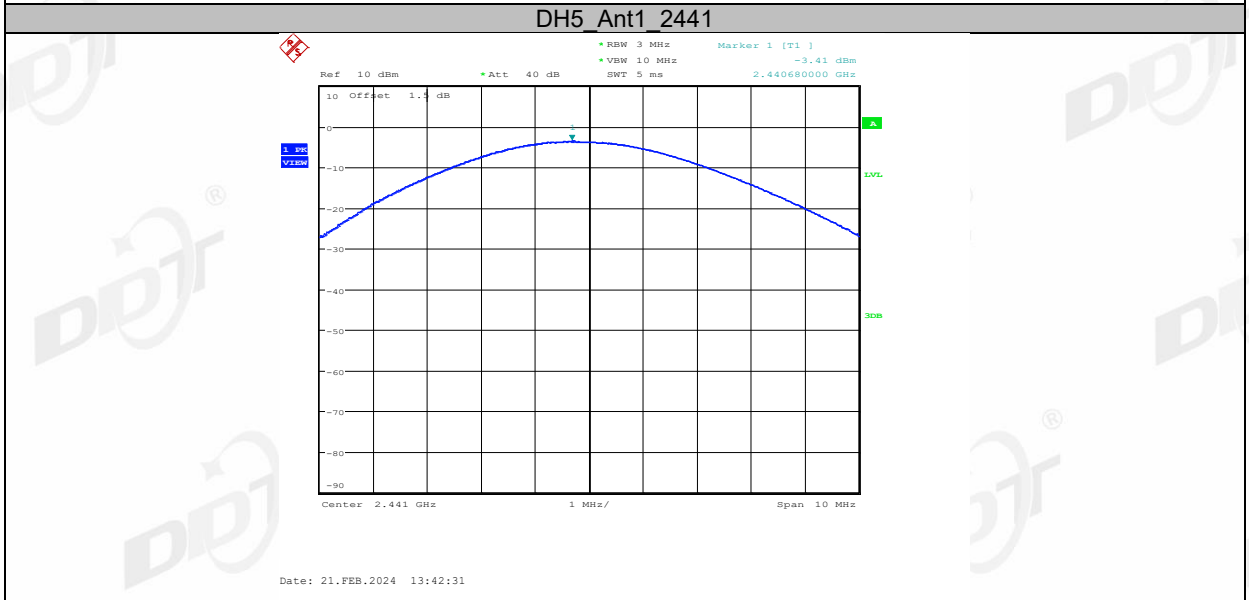
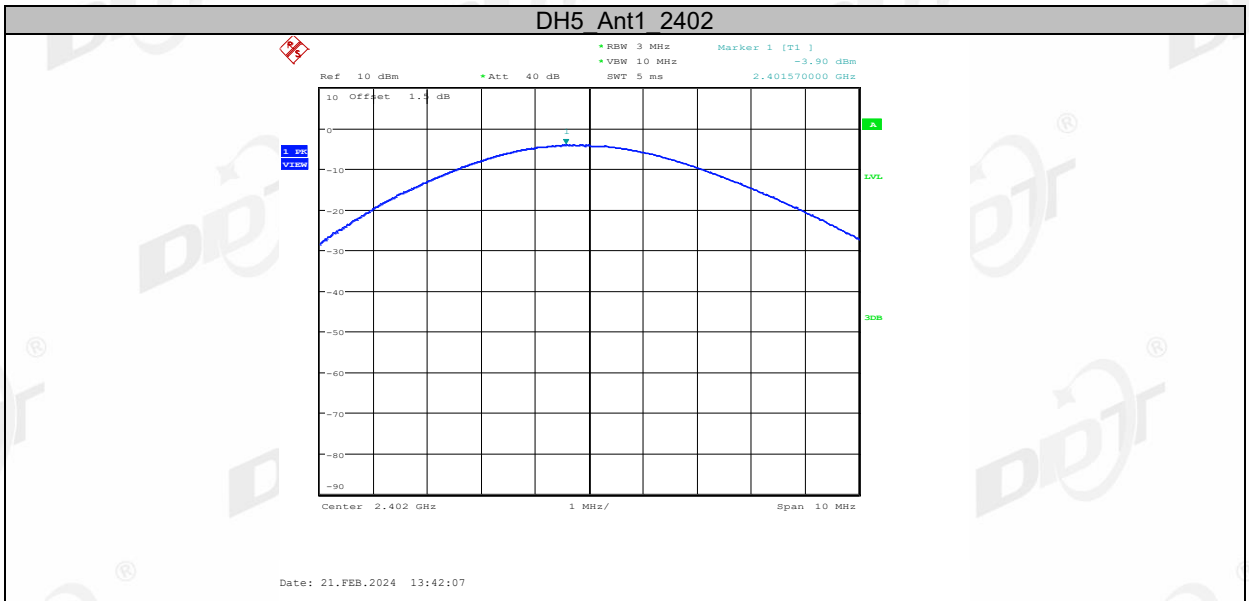

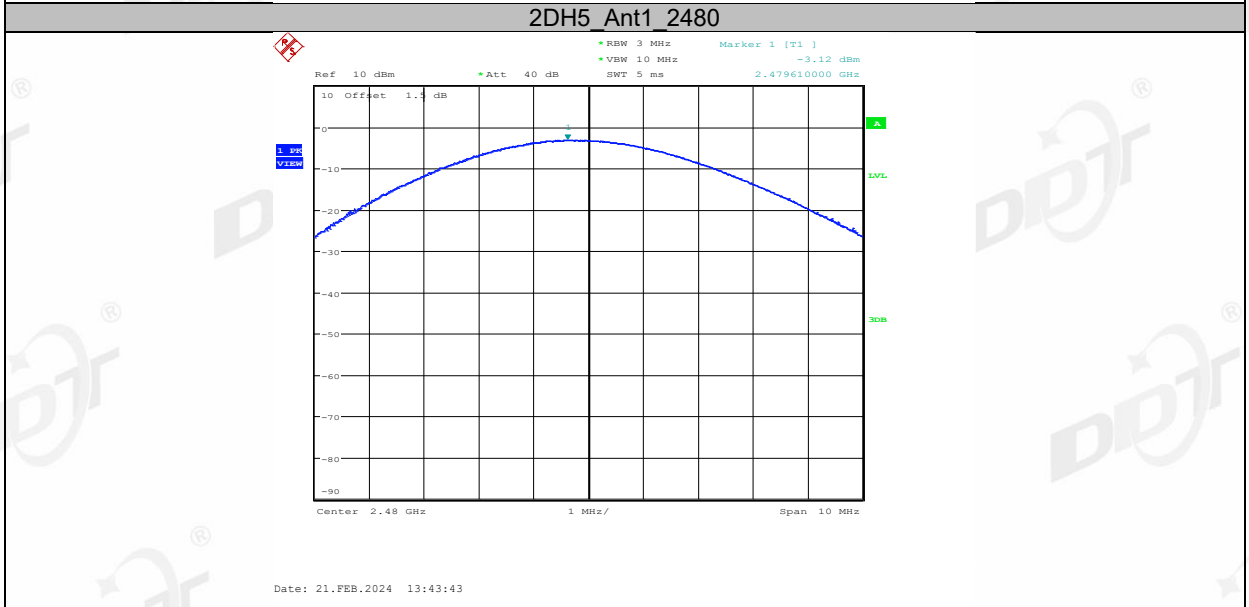
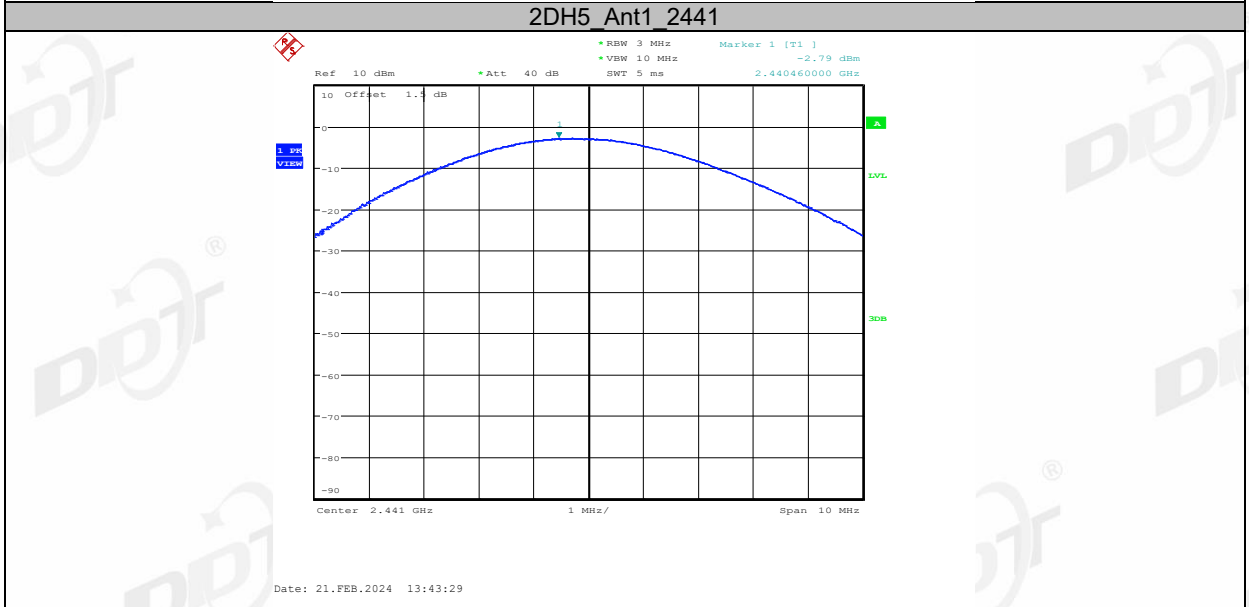
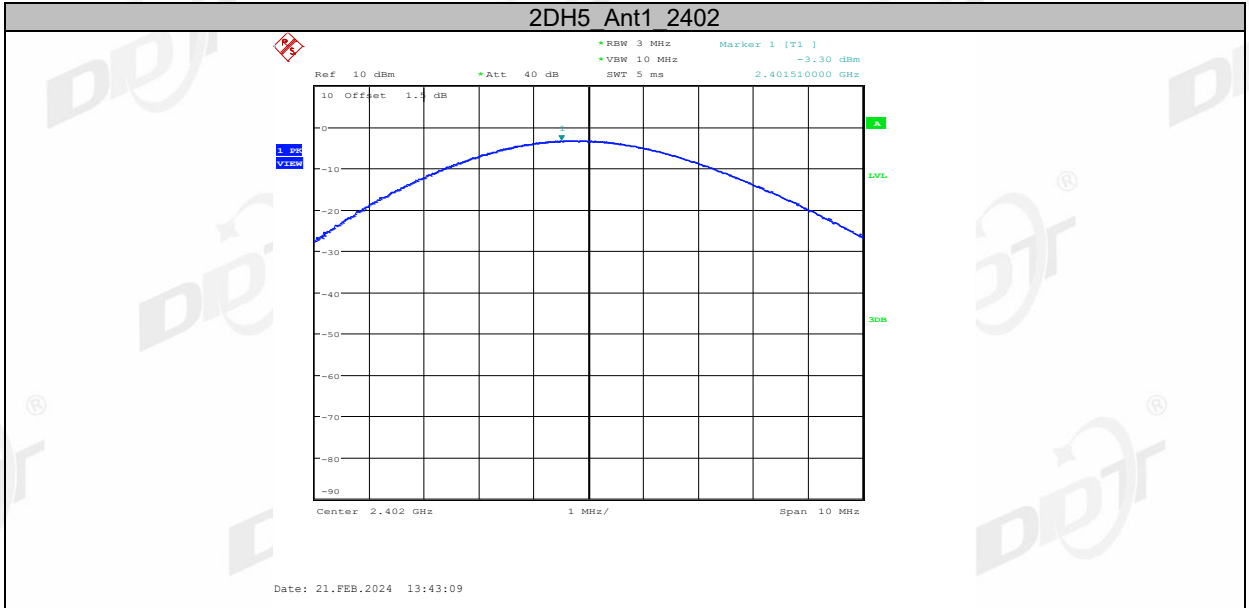

3DH5 Ant1 2402

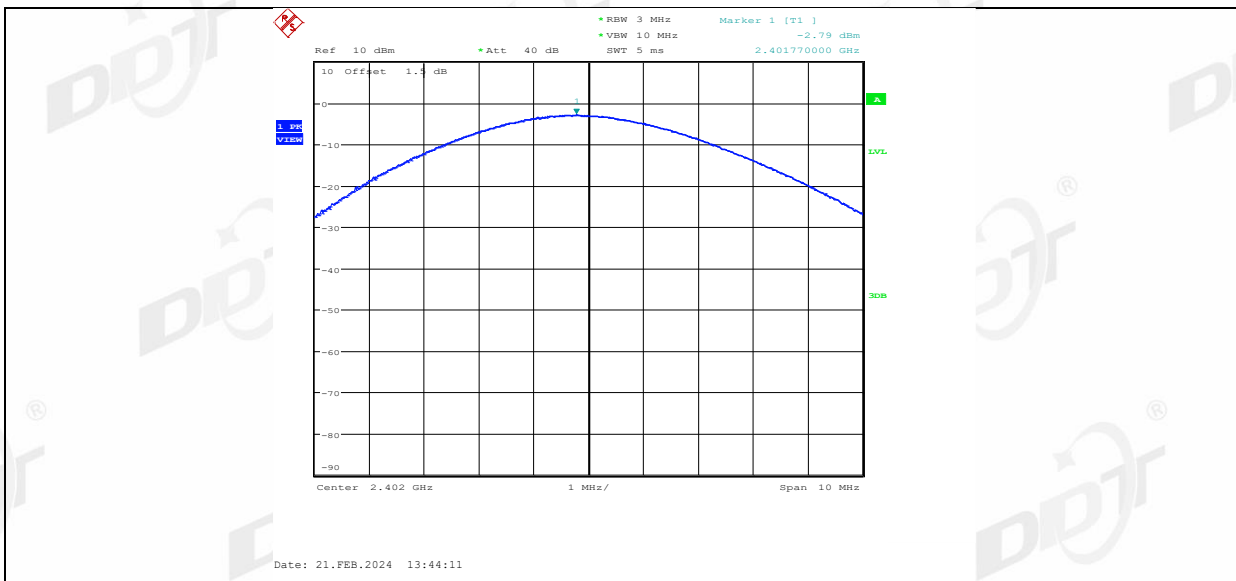

3DH5 Ant1 2441

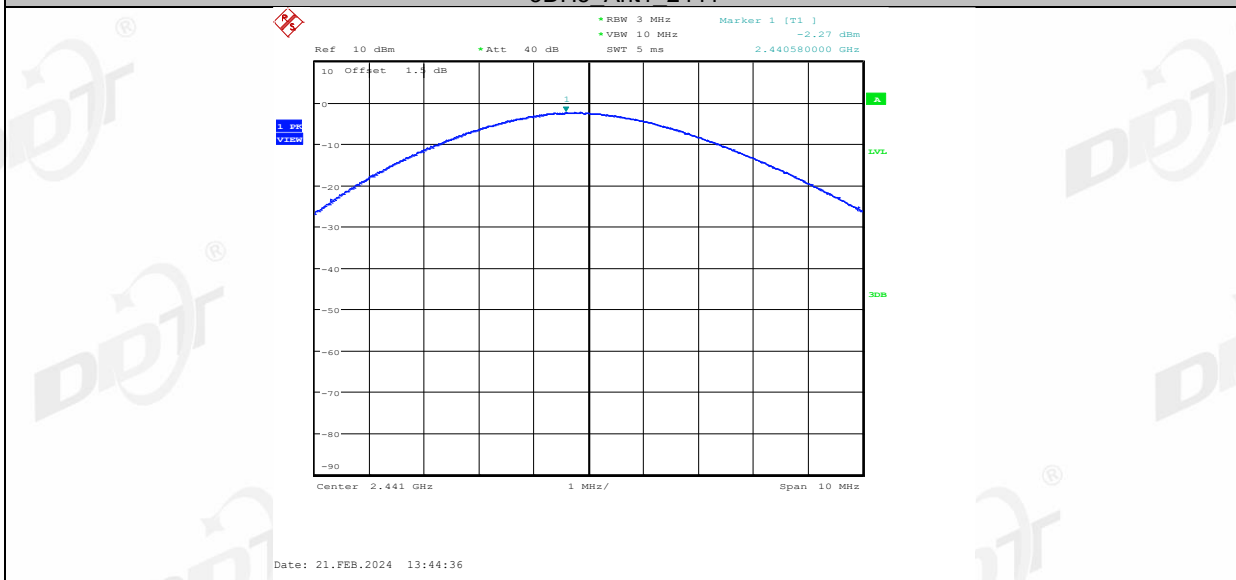

3DH5 Ant1 2480

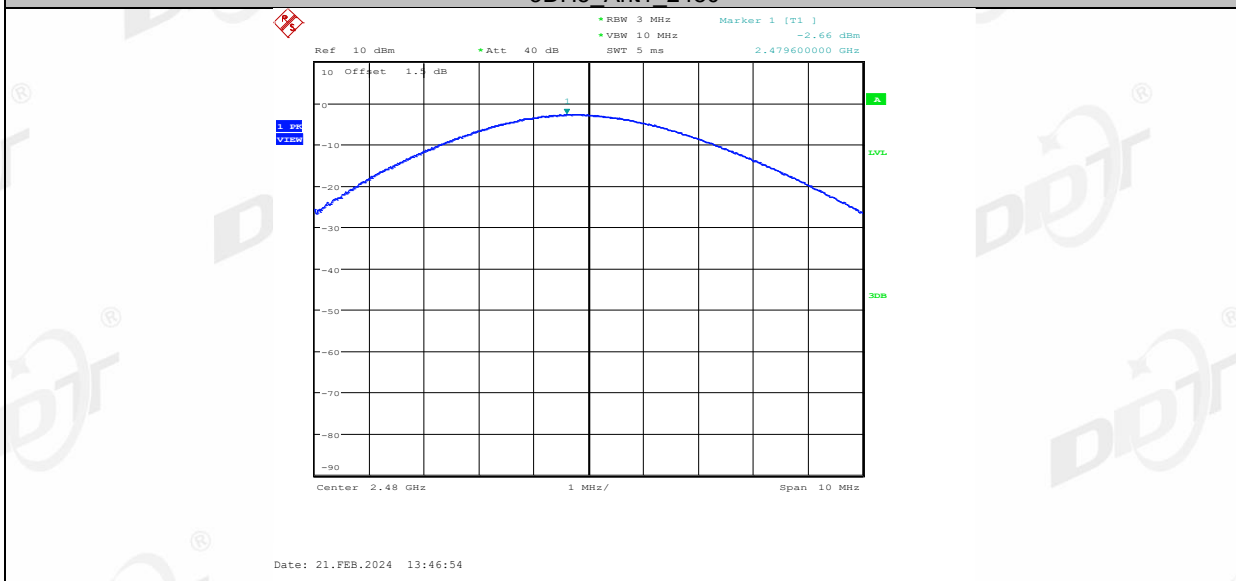

7. Carrier Frequency Separation

7.1. Block diagram of test setup

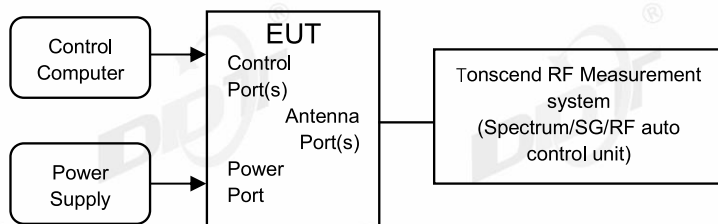

7.2. Limits

Frequency hopping systems shall have hopping channel carrier frequencies separated by a minimum of 25 kHz or the 20 dB bandwidth of the hopping channel, whichever is greater. Alternatively, frequency hopping systems operating in the 2400-2483.5 MHz band may have hopping channel carrier frequencies that are separated by 25 kHz or two-thirds of the 20 dB bandwidth of the hopping channel, whichever is greater, provided the systems operate with an output power no greater than 125 mW.

7.3. Test procedure

- (1) The test according to ANSI C63.10-2013 clause 7.8.2.
- (2) Connect EUT's antenna output to spectrum analyzer by RF cable, the path loss was compensated to the results.
- (3) Set the EUT as maximum power setting and enable the EUT transmit continuously.
- (4) Use the following spectrum analyzer settings for the maximum peak output power measurement:

RBW:	approximately 30% of the channel spacing
VBW:	VBW \geq RBW.
Span:	Wide enough to capture the peaks of two adjacent channels.
Detector Mode:	Peak
Sweep time:	Auto
Trace mode:	Max hold
- (5) Use the marker-delta function to determine the separation between the peaks of the adjacent channels and record the results in the report.

7.4. Test result

Test Engineer:	Zoe	Test Site:	RF Measurement System 2#
Ambient Condition:	24.3°C,46.1%RH	Test Date:	2024.02.21
Test Power Supply:	Battery	EUT:	Safe Audio Headphone
Sample Number:	S24010331-011	Model No.:	Buzz junior

Test Mode	Antenna	Frequency [MHz]	Result [MHz]	Limit [MHz]	Verdict
DH5	Ant1	Hop	0.997	≥0.960	PASS
2DH5	Ant1	Hop	1.003	≥0.873	PASS
3DH5	Ant1	Hop	1	≥0.867	PASS

7.5. Test graphs

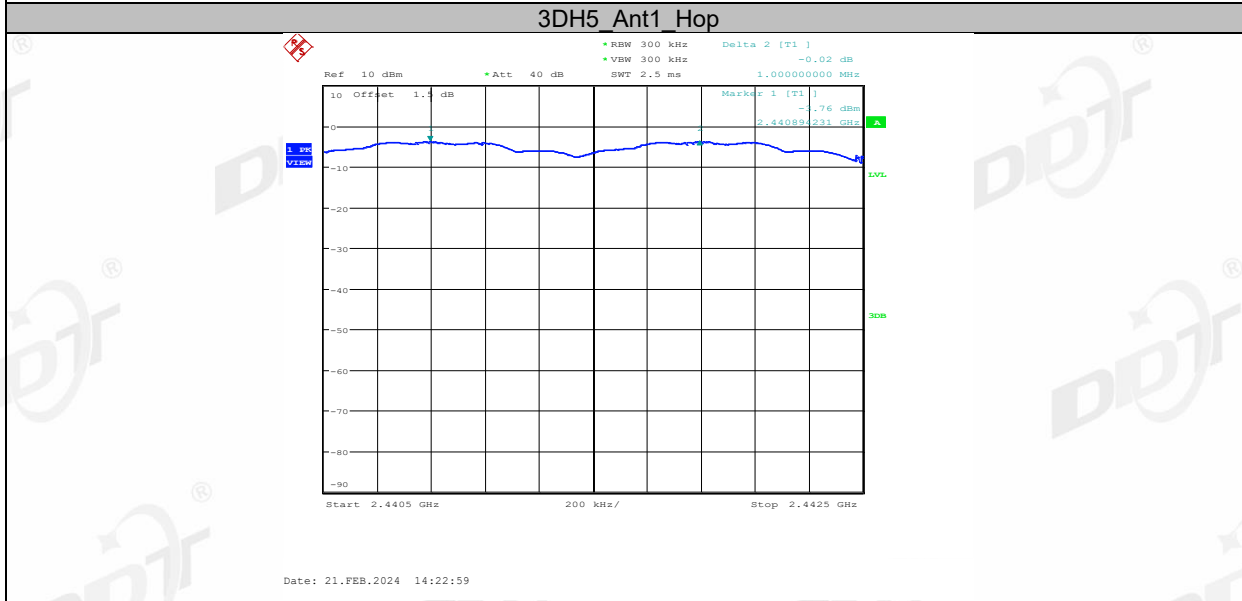
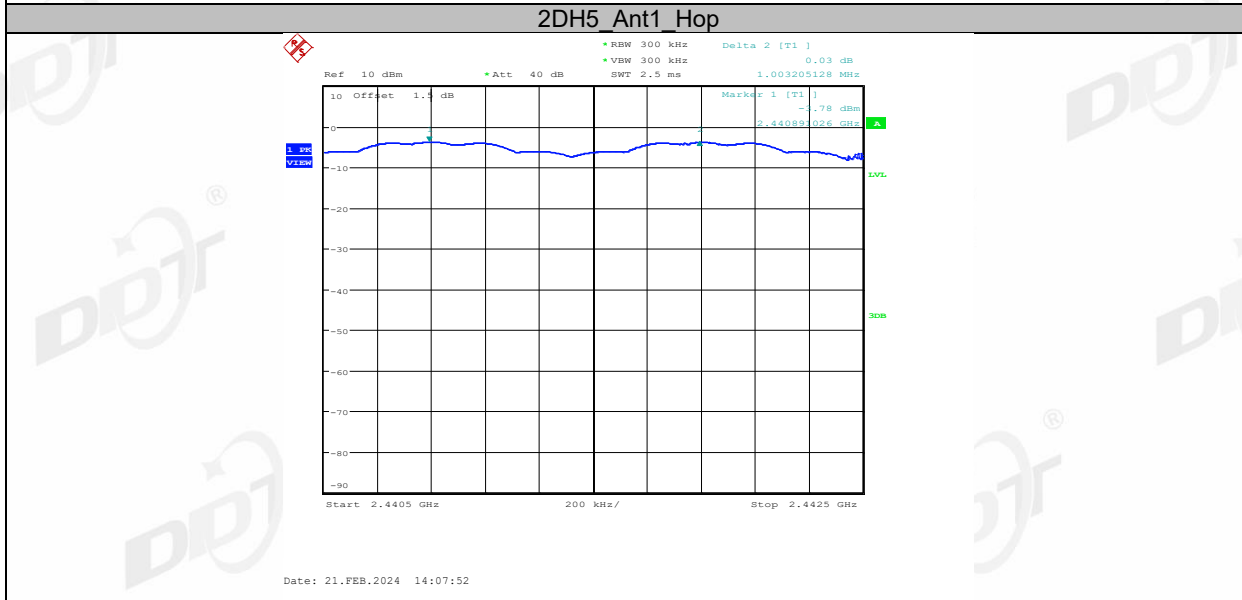
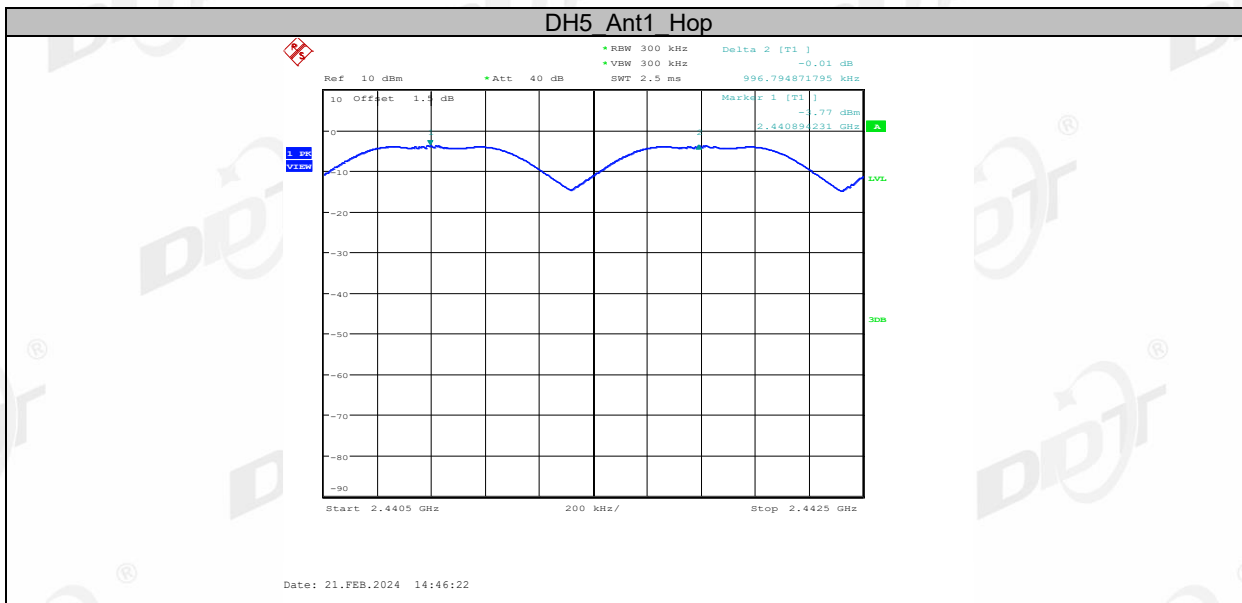

8. Dwell Time

8.1. Block diagram of test setup

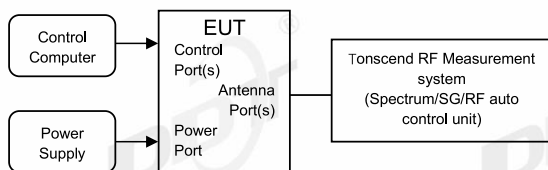

8.2. Limits

The average time of occupancy on any channel shall not be greater than 0.4 seconds within a period of 0.4 seconds multiplied by the number of hopping channels employed.

8.3. Test procedure

- (1) The test according to ANSI C63.10-2013 clause 7.8.4.
- (2) Connect EUT's antenna output to spectrum analyzer by RF cable, the path loss was compensated to the results.
- (3) Set the EUT as maximum power setting and enable the EUT transmit continuously.
- (4) Use the following spectrum analyzer settings for the maximum peak output power measurement:

RBW:	≤ channel spacing and where possible RBW should be set $\gg 1 / T$
VBW:	$VBW \geq RBW$.
Span:	Zero span, centered on a hopping channel.
Detector Mode:	Peak
Sweep time:	Auto
Trace mode:	Clear Write.
- (5) The test period: $T = 0.4 \text{ Second/Channel} \times 79 \text{ Channel} = 31.6 \text{ s}$
- (6) Measure the hopping number and on time of each pulse with spectrum analyzer in zero span set, and calculate dwell time with formula $\text{Dwell time} = \text{total hops} \times \text{pulse's on time}$.
- (7) Measure and record the results in the report.

8.4. Test result

Test Engineer:	Zoe	Test Site:	RF Measurement System 2#
Ambient Condition:	24.3°C,46.1%RH	Test Date:	2024.02.21
Test Power Supply:	Battery	EUT:	Safe Audio Headphone
Sample Number:	S24010331-011	Model No.:	Buzz junior

Test Mode	Antenna	Frequency [MHz]	BurstWidth [ms]	TotalHops [Num]	Result[s]	Limit[s]	Verdict
DH1	Ant1	Hop	0.360	316	0.114	≤0.4	PASS
DH3	Ant1	Hop	1.610	159	0.256	≤0.4	PASS
DH5	Ant1	Hop	2.865	103	0.295	≤0.4	PASS
2DH1	Ant1	Hop	0.360	320	0.115	≤0.4	PASS
2DH3	Ant1	Hop	1.620	154	0.249	≤0.4	PASS
2DH5	Ant1	Hop	2.880	114	0.328	≤0.4	PASS
3DH1	Ant1	Hop	0.370	320	0.118	≤0.4	PASS
3DH3	Ant1	Hop	1.620	158	0.256	≤0.4	PASS
3DH5	Ant1	Hop	2.880	111	0.32	≤0.4	PASS

8.5. Test graphs

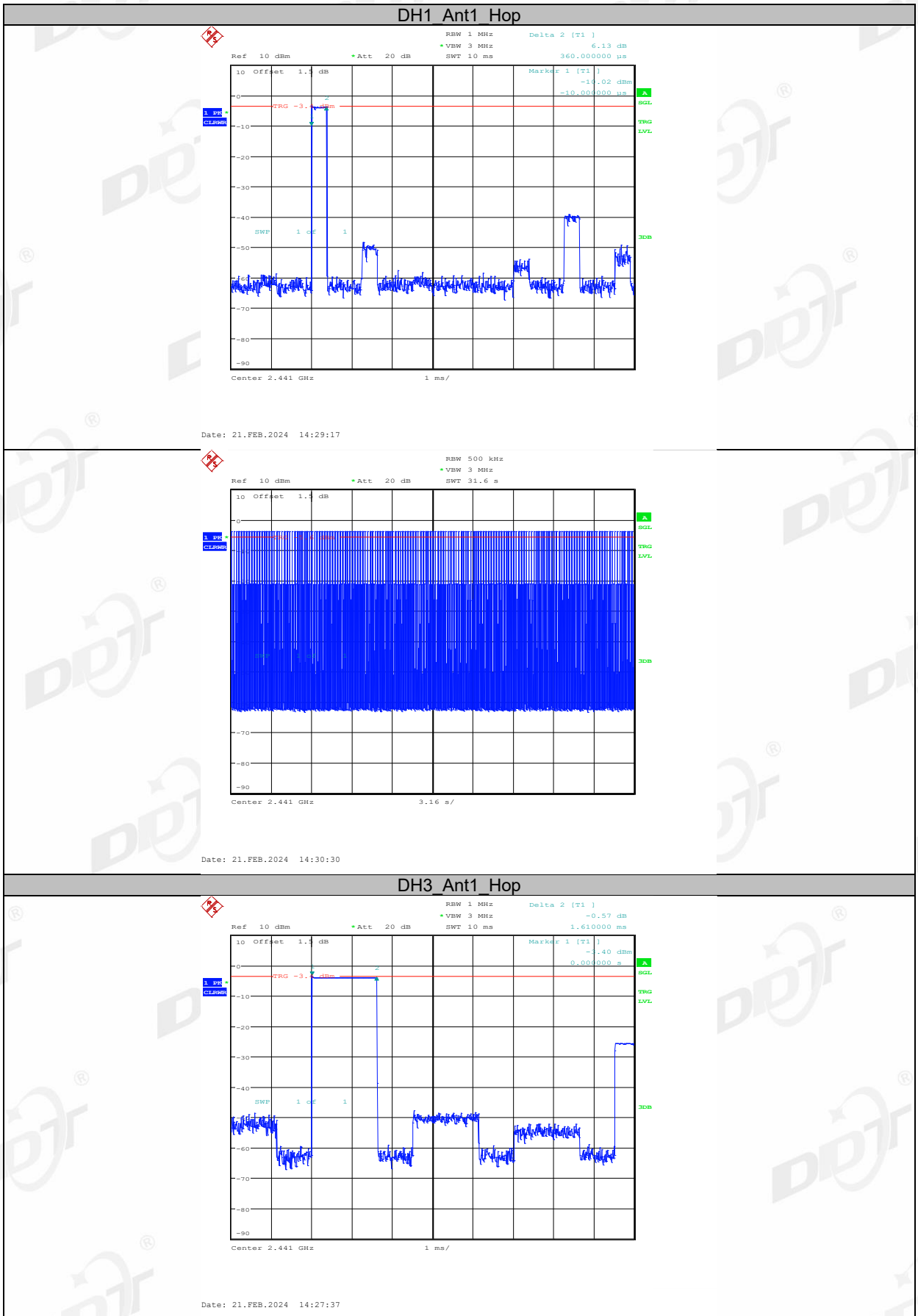

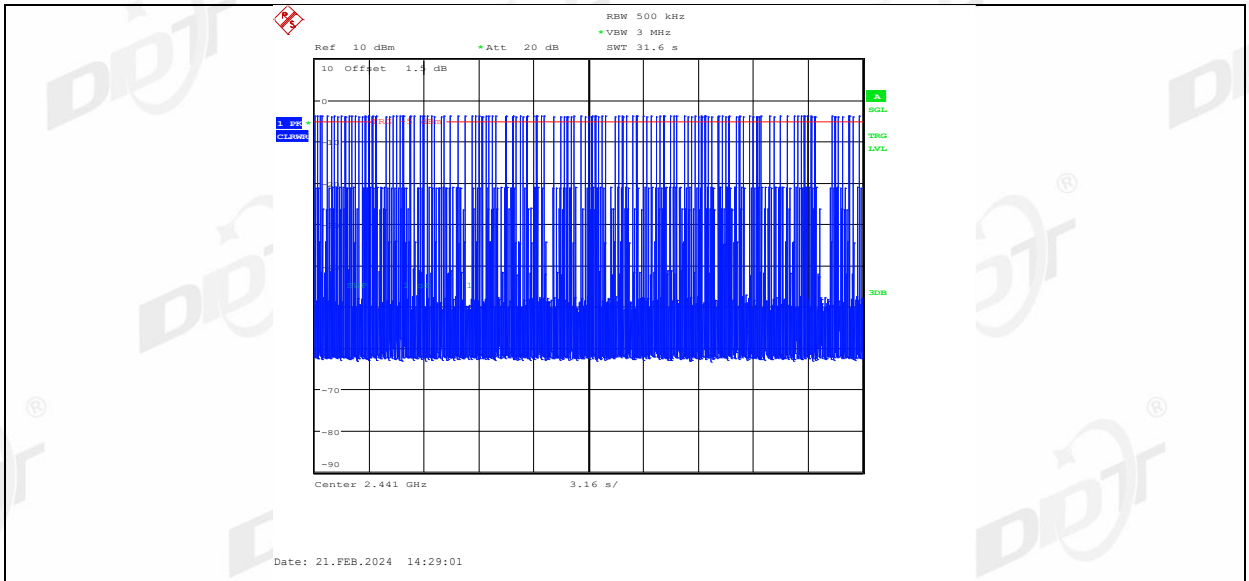

DH5 Ant1 Hop

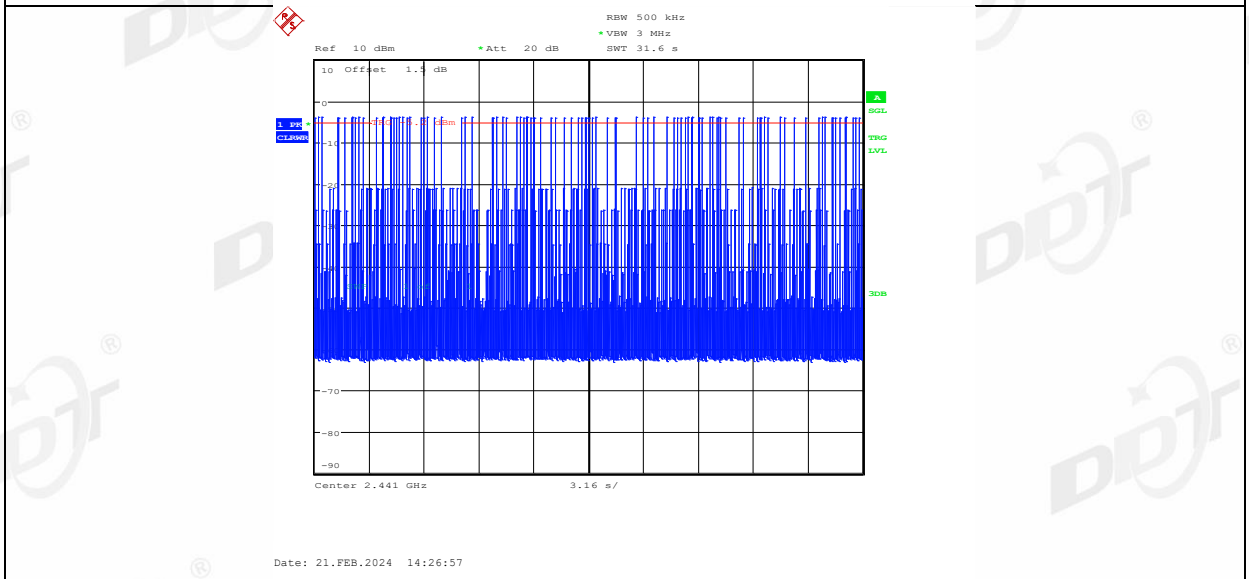
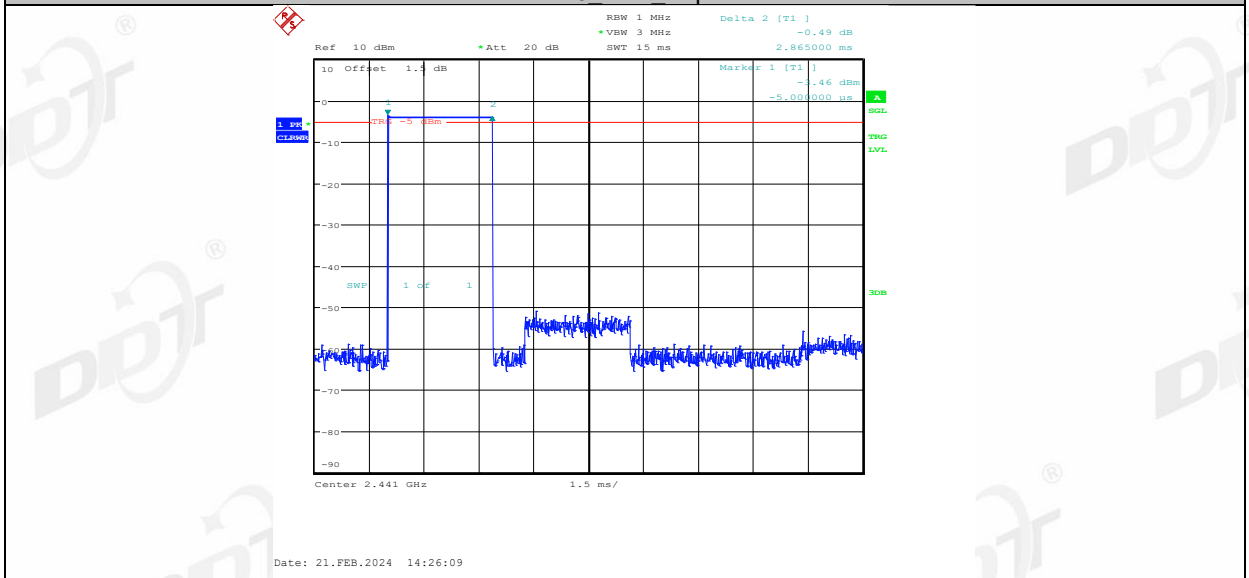

2DH1_Ant1_Hop

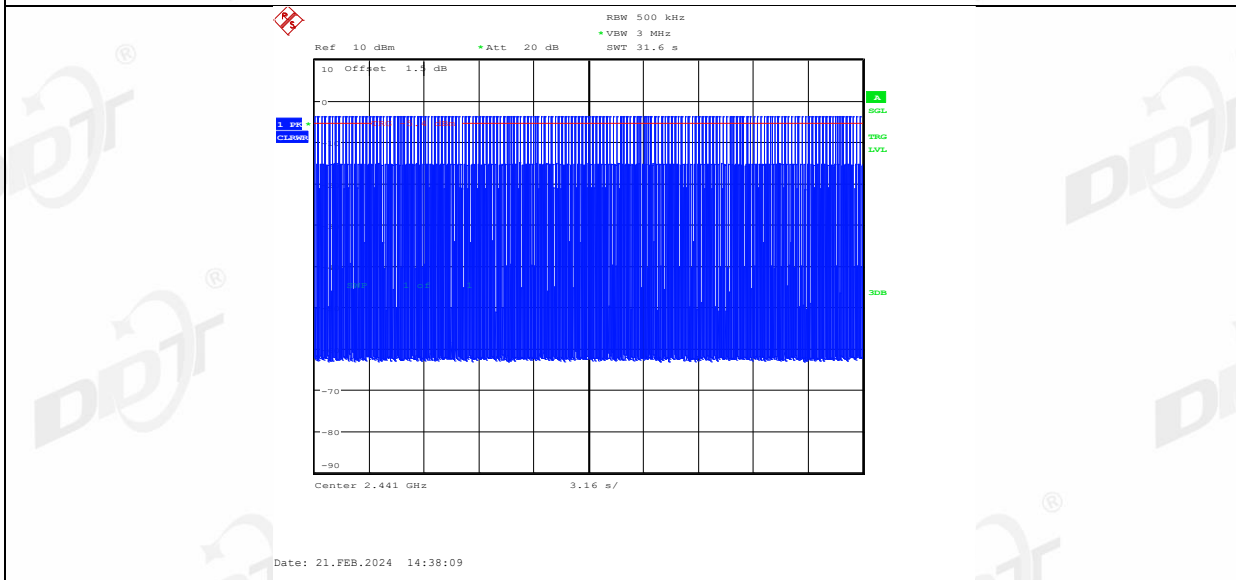
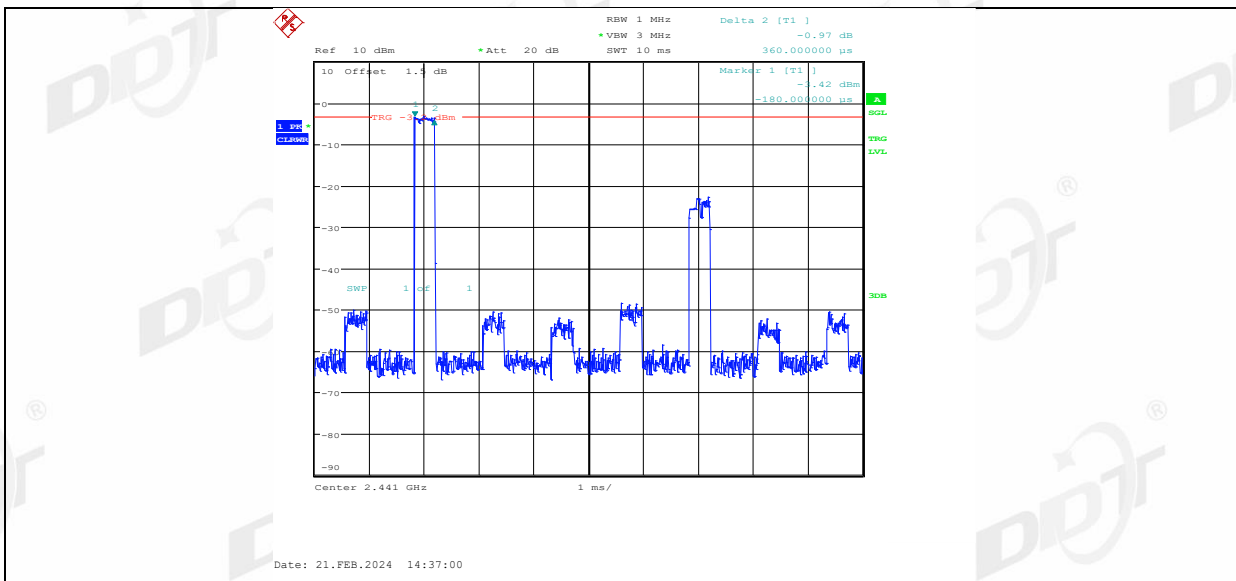

2DH3_Ant1_Hop

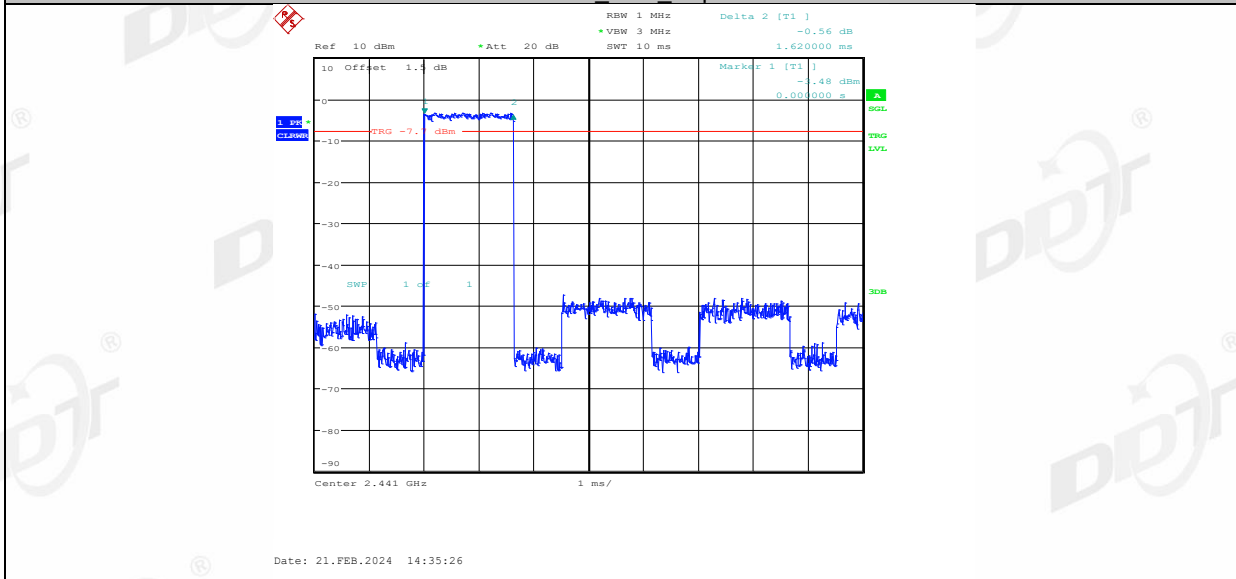

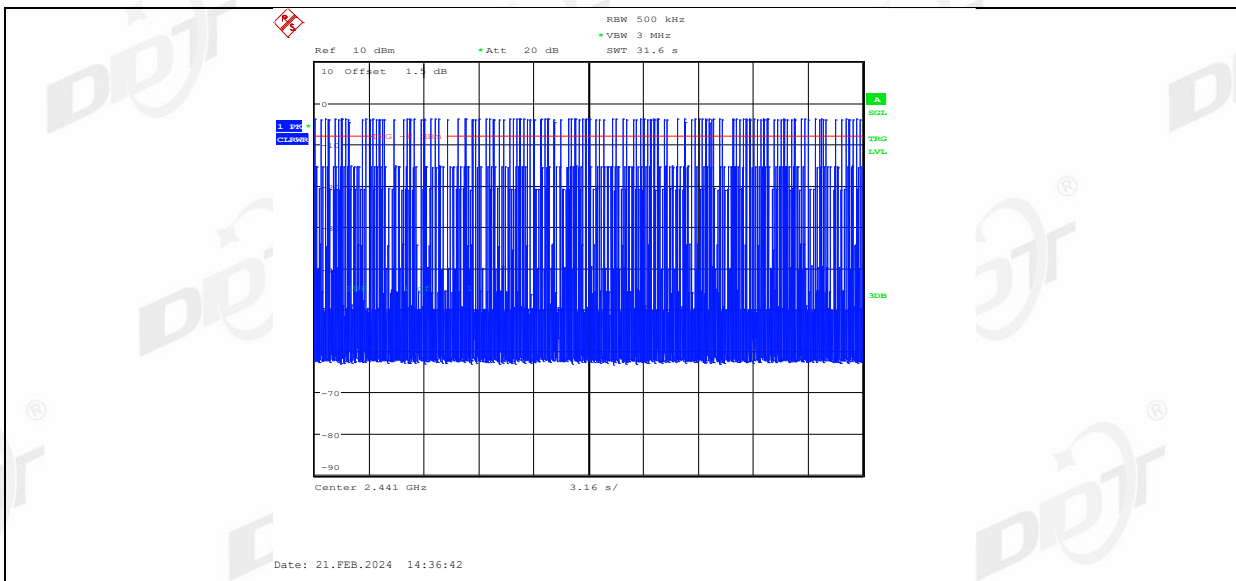

2DH5_Ant1_Hop

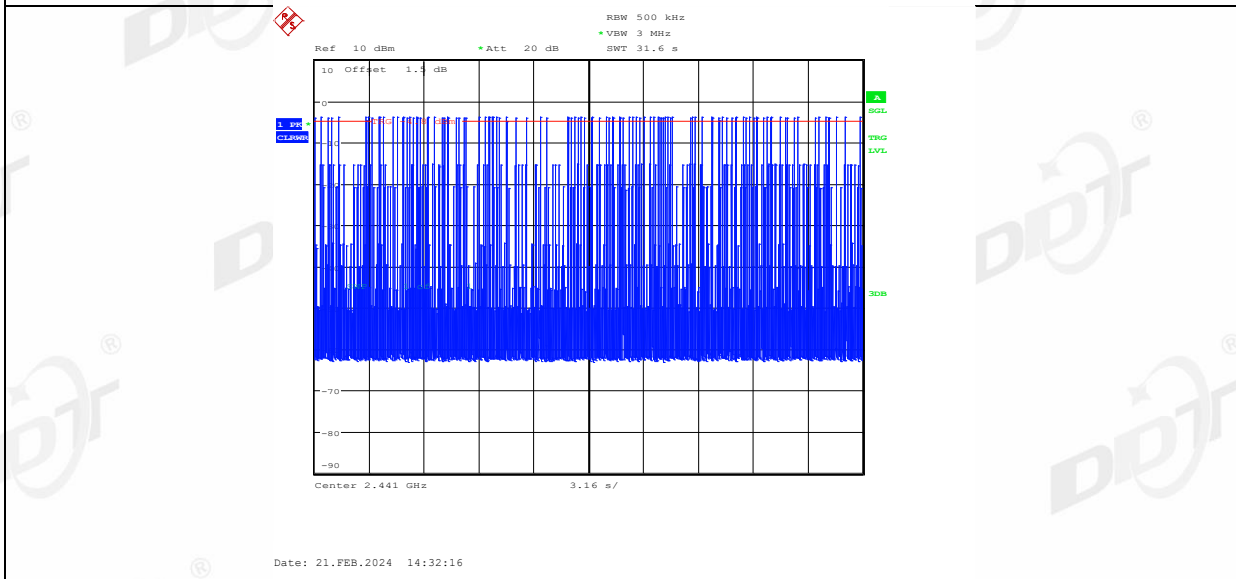
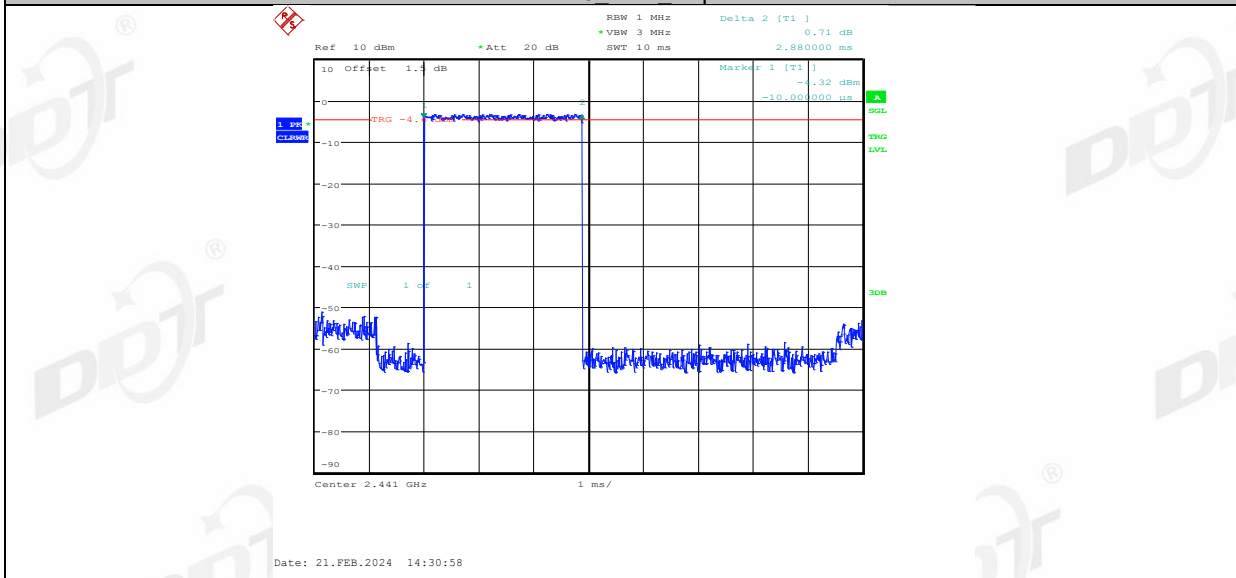

3DH1_Ant1_Hop

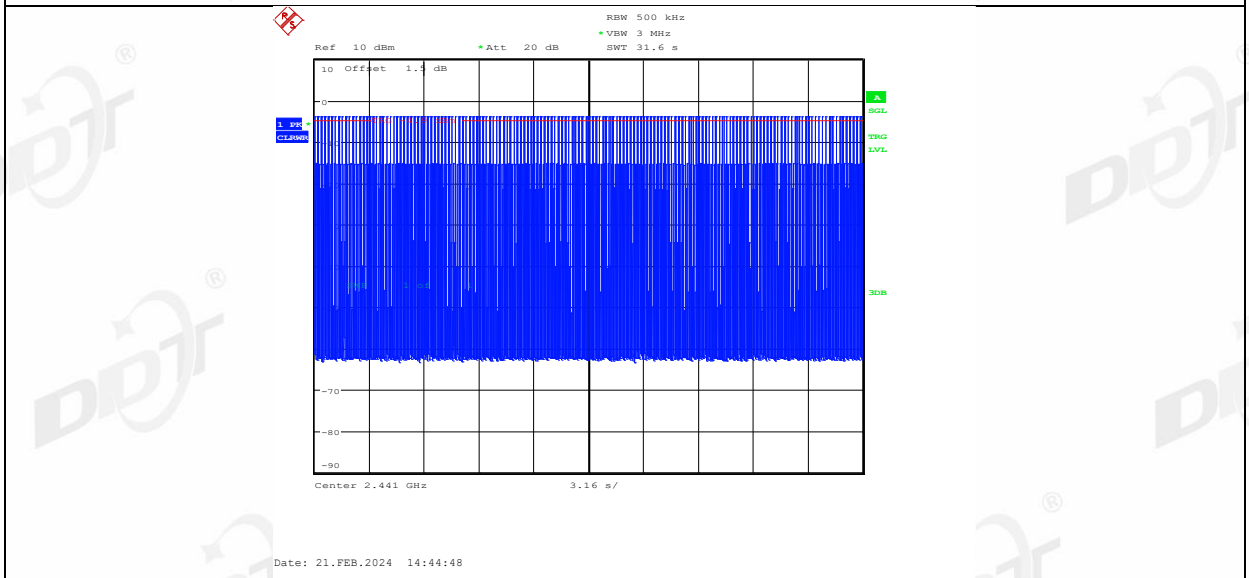
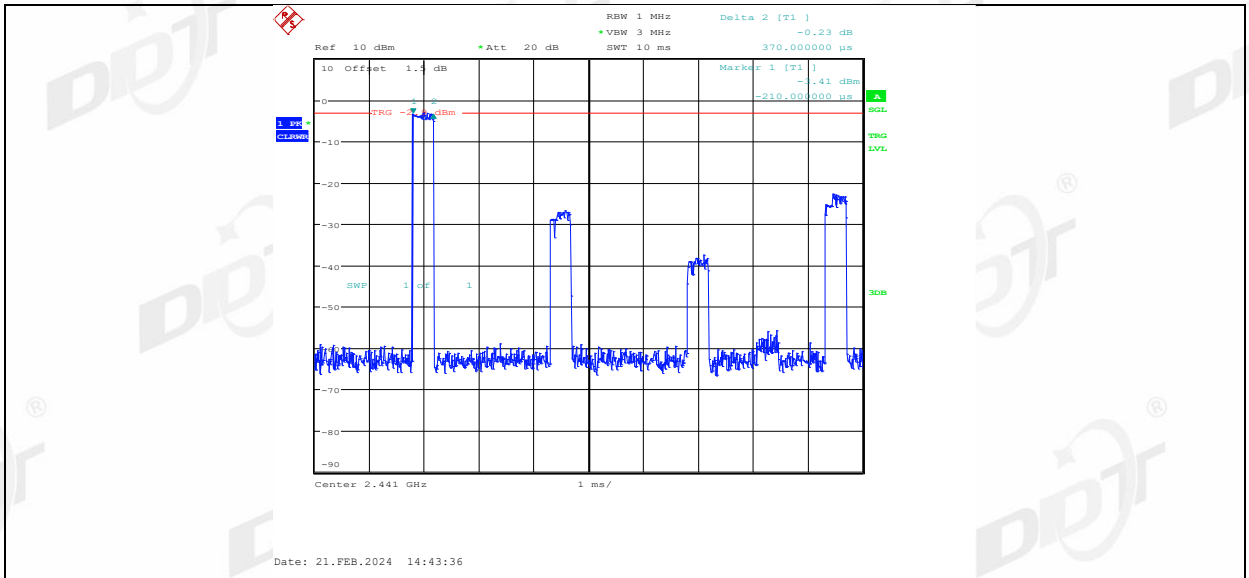

3DH3_Ant1_Hop

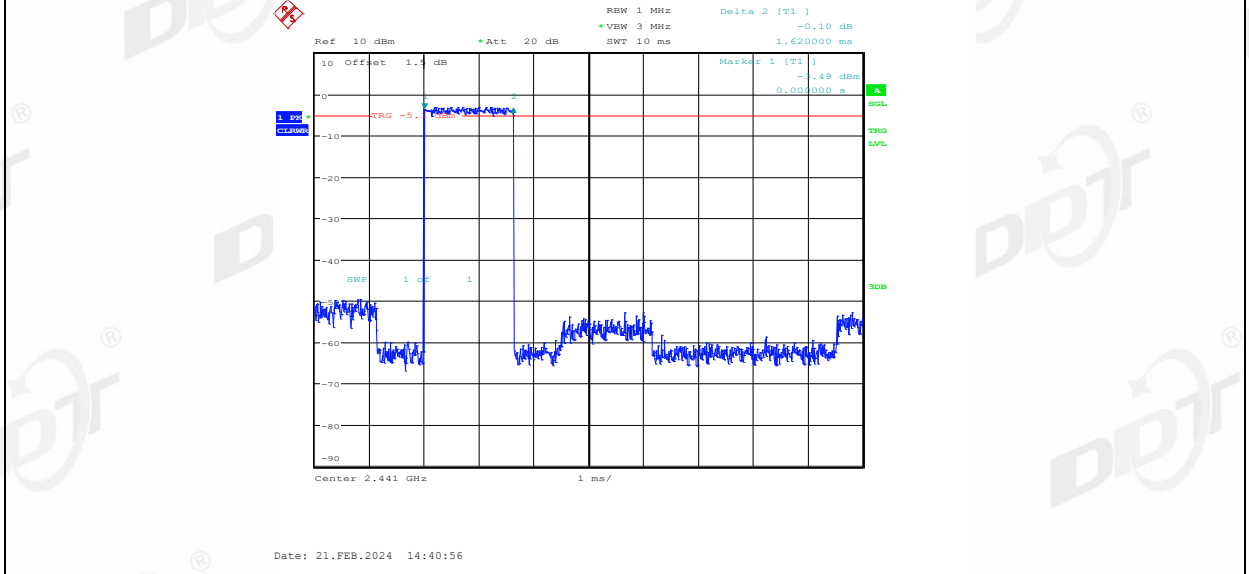

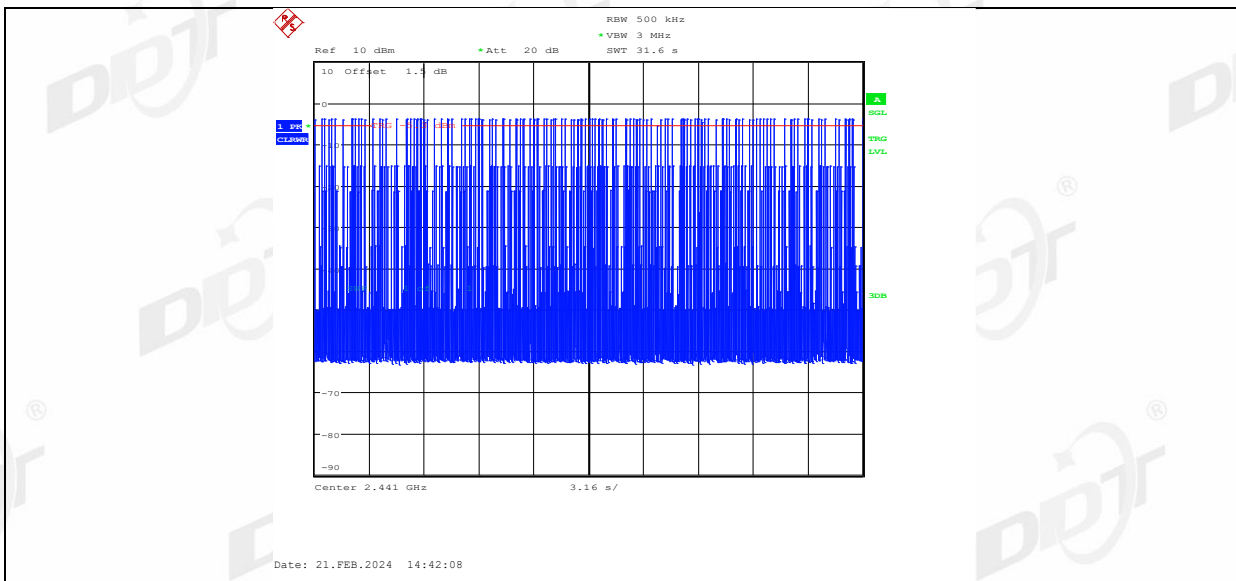

3DH5 Ant1 Hop

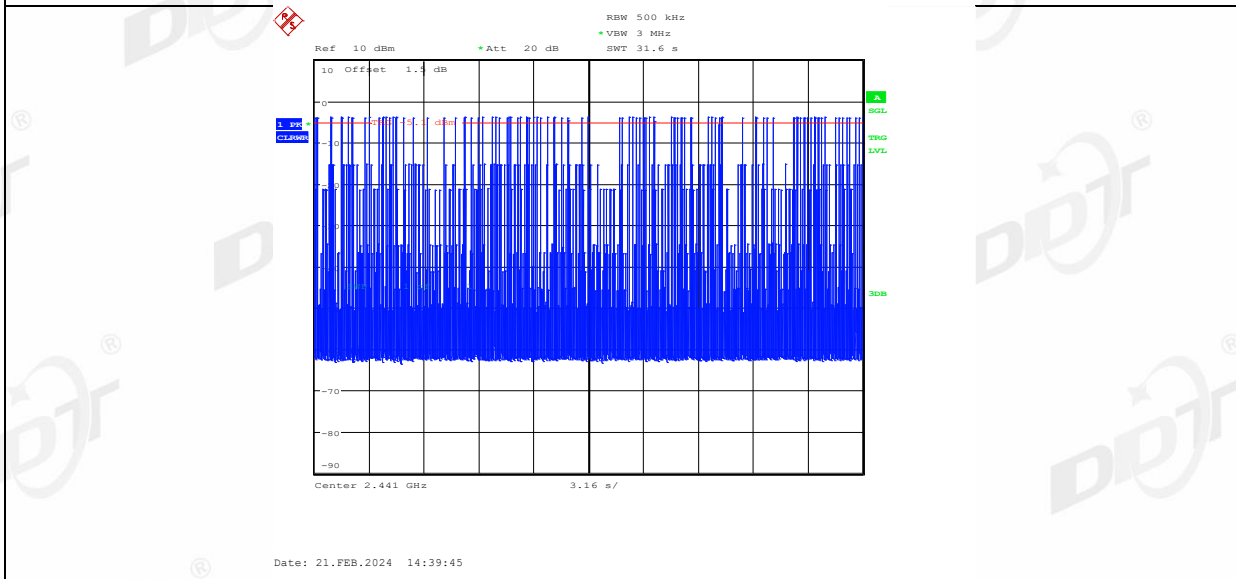
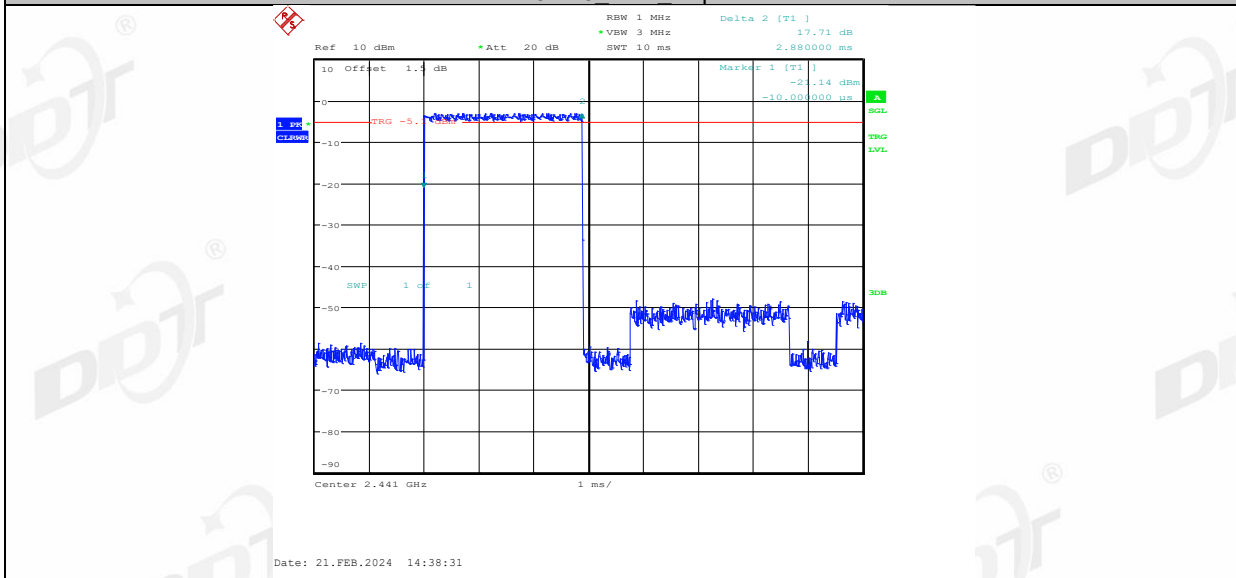

9. Number of Hopping Channel

9.1. Block diagram of test setup

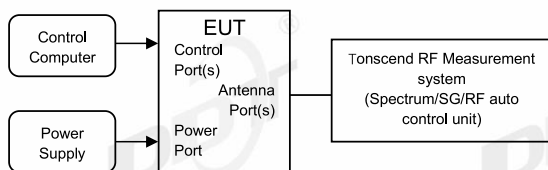

9.2. Limits

Frequency hopping systems in the 2400-2483.5 MHz band shall use at least 15 channels.

9.3. Test procedure

- (1) The test according to ANSI C63.10-2013 clause 7.8.3.
- (2) Connect EUT's antenna output to spectrum analyzer by RF cable, the path loss was compensated to the results.
- (3) Set the EUT as maximum power setting and enable the EUT transmit continuously.
- (4) Use the following spectrum analyzer settings for the maximum peak output power measurement:

RBW:	RBW to less than 30% of the channel spacing or the 20 dB bandwidth, whichever is smaller.
VBW:	VBW \geq RBW.
Span:	The frequency band of operation
Detector Mode:	Peak
Sweep time:	Auto
Trace mode:	Max hold

- (5) Measure the hopping number and record the results in the report.
- (6) Measure and record the results in the report.

9.4. Test result

Test Engineer:	Zoe	Test Site:	RF Measurement System 2#
Ambient Condition:	24.3°C,46.1%RH	Test Date:	2024.02.21
Test Power Supply:	Battery	EUT:	Safe Audio Headphone
Sample Number:	S24010331-011	Model No.:	Buzz junior

Test Mode	Antenna	Frequency [MHz]	Result [Num]	Limit [Num]	Verdict
DH5	Ant1	Hop	79	≥15	PASS
2DH5	Ant1	Hop	79	≥15	PASS
3DH5	Ant1	Hop	79	≥15	PASS

9.5. Test graphs

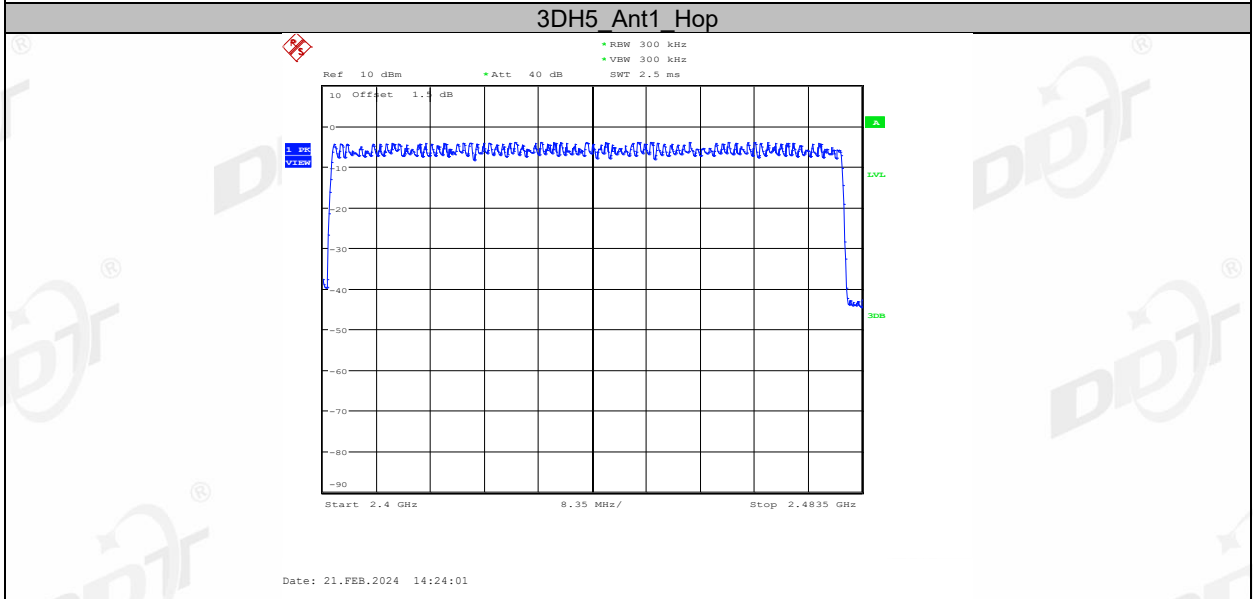
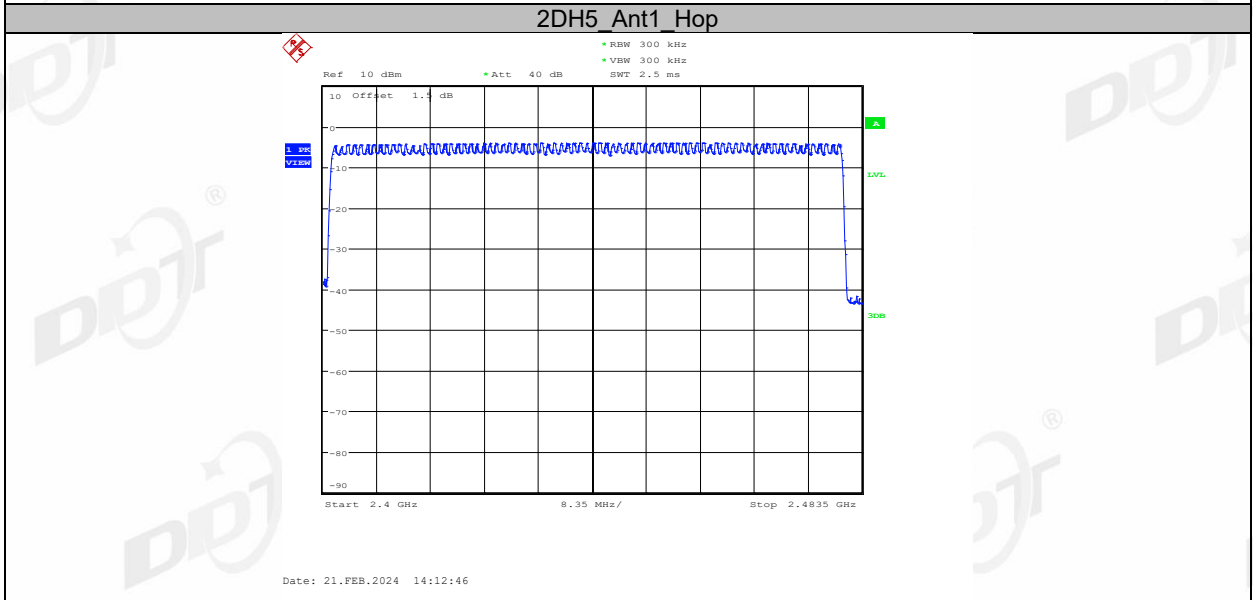
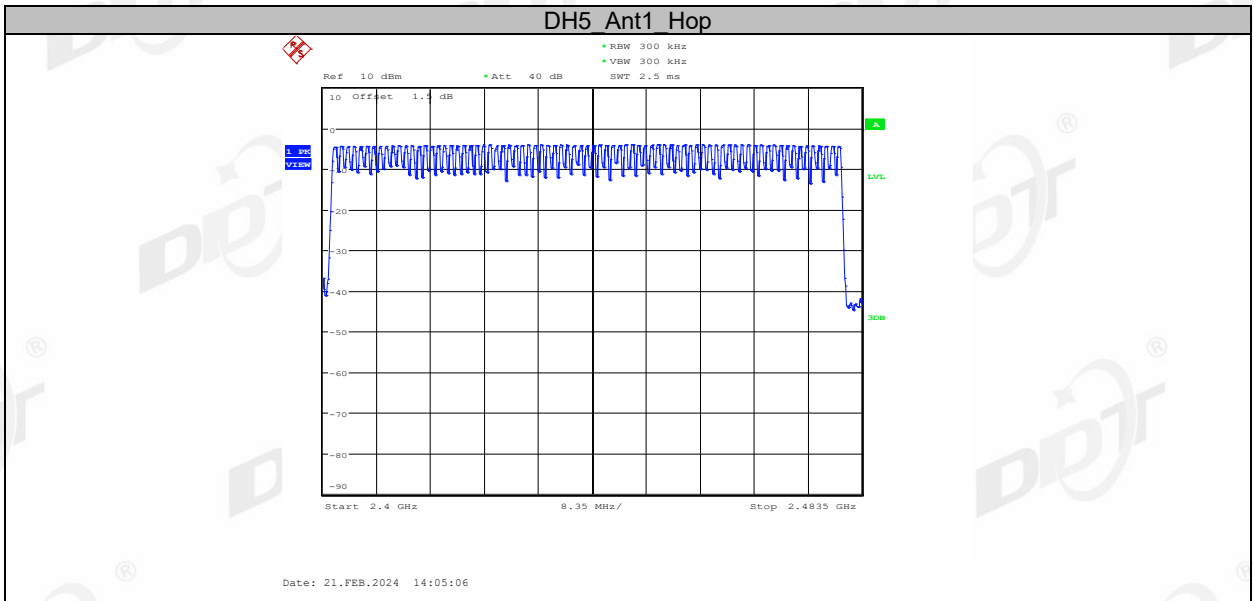

10. Band Edge Compliance (Conducted Method)

10.1. Block diagram of test setup

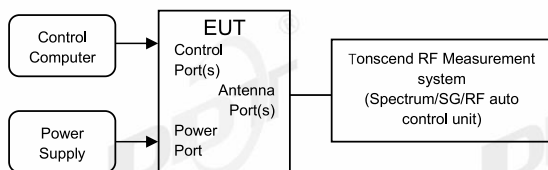

10.2. Limit

All restriction band should comply with 15.209, other emission should be at least 20dB below the fundamental.

10.3. Test procedure

- (1) Connect EUT's antenna output to spectrum analyzer by RF cable.
- (2) Establish a reference level by using the following procedure:

RBW:	100 kHz
VBW:	300 kHz
Span	Encompass frequency range to be measured
Detector Mode:	Peak
Sweep time:	Auto
Trace mode	Max hold
- (3) Allow the trace to stabilize, use the peak marker function to determine the maximum peak power level to establish the reference level.
- (4) Then mark the maximum amplitude of all unwanted emissions outside of the authorized frequency band.

10.4. Test result

Test Engineer:	Zoe	Test Site:	RF Measurement System 2#
Ambient Condition:	24.3°C,46.1%RH	Test Date:	2024.02.21
Test Power Supply:	Battery	EUT:	Safe Audio Headphone
Sample Number:	S24010331-011	Model No.:	Buzz junior

Mode	Freq. (MHz)	Verdict
GFSK	Hopping off 2402	Pass
	Hopping off 2480	Pass
	Hopping on	Pass
$\pi/4$ -DQPSK	Hopping off 2402	Pass
	Hopping off 2480	Pass
	Hopping on	Pass
8DPSK	Hopping off 2402	Pass
	Hopping off 2480	Pass
	Hopping on	Pass

10.5. Test graphs

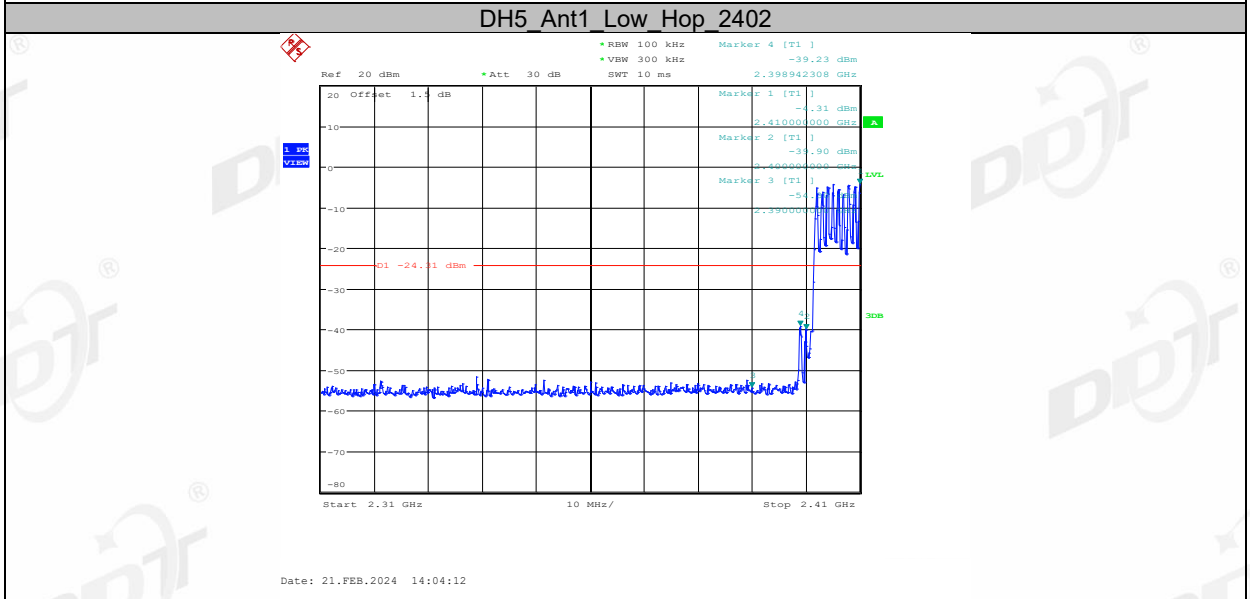
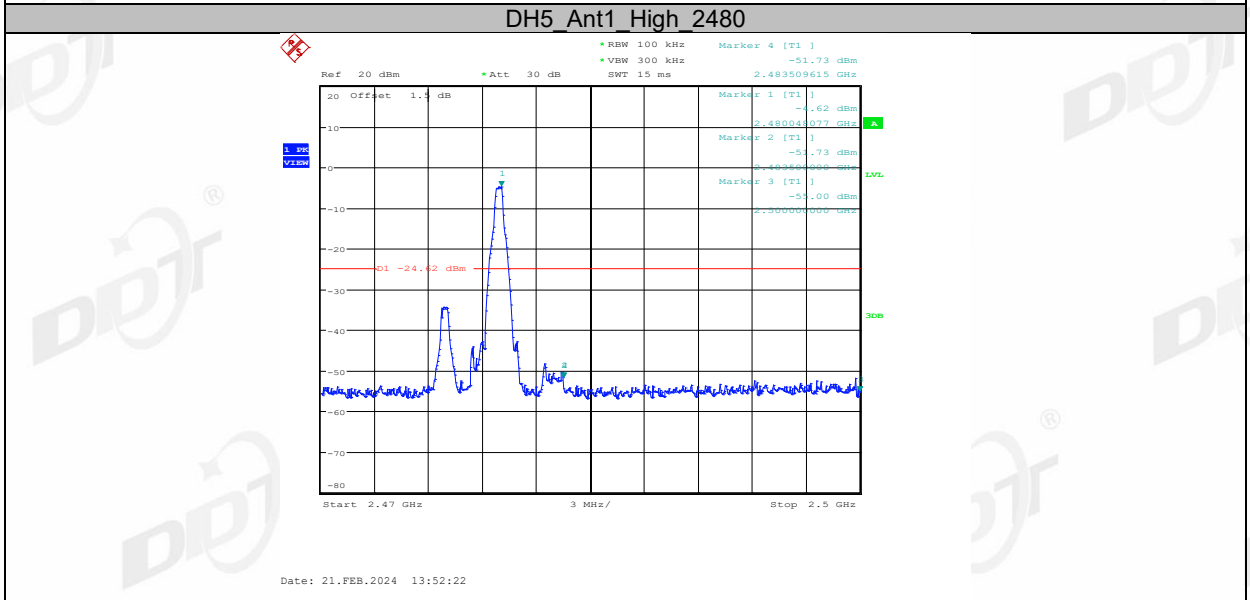
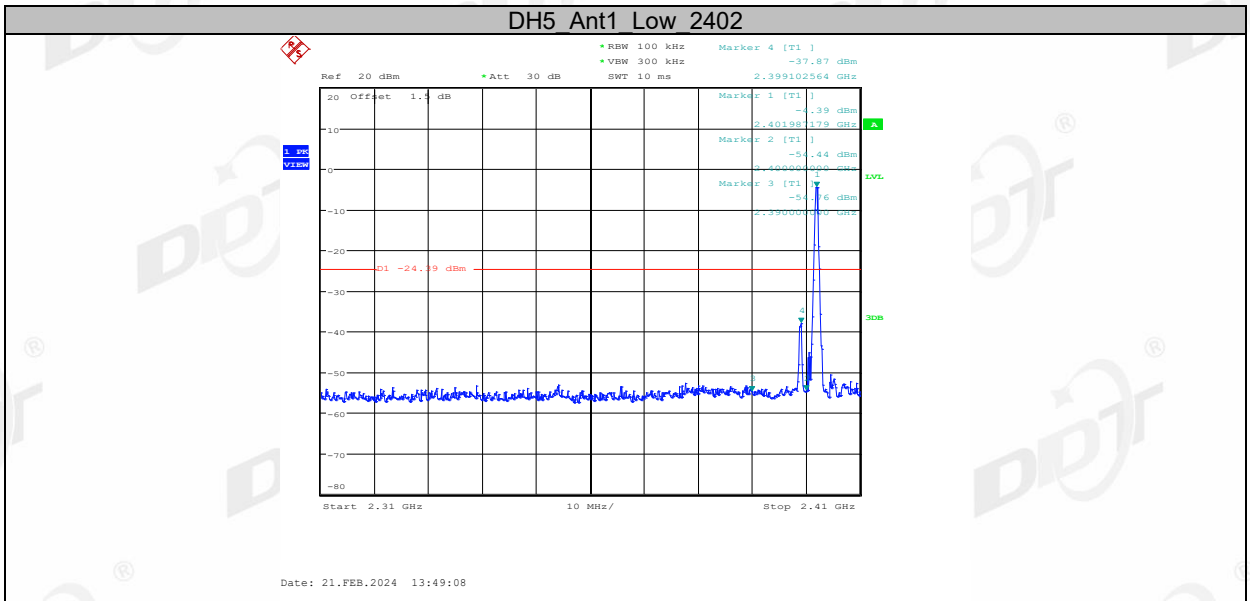

DH5 Ant1 High Hop 2480

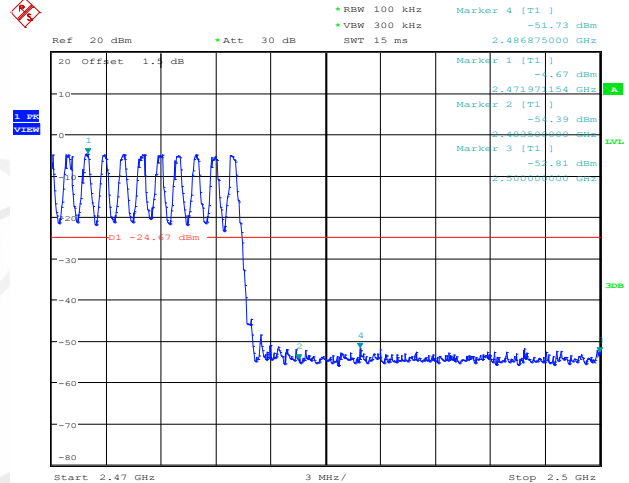

Date: 21.FEB.2024 14:05:38

2DH5 Ant1 Low 2402

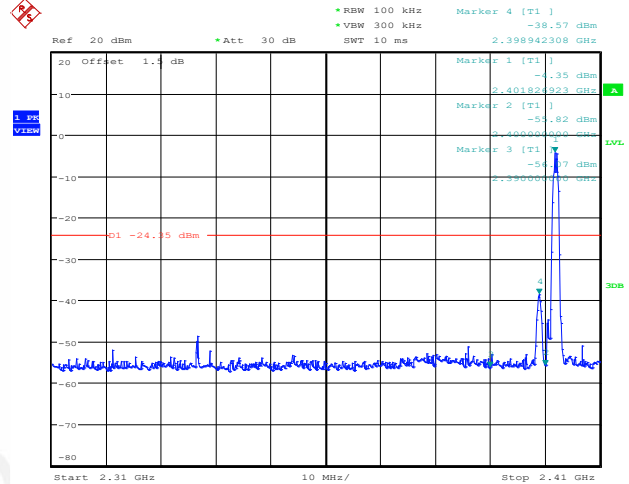

Date: 21.FEB.2024 13:53:51

2DH5 Ant1 High 2480

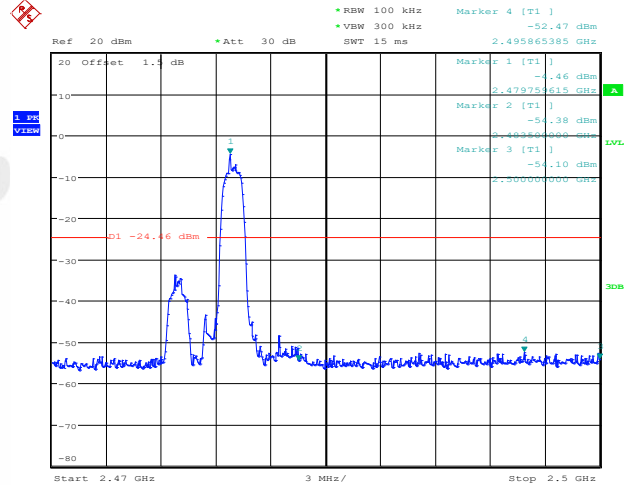

Date: 21.FEB.2024 13:56:32

2DH5 Ant1 Low Hop 2402

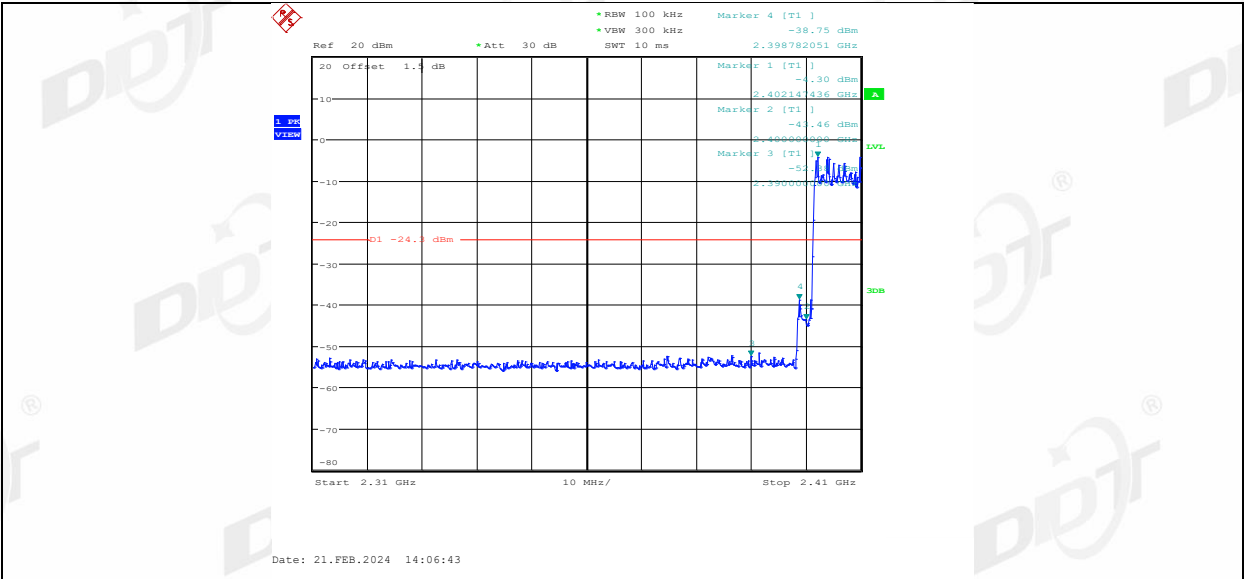

2DH5 Ant1 High Hop 2480

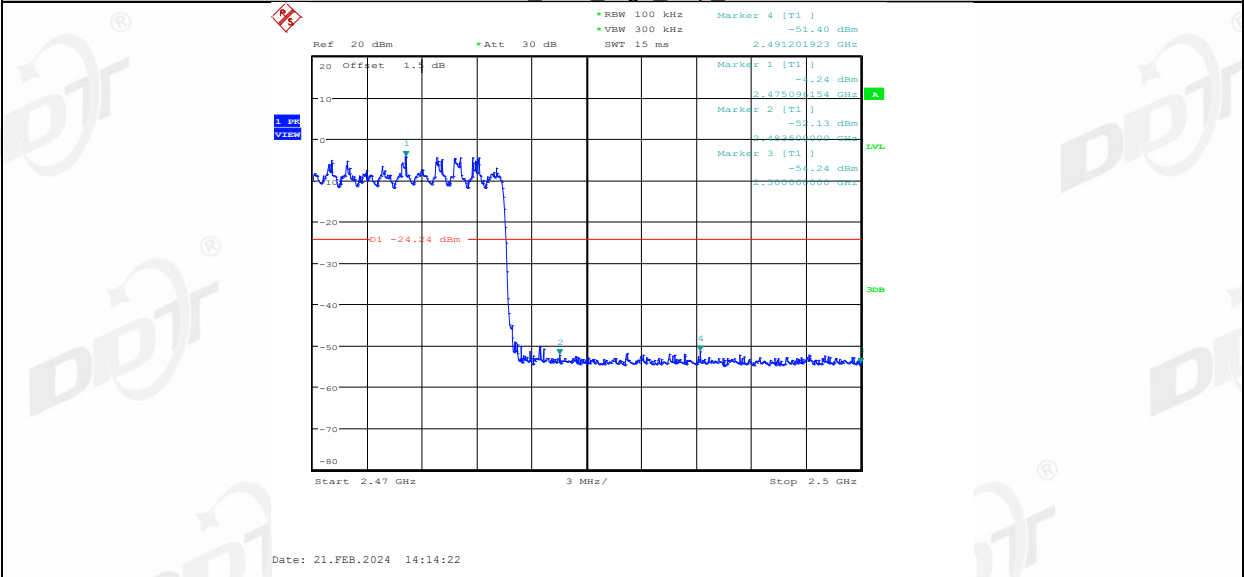

3DH5 Ant1 Low 2402

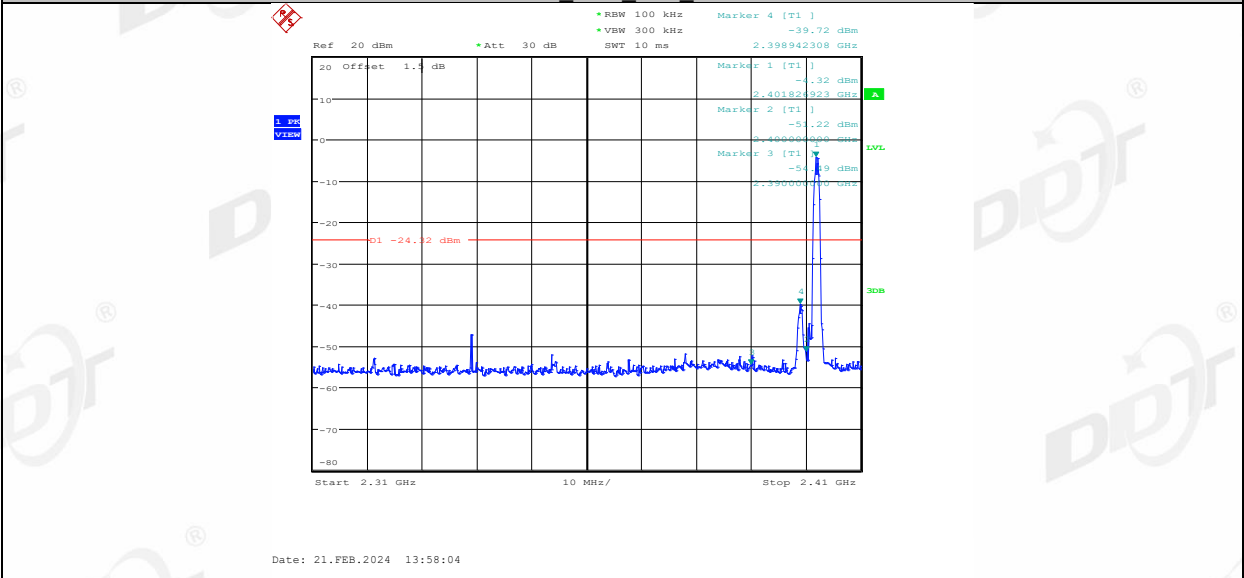

3DH5 Ant1 High 2480

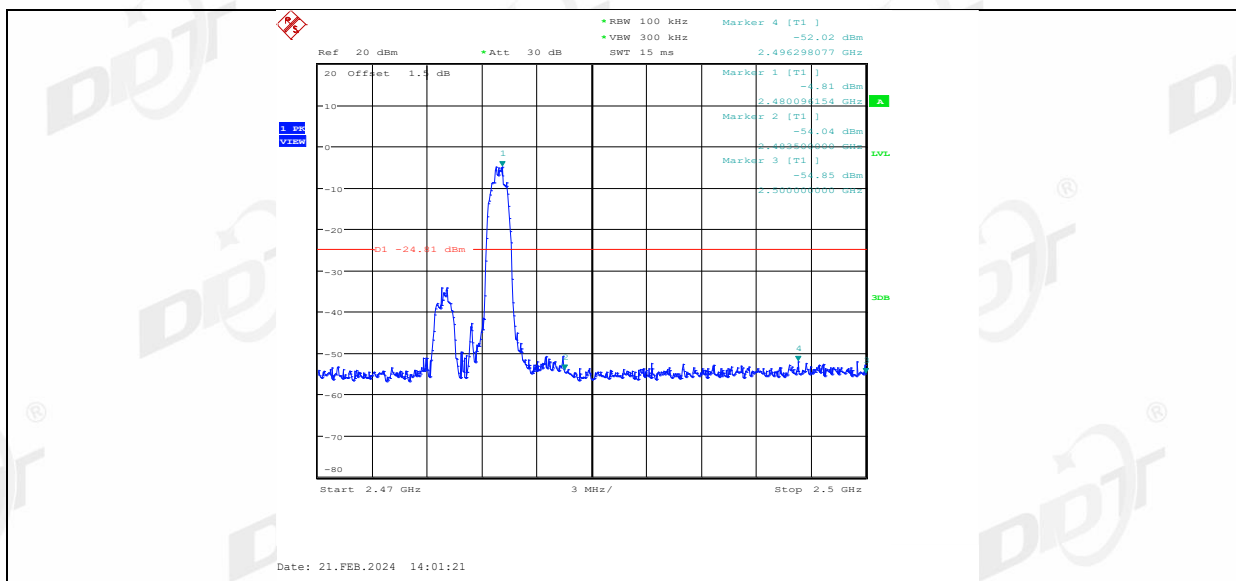

3DH5 Ant1 Low Hop 2402

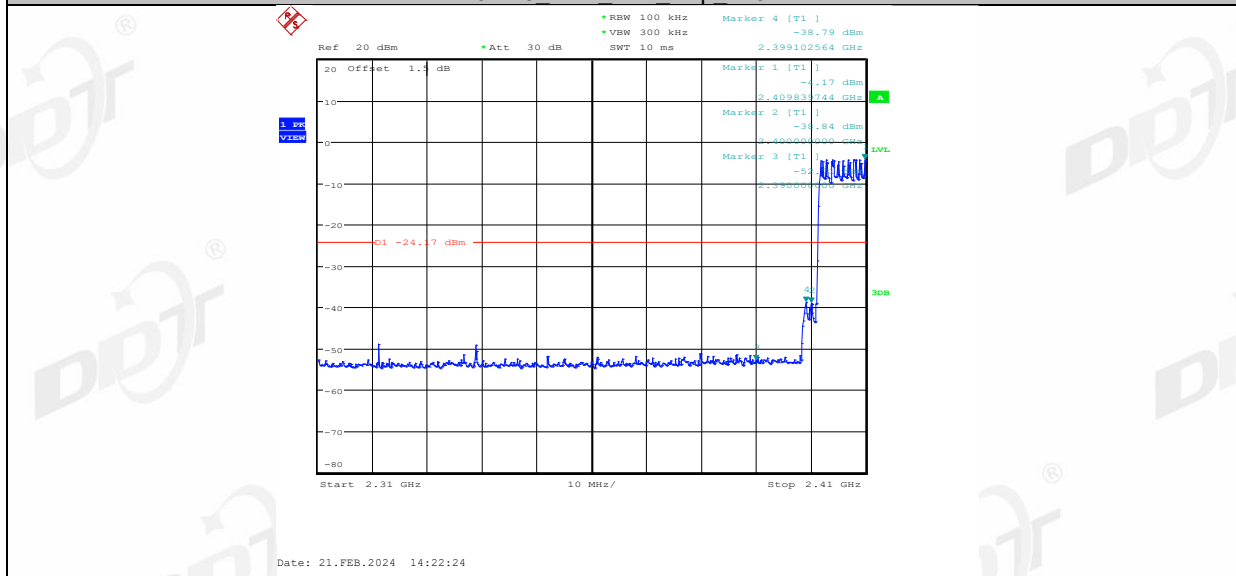

3DH5 Ant1 High Hop 2480

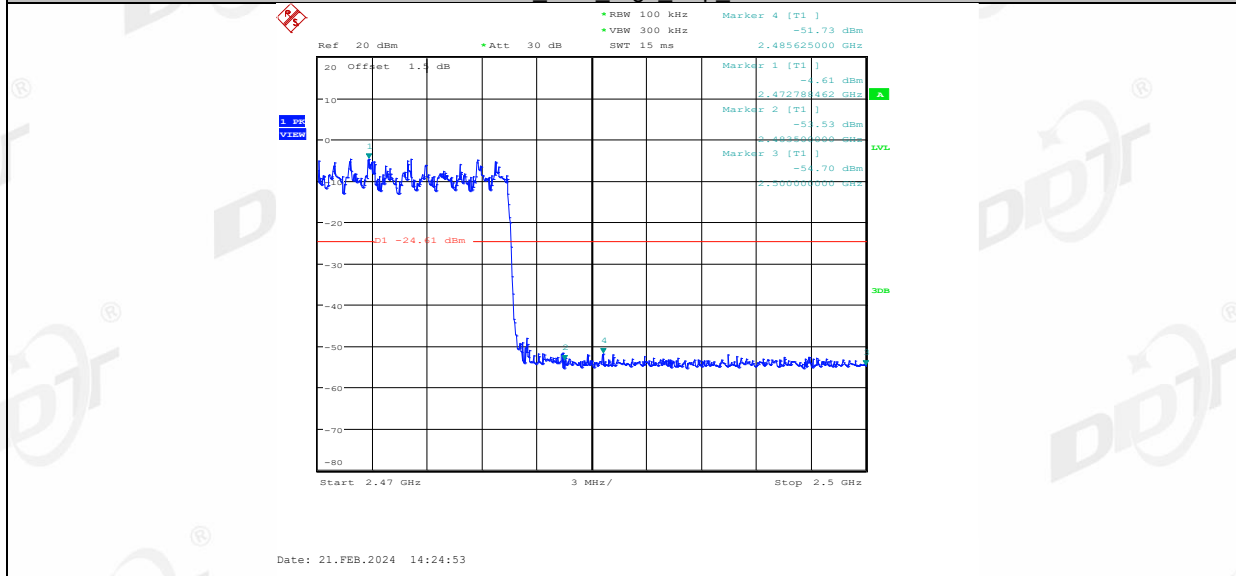

11. RF Conducted Spurious Emissions

11.1. Block diagram of test setup

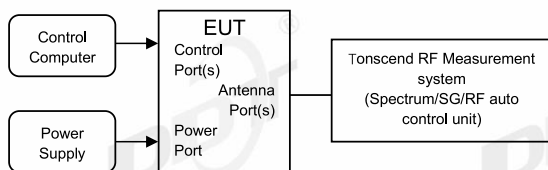

11.2. Limits

In any 100 kHz bandwidth outside the frequency bands in which the spread spectrum intentional radiator is operating, the radio frequency power that is produced by the intentional radiator shall be at least 20 dB below that in the 100 kHz bandwidth within the band that contains the highest level of the desired power.

11.3. Test procedure

- (1) Connect EUT's antenna output to spectrum analyzer by RF cable.
- (2) Establish a reference level by using the following procedure:

Center frequency	Test frequency
RBW:	100 kHz
VBW:	300 kHz
Span	Wide enough to capture the peak level of the in-band emission
Detector Mode:	Peak
Sweep time:	Auto
Trace mode	Max hold
- (3) Allow the trace to stabilize, use the peak marker function to determine the maximum peak power level to establish the reference level.
- (4) Set the spectrum analyzer as follows:

RBW:	100 kHz
VBW:	300 kHz
Span	Encompass frequency range to be measured
Number of measurement points	$\geq \text{Span}/\text{RBW}$
Detector Mode:	Peak
Sweep time:	Auto
Trace mode	Max hold

Allow the trace to stabilize, use the peak marker function to determine the maximum amplitude of all unwanted emissions outside of the authorized frequency band

11.4. Test result

Test Engineer:	Zoe	Test Site:	RF Measurement System 2#
Ambient Condition:	24.3°C,46.1%RH	Test Date:	2024.02.21
Test Power Supply:	Battery	EUT:	Safe Audio Headphone
Sample Number:	S24010331-011	Model No.:	Buzz junior

Mode	Freq. (MHz)	Verdict
GFSK	Hopping off 2402	Pass
	Hopping off 2441	Pass
	Hopping off 2480	Pass
$\pi/4$ -DQPSK	Hopping off 2402	Pass
	Hopping off 2441	Pass
	Hopping off 2480	Pass
8DPSK	Hopping off 2402	Pass
	Hopping off 2441	Pass
	Hopping off 2480	Pass

11.5. Test graphs

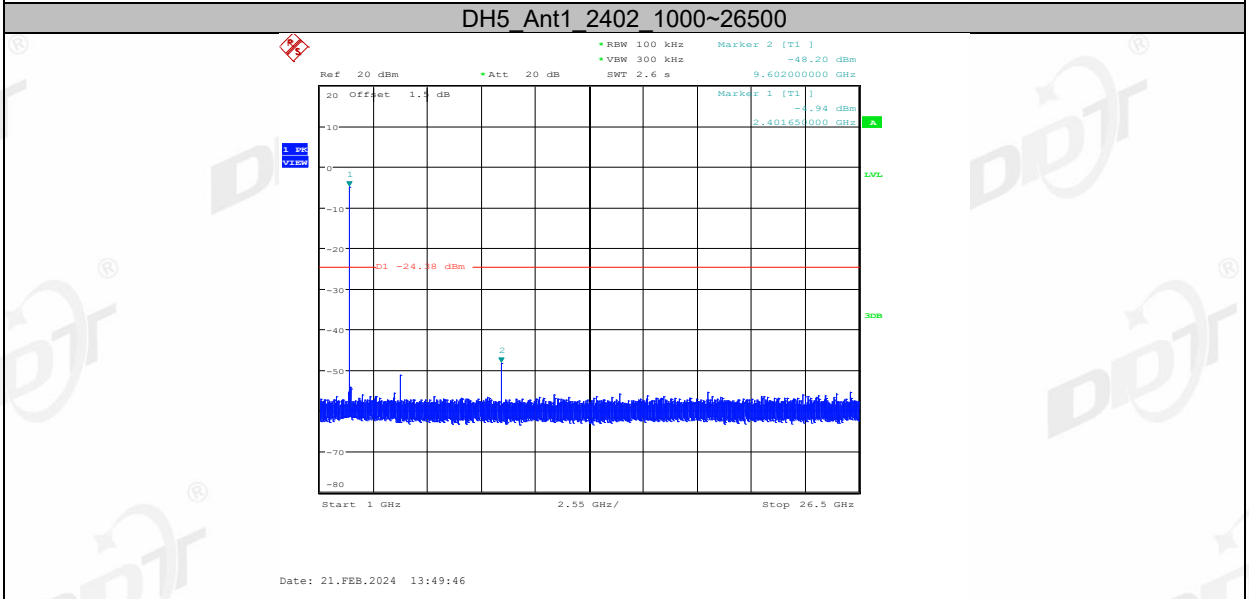
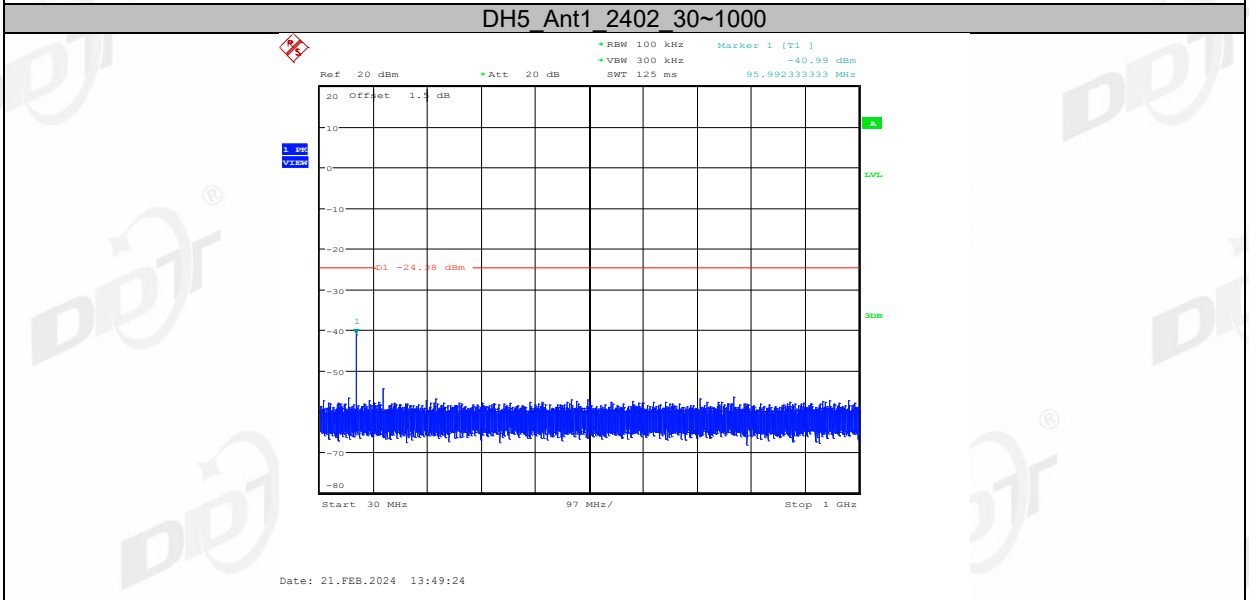
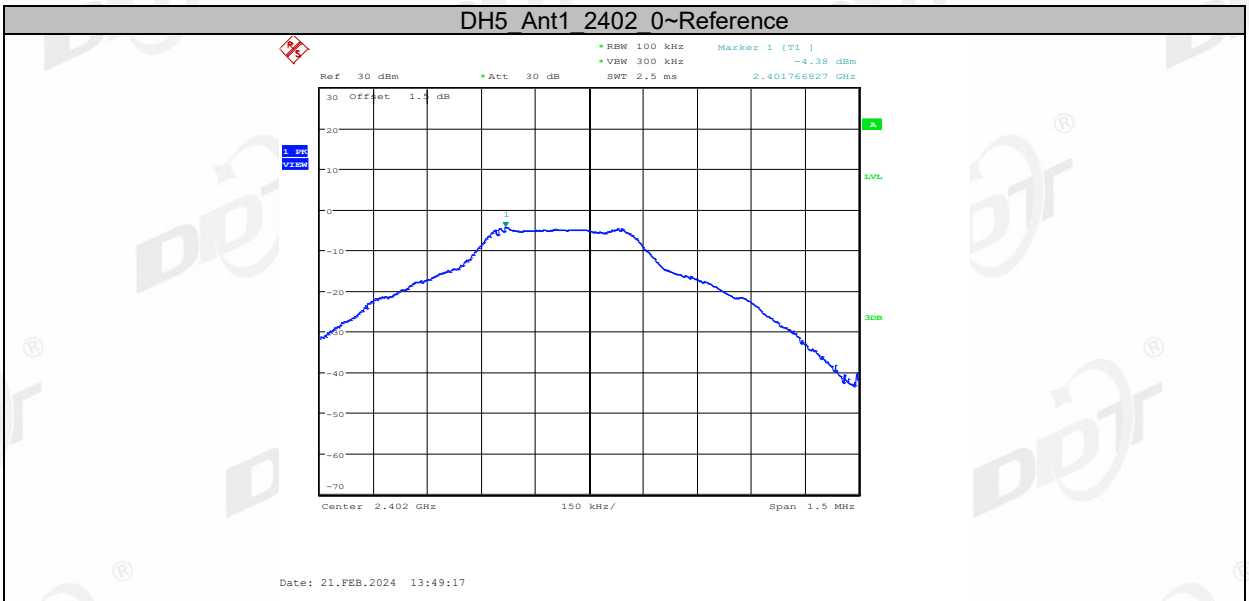

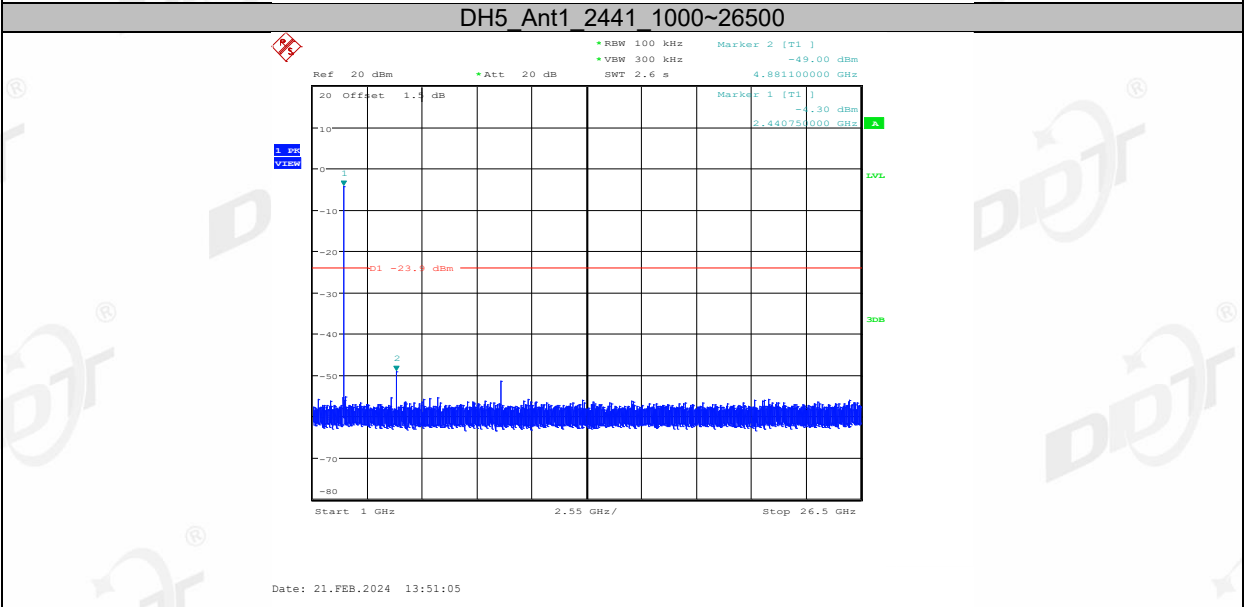
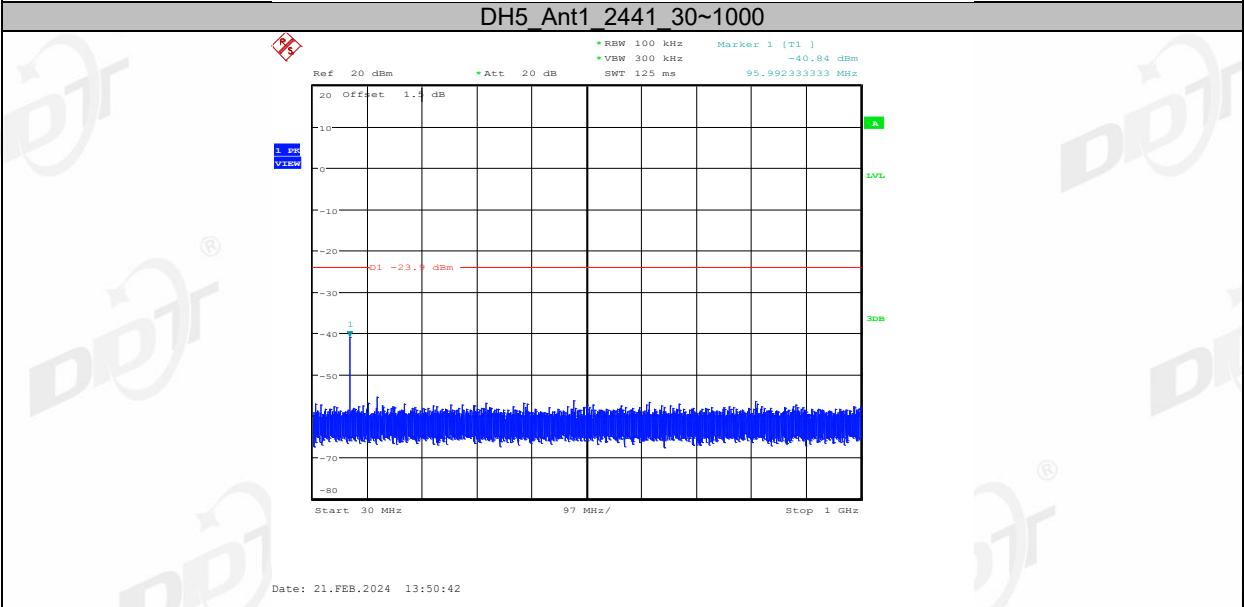
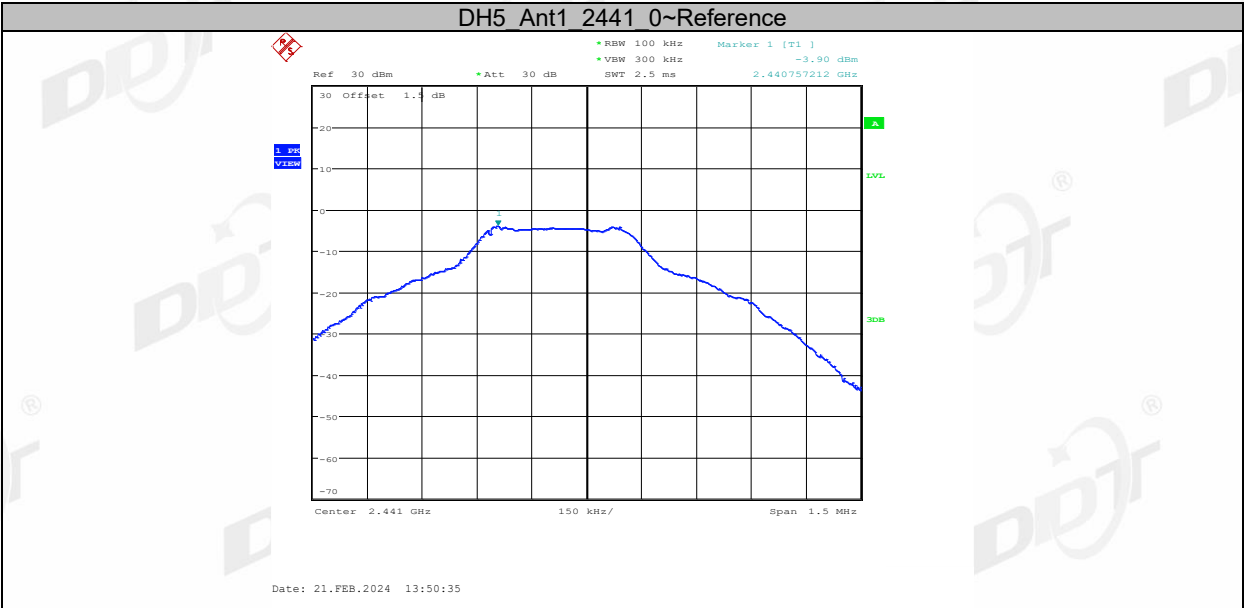

DH5_Ant1_2480_0~Reference

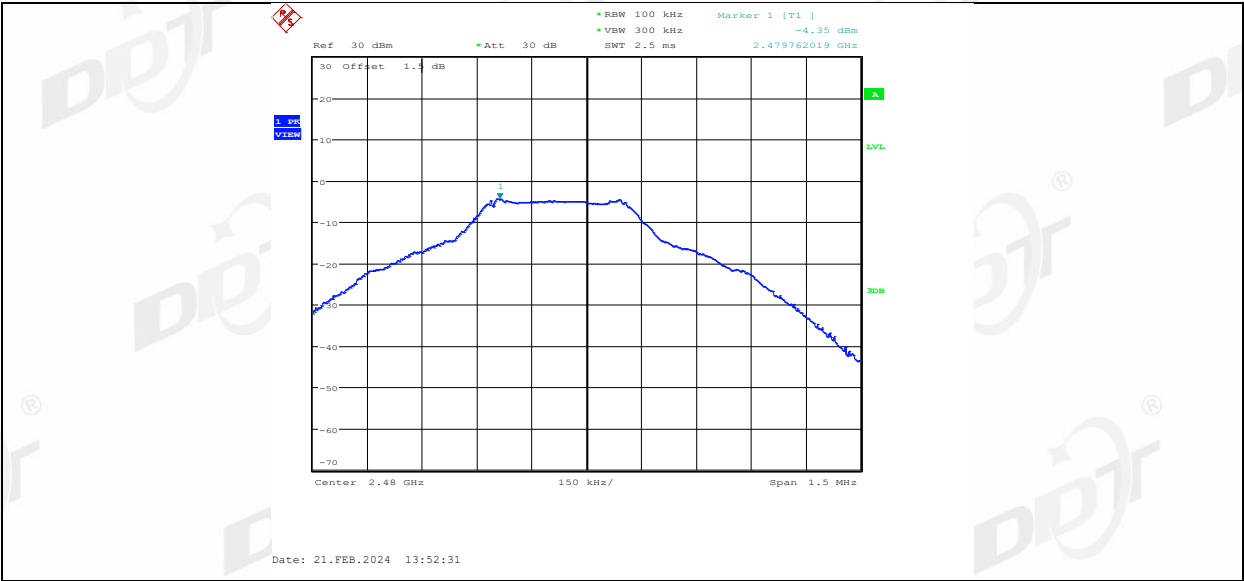

DH5 Ant1 2480 30~1000

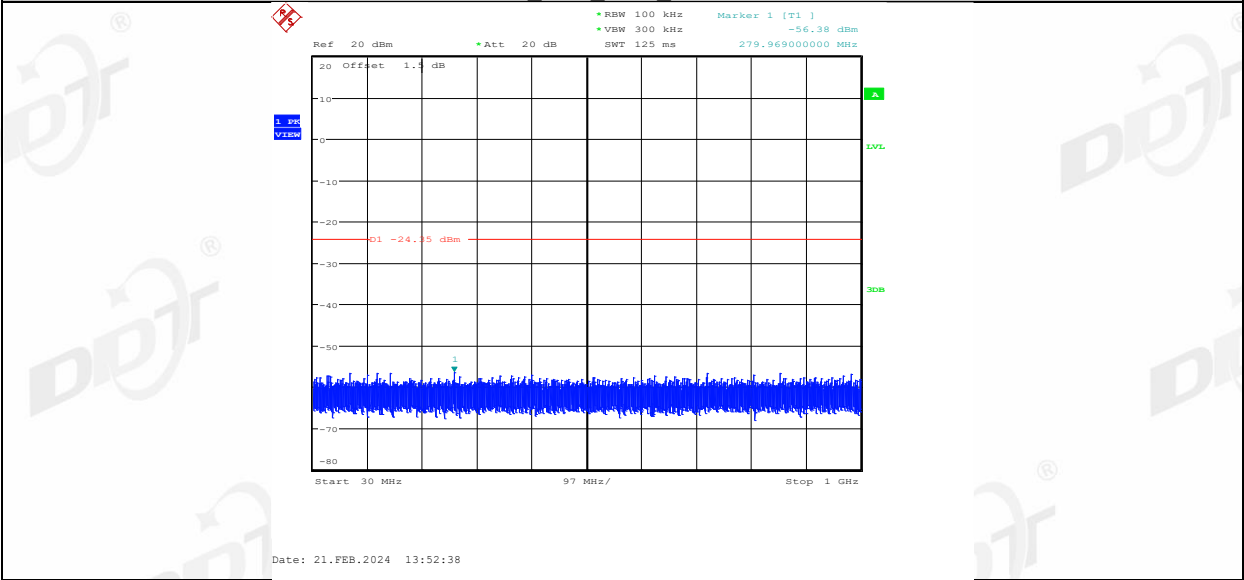

DH5 Ant1 2480 1000~26500

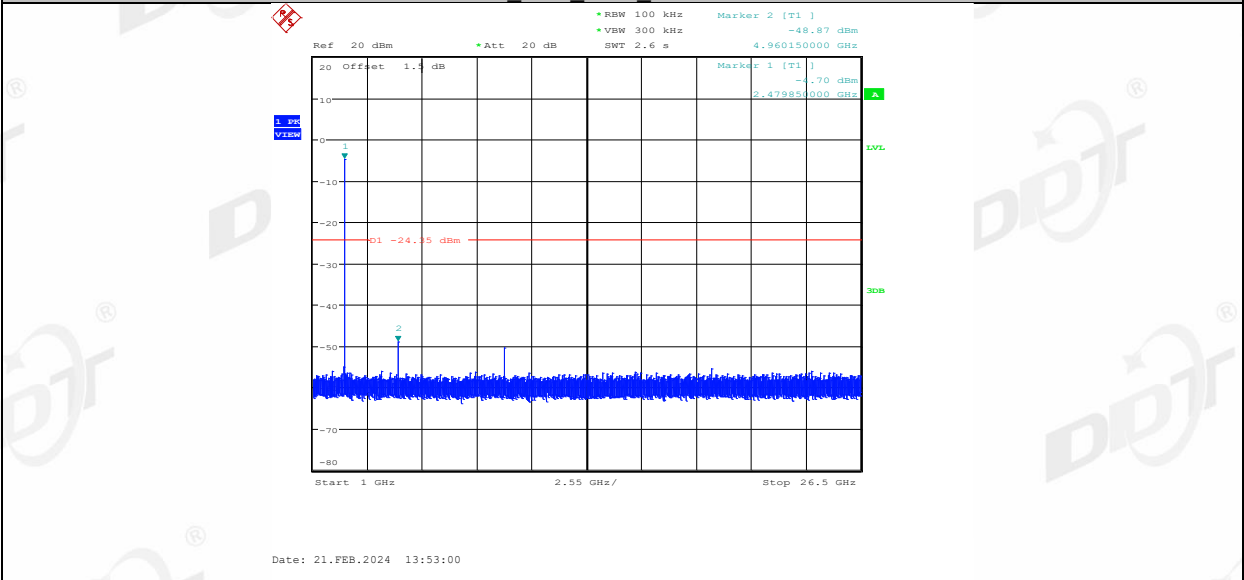

2DH5 Ant1 2402 0~Reference



2DH5 Ant1 2402 30~1000

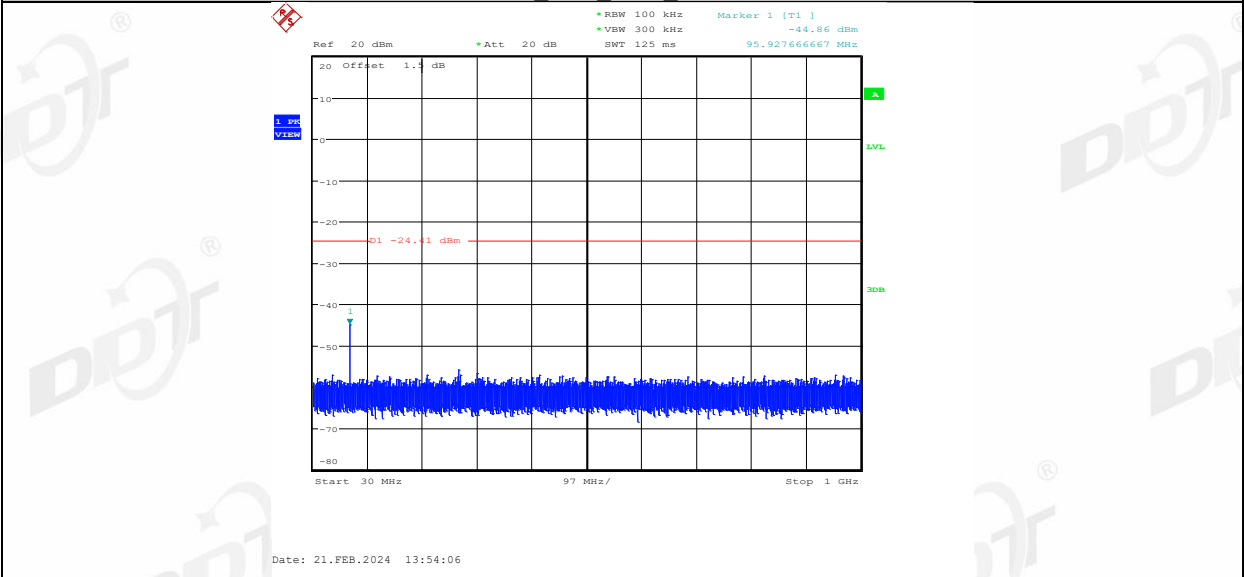

2DH5 Ant1 2402 1000~26500

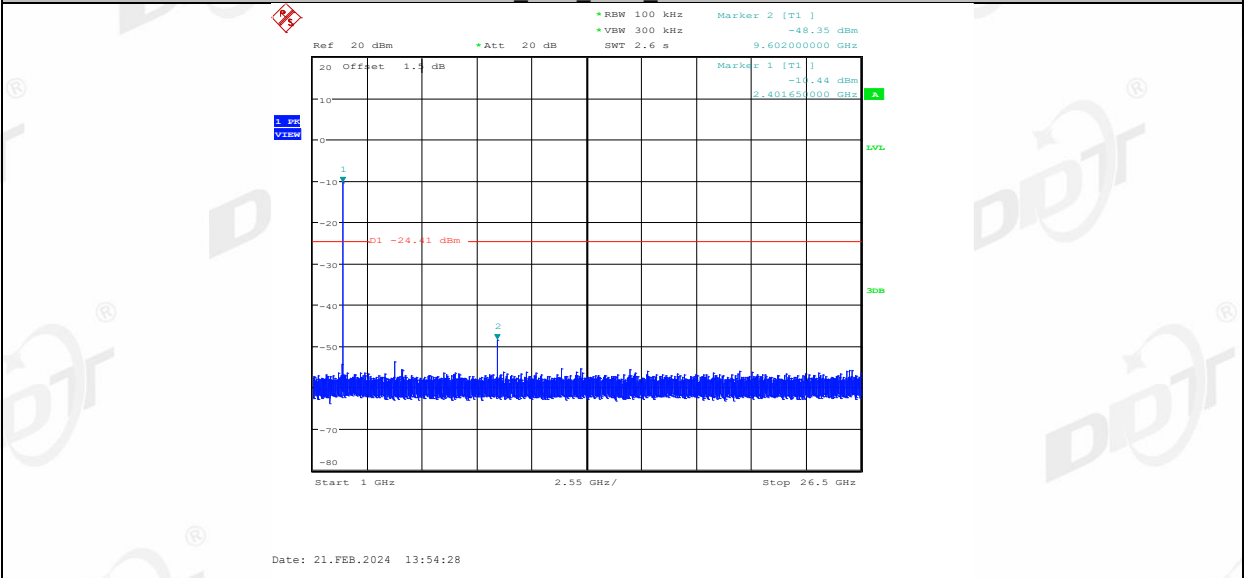

2DH5 Ant1 2441 0~Reference



2DH5 Ant1 2441 30~1000

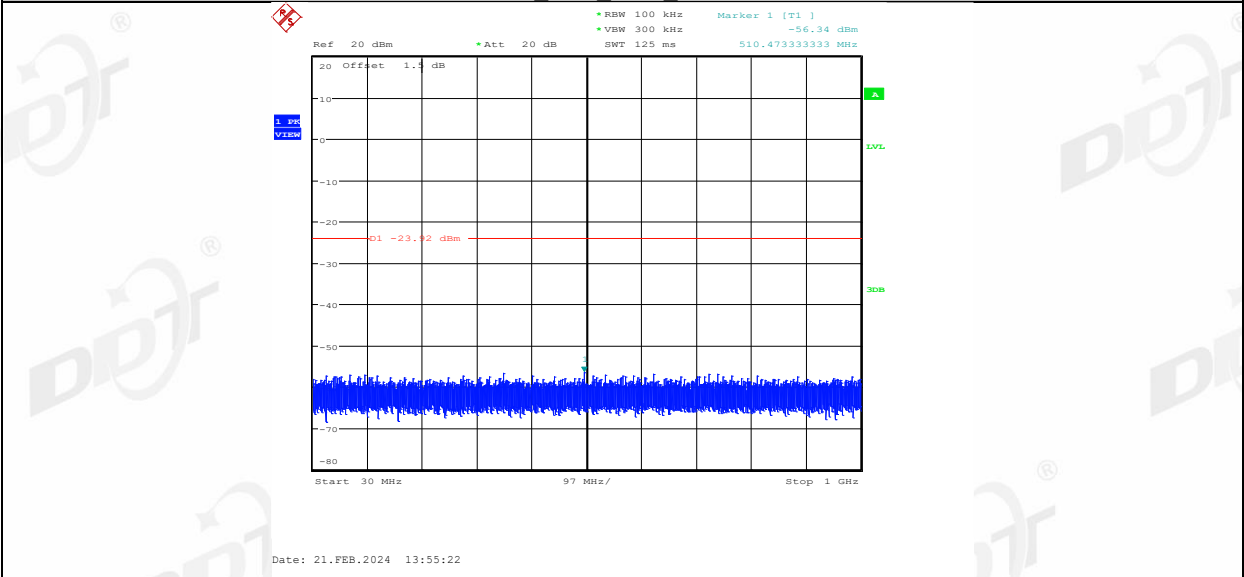

2DH5 Ant1 2441 1000~26500

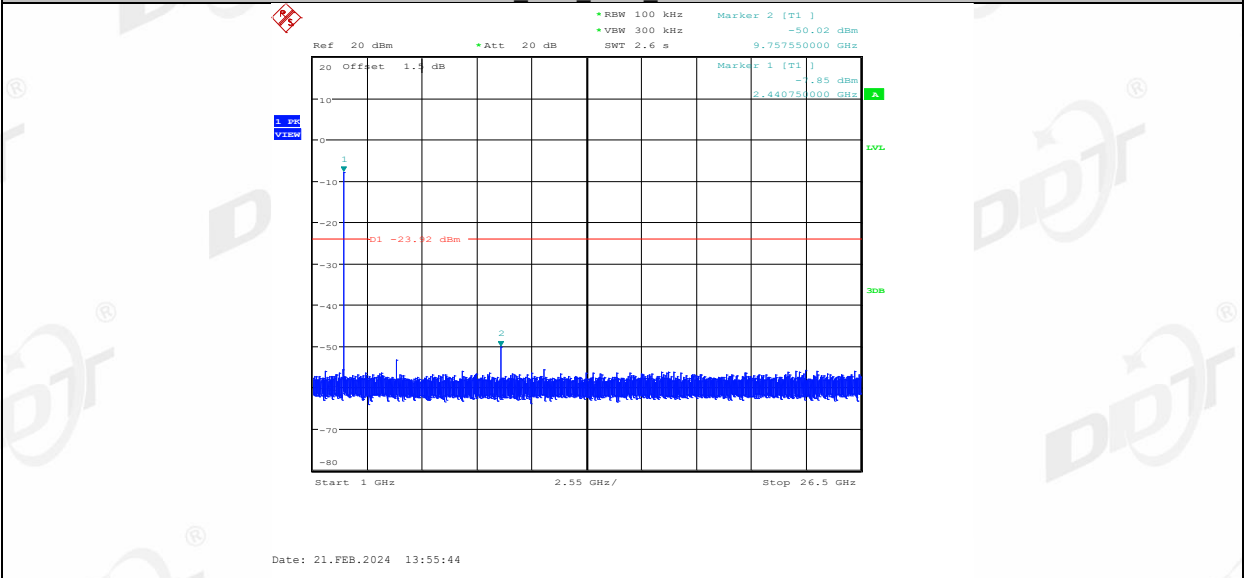

2DH5 Ant1 2480 0~Reference

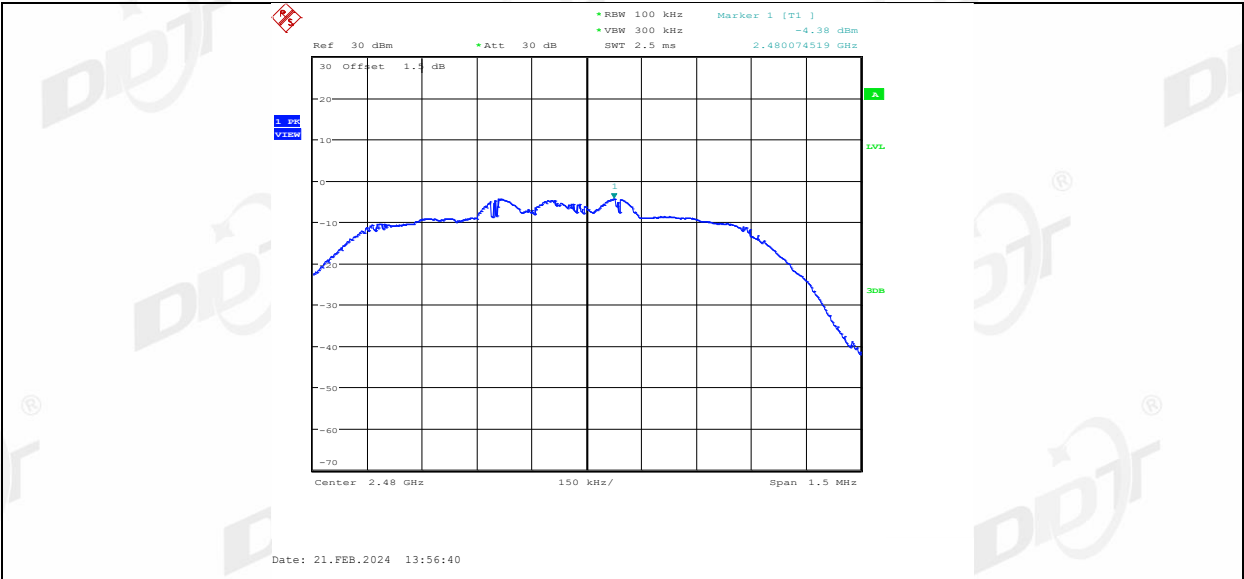

2DH5 Ant1 2480 30~1000

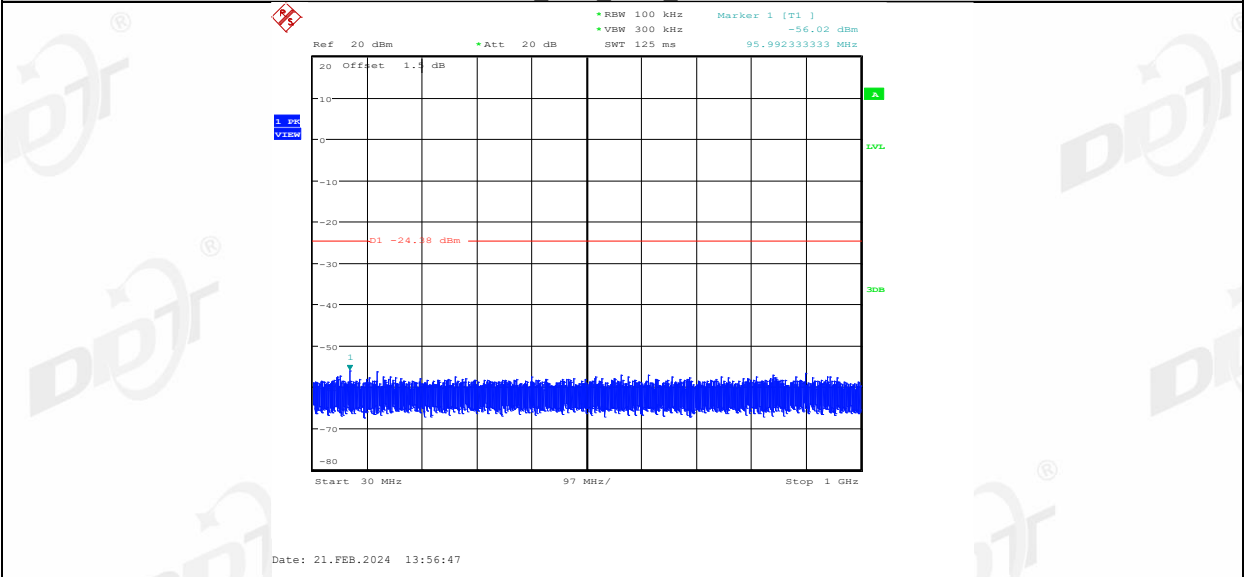

2DH5 Ant1 2480 1000~26500

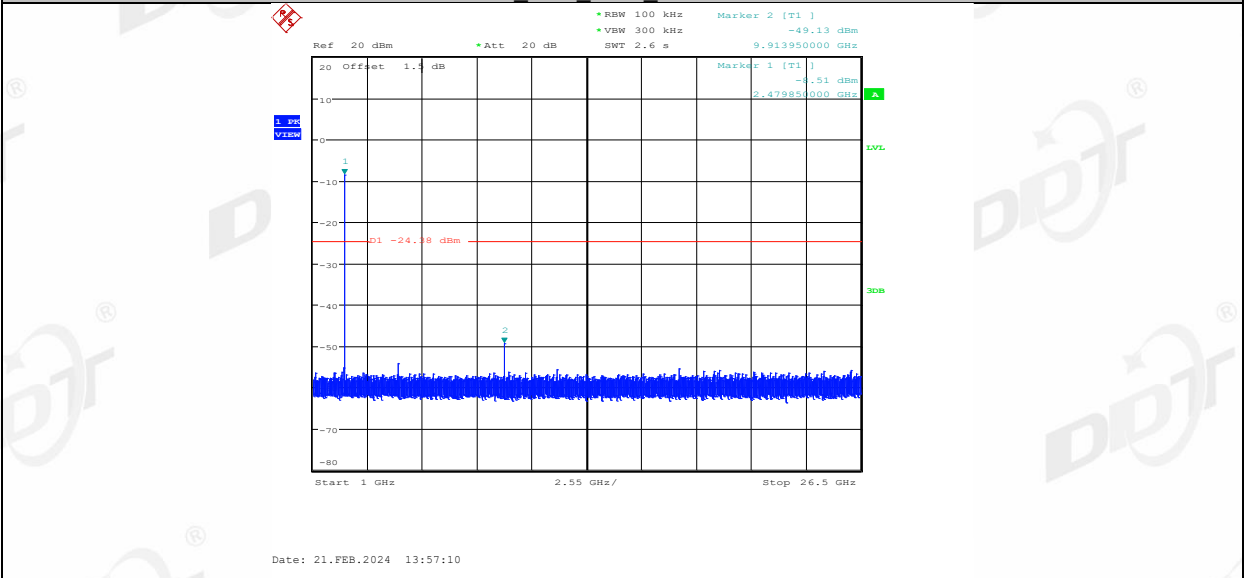

3DH5 Ant1 2402 0~Reference

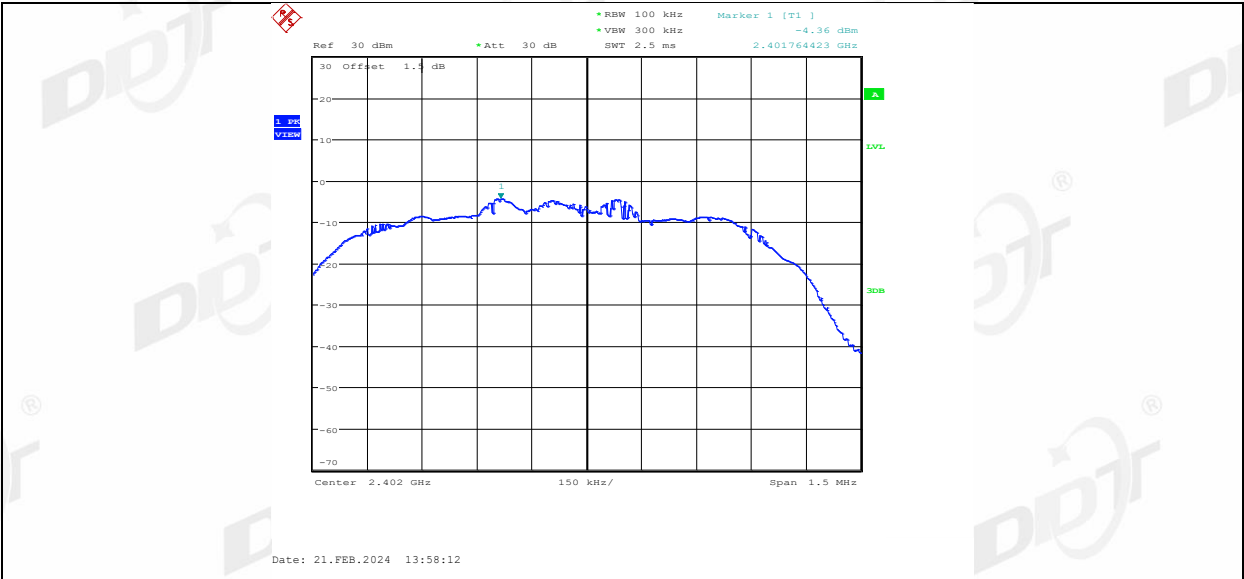

3DH5 Ant1 2402 30~1000

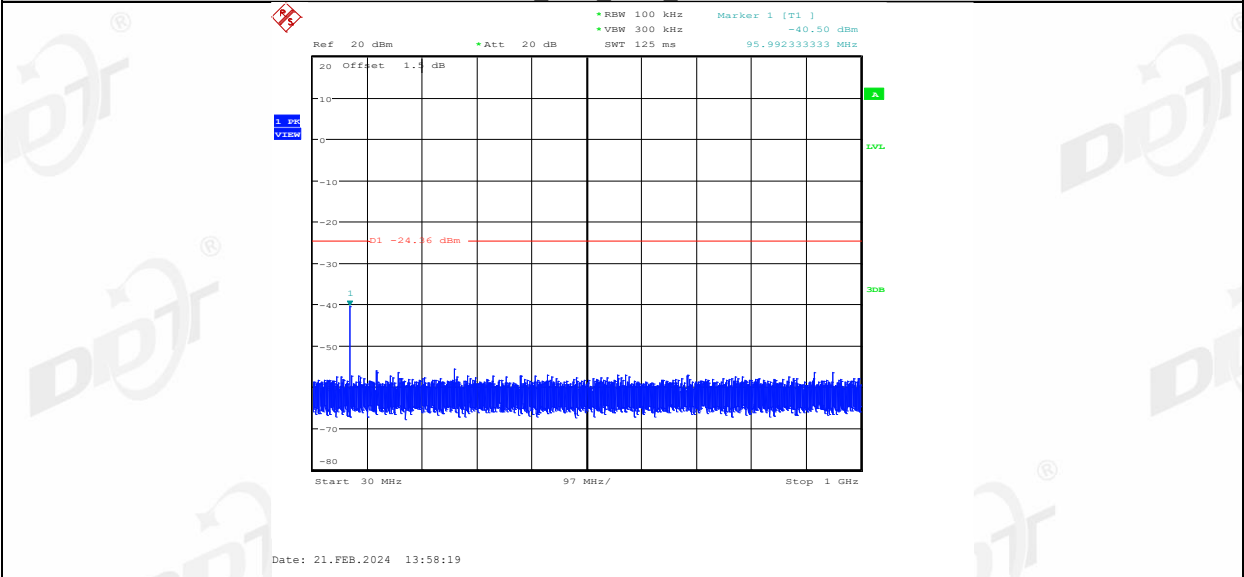

3DH5 Ant1 2402 1000~26500

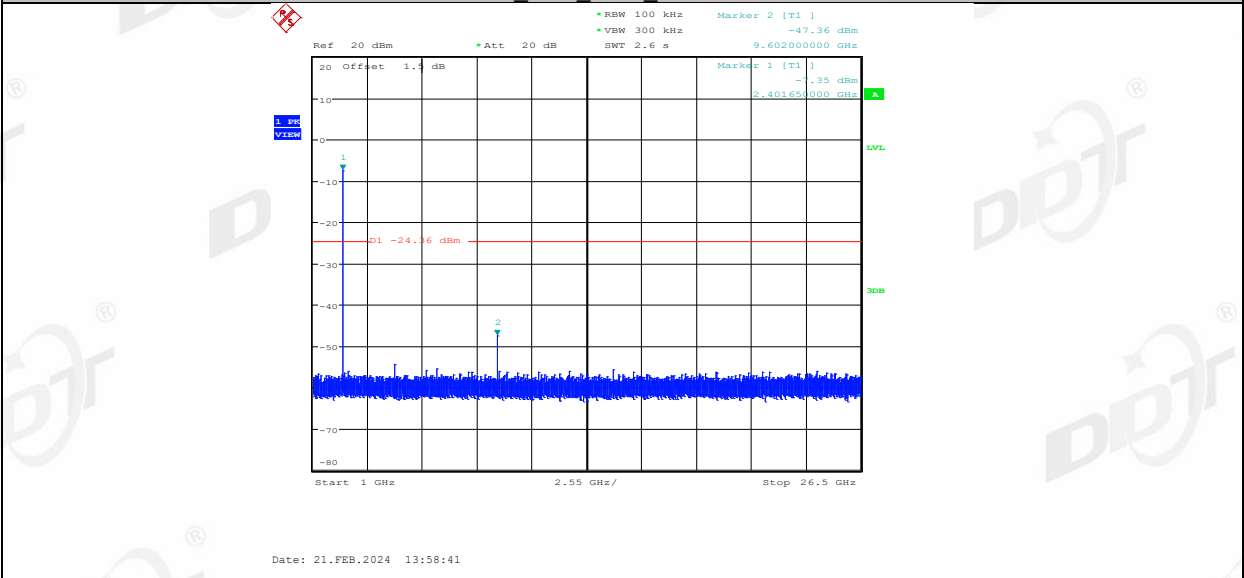

3DH5 Ant1 2441 0~Reference



3DH5 Ant1 2441 30~1000

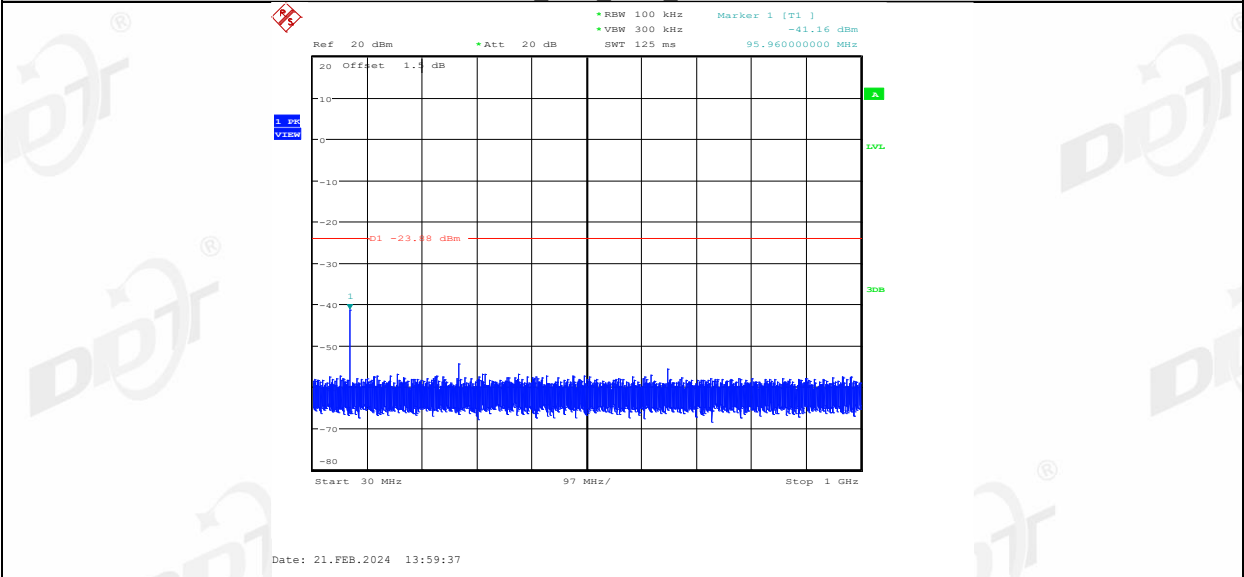

3DH5 Ant1 2441 1000~26500

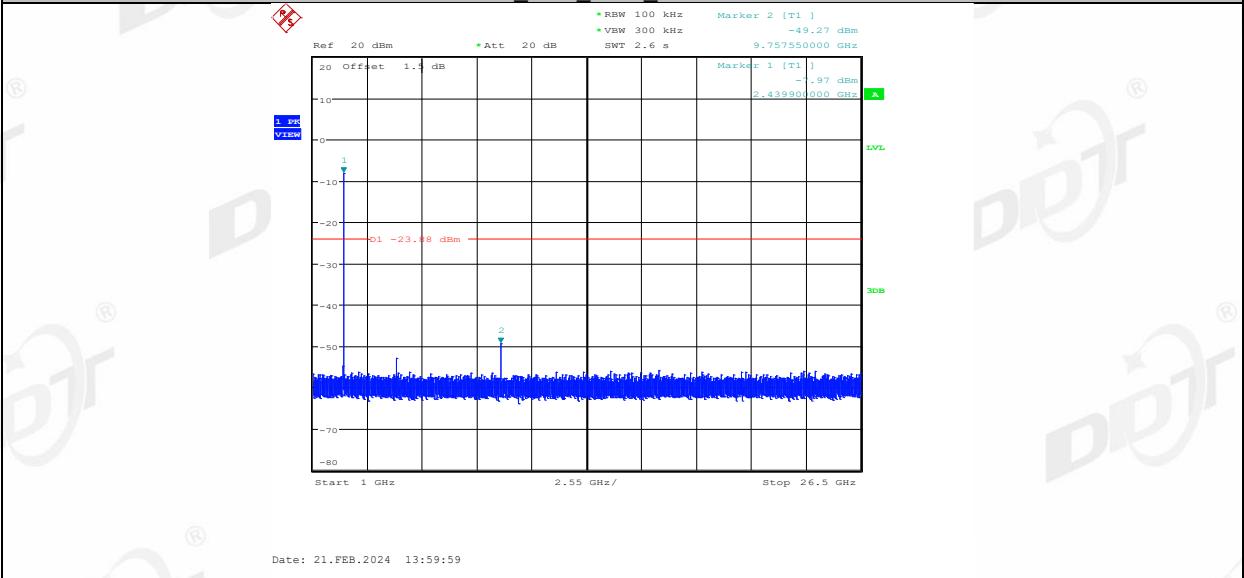

3DH5 Ant1 2480 0~Reference

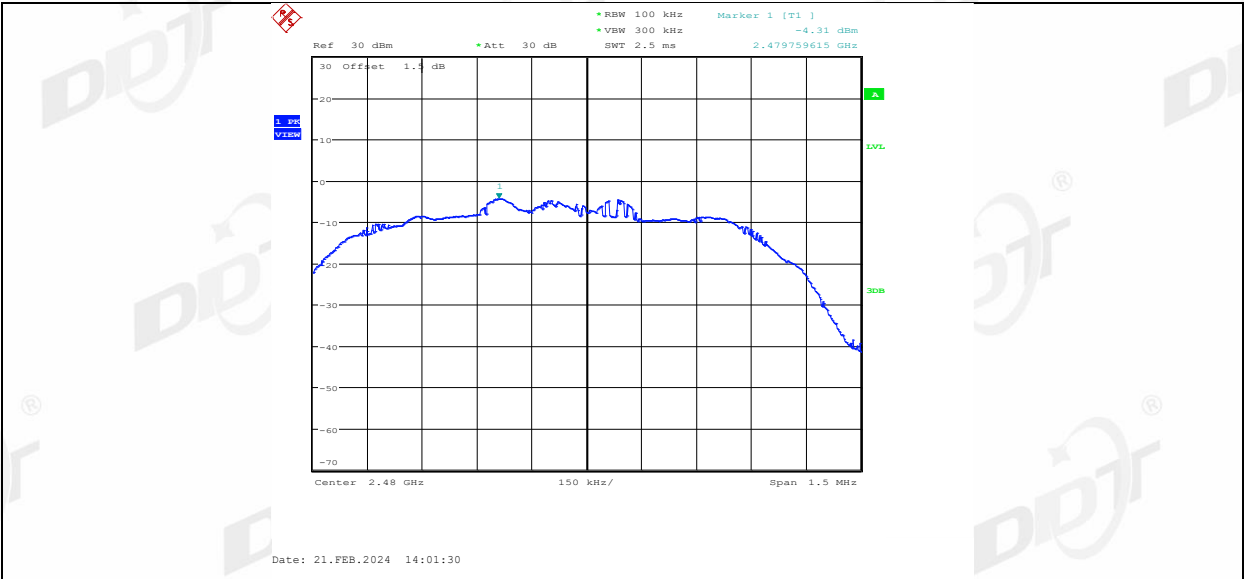

3DH5 Ant1 2480 30~1000

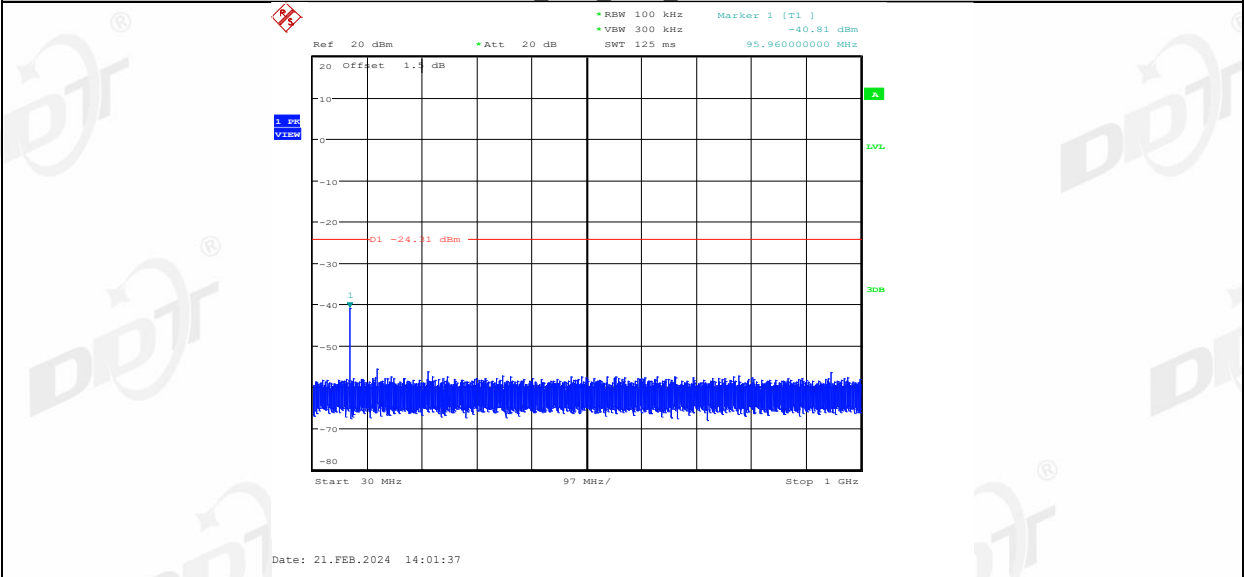

3DH5 Ant1 2480 1000~26500

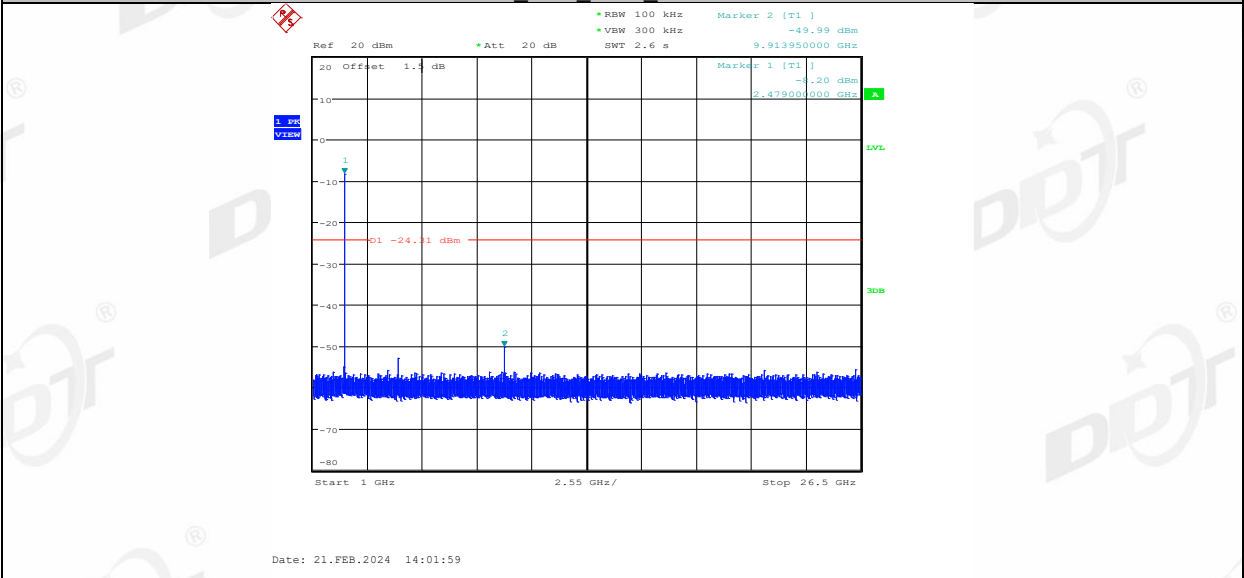

12. Duty cycle

12.1. Block diagram of test setup

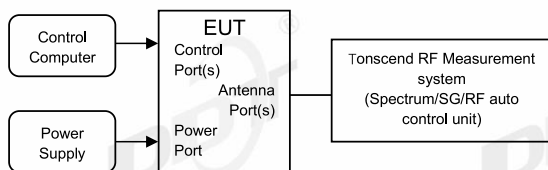

12.2. Limit

Just for Report.

12.3. Test procedure

(1) Connected the EUT's antenna port to the Spectrum Analyzer by suitable attenuator, The cable loss and attenuator loss have been put into spectrum analyzer as amplitude offset.

set the Spectrum Analyzer as below:

Centre Frequency: The centre frequency of the middle hopping channel.

Resolution BW: 10 MHz.

Video BW: 10 MHz.

Span: Zero span.

Detector: Peak.

Trace Mode: Clear Write.

Sweep: Video Trigger

(2) When the trace is complete, measure the sending time of 1 burst and the duty cycle of 1 burst cycle.

(3) Calculate dwell time follow below formula:

Duty cycle= Pulse's on time / Burst cycle

12.4. Test result

Test Engineer:	Zoe	Test Site:	RF Measurement System 2#
Ambient Condition:	24.3°C,46.1%RH	Test Date:	2024.02.21
Test Power Supply:	Battery	EUT:	Safe Audio Headphone
Sample Number:	S24010331-011	Model No.:	Buzz junior

Test Mode	Antenna	Frequency [MHz]	ON Time [ms]	Period [ms]	Duty Cycle [%]	Duty Cycle Factor[dB]
DH5	Ant1	2402	2.89	3.76	76.86	1.14
		2441	2.89	3.77	76.66	1.15
		2480	2.89	3.76	76.86	1.14
2DH5	Ant1	2402	2.89	3.76	76.86	1.14
		2441	2.89	3.76	76.86	1.14
		2480	2.89	3.76	76.86	1.14
3DH5	Ant1	2402	2.90	3.76	77.13	1.13
		2441	2.90	3.76	77.13	1.13
		2480	2.90	3.76	77.13	1.13

12.5. Test graphs

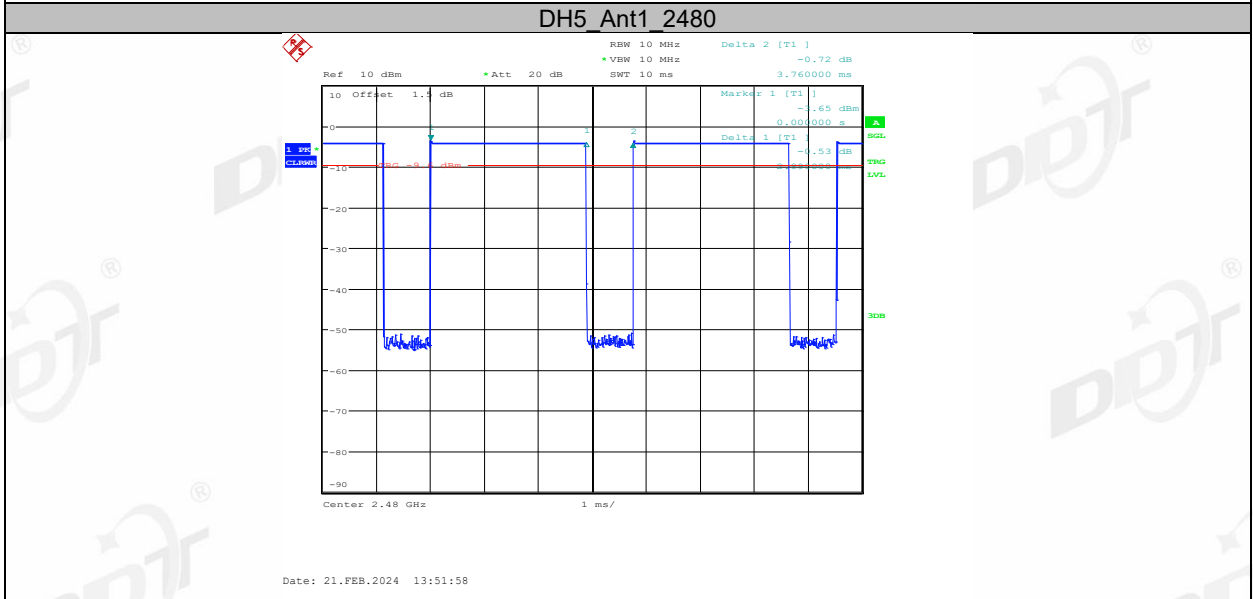
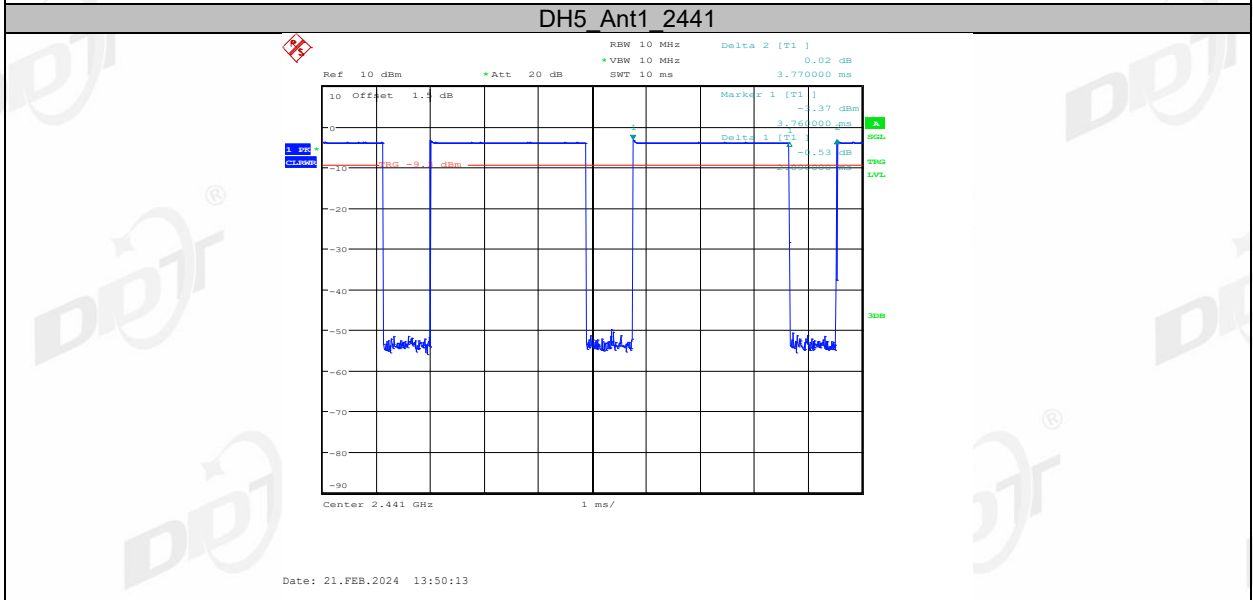
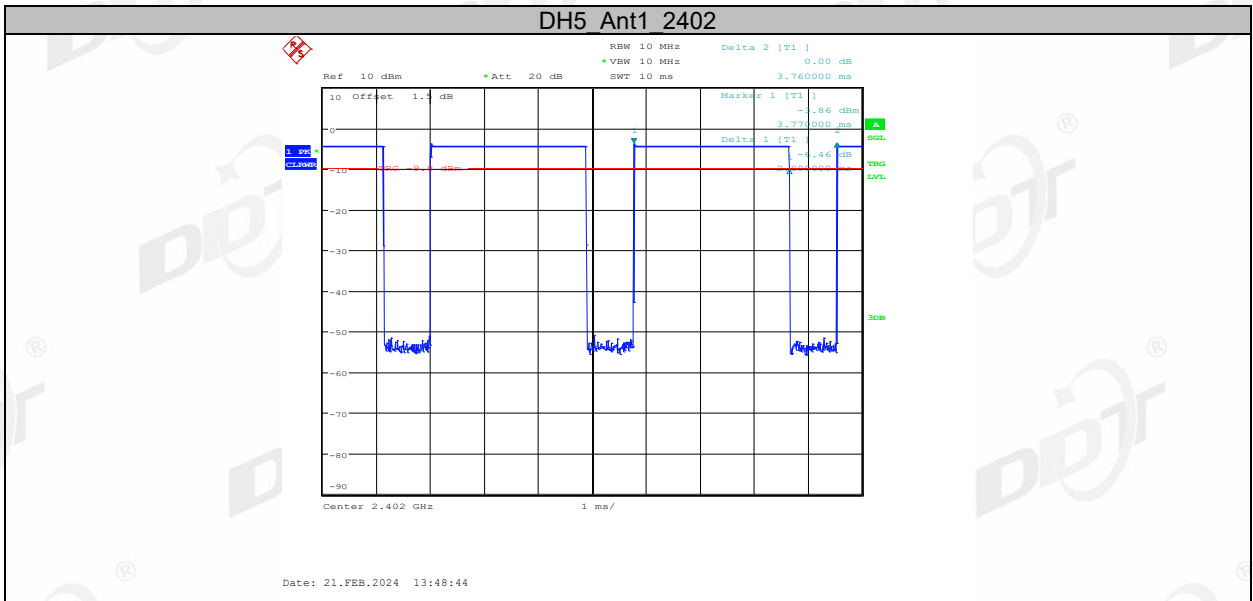

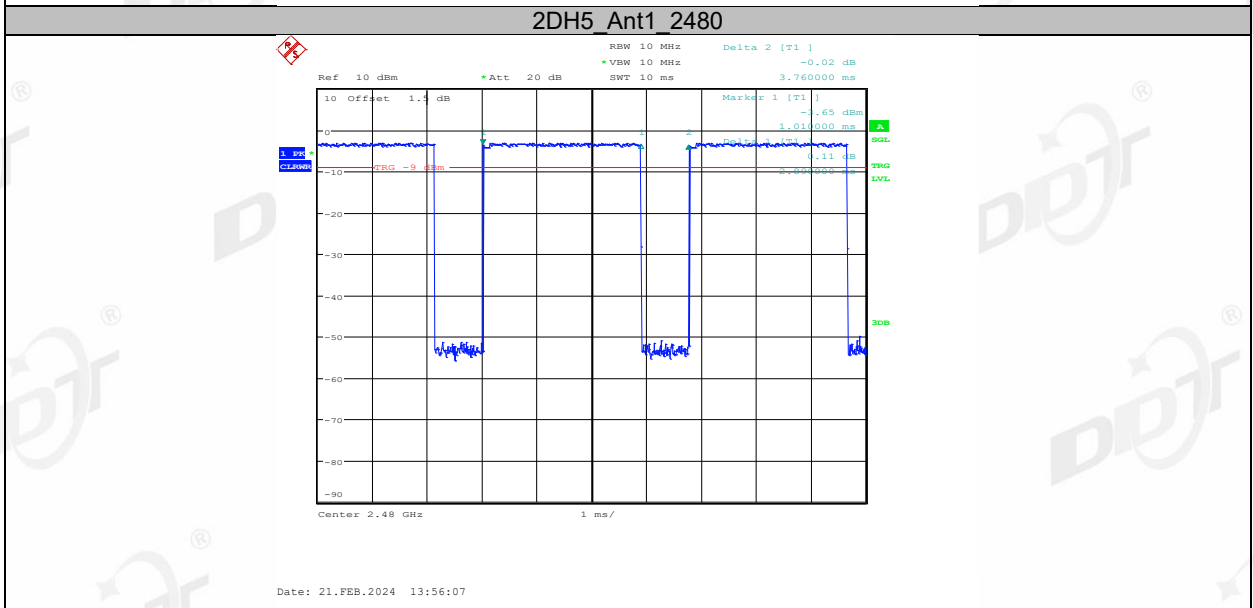
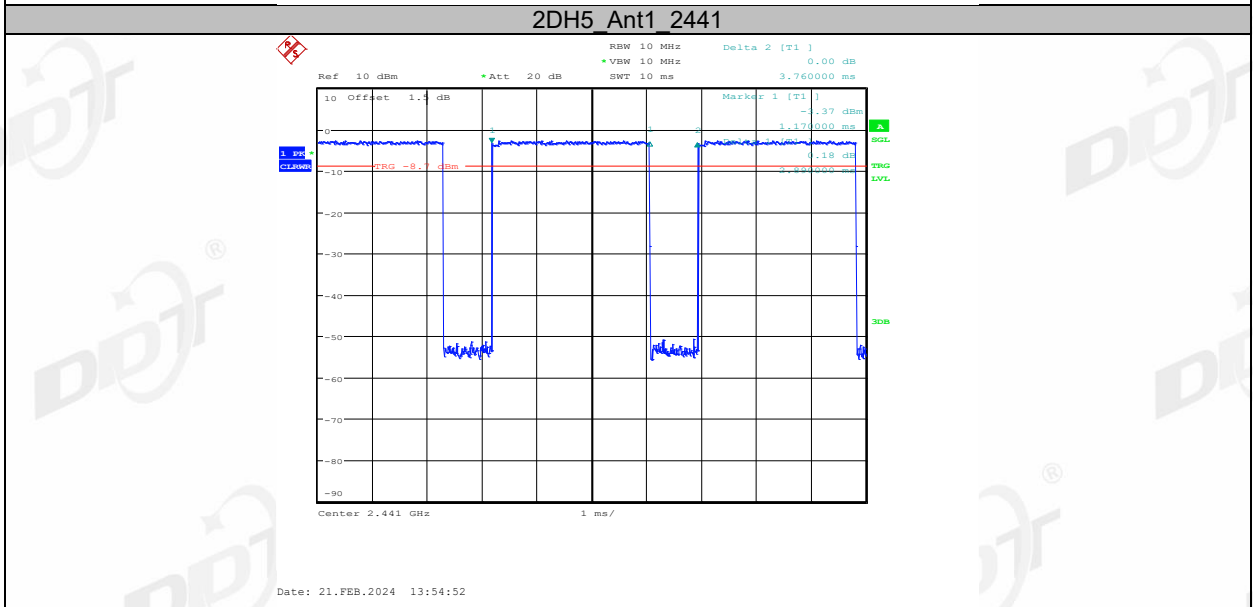
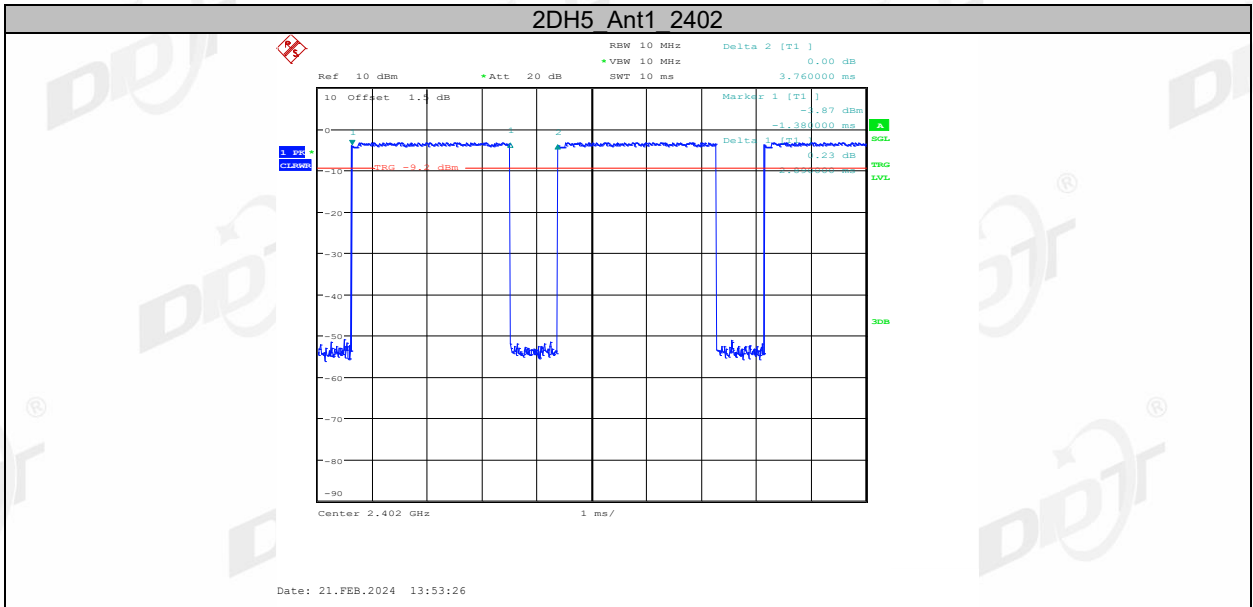

3DH5_Ant1_2402

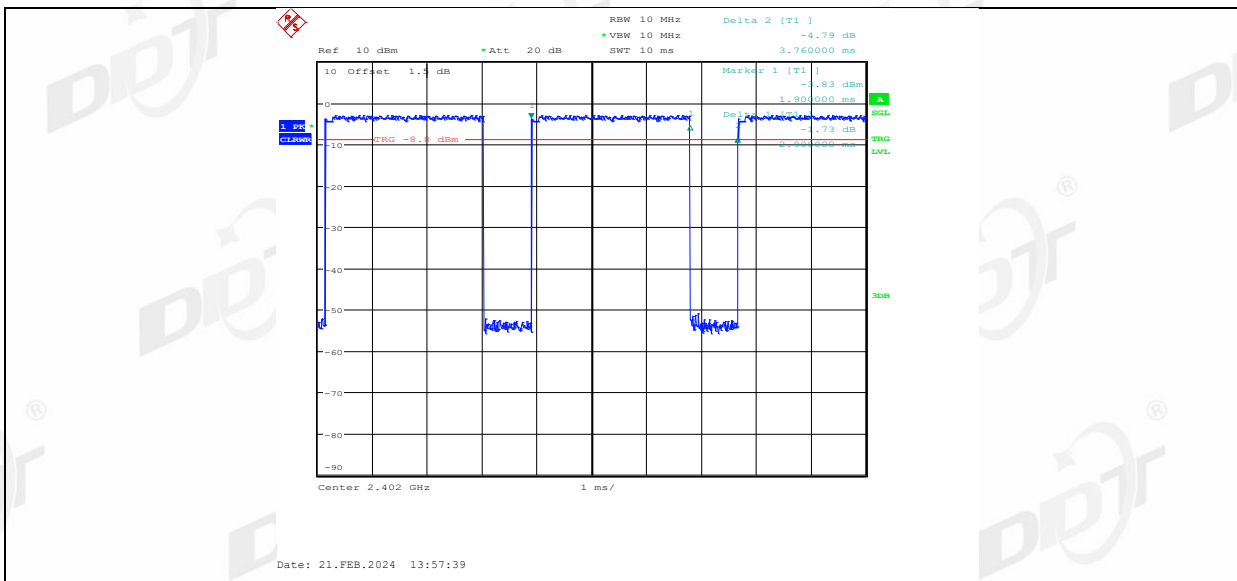

3DH5 Ant1_2441

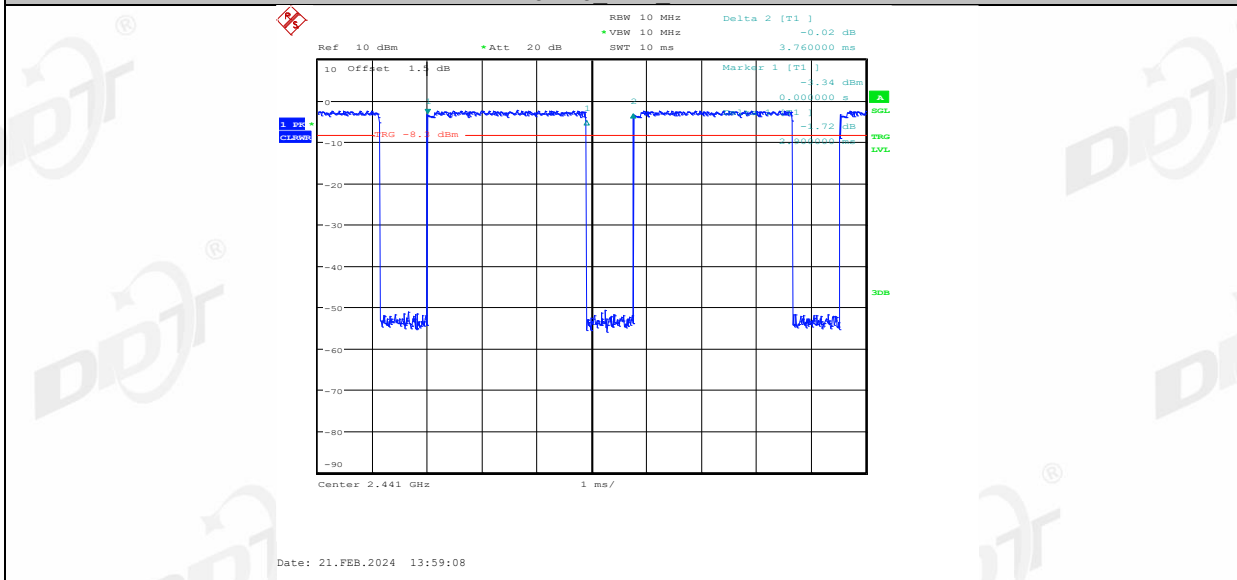

3DH5 Ant1_2480

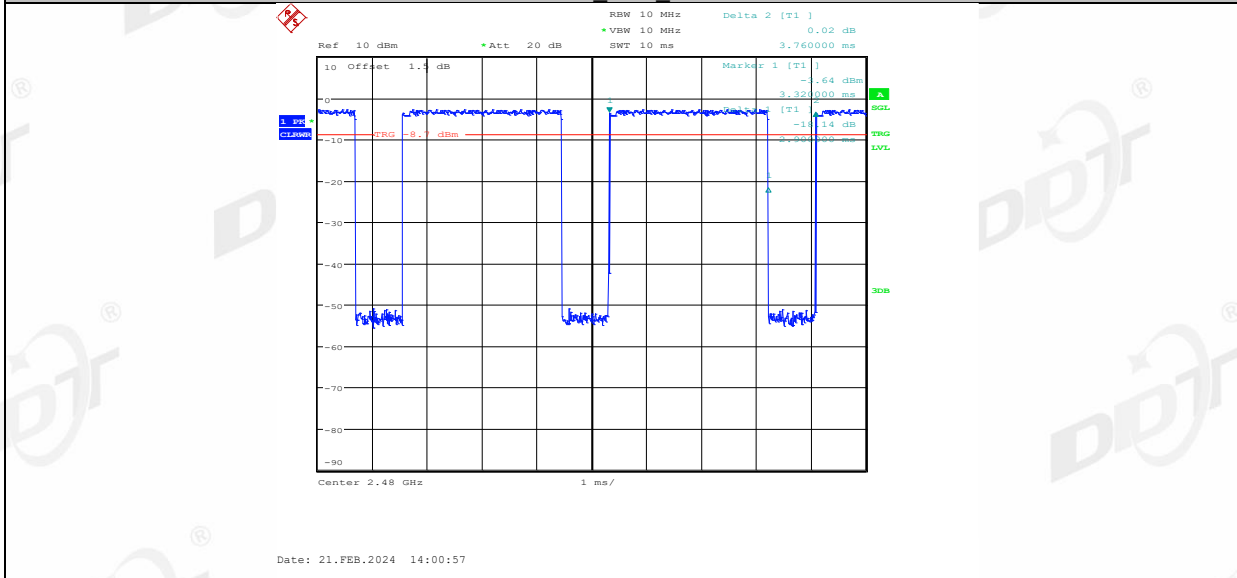

13.Radiated Emission

13.1. Test equipment

Equipment	Manufacturer	Model No.	Serial No.	Cal Due To
/	/	/	/	/

13.2. Block diagram of test setup

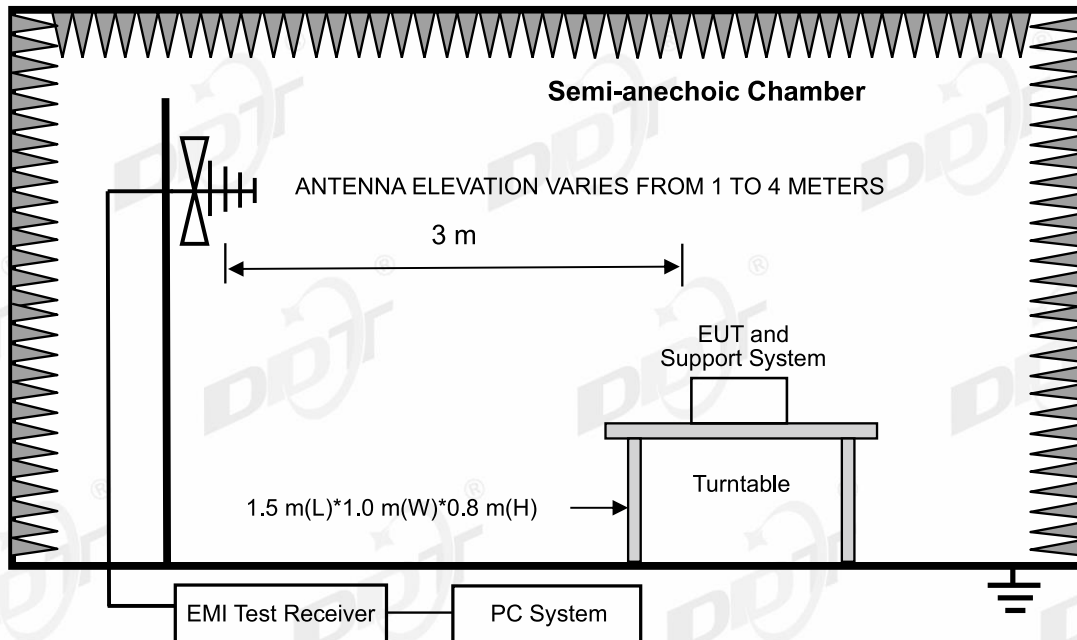
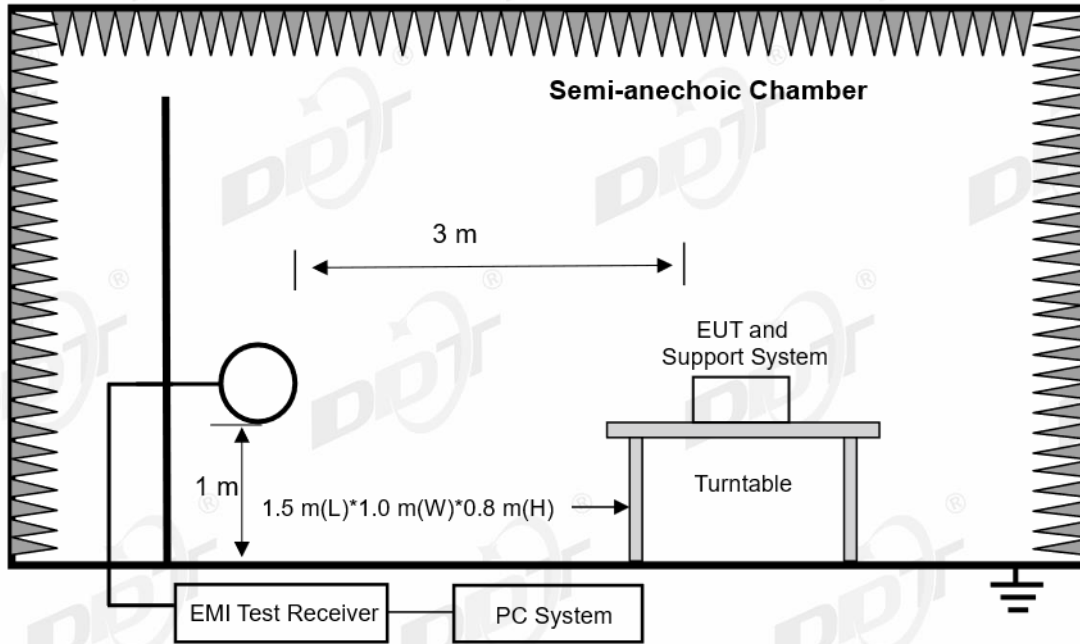

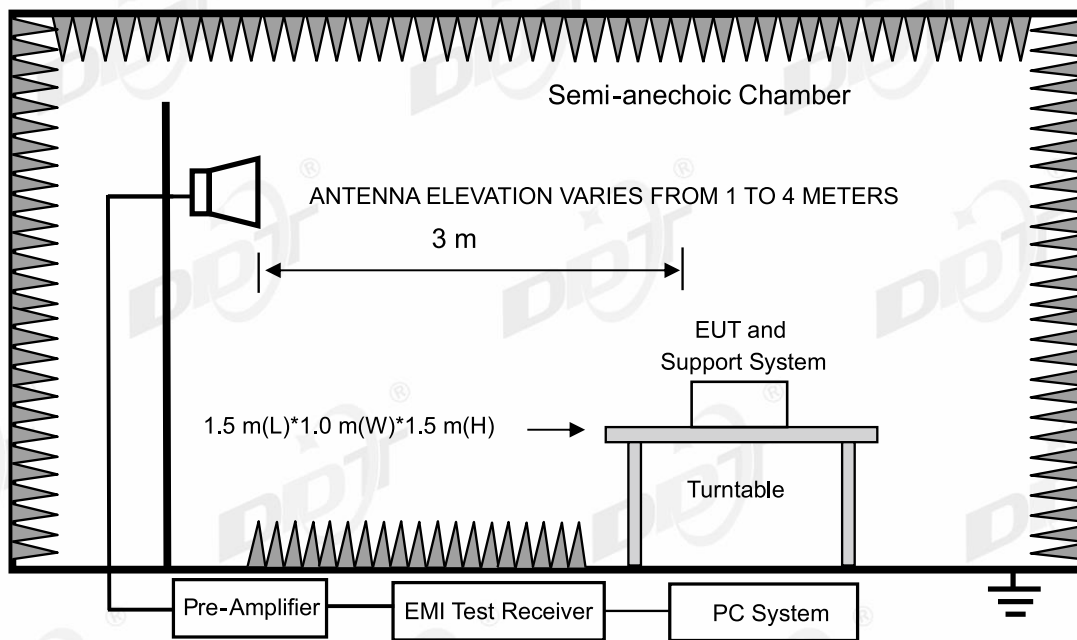

13.3. Limits

(1) FCC 15.205 Restricted frequency band

MHz	MHz	MHz	GHz
0.090-0.110	16.42-16.423	399.9-410	4.5-5.15
10.495-0.505	16.69475-16.69525	608-614	5.35-5.46
2.1735-2.1905	16.80425-16.80475	960-1240	7.25-7.75
4.125-4.128	25.5-25.67	1300-1427	8.025-8.5
4.1772&4.17775	37.5-38.25	1435-1626.5	9.0-9.2
4.2072&4.20775	73-74.6	1645.5-1646.5	9.3-9.5
6.215-6.218	74.8-75.2	1660-1710	10.6-12.7
6.26775-6.26825	108-121.94	1718.8-1722.2	13.25-13.4
6.31175-6.31225	123-138	2200-2300	14.47-14.5
8.291-8.294	149.9-150.05	2310-2390	15.35-16.2
8.362-8.366	156.52475-156.52525	2483.5-2500	17.7-21.4
8.37625-8.38675	156.7-156.9	2690-2900	22.01-23.12
8.41425-8.41475	162.0125-167.17	3260-3267	23.6-24.0
12.29-12.293	167.72-173.2	3332-3339	31.2-31.8
12.51975-12.52025	240-285	3345.8-3358	36.43-36.5
12.57675-12.57725	322-335.4	3600-4400	(2)
13.36-13.41			

1Until February 1, 1999, this restricted band shall be 0.490-0.510 MHz

2Above 38.6

(2) FCC 15.209 Limit

FREQUENCY MHz	DISTANCE Meters	FIELD STRENGTHS LIMIT	
		mV/m	dB(mV)/m
0.009 ~ 0.490	300	2400/F(kHz)	67.6-20log(F)
0.490 ~ 1.705	30	24000/F(kHz)	87.6-20log(F)
1.705 ~ 30.0	30	30	29.54
30 ~ 88	3	100	40.0
88 ~ 216	3	150	43.5
216 ~ 960	3	200	46.0
960 ~ 1000	3	500	54.0
Above	1000	74.0 dB(mV)/m (Peak) 54.0 dB(mV)/m (Average)	

Note:

(1) The emission limits shown in the above table are based on measurements employing a CISPR QP detector except for the frequency bands 9 - 90 kHz, 110 - 490 kHz and above 1000 MHz, radiated emissions limits in these three bands are based on measurements employing an average detector.

(2) At frequencies below 30 MHz, measurement may be performed at a distance closer than that specified, and the limit at closer measurement distance can be extrapolated by below formula:

$$\text{Limit}_{3\text{m}}(\text{dBuV/m}) = \text{Limit}_{30\text{m}}(\text{dBuV/m}) + 40\text{Log}(30\text{m}/3\text{m})$$

(3) Limit for this EUT

The emissions appearing within 15.205 restricted frequency bands shall not exceed the limits shown in 15.209, , all the other emissions shall be at least 20 dB below the fundamental emissions or comply with 15.209 limits .

13.4. Assistant equipment used for test

Assistant equipment	Manufacturer	Model number	Description	other
/	/	/	/	/

13.5. Test procedure

- (1) EUT was placed on a non-metallic table, 80 cm above the ground plane inside a semi-anechoic chamber for below 1G and 150 cm above the ground plane inside a fully-anechoic chamber for above 1G.
- (2) Test antenna was located 3 m from the EUT on an adjustable mast, and the antenna used as below table.

Test frequency range	Test antenna used	Test antenna distance
9 kHz - 30 MHz	Active Loop antenna	3 m
30 MHz - 1 GHz	Trilog Broadband Antenna	3 m
1 GHz - 18 GHz	Double Ridged Horn Antenna(1 GHz-18 GHz)	3 m

18 GHz - 40 GHz	Horn Antenna(18 GHz-40 GHz)	1 m
-----------------	-----------------------------	-----

According ANSI C63.10:2013 clause 6.4.6 and 6.5.3, for measurements below 30 MHz, Antenna was located 3 m from EUT, the loop antenna was positioned in three antenna orientations (parallel, perpendicular, and round-parallel), for each measurement antenna alignment, the EUT shall be rotated through 0° to 360° on a turntable, and the lowest height of the magnetic antenna shall be 1 m above the ground. For measurement above 30MHz, the trilog Broadband Antenna or Horn Antenna was located 3m from EUT, Measurements were made with the antenna positioned in both the horizontal and vertical planes of Polarization, and the measurement antenna was varied from 1 m to 4 m. in height above the reference ground plane to obtain the maximum signal strength.

(3) Below pre-scan procedure was first performed in order to find prominent frequency spectrum radiated emissions from 9 kHz to 25 GHz:

(a) Scanning the peak frequency spectrum with the antenna specified in step (3), and the EUT was rotated 360 degree, the antenna height was varied from 1 m to 4 m (Except loop antenna, it's fixed 1 m above ground.)

(b) Change work frequency or channel of device if practicable.

(c) Change modulation type of device if practicable.

(d) Change power supply range from 85% to 115% of the rated supply voltage

(e) Rotated EUT though three orthogonal axes to determine the attitude of EUT arrangement produces highest emissions.

Spectrum frequency from 9 kHz to 25 GHz (tenth harmonic of fundamental frequency) was investigated, and no any obvious emission were detected from 18 GHz to 25 GHz, so below final test was performed with frequency range from 9 kHz to 18 GHz.

(4) For final emissions measurements at each frequency of interest, the EUT was rotated and the antenna height was varied between 1 m and 4 m in order to maximize the emission. Measurements in both horizontal and vertical polarities were made and the data was recorded. In order to find the maximum emission, the relative positions of equipment and all of the interface cables were changed according to ANSI C63.10:2013 on Radiated Emission test.

(5) The emissions from 9 kHz to 1 GHz were measured based on CISPR QP detector except for the frequency bands 9 - 90 kHz, 110 - 490 kHz, for emissions from 9 kHz - 90 kHz, 110 kHz - 490 kHz and above 1 GHz were measured based on average detector, for emissions above 1 GHz, peak emissions also be measured and need comply with Peak limit.

(6) The emissions from 9 kHz to 1 GHz, QP or average values were measured with EMI receiver with below RBW.

Frequency band	RBW
9 kHz - 150 kHz	200 Hz
150 kHz - 30 MHz	9 kHz
30 MHz - 1 GHz	120 kHz

(7) For emissions above 1GHz, both Peak and Average level were measured with Spectrum Analyzer, and the RBW is set at 1 MHz, VBW is set at 3 MHz for Peak measure; According ANSI C63.10:2013 clause 4.1.4.2.2 procedure for average measure.

(8) For portable device, X axis, Y axis, Z axis are tested, and worse setup is reported.

13.6. Test result

PASS. (See below detailed test result)

13.7. Test data

TR-4-E-009 Radiated Emission Test Result

Test Date: 2024-02-20 **Tested By:** Bairong
EUT: Safe Audio Headphone **Model Number:** Buzz junior
Test Mode: BT mode **Power Supply:** Battery
Condition: Temp:23.4°C;Humi:62.3% **Test Site:** DDT 3# Chamber
File Path: d:\ts\2024 report data\Q24010331-3E\FCC BELOW 1G\20240220-233520_H
Memo: Sample Number:S24010331-012 Power Setting:10

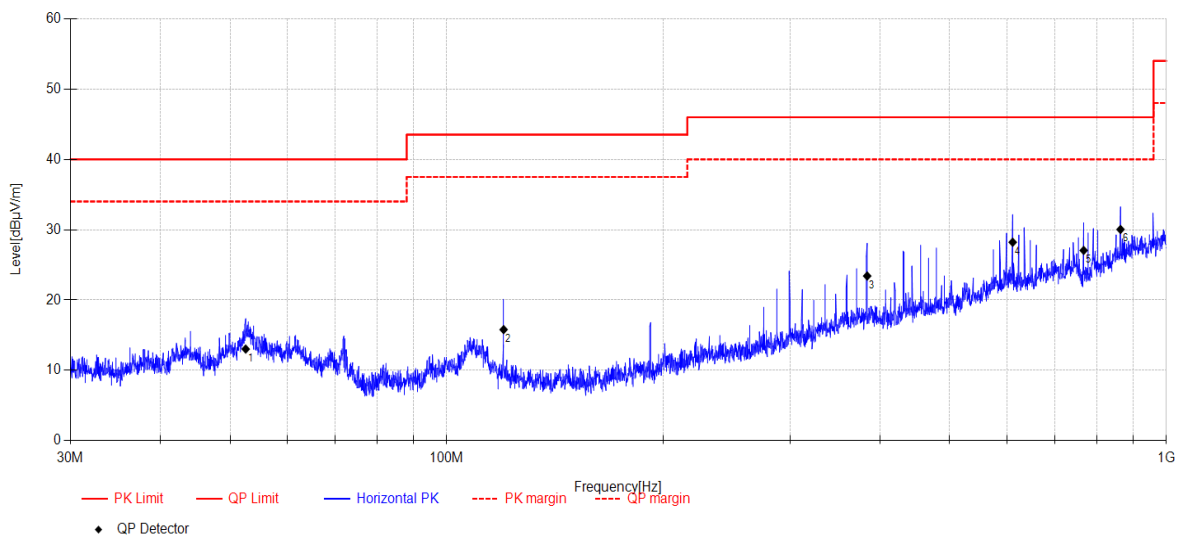

Data List										
NO.	Freq. [MHz]	Reading [dBµV/m]	Antenna Factor [dB]	Cable Loss [dB]	AMP [dB]	Result [dBµV/m]	Limit [dBµV/m]	Margin [dB]	Detector	Polarity
1	52.57	25.68	13.30	4.74	-30.68	13.04	40.00	26.96	QP	Horizontal
2	119.99	31.47	10.00	5.17	-30.84	15.80	43.50	27.70	QP	Horizontal
3	384.01	31.6	15.34	6.61	-30.13	23.42	46.00	22.58	QP	Horizontal
4	611.70	31.61	19.13	7.38	-29.90	28.22	46.00	17.78	QP	Horizontal
5	767.71	30.52	18.53	7.91	-29.90	27.06	46.00	18.94	QP	Horizontal
6	863.69	30.24	20.92	8.21	-29.33	30.04	46.00	15.96	QP	Horizontal

Note:

1. Result Level = Reading + Cable loss + Antenna Factor + AMP
2. If Peak Result complies with QP limit, QP Result is deemed to comply with QP limit.
3. Test setup: RBW: 120 kHz, VBW: 300 kHz, Sweep time: auto.

TR-4-E-009 Radiated Emission Test Result

Test Date: 2024-02-20 **Tested By:** Bairong
EUT: Safe Audio Headphone **Model Number:** Buzz junior
Test Mode: BT mode **Power Supply:** Battery
Condition: Temp:23.4°C;Humi:62.3% **Test Site:** DDT 3# Chamber
File Path: d:\ts\2024 report data\Q24010331-3E\FCC BELOW 1G\20240220-233610_V
Memo: Sample Number:S24010331-012 Power Setting:10

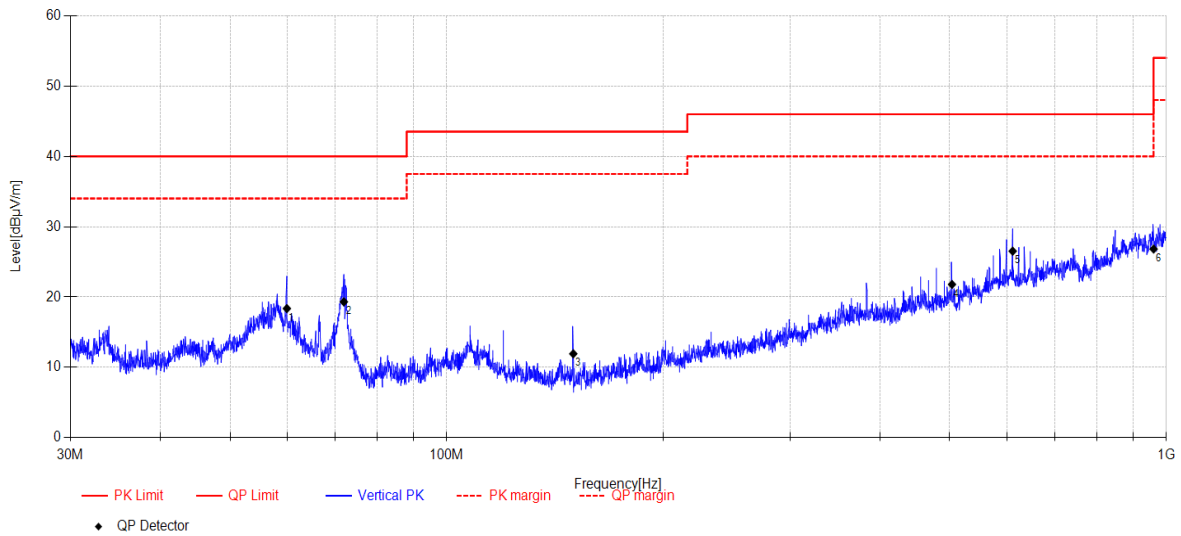

Data List										
NO.	Freq. [MHz]	Reading [dBµV/m]	Antenna Factor [dB]	Cable Loss [dB]	AMP [dB]	Result [dBµV/m]	Limit [dBµV/m]	Margin [dB]	Detector	Polarity
1	59.98	31.45	12.79	4.76	-30.63	18.37	40.00	21.63	QP	Vertical
2	71.97	35.47	9.60	4.80	-30.55	19.32	40.00	20.68	QP	Vertical
3	149.96	29.25	8.12	5.32	-30.75	11.94	43.50	31.56	QP	Vertical
4	503.71	27.96	16.80	6.94	-29.90	21.80	46.00	24.20	QP	Vertical
5	611.70	29.92	19.13	7.38	-29.90	26.53	46.00	19.47	QP	Vertical
6	960.15	24.55	22.19	8.55	-28.46	26.83	54.00	27.17	QP	Vertical

Note:

1. Result Level = Reading + Cable loss + Antenna Factor + AMP
2. If Peak Result complies with QP limit, QP Result is deemed to comply with QP limit.
3. Test setup: RBW: 120 kHz, VBW: 300 kHz, Sweep time: auto.

TR-4-E-009 Radiated Emission Test Result

Test Date: 2024-02-06 **Tested By:** Bairong
EUT: Safe Audio Headphone **Model Number:** Buzz junior
Test Mode: DH5 TX 2402MHz **Power Supply:** Battery
Condition: Temp:23.4°C;Humi:62.3% **Test Site:** DDT 3# Chamber
File Path: d:\ts\2024 report data\Q24010331-3E\FCC ABOVE 1G\1
Memo: Sample Number:S24010331-012 Power Setting:10

Test Graph

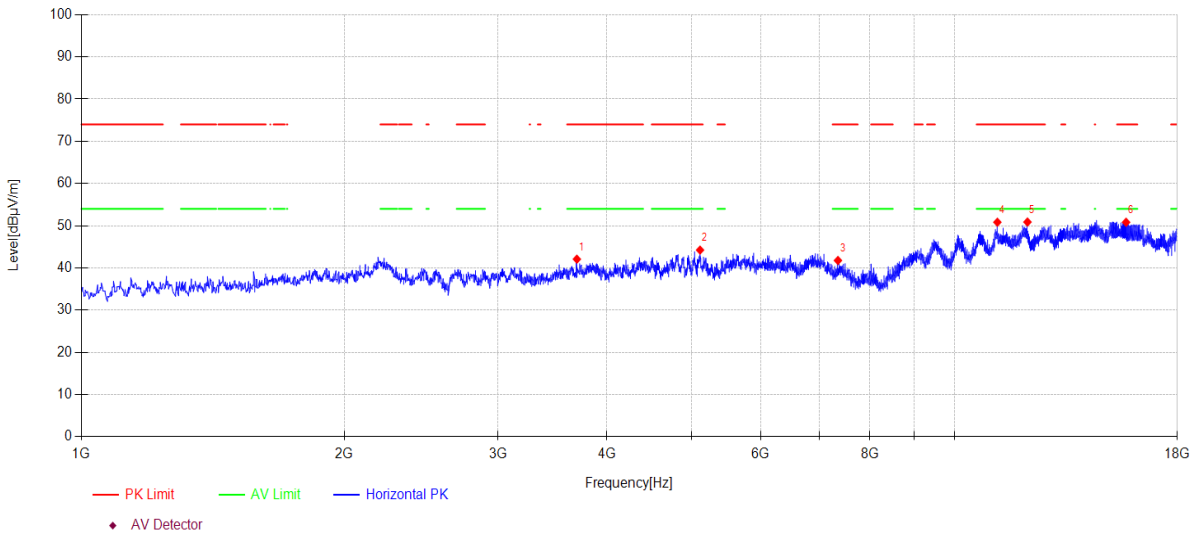

Data List										
NO	Freq. [MHz]	Reading [dBµV/m]	Antenna Factor [dB]	Cable loss [dB]	AMP [dB]	Level [dBµV/m]	Limit [dBµV/m]	Margin [dB]	Detector	Polarity
1	3694.50	46.18	30.38	5.78	-40.26	42.08	74.00	31.92	PK	Horizontal
2	5112.30	42.88	33.40	8.03	-40.07	44.24	74.00	29.76	PK	Horizontal
3	7354.60	38.94	36.79	7.63	-41.59	41.77	74.00	32.23	PK	Horizontal
4	11198.30	40.99	39.20	9.83	-39.18	50.84	74.00	23.16	PK	Horizontal
5	12123.10	40.64	39.30	10.54	-39.61	50.87	74.00	23.13	PK	Horizontal
6	15723.70	36.93	38.45	14.63	-39.19	50.82	74.00	23.18	PK	Horizontal

Note:

- Level = Reading + Cable loss + Antenna Factor + AMP
- If Peak Result complies with AV limit, AV Result is deemed to comply with AV limit.
- Test setup: RBW: 1 MHz, VBW: 3 MHz, Sweep time: auto.

TR-4-E-009 Radiated Emission Test Result

Test Date: 2024-02-06 **Tested By:** Bairong
EUT: Safe Audio Headphone **Model Number:** Buzz junior
Test Mode: DH5 TX 2402MHz **Power Supply:** Battery
Condition: Temp:23.4°C;Humi:62.3% **Test Site:** DDT 3# Chamber
File Path: d:\ts\2024 report data\Q24010331-3E\FCC ABOVE 1G\2
Memo: Sample Number:S24010331-012 Power Setting:10

Test Graph

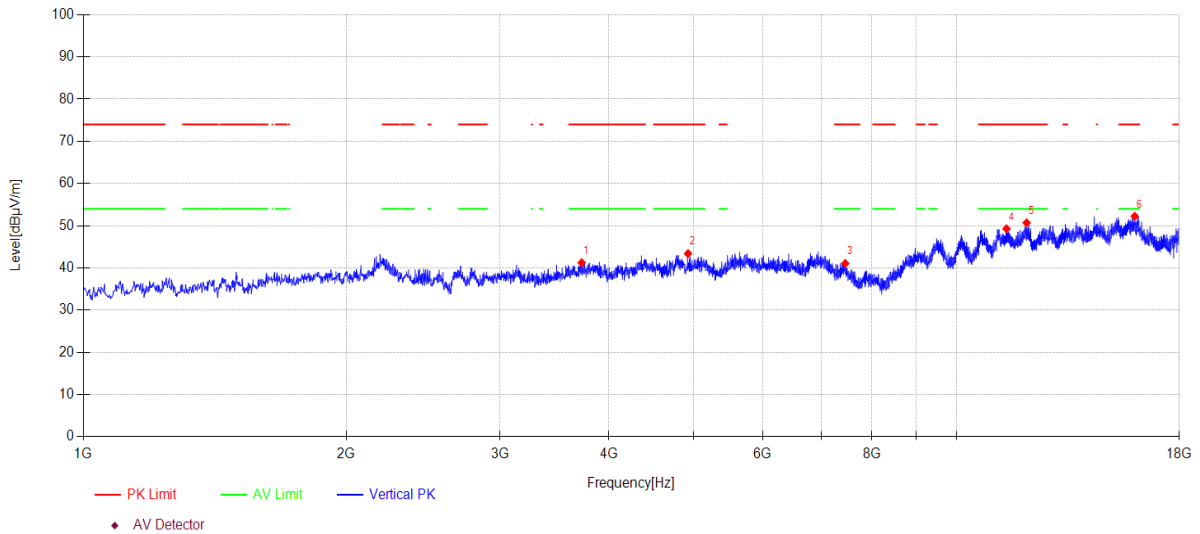

Data List										
NO	Freq. [MHz]	Reading [dBµV/m]	Antenna Factor [dB]	Cable loss [dB]	AMP [dB]	Level [dBµV/m]	Limit [dBµV/m]	Margin [dB]	Detector	Polarity
1	3721.70	45.29	30.44	5.79	-40.28	41.24	74.00	32.76	PK	Vertical
2	4927.00	42.74	33.05	7.72	-40.11	43.40	74.00	30.60	PK	Vertical
3	7458.30	38.69	36.58	7.64	-41.85	41.06	74.00	32.94	PK	Vertical
4	11410.80	39.24	39.29	10.02	-39.28	49.27	74.00	24.73	PK	Vertical
5	12033.00	40.49	39.23	10.54	-39.57	50.69	74.00	23.31	PK	Vertical
6	16002.50	37.73	38.00	15.87	-39.36	52.24	74.00	21.76	PK	Vertical

Note:

- Level = Reading + Cable loss + Antenna Factor + AMP
- If Peak Result complies with AV limit, AV Result is deemed to comply with AV limit.
- Test setup: RBW: 1 MHz, VBW: 3 MHz, Sweep time: auto.

TR-4-E-009 Radiated Emission Test Result

Test Date: 2024-02-06 **Tested By:** Bairong
EUT: Safe Audio Headphone **Model Number:** Buzz junior
Test Mode: DH5 TX 2441MHz **Power Supply:** Battery
Condition: Temp:23.4°C;Humi:62.3% **Test Site:** DDT 3# Chamber
File Path: d:\ts\2024 report data\Q24010331-3E\FCC ABOVE 1G\3
Memo: Sample Number:S24010331-012 Power Setting:10

Test Graph

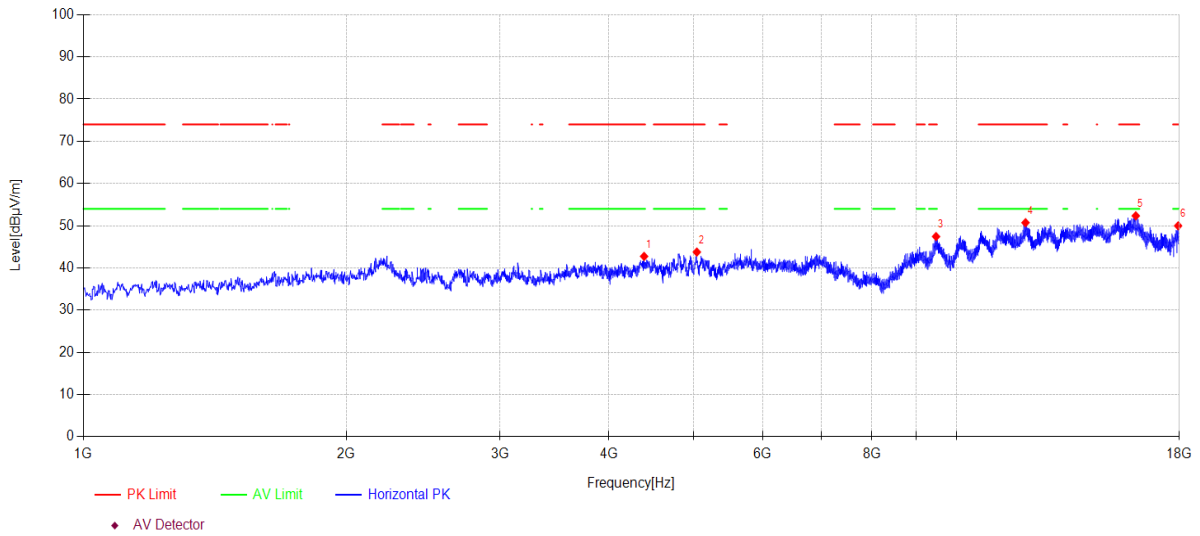

Data List										
NO	Freq. [MHz]	Reading [dBµV/m]	Antenna Factor [dB]	Cable loss [dB]	AMP [dB]	Level [dBµV/m]	Limit [dBµV/m]	Margin [dB]	Detector	Polarity
1	4388.10	44.74	31.68	6.63	-40.31	42.74	74.00	31.26	PK	Horizontal
2	5042.60	42.61	33.29	7.93	-40.07	43.76	74.00	30.24	PK	Horizontal
3	9476.20	38.67	38.70	8.83	-38.76	47.44	74.00	26.56	PK	Horizontal
4	11997.30	40.55	39.19	10.54	-39.56	50.72	74.00	23.28	PK	Horizontal
5	16046.70	38.09	37.95	15.70	-39.40	52.34	74.00	21.66	PK	Horizontal
6	17942.20	37.08	42.11	13.06	-42.27	49.98	74.00	24.02	PK	Horizontal

Note:

1. Level = Reading + Cable loss + Antenna Factor + AMP
2. If Peak Result complies with AV limit, AV Result is deemed to comply with AV limit.
3. Test setup: RBW: 1 MHz, VBW: 3 MHz, Sweep time: auto.

TR-4-E-009 Radiated Emission Test Result

Test Date: 2024-02-06 **Tested By:** Bairong
EUT: Safe Audio Headphone **Model Number:** Buzz junior
Test Mode: DH5 TX 2441MHz **Power Supply:** Battery
Condition: Temp:23.4°C;Humi:62.3% **Test Site:** DDT 3# Chamber
File Path: d:\ts\2024 report data\Q24010331-3E\FCC ABOVE 1G\4
Memo: Sample Number:S24010331-012 Power Setting:10

Test Graph

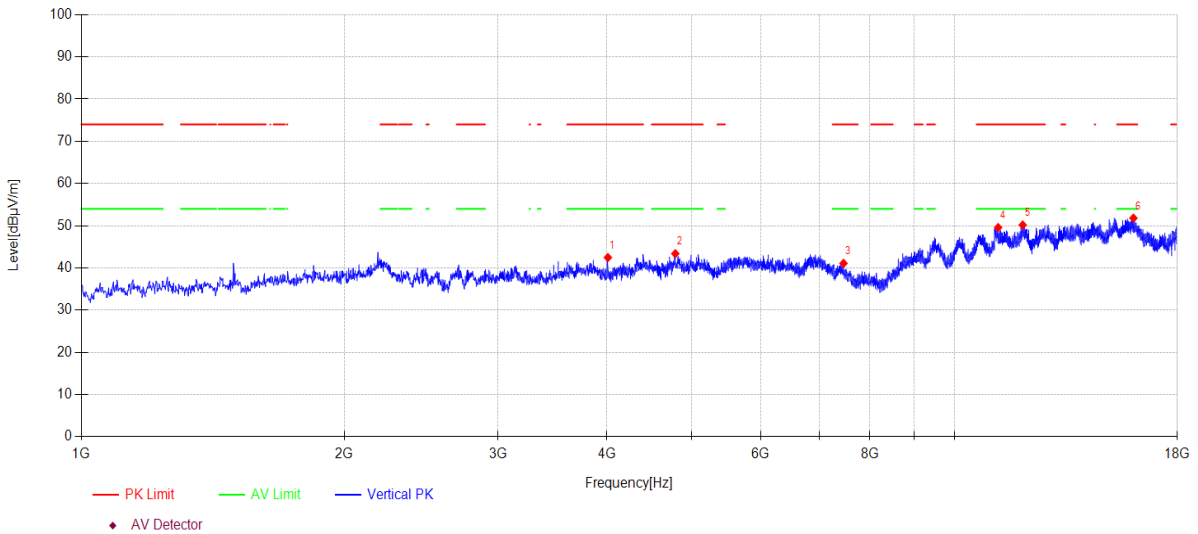

Data List										
NO	Freq. [MHz]	Reading [dBµV/m]	Antenna Factor [dB]	Cable loss [dB]	AMP [dB]	Level [dBµV/m]	Limit [dBµV/m]	Margin [dB]	Detector	Polarity
1	4009.00	46.13	30.92	5.87	-40.45	42.47	74.00	31.53	PK	Vertical
2	4789.30	43.65	32.46	7.44	-40.16	43.39	74.00	30.61	PK	Vertical
3	7463.40	38.73	36.57	7.64	-41.86	41.08	74.00	32.92	PK	Vertical
4	11220.40	39.72	39.20	9.85	-39.19	49.58	74.00	24.42	PK	Vertical
5	11973.50	40.08	39.12	10.52	-39.55	50.17	74.00	23.83	PK	Vertical
6	16031.40	37.47	37.97	15.76	-39.39	51.81	74.00	22.19	PK	Vertical

Note:

1. Level = Reading + Cable loss + Antenna Factor + AMP
2. If Peak Result complies with AV limit, AV Result is deemed to comply with AV limit.
3. Test setup: RBW: 1 MHz, VBW: 3 MHz, Sweep time: auto.

TR-4-E-009 Radiated Emission Test Result

Test Date: 2024-02-06 **Tested By:** Bairong
EUT: Safe Audio Headphone **Model Number:** Buzz junior
Test Mode: DH5 TX 2480MHz **Power Supply:** Battery
Condition: Temp:23.4°C;Humi:62.3% **Test Site:** DDT 3# Chamber
File Path: d:\ts\2024 report data\Q24010331-3E\FCC ABOVE 1G\5
Memo: Sample Number:S24010331-012 Power Setting:10

Test Graph

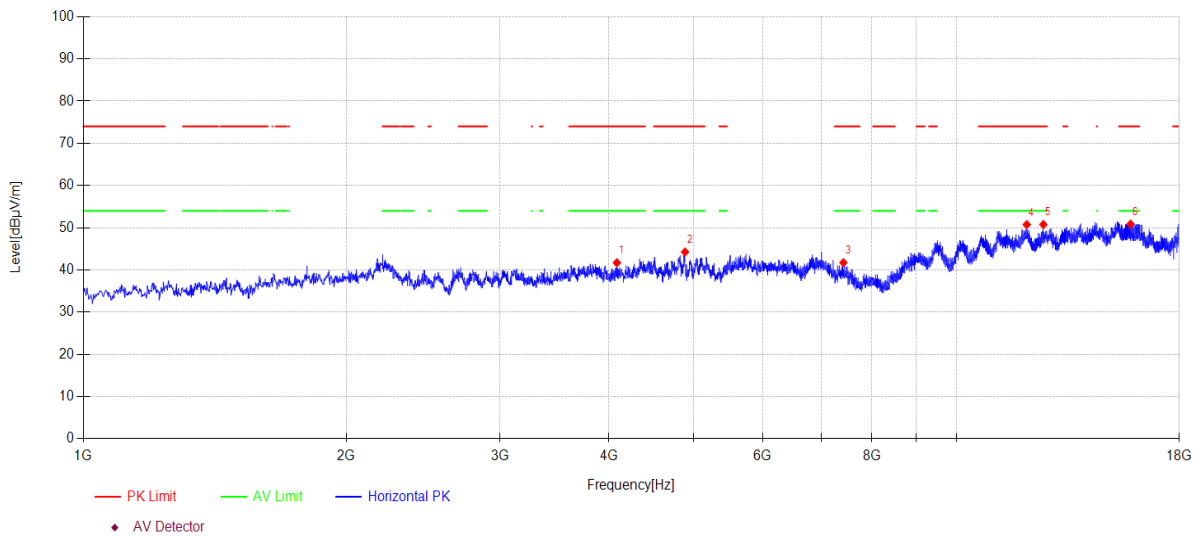

Data List										
NO	Freq. [MHz]	Reading [dBµV/m]	Antenna Factor [dB]	Cable loss [dB]	AMP [dB]	Level [dBµV/m]	Limit [dBµV/m]	Margin [dB]	Detector	Polarity
1	4083.80	45.03	31.07	6.02	-40.42	41.70	74.00	32.30	PK	Horizontal
2	4887.90	43.55	33.19	7.64	-40.12	44.26	74.00	29.74	PK	Horizontal
3	7422.60	39.20	36.65	7.64	-41.76	41.73	74.00	32.27	PK	Horizontal
4	12038.10	40.54	39.24	10.54	-39.57	50.75	74.00	23.25	PK	Horizontal
5	12577.00	40.62	39.40	10.54	-39.79	50.77	74.00	23.23	PK	Horizontal
6	15825.70	36.78	38.25	15.09	-39.26	50.86	74.00	23.14	PK	Horizontal

Note:

- Level = Reading + Cable loss + Antenna Factor + AMP
- If Peak Result complies with AV limit, AV Result is deemed to comply with AV limit.
- Test setup: RBW: 1 MHz, VBW: 3 MHz, Sweep time: auto.

TR-4-E-009 Radiated Emission Test Result

Test Date: 2024-02-06 **Tested By:** Bairong
EUT: Safe Audio Headphone **Model Number:** Buzz junior
Test Mode: DH5 TX 2480MHz **Power Supply:** Battery
Condition: Temp:23.4°C;Humi:62.3% **Test Site:** DDT 3# Chamber
File Path: d:\ts\2024 report data\Q24010331-3E\FCC ABOVE 1G\6
Memo: Sample Number:S24010331-012 Power Setting:10

Test Graph

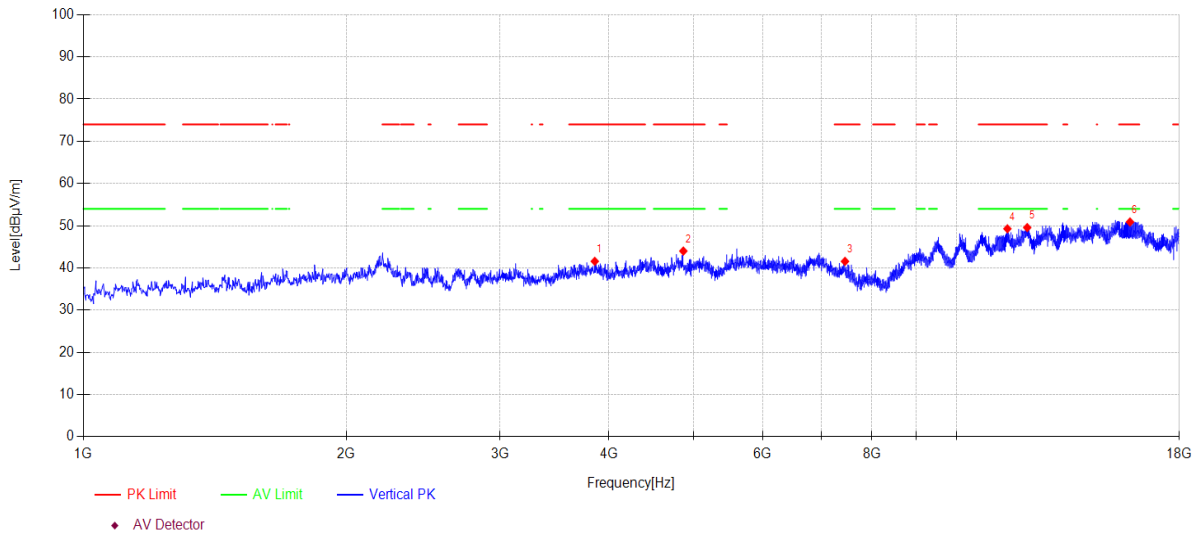

Data List										
NO	Freq. [MHz]	Reading [dBµV/m]	Antenna Factor [dB]	Cable loss [dB]	AMP [dB]	Level [dBµV/m]	Limit [dBµV/m]	Margin [dB]	Detector	Polarity
1	3852.60	45.19	30.92	5.82	-40.36	41.57	74.00	32.43	PK	Vertical
2	4865.80	42.98	33.55	7.60	-40.13	44.00	74.00	30.00	PK	Vertical
3	7453.20	39.16	36.59	7.64	-41.83	41.56	74.00	32.44	PK	Vertical
4	11438.00	39.28	39.26	10.04	-39.30	49.28	74.00	24.72	PK	Vertical
5	12051.70	39.35	39.25	10.54	-39.58	49.56	74.00	24.44	PK	Vertical
6	15805.30	36.84	38.29	15.00	-39.24	50.89	74.00	23.11	PK	Vertical

Note:

- Level = Reading + Cable loss + Antenna Factor + AMP
- If Peak Result complies with AV limit, AV Result is deemed to comply with AV limit.
- Test setup: RBW: 1 MHz, VBW: 3 MHz, Sweep time: auto.

TR-4-E-009 Radiated Emission Test Result

Test Date: 2024-02-06 **Tested By:** Bairong
EUT: Safe Audio Headphone **Model Number:** Buzz junior
Test Mode: DH5 TX 2402MHz **Power Supply:** Battery
Condition: Temp:23.4°C;Humi:62.3% **Test Site:** DDT 3# Chamber
File Path: d:\ts\2024 report data\Q24010331-3E\FCC ABOVE 1G\7
Memo: Sample Number:S24010331-012 Power Setting:10

Test Graph

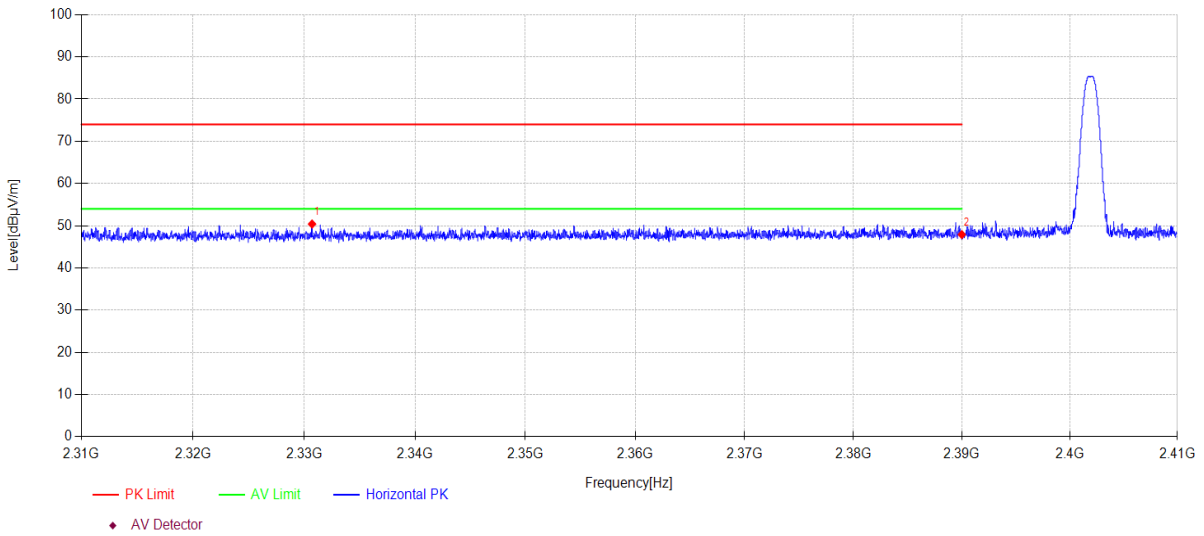

Data List										
NO	Freq. [MHz]	Reading [dBµV/m]	Antenna Factor [dB]	Cable loss [dB]	AMP [dB]	Level [dBµV/m]	Limit [dBµV/m]	Margin [dB]	Detector	Polarity
1	2330.70	19.60	26.98	3.82	0.00	50.40	74.00	23.60	PK	Horizontal
2	2390.00	16.78	27.26	3.87	0.00	47.91	74.00	26.09	PK	Horizontal

Note:

1. Level = Reading + Cable loss + Antenna Factor + AMP
2. If Peak Result complies with AV limit, AV Result is deemed to comply with AV limit.
3. Test setup: RBW: 1 MHz, VBW: 3 MHz, Sweep time: auto.

TR-4-E-009 Radiated Emission Test Result

Test Date: 2024-02-06 **Tested By:** Bairong
EUT: Safe Audio Headphone **Model Number:** Buzz junior
Test Mode: DH5 TX 2402MHz **Power Supply:** Battery
Condition: Temp:23.4°C;Humi:62.3% **Test Site:** DDT 3# Chamber
File Path: d:\ts\2024 report data\Q24010331-3E\FCC ABOVE 1G\8
Memo: Sample Number:S24010331-012 Power Setting:10

Test Graph

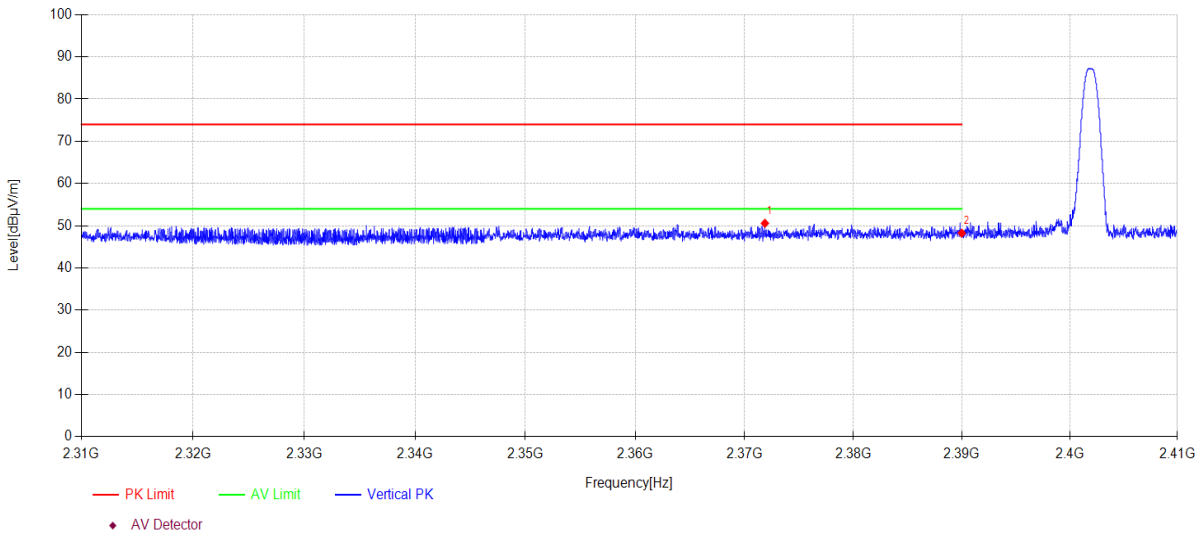

Data List										
NO	Freq. [MHz]	Reading [dBµV/m]	Antenna Factor [dB]	Cable loss [dB]	AMP [dB]	Level [dBµV/m]	Limit [dBµV/m]	Margin [dB]	Detector	Polarity
1	2371.87	19.54	27.19	3.85	0.00	50.58	74.00	23.42	PK	Vertical
2	2390.00	17.12	27.26	3.87	0.00	48.25	74.00	25.75	PK	Vertical

Note:

1. Level = Reading + Cable loss + Antenna Factor + AMP
2. If Peak Result complies with AV limit, AV Result is deemed to comply with AV limit.
3. Test setup: RBW: 1 MHz, VBW: 3 MHz, Sweep time: auto.

TR-4-E-009 Radiated Emission Test Result

Test Date: 2024-02-06 **Tested By:** Bairong
EUT: Safe Audio Headphone **Model Number:** Buzz junior
Test Mode: 2DH5 TX 2402MHz **Power Supply:** Battery
Condition: Temp:23.4°C;Humi:62.3% **Test Site:** DDT 3# Chamber
File Path: d:\ts\2024 report data\Q24010331-3E\FCC ABOVE 1G\9
Memo: Sample Number:S24010331-012 Power Setting:10

Test Graph

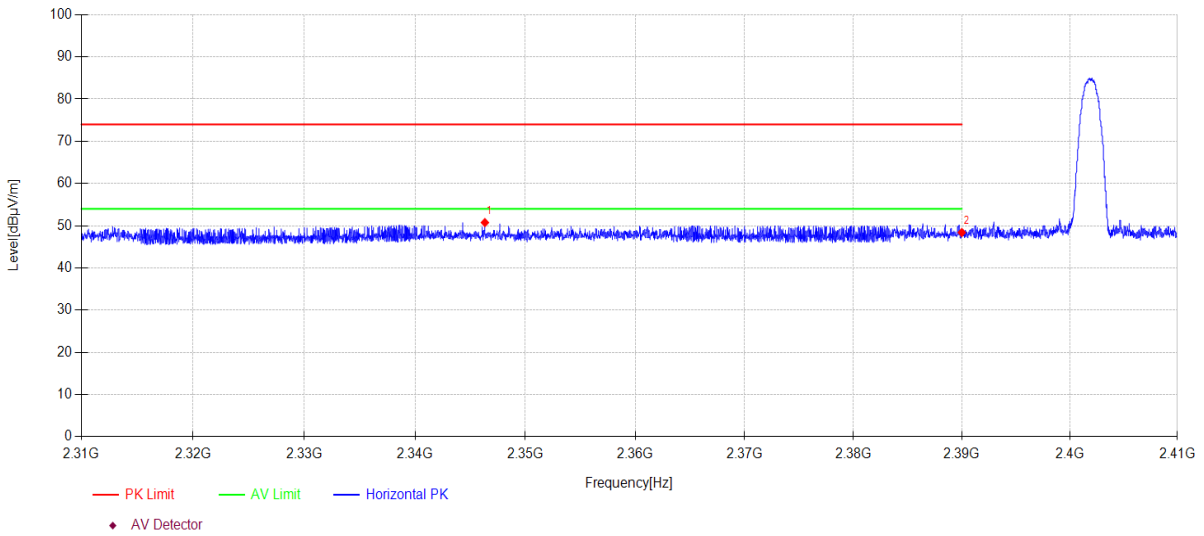

Data List										
NO	Freq. [MHz]	Reading [dBµV/m]	Antenna Factor [dB]	Cable loss [dB]	AMP [dB]	Level [dBµV/m]	Limit [dBµV/m]	Margin [dB]	Detector	Polarity
1	2346.33	19.84	27.08	3.83	0.00	50.75	74.00	23.25	PK	Horizontal
2	2390.00	17.26	27.26	3.87	0.00	48.39	74.00	25.61	PK	Horizontal

Note:

1. Level = Reading + Cable loss + Antenna Factor + AMP
2. If Peak Result complies with AV limit, AV Result is deemed to comply with AV limit.
3. Test setup: RBW: 1 MHz, VBW: 3 MHz, Sweep time: auto.

TR-4-E-009 Radiated Emission Test Result

Test Date: 2024-02-06 **Tested By:** Bairong
EUT: Safe Audio Headphone **Model Number:** Buzz junior
Test Mode: 2DH5 TX 2402MHz **Power Supply:** Battery
Condition: Temp:23.4°C;Humi:62.3% **Test Site:** DDT 3# Chamber
File Path: d:\ts\2024 report data\Q24010331-3E\FCC ABOVE 1G\10
Memo: Sample Number:S24010331-012 Power Setting:10

Test Graph

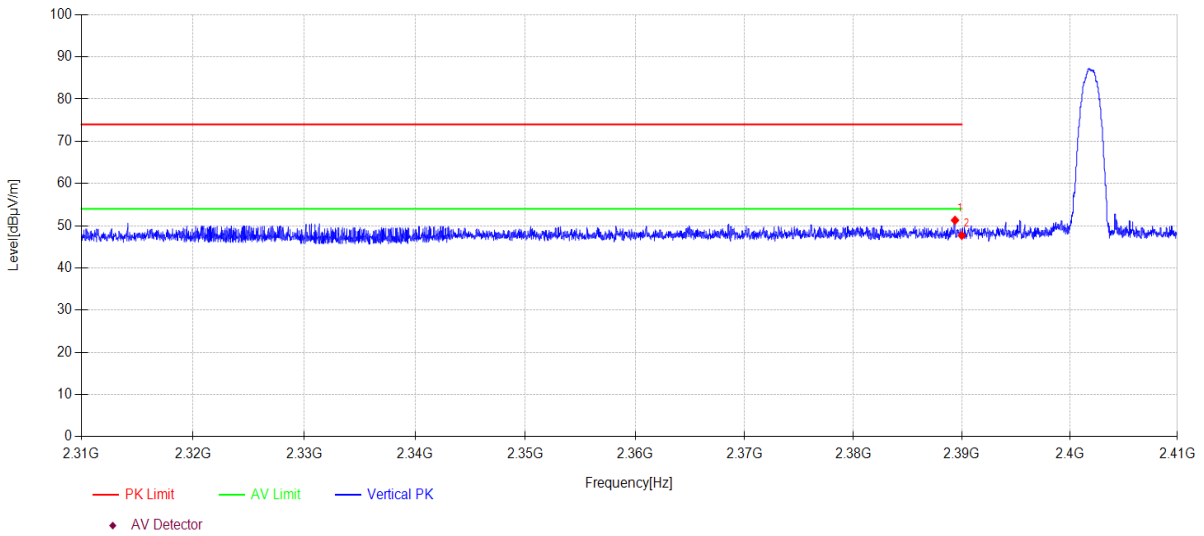

Data List										
NO	Freq. [MHz]	Reading [dBµV/m]	Antenna Factor [dB]	Cable loss [dB]	AMP [dB]	Level [dBµV/m]	Limit [dBµV/m]	Margin [dB]	Detector	Polarity
1	2389.37	20.17	27.26	3.87	0.00	51.30	74.00	22.70	PK	Vertical
2	2390.00	16.56	27.26	3.87	0.00	47.69	74.00	26.31	PK	Vertical

Note:

1. Level = Reading + Cable loss + Antenna Factor + AMP
2. If Peak Result complies with AV limit, AV Result is deemed to comply with AV limit.
3. Test setup: RBW: 1 MHz, VBW: 3 MHz, Sweep time: auto.

TR-4-E-009 Radiated Emission Test Result

Test Date: 2024-02-06 **Tested By:** Bairong
EUT: Safe Audio Headphone **Model Number:** Buzz junior
Test Mode: 3DH5 TX 2402MHz **Power Supply:** Battery
Condition: Temp:23.4°C;Humi:62.3% **Test Site:** DDT 3# Chamber
File Path: d:\ts\2024 report data\Q24010331-3E\FCC ABOVE 1G\11
Memo: Sample Number:S24010331-012 Power Setting:10

Test Graph

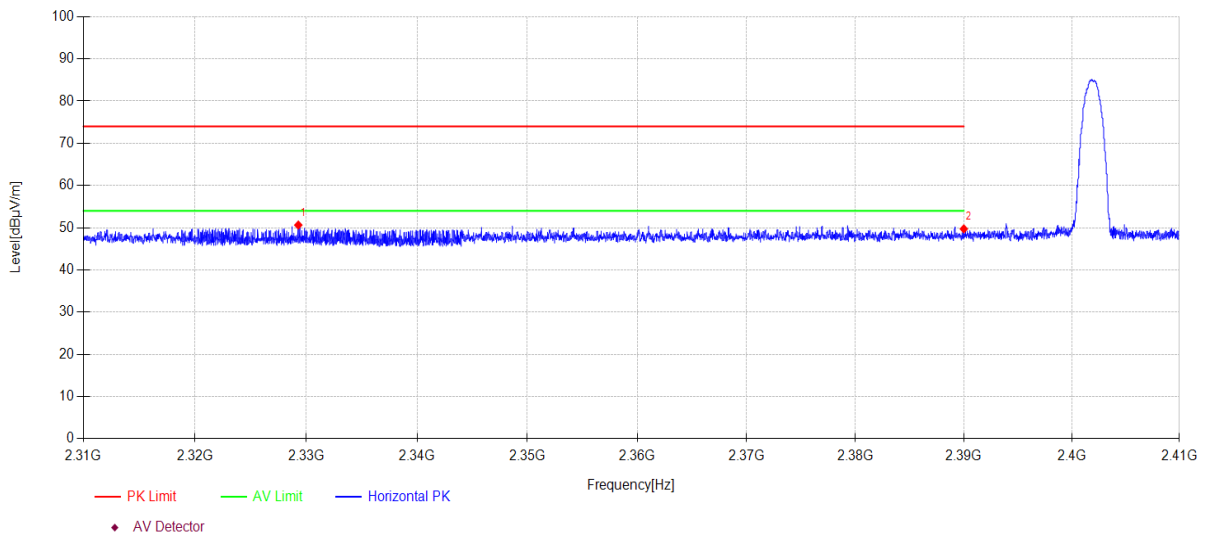

Data List										
NO	Freq. [MHz]	Reading [dBµV/m]	Antenna Factor [dB]	Cable loss [dB]	AMP [dB]	Level [dBµV/m]	Limit [dBµV/m]	Margin [dB]	Detector	Polarity
1	2329.28	19.83	26.98	3.82	0.00	50.63	74.00	23.37	PK	Horizontal
2	2390.00	18.60	27.26	3.87	0.00	49.73	74.00	24.27	PK	Horizontal

Note:

1. Level = Reading + Cable loss + Antenna Factor + AMP
2. If Peak Result complies with AV limit, AV Result is deemed to comply with AV limit.
3. Test setup: RBW: 1 MHz, VBW: 3 MHz, Sweep time: auto.

TR-4-E-009 Radiated Emission Test Result

Test Date: 2024-02-06 **Tested By:** Bairong
EUT: Safe Audio Headphone **Model Number:** Buzz junior
Test Mode: 3DH5 TX 2402MHz **Power Supply:** Battery
Condition: Temp:23.4°C;Humi:62.3% **Test Site:** DDT 3# Chamber
File Path: d:\ts\2024 report data\Q24010331-3E\FCC ABOVE 1G\12
Memo: Sample Number:S24010331-012 Power Setting:10

Test Graph

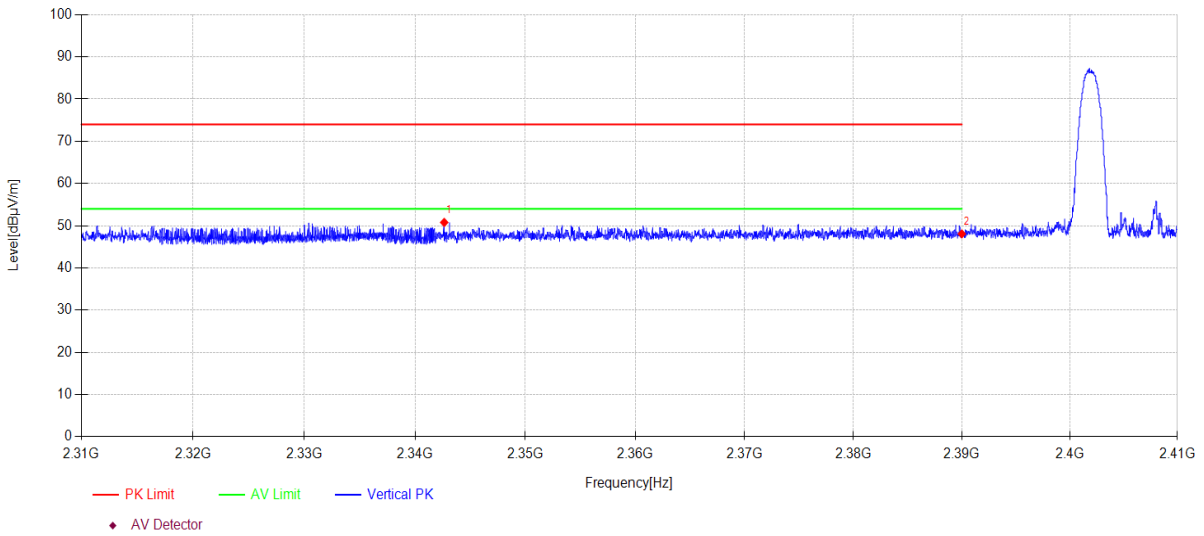

Data List										
NO	Freq. [MHz]	Reading [dBµV/m]	Antenna Factor [dB]	Cable loss [dB]	AMP [dB]	Level [dBµV/m]	Limit [dBµV/m]	Margin [dB]	Detector	Polarity
1	2342.64	19.89	27.06	3.83	0.00	50.78	74.00	23.22	PK	Vertical
2	2390.00	16.93	27.26	3.87	0.00	48.06	74.00	25.94	PK	Vertical

Note:

1. Level = Reading + Cable loss + Antenna Factor + AMP
2. If Peak Result complies with AV limit, AV Result is deemed to comply with AV limit.
3. Test setup: RBW: 1 MHz, VBW: 3 MHz, Sweep time: auto.

TR-4-E-009 Radiated Emission Test Result

Test Date: 2024-02-06 **Tested By:** Bairong
EUT: Safe Audio Headphone **Model Number:** Buzz junior
Test Mode: DH5 TX 2480MHz **Power Supply:** Battery
Condition: Temp:23.4°C;Humi:62.3% **Test Site:** DDT 3# Chamber
File Path: d:\ts\2024 report data\Q24010331-3E\FCC ABOVE 1G\13
Memo: Sample Number:S24010331-012 Power Setting:10

Test Graph

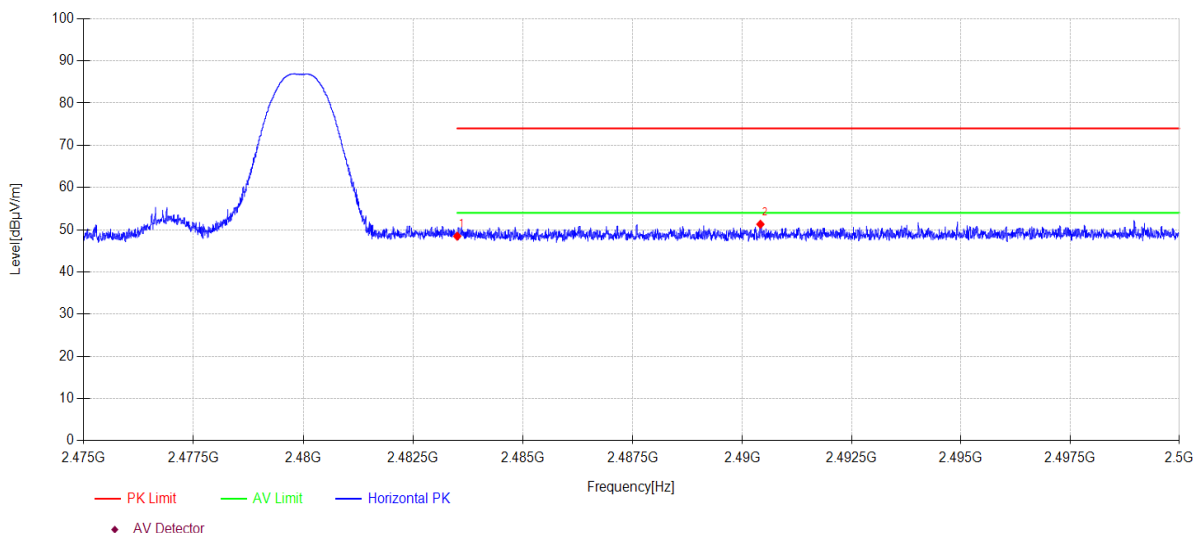

Data List										
NO	Freq. [MHz]	Reading [dBµV/m]	Antenna Factor [dB]	Cable loss [dB]	AMP [dB]	Level [dBµV/m]	Limit [dBµV/m]	Margin [dB]	Detector	Polarity
1	2483.50	17.00	27.53	3.94	0.00	48.47	74.00	25.53	PK	Horizontal
2	2490.42	19.80	27.56	3.94	0.00	51.30	74.00	22.70	PK	Horizontal

Note:

1. Level = Reading + Cable loss + Antenna Factor + AMP
2. If Peak Result complies with AV limit, AV Result is deemed to comply with AV limit.
3. Test setup: RBW: 1 MHz, VBW: 3 MHz, Sweep time: auto.

TR-4-E-009 Radiated Emission Test Result

Test Date: 2024-02-06 **Tested By:** Bairong
EUT: Safe Audio Headphone **Model Number:** Buzz junior
Test Mode: DH5 TX 2480MHz **Power Supply:** Battery
Condition: Temp:23.4°C;Humi:62.3% **Test Site:** DDT 3# Chamber
File Path: d:\ts\2024 report data\Q24010331-3E\FCC ABOVE 1G\14
Memo: Sample Number:S24010331-012 Power Setting:10

Test Graph

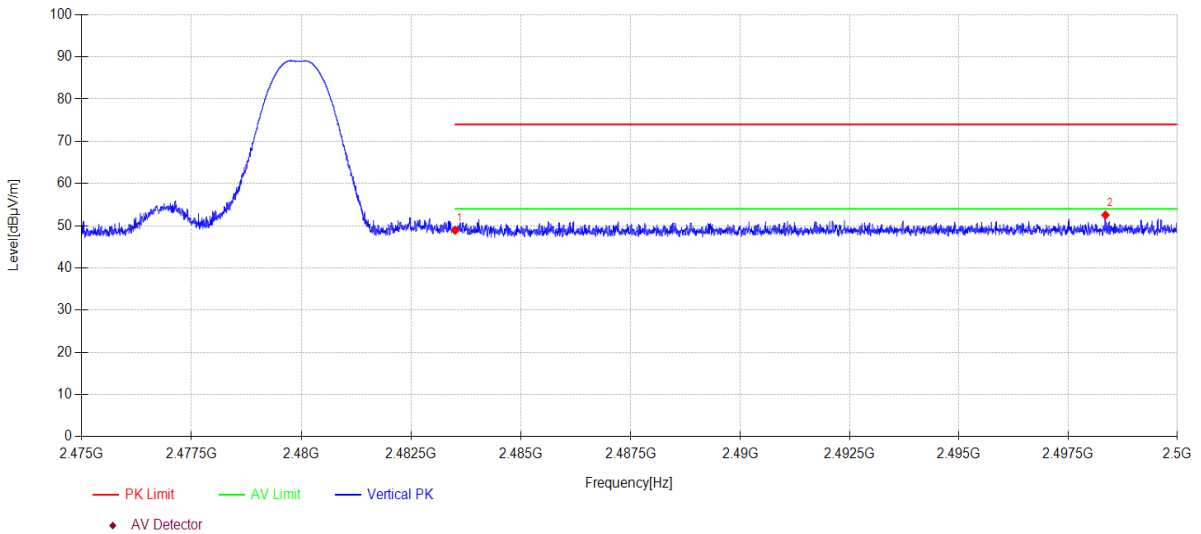

Data List										
NO	Freq. [MHz]	Reading [dBµV/m]	Antenna Factor [dB]	Cable loss [dB]	AMP [dB]	Level [dBµV/m]	Limit [dBµV/m]	Margin [dB]	Detector	Polarity
1	2483.50	17.43	27.53	3.94	0.00	48.90	74.00	25.10	PK	Vertical
2	2498.35	20.99	27.59	3.95	0.00	52.53	74.00	21.47	PK	Vertical

Note:

1. Level = Reading + Cable loss + Antenna Factor + AMP
2. If Peak Result complies with AV limit, AV Result is deemed to comply with AV limit.
3. Test setup: RBW: 1 MHz, VBW: 3 MHz, Sweep time: auto.

TR-4-E-009 Radiated Emission Test Result

Test Date: 2024-02-06 **Tested By:** Bairong
EUT: Safe Audio Headphone **Model Number:** Buzz junior
Test Mode: 2DH5 TX 2480MHz **Power Supply:** Battery
Condition: Temp:23.4°C;Humi:62.3% **Test Site:** DDT 3# Chamber
File Path: d:\ts\2024 report data\Q24010331-3E\FCC ABOVE 1G\15
Memo: Sample Number:S24010331-012 Power Setting:10

Test Graph

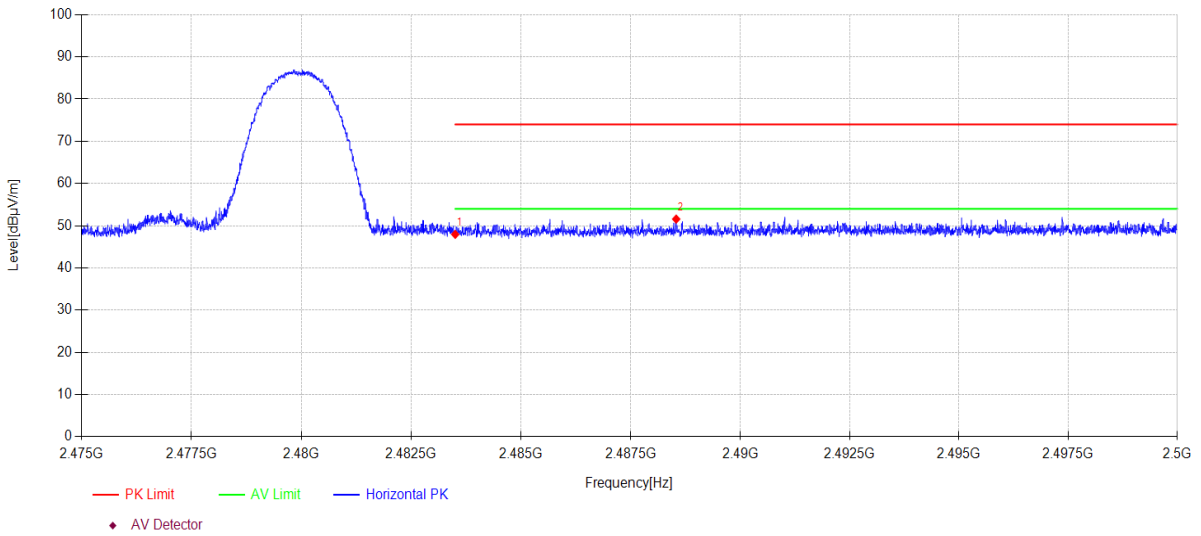

Data List										
NO	Freq. [MHz]	Reading [dBµV/m]	Antenna Factor [dB]	Cable loss [dB]	AMP [dB]	Level [dBµV/m]	Limit [dBµV/m]	Margin [dB]	Detector	Polarity
1	2483.50	16.48	27.53	3.94	0.00	47.95	74.00	26.05	PK	Horizontal
2	2488.54	20.08	27.55	3.94	0.00	51.57	74.00	22.43	PK	Horizontal

Note:

1. Level = Reading + Cable loss + Antenna Factor + AMP
2. If Peak Result complies with AV limit, AV Result is deemed to comply with AV limit.
3. Test setup: RBW: 1 MHz, VBW: 3 MHz, Sweep time: auto.

TR-4-E-009 Radiated Emission Test Result

Test Date: 2024-02-06 **Tested By:** Bairong
EUT: Safe Audio Headphone **Model Number:** Buzz junior
Test Mode: 2DH5 TX 2480MHz **Power Supply:** Battery
Condition: Temp:23.4°C;Humi:62.3% **Test Site:** DDT 3# Chamber
File Path: d:\ts\2024 report data\Q24010331-3E\FCC ABOVE 1G\16
Memo: Sample Number:S24010331-012 Power Setting:10

Test Graph

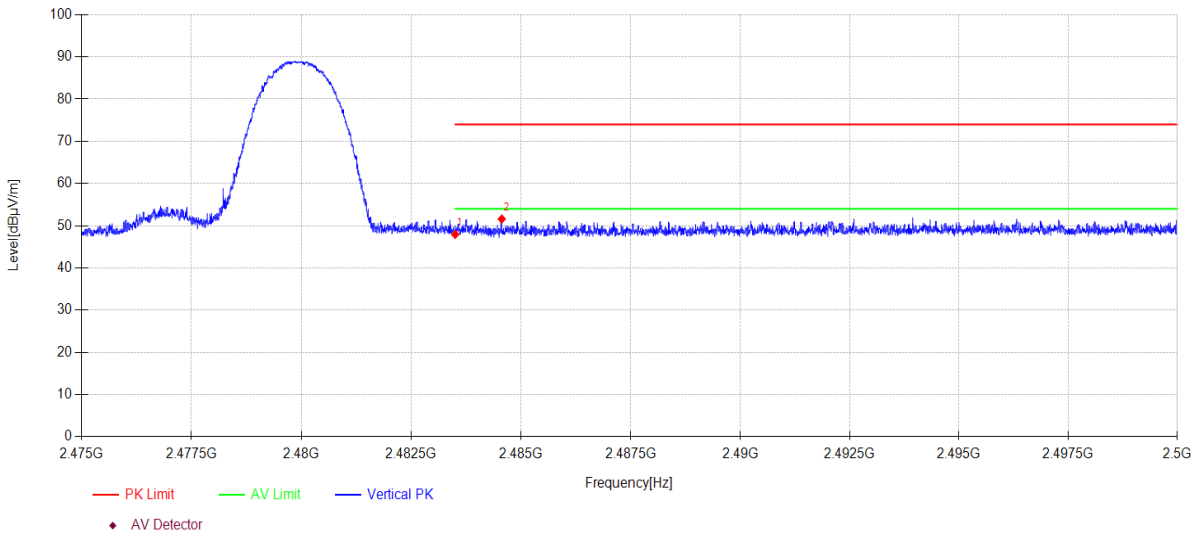

Data List										
NO	Freq. [MHz]	Reading [dBµV/m]	Antenna Factor [dB]	Cable loss [dB]	AMP [dB]	Level [dBµV/m]	Limit [dBµV/m]	Margin [dB]	Detector	Polarity
1	2483.50	16.47	27.53	3.94	0.00	47.94	74.00	26.06	PK	Vertical
2	2484.56	20.12	27.54	3.94	0.00	51.60	74.00	22.40	PK	Vertical

Note:

1. Level = Reading + Cable loss + Antenna Factor + AMP
2. If Peak Result complies with AV limit, AV Result is deemed to comply with AV limit.
3. Test setup: RBW: 1 MHz, VBW: 3 MHz, Sweep time: auto.

TR-4-E-009 Radiated Emission Test Result

Test Date: 2024-02-06 **Tested By:** Bairong
EUT: Safe Audio Headphone **Model Number:** Buzz junior
Test Mode: 3DH5 TX 2480MHz **Power Supply:** Battery
Condition: Temp:23.4°C;Humi:62.3% **Test Site:** DDT 3# Chamber
File Path: d:\ts\2024 report data\Q24010331-3E\FCC ABOVE 1G\17
Memo: Sample Number:S24010331-012 Power Setting:10

Test Graph

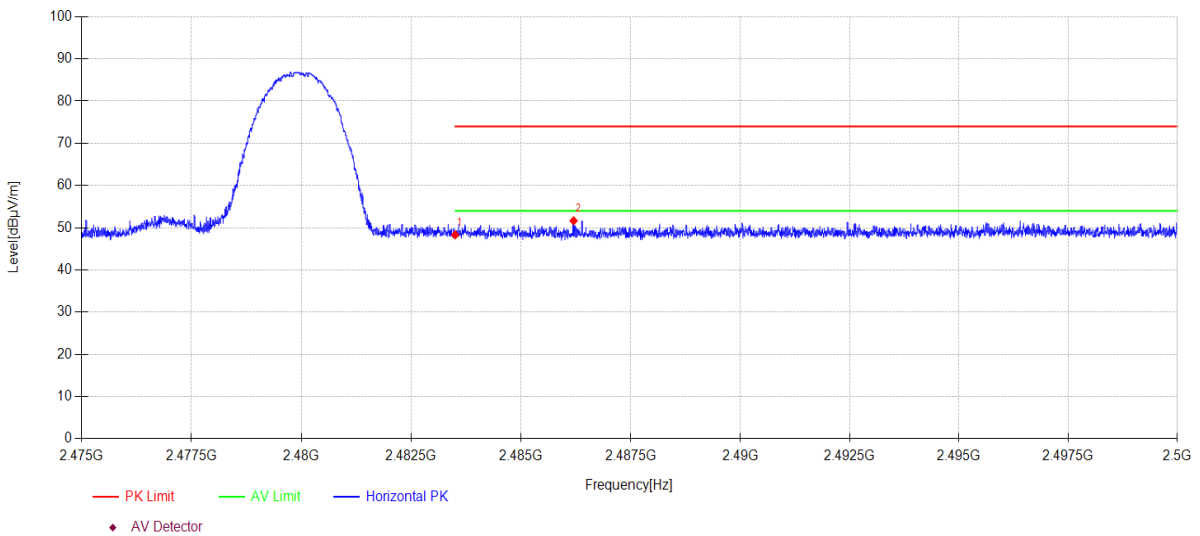

Data List										
NO	Freq. [MHz]	Reading [dBµV/m]	Antenna Factor [dB]	Cable loss [dB]	AMP [dB]	Level [dBµV/m]	Limit [dBµV/m]	Margin [dB]	Detector	Polarity
1	2483.50	16.84	27.53	3.94	0.00	48.31	74.00	25.69	PK	Horizontal
2	2486.20	20.18	27.54	3.94	0.00	51.66	74.00	22.34	PK	Horizontal

Note:

- Level = Reading + Cable loss + Antenna Factor + AMP
- If Peak Result complies with AV limit, AV Result is deemed to comply with AV limit.
- Test setup: RBW: 1 MHz, VBW: 3 MHz, Sweep time: auto.

TR-4-E-009 Radiated Emission Test Result

Test Date: 2024-02-06 **Tested By:** Bairong
EUT: Safe Audio Headphone **Model Number:** Buzz junior
Test Mode: 3DH5 TX 2480MHz **Power Supply:** Battery
Condition: Temp:23.4°C;Humi:62.3% **Test Site:** DDT 3# Chamber
File Path: d:\ts\2024 report data\Q24010331-3E\FCC ABOVE 1G\18
Memo: Sample Number:S24010331-012 Power Setting:10

Test Graph

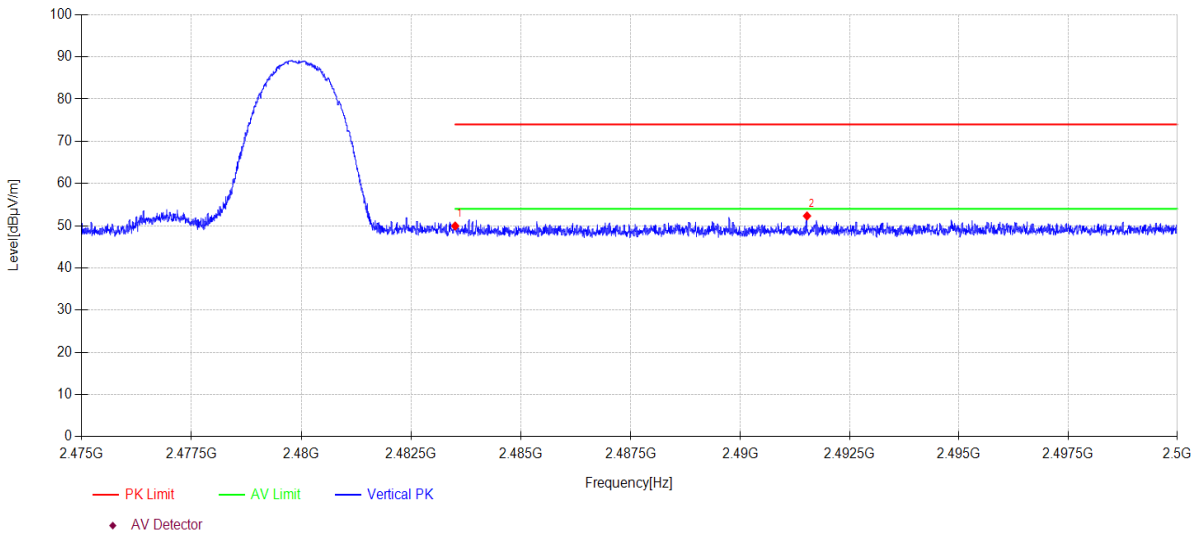

Data List										
NO	Freq. [MHz]	Reading [dBµV/m]	Antenna Factor [dB]	Cable loss [dB]	AMP [dB]	Level [dBµV/m]	Limit [dBµV/m]	Margin [dB]	Detector	Polarity
1	2483.50	18.46	27.53	3.94	0.00	49.93	74.00	24.07	PK	Vertical
2	2491.53	20.81	27.57	3.94	0.00	52.32	74.00	21.68	PK	Vertical

Note:

1. Level = Reading + Cable loss + Antenna Factor + AMP
2. If Peak Result complies with AV limit, AV Result is deemed to comply with AV limit.
3. Test setup: RBW: 1 MHz, VBW: 3 MHz, Sweep time: auto.

14. Band Edge Compliance

14.1. Test equipment

Equipment	Manufacturer	Model No.	Serial No.	Cal Due To
/	/	/	/	/

14.2. Block diagram of test setup

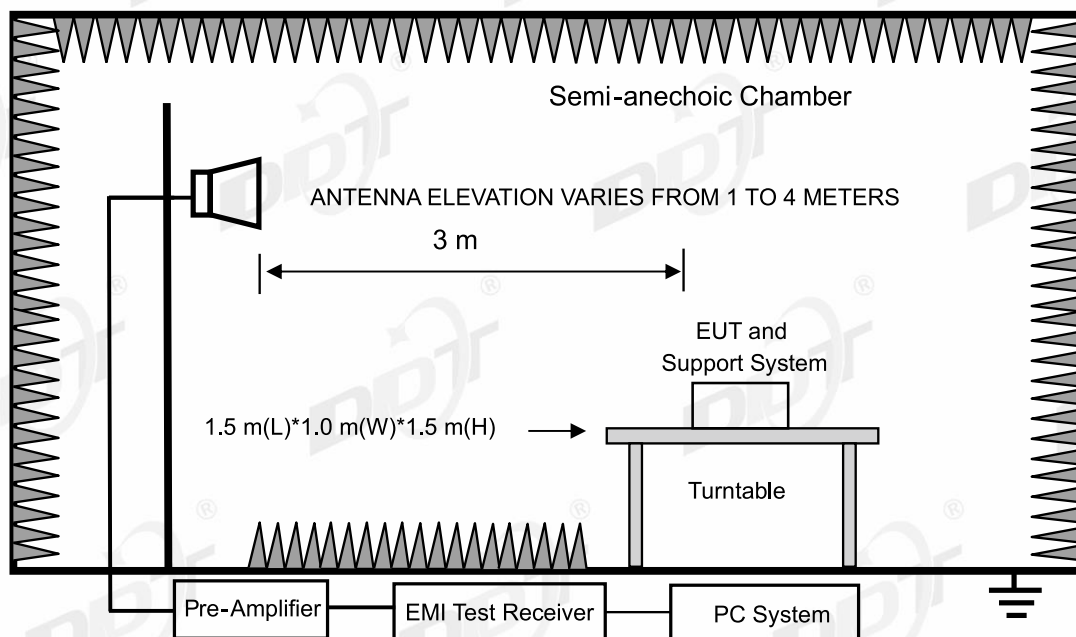

14.3. Limits

All restriction band should comply with 15.209 and limits, other emission should be at least 20 dB below the fundamental.

14.4. Assistant equipment used for test

Assistant equipment	Manufacturer	Model number	Description	other
/	/	/	/	/

14.5. Test procedure

Same with Radiated Emission except change investigated frequency range.

Remark: All restriction band have been tested, and only the worst case is shown in report.

14.6. Test result

PASS. (See below detailed test result)

14.7. Test data

TR-4-E-009 Radiated Emission Test Result

Test Date: 2024-02-06 **Tested By:** Bairong
EUT: Safe Audio Headphone **Model Number:** Buzz junior
Test Mode: DH5 TX 2402MHz **Power Supply:** Battery
Condition: Temp:23.4°C;Humi:62.3% **Test Site:** DDT 3# Chamber
File Path: d:\ts\2024 report data\Q24010331-3E\FCC ABOVE 1G\7
Memo: Sample Number:S24010331-012 Power Setting:10

Test Graph

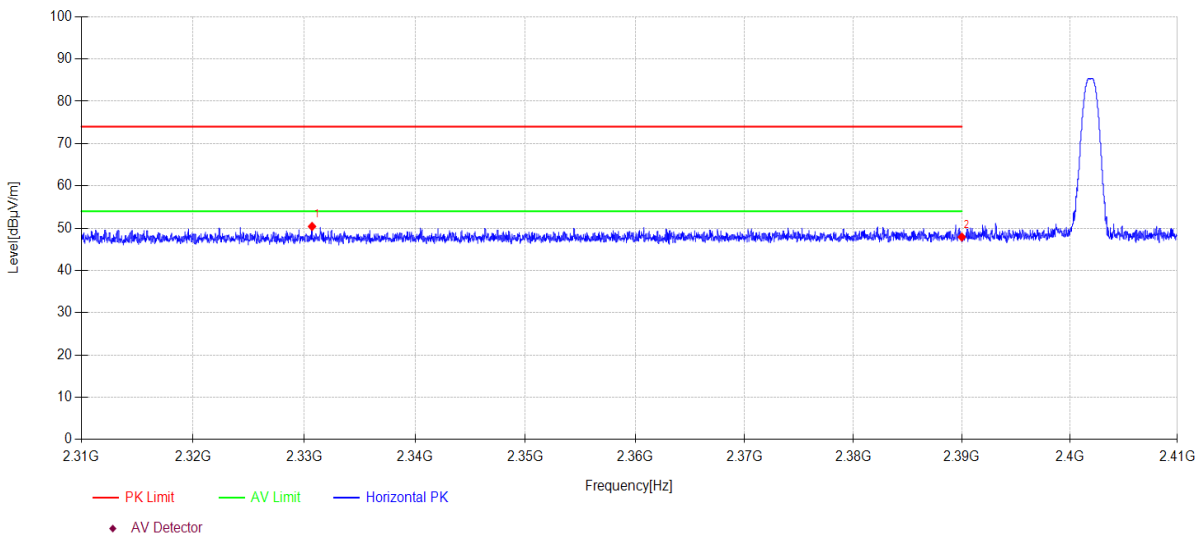

Data List										
NO	Freq. [MHz]	Reading [dBµV/m]	Antenna Factor [dB]	Cable loss [dB]	AMP [dB]	Level [dBµV/m]	Limit [dBµV/m]	Margin [dB]	Detector	Polarity
1	2330.70	19.60	26.98	3.82	0.00	50.40	74.00	23.60	PK	Horizontal
2	2390.00	16.78	27.26	3.87	0.00	47.91	74.00	26.09	PK	Horizontal

Note:

1. Level = Reading + Cable loss + Antenna Factor + AMP
2. If Peak Result complies with AV limit, AV Result is deemed to comply with AV limit.
3. Test setup: RBW: 1 MHz, VBW: 3 MHz, Sweep time: auto.

TR-4-E-009 Radiated Emission Test Result

Test Date: 2024-02-06 **Tested By:** Bairong
EUT: Safe Audio Headphone **Model Number:** Buzz junior
Test Mode: DH5 TX 2402MHz **Power Supply:** Battery
Condition: Temp:23.4°C;Humi:62.3% **Test Site:** DDT 3# Chamber
File Path: d:\ts\2024 report data\Q24010331-3E\FCC ABOVE 1G\8
Memo: Sample Number:S24010331-012 Power Setting:10

Test Graph

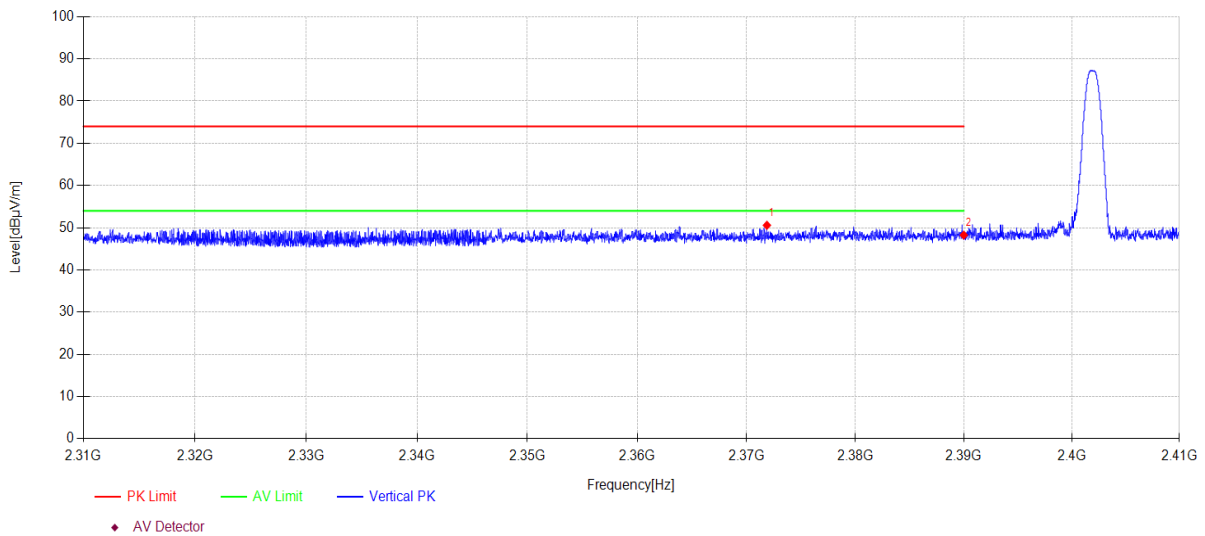

Data List										
NO	Freq. [MHz]	Reading [dBµV/m]	Antenna Factor [dB]	Cable loss [dB]	AMP [dB]	Level [dBµV/m]	Limit [dBµV/m]	Margin [dB]	Detector	Polarity
1	2371.87	19.54	27.19	3.85	0.00	50.58	74.00	23.42	PK	Vertical
2	2390.00	17.12	27.26	3.87	0.00	48.25	74.00	25.75	PK	Vertical

Note:

- Level = Reading + Cable loss + Antenna Factor + AMP
- If Peak Result complies with AV limit, AV Result is deemed to comply with AV limit.
- Test setup: RBW: 1 MHz, VBW: 3 MHz, Sweep time: auto.

TR-4-E-009 Radiated Emission Test Result

Test Date: 2024-02-06 **Tested By:** Bairong
EUT: Safe Audio Headphone **Model Number:** Buzz junior
Test Mode: 2DH5 TX 2402MHz **Power Supply:** Battery
Condition: Temp:23.4°C;Humi:62.3% **Test Site:** DDT 3# Chamber
File Path: d:\ts\2024 report data\Q24010331-3E\FCC ABOVE 1G\9
Memo: Sample Number:S24010331-012 Power Setting:10

Test Graph

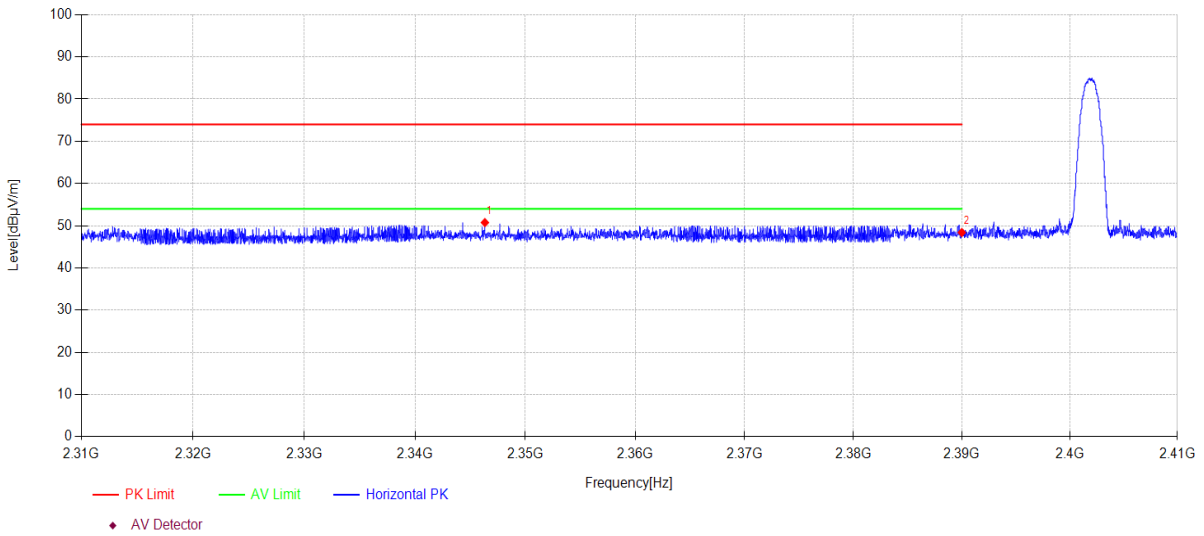

Data List										
NO	Freq. [MHz]	Reading [dBµV/m]	Antenna Factor [dB]	Cable loss [dB]	AMP [dB]	Level [dBµV/m]	Limit [dBµV/m]	Margin [dB]	Detector	Polarity
1	2346.33	19.84	27.08	3.83	0.00	50.75	74.00	23.25	PK	Horizontal
2	2390.00	17.26	27.26	3.87	0.00	48.39	74.00	25.61	PK	Horizontal

Note:

1. Level = Reading + Cable loss + Antenna Factor + AMP
2. If Peak Result complies with AV limit, AV Result is deemed to comply with AV limit.
3. Test setup: RBW: 1 MHz, VBW: 3 MHz, Sweep time: auto.

TR-4-E-009 Radiated Emission Test Result

Test Date: 2024-02-06 **Tested By:** Bairong
EUT: Safe Audio Headphone **Model Number:** Buzz junior
Test Mode: 2DH5 TX 2402MHz **Power Supply:** Battery
Condition: Temp:23.4°C;Humi:62.3% **Test Site:** DDT 3# Chamber
File Path: d:\ts\2024 report data\Q24010331-3E\FCC ABOVE 1G\10
Memo: Sample Number:S24010331-012 Power Setting:10

Test Graph

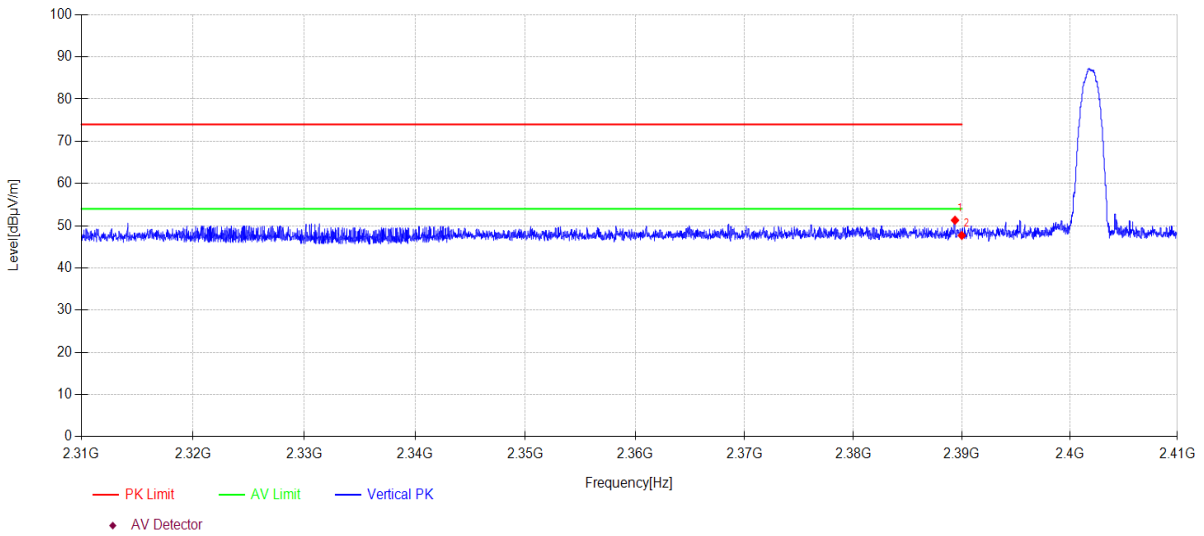

Data List										
NO	Freq. [MHz]	Reading [dBµV/m]	Antenna Factor [dB]	Cable loss [dB]	AMP [dB]	Level [dBµV/m]	Limit [dBµV/m]	Margin [dB]	Detector	Polarity
1	2389.37	20.17	27.26	3.87	0.00	51.30	74.00	22.70	PK	Vertical
2	2390.00	16.56	27.26	3.87	0.00	47.69	74.00	26.31	PK	Vertical

Note:

1. Level = Reading + Cable loss + Antenna Factor + AMP
2. If Peak Result complies with AV limit, AV Result is deemed to comply with AV limit.
3. Test setup: RBW: 1 MHz, VBW: 3 MHz, Sweep time: auto.

TR-4-E-009 Radiated Emission Test Result

Test Date: 2024-02-06 **Tested By:** Bairong
EUT: Safe Audio Headphone **Model Number:** Buzz junior
Test Mode: 3DH5 TX 2402MHz **Power Supply:** Battery
Condition: Temp:23.4°C;Humi:62.3% **Test Site:** DDT 3# Chamber
File Path: d:\ts\2024 report data\Q24010331-3E\FCC ABOVE 1G\11
Memo: Sample Number:S24010331-012 Power Setting:10

Test Graph

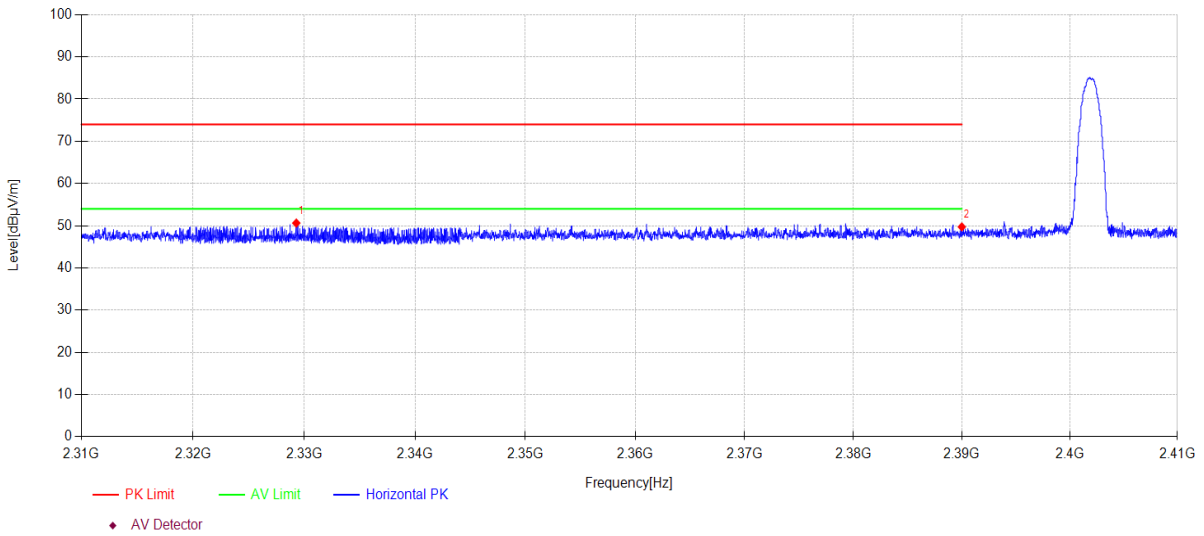

Data List										
NO	Freq. [MHz]	Reading [dBµV/m]	Antenna Factor [dB]	Cable loss [dB]	AMP [dB]	Level [dBµV/m]	Limit [dBµV/m]	Margin [dB]	Detector	Polarity
1	2329.28	19.83	26.98	3.82	0.00	50.63	74.00	23.37	PK	Horizontal
2	2390.00	18.60	27.26	3.87	0.00	49.73	74.00	24.27	PK	Horizontal

Note:

1. Level = Reading + Cable loss + Antenna Factor + AMP
2. If Peak Result complies with AV limit, AV Result is deemed to comply with AV limit.
3. Test setup: RBW: 1 MHz, VBW: 3 MHz, Sweep time: auto.

TR-4-E-009 Radiated Emission Test Result

Test Date: 2024-02-06 **Tested By:** Bairong
EUT: Safe Audio Headphone **Model Number:** Buzz junior
Test Mode: 3DH5 TX 2402MHz **Power Supply:** Battery
Condition: Temp:23.4°C;Humi:62.3% **Test Site:** DDT 3# Chamber
File Path: d:\ts\2024 report data\Q24010331-3E\FCC ABOVE 1G\12
Memo: Sample Number:S24010331-012 Power Setting:10

Test Graph

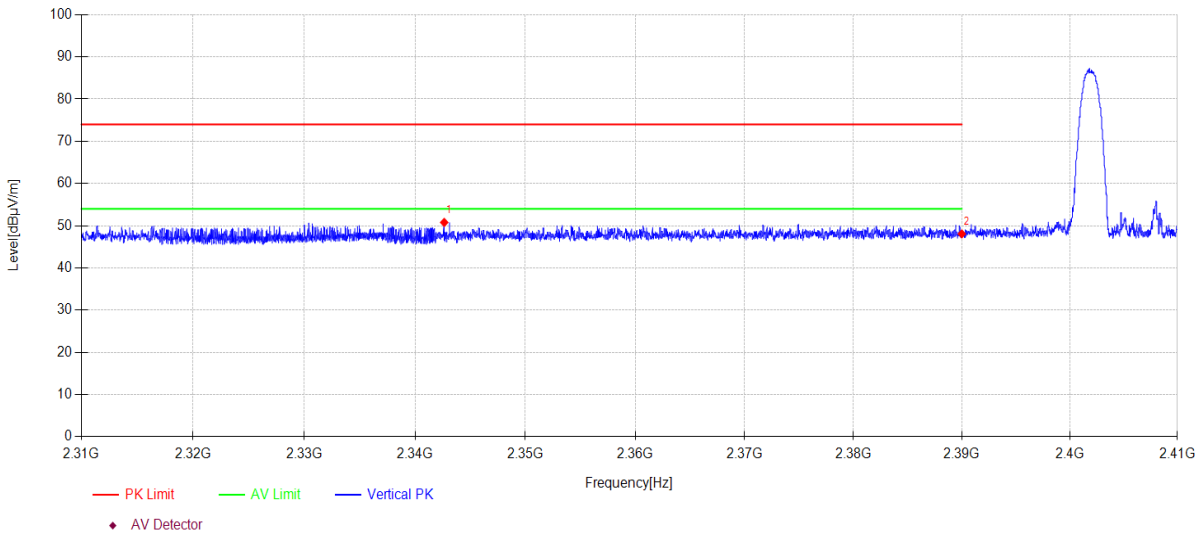

Data List										
NO	Freq. [MHz]	Reading [dBµV/m]	Antenna Factor [dB]	Cable loss [dB]	AMP [dB]	Level [dBµV/m]	Limit [dBµV/m]	Margin [dB]	Detector	Polarity
1	2342.64	19.89	27.06	3.83	0.00	50.78	74.00	23.22	PK	Vertical
2	2390.00	16.93	27.26	3.87	0.00	48.06	74.00	25.94	PK	Vertical

Note:

1. Level = Reading + Cable loss + Antenna Factor + AMP
2. If Peak Result complies with AV limit, AV Result is deemed to comply with AV limit.
3. Test setup: RBW: 1 MHz, VBW: 3 MHz, Sweep time: auto.

TR-4-E-009 Radiated Emission Test Result

Test Date: 2024-02-06 **Tested By:** Bairong
EUT: Safe Audio Headphone **Model Number:** Buzz junior
Test Mode: DH5 TX 2480MHz **Power Supply:** Battery
Condition: Temp:23.4°C;Humi:62.3% **Test Site:** DDT 3# Chamber
File Path: d:\ts\2024 report data\Q24010331-3E\FCC ABOVE 1G\13
Memo: Sample Number:S24010331-012 Power Setting:10

Test Graph

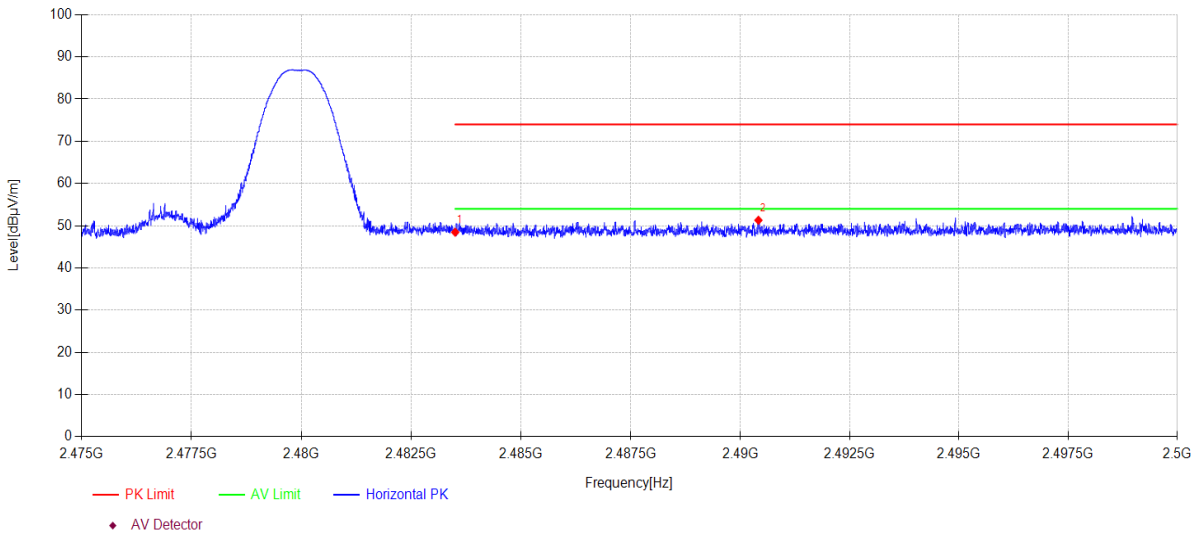

Data List										
NO	Freq. [MHz]	Reading [dBµV/m]	Antenna Factor [dB]	Cable loss [dB]	AMP [dB]	Level [dBµV/m]	Limit [dBµV/m]	Margin [dB]	Detector	Polarity
1	2483.50	17.00	27.53	3.94	0.00	48.47	74.00	25.53	PK	Horizontal
2	2490.42	19.80	27.56	3.94	0.00	51.30	74.00	22.70	PK	Horizontal

Note:

1. Level = Reading + Cable loss + Antenna Factor + AMP
2. If Peak Result complies with AV limit, AV Result is deemed to comply with AV limit.
3. Test setup: RBW: 1 MHz, VBW: 3 MHz, Sweep time: auto.

TR-4-E-009 Radiated Emission Test Result

Test Date: 2024-02-06 **Tested By:** Bairong
EUT: Safe Audio Headphone **Model Number:** Buzz junior
Test Mode: DH5 TX 2480MHz **Power Supply:** Battery
Condition: Temp:23.4°C;Humi:62.3% **Test Site:** DDT 3# Chamber
File Path: d:\ts\2024 report data\Q24010331-3E\FCC ABOVE 1G\14
Memo: Sample Number:S24010331-012 Power Setting:10

Test Graph

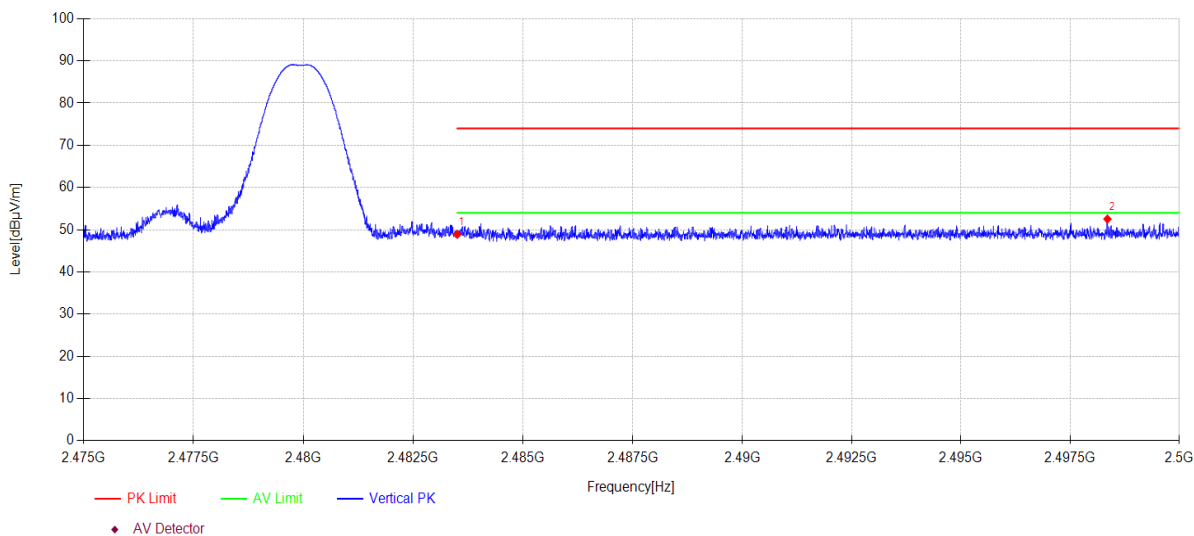

Data List										
NO	Freq. [MHz]	Reading [dBµV/m]	Antenna Factor [dB]	Cable loss [dB]	AMP [dB]	Level [dBµV/m]	Limit [dBµV/m]	Margin [dB]	Detector	Polarity
1	2483.50	17.43	27.53	3.94	0.00	48.90	74.00	25.10	PK	Vertical
2	2498.35	20.99	27.59	3.95	0.00	52.53	74.00	21.47	PK	Vertical

Note:

1. Level = Reading + Cable loss + Antenna Factor + AMP
2. If Peak Result complies with AV limit, AV Result is deemed to comply with AV limit.
3. Test setup: RBW: 1 MHz, VBW: 3 MHz, Sweep time: auto.

TR-4-E-009 Radiated Emission Test Result

Test Date: 2024-02-06 **Tested By:** Bairong
EUT: Safe Audio Headphone **Model Number:** Buzz junior
Test Mode: 2DH5 TX 2480MHz **Power Supply:** Battery
Condition: Temp:23.4°C;Humi:62.3% **Test Site:** DDT 3# Chamber
File Path: d:\ts\2024 report data\Q24010331-3E\FCC ABOVE 1G\15
Memo: Sample Number:S24010331-012 Power Setting:10

Test Graph

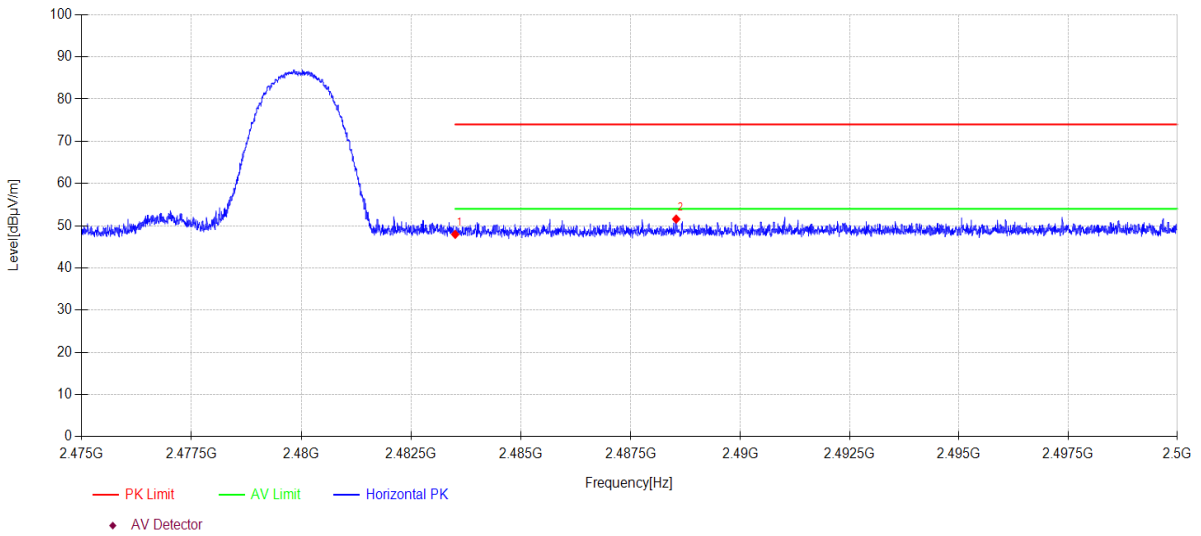

Data List										
NO	Freq. [MHz]	Reading [dBµV/m]	Antenna Factor [dB]	Cable loss [dB]	AMP [dB]	Level [dBµV/m]	Limit [dBµV/m]	Margin [dB]	Detector	Polarity
1	2483.50	16.48	27.53	3.94	0.00	47.95	74.00	26.05	PK	Horizontal
2	2488.54	20.08	27.55	3.94	0.00	51.57	74.00	22.43	PK	Horizontal

Note:

1. Level = Reading + Cable loss + Antenna Factor + AMP
2. If Peak Result complies with AV limit, AV Result is deemed to comply with AV limit.
3. Test setup: RBW: 1 MHz, VBW: 3 MHz, Sweep time: auto.

TR-4-E-009 Radiated Emission Test Result

Test Date: 2024-02-06 **Tested By:** Bairong
EUT: Safe Audio Headphone **Model Number:** Buzz junior
Test Mode: 2DH5 TX 2480MHz **Power Supply:** Battery
Condition: Temp:23.4°C;Humi:62.3% **Test Site:** DDT 3# Chamber
File Path: d:\ts\2024 report data\Q24010331-3E\FCC ABOVE 1G\16
Memo: Sample Number:S24010331-012 Power Setting:10

Test Graph

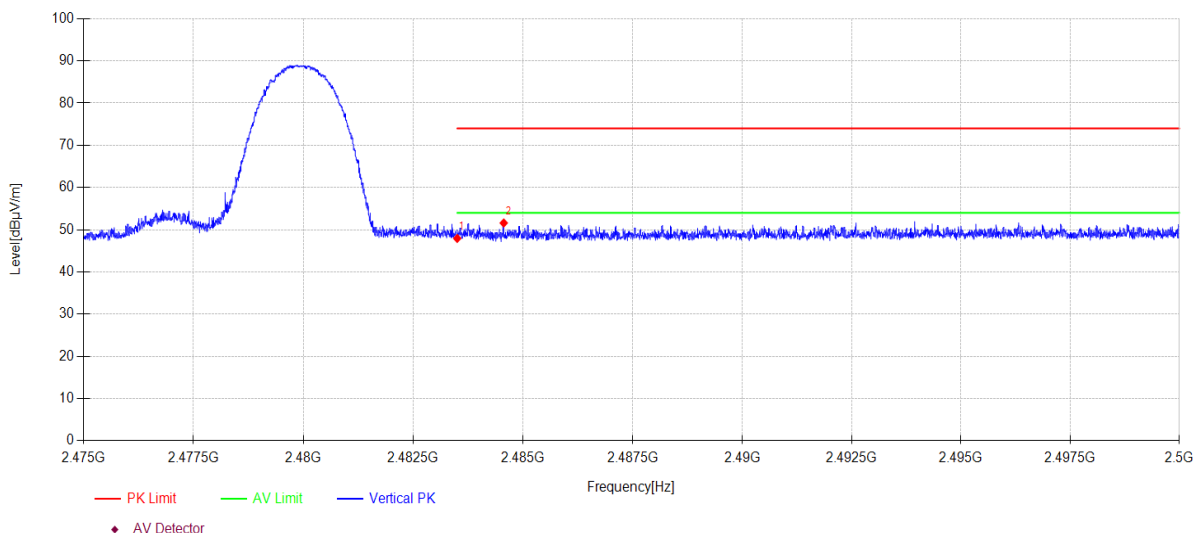

Data List										
NO	Freq. [MHz]	Reading [dBµV/m]	Antenna Factor [dB]	Cable loss [dB]	AMP [dB]	Level [dBµV/m]	Limit [dBµV/m]	Margin [dB]	Detector	Polarity
1	2483.50	16.47	27.53	3.94	0.00	47.94	74.00	26.06	PK	Vertical
2	2484.56	20.12	27.54	3.94	0.00	51.60	74.00	22.40	PK	Vertical

Note:

1. Level = Reading + Cable loss + Antenna Factor + AMP
2. If Peak Result complies with AV limit, AV Result is deemed to comply with AV limit.
3. Test setup: RBW: 1 MHz, VBW: 3 MHz, Sweep time: auto.

TR-4-E-009 Radiated Emission Test Result

Test Date: 2024-02-06 **Tested By:** Bairong
EUT: Safe Audio Headphone **Model Number:** Buzz junior
Test Mode: 3DH5 TX 2480MHz **Power Supply:** Battery
Condition: Temp:23.4°C;Humi:62.3% **Test Site:** DDT 3# Chamber
File Path: d:\ts\2024 report data\Q24010331-3E\FCC ABOVE 1G\17
Memo: Sample Number:S24010331-012 Power Setting:10

Test Graph

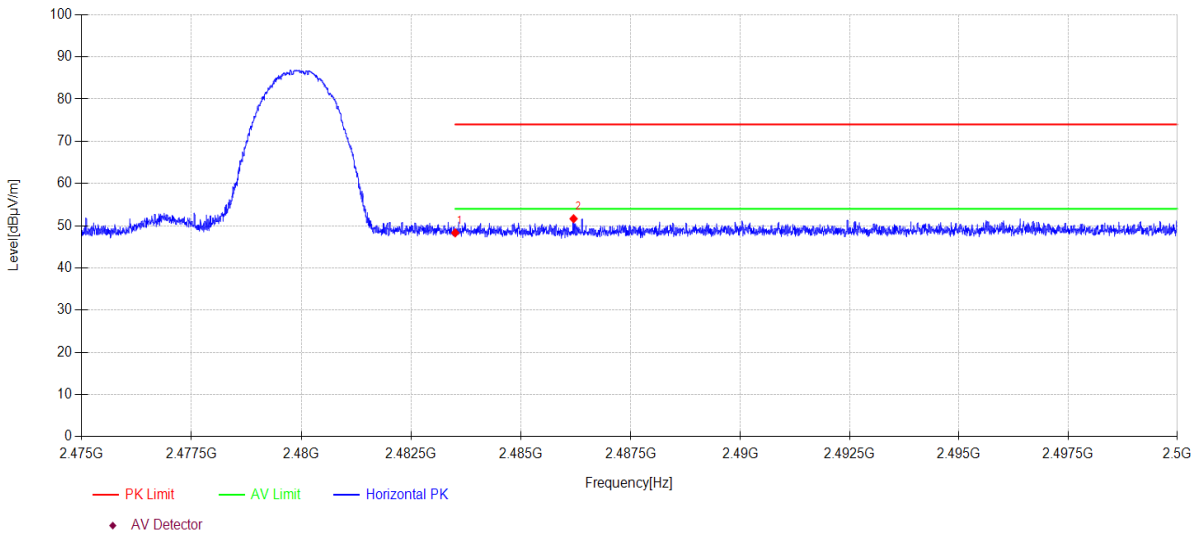

Data List										
NO	Freq. [MHz]	Reading [dBµV/m]	Antenna Factor [dB]	Cable loss [dB]	AMP [dB]	Level [dBµV/m]	Limit [dBµV/m]	Margin [dB]	Detector	Polarity
1	2483.50	16.84	27.53	3.94	0.00	48.31	74.00	25.69	PK	Horizontal
2	2486.20	20.18	27.54	3.94	0.00	51.66	74.00	22.34	PK	Horizontal

Note:

1. Level = Reading + Cable loss + Antenna Factor + AMP
2. If Peak Result complies with AV limit, AV Result is deemed to comply with AV limit.
3. Test setup: RBW: 1 MHz, VBW: 3 MHz, Sweep time: auto.

TR-4-E-009 Radiated Emission Test Result

Test Date: 2024-02-06 **Tested By:** Bairong
EUT: Safe Audio Headphone **Model Number:** Buzz junior
Test Mode: 3DH5 TX 2480MHz **Power Supply:** Battery
Condition: Temp:23.4°C;Humi:62.3% **Test Site:** DDT 3# Chamber
File Path: d:\ts\2024 report data\Q24010331-3E\FCC ABOVE 1G\18
Memo: Sample Number:S24010331-012 Power Setting:10

Test Graph

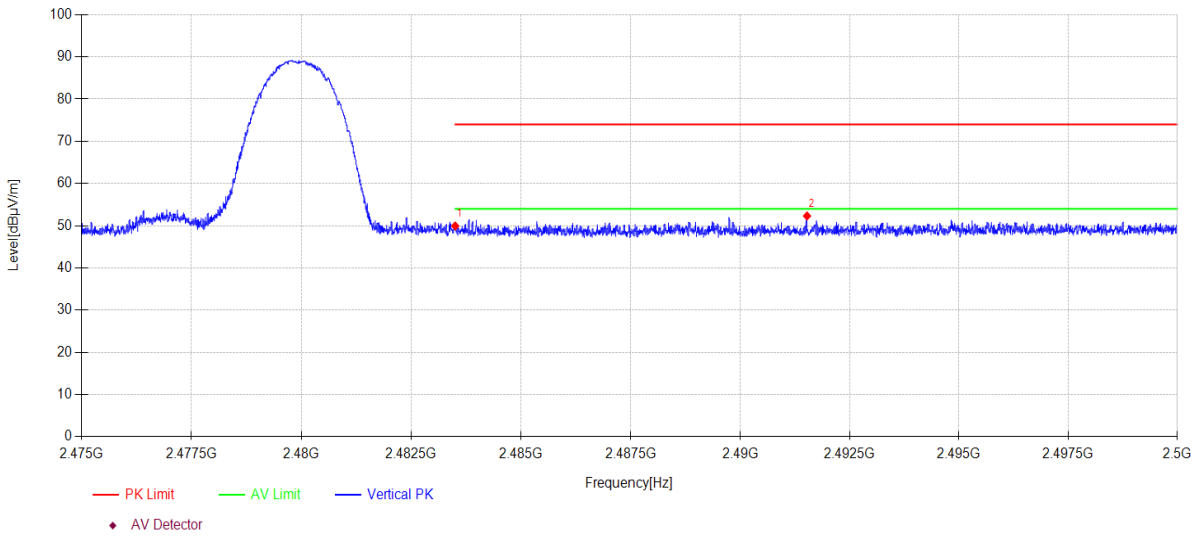

Data List										
NO	Freq. [MHz]	Reading [dBµV/m]	Antenna Factor [dB]	Cable loss [dB]	AMP [dB]	Level [dBµV/m]	Limit [dBµV/m]	Margin [dB]	Detector	Polarity
1	2483.50	18.46	27.53	3.94	0.00	49.93	74.00	24.07	PK	Vertical
2	2491.53	20.81	27.57	3.94	0.00	52.32	74.00	21.68	PK	Vertical

Note:

1. Level = Reading + Cable loss + Antenna Factor + AMP
2. If Peak Result complies with AV limit, AV Result is deemed to comply with AV limit.
3. Test setup: RBW: 1 MHz, VBW: 3 MHz, Sweep time: auto.

15. Power Line Conducted Emissions

15.1. Test equipment

Equipment	Manufacturer	Model No.	Serial No.	Cal Due To
Artificial mains	R&S	ESH2-Z5	DDT-ZC00538	2024/07/11
CE Cable 1	R&S	ESU8/RF2	DDT-ZC00566	2024/07/14
Pulse Limiter	SCHWARZBEC K	ESH3-Z2	DDT-ZC00539	2024/07/14
EMI Test Receiver	R&S	ESCI	DDT-ZC00235	2024/07/10
EMI Test Software	Audix/TW	e3	DDT-ZC01252	/
Two Line V-Network	R&S	ENV216	DDT-ZC00535	2024/07/10

15.2. Block diagram of test setup

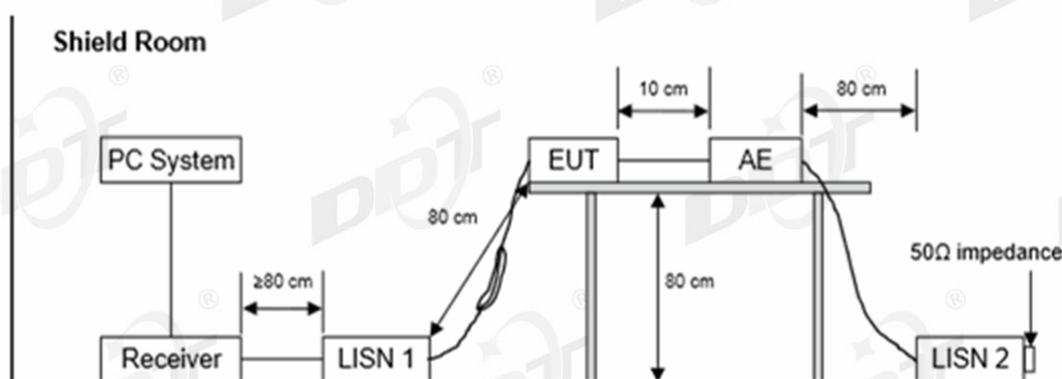

15.3. Limits

Frequency	Quasi-Peak Level dB(mV)	Average Level dB(mV)
150 kHz~500 kHz	66 ~ 56*	56 ~ 46*
500 kHz~5 MHz	56	46
5 MHz~30 MHz	60	50

Note 1: * Decreasing linearly with logarithm of frequency.

Note 2: The lower limit shall apply at the transition frequencies.

15.4. Assistant equipment used for test

Assistant equipment	Manufacturer	Model number	Description	other
Adapter	SOLUM VINA COMPANY LIMITED	EP-TA200	Input:100-240V 50-60Hz, 0.5A Output:9V/1.67A or 5V/2A	R37N4ER2G01 SE3
USB cable	N/A	N/A	N/A	N/A

15.5. Test procedure

The EUT and Support equipment, if needed, were put placed on a non-metallic table, 80cm above the ground plane.

All support equipment power received from a second LISN.

Emissions were measured on each current carrying line of the EUT using an EMI Test Receiver connected to the LISN powering the EUT.

The Receiver scanned from 150 kHz to 30 MHz for emissions in each of the test modes.

During the above scans, the emissions were maximized by cable manipulation.

The test mode(s) described in clause 2.4 were scanned during the preliminary test.

After the preliminary scan, we found the test mode producing the highest emission level.

The EUT configuration and worse cable configuration of the above highest emission levels were recorded for reference of the final test.

EUT and support equipment were set up on the test bench as per the configuration with highest emission level in the preliminary test.

A scan was taken on both power lines, Neutral and Line, recording at least the six highest emissions.

Emission frequency and amplitude were recorded into a computer in which correction factors were used to calculate the emission level and compare reading to the applicable limit.

The test data of the worst-case condition(s) was recorded.

The bandwidth of test receiver is set at 9 kHz.

15.6. Test result

PASS. (See below detailed test result)

Note1: All emissions not reported below are too low against the prescribed limits.

Note2: "----" means Peak detection; "----" means Average detection.

Note3: Pre-test AC conducted emission at both voltage AC 120V/60Hz and AC 240V/50Hz, recorded the worst case.

15.7. Test data

TR-4-E-010 Conducted Emission Test Result

Test Site	: DDT 1# Shield Room	D:\2024 CE report data\Q24010331-3E\FCC CE.EM6
Test Date	: 2024-02-20	Tested By : Bairong
EUT	: Safe Audio Headphone	Model Number : Buzz junior
Power Supply	: AC 120V/60Hz	Test Mode : BT mode
Condition	: TEMP:22.3°C, RH:56.5%	LISN : 2023 1# ENV216/NEUTRAL
Memo	: Sample Number:S24010331-012	

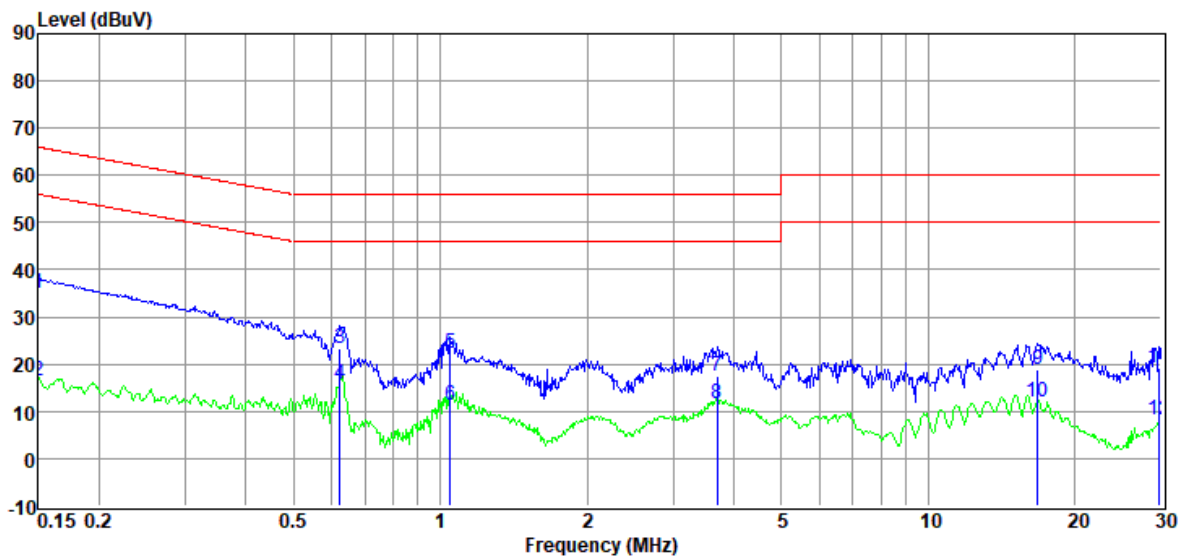

Item (Mark)	Freq. (MHz)	Read Level (dBμV)	LISN Factor (dB)	Cable Loss (dB)	Pulse Limiter Factor (dB)	Result Level (dBμV)	Limit Line (dBμV)	Over Limit (dB)	Detector	Phase
1	0.15	14.47	9.83	0.92	9.68	34.90	66.00	-31.10	QP	NEUTRAL
2	0.15	-4.11	9.83	0.92	9.68	16.32	56.00	-39.68	Average	NEUTRAL
3	0.62	2.96	9.83	0.81	9.72	23.32	56.00	-32.68	QP	NEUTRAL
4	0.62	-4.47	9.83	0.81	9.72	15.89	46.00	-30.11	Average	NEUTRAL
5	1.05	2.27	9.75	0.67	9.73	22.42	56.00	-33.58	QP	NEUTRAL
6	1.05	-8.85	9.75	0.67	9.73	11.30	46.00	-34.70	Average	NEUTRAL
7	3.70	-2.50	9.74	0.57	9.78	17.59	56.00	-38.41	QP	NEUTRAL
8	3.70	-8.30	9.74	0.57	9.78	11.79	46.00	-34.21	Average	NEUTRAL
9	16.75	-1.25	9.82	0.34	9.89	18.80	60.00	-41.20	QP	NEUTRAL
10	16.75	-8.09	9.82	0.34	9.89	11.96	50.00	-38.04	Average	NEUTRAL
11	29.68	-1.37	10.11	0.51	9.91	19.16	60.00	-40.84	QP	NEUTRAL
12	29.68	-12.47	10.11	0.51	9.91	8.06	50.00	-41.94	Average	NEUTRAL

Note:

1. Result Level = Read Level + LISN Factor + Pulse Limiter Factor + Cable loss.
2. If QP Result complies with AV limit, AV Result is deemed to comply with AV limit.
3. Test setup: RBW: 200 Hz (9 kHz—150 kHz), 9 kHz (150 kHz—30 MHz).
4. Step size: 80Hz (0.009MHz-0.15MHz), 4 kHz (0.15MHz-30MHz), Scan time: auto.

TR-4-E-010 Conducted Emission Test Result

Test Site : DDT 1# Shield Room D:\2024 CE report data\Q24010331-3E\FCC CE.EM6
Test Date : 2024-02-20 **Tested By** : Bairong
EUT : Safe Audio Headphone **Model Number** : Buzz junior
Power Supply : AC 120V/60Hz **Test Mode** : BT mode
Condition : TEMP:22.3°C, RH:56.5% **LISN** : 2023 1# ENV216/LINE
Memo : Sample Number:S24010331-012

Data: 4

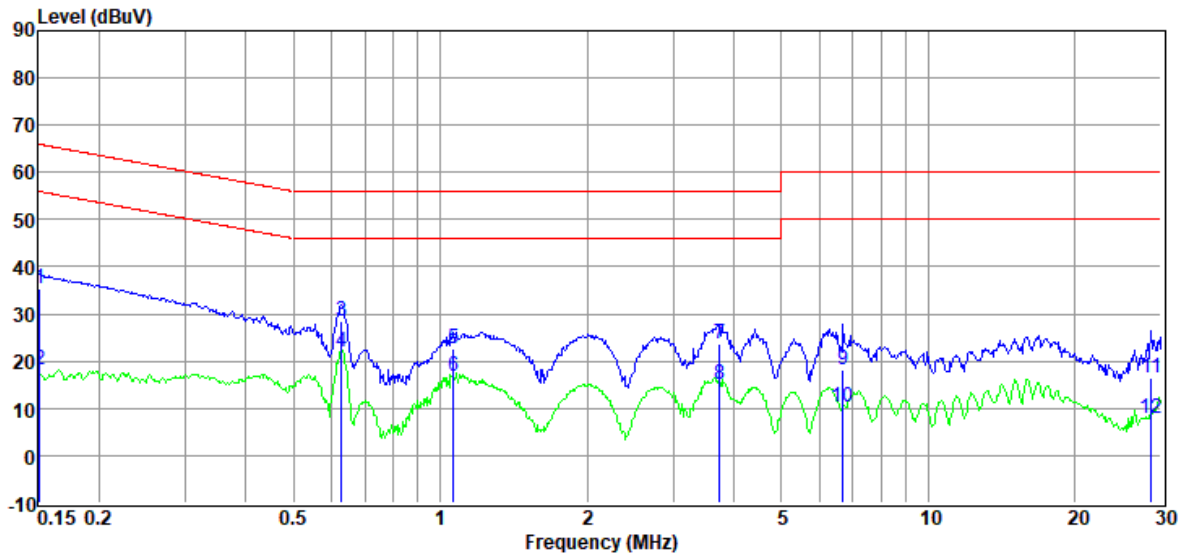

Item (Mark)	Freq. (MHz)	Read Level (dBuV)	LISN Factor (dB)	Cable Loss (dB)	Pulse Limiter Factor (dB)	Result Level (dBuV)	Limit Line (dBuV)	Over Limit (dB)	Detector	Phase
1	0.15	14.74	9.85	0.92	9.68	35.19	65.96	-30.77	QP	LINE
2	0.15	-2.32	9.85	0.92	9.68	18.13	55.96	-37.83	Average	LINE
3	0.63	8.01	9.78	0.81	9.72	28.32	56.00	-27.68	QP	LINE
4	0.63	1.69	9.78	0.81	9.72	22.00	46.00	-24.00	Average	LINE
5	1.07	2.73	9.65	0.67	9.73	22.78	56.00	-33.22	QP	LINE
6	1.07	-3.12	9.65	0.67	9.73	16.93	46.00	-29.07	Average	LINE
7	3.74	3.69	9.65	0.57	9.78	23.69	56.00	-32.31	QP	LINE
8	3.74	-4.76	9.65	0.57	9.78	15.24	46.00	-30.76	Average	LINE
9	6.70	-1.92	9.68	0.46	9.80	18.02	60.00	-41.98	QP	LINE
10	6.70	-9.83	9.68	0.46	9.80	10.11	50.00	-39.89	Average	LINE
11	28.60	-4.28	10.17	0.53	9.91	16.33	60.00	-43.67	QP	LINE
12	28.60	-12.77	10.17	0.53	9.91	7.84	50.00	-42.16	Average	LINE

Note:

1. Result Level = Read Level + LISN Factor + Pulse Limiter Factor + Cable loss.
2. If QP Result complies with AV limit, AV Result is deemed to comply with AV limit.
3. Test setup: RBW: 200 Hz (9 kHz—150 kHz), 9 kHz (150 kHz—30 MHz).
4. Step size: 80Hz (0.009MHz-0.15MHz), 4 kHz (0.15MHz-30MHz), Scan time: auto.

17. Photos of the EUT

Please refer to DDT-Q24010331-2E appendix I

-----End Report-----