

aMAJOR

Premium Bluetooth speaker

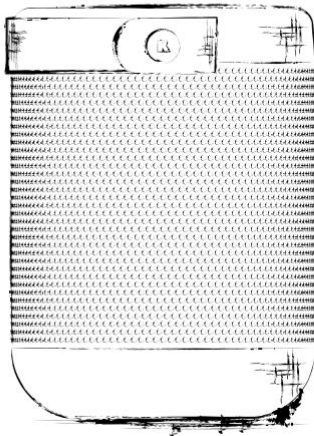

Operation manual
Bedienungshandbuch
Manual de instrucciones
Manuel d'utilisation
Brugermanual
Manuale operativo
操作手冊

**KREA
FUNK
EST.
2011**

KREAFUNK
kreafunk.com

English	4
Deutsch	18
Español	32
Français	46
Dansk	60
Italiano	74
Chinese 中文	88

This product is in compliance with the essential requirements and other relevant provisions of Directive 2014/53/EU.

The declaration of conformity may be consulted at:
www.kreafunk.com/declaration-of-conformity/



English

Operation manual

SAFETY AND MAINTENANCE INSTRUCTIONS

1. Please read this operation manual carefully before use.
2. The safety and maintenance instructions in this operation manual should be retained for future reference and must be followed at all times.
3. Keep the product away from heat sources such as radiators, heaters or other appliances that produce heat.
4. Do not expose the product to direct sunlight for longer periods. High temperatures will shorten the life of the product, destroy the battery and distort certain plastic parts.
5. Do not expose the product to extreme cold as it may damage the internal circuit board.
6. Avoid liquids getting into the product.
7. Do not throw with or stamp on the product. This may damage the internal circuit board.
8. Do not try to disassemble the product. This must only be done by a professional.
9. Do not use concentrated chemical products or detergent to clean the product.
10. Keep the surface away from sharp things, as these may cause damage to the plastic parts.
11. Use 5V / 1A power supplies only. The connection of power supplies with higher voltage may lead to severe damage.
12. Do not arbitrarily discard or place the lithium battery near fire or intense heat in order to avoid a risk of explosion.

Leaving a battery in an extremely high temperature surrounding environment that can result in an explosion or the leakage of flammable liquid or gas. A battery subjected to extremely low air pressure that may result in an explosion or the leakage of flammable liquid or gas.

13. The max. operation temperature: 45°C

If you do experience any problems with your product please contact the retailer you purchased the product from. The retailer will provide you with guidance and if that does not solve the problem the retailer will handle the claim directly with KREAFUNK.

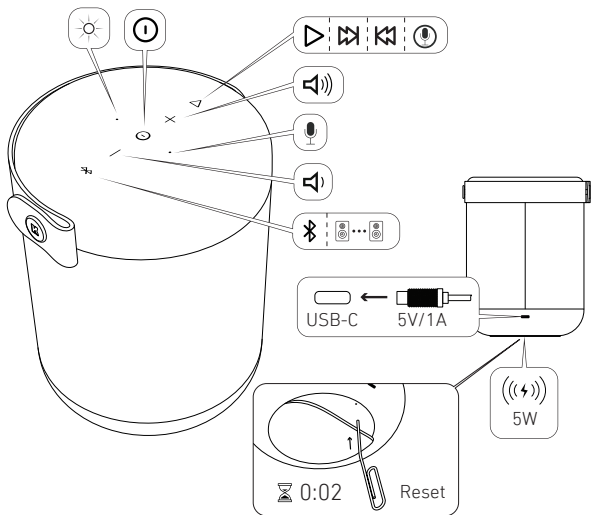

BLUETOOTH® PAIRING

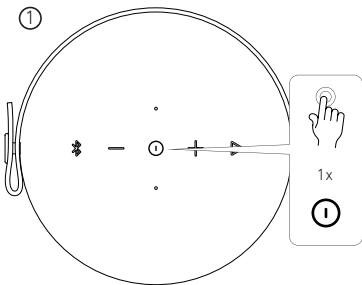

Press the ON/OFF button to turn aMAJOR on. The LED indicator will light up white and a sound prompt is heard.

2

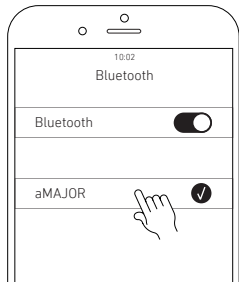

When the LED indicator on aMAJOR starts flashing white, make sure Bluetooth on your device is turned on. Find the list of visible / connected units on your device and select "aMAJOR". The LED indicator will turn solid white, a sound prompt is heard and aMAJOR is ready to play.

MANUAL BLUETOOTH® PAIRING MODE

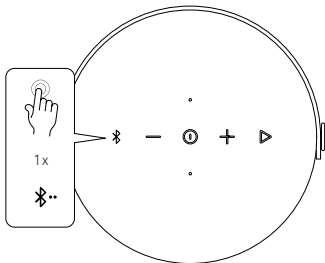

aMAJOR will always re-connect to last connected device, when turned on. If you wish to connect a new device, you can manually activate Bluetooth® pairing mode:

Press the Bluetooth button to activate Bluetooth pairing mode. The LED indicator will flash white and you can now pair aMAJOR with a new device. You can have up to 2 devices paired with aMAJOR simultaneously.

MULTI-FUNCTIONS

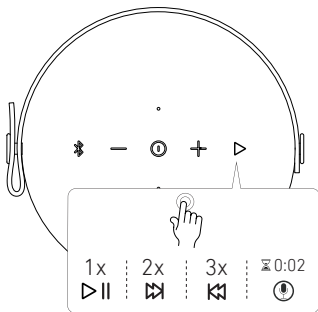

BATTERY AND CHARGING

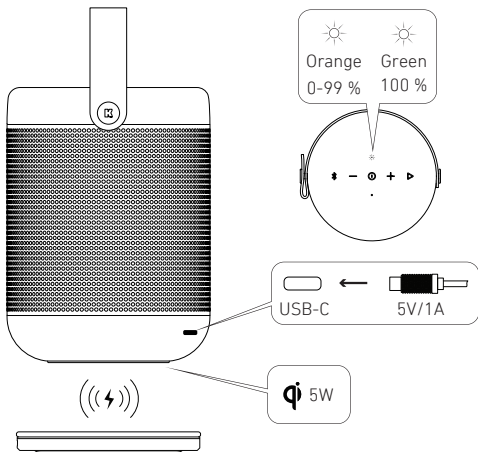

CHARGING















Charging time is approximately 6 hours using the included USB cable. The LED indicator turns solid orange when charging. The LED indicator turns solid green when the battery is fully charged.

WIRELESS CHARGING

aMAJOR can be charged via the USB-C input or by being placed on a Qi® certified wireless charging pad. When aMAJOR is charging correctly, the LED indicator will turn solid orange. When the battery is fully charged, the LED indicator will turn solid green until aMAJOR is removed from the Qi® certified charging pad or the charging cable is unplugged.

Charging time on a Qi® certified charging pad is approximately 14 hours.

BATTERY STATUS

	LED		Battery Status
White			 15-100 %
Red			 <15 %
Flashing Red			 <10 %
Orange			  0-99 %
Green			  100 %

When the battery level is below 15%, the LED indicator turns solid red. When the battery level is below 10%, the LED indicator flashes red. aMAJOR will automatically switch off when not in use for 60 minutes.

TRUE WIRELESS STEREO PAIRING

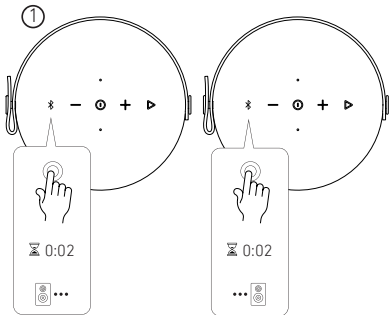

aMAJOR can pair with another aMAJOR and play in True Wireless Stereo (TWS).

Turn on both aMAJORs. Simultaneously, press and hold the Bluetooth button on both speakers for 2 seconds to activate TWS pairing mode. The LED indicator on both speakers now flashes purple.

②

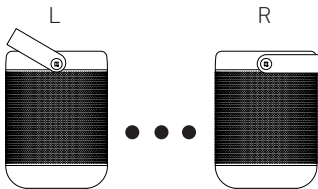

The two aMAJORs will automatically pair, the LED indicator will turn solid white on both speakers and a sound prompt will be heard.

Make sure your device is paired to one of your aMAJORs. You are now ready to play in True Wireless Stereo.

The two aMAJORs will automatically reconnect in TWS mode when both speakers are turned on, until TWS pairing mode is manually activated again on one of the speakers.

VOICE ASSISTANT FUNCTION

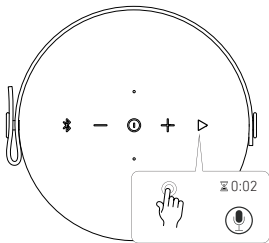

You can use your device's Voice Assistant through the built-in microphone on aMAJOR. Activate your Voice Assistant by pressing and holding the Play button for 2 seconds. The LED indicator will flash white and the built-in microphone will pick up your voice commands.

When having two aMAJORs playing in TWS mode, only one aMAJOR can activate the microphone for Voice Assistant. When activating your Voice Assistant, the LED indicator will flash white on the speaker that listens to your commands.

Deutsch

Bedienungshandbuch

SICHERHEITS- UND WARTUNGSANLEITUNG

1. Bitte lesen Sie diese Bedienungsanleitung vor dem Gebrauch sorgfältig durch.
2. Die Sicherheits- und Wartungsanweisungen dieser Bedienungsanleitung sollten für zukünftige Bezugnahme aufbewahrt werden und müssen jederzeit befolgt werden.
3. Halten Sie das Produkt von Wärmequellen wie Heizkörpern, Heizgeräten oder anderen Wärme erzeugenden Geräten fern.
4. Setzen Sie das Produkt nicht für längere Zeit direktem Sonnenlicht aus. Hohe Temperaturen verkürzen die Lebensdauer des Produkts, zerstören die Batterie und verformen bestimmte Kunststoffteile.
5. Setzen Sie das Produkt nicht extremer Kälte aus, da dies die interne Leiterplatte beschädigen kann.
6. Vermeiden Sie, dass Flüssigkeiten in das Produkt gelangen.
7. Nicht das Produkt werfen oder auf das Produkt draufstellen. Dies könnte den internen Schaltkreis beschädigen.
8. Versuchen Sie nicht, das Produkt zu zerlegen. Dies darf nur von einem Fachmann durchgeführt werden.
9. Verwenden Sie keine konzentrierten chemischen Produkte oder Reinigungsmittel, um das Produkt zu reinigen.
10. Halten Sie die Oberfläche von scharfen Gegenständen fern, da diese das Kunststoff beschädigen können.
11. Verwenden Sie nur 5 V/1 A-Netzteile. Der Anschluss von Netzteilen mit höherer Spannung kann zu folgenschweren Schäden führen.
12. Werfen oder legen Sie die Lithiumbatterie nicht willkürlich in die Nähe von Feuer oder starker Hitze, um eine Explosion zu vermeiden.

Wenn Sie Probleme mit Ihrem Produkt haben, wenden Sie sich bitte an den Händler, bei dem Sie den Produkt gekauft haben. Der Händler wird Sie beraten und wenn dies das Problem nicht löst, wird der Händler die Reklamation direkt mit KREAFUNK abwickeln.

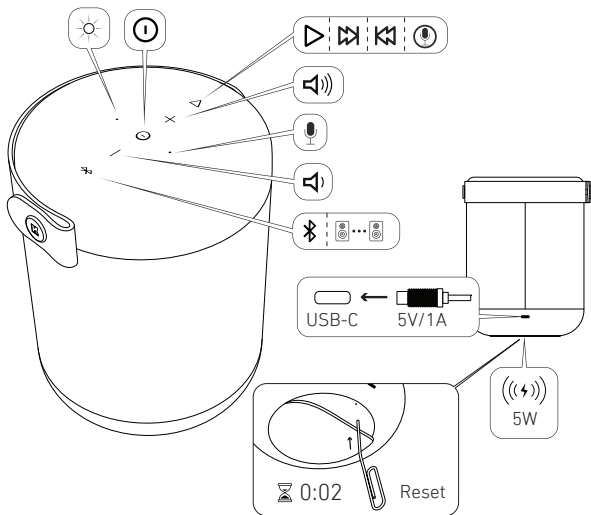

BLUETOOTH®-KOPPLUNG

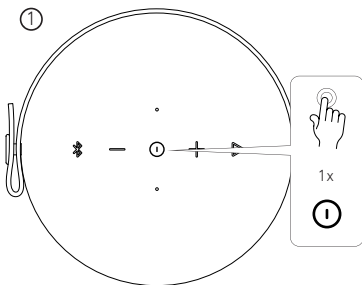

Drücken Sie die EIN / AUS-Taste, um aMAJOR einzuschalten. Die LED-Anzeige leuchtet weiß und Sie hören einen Sound.

②

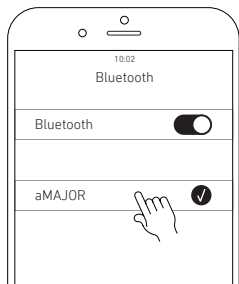

Wenn die LED-Anzeige von aMAJOR weiß zu blinken beginnt, vergewissern Sie sich, dass Sie Bluetooth auf Ihrem Gerät aktiviert haben. Öffnen Sie auf Ihrem Gerät die Liste der sichtbaren/verbundenen Geräte und wählen Sie „aMAJOR“. Die LED-Anzeige leuchtet durchgehend weiß, es ertönt ein Sound und aMAJOR kann loslegen.

MANUELLER BLUETOOTH®-KOPPLUNGSMODUS

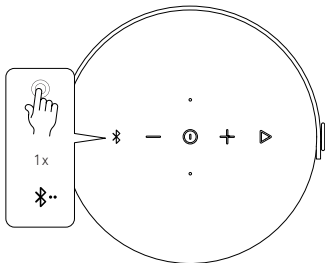

aMAJOR stellt beim Einschalten immer die Verbindung zum zuletzt verbundenen Gerät wieder her. Wenn Sie ein neues Gerät anschließen möchten, können Sie den Bluetooth®-Pairing-Modus manuell aktivieren:

Drücken Sie die Bluetooth-Taste, um den Bluetooth-Pairing-Modus zu aktivieren. Die LED-Anzeige blinkt weiß und Sie können jetzt ein neues Gerät mit einem aMAJOR koppeln. Sie können bis zu 2 Geräte gleichzeitig mit aMAJOR koppeln.

MULTI-FUNKTIONEN

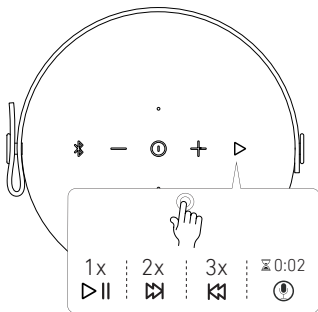

AKKU UND AUFLADEN

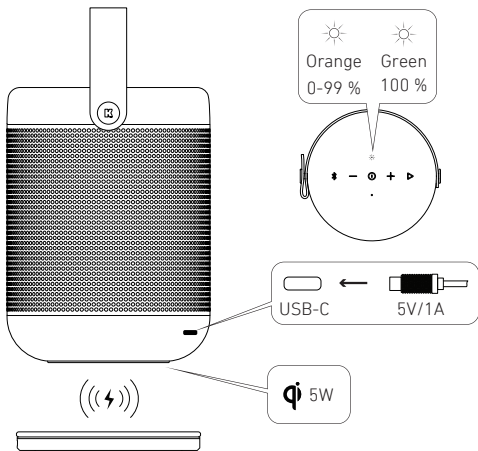

AUFLADEN















Die Ladezeit beträgt mit dem mitgelieferten USB-Kabel ca. 6 Stunden. Die LED-Anzeige leuchtet beim Laden durchgehend orange. Die LED-Leuchte wechselt auf grün, wenn der Akku vollständig geladen ist

KABELLOSES LADEN

aMAJOR kann über den USB-C-Eingang oder über ein Qi®-zertifiziertes kabelloses Ladegerät aufgeladen werden. Wenn aMAJOR korrekt geladen wird, leuchtet die LED-Anzeige durchgehend orange. Wenn der Akku vollständig aufgeladen ist, leuchtet die LED-Anzeige durchgehend grün, bis aMAJOR von der Qi®-zertifizierten Ladeschale entfernt oder das Ladekabel abgezogen wird.

Die Ladezeit auf einem Qi®-zertifizierten Ladegerät beträgt ca. 14 Stunden.

LADESTANDSANZEIGE

	LED		Batteriestatus
Weiß			 15-100 %
Rot			 <15 %
Rot blinkend			 <10 %
Orange			  0-99 %
Grün			  100 %

Wenn der Akku bei unter 15 % liegt, leuchtet die LED-Anzeige durchgehend rot. Wenn der Akku bei unter 10 % liegt, blinkt die LED-Anzeige rot. aMAJOR schaltet sich bei Inaktivität nach 60 Minuten aus.

TRUE WIRELESS STEREO-KOPPLUNG

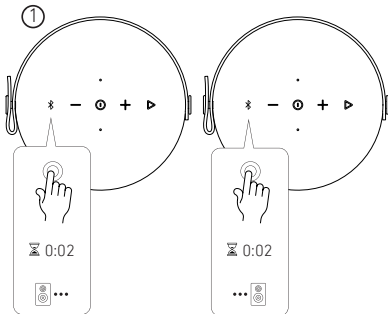

aMAJOR kann mit einem anderen aMAJOR gekoppelt werden und Musik in True Wireless Stereo (TWS) wiedergeben.

Schalten Sie beide aMAJORs ein. Halten Sie gleichzeitig die Bluetooth-Taste an beiden Lautsprechern 2 Sekunden lang gedrückt, um den TWS-Kopplungsmodus zu aktivieren. Die LED-Anzeige an beiden Lautsprechern blinkt nun lila.

②

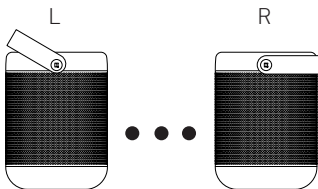

Die beiden aMAJORs werden automatisch gekoppelt, die LED-Anzeige an beiden Lautsprechern leuchtet weiß und es ertönt ein akustisches Signal.

Vergewissern Sie sich, dass Ihr Gerät mit einem Ihrer aMAJORs gekoppelt ist. Sie können jetzt Ihre Musik in True Wireless Stereo abspielen.

Bis der TWS-Pairing-Modus an einem der Lautsprecher manuell aktiviert wird bleiben die beiden aMAJORs automatisch im TWS-Modus.

VOICE ASSISTANT-FUNKTION

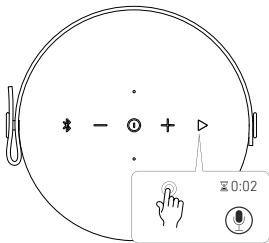

Sie können den Voice Assistant Ihres Geräts über das eingebaute aMAJOR-Mikrofon verwenden. Aktivieren Sie Ihren Voice Assistant, indem Sie die Wiedergabetaste 2 Sekunden lang gedrückt halten. Die LED-Anzeige blinkt weiß und das eingebaute Mikrofon nimmt Ihre Sprachbefehle auf.

Wenn zwei aMAJORS im TWS-Modus abspielen, kann nur ein aMAJOR das Mikrofon für Voice Assistant aktivieren. Wenn Sie Ihren Voice Assistant aktivieren, blinkt die LED-Anzeige auf dem Lautsprecher, der Ihre Sprachbefehle hört, weiß.

Español

Manual de instrucciones

INSTRUCCIONES DE SEGURIDAD Y MANTENIMIENTO

1. Por favor lea con atención este manual de funcionamiento antes del uso.
2. Conserve las instrucciones de seguridad y mantenimiento de este manual para consultarlas en el futuro y sígalas en todo momento.
3. Mantenga el producto alejado de fuentes de calor como radiadores, calentadores y otros aparatos que produzcan calor.
4. No exponga el producto a la luz solar directa por periodos largos. Las altas temperaturas acortarán la vida útil del producto, destruirán la batería y deformarán ciertas partes plásticas.
5. No exponga el producto al frío extremo, ya que puede dañar la placa de circuito interna.
6. Evite que el producto entre en contacto con líquidos.
7. No arroje ni pise el producto. Esto puede dañar la placa de circuito interna.
8. No intente desarmar el producto. Esto solo lo puede hacer un profesional.
9. No use productos químicos concentrados o detergentes para limpiar el producto
10. Mantenga la superficie alejada de objetos filosos, ya que pueden dañar las partes plásticas.
11. Utilice únicamente fuentes de alimentación de 5V / 1A. La conexión a fuentes de alimentación con voltaje más alto puede provocar daños graves.
12. Para evitar el riesgo de explosión, no deseché ni coloque arbitrariamente la batería de litio cerca del fuego o del calor intenso.

Si tiene cualquier problema con su producto, póngase en contacto con la tienda donde compró el producto. La tienda minorista le orientará sobre lo que debe hacer, y si eso no resuelve el problema, la tienda minorista manejará el reclamo directamente con KREAFUNK.

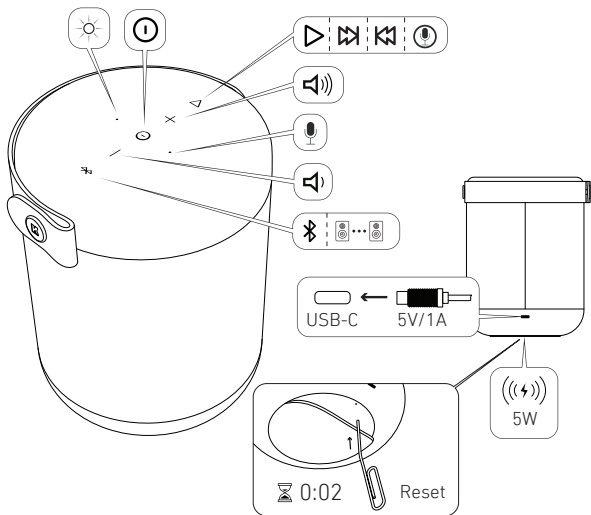

CONEXIÓN CON BLUETOOTH®

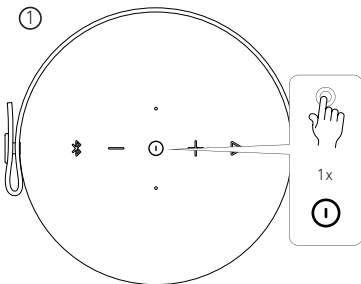

Presione el botón ON / OFF para encender aMAJOR. El indicador LED se iluminará en blanco y se escuchará un sonido de aviso.

2

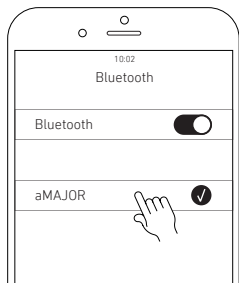

Cuando el indicador LED del aMAJOR comience a parpadear en blanco, asegúrese de que la función Bluetooth de su dispositivo esté activada. Busque la lista de equipos visibles / conectados en su dispositivo y seleccione "aMAJOR". El indicador LED se pondrá blanco, se escuchará un sonido de aviso y el aMAJOR estará listo para usar.

ACTIVAR MANUALMENTE EL MODO DE CONEXIÓN CON BLUETOOTH®

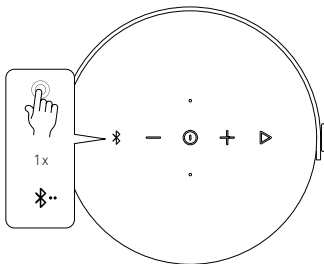

El aMAJOR siempre se volverá a conectar con el dispositivo con el que se conectó la última vez, cuando lo encienda. Si desea conectarlo a un dispositivo nuevo, puede activar manualmente el modo de conexión con Bluetooth®:

Presione el botón Bluetooth para activar el modo de emparejamiento de Bluetooth. El indicador LED parpadeará en blanco y ahora puede emparejar aMAJOR con un nuevo dispositivo. Puede tener hasta 2 dispositivos emparejados con aMAJOR imultáneamente.

MULTIFUNCIONES

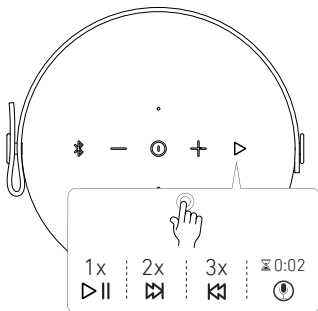

BATERÍA Y CARGA

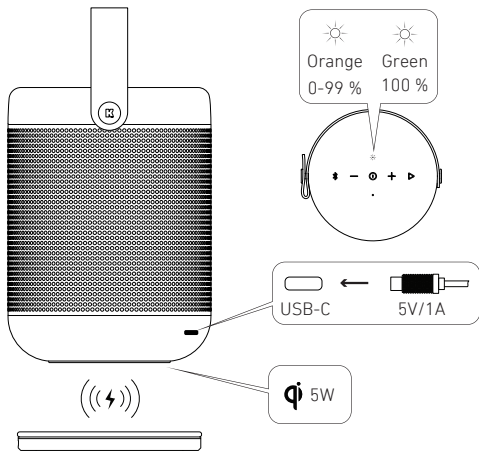

CARGA













El proceso de carga dura aproximadamente 6 horas, usando el cable USB que viene incluido. El indicador LED se pondrá naranja durante el proceso de carga. El indicador LED se pondrá verde cuando la batería esté completamente cargada.

CARGA INALÁMBRICA

El aMAJOR se puede cargar a través de una entrada USB-C o poniéndolo sobre una base de carga inalámbrica Qi® certificada. Cuando el aMAJOR se está cargando correctamente, el indicador LED se pondrá naranja. Cuando la batería esté completamente cargada, el indicador LED se pondrá verde hasta que lo retire de la base de carga Qi® certificada o desconecte el cable de carga.

El tiempo de carga en una plataforma de carga certificada Qi® es de aproximadamente 14 horas.

ESTADO DE LA BATERÍA

	LED		Estado de la batería
Blanco			15-100 %
Rojo			<15 %
Rojo intermitente			<10 %
Naranja	 		0-99 %
Verde	 		100 %

Si el nivel de carga de la batería es inferior al 15%, el indicador LED se pone rojo.

Cuando es inferior al 10%, el indicador LED comienza a parpadear en rojo.

El aMAJOR se apagará automáticamente cuando no se use por 60 minutos.

CONEXIÓN CON EL SISTEMA TRUE WIRELESS STEREO

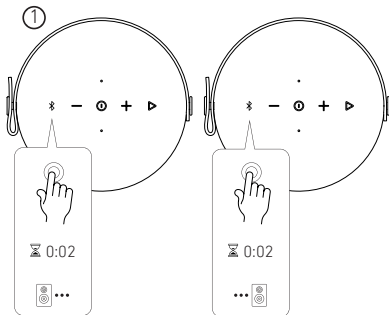

El aMAJOR puede conectarse con otro aMAJOR y reproducir sonido con el sistema True Wireless Stereo (TWS).

Encienda ambos aMAJORs. Al mismo tiempo, mantenga presionado el botón de Bluetooth de ambos altavoces durante dos segundos para activar el modo de conexión del sistema TWS. El indicador LED en ambos altavoces ahora parpadeará en púrpura.

②

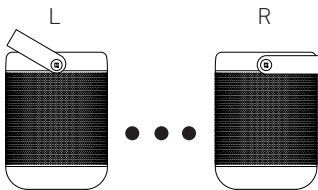

Los dos aMAJORs se conectarán automáticamente entre ellos, el indicador LED se pondrá blanco en ambos altavoces y se escuchará un sonido de aviso.

Asegúrese de que su dispositivo esté conectado a uno de sus aMAJORs. Ahora está listo para reproducir sonido en el sistema True Wireless Stereo.

Los dos aMAJORs se volverán a conectar automáticamente en el modo TWS cuando ambos estén encendidos, hasta que vuelva a activar manualmente el modo de conexión del sistema TWS en uno de los altavoces.

FUNCIÓN DE ASISTENTE DE VOZ

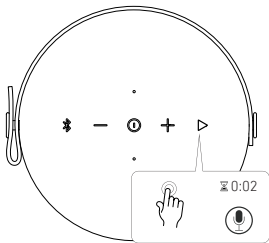

Puede usar la función de asistente de voz de su dispositivo a través del micrófono integrado en su aMAJOR. Active el asistente de voz manteniendo presionado el botón de reproducción durante dos segundos. El indicador LED parpadeará en blanco y el micrófono integrado captará sus comandos de voz.

Cuando tenga dos aMAJORS reproduciendo sonido en modo TWS, solo puede activar el micrófono para el asistente de voz en uno de los aMAJORS. Cuando active su asistente de voz, el indicador LED parpadeará en blanco en el altavoz que escucha sus comandos de voz.

Français

Manuel d'utilisation

CONSIGNES DE SECURITE ET D'ENTRETIEN

1. Veuillez lire attentivement ce manuel d'utilisation avant d'utiliser l'appareil.
2. Les instructions de sécurité et d'entretien de ce manuel d'utilisation doivent être conservées pour toute référence ultérieure et doivent être suivies en toutes circonstances.
3. Eloignez le produit des sources de chaleur telles que les radiateurs ou tout autre appareil produisant de la chaleur.
4. N'exposez pas le produit à la lumière directe du soleil pendant une période prolongée. Les températures élevées peuvent réduire la durée de vie du produit, détruire la batterie et déformer certaines pièces en plastique.
5. N'exposez pas le produit à des températures extrêmement froides car cela pourrait endommager le circuit imprimé interne.
6. Évitez que des liquides ne pénètrent dans l'appareil.
7. Ne jetez pas l'appareil et ne montez pas dessus. Cela pourrait endommager le circuit imprimé interne.
8. N'essayez pas de démonter l'appareil. Seul un professionnel est habilité à le faire.
9. N'utilisez pas de produits chimiques concentrés ni de détergent pour nettoyer le produit.
10. Gardez la surface à l'écart des objets coupants, car ils pourraient endommager les pièces en plastique.
11. Utilisez uniquement des alimentations 5V/1A. Le connecter à des blocs d'alimentation produisant une tension plus élevée peut entraîner de graves dommages.
12. Ne jetez pas et ne placez pas la batterie au lithium à proximité de flammes ou d'une chaleur intense afin d'éviter tout risque d'explosion.

Si vous rencontrez des problèmes avec votre produit, veuillez contacter le revendeur auprès duquel vous avez l'avez acheté. Le revendeur vous guidera pour régler le problème ou traitera la réclamation directement avec KREAFUNK.

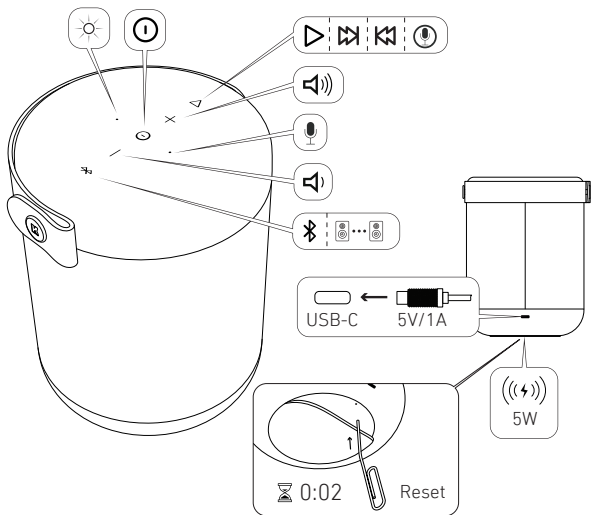

JUMELAGE BLUETOOTH®

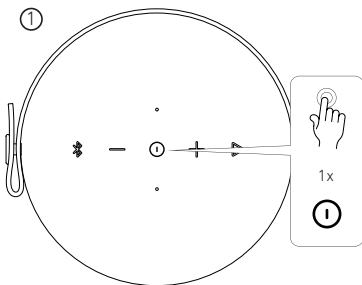

Appuyez sur le bouton ON / OFF pour activer aMAJOR. Le voyant LED devient blanc et un signal sonore se fait entendre.

②

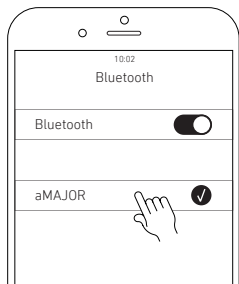

Lorsque le voyant LED blanc du aMAJOR commence à clignoter, assurez-vous que la fonction Bluetooth de votre appareil est activée. Trouvez la liste des appareils visibles / connectés sur votre appareil et sélectionnez "aMAJOR". Le voyant LED devient blanc et ne clignote plus, un signal sonore se fait entendre et aMAJOR est prêt à lancer une piste audio.

MODE DE JUMELAGE BLUETOOTH® MANUEL

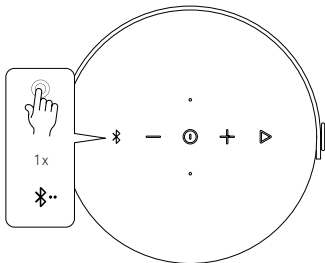

Le aMAJOR se reconnectera toujours au dernier appareil connecté lorsqu'il est allumé. Si vous souhaitez jumeler un nouvel appareil, vous pouvez activer manuellement le mode de jumelage Bluetooth® :

Appuyez sur le bouton Bluetooth pour activer le mode de couplage Bluetooth. Le voyant LED clignote en blanc et vous pouvez maintenant associer un aMAJOR à un nouvel appareil. Vous pouvez associer jusqu'à 2 appareils simultanément à un aMAJOR.

MULTI-FONCTIONS

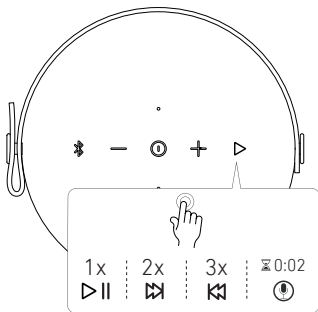

BATTERIE ET CHARGE

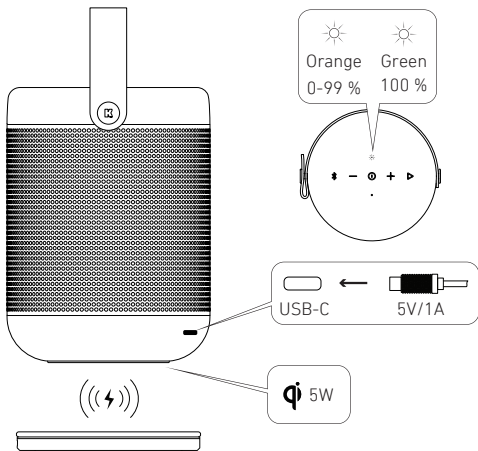

CHARGEMENT















La durée de charge est d'environ 6 heures à l'aide du câble USB fourni. Le voyant LED devient orange fixe lors de la charge. Le voyant LED devient vert fixe lorsque la batterie est complètement chargée.

CHARGEMENT SANS FIL

Le aMAJOR peut être rechargé via l'entrée USB-C ou en étant placé sur un chargeur sans fil certifié Qi®. Lorsque aMAJOR se recharge correctement, le voyant LED devient orange fixe. Lorsque la batterie est complètement chargée, l'indicateur LED devient vert fixe jusqu'à ce que aMAJOR soit retiré du chargeur à induction certifiée Qi® ou que le câble de chargement soit débranché.

La durée de charge sur un chargeur certifié Qi® est d'environ 14 heures.

ÉTAT DE LA BATTERIE

	LED		Battery Status
Blanc			 15-100 %
Rouge			 <15 %
Rouge clignotant			 <10 %
Orange	 		 0-99 %
Vert	 		 100 %

Lorsque le niveau de la batterie est inférieur à 15 %, le voyant LED devient rouge fixe. Lorsque le niveau de la batterie est inférieur à 10%, le voyant LED clignote en rouge.

Le aMAJOR s'éteint automatiquement lorsqu'il n'est pas utilisé pendant 60 minutes.

JUMELAGE STÉRÉO SANS FIL

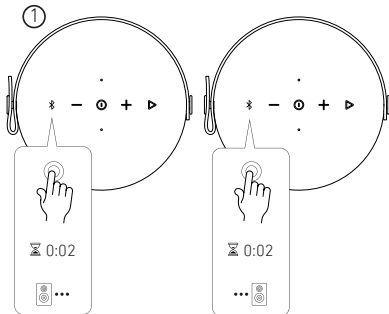

aMAJOR peut être jumelé à un autre aMAJOR et fonctionner en stéréo True Wireless Stereo (TWS).

Allumez les deux aMAJOR. Appuyez simultanément sur la touche Bluetooth des deux haut-parleurs et maintenez-la enfoncée pendant 2 secondes pour activer le mode de jumelage TWS. Le voyant LED violet des deux enceintes clignote.

②

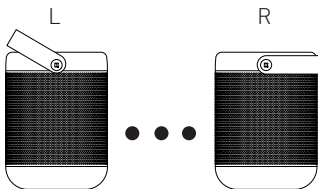

Les deux aMAJORs se jumèlent automatiquement, le voyant LED devient blanc fixe sur les deux enceintes et un signal sonore se fait entendre.

Assurez-vous que votre appareil est jumelé à l'un de vos aMAJORs. Vous êtes maintenant prêt à lancer une piste audio avec le True Wireless Stereo.

Les deux aMAJORs se reconnecteront automatiquement en mode TWS lorsque les deux enceintes sont activées, jusqu'à ce que le mode de jumelage TWS soit à nouveau activé manuellement sur une des enceintes.

FONCTION ASSISTANT VOCAL

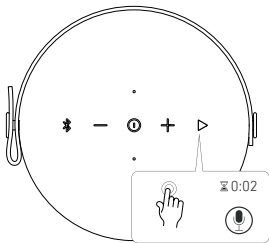

Vous pouvez utiliser l'Assistant vocal de votre appareil via le micro intégré sur aMAJOR. Activez votre assistant vocal en maintenant enfoncé le bouton Play pendant 2 secondes. Le voyant LED blanc clignotera et le micro intégré captera vos commandes vocales.

Lorsque deux aMAJORS jouent en mode TWS, un seul aMAJOR peut activer le micro de l'assistant vocal. Lorsque vous activez votre assistant vocal, le voyant LED blanc clignote sur l'enceinte qui capte vos commandes.

Dansk

Brugermanual

SIKKERHEDS- OG VEDLIGHOLDELSSESINSTRUKTIONER

1. Læs venligst denne brugsvejledning omhyggeligt før brug.
2. Sikkerheds- og vedligeholdelsesinstruktionerne i denne brugsvejledning skal opbevares til senere brug og skal altid følges.
3. Hold produktet væk fra varmekilder såsom radiatorer, kedler eller andre apparater der producerer varme.
4. Udsæt ikke produktet for direkte sollys over længere perioder. Høje temperaturer vil forkorte produktets levetid, ødelægge batteriet og forvride visse plastdele.
5. Udsæt ikke produktet for ekstrem kulde, da det kan beskadige det interne printplade.
6. Undgå væsker kommer ind i produktet.
7. Kast ikke med eller trød på produktet. Dette kan beskadige det interne printplade.
8. Prøv ikke at adskille produktet. Dette må kun gøres af en professionel.
9. Brug ikke koncentrerede kemiske produkter eller rengøringsmidler til at rengøre produktet.
10. Hold overfladen væk fra skarpe ting, da disse kan skade plastdelene.
11. Brug kun 5V / 1A strømforsyninger. Tilslutning af strømforsyninger med højere spænding kan medføre alvorlig skade.
12. Placer eller læg ikke batteriet vilkårligt nær ild eller intens varme for at undgå eksplosionsfare.

Hvis du oplever nogen problemer med dit produkt, bedes du kontakte den forhandler du købte produktet hos. Forhandleren vil give dig vejledning og hvis dette ikke løser problemet, vil forhandleren håndtere kravet direkte med KREAFUNK.

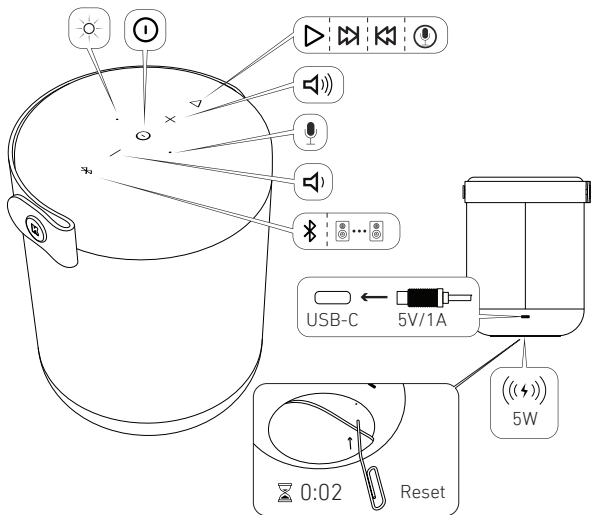

BLUETOOTH® FORBINDELSE

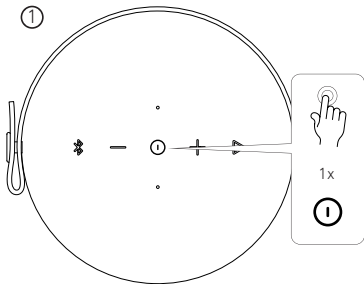

Tryk på tænd / sluk-knappen for at aktivere aMAJOR. LED-indikatoren lyser hvidt, og der høres en lydprompt.

②

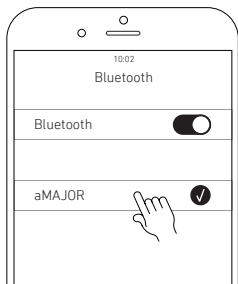

Når LED-indikatoren på aMAJOR begynder at blinke hvid, skal du sørge for, at Bluetooth på din enhed er tændt. Find listen over synlige/tilsluttede enheder på din enhed og vælg "aMAJOR". LED-indikatoren bliver solid hvid, der høres en lydprompt og aMAJOR er klar til afspilning.

MANUEL BLUETOOTH® FORBINDELSESTILSTAND

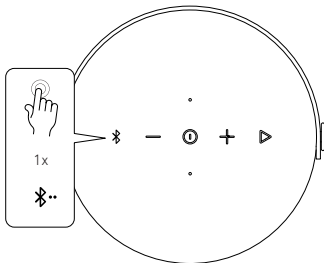

aMAJOR vil altid forbinde til den sidst tilsluttede enhed, når den er tændt. Hvis du ønsker at oprette forbindelse til en ny enhed, kan du manuelt aktivere Bluetooth® forbindelsestilstand:

Tryk på Bluetooth-knappen for at aktivere Bluetooth-parringstilstand. LEDindikatoren blinker hvidt, og du kan nu parre aMAJOR med en ny enhed. Du kan have op til 2 enheder parret med aMAJOR på samme tid.

MULTI-FUNKTIONER

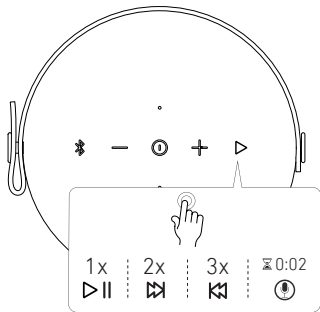

BATTERI OG OPLADNING

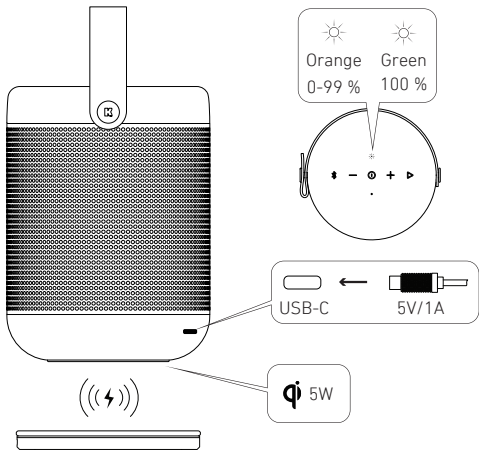















OPLADNING

Opladningstiden er omkring 6 timer ved brug af det inkluderede USB-kabel. LED-indikatoren skifter til orange, når den oplades. LED-indikatoren skifter til grøn, når batteriet er fuldt opladt.

TRÅDLØS OPLADNING

aMAJOR kan oplades via USB-C-indgangen eller ved at blive placeret på en Qi®-certificeret trådløs opladningsplade. Når aMAJOR oplader korrekt, lyser LED-indikatoren solid orange. Når batteriet er fuldt opladt, lyser LED-indikatoren solid grønt, indtil aMAJOR fjernes fra den Qi®-certificerede opladningsplade, eller opladningskablet trækkes ud. Opladningstid med en Qi®-certificeret trådløs oplader er ca. 14 timer.

BATTERISTATUS

	LED		Batteristatus
Hvid			 15-100 %
Rød			 <15 %
Blinker rødt			 <10 %
Orange	 		 0-99 %
Grøn	 		 100 %

Når batteriniveauet er under 15%, skifter LED-indikatoren til rød. Når batteriniveauet er under 10%, blinker LED-indikatoren rødt. aMAJOR slukker automatisk, når den ikke har været i brug i 60 minutter.

TRUE WIRELESS STEREO FORBINDELSE

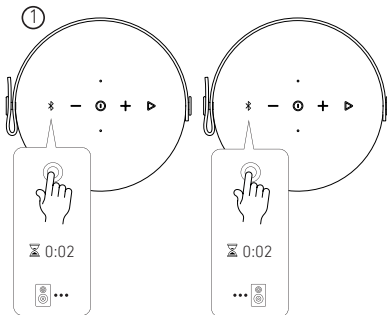

aMAJOR kan forbindes med en anden aMAJOR og afspille i True Wireless Stereo (TWS).

Tænd begge aMAJORs. Tryk og hold Bluetooth knappen inde på begge højtalere i 2 sekunder for at aktivere TWS forbindelsestilstand. LED-indikatoren på begge højtalere blinker nu lilla.

②

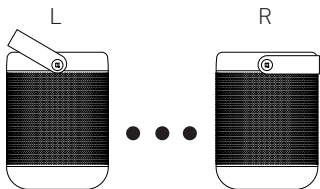

De to aMAJORs vil automatisk forbindes, LED-indikatoren vil skifte til hvid på begge højtalere og en lydprompt høres.

Sørg for, at din enhed er forbundet til en af dine aMAJORs. Du er nu klar til at afspille i True Wireless Stereo.

De to aMAJORs vil automatisk forbinde I TWS-tilstand når begge højtalere er tændte, indtil TWS-forbindelsestilstanden igen manuelt aktiveres på en af højtalerne.

VOICE ASSISTANT FUNKTION

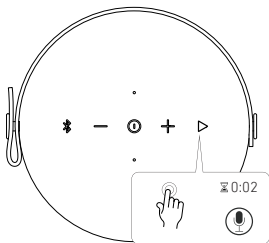

Du kan bruge din enheds Voice Assistant gennem den indbyggede mikrofon på aMAJOR. Aktiver din Voice Assistant ved at trykke og holde på Play-knappen i 2 sekunder. LED-indikatoren vil blinke hvidt og den indbyggede mikrofon vil fange dine stemmekommandoer.

Når der er to aMAJORS, der afspiller i TWS-tilstand, kan kun den ene aMAJOR aktivere mikrofonen til Voice Assistant. Når du aktiverer din Voice Assistant, vil LED-indikatoren blinke hvidt på den højttaler, der lytter til dine kommandoer.

Italiano

Manuale operativo

ISTRUZIONI DI SICUREZZA E MANUTENZIONE

1. Per favore, leggere attentamente il presente manuale di istruzioni prima dell'utilizzo.
2. Le istruzioni di sicurezza e manutenzione contenute in questo manuale devono essere conservate per riferimento futuro ed essere seguite in ogni momento.
3. Tenere il prodotto lontano da fonti di calore come termosifoni, stufe o altri apparecchi che producono calore.
4. Non esporre il prodotto alla luce diretta del sole per lunghi periodi. Le alte temperature possono ridurre la durata del prodotto, danneggiare la batteria e deformare alcune parti in plastica.
5. Non esporre il prodotto al gelo in quanto potrebbe danneggiare il circuito interno.
6. Evitare che il prodotto entri in contatto con liquidi.
7. Non lanciare, calpestare o esercitare una forte pressione sul prodotto in quanto potrebbe danneggiare il circuito interno.
8. Non provare a smontare il prodotto. Tale operazione deve essere eseguita esclusivamente da un professionista.
9. Non utilizzare prodotti chimici concentrati o detergenti per pulire il prodotto.
10. Tenere la superficie lontana da oggetti taglienti e appuntiti che potrebbero danneggiare le parti in plastica.
11. Utilizzare esclusivamente alimentatori da 5V / 1A. L'utilizzo di alimentatori con tensione superiore può causare gravi danni.
12. Non gettare o collocare la batteria al litio vicino al fuoco o a fonti di calore intenso per evitare il rischio di esplosione.

Se riscontri problemi di qualsiasi tipo con il tuo prodotto, ti preghiamo di contattare il rivenditore presso cui hai effettuato l'acquisto. Il rivenditore provvederà a fornirti assistenza e, nel caso in cui il problema non venga risolto, il rivenditore gestirà il reclamo direttamente con KREAFUNK.

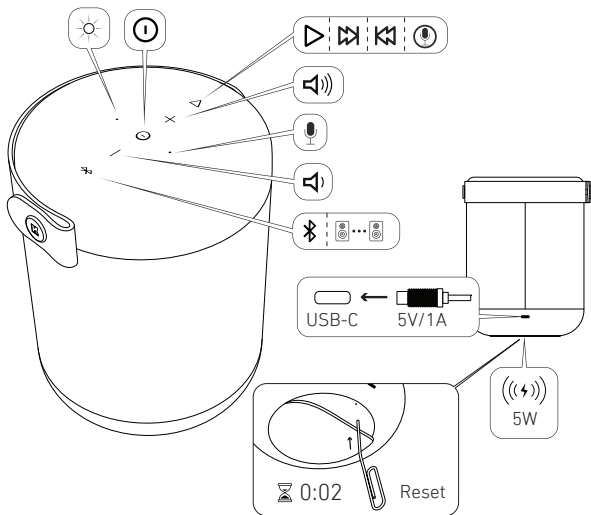

CONNESSIONE BLUETOOTH®

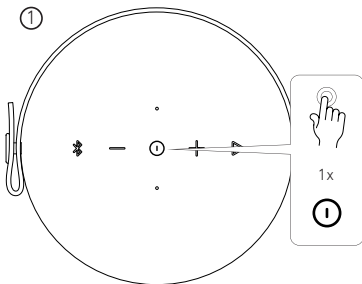

Premere il pulsante ON / OFF per attivare aMAJOR. L'indicatore LED si illuminerà di bianco e verrà emesso un segnale acustico.

②

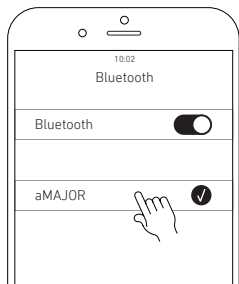

Quando l'indicatore LED su aMAJOR inizia a lampeggiare in bianco, assicurarsi che il Bluetooth sul dispositivo sia acceso. Trovare l'elenco delle unità visibili / collegate sul dispositivo e selezionare "aMAJOR". L'indicatore LED diventerà bianco fisso, verrà emesso un segnale acustico e aMAJOR sarà pronto per la riproduzione.

CONNESSIONE MANUALE DEL BLUETOOTH®

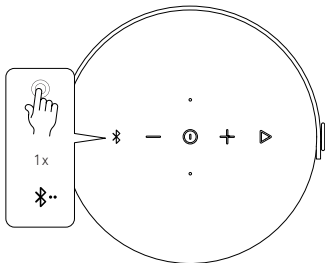

aMAJOR, quando acceso, si ricollegherà sempre all'ultimo dispositivo connesso. Se si desidera collegare un nuovo dispositivo, è possibile attivare manualmente la modalità di connessione Bluetooth®:

Premere il pulsante Bluetooth per attivare la modalità di associazione Bluetooth. L'indicatore LED lampeggerà in bianco e ora è possibile associare aMAJOR a un nuovo dispositivo. È possibile abbinare fino a 2 dispositivi contemporaneamente a aMAJOR.

MULTIFUNZIONE

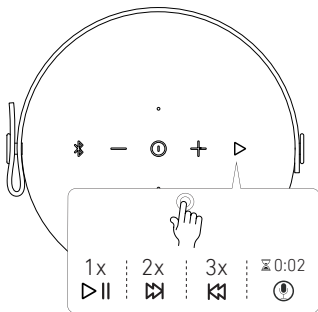

BATTERIA E RICARICA

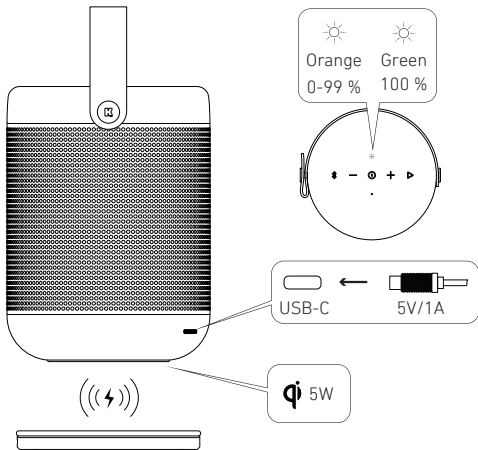

Ricarica















Il tempo di ricarica è approssimativamente 6 ore utilizzando il cavo USB incluso. L'indicatore LED diventa arancione fisso durante la ricarica. Quando la batteria è totalmente carica, l'indicatore LED diventa verde fisso.

RICARICA WIRELESS

aMAJOR può essere ricaricato con USB-C input o attraverso un tappetino di ricarica wireless certificato Qi®. Quando aMAJOR è correttamente in carica, l'indicatore LED sarà arancione fisso. Quando la batteria è del tutto carica, l'indicatore LED diventerà verde fisso e rimarrà tale fino a quando aMAJOR verrà rimosso dal tappetino di ricarica wireless certificato Qi® o fino a quando verrà rimosso il cavo di ricarica.

Il tempo di ricarica su un tappetino di ricarica certificato Qi® è di circa 14 ore.

STATO DELLA BATTERIA

	LED		Stato della batteria	
Bianca			15-100 %	
Rosso			<15 %	
Rosso lampeggiante			<10 %	
Arancia	 			0-99 %
Verde	 			100 %

Quando il livello della batteria è inferiore al 15%, l'indicatore LED diventa rosso fisso. Quando il livello della batteria è inferiore al 10%, l'indicatore LED lampeggia in rosso.

aMAJOR si spegnerà automaticamente se non utilizzato per 60 minuti.

ABBINAMENTO TRUE WIRELESS STEREO

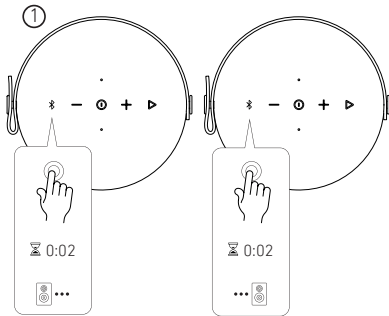

aMAJOR può essere abbinato a un altro aMAJOR e funzionare in True Wireless Stereo (TWS).

Accendere i due aMAJORs. Contemporaneamente, tenere premuto il pulsante Bluetooth su entrambi gli altoparlanti per 2 secondi per attivare la modalità di abbinamento TWS. L'indicatore LED di entrambi gli altoparlanti lampeggerà in viola.

②

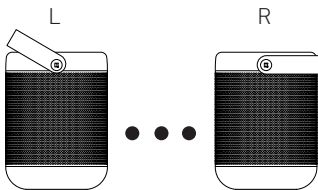

I due aMAJORs si abbineranno automaticamente, l'indicatore LED diventerà bianco fisso su entrambi gli altoparlanti e verrà emesso un segnale acustico.

Assicurarsi che il dispositivo sia accoppiato a uno dei due aMAJORs. Ora sarà possibile utilizzare gli altoparlanti in modalità True Wireless Stereo.

I due aMAJORs si ricollegheranno automaticamente in modalità TWS quando entrambi gli altoparlanti saranno accesi, fino a quando la modalità di abbinamento TWS verrà attivata manualmente su uno degli altoparlanti.

FUNZIONE ASSISTENTE VOCALE

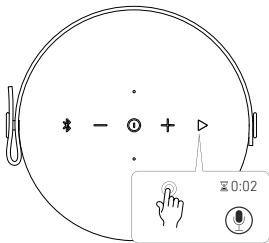

È possibile utilizzare l'Assistente Vocale del dispositivo tramite il microfono incorporato su aMAJOR. Attivare l'Assistente Vocale tenendo premuto il pulsante Play per 2 secondi. L'indicatore LED lampeggerà in bianco e il microfono incorporato riceverà i comandi vocali.

Quando due aMAJORs sono in modalità TWS, solo un aMAJOR potrà attivare il microfono per l'Assistente Vocale. Quando si attiva l'Assistente Vocale, l'indicatore LED lampeggerà in bianco sull'altoparlante pronto a ricevere i vostri comandi.

中文

Chinese

操作手冊

安全和保养说明

1. 使用前请仔细阅读此操作说明书
2. 务必保留本操作说明书中的安全和保养说明以供将来使用参考，并始终遵循安全和保养说明
3. 保持产品远离热源，如散热器，加热器或其他产生热量的器具
4. 请勿将产品长时间暴露在直射阳光下。高温会缩短产品的使用寿命，破坏电池并扭曲某些塑料部件。
5. 请勿将产品暴露在极冷的环境中，否则可能会损坏内部电路板。
6. 避免液体浸入产品
7. 请勿乱扔或在产品上印刻。这可能会损坏内部电路板。
8. 不要擅自试拆产品。这必须由专业人士完成。
9. 请勿使用浓缩化学产品或清洁剂清洁产品。
10. 请保持产品表面远离尖锐物体，因为这可能会损坏塑料部件。
11. 仅使用5V / 1A电源。连接电源电压过高可能会导致严重损坏。
12. 请勿随意丢弃或将锂电池放置在火源或高温附近，以免发生爆炸危险。

如果您确实遇到产品问题，请联系您购买产品时的零售商。零售商将为您提供指导，如果零售商不能解决问题，零售商将与KREAFUNK直接联系处理此类问题。

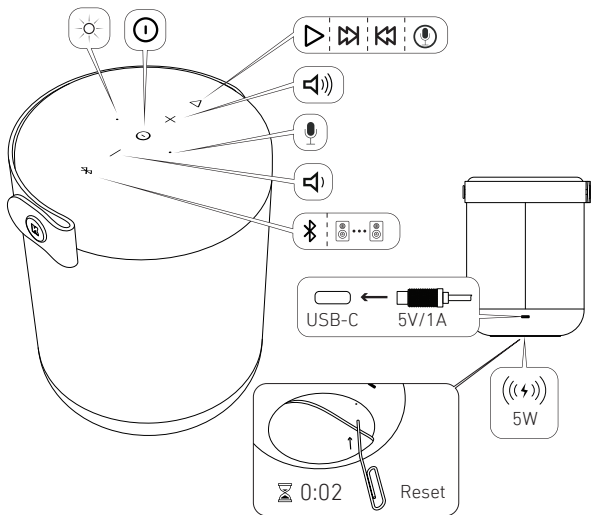

蓝牙®配对

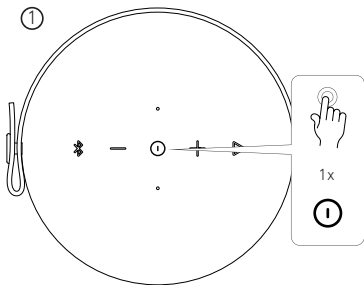

按ON / OFF按钮打开aMAJORS。LED指示灯将亮起白色并听到声音提示。

②

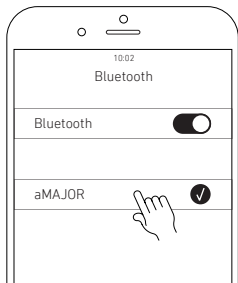

当aMAJOR上的LED指示灯开始闪烁白灯时，请确保设备上的蓝牙已打开。在设备上查看可见/已连接设备的列表，然后选择“aMAJOR”。LED指示灯变为白灯常亮，听到声音提示，以及aMAJOR准备就绪。

手动蓝牙®配对模式

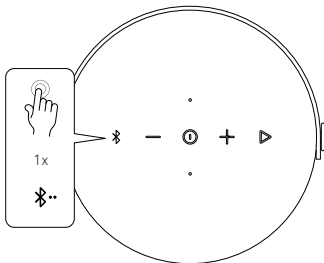

当打开时，aMAJOR将始终重新连接到上次连接的设备。如果您需要连接新设备，可以手动激活蓝牙®配对模式：

按蓝牙按钮激活蓝牙配对模式。LED指示灯将闪烁白色，您现在可以将aMAJOR与新设备配对。您最多可以同时拥有2个与aMAJOR配对的设备。

多功能

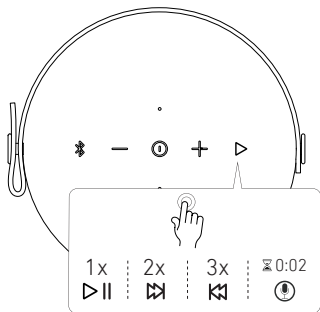

电池与充电

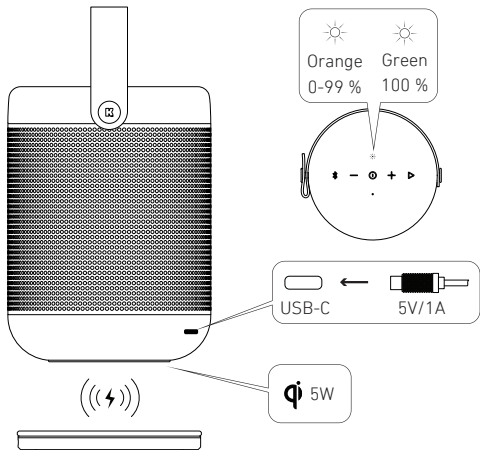

充电

使用随附的USB连接线充电大约耗时6小时。充电时，LED指示灯变为橙灯常亮。电池充满电后，LED指示灯变为绿灯常亮。

无线充电

aMAJOR可以通过USB-C输入或放在QI®认证的无线充电板进行充电。当aMAJOR正常充电时，LED指示灯将变为橙灯常亮。当电池充满电时，LED指示灯将变为绿灯常亮，aMAJOR离开QI®认证的充电板或拔下充电线时，指示灯熄灭。

充电时间约为14小时

电池状态

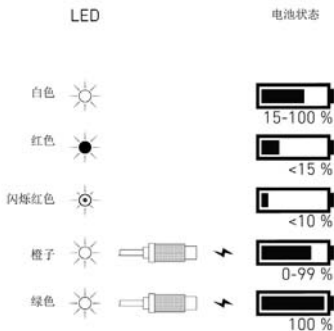

当电池电量低于15%时，LED指示灯变为红色常亮。当电池电量低于10%时，LED指示灯闪烁红灯。

aMAJOR未使用60分钟后将自动关闭。

真实无线立体声配对

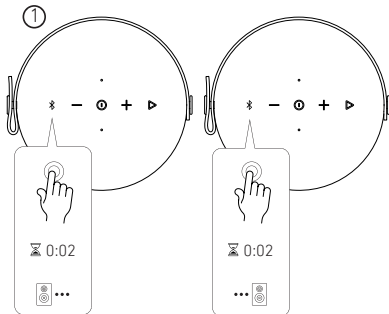

aMAJOR可以与另一个aMAJOR配对，并在真实无线立体声（TWS）模式播放。

打開aMAJORs。確保您的設備與aMAJORs之一配對。同時，按住兩個揚聲器上的藍牙按鈕2秒鐘以激活TWS配對模式。兩個揚聲器上的LED指示燈現在呈藍色閃爍。

②

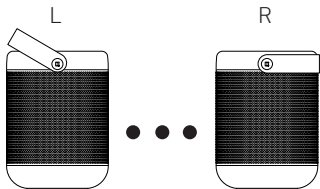

兩個aMAJORS將自動配對，兩個揚聲器上的LED指示燈將變為純白色，並且會聽到聲音提示。

確保您的設備與aMAJORS之一配對。您現在可以使用True Wireless Stereo。

當兩個揚聲器都打開時，兩個 aMAJORS 將在TWS模式下自動重新連接，直到在其中一個揚聲器上再次手動激活TWS配對模式。

语音助手功能

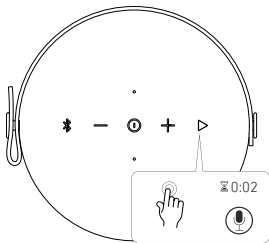

通过aMAJOR上的内置麦克风，您可以使用设备的语音助手。长按“播放”按钮2秒钟激活语音助手。LED指示灯将闪烁白灯，内置麦克风将拾取您的语音命令。

当在TWS模式下播放两个aMAJORs时，只有一个aMAJOR可以激活麦克风开启语音助手功能。当激活语音助手功能时，接收语音命令的扬声器上LED指示灯将闪烁白灯。

FCC STATEMENT

This device complies with part 15 of the FCC rules. Operation is subject to the following two conditions:

1. This device may not cause harmful interference and
2. This device must accept any interference received, including interference that may cause undesired operation.

Important:

Changes or modifications to this product not authorized could void the FCC compliance and negate your authority to operate the product.

NOTE:

This equipment has been tested and found to comply with the limits for a Class B digital device, pursuant to part 15 of the FCC Rules. These limits are designed to provide reasonable protection against harmful interference in a residential installation. This equipment generates uses and can radiate radio frequency energy and, if not installed and used in accordance with the instructions, may cause harmful interference to radio communications.

However, there is no guarantee that interference will not occur in a particular installation. If this equipment does cause harmful interference to radio or television reception, which can be determined by turning the equipment off and on, the user is encouraged to try to correct the interference by one or more of the following measures:

- Reorient or relocate the receiving antenna.
- Increase the separation between the equipment and receiver.
- Connect the equipment into an outlet on a circuit different from that to which the receiver is connected.
- Consult the dealer or an experienced radio / TV technician for help.

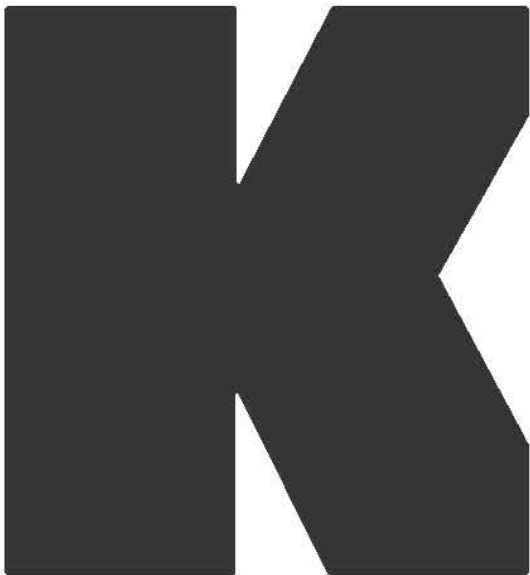

KREAFUNK
kreatfunk.com