

FCC CERTIFICATION TEST REPORT

FOR

| | | |
|-----------------------------|---|------------------------------------------------------------------------------------------|
| Applicant | : | KREAFUNK APS |
| Address | : | Klamsagervej 35 A, st.8230 Abyhoj, Denmark |
| Equipment under Test | : | Bluetooth Speaker |
| Model No. | : | aGROOVE MINI |
| Trade Mark | : | KREAFUNK |
| FCC ID | : | 2ACVC-AGROOVEMINI |
| Manufacturer | : | Shenzhen Winnershine Electronics Co., Ltd. |
| Address | : | 32# Yuan hu Road, Zhang Bei Community, Longcheng Street, Long gang District, Shenzhen |

Issued By: Dongguan Dongdian Testing Service Co., Ltd.

Add.: No. 17, Zongbu Road 2, Songshan Lake Sci&Tech, Industry Park,
Dongguan City, Guangdong Province, China, 523808

Tel.: +86-0769-38826678, **E-mail:** ddt@dgddt.com, <http://www.dgddt.com>

REPORT

Table of Contents

| | | |
|------|---------------------------------------------------|----|
| | Test report declares..... | 4 |
| 1. | Summary of Test Results..... | 6 |
| 2. | General Test Information | 7 |
| 2.1. | Description of EUT | 7 |
| 2.2. | Accessories of EUT..... | 8 |
| 2.3. | Assistant equipment used for test..... | 8 |
| 2.4. | Block diagram of EUT configuration for test | 8 |
| 2.5. | Deviations of test standard..... | 8 |
| 2.6. | Test environment conditions | 9 |
| 2.7. | Test laboratory | 9 |
| 2.8. | Measurement uncertainty..... | 10 |
| 3. | Equipment Used During Test..... | 11 |
| 4. | Maximum Peak Output Power | 12 |
| 4.1. | Block diagram of test setup..... | 12 |
| 4.2. | Limits | 12 |
| 4.3. | Test procedure | 12 |
| 4.4. | Test result..... | 12 |
| 4.5. | Original test data | 13 |
| 5. | 20 dB Bandwidth and 99% Bandwidth..... | 16 |
| 5.1. | Block diagram of test setup..... | 16 |
| 5.2. | Limits | 16 |
| 5.3. | Test procedure | 16 |
| 5.4. | Test result..... | 16 |
| 5.5. | Original test data | 17 |
| 6. | Carrier Frequency Separation..... | 23 |
| 6.1. | Block diagram of test setup..... | 23 |
| 6.2. | Limits | 23 |
| 6.3. | Test procedure | 23 |
| 6.4. | Test result..... | 23 |
| 6.5. | Original test data | 24 |
| 7. | Number of Hopping Channel | 25 |
| 7.1. | Block diagram of test setup..... | 25 |
| 7.2. | Limits | 25 |
| 7.3. | Test procedure | 25 |
| 7.4. | Test result..... | 25 |
| 7.5. | Original test data | 25 |
| 8. | Dwell Time..... | 27 |

| | | |
|-------|-----------------------------------------------|----|
| 8.1. | Block diagram of test setup..... | 27 |
| 8.2. | Limits | 27 |
| 8.3. | Test procedure | 27 |
| 8.4. | Test result..... | 27 |
| 8.5. | Original test data | 28 |
| 9. | Band Edge Compliance (Conducted Method) | 33 |
| 9.1. | Block diagram of test setup..... | 33 |
| 9.2. | Limit..... | 33 |
| 9.3. | Test result..... | 33 |
| 9.4. | Original test data | 33 |
| 10. | Radiated Emission | 37 |
| 10.1. | Block diagram of test setup..... | 37 |
| 10.2. | Limit..... | 38 |
| 10.3. | Test procedure | 39 |
| 10.4. | Test result..... | 41 |
| 11. | RF Conducted Spurious Emissions | 56 |
| 11.1. | Block diagram of test setup..... | 56 |
| 11.2. | Limits | 56 |
| 11.3. | Test procedure | 56 |
| 11.4. | Test result..... | 57 |
| 11.5. | Original test data | 57 |
| 12. | Band Edge Compliance (Radiated Method) | 64 |
| 12.1. | Block diagram of test setup..... | 64 |
| 12.2. | Limit..... | 64 |
| 12.3. | Test procedure | 64 |
| 12.4. | Test result..... | 64 |
| 13. | Power Line Conducted Emission | 73 |
| 13.1. | Block diagram of test setup..... | 73 |
| 13.2. | Power line conducted emission limits | 73 |
| 13.3. | Test procedure | 73 |
| 13.4. | Test result..... | 74 |
| 14. | Antenna Requirements | 77 |
| 14.1. | Limit..... | 77 |
| 14.2. | Result | 77 |
| 15. | Test Setup Photograph | 78 |
| 16. | Photos of the EUT | 80 |

Test Report Declare

| | | |
|-----------------------------|---|------------------------------------------------------------------------------------------|
| Applicant | : | KREAFUNK APS |
| Address | : | Klamsagervej 35 A, st.8230 Abyhoj, Denmark |
| Equipment under Test | : | Bluetooth Speaker |
| Model No. | : | aGROOVE MINI |
| Trade Mark | : | KREAFUNK |
| Manufacturer | : | Shenzhen Winnershine Electronics Co., Ltd. |
| Address | : | 32# Yuan hu Road, Zhang Bei Community, Longcheng Street, Long gang District, Shenzhen |

Test Standard Used:

FCC Rules and Regulations Part 15 Subpart C.

Test Procedure Used:

ANSI C63.10:2013.

We Declare:

The equipment described above is tested by Dongguan Dongdian Testing Service Co., Ltd. and in the configuration tested the equipment complied with the standards specified above. The test results are contained in this test report and Dongguan Dongdian Testing Service Co., Ltd. is assumed of full responsibility for the accuracy and completeness of these tests.

After test and evaluation, our opinion is that the equipment provided for test compliance with the requirement of the above FCC standards.

| | | | |
|-------------------------|--------------------|----------------------|-------------------------------|
| Report No.: | DDT-R22061414-4E01 | | |
| Date of Receipt: | Jun. 21, 2022 | Date of Test: | Jun. 21, 2022 ~ Jul. 22, 2022 |

Prepared By:

Sanvin Zheng

Sanvin Zheng/Engineer

Approved By:



Damon Hu/EMC Manager

Note: This report applies to above tested sample only. This report shall not be reproduced in parts without written approval of Dongguan Dongdian Testing Service Co., Ltd.

Revision History

| Rev. | Revisions | Issue Date | Revised By |
|------|---------------|---------------|------------|
| --- | Initial issue | Jul. 22, 2022 | |
| | | | |

1. Summary of Test Results

| Description of Test Item | Standard | Results |
|-----------------------------------|-------------------------------------------------------------------|---------|
| Maximum Peak Output Power | FCC Part 15: 15.247(b)(1) ANSI C63.10:2013 | Pass |
| 20 dB Bandwidth and 99% Bandwidth | FCC Part 15: 15.215 ANSI C63.10:2013 | Pass |
| Carrier Frequency Separation | FCC Part 15: 15.247(a)(1) ANSI C63.10:2013 | Pass |
| Number of Hopping Channel | FCC Part 15: 15.247(a)(1)(iii) ANSI C63.10:2013 | Pass |
| Dwell Time | FCC Part 15: 15.247(a)(1)(iii) ANSI C63.10:2013 | Pass |
| Radiated Emission | FCC Part 15: 15.209 FCC Part 15: 15.247(d) ANSI C63.10:2013 | Pass |
| Band Edge Compliance | FCC Part 15: 15.247(d) ANSI C63.10:2013 | Pass |
| Power Line Conducted Emissions | FCC Part 15: 15.207 ANSI C63.10:2013 | Pass |
| Antenna Requirement | FCC Part 15: 15.203 | Pass |

2. General Test Information

2.1. Description of EUT

| | |
|--------------------------|------------------------------------------------------------------------|
| EUT* Name | : Bluetooth Speaker |
| Model Number | : aGROOVE MINI |
| EUT Function Description | : Please reference user manual of this device |
| Power Supply | : DC 3.7V Polymer Li-ion built-in battery : DC 5V from external USB |
| Radio Specification | : Bluetooth V5.1 |
| Operation Frequency | : 2402 MHz - 2480 MHz |
| Modulation | : GFSK, $\pi/4$ -DQPSK |
| Data Rate | : 1 Mbps, 2 Mbps |
| Antenna Gain | : FPC antenna, maximum PK gain: -0.58 dBi |
| Sample Type | : Series production |
| Sample Number | : S22061414-12 for conductive : S22061414-13 for radiation |

Note: EUT is the abbreviation of equipment under test.

| Channel Information | | | | | |
|---------------------|-----------------|---------|-----------------|---------|-----------------|
| Channel | Frequency (MHz) | Channel | Frequency (MHz) | Channel | Frequency (MHz) |
| 0 | 2402 | 27 | 2429 | 54 | 2456 |
| 1 | 2403 | 28 | 2430 | 55 | 2457 |
| 2 | 2404 | 29 | 2431 | 56 | 2458 |
| 3 | 2405 | 30 | 2432 | 57 | 2459 |
| 4 | 2406 | 31 | 2433 | 58 | 2460 |
| 5 | 2407 | 32 | 2434 | 59 | 2461 |
| 6 | 2408 | 33 | 2435 | 60 | 2462 |
| 7 | 2409 | 34 | 2436 | 61 | 2463 |
| 8 | 2410 | 35 | 2437 | 62 | 2464 |
| 9 | 2411 | 36 | 2438 | 63 | 2465 |
| 10 | 2412 | 37 | 2439 | 64 | 2466 |
| 11 | 2413 | 38 | 2440 | 65 | 2467 |
| 12 | 2414 | 39 | 2441 | 66 | 2468 |
| 13 | 2415 | 40 | 2442 | 67 | 2469 |
| 14 | 2416 | 41 | 2443 | 68 | 2470 |
| 15 | 2417 | 42 | 2444 | 69 | 2471 |
| 16 | 2418 | 43 | 2445 | 70 | 2472 |
| 17 | 2419 | 44 | 2446 | 71 | 2473 |
| 18 | 2420 | 45 | 2447 | 72 | 2474 |
| 19 | 2421 | 46 | 2448 | 73 | 2475 |
| 20 | 2422 | 47 | 2449 | 74 | 2476 |
| 21 | 2423 | 48 | 2450 | 75 | 2477 |
| 22 | 2424 | 49 | 2451 | 76 | 2478 |
| 23 | 2425 | 50 | 2452 | 77 | 2479 |
| 24 | 2426 | 51 | 2453 | 78 | 2480 |
| 25 | 2427 | 52 | 2454 | | |
| 26 | 2428 | 53 | 2455 | | |

2.2. Accessories of EUT

| Description of Accessories | Manufacturer | Model number | Description | Remark |
|----------------------------|--------------|--------------|-------------|--------|
| N/A | N/A | N/A | N/A | N/A |

2.3. Assistant equipment used for test

| Assistant equipment | Manufacturer | Model number | Description | SN |
|---------------------|--------------|--------------|-------------|---------------------------------------------------------------|
| AC Adapter | SAMSUNG | EP-TA200 | N/A | Input: 100-240V~50-60Hz Output: 9.0V/1.67A or 5.0V/2.0A |

2.4. Block diagram of EUT configuration for test

EUT

Test software: FCC_assist_ v1.0.1.2.exe

The test software was used to control EUT work in Continuous Tx mode, and select test channel, wireless mode as below table.

The pathloss of external cable: 0.5dB (According to the manufacturer's claims)

| Tested mode, channel, information | | | |
|------------------------------------|------------------|-------------|-----------------|
| Mode | Setting Tx Power | Channel | Frequency (MHz) |
| GFSK hopping on Tx mode | 10 | CH0 to CH78 | 2402 to 2480 |
| $\pi/4$ -DQPSK hopping on Tx mode | 10 | CH0 to CH78 | 2402 to 2480 |
| 8DPSK hopping on Tx mode | 10 | CH0 to CH78 | 2402 to 2480 |
| GFSK hopping off Tx mode | 10 | CH0 | 2402 |
| | 10 | CH39 | 2441 |
| | 10 | CH78 | 2480 |
| $\pi/4$ -DQPSK hopping off Tx mode | 10 | CH0 | 2402 |
| | 10 | CH39 | 2441 |
| | 10 | CH78 | 2480 |
| 8DPSK hopping off Tx mode | 10 | CH0 | 2402 |
| | 10 | CH39 | 2441 |
| | 10 | CH78 | 2480 |

2.5. Deviations of test standard

No deviation.

2.6. Test environment conditions

During the measurement the environmental conditions were within the listed ranges:

| | |
|--------------------|------------|
| Temperature range: | 21-25 °C |
| Humidity range: | 40-75% |
| Pressure range: | 86-106 kPa |

2.7. Test laboratory

Dongguan Dongdian Testing Service Co., Ltd.

Add.: No. 17, Zongbu Road 2, Songshan Lake Sci&Tech, Industry Park, Dongguan City,
Guangdong Province, China, 523808.

Tel.: +86-0769-38826678, <http://www.dgddt.com>, Email: ddt@dgddt.com.

CNAS Accreditation No. L6451; A2LA Accreditation Number: 3870.01

FCC Designation Number: CN1182, Test Firm Registration Number: 540522

Innovation, Science and Economic Development Canada Site Registration Number: 10288A

Conformity Assessment Body identifier: CN0048

VCCI facility registration number: C-20087, T-20088, R-20123, G-20118

2.8. Measurement uncertainty

| Test Item | Uncertainty |
|-----------------------------------------------------------------------------------------------------------------------------------------------|------------------------------------------------|
| Bandwidth | 1.1% |
| Peak Output Power (Conducted) (Spectrum Analyzer) | 0.86 dB (10 MHz ≤ f < 3.6 GHz); |
| | 1.38 dB (3.6 GHz ≤ f < 8 GHz) |
| Peak Output Power (Conducted) (Power Sensor) | 0.74 dB |
| Power Spectral Density | 0.74 dB (10 MHz ≤ f < 3.6 GHz); |
| | 1.38 dB (3.6 GHz ≤ f < 8 GHz) |
| Frequencies Stability | 6.7 x 10 ⁻⁸ (Antenna couple method) |
| | 5.5 x 10 ⁻⁸ (Conducted method) |
| Conducted Spurious Emissions | 0.86 dB (10 MHz ≤ f < 3.6 GHz); |
| | 1.40 dB (3.6 GHz ≤ f < 8 GHz) |
| | 1.66 dB (8 GHz ≤ f < 22 GHz) |
| Uncertainty for Radio Frequency (RBW < 20 kHz) | 3x10 ⁻⁸ |
| Temperature | 0.4 °C |
| Humidity | 2 % |
| Uncertainty for Radiation Emission Test (9 kHz – 30 MHz) | 3.44 dB |
| Uncertainty for Radiation Emission Test (30 MHz - 1 GHz) | 4.70 dB (Antenna Polarize: V) |
| | 4.84 dB (Antenna Polarize: H) |
| Uncertainty for Radiation Emission Test (1 GHz - 40 GHz) | 4.10 dB (1 - 6 GHz) |
| | 4.40 dB (6 GHz - 18 GHz) |
| | 3.54 dB (18 GHz - 26 GHz) |
| | 4.30 dB (26 GHz - 40 GHz) |
| Uncertainty for Power Line Conduction Emission Test | 3.32 dB (150 kHz - 30 MHz) |
| Note: This uncertainty represents an expanded uncertainty expressed at approximately the 95% confidence level using a coverage factor of k=2. | |

3. Equipment Used During Test

| Equipment | Manufacturer | Model No. | Serial No. | Last Cal. | Cal. Interval |
|-------------------------------------------------------------------------------------------|--------------|-------------|-----------------|---------------|---------------|
| <input checked="" type="checkbox"/> RF Connected Test (Tonscend RF Measurement System 1#) | | | | | |
| SIGNAL ANALYZER | R&S | FSQ26 | 101272 | May 18, 2022 | 1 Year |
| Wideband Radio Communication tester | R&S | CMW500 | 120259 | Sep. 02, 2021 | 1 Year |
| Vector Signal Generator | Agilent | E8267D | US49060192 | Oct. 15, 2021 | 1 Year |
| Vector Signal Generator | Agilent | N5182A | MY48180737 | May 18, 2022 | 1 Year |
| RF Control Unit | Tonsend | JS0806-2 | 158060010 | May 18, 2022 | 1 Year |
| Temp&Humi Programmable | ZHIXIANG | ZXGDJS-150L | ZX170110-A | May 26, 2022 | 1 Year |
| Test Software | JS Tonscend | JS1120-3 | Ver.2.6.77.0518 | N/A | N/A |
| <input checked="" type="checkbox"/> Radiation 3#chamber | | | | | |
| EMI Test Receiver | R&S | ESU | 100472 | May 18, 2022 | 1 Year |
| Spectrum analyzer | Agilent | E4447A | MY50180031 | May 18, 2022 | 1 Year |
| Active Loop antenna | Schwarzbeck | FMZB-1519 | 1519-038 | Sep. 19, 2021 | 1 Year |
| Trilog Broadband Antenna | Schwarzbeck | VULB 9163 | 01429 | Aug. 07, 2021 | 1 Year |
| Double Ridged Horn Antenna | Schwarzbeck | BBHA9120 | 02468 | Nov. 17, 2021 | 1 Year |
| Broad Band Horn Antenna | Schwarzbeck | BBHA 9170 | 790 | May 06, 2022 | 1 Year |
| Pre-amplifier | COM-POWER | PAM-118A | 18040084 | Sep. 02, 2021 | 1 Year |
| Pre-amplifier | COM-POWER | PAM-840A | 461369 | Apr. 11, 2022 | 1 Year |
| Test software | Audix | E3 | V 6.1.1.1 | N/A | N/A |
| <input checked="" type="checkbox"/> Power Line Conducted Emissions Test 1# | | | | | |
| Test Receiver | R&S | ESCI | 100551 | Sep. 02, 2021 | 1 Year |
| LISN 1 | R&S | ENV216 | 101109 | Sep. 02, 2021 | 1 Year |
| LISN 2 | R&S | ESH2-Z5 | 100309 | Sep. 02, 2021 | 1 Year |
| Pulse Limiter | R&S | ESH3-Z2 | 101242 | Sep. 02, 2021 | 1 Year |
| CE Cable 1 | HUBSER | N/A | W10.01 | Sep. 02, 2021 | 1 Year |
| LISN 3 | SCHWARZBECK | NSLK 8163 | 00017 | Sep. 02, 2021 | 1 Year |
| Test software | Audix | E3 | V 6.11111b | N/A | N/A |

4. Maximum Peak Output Power

4.1. Block diagram of test setup

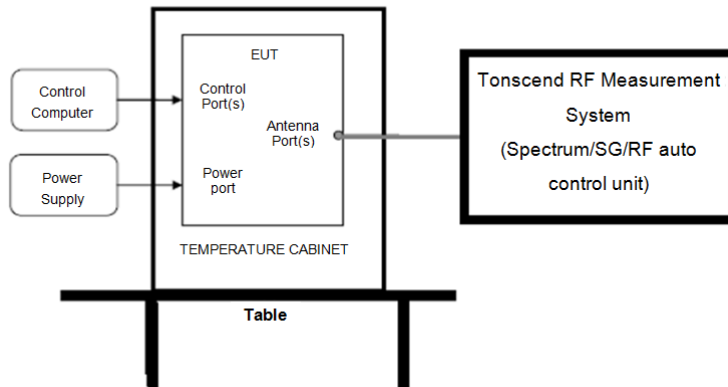

4.2. Limits

For frequency hopping systems operating in the 2400-2483.5 MHz band employing at least 75 non-overlapping hopping channels, and all frequency hopping systems in the 5725-5850 MHz band: 1 watt. For all other frequency hopping systems in the 2400-2483.5 MHz band: 0.125 watts, the e.i.r.p shall not exceed 4 W.

4.3. Test procedure

- (1) Connect EUT's antenna output to spectrum analyzer by RF cable.
- (2) Measure the maximum output power of EUT by spectrum analyzer with PK detector and RBW = 3 MHz (above 20 dB bandwidth of measured signal), VBW = 8 MHz

Note: The attenuator loss was inputted into spectrum analyzer as amplitude offset.

4.4. Test result

| Mode | Antenna | Freq. (MHz) | Result (dBm) | Limit (dBm) | Verdict |
|----------------|---------|-------------|--------------|-------------|---------|
| GFSK | ANT1 | 2402 | 3.81 | 21 | Pass |
| | ANT1 | 2441 | 4.06 | 21 | Pass |
| | ANT1 | 2480 | 4.27 | 21 | Pass |
| $\pi/4$ -DQPSK | ANT1 | 2402 | 4.50 | 21 | Pass |
| | ANT1 | 2441 | 4.63 | 21 | Pass |
| | ANT1 | 2480 | 4.73 | 21 | Pass |

4.5. Original test data

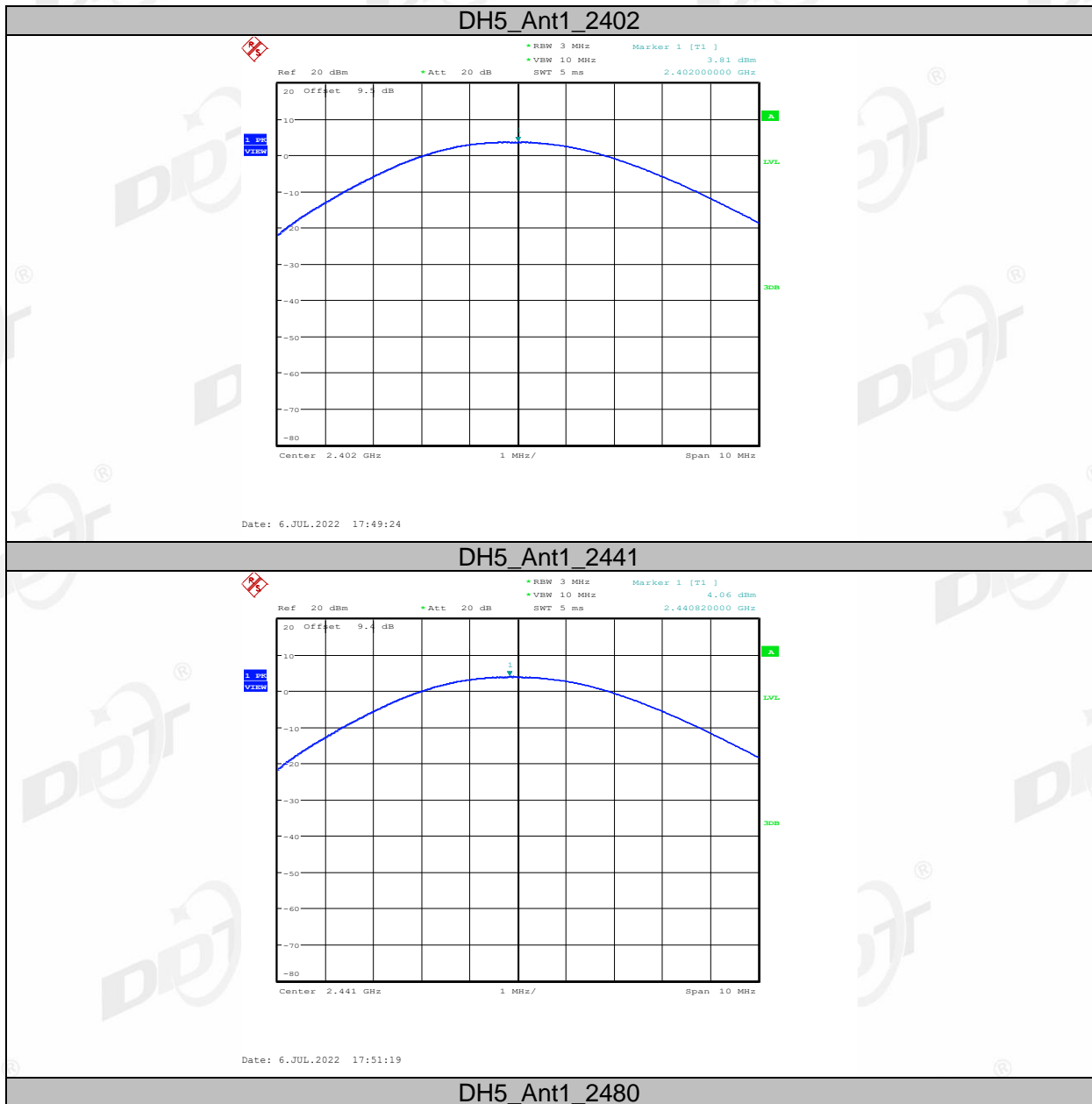

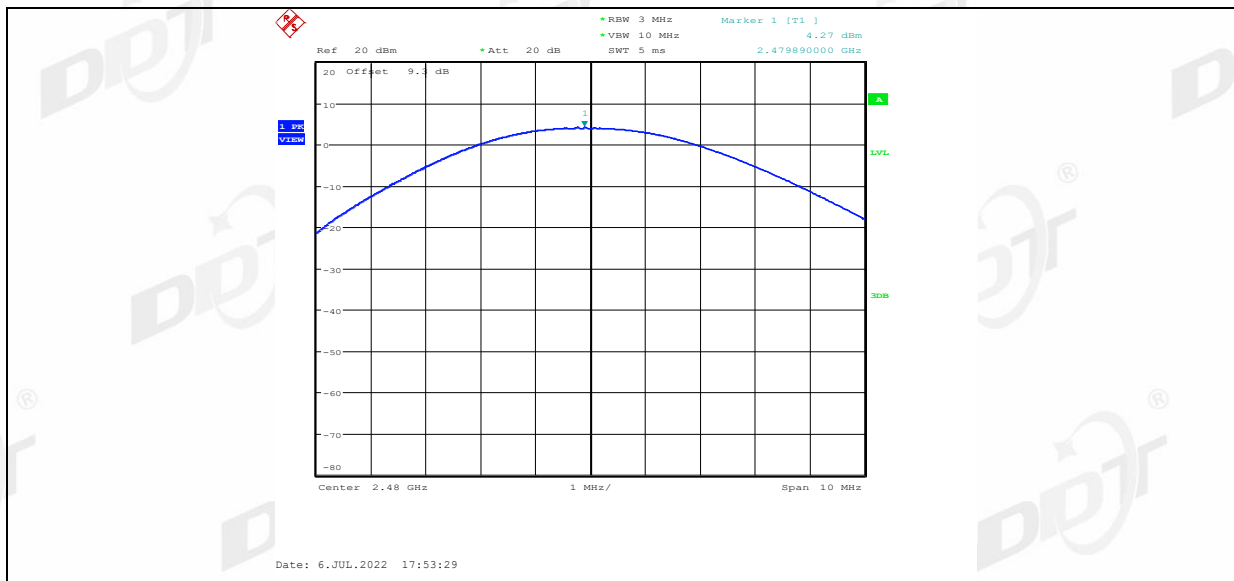

2DH5_Ant1_2402

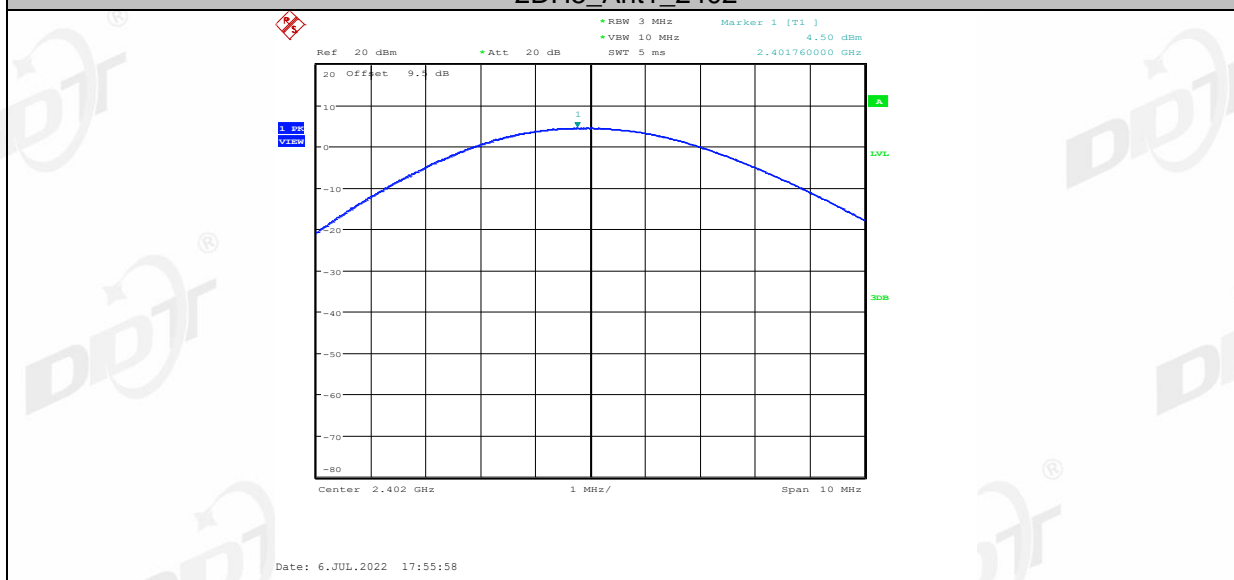

2DH5_Ant1_2441

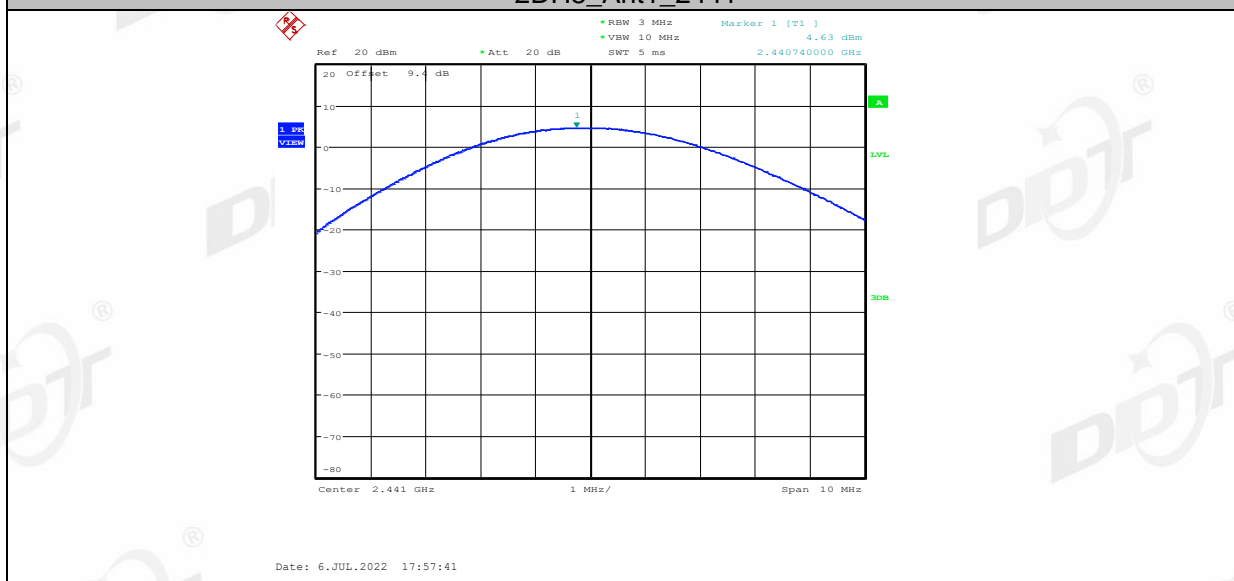

2DH5_Ant1_2480

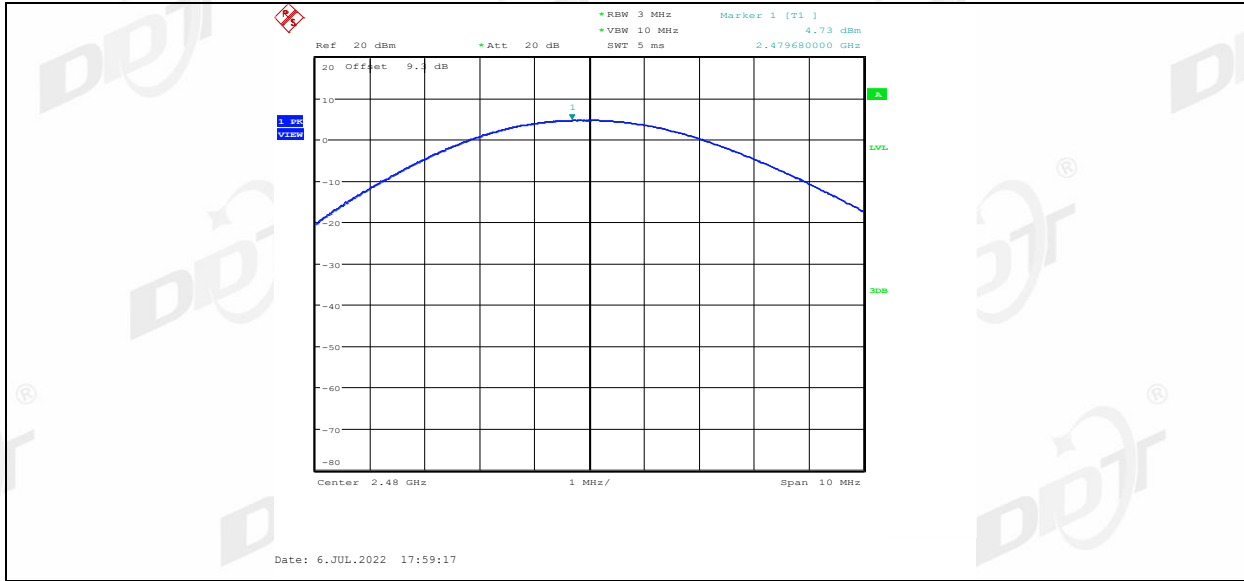

5. 20 dB Bandwidth and 99% Bandwidth

5.1. Block diagram of test setup

Same as section 4.1

5.2. Limits

Intentional radiators operating under the alternative provisions to the general emission limits, as contained in § 15.217 through 15.257 and in Subpart E of this part, must be designed to ensure that the 20 dB bandwidth of the emission, or whatever bandwidth may otherwise be specified in the specific rule section under which the equipment operates, is contained within the frequency band designated in the rule section under which the equipment is operated.

5.3. Test procedure

- (1) Connect EUT's antenna output to spectrum analyzer by RF cable.
- (2) The bandwidth of the fundamental frequency was measured by spectrum analyzer with 30 kHz RBW and 100 kHz VBW. The 20 dB bandwidth is defined as the total spectrum the power of which is higher than peak power minus 20 dB.

5.4. Test result

| Mode | Freq. (MHz) | 20 dB bandwidth Result (MHz) | 99% bandwidth Result (MHz) | Verdict |
|----------------|-------------|------------------------------|----------------------------|---------|
| GFSK | 2402 | 1.036 | 0.918 | Pass |
| | 2441 | 1.036 | 0.936 | Pass |
| | 2480 | 1.040 | 0.946 | Pass |
| $\pi/4$ -DQPSK | 2402 | 1.326 | 1.202 | Pass |
| | 2441 | 1.332 | 1.204 | Pass |
| | 2480 | 1.338 | 1.220 | Pass |

5.5. Original test data

20 dB bandwidth:

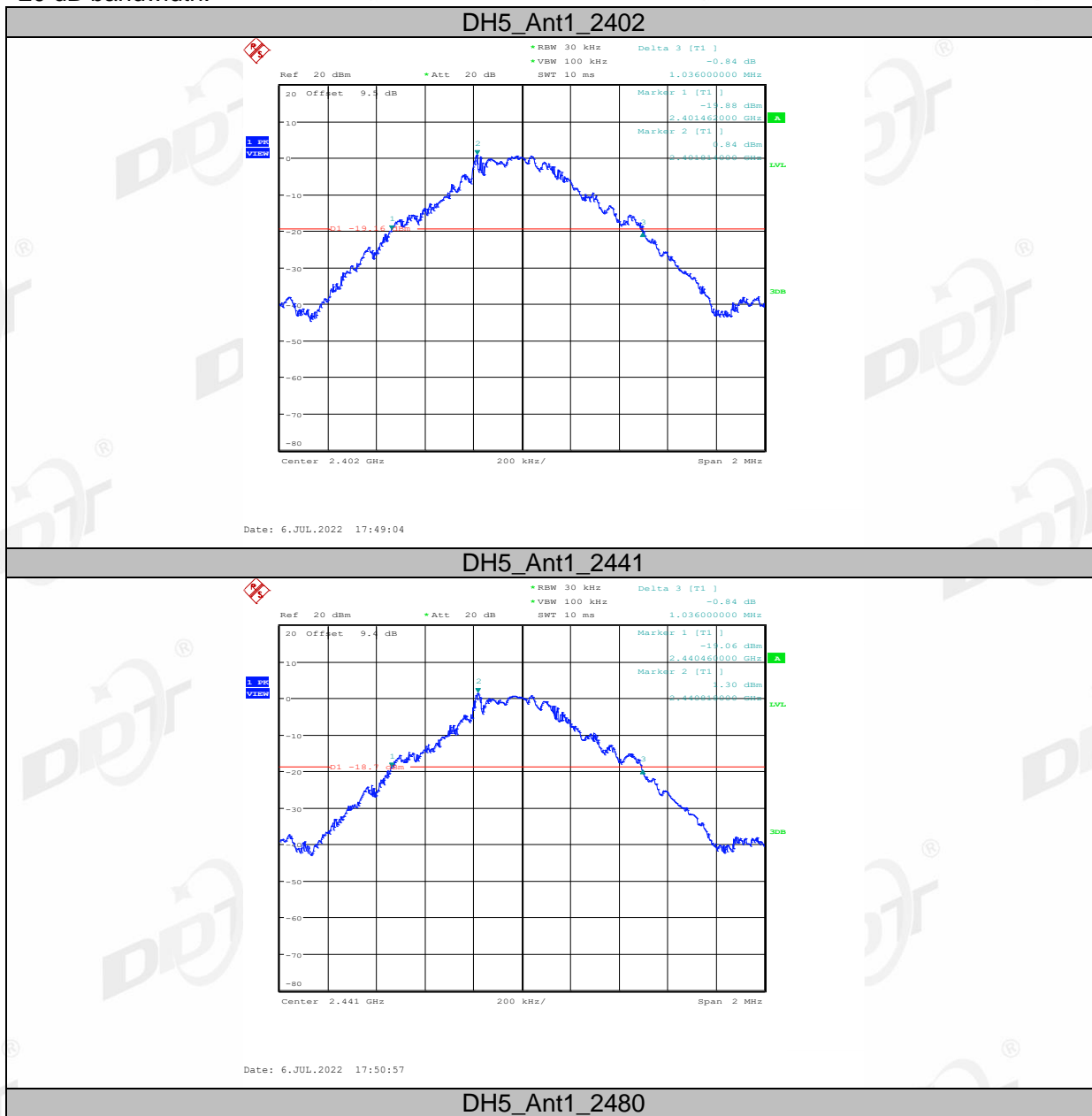

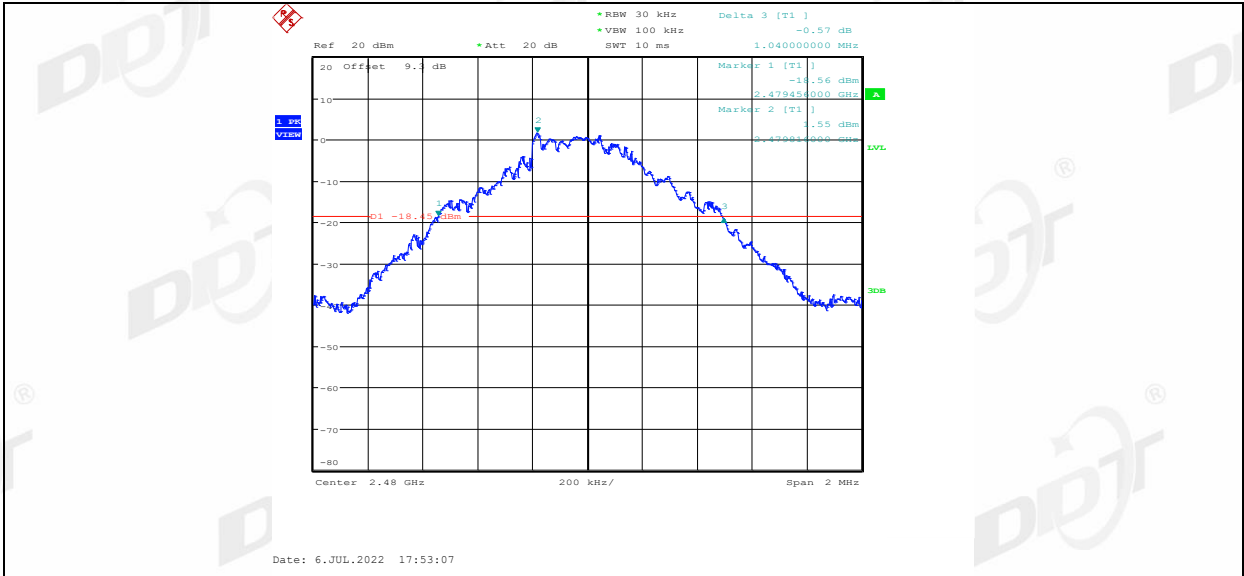

2DH5_Ant1_2402

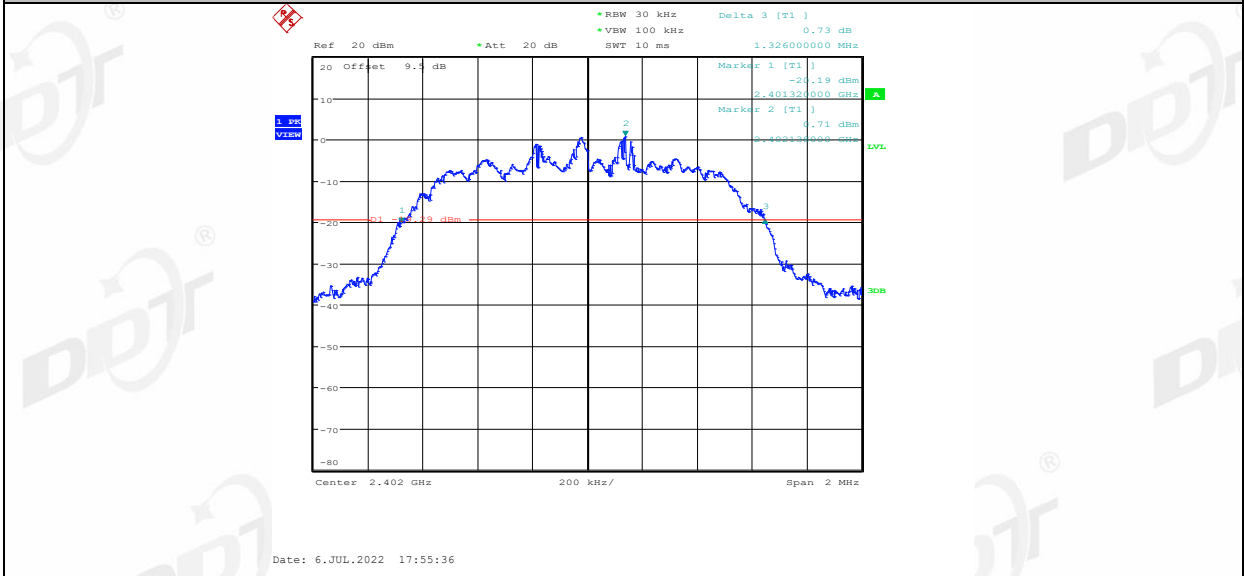

2DH5_Ant1_2441

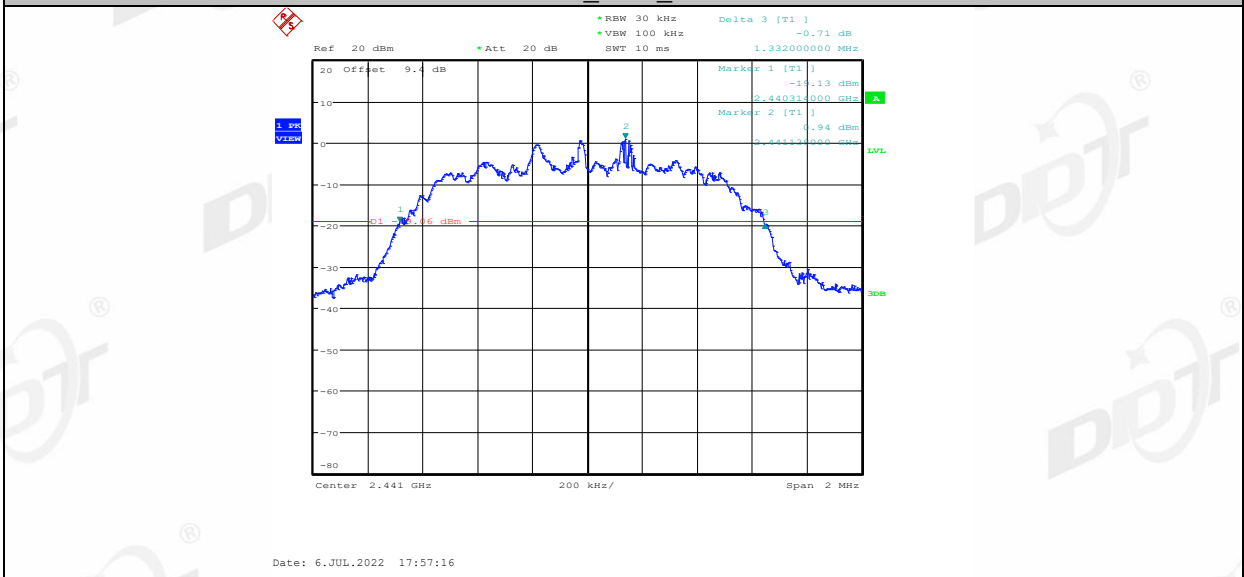

2DH5_Ant1_2480

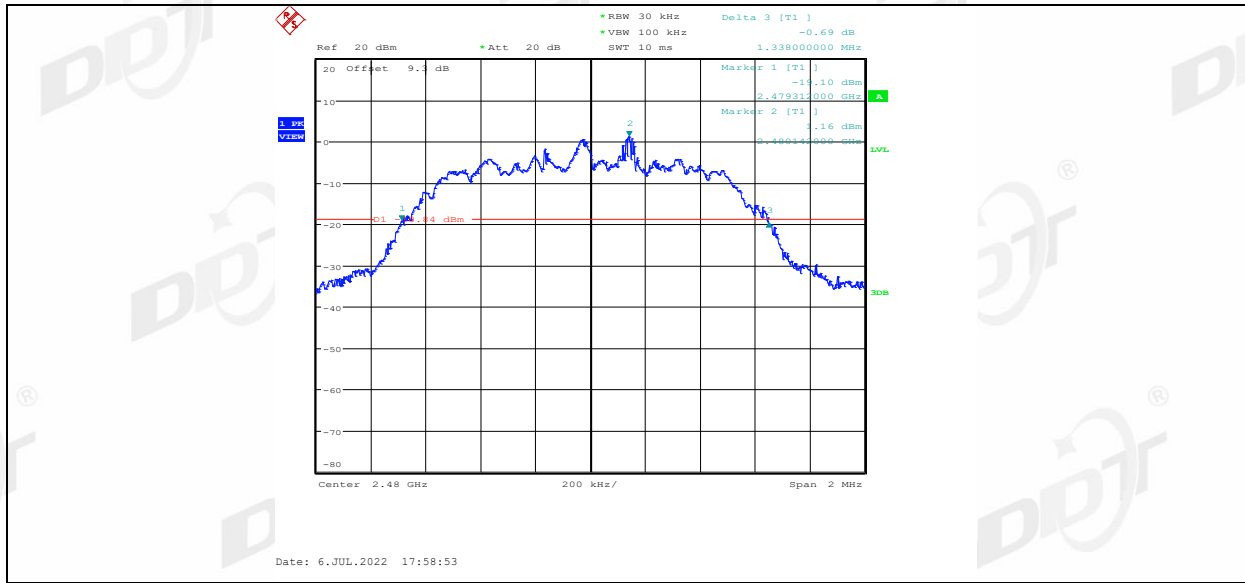

99% bandwidth:

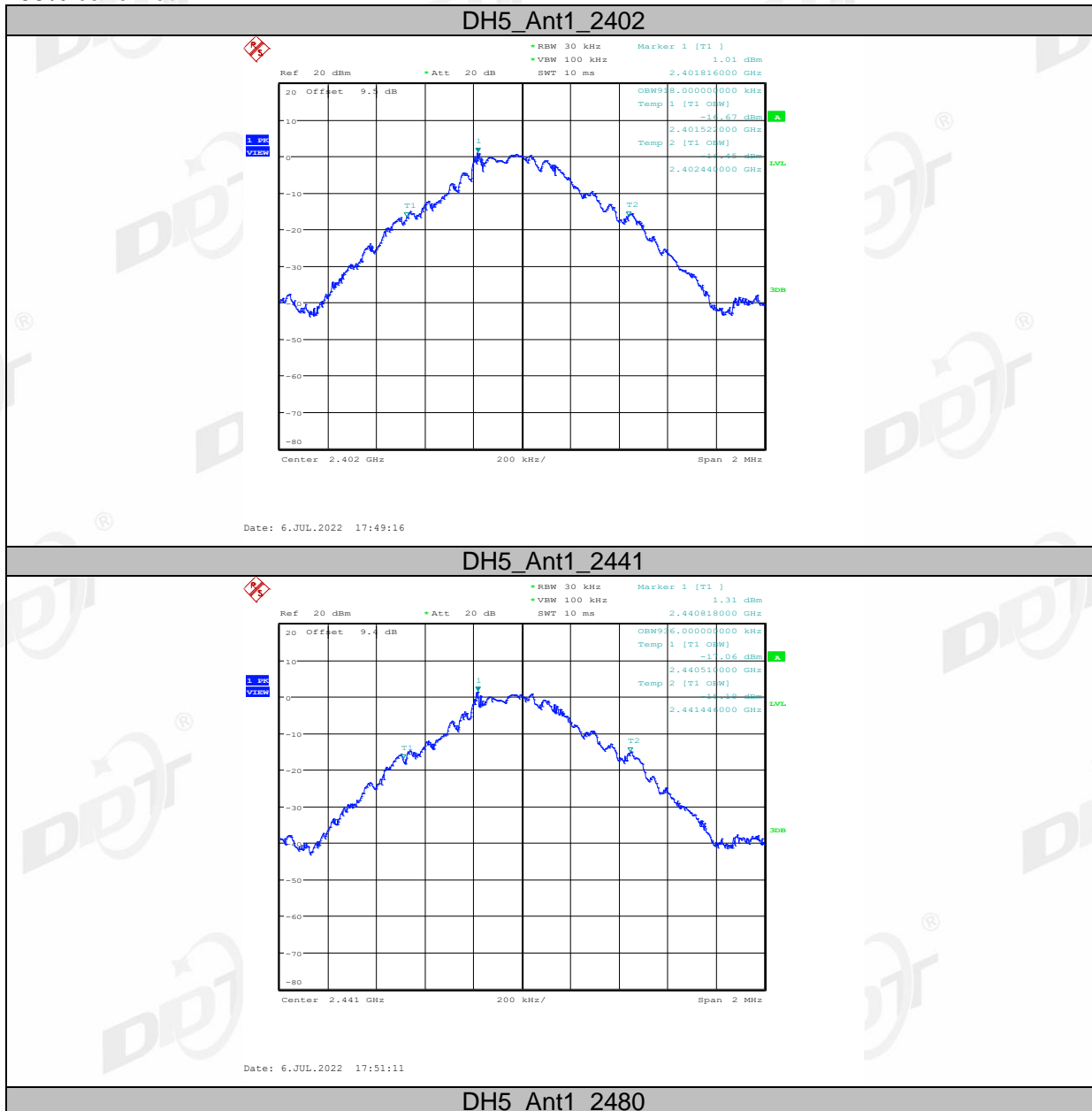

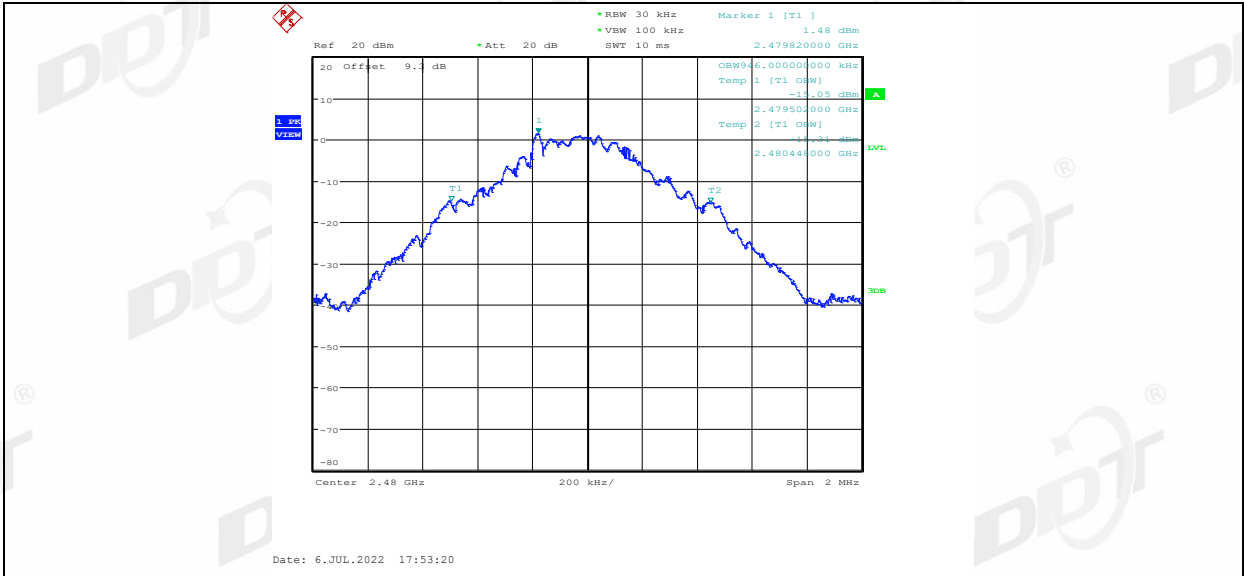

2DH5_Ant1_2402

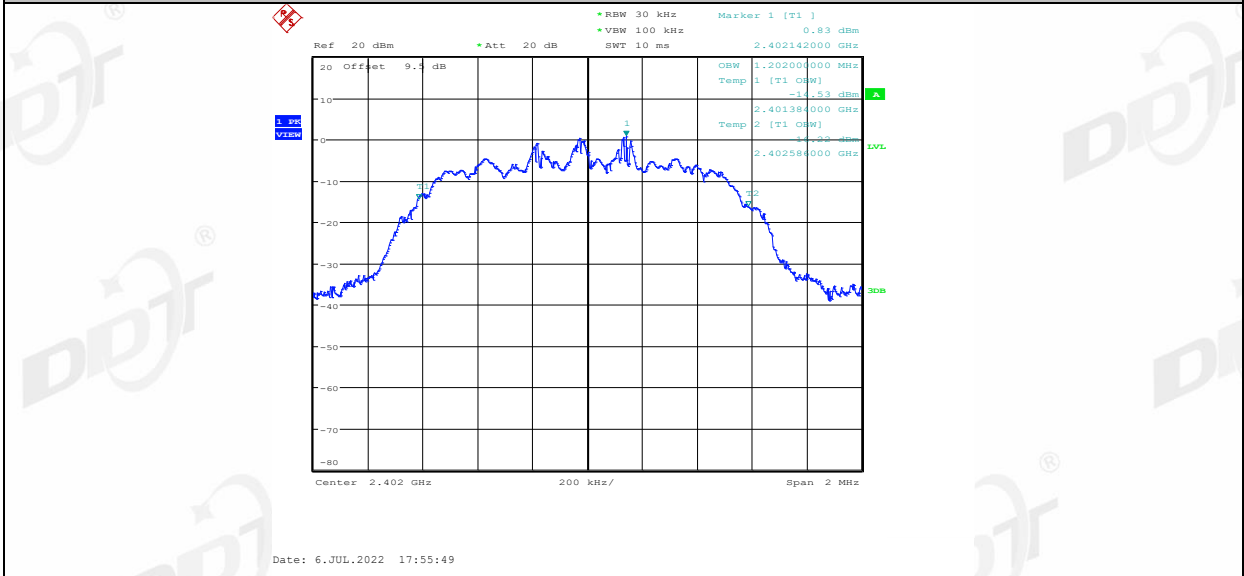

2DH5_Ant1_2441



2DH5_Ant1_2480

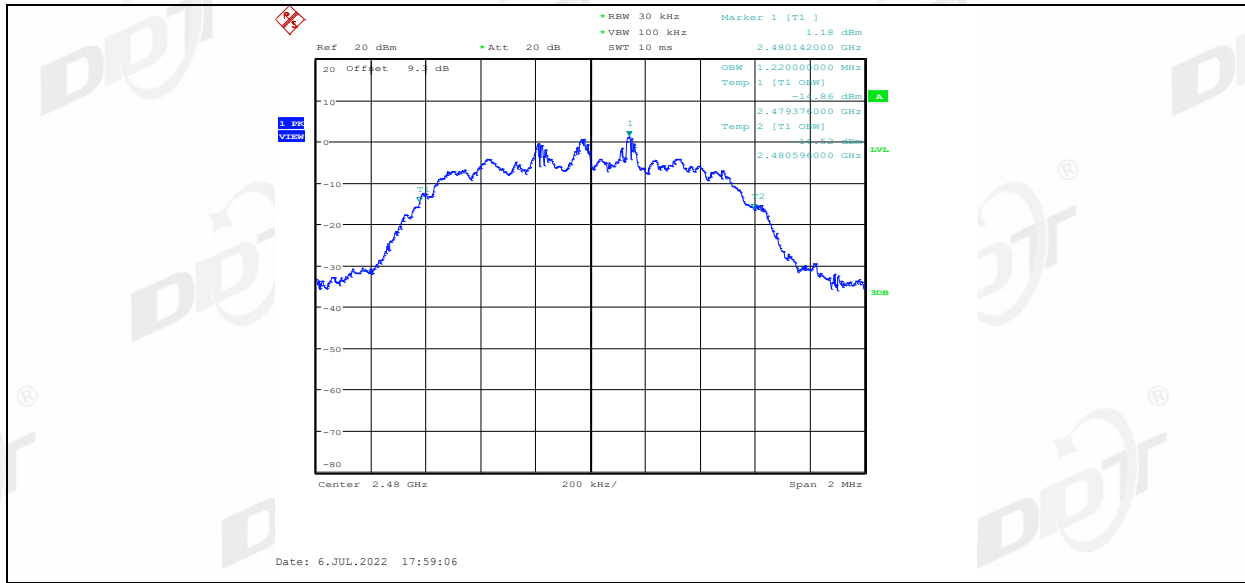

6. Carrier Frequency Separation

6.1. Block diagram of test setup

Same as section 4.1

6.2. Limits

Frequency hopping systems shall have hopping channel carrier frequencies separated by a minimum of 25 kHz or the 20 dB bandwidth of the hopping channel, whichever is greater.

Alternatively, frequency hopping systems operating in the 2400-2483.5 MHz band may have hopping channel carrier frequencies that are separated by 25 kHz or two-thirds of the 20 dB bandwidth of the hopping channel, whichever is greater, provided the systems operate with an output power no greater than 125 mW.

6.3. Test procedure

- (1) Connect EUT's antenna output to spectrum analyzer by RF cable.
- (2) The carrier frequency was measured by spectrum analyzer with 100 kHz RBW and 300 kHz VBW.

6.4. Test result

| Mode | Channel separation (MHz) | 20 dB bandwidth (MHz) (Worse case) | Limit (MHz) 2/3 of 20 dB bandwidth | Verdict |
|----------------|--------------------------|---------------------------------------|---------------------------------------|---------|
| GFSK | 1.013 | 1.040 | ≥0.694 | Pass |
| $\pi/4$ -DQPSK | 1.000 | 1.338 | ≥0.892 | Pass |

6.5. Original test data



7. Number of Hopping Channel

7.1. Block diagram of test setup

Same as section 4.1

7.2. Limits

Frequency hopping systems in the 2400-2483.5 MHz band shall use at least 15 channels.

7.3. Test procedure

- (1) Connect EUT's antenna output to spectrum analyzer by RF cable.
- (2) The number of hopping channels was measured by spectrum analyzer with 100 kHz RBW and 300 kHz VBW.

7.4. Test result

| Mode | Number of hopping channels | Limit | Verdict |
|----------------|----------------------------|-------|---------|
| GFSK | 79 | >15 | Pass |
| $\pi/4$ -DQPSK | 79 | >15 | Pass |

7.5. Original test data

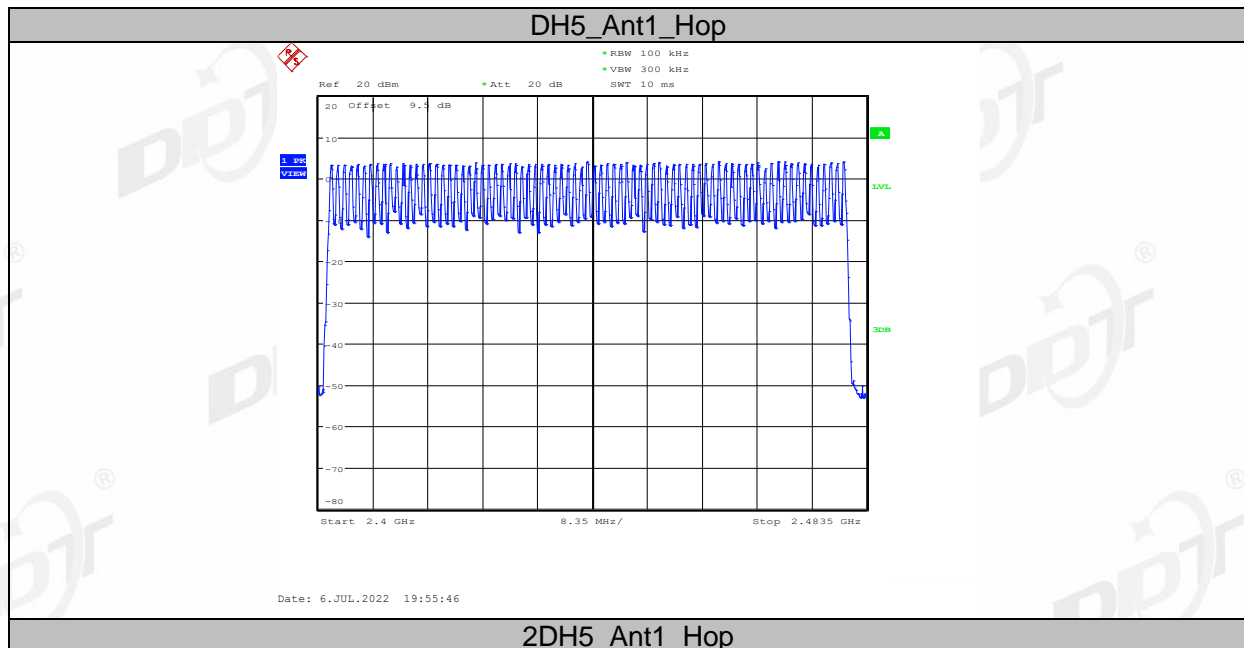

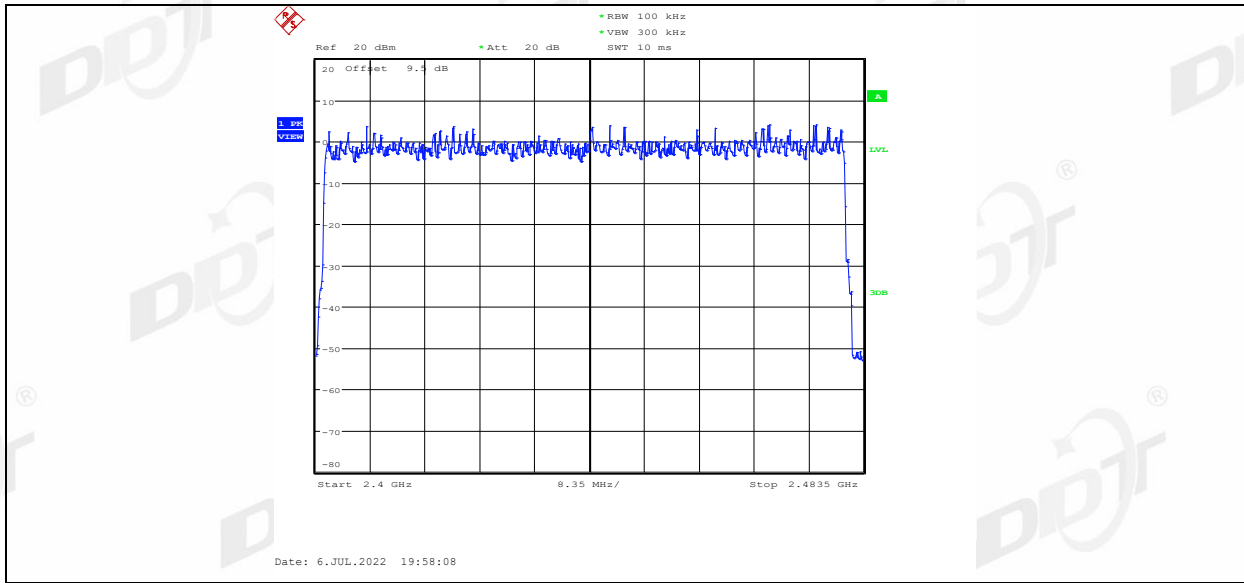

8. Dwell Time

8.1. Block diagram of test setup

Same as section 4.1

8.2. Limits

The average time of occupancy on any channel shall not be greater than 0.4 seconds within a period of 0.4 seconds multiplied by the number of hopping channels employed.

8.3. Test procedure

- (1) Connect EUT's antenna output to spectrum analyzer by RF cable.
- (2) The test period: $T = 0.4 \text{ Second/Channel} \times 79 \text{ Channel} = 31.6 \text{ s}$
- (3) Measure the hopping number and on time of each pulse with spectrum analyzer in zero span set, and calculate dwell time with formula $\text{Dwell time} = \text{total hops} \times \text{pulse's on time}$.

8.4. Test result

| Mode | Dwell time (s) | Pulse's on time (ms) | Total hops | Limit | Verdict |
|------|----------------|----------------------|------------|--------|---------|
| DH1 | 0.115 | 0.36 | 319 | <400ms | Pass |
| DH3 | 0.259 | 1.62 | 160 | <400ms | Pass |
| DH5 | 0.284 | 2.87 | 99 | <400ms | Pass |
| 2DH1 | 0.118 | 0.37 | 318 | <400ms | Pass |
| 2DH3 | 0.254 | 1.63 | 156 | <400ms | Pass |
| 2DH5 | 0.297 | 2.88 | 103 | <400ms | Pass |

Note: $\text{Dwell time} = \text{total hops} \times \text{pulse's on time}$.

8.5. Original test data



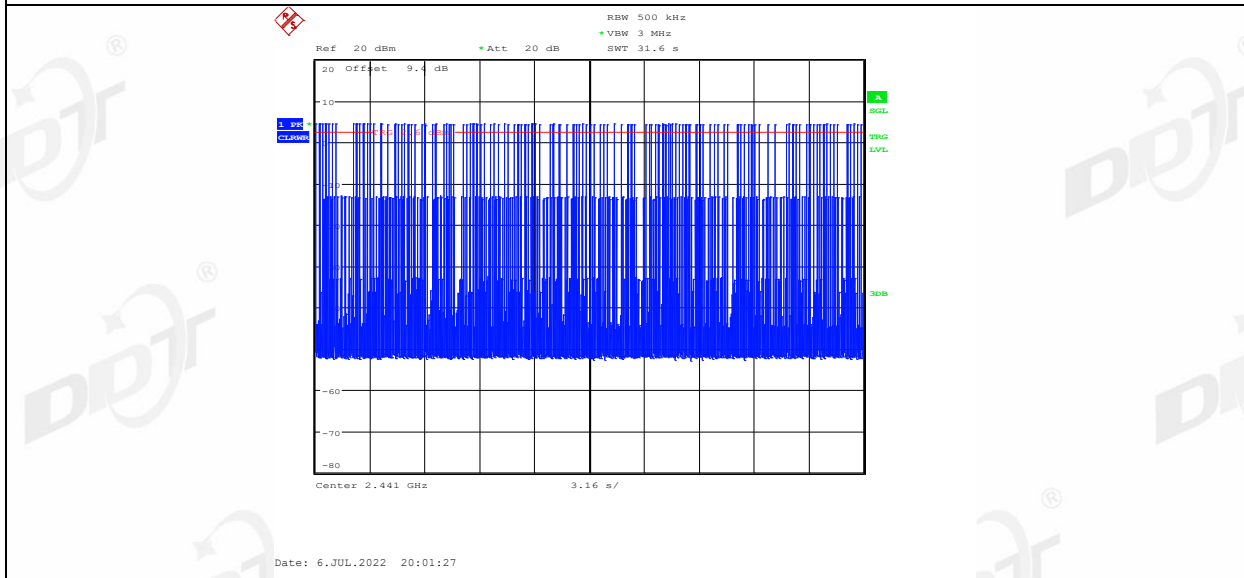
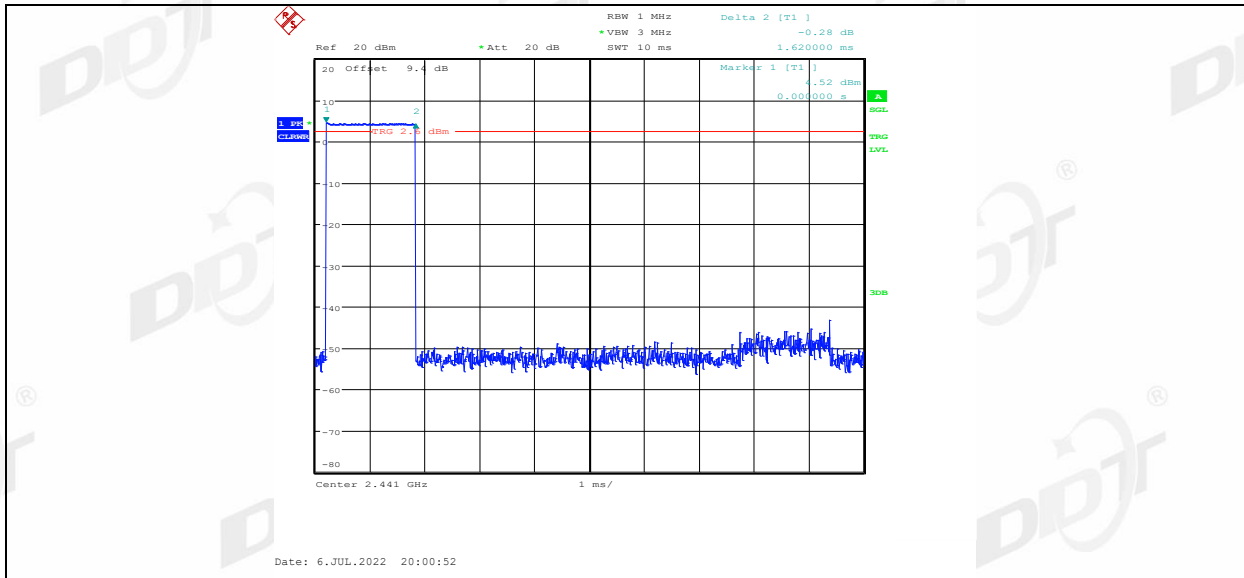

DH5_Ant1_Hop

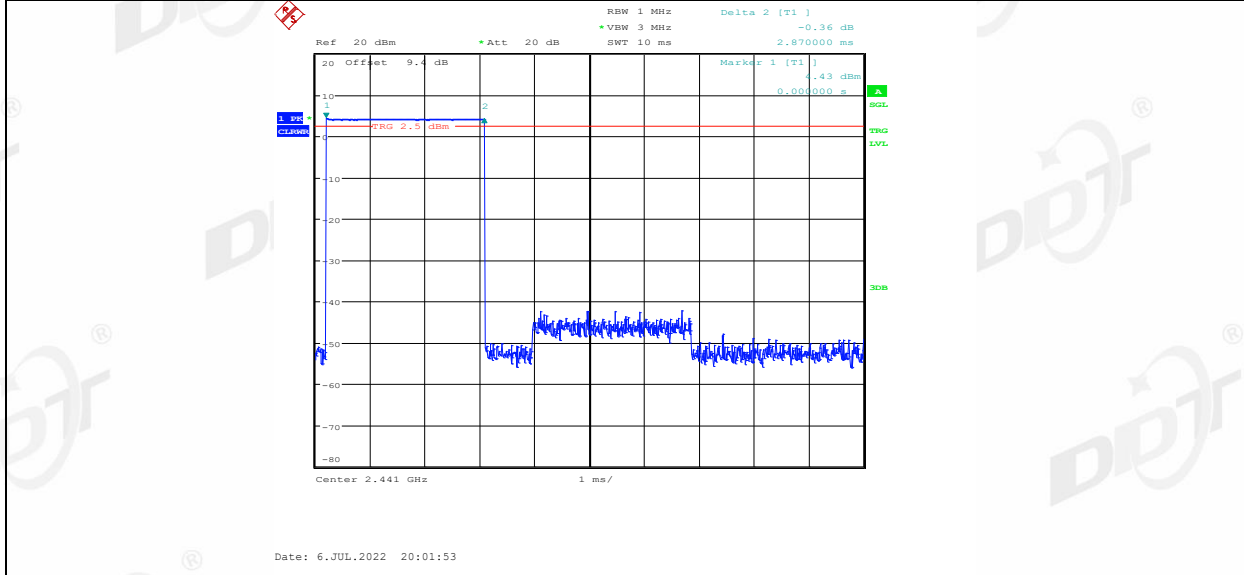

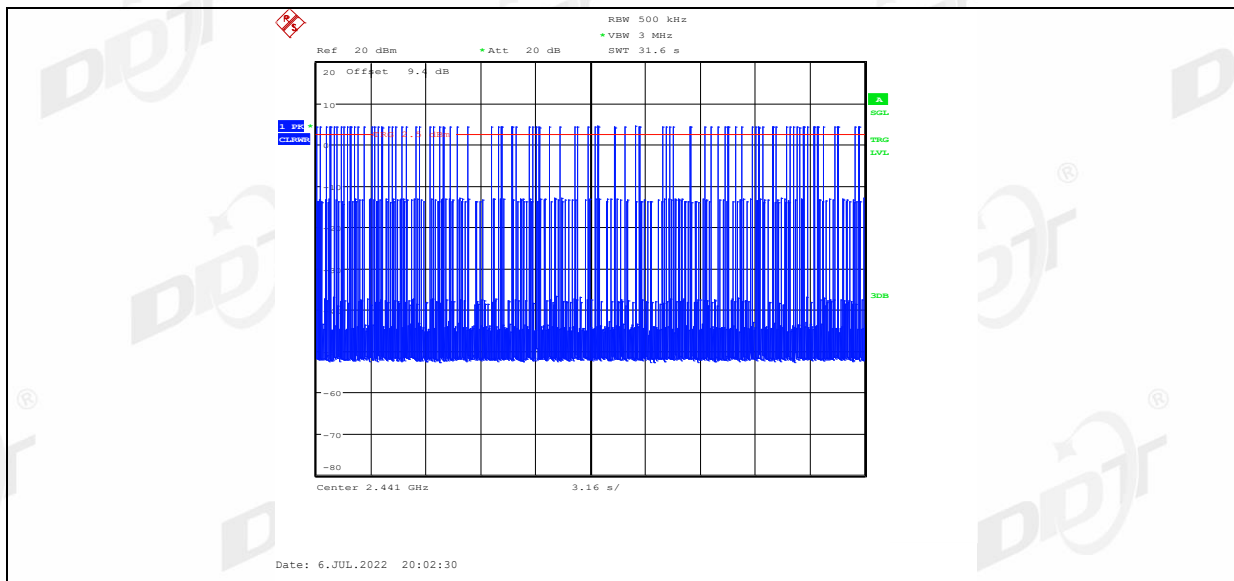

2DH1_Ant1_Hop

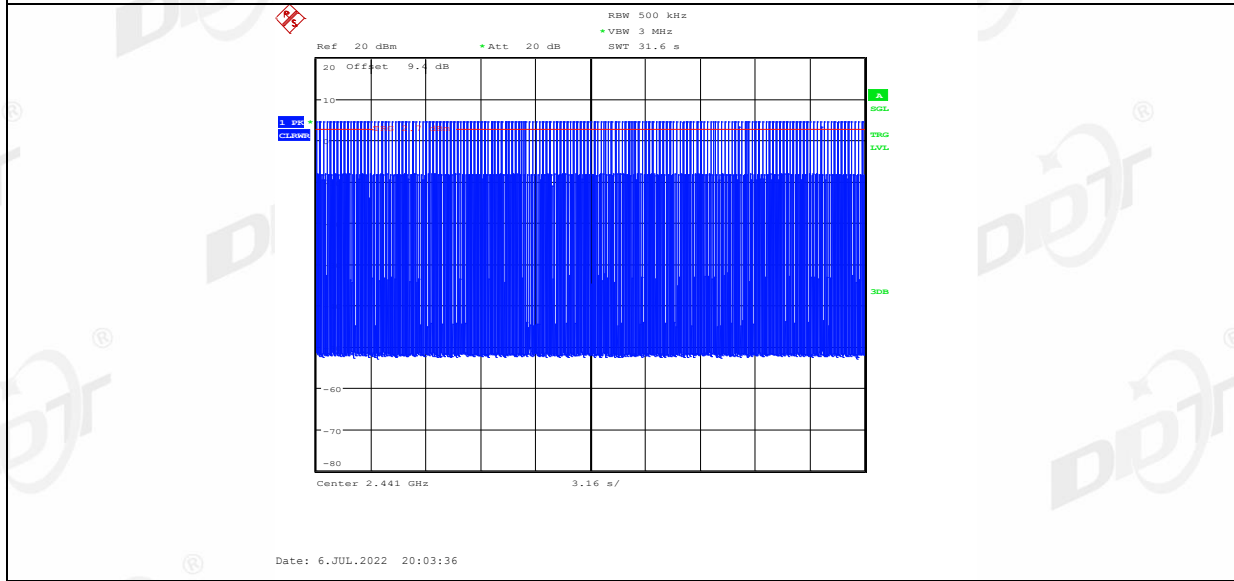
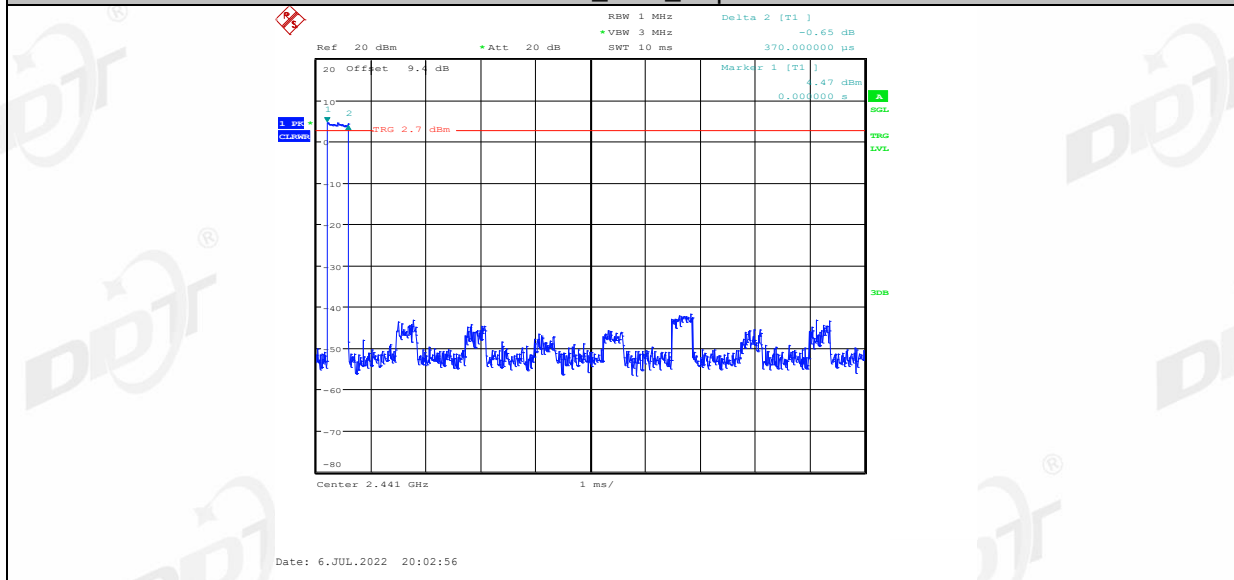

2DH3_Ant1_Hop

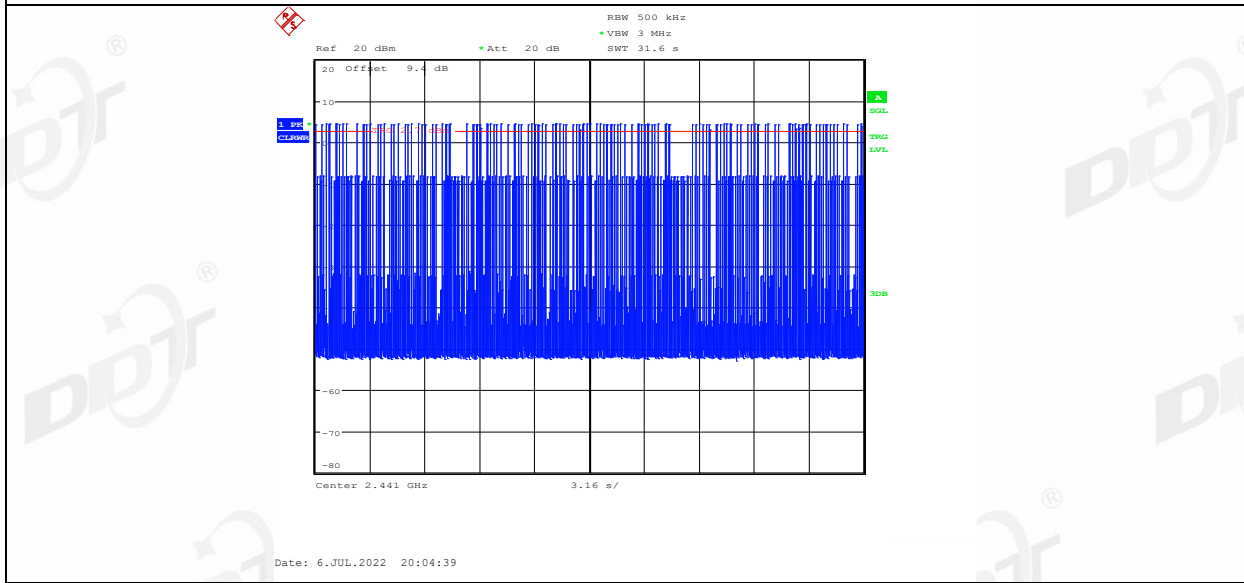
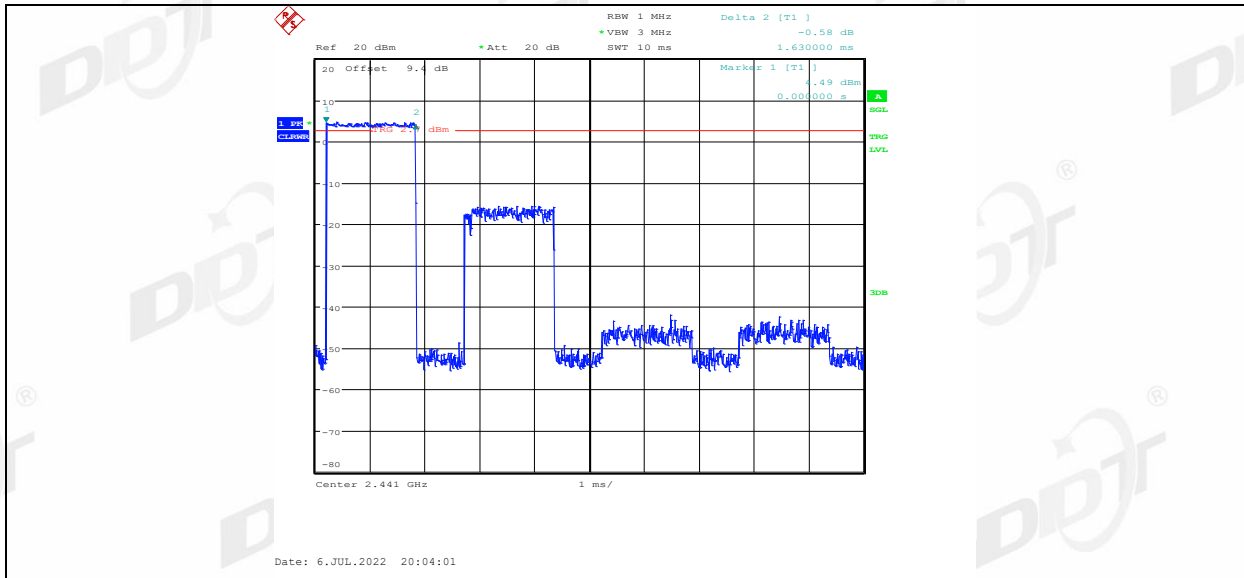

2DH5_Ant1_Hop

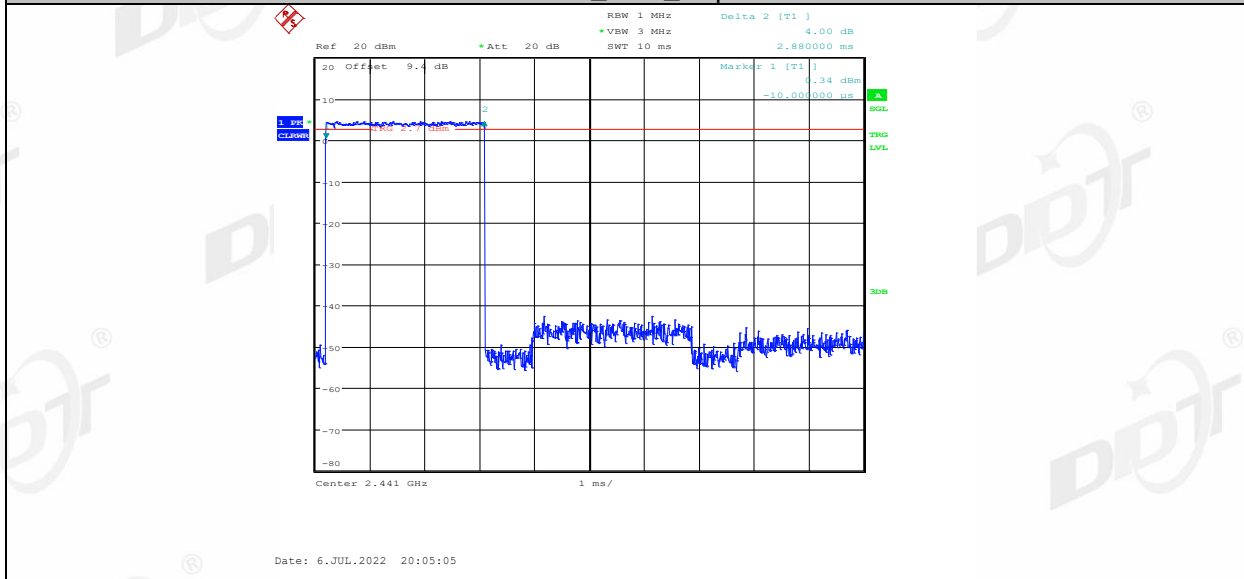

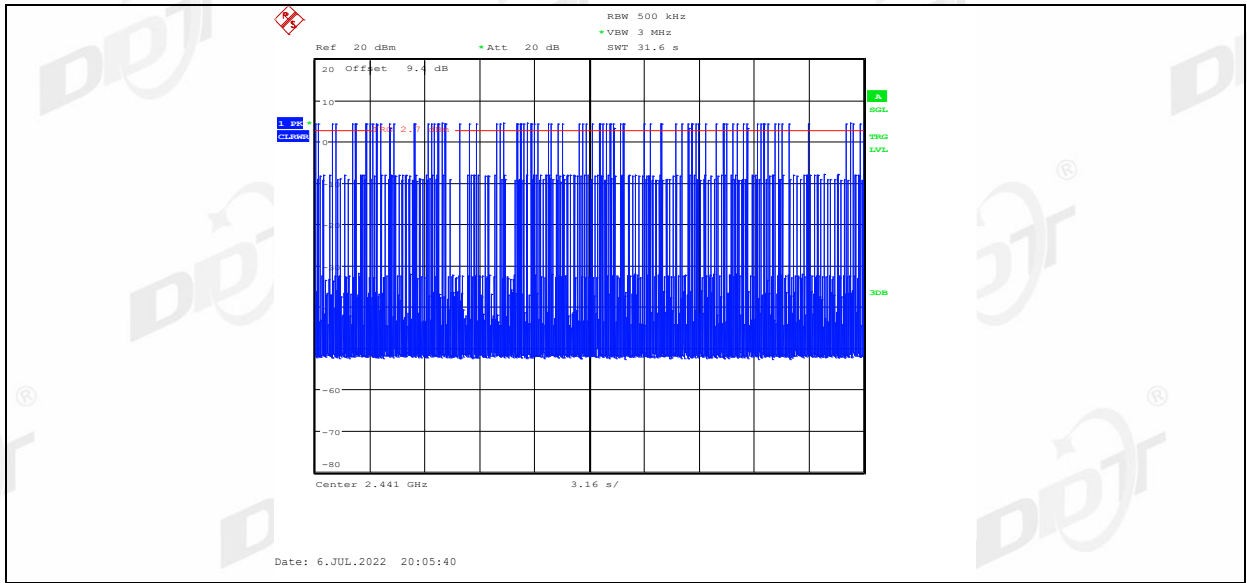

9. Band Edge Compliance (Conducted Method)

9.1. Block diagram of test setup

Same as section 4.1

9.2. Limit

All restriction band should comply with 15.209, other emission should be at least 20 dB below the fundamental.

9.3. Test result

| Mode | Freq. (MHz) | Verdict |
|----------------|------------------|---------|
| GFSK | Hopping off 2402 | Pass |
| | Hopping off 2480 | Pass |
| | Hopping on | Pass |
| $\pi/4$ -DQPSK | Hopping off 2402 | Pass |
| | Hopping off 2480 | Pass |
| | Hopping on | Pass |

9.4. Original test data

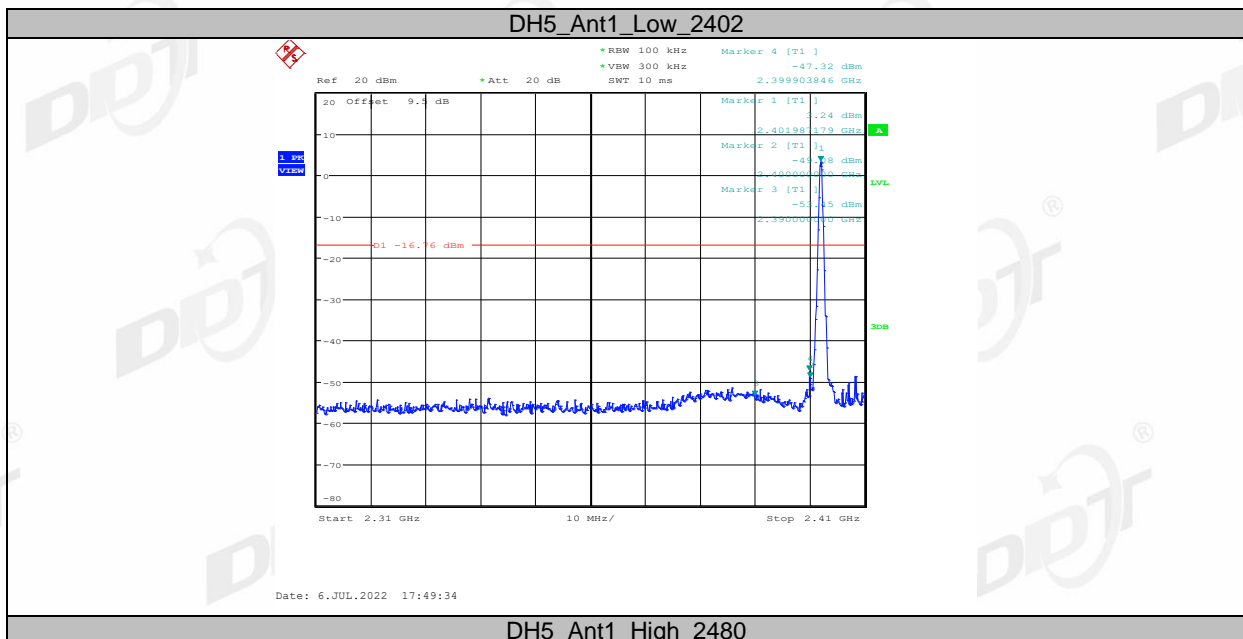

DH5_Ant1_High_2480

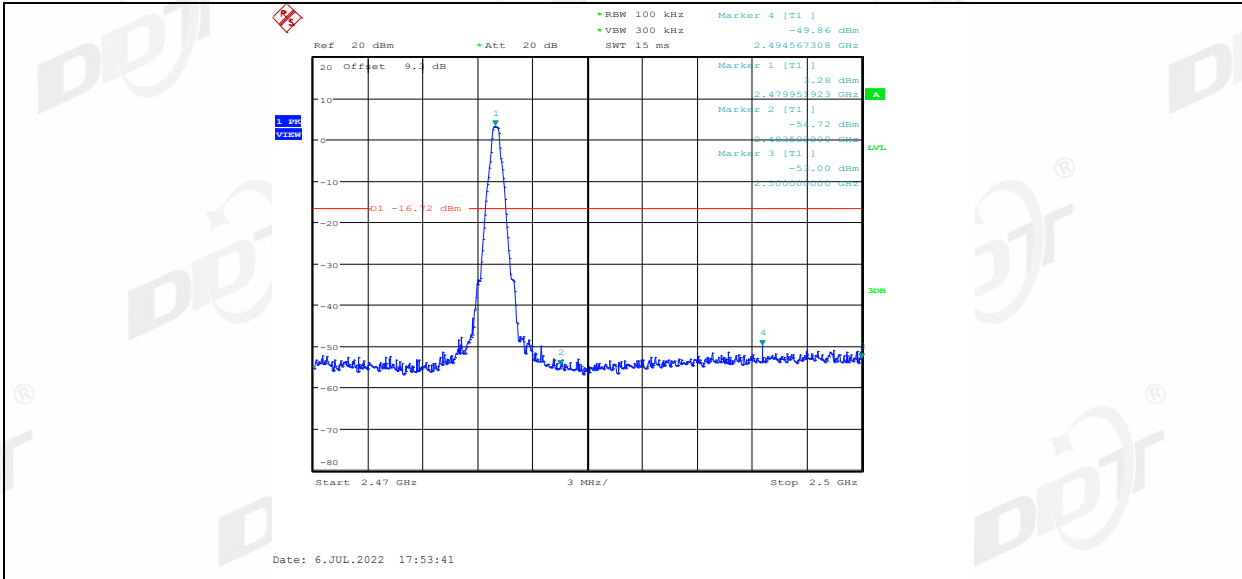

DH5_Ant1_Low_Hop

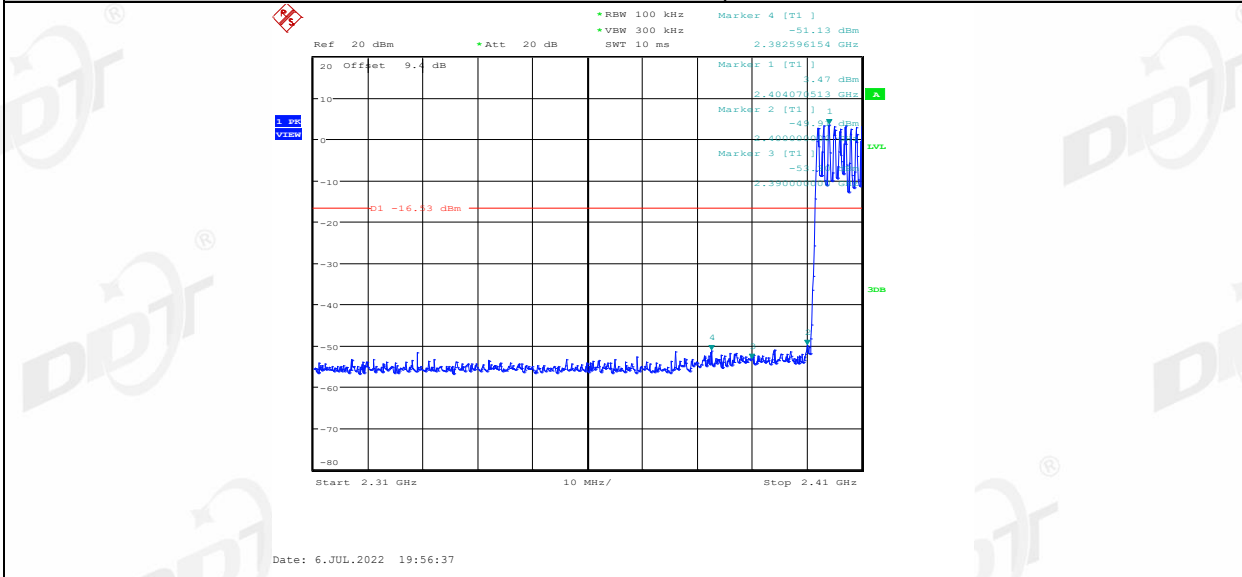

DH5_Ant1_High_Hop

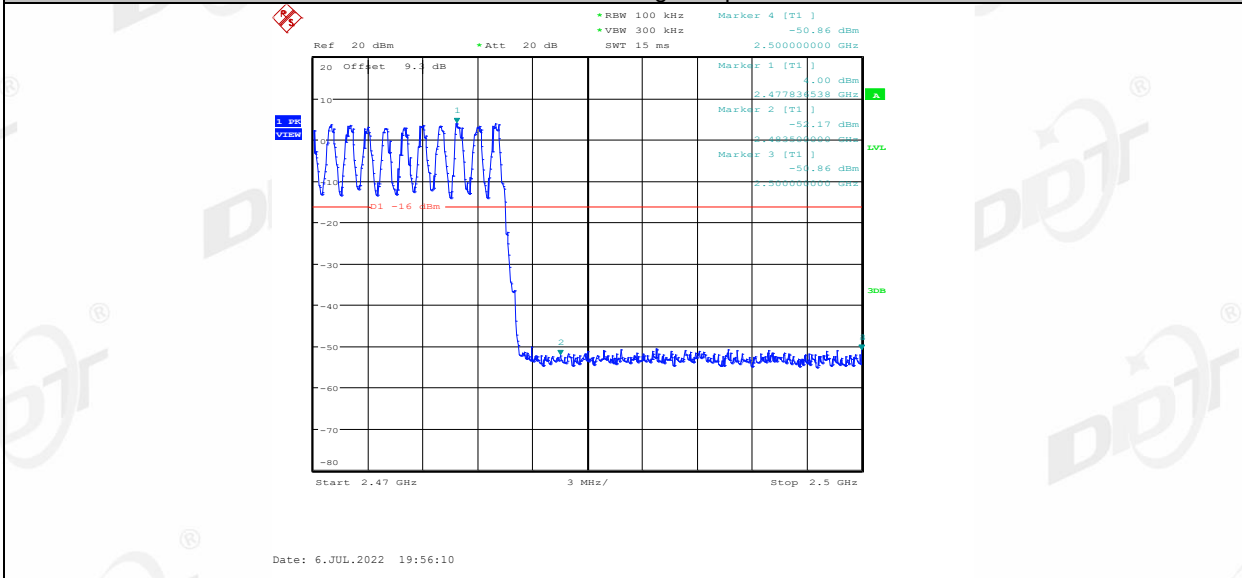

2DH5_Ant1_Low_2402

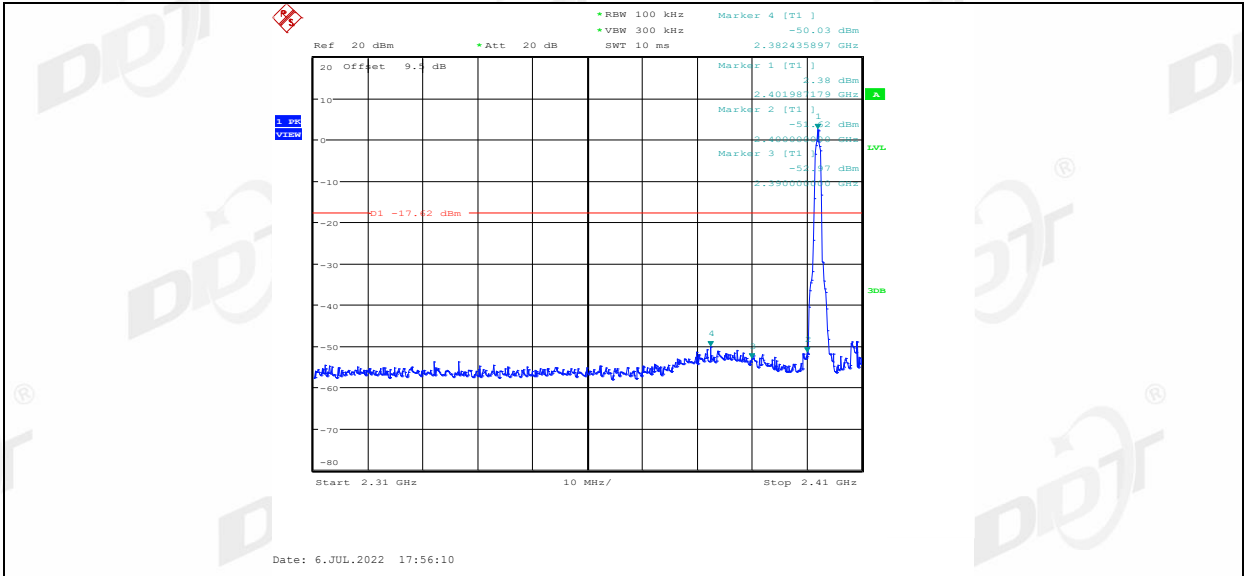

2DH5_Ant1_High_2480

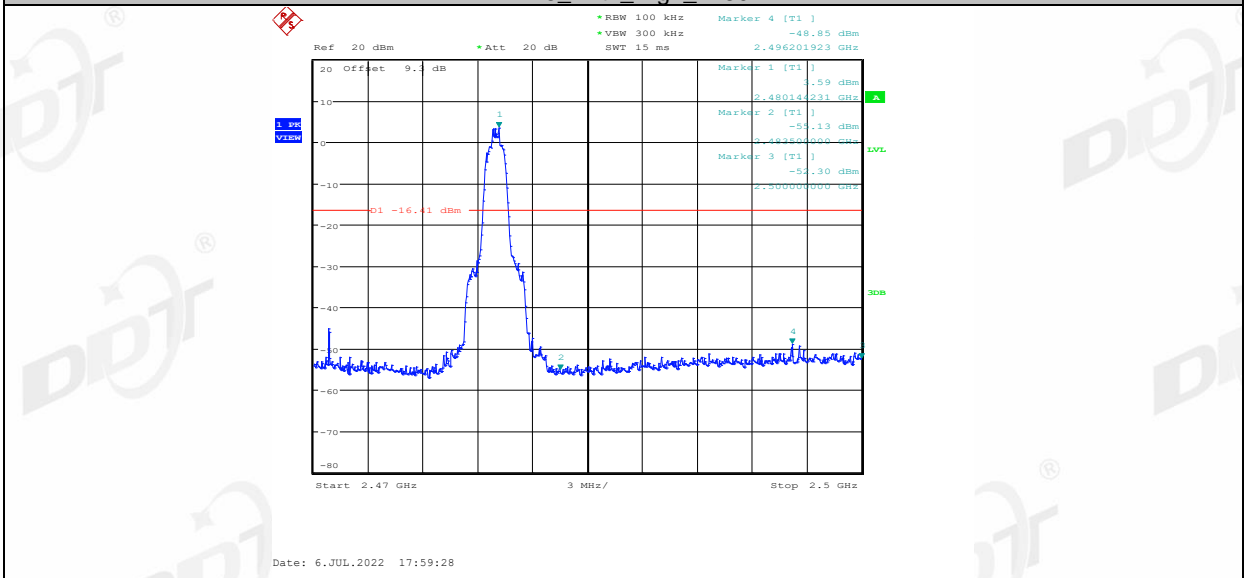

2DH5_Ant1_Low_Hop

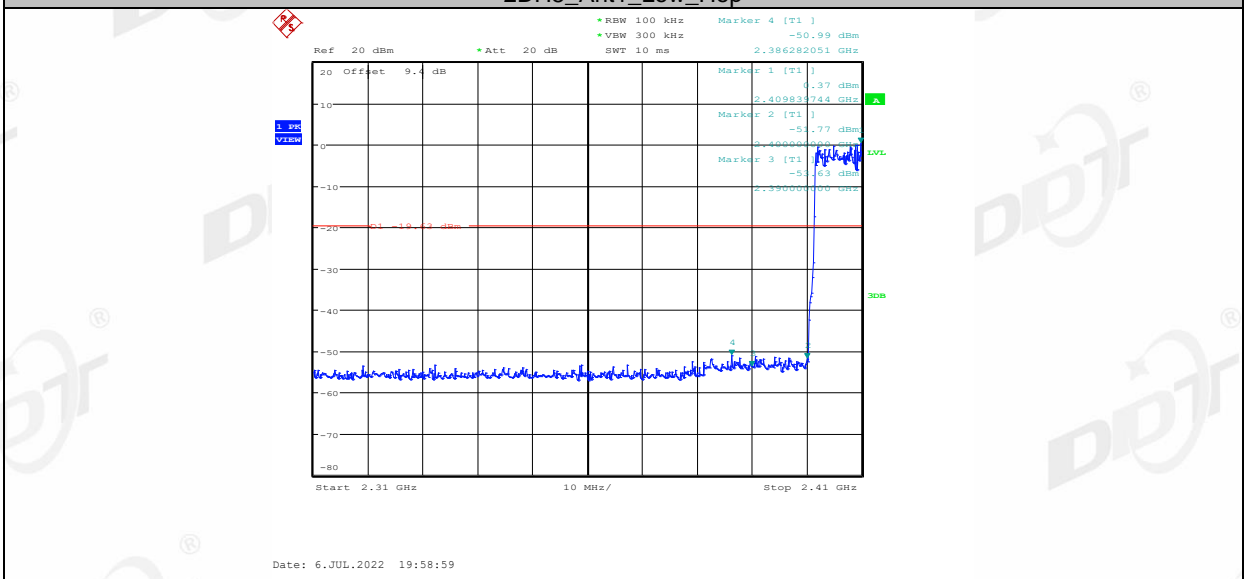

2DH5_Ant1_High_Hop

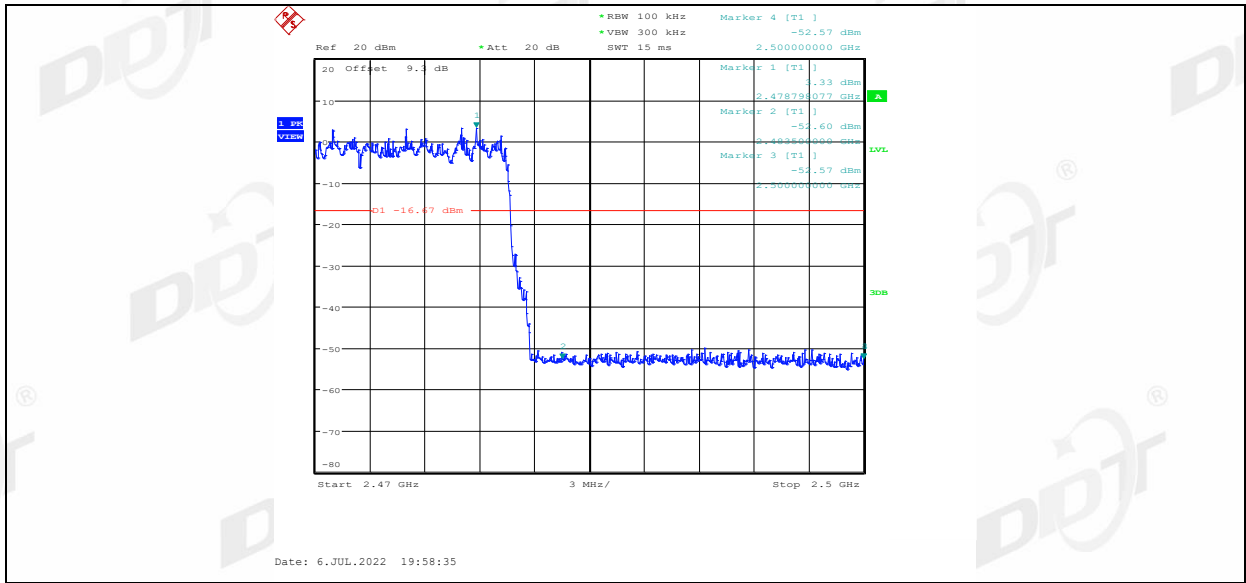

10. Radiated Emission

10.1. Block diagram of test setup

In 3 m Anechoic Chamber, test setup diagram for 9 kHz - 30 MHz:

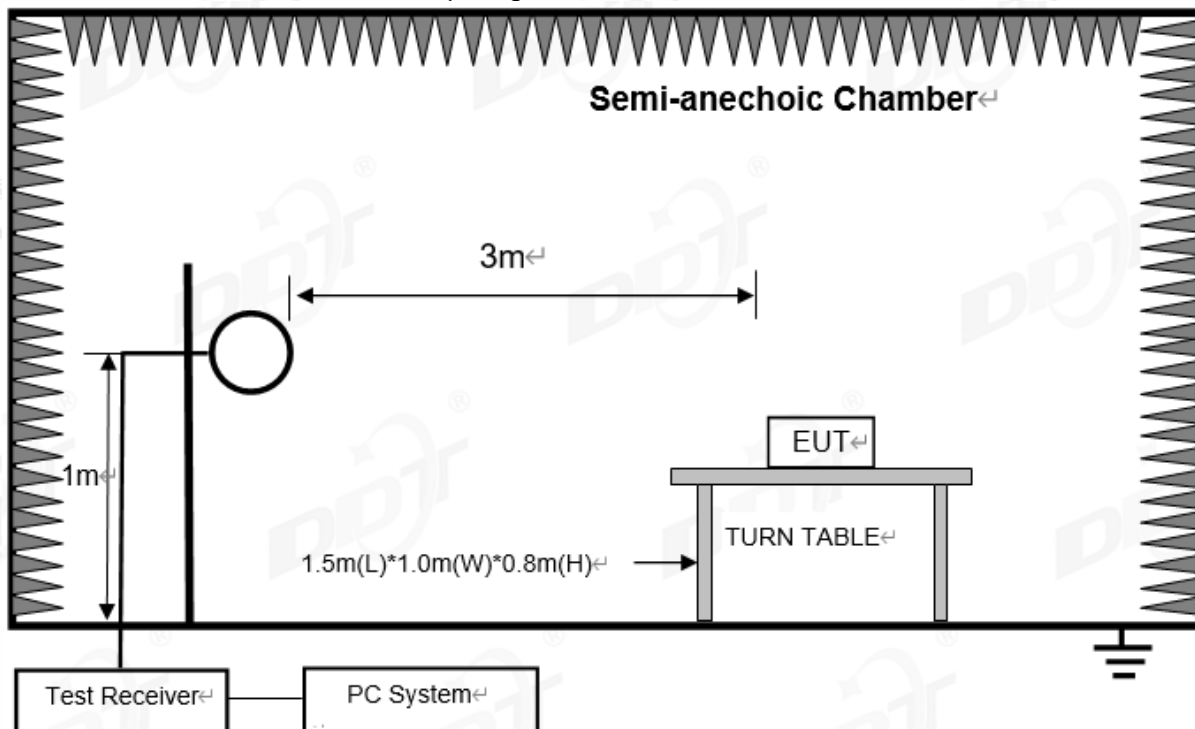

In 3 m Anechoic Chamber, test setup diagram for 30 MHz - 1 GHz:

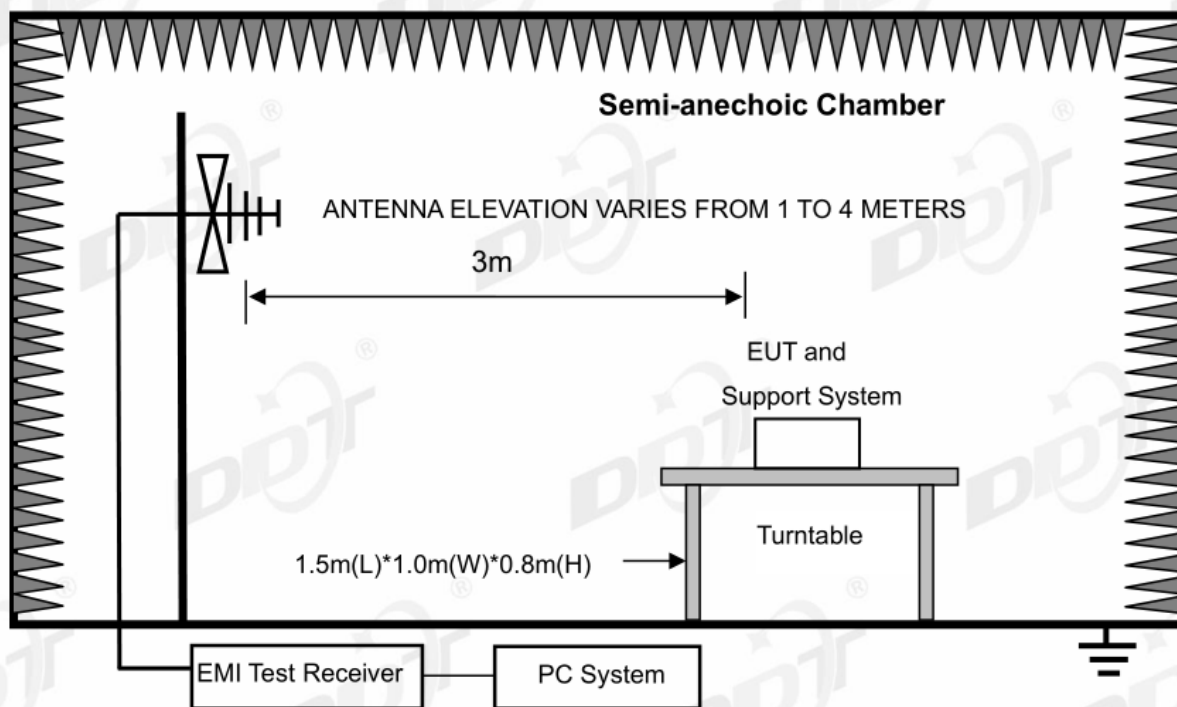

In 3 m Anechoic Chamber, test setup diagram for frequency above 1 GHz:

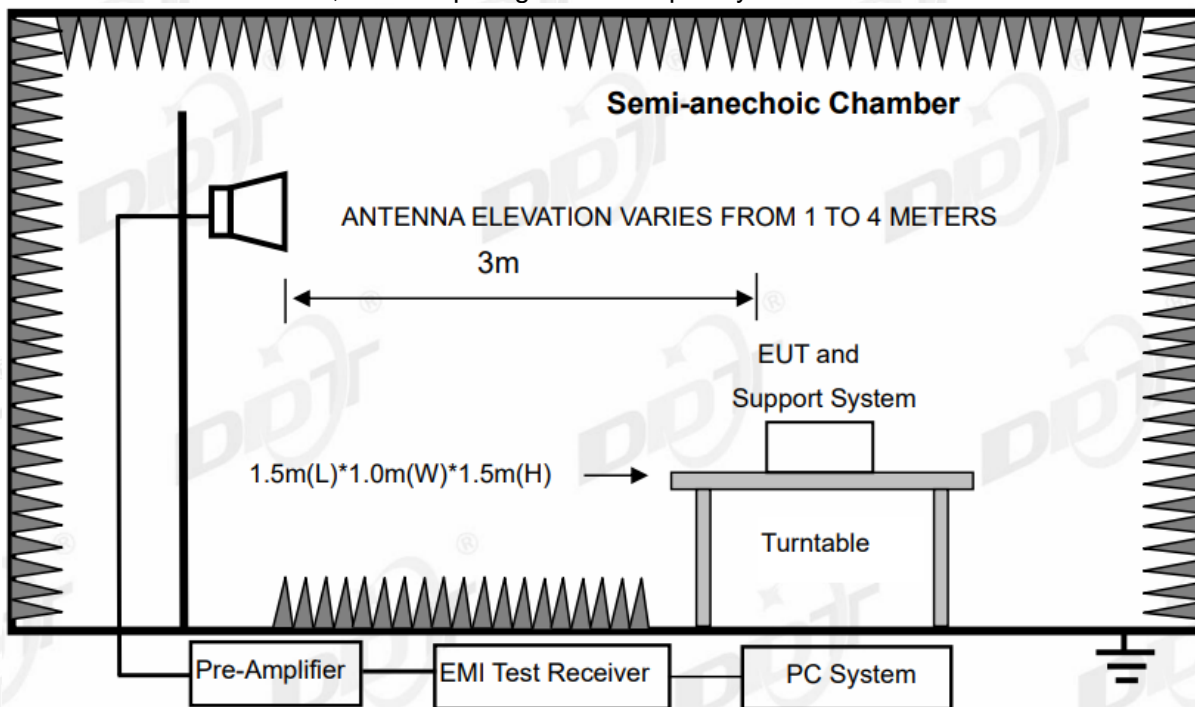

Note: For harmonic emissions test an appropriate high pass filter was inserted in the input port of AMP.

10.2. Limit

(1) FCC 15.205 Restricted frequency band

| MHz | MHz | MHz | GHz |
|--------------------------|---------------------|---------------|------------------|
| 0.090-0.110 | 16.42-16.423 | 399.9-410 | 4.5-5.15 |
| ¹ 0.495-0.505 | 16.69475-16.69525 | 608-614 | 5.35-5.46 |
| 2.1735-2.1905 | 16.80425-16.80475 | 960-1240 | 7.25-7.75 |
| 4.125-4.128 | 25.5-25.67 | 1300-1427 | 8.025-8.5 |
| 4.1772&4.17775 | 37.5-38.25 | 1435-1626.5 | 9.0-9.2 |
| 4.2072&4.20775 | 73-74.6 | 1645.5-1646.5 | 9.3-9.5 |
| 6.215-6.218 | 74.8-75.2 | 1660-1710 | 10.6-12.7 |
| 6.26775-6.26825 | 108-121.94 | 1718.8-1722.2 | 13.25-13.4 |
| 6.31175-6.31225 | 123-138 | 2200-2300 | 14.47-14.5 |
| 8.291-8.294 | 149.9-150.05 | 2310-2390 | 15.35-16.2 |
| 8.362-8.366 | 156.52475-156.52525 | 2483.5-2500 | 17.7-21.4 |
| 8.37625-8.38675 | 156.7-156.9 | 2690-2900 | 22.01-23.12 |
| 8.41425-8.41475 | 162.0125-167.17 | 3260-3267 | 23.6-24.0 |
| 12.29-12.293 | 167.72-173.2 | 3332-3339 | 31.2-31.8 |
| 12.51975-12.52025 | 240-285 | 3345.8-3358 | 36.43-36.5 |
| 12.57675-12.57725 | 322-335.4 | 3600-4400 | (²) |
| 13.36-13.41 | | | |

¹Until February 1, 1999, this restricted band shall be 0.490-0.510 MHz.

²Above 38.6

(2) FCC 15.209 Limit.

| Frequency (MHz) | Measurement distance (meters) | Field strength limit | |
|-----------------|-------------------------------|---------------------------------------------------------------------------|-----------------------------------|
| | | $\mu\text{V}/\text{m}$ | $\text{dB}(\mu\text{V})/\text{m}$ |
| 0.009 ~ 0.490 | 300 | 2400/F(kHz) | 67.6-20log(F) |
| 0.490 ~ 1.705 | 30 | 24000/F(kHz) | 87.6-20log(F) |
| 1.705 ~ 30.0 | 30 | 30 | 29.54 |
| 30 ~ 88 | 3 | 100 | 40.0 |
| 88 ~ 216 | 3 | 150 | 43.5 |
| 216 ~ 960 | 3 | 200 | 46.0 |
| 960 ~ 1000 | 3 | 500 | 54.0 |
| Above 1000 | 3 | 74.0 dB(μV)/m (Peak) 54.0 dB(μV)/m (Average) | |

Note: (1) The emission limits shown in the above table are based on measurements employing a CISPR QP detector except for the frequency bands 9-90 kHz, 110-490 kHz and above 1000 MHz, radiated emissions limits in these three bands are based on measurements employing an average detector.

(2) At frequencies below 30 MHz, measurement may be performed at a distance closer than that specified, and the limit at closer measurement distance can be extrapolated by below formula:

$$\text{Limit}_{3\text{m}}(\text{dB}\mu\text{V}/\text{m}) = \text{Limit}_{30\text{m}}(\text{dB}\mu\text{V}/\text{m}) + 40\text{Log}(30\text{m}/3\text{m})$$

(3) Limit for this EUT

All the emissions appearing within 15.205 restricted frequency bands shall not exceed the limits shown in 15.209, all the other emissions shall be at least 20 dB below the fundamental emissions or comply with 15.209 limits.

10.3. Test procedure

- (1) EUT was placed on a non-metallic table, 80 cm above the ground plane inside a semi-anechoic chamber for below 1 G and 150 cm above the ground plane inside a semi-anechoic chamber for above 1 G.
- (2) Test antenna was located 3 m from the EUT on an adjustable mast, and the antenna used as below table.

| Test frequency range | Test antenna used | Test antenna distance |
|----------------------|------------------------------------------------|-----------------------|
| 9 kHz - 30 MHz | Active Loop antenna | 3 m |
| 30 MHz - 1 GHz | Trilog Broadband Antenna | 3 m |
| 1 GHz - 18 GHz | Double Ridged Horn Antenna (1 GHz - 18 GHz) | 3 m |
| 18 GHz - 40 GHz | Horn Antenna (18 GHz - 40 GHz) | 1 m |

According ANSI C63.10:2013 clause 6.4.4.2 and 6.5.3, for measurements below 30 MHz, the loop antenna was located 3 m from EUT, the loop antenna was positioned in three antenna

orientations (parallel, perpendicular, and round-parallel), for each measurement antenna alignment, the EUT shall be rotated through 0° to 360° on a turntable, and the lowest height of the magnetic antenna shall be 1 m above the ground. For measurement above 30 MHz, the Broadband Antenna or Horn Antenna was located 3 m from EUT, Measurements were made with the antenna positioned in both the horizontal and vertical planes of Polarization, and the measurement antenna was varied from 1 m to 4 m. in height above the reference ground plane to obtain the maximum signal strength.

(3) Below pre-scan procedure was first performed in order to find prominent frequency spectrum radiated emissions from 9 kHz to 25 GHz:

(a) Scanning the peak frequency spectrum with the antenna specified in step (3), and the EUT was rotated 360 degree, the antenna height was varied from 1 m to 4 m (Except loop antenna, it's fixed 1 m above ground.)

(b) Change work frequency or channel of device if practicable.

(c) Change modulation type of device if practicable.

(d) Change power supply range from 85% to 115% of the rated supply voltage

(e) Rotated EUT though three orthogonal axes to determine the attitude of EUT arrangement produces highest emissions.

Spectrum frequency from 9 kHz to 25 GHz (tenth harmonic of fundamental frequency) was investigated, and no any obvious emission were detected from 18 GHz to 25 GHz, so below final test was performed with frequency range from 9 kHz to 18 GHz.

(4) For final emissions measurements at each frequency of interest, the EUT was rotated and the antenna height was varied between 1 m and 4 m in order to maximize the emission.

Measurements in both horizontal and vertical polarities were made and the data was recorded.

In order to find the maximum emission, the relative positions of equipment and all of the interface cables were changed according to ANSI C63.10:2013 on Radiated Emission test.

(5) The emissions from 9 kHz to 1 GHz were measured based on CISPR QP detector except for the frequency bands 9-90 kHz, 110-490 kHz, for emissions from 9 kHz - 90 kHz, 110 kHz - 490 kHz and above 1 GHz were measured based on average detector, for emissions above 1 GHz, peak emissions also be measured and need comply with Peak limit.

(6) The emissions from 9 kHz to 1 GHz, QP or average values were measured with EMI receiver with below RBW.

| Frequency band | RBW |
|------------------|---------|
| 9 kHz - 150 kHz | 200 Hz |
| 150 kHz - 30 MHz | 9 kHz |
| 30 MHz - 1 GHz | 120 kHz |

(7) For emissions above 1 GHz, both Peak and Average level were measured with Spectrum Analyzer, and the RBW is set at 1 MHz, VBW is set at 3 MHz for Peak measure; according ANSI C63.10:2013 clause 4.1.4.2 procedure for average measure.

10.4. Test result

Pass. (See below detailed test result)

All the emissions except fundamental emission from 9 kHz to 25 GHz were comply with 15.209 limits.

Note1: According exploratory test, the emission levels are 20 dB below the limit detected from 9 kHz to 30 MHz and 18 GHz to 25 GHz, so the final test was performed with frequency range from 30 MHz to 18 GHz and recorded in below.

Note2: For emissions below 1 GHz, according exploratory explorer test, when change Tx mode and channel, have no distinct influence on emissions level, so for emissions below 1 GHz, the final test was only performed with EUT working in $\pi/4$ -DQPSK, Tx 2480 MHz mode.

Note3: For emissions above 1 GHz, Scan with GFSK, $\pi/4$ -DQPSK, the worst case is $\pi/4$ -DQPSK. Mode. If peak results comply with AV limit, AV Result is deemed to comply with AV limit. Other emissions are attenuated 20 dB below the limits, so it does not record.

Radiated Emission test (below 1 GHz)

TR-4-E-009 Radiated Emission Test Result

Test Site : DDT 3m Chamber 3#

D:\E3 6.111\2022 Report Data\Q22061414-4E
aGROOVE-MINI\FCC BELOW 1G.EM6

Test Date : 2022-07-08

Tested By : Bairong

EUT : Bluetooth Speaker

Model Number : aGROOVE MINI

Power Supply : Battery

Test Mode : TX mode

Condition : Temp:23.3°C,Humi:54.1%,Press:100.3kPa **Antenna/Distance** : 2021 VLUB 9163 #3/3m/HORIZONTAL

Memo :

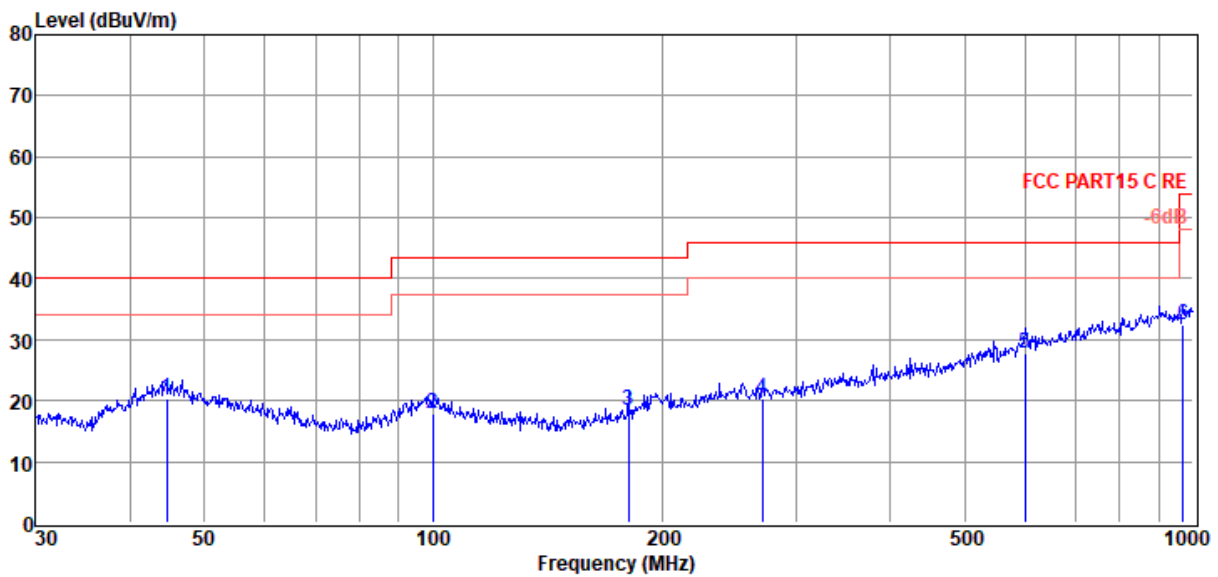

| Item (Mark) | Freq. (MHz) | Read Level (dBμV) | Antenna Factor (dB/m) | Cable Loss (dB) | Result Level (dBμV/m) | Limit Line (dBμV/m) | Over Limit (dB) | Detector | Polarization |
|-------------|-------------|-------------------|-----------------------|-----------------|-----------------------|---------------------|-----------------|----------|--------------|
| 1 | 44.59 | 1.61 | 15.06 | 3.64 | 20.31 | 40.00 | -19.69 | QP | HORIZONTAL |
| 2 | 99.88 | 2.42 | 11.50 | 3.98 | 17.90 | 43.50 | -25.60 | QP | HORIZONTAL |
| 3 | 180.65 | 4.67 | 9.36 | 4.38 | 18.41 | 43.50 | -25.09 | QP | HORIZONTAL |
| 4 | 271.33 | 3.11 | 12.63 | 4.73 | 20.47 | 46.00 | -25.53 | QP | HORIZONTAL |
| 5 | 601.43 | 2.92 | 19.13 | 5.74 | 27.79 | 46.00 | -18.21 | QP | HORIZONTAL |
| 6 | 968.93 | 3.53 | 22.18 | 6.67 | 32.38 | 54.00 | -21.62 | QP | HORIZONTAL |

Note: 1. Result Level = Read Level + Antenna Factor + Cable loss.

2. If Peak Result complies with QP limit, QP Result is deemed to comply with QP limit.

3. Test setup: RBW: 120 kHz, VBW: 300 kHz, Sweep time: auto.

TR-4-E-009 Radiated Emission Test Result

Test Site : DDT 3m Chamber 3# D:\E3 6.111\2022 Report Data\Q22061414-4E aGROOVE-MINI\FCC BELOW 1G.EM6
Test Date : 2022-07-08 **Tested By** : Bairong
EUT : Bluetooth Speaker **Model Number** : aGROOVE MINI
Power Supply : Battery **Test Mode** : TX mode
Condition : Temp:23.3°C,Humi:54.1%,Press:100.3kPa **Antenna/Distance** : 2021 VLUB 9163 #3/3m/VERTICAL
Memo :

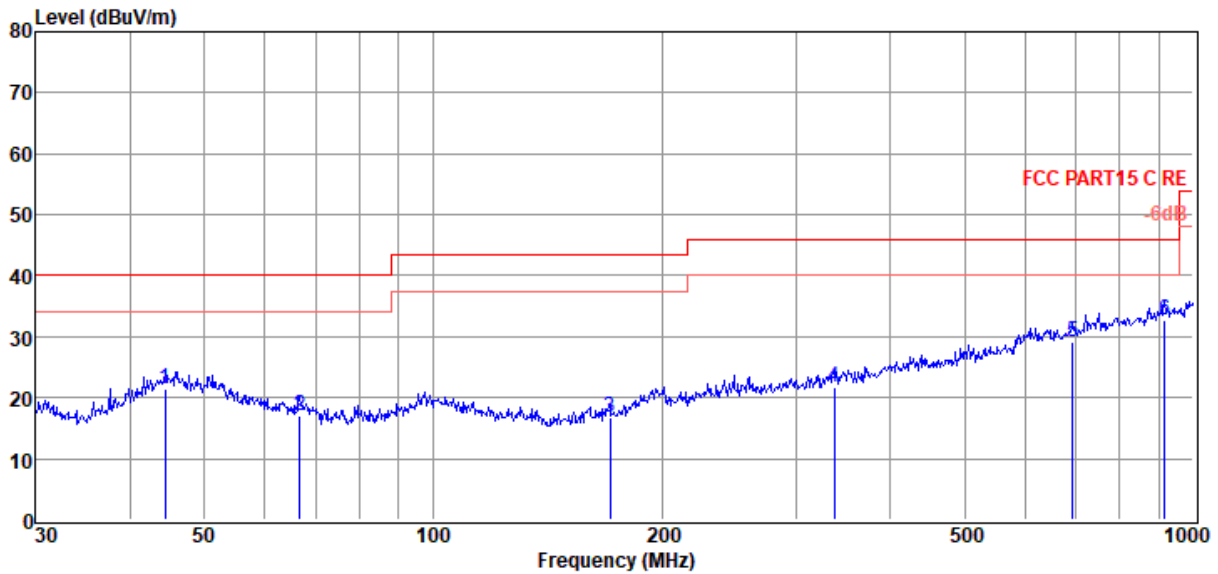

| Item (Mark) | Freq. (MHz) | Read Level (dBuV) | Antenna Factor (dB/m) | Cable Loss (dB) | Result Level (dBuV/m) | Limit Line (dBuV/m) | Over Limit (dB) | Detector | Polarization |
|-------------|-------------|-------------------|-----------------------|-----------------|-----------------------|---------------------|-----------------|----------|--------------|
| 1 | 44.43 | 2.89 | 15.04 | 3.64 | 21.57 | 40.00 | -18.43 | QP | VERTICAL |
| 2 | 66.73 | 4.14 | 9.23 | 3.80 | 17.17 | 40.00 | -22.83 | QP | VERTICAL |
| 3 | 170.79 | 3.71 | 8.80 | 4.34 | 16.85 | 43.50 | -26.65 | QP | VERTICAL |
| 4 | 337.22 | 2.34 | 14.33 | 4.95 | 21.62 | 46.00 | -24.38 | QP | VERTICAL |
| 5 | 694.42 | 3.77 | 19.40 | 5.98 | 29.15 | 46.00 | -16.85 | QP | VERTICAL |
| 6 | 916.07 | 3.76 | 22.40 | 6.51 | 32.67 | 46.00 | -13.33 | QP | VERTICAL |

- Note: 1. Result Level = Read Level + Antenna Factor + Cable loss.
 2. If Peak Result complies with QP limit, QP Result is deemed to comply with QP limit.
 3. Test setup: RBW: 120 kHz, VBW: 300 kHz, Sweep time: auto.

Radiated Emission test (above 1 GHz)

TR-4-E-009 Radiated Emission Test Result

Test Site : DDT 3m Chamber 3#
Test Date : 2022-06-30
EUT : Bluetooth Speaker
Power Supply : Battery
Condition : Temp:22°C,Humi:59.4%,Press:100.3kPa
Memo : 2DH5 2402

Tested By : Bairong
Model Number : aGROOVE MINI
Test Mode : Tx Mode
Antenna/Distance : 2021 BBHA 9120D
 3#/3m/HORIZONTAL

D:\E3 6.111\2022 Report Data\Q22061414-4E
 aGROOVE-MINI\FCC ABOVE 1G.EM6

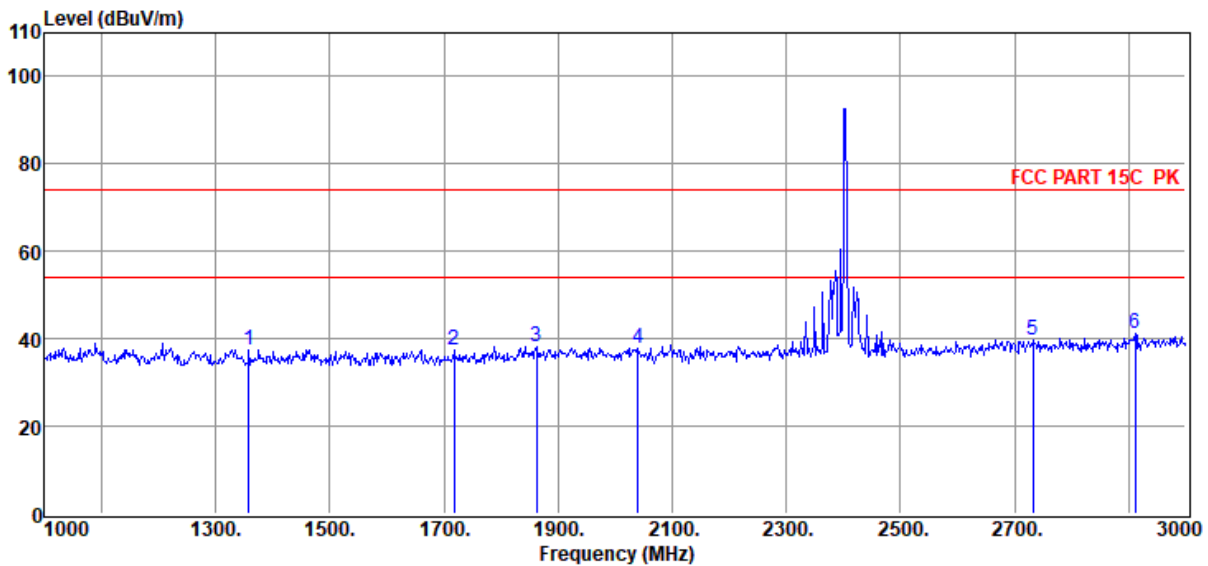

| Item (Mark) | Freq. (MHz) | Read Level (dB μ V) | Antenna Factor (dB/m) | PRM Factor dB | Cable Loss dB | Filter Factor dB | Result Level (dB μ V/m) | Limit Line (dB μ V/m) | Over Limit (dB) | Detector | Polarization |
|-------------|-------------|-------------------------|-----------------------|---------------|---------------|------------------|-----------------------------|---------------------------|-----------------|----------|--------------|
| 1 | 1358.00 | 48.52 | 25.43 | 38.44 | 1.30 | 0.56 | 37.37 | 74.00 | -36.63 | Peak | HORIZONTAL |
| 2 | 1718.00 | 48.37 | 25.97 | 38.98 | 1.48 | 0.63 | 37.47 | 74.00 | -36.53 | Peak | HORIZONTAL |
| 3 | 1862.00 | 48.93 | 26.34 | 39.19 | 1.54 | 0.66 | 38.28 | 74.00 | -35.72 | Peak | HORIZONTAL |
| 4 | 2040.00 | 48.29 | 26.77 | 39.42 | 1.61 | 0.68 | 37.93 | 74.00 | -36.07 | Peak | HORIZONTAL |
| 5 | 2732.00 | 48.42 | 28.48 | 39.77 | 1.80 | 0.76 | 39.69 | 74.00 | -34.31 | Peak | HORIZONTAL |
| 6 | 2912.00 | 49.19 | 29.17 | 39.86 | 1.85 | 0.78 | 41.13 | 74.00 | -32.87 | Peak | HORIZONTAL |

Note: 1. Result Level = Read Level + Antenna Factor + Cable loss + Filter Factor - PRM Factor.
 2. If Peak Result complies with AV limit, AV Result is deemed to comply with AV limit.
 3. Test setup: RBW: 1 MHz, VBW: 3 MHz, Sweep time: auto.

TR-4-E-009 Radiated Emission Test Result

Test Site : DDT 3m Chamber 3# D:\E3 6.111\2022 Report Data\Q22061414-4E aGROOVE-MINI\FCC ABOVE 1G.EM6
Test Date : 2022-06-30 **Tested By** : Bairong
EUT : Bluetooth Speaker **Model Number** : aGROOVE MINI
Power Supply : Battery **Test Mode** : Tx Mode
Condition : Temp:22°C,Humi:59.4%,Press:100.3kPa **Antenna/Distance** : 2021 BBHA 9120D 3#/3m/VERTICAL
Memo : 2DH5 2402

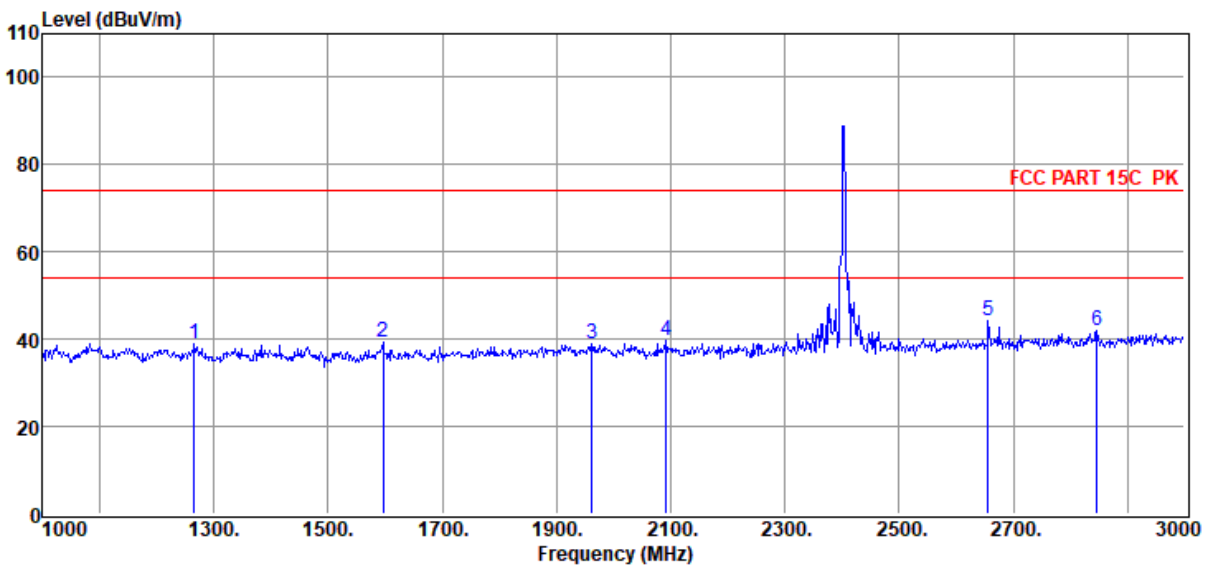

| Item (Mark) | Freq. (MHz) | Read Level (dBµV) | Antenna Factor (dB/m) | PRM Factor (dB) | Cable Loss (dB) | Filter Factor (dB) | Result Level (dBµV/m) | Limit Line (dBµV/m) | Over Limit (dB) | Detector | Polarization |
|-------------|-------------|-------------------|-----------------------|-----------------|-----------------|--------------------|-----------------------|---------------------|-----------------|----------|--------------|
| 1 | 1266.00 | 49.91 | 25.45 | 38.30 | 1.25 | 0.55 | 38.86 | 74.00 | -35.14 | Peak | VERTICAL |
| 2 | 1596.00 | 50.34 | 25.65 | 38.79 | 1.42 | 0.61 | 39.23 | 74.00 | -34.77 | Peak | VERTICAL |
| 3 | 1962.00 | 49.32 | 26.60 | 39.34 | 1.58 | 0.67 | 38.83 | 74.00 | -35.17 | Peak | VERTICAL |
| 4 | 2092.00 | 49.92 | 26.87 | 39.45 | 1.63 | 0.69 | 39.66 | 74.00 | -34.34 | Peak | VERTICAL |
| 5 | 2656.00 | 53.14 | 28.19 | 39.73 | 1.78 | 0.75 | 44.13 | 74.00 | -29.87 | Peak | VERTICAL |
| 6 | 2846.00 | 50.18 | 28.91 | 39.82 | 1.83 | 0.77 | 41.87 | 74.00 | -32.13 | Peak | VERTICAL |

Note: 1. Result Level = Read Level + Antenna Factor + Cable loss + Filter Factor - PRM Factor.
 2. If Peak Result complies with AV limit, AV Result is deemed to comply with AV limit.
 3. Test setup: RBW: 1 MHz, VBW: 3 MHz, Sweep time: auto.

TR-4-E-009 Radiated Emission Test Result

Test Site : DDT 3m Chamber 3# D:\E3 6.111\2022 Report Data\Q22061414-4E aGROOVE-MINI\FCC ABOVE 1G.EM6
Test Date : 2022-06-30 **Tested By** : Bairong
EUT : Bluetooth Speaker **Model Number** : aGROOVE MINI
Power Supply : Battery **Test Mode** : Tx Mode
Condition : Temp:22°C,Humi:59.4%,Press:100.3kPa **Antenna/Distance** : 2021 BBHA 9120D
3#/3m/HORIZONTAL
Memo : 2DH5 2402

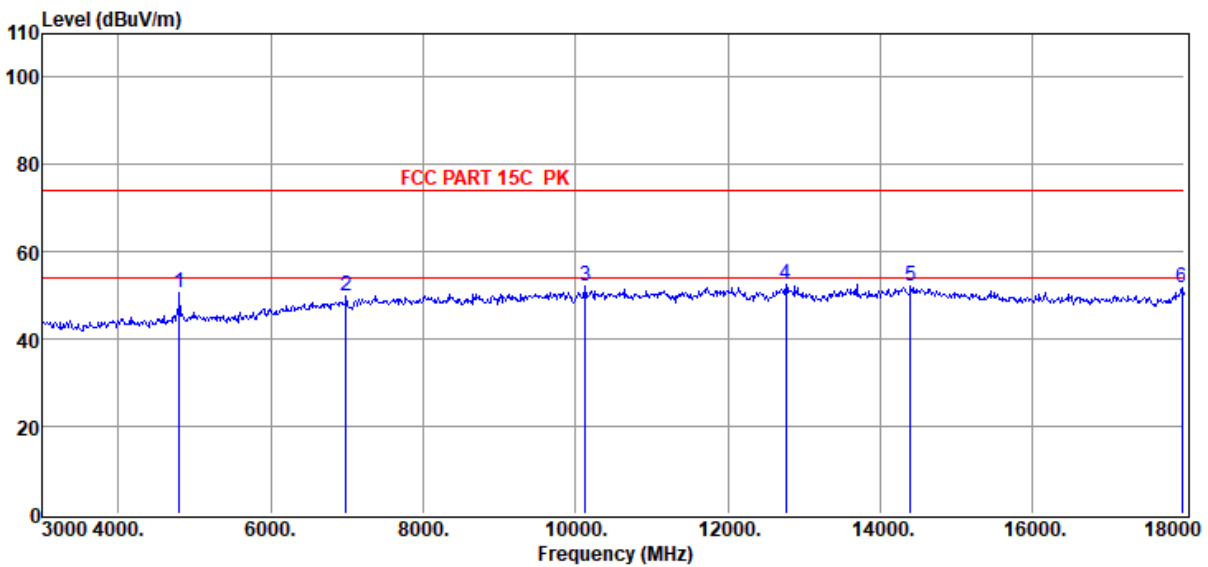

| Item (Mark) | Freq. (MHz) | Read Level (dBμV) | Antenna Factor (dB/m) | PRM Factor (dB) | Cable Loss (dB) | Filter Factor (dB) | Result Level (dBμV/m) | Limit Line (dBμV/m) | Over Limit (dB) | Detector | Polarization |
|-------------|-------------|-------------------|-----------------------|-----------------|-----------------|--------------------|-----------------------|---------------------|-----------------|----------|--------------|
| 1 | 4800.00 | 53.94 | 32.46 | 40.36 | 2.47 | 2.16 | 50.67 | 74.00 | -23.33 | Peak | HORIZONTAL |
| 2 | 6990.00 | 48.31 | 35.98 | 39.71 | 3.03 | 2.27 | 49.88 | 74.00 | -24.12 | Peak | HORIZONTAL |
| 3 | 10125.00 | 48.03 | 38.55 | 40.55 | 3.67 | 2.47 | 52.17 | 74.00 | -21.83 | Peak | HORIZONTAL |
| 4 | 12765.00 | 46.49 | 39.32 | 40.33 | 4.08 | 2.83 | 52.39 | 74.00 | -21.61 | Peak | HORIZONTAL |
| 5 | 14400.00 | 44.87 | 39.90 | 39.66 | 4.39 | 2.79 | 52.29 | 74.00 | -21.71 | Peak | HORIZONTAL |
| 6 | 17970.00 | 41.55 | 42.31 | 40.68 | 4.95 | 3.78 | 51.91 | 74.00 | -22.09 | Peak | HORIZONTAL |

Note: 1. Result Level = Read Level + Antenna Factor + Cable loss + Filter Factor - PRM Factor.
 2. If Peak Result complies with AV limit, AV Result is deemed to comply with AV limit.
 3. Test setup: RBW: 1 MHz, VBW: 3 MHz, Sweep time: auto.

TR-4-E-009 Radiated Emission Test Result

Test Site : DDT 3m Chamber 3# D:\E3 6.111\2022 Report Data\Q22061414-4E aGROOVE-MINI\FCC ABOVE 1G.EM6
Test Date : 2022-06-30 **Tested By** : Bairong
EUT : Bluetooth Speaker **Model Number** : aGROOVE MINI
Power Supply : Battery **Test Mode** : Tx Mode
Condition : Temp:22°C,Humi:59.4%,Press:100.3kPa **Antenna/Distance** : 2021 BBHA 9120D 3#/3m/VERTICAL
Memo : 2DH5 2402

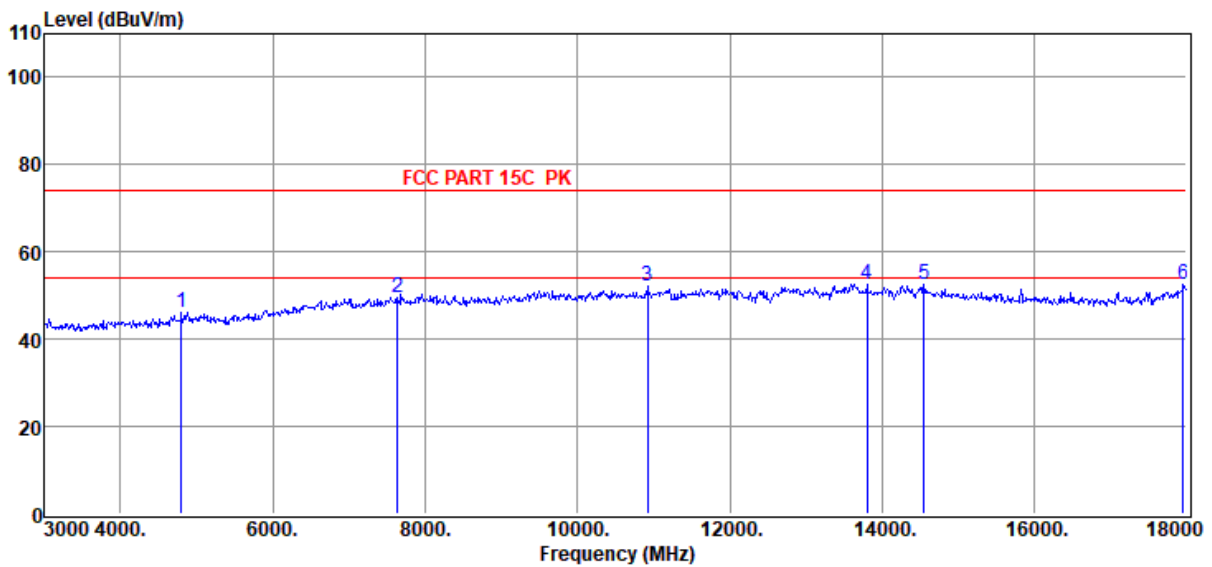

| Item (Mark) | Freq. (MHz) | Read Level (dBµV) | Antenna Factor (dB/m) | PRM Factor (dB) | Cable Loss (dB) | Filter Factor (dB) | Result Level (dBµV/m) | Limit Line (dBµV/m) | Over Limit (dB) | Detector | Polarization |
|-------------|-------------|-------------------|-----------------------|-----------------|-----------------|--------------------|-----------------------|---------------------|-----------------|----------|--------------|
| 1 | 4800.00 | 49.56 | 32.46 | 40.36 | 2.47 | 2.16 | 46.29 | 74.00 | -27.71 | Peak | VERTICAL |
| 2 | 7635.00 | 47.42 | 36.56 | 39.76 | 3.15 | 2.27 | 49.64 | 74.00 | -24.36 | Peak | VERTICAL |
| 3 | 10920.00 | 46.85 | 39.25 | 40.23 | 3.78 | 2.39 | 52.04 | 74.00 | -21.96 | Peak | VERTICAL |
| 4 | 13800.00 | 45.22 | 39.94 | 39.84 | 4.31 | 2.91 | 52.54 | 74.00 | -21.46 | Peak | VERTICAL |
| 5 | 14550.00 | 45.33 | 39.86 | 39.65 | 4.36 | 2.75 | 52.65 | 74.00 | -21.35 | Peak | VERTICAL |
| 6 | 17955.00 | 42.31 | 42.22 | 40.67 | 4.95 | 3.78 | 52.59 | 74.00 | -21.41 | Peak | VERTICAL |

Note: 1. Result Level = Read Level + Antenna Factor + Cable loss + Filter Factor - PRM Factor.
 2. If Peak Result complies with AV limit, AV Result is deemed to comply with AV limit.
 3. Test setup: RBW: 1 MHz, VBW: 3 MHz, Sweep time: auto.

TR-4-E-009 Radiated Emission Test Result

Test Site : DDT 3m Chamber 3# D:\E3 6.111\2022 Report Data\Q22061414-4E aGROOVE-MINI\FCC ABOVE 1G.EM6
Test Date : 2022-06-30 **Tested By** : Bairong
EUT : Bluetooth Speaker **Model Number** : aGROOVE MINI
Power Supply : Battery **Test Mode** : Tx Mode
Condition : Temp:22°C,Humi:59.4%,Press:100.3kPa **Antenna/Distance** : 2021 BBHA 9120D
3#/3m/HORIZONTAL
Memo : 2DH5 2441

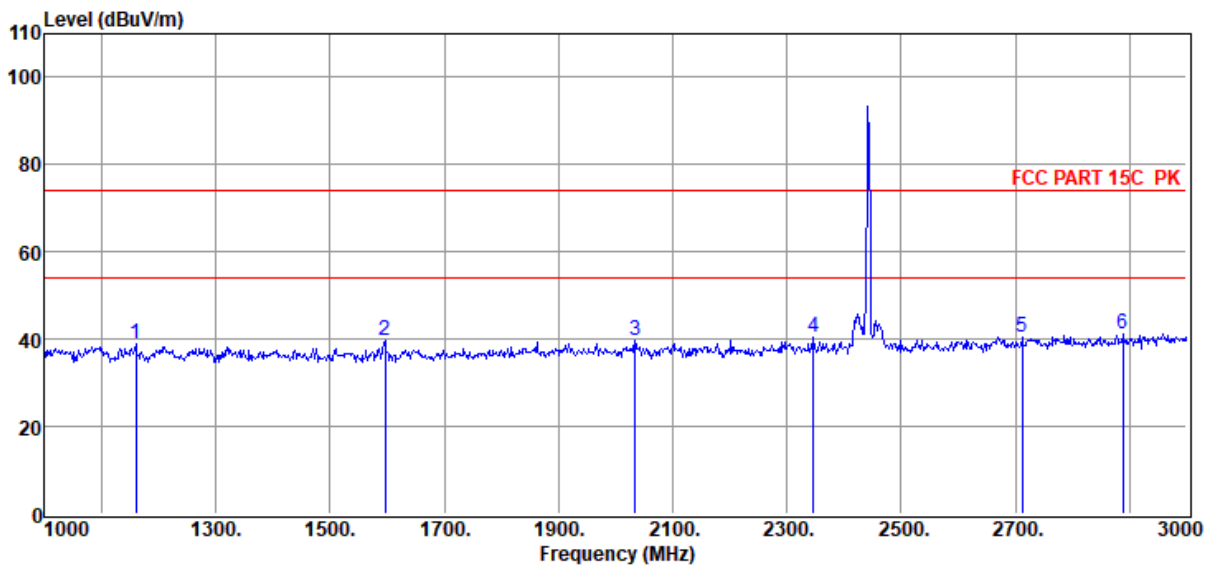

| Item (Mark) | Freq. (MHz) | Read Level (dBuV) | Antenna Factor (dB/m) | PRM Factor (dB) | Cable Loss (dB) | Filter Factor (dB) | Result Level (dBuV/m) | Limit Line (dBuV/m) | Over Limit (dB) | Detector | Polarization |
|-------------|-------------|-------------------|-----------------------|-----------------|-----------------|--------------------|-----------------------|---------------------|-----------------|----------|--------------|
| 1 | 1160.00 | 49.83 | 25.47 | 38.14 | 1.19 | 0.53 | 38.88 | 74.00 | -35.12 | Peak | HORIZONTAL |
| 2 | 1596.00 | 50.73 | 25.65 | 38.79 | 1.42 | 0.61 | 39.62 | 74.00 | -34.38 | Peak | HORIZONTAL |
| 3 | 2034.00 | 50.09 | 26.76 | 39.42 | 1.61 | 0.68 | 39.72 | 74.00 | -34.28 | Peak | HORIZONTAL |
| 4 | 2346.00 | 50.29 | 27.32 | 39.57 | 1.70 | 0.72 | 40.46 | 74.00 | -33.54 | Peak | HORIZONTAL |
| 5 | 2712.00 | 49.37 | 28.41 | 39.76 | 1.80 | 0.76 | 40.58 | 74.00 | -33.42 | Peak | HORIZONTAL |
| 6 | 2888.00 | 49.43 | 29.07 | 39.84 | 1.84 | 0.78 | 41.28 | 74.00 | -32.72 | Peak | HORIZONTAL |

Note: 1. Result Level = Read Level + Antenna Factor + Cable loss + Filter Factor - PRM Factor.
 2. If Peak Result complies with AV limit, AV Result is deemed to comply with AV limit.
 3. Test setup: RBW: 1 MHz, VBW: 3 MHz, Sweep time: auto.

TR-4-E-009 Radiated Emission Test Result

Test Site : DDT 3m Chamber 3# D:\E3 6.111\2022 Report Data\Q22061414-4E aGROOVE-MINI\FCC ABOVE 1G.EM6
Test Date : 2022-06-30 **Tested By** : Bairong
EUT : Bluetooth Speaker **Model Number** : aGROOVE MINI
Power Supply : Battery **Test Mode** : Tx Mode
Condition : Temp:22°C,Humi:59.4%,Press:100.3kPa **Antenna/Distance** : 2021 BBHA 9120D 3#/3m/VERTICAL
Memo : 2DH5 2441

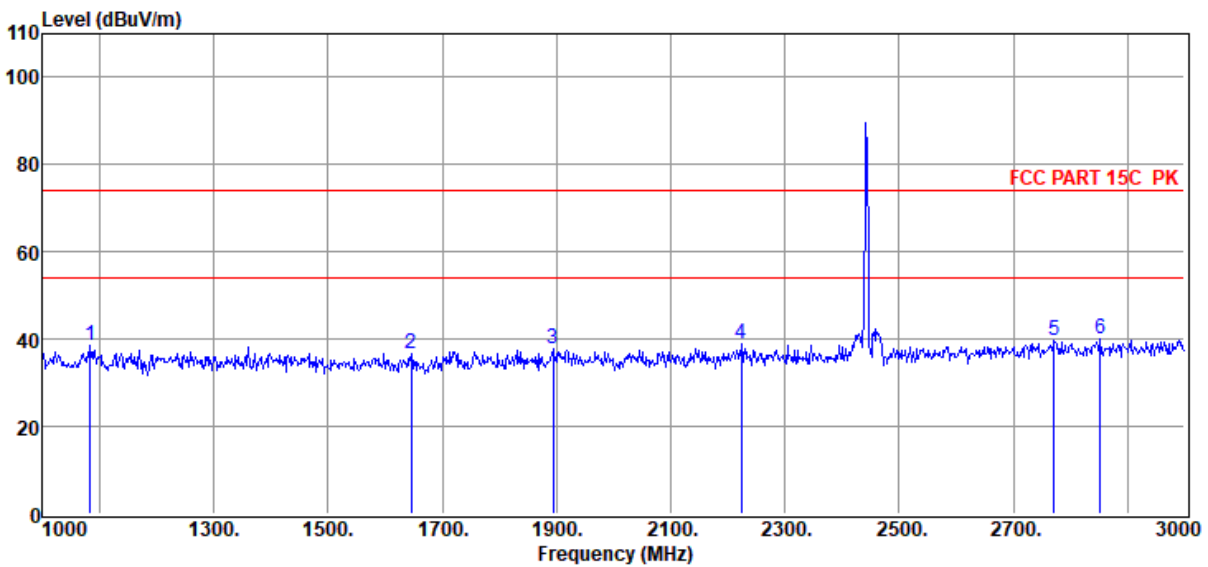

| Item (Mark) | Freq. (MHz) | Read Level (dBuV) | Antenna Factor (dB/m) | PRM Factor (dB) | Cable Loss (dB) | Filter Factor (dB) | Result Level (dBuV/m) | Limit Line (dBuV/m) | Over Limit (dB) | Detector | Polarization |
|-------------|-------------|-------------------|-----------------------|-----------------|-----------------|--------------------|-----------------------|---------------------|-----------------|----------|--------------|
| 1 | 1084.00 | 49.46 | 25.48 | 38.03 | 1.15 | 0.52 | 38.58 | 74.00 | -35.42 | Peak | VERTICAL |
| 2 | 1646.00 | 47.80 | 25.78 | 38.87 | 1.44 | 0.62 | 36.77 | 74.00 | -37.23 | Peak | VERTICAL |
| 3 | 1894.00 | 48.25 | 26.42 | 39.24 | 1.55 | 0.66 | 37.64 | 74.00 | -36.36 | Peak | VERTICAL |
| 4 | 2224.00 | 48.99 | 27.10 | 39.51 | 1.66 | 0.70 | 38.94 | 74.00 | -35.06 | Peak | VERTICAL |
| 5 | 2772.00 | 48.10 | 28.63 | 39.79 | 1.81 | 0.76 | 39.51 | 74.00 | -34.49 | Peak | VERTICAL |
| 6 | 2852.00 | 48.34 | 28.94 | 39.83 | 1.83 | 0.77 | 40.05 | 74.00 | -33.95 | Peak | VERTICAL |

Note: 1. Result Level = Read Level + Antenna Factor + Cable loss + Filter Factor - PRM Factor.
 2. If Peak Result complies with AV limit, AV Result is deemed to comply with AV limit.
 3. Test setup: RBW: 1 MHz, VBW: 3 MHz, Sweep time: auto.

TR-4-E-009 Radiated Emission Test Result

Test Site : DDT 3m Chamber 3# D:\E3 6.111\2022 Report Data\Q22061414-4E aGROOVE-MINI\FCC ABOVE 1G.EM6
Test Date : 2022-06-30 **Tested By** : Bairong
EUT : Bluetooth Speaker **Model Number** : aGROOVE MINI
Power Supply : Battery **Test Mode** : Tx Mode
Condition : Temp:22°C,Humi:59.4%,Press:100.3kPa **Antenna/Distance** : 2021 BBHA 9120D
3#/3m/HORIZONTAL
Memo : 2DH5 2441

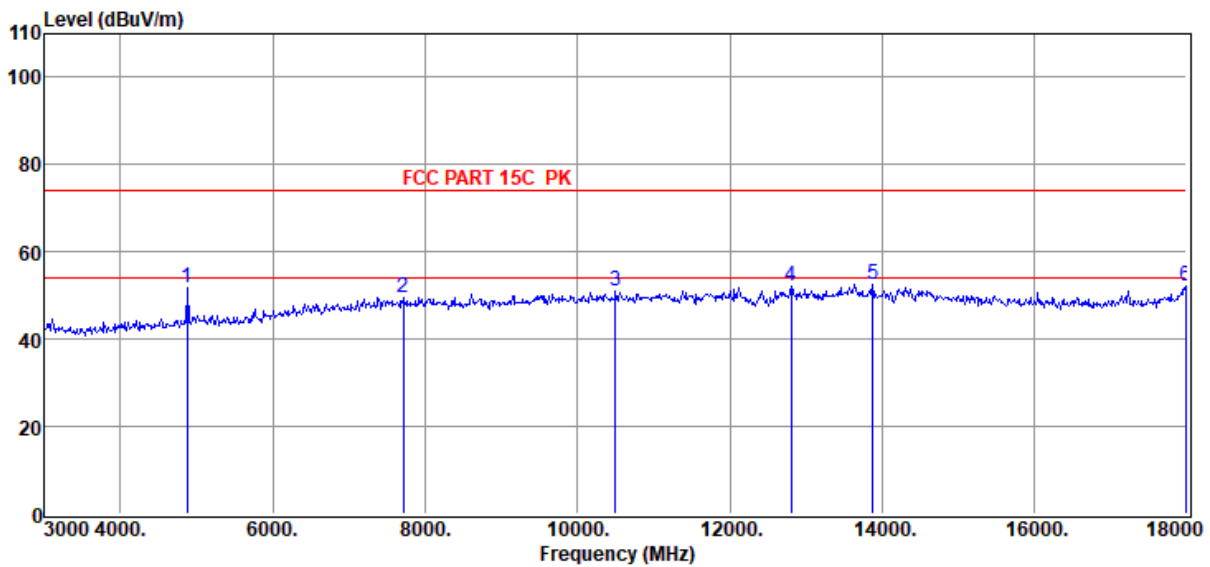

| Item (Mark) | Freq. (MHz) | Read Level (dBμV) | Antenna Factor (dB/m) | PRM Factor (dB) | Cable Loss (dB) | Filter Factor (dB) | Result Level (dBμV/m) | Limit Line (dBμV/m) | Over Limit (dB) | Detector | Polarization |
|-------------|-------------|-------------------|-----------------------|-----------------|-----------------|--------------------|-----------------------|---------------------|-----------------|----------|--------------|
| 1 | 4875.00 | 54.94 | 32.70 | 40.38 | 2.49 | 2.17 | 51.92 | 74.00 | -22.08 | Peak | HORIZONTAL |
| 2 | 7710.00 | 47.26 | 36.65 | 39.77 | 3.16 | 2.27 | 49.57 | 74.00 | -24.43 | Peak | HORIZONTAL |
| 3 | 10500.00 | 46.40 | 39.00 | 40.40 | 3.67 | 2.43 | 51.10 | 74.00 | -22.90 | Peak | HORIZONTAL |
| 4 | 12810.00 | 46.08 | 39.37 | 40.34 | 4.14 | 2.85 | 52.10 | 74.00 | -21.90 | Peak | HORIZONTAL |
| 5 | 13875.00 | 45.23 | 39.93 | 39.79 | 4.39 | 2.91 | 52.67 | 74.00 | -21.33 | Peak | HORIZONTAL |
| 6 | 17985.00 | 41.68 | 42.41 | 40.69 | 4.96 | 3.79 | 52.15 | 74.00 | -21.85 | Peak | HORIZONTAL |

Note: 1. Result Level = Read Level + Antenna Factor + Cable loss + Filter Factor - PRM Factor.
 2. If Peak Result complies with AV limit, AV Result is deemed to comply with AV limit.
 3. Test setup: RBW: 1 MHz, VBW: 3 MHz, Sweep time: auto.

TR-4-E-009 Radiated Emission Test Result

Test Site : DDT 3m Chamber 3#
Test Date : 2022-06-30
EUT : Bluetooth Speaker
Power Supply : Battery
Condition : Temp:22°C,Humi:59.4%,Press:100.3kPa
Memo : 2DH5 2441

Tested By : Bairong
Model Number : aGROOVE MINI
Test Mode : Tx Mode
Antenna/Distance : 2021 BBHA 9120D 3#/3m/VERTICAL

D:\E3 6.111\2022 Report Data\Q22061414-4E
 aGROOVE-MINI\FCC ABOVE 1G.EM6

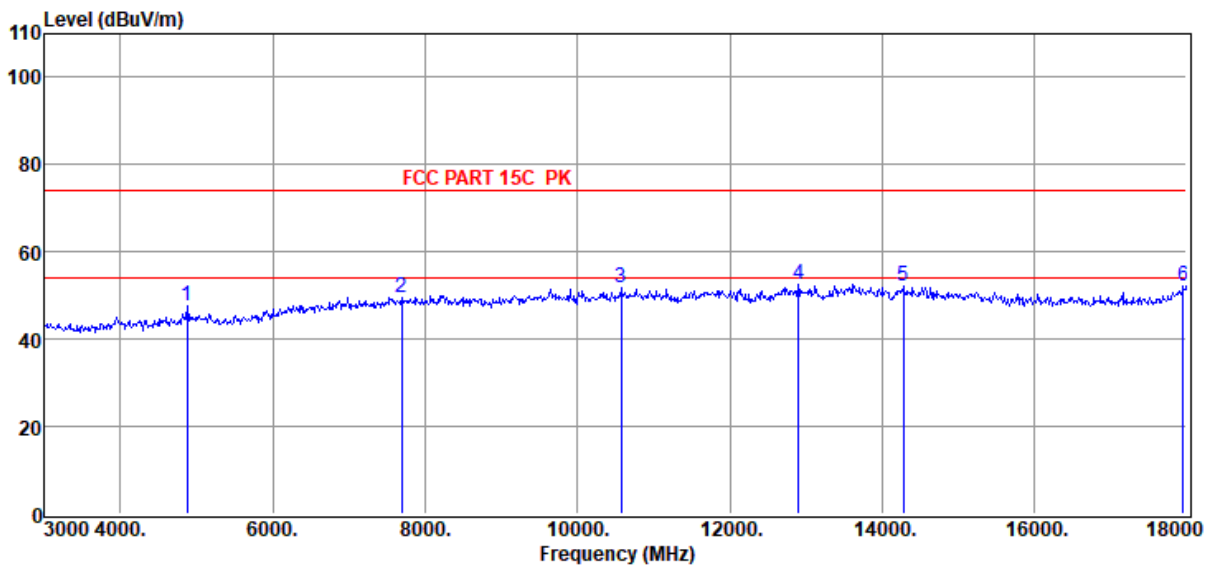

| Item (Mark) | Freq. (MHz) | Read Level (dB μ V) | Antenna Factor (dB/m) | PRM Factor (dB) | Cable Loss (dB) | Filter Factor (dB) | Result Level (dB μ V/m) | Limit Line (dB μ V/m) | Over Limit (dB) | Detector | Polarization |
|-------------|-------------|-------------------------|-----------------------|-----------------|-----------------|--------------------|-----------------------------|---------------------------|-----------------|----------|--------------|
| 1 | 4875.00 | 50.59 | 32.70 | 40.38 | 2.49 | 2.17 | 47.57 | 74.00 | -26.43 | Peak | VERTICAL |
| 2 | 7695.00 | 47.13 | 36.63 | 39.77 | 3.16 | 2.27 | 49.42 | 74.00 | -24.58 | Peak | VERTICAL |
| 3 | 10575.00 | 46.98 | 39.04 | 40.37 | 3.69 | 2.42 | 51.76 | 74.00 | -22.24 | Peak | VERTICAL |
| 4 | 12900.00 | 46.13 | 39.48 | 40.37 | 4.26 | 2.90 | 52.40 | 74.00 | -21.60 | Peak | VERTICAL |
| 5 | 14280.00 | 44.78 | 39.90 | 39.67 | 4.43 | 2.82 | 52.26 | 74.00 | -21.74 | Peak | VERTICAL |
| 6 | 17955.00 | 42.06 | 42.22 | 40.67 | 4.95 | 3.78 | 52.34 | 74.00 | -21.66 | Peak | VERTICAL |

Note: 1. Result Level = Read Level + Antenna Factor + Cable loss + Filter Factor - PRM Factor.
 2. If Peak Result complies with AV limit, AV Result is deemed to comply with AV limit.
 3. Test setup: RBW: 1 MHz, VBW: 3 MHz, Sweep time: auto.

TR-4-E-009 Radiated Emission Test Result

Test Site : DDT 3m Chamber 3# D:\E3 6.111\2022 Report Data\Q22061414-4E aGROOVE-MINI\FCC ABOVE 1G.EM6
Test Date : 2022-06-30 **Tested By** : Bairong
EUT : Bluetooth Speaker **Model Number** : aGROOVE MINI
Power Supply : Battery **Test Mode** : Tx Mode
Condition : Temp:22°C,Humi:59.4%,Press:100.3kPa **Antenna/Distance** : 2021 BBHA 9120D
3#/3m/HORIZONTAL
Memo : 2DH5 2480

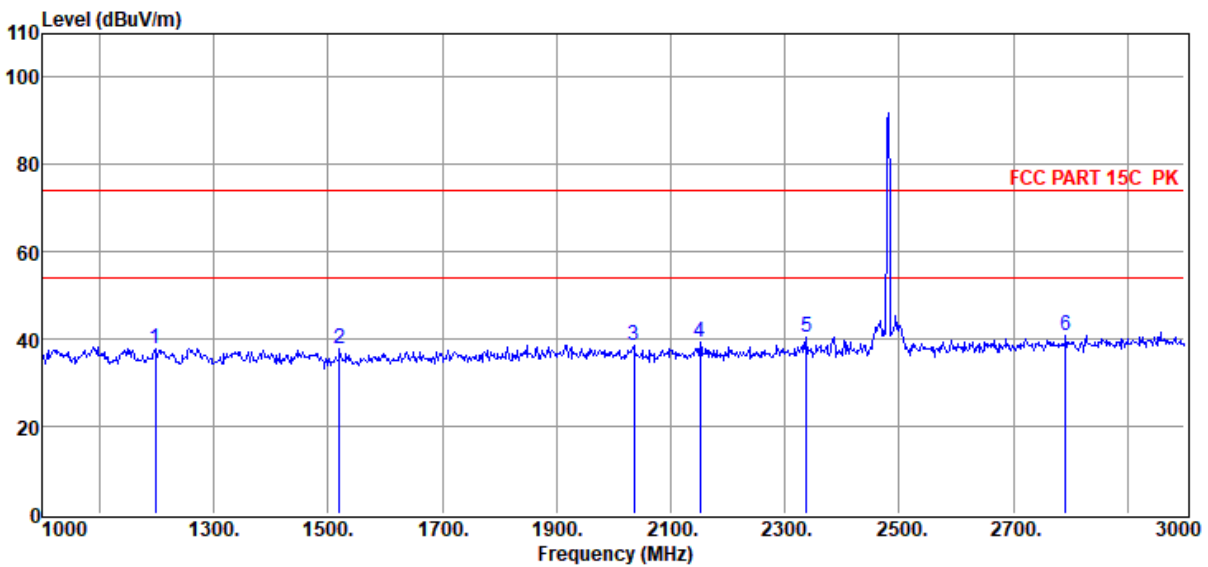

| Item (Mark) | Freq. (MHz) | Read Level (dBμV) | Antenna Factor (dB/m) | PRM Factor dB | Cable Loss dB | Filter Factor dB | Result Level (dBμV/m) | Limit Line (dBμV/m) | Over Limit (dB) | Detector | Polarization |
|-------------|-------------|-------------------|-----------------------|---------------|---------------|------------------|-----------------------|---------------------|-----------------|----------|--------------|
| 1 | 1198.00 | 48.79 | 25.46 | 38.20 | 1.21 | 0.54 | 37.80 | 74.00 | -36.20 | Peak | HORIZONTAL |
| 2 | 1520.00 | 48.99 | 25.45 | 38.68 | 1.39 | 0.59 | 37.74 | 74.00 | -36.26 | Peak | HORIZONTAL |
| 3 | 2036.00 | 49.03 | 26.76 | 39.42 | 1.61 | 0.68 | 38.66 | 74.00 | -35.34 | Peak | HORIZONTAL |
| 4 | 2152.00 | 49.48 | 26.97 | 39.48 | 1.64 | 0.70 | 39.31 | 74.00 | -34.69 | Peak | HORIZONTAL |
| 5 | 2338.00 | 50.48 | 27.31 | 39.57 | 1.69 | 0.72 | 40.63 | 74.00 | -33.37 | Peak | HORIZONTAL |
| 6 | 2792.00 | 49.14 | 28.71 | 39.80 | 1.82 | 0.77 | 40.64 | 74.00 | -33.36 | Peak | HORIZONTAL |

Note: 1. Result Level = Read Level + Antenna Factor + Cable loss + Filter Factor - PRM Factor.
 2. If Peak Result complies with AV limit, AV Result is deemed to comply with AV limit.
 3. Test setup: RBW: 1 MHz, VBW: 3 MHz, Sweep time: auto.

TR-4-E-009 Radiated Emission Test Result

Test Site : DDT 3m Chamber 3# D:\E3 6.111\2022 Report Data\Q22061414-4E aGROOVE-MINI\FCC ABOVE 1G.EM6
Test Date : 2022-06-30 **Tested By** : Bairong
EUT : Bluetooth Speaker **Model Number** : aGROOVE MINI
Power Supply : Battery **Test Mode** : Tx Mode
Condition : Temp:22°C,Humi:59.4%,Press:100.3kPa **Antenna/Distance** : 2021 BBHA 9120D 3#/3m/VERTICAL
Memo : 2DH5 2480

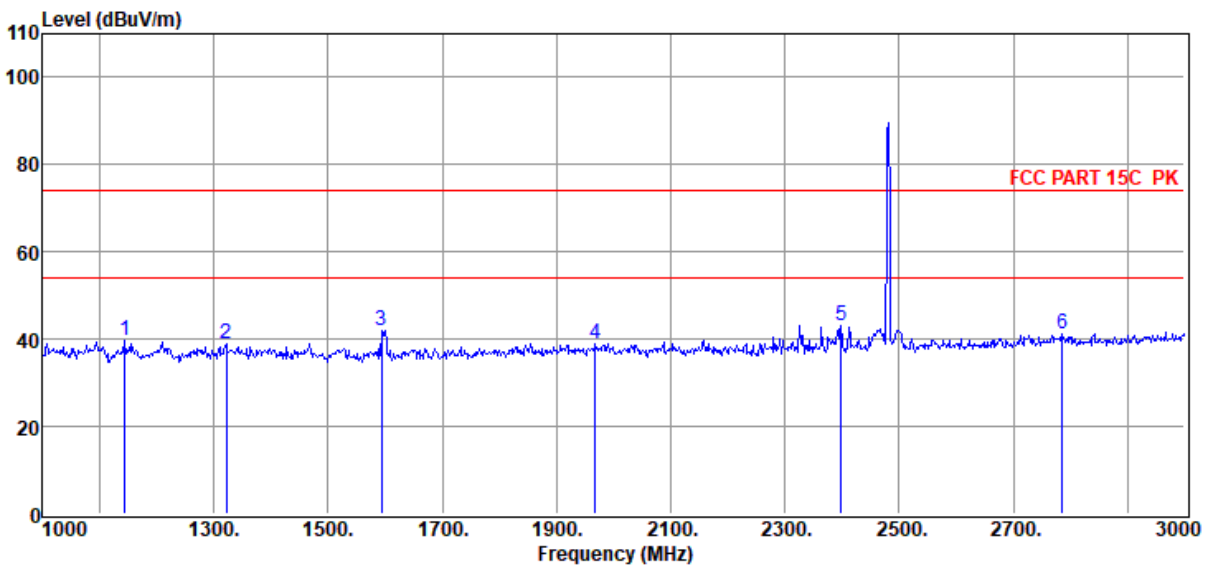

| Item (Mark) | Freq. (MHz) | Read Level (dBμV) | Antenna Factor (dB/m) | PRM Factor (dB) | Cable Loss (dB) | Filter Factor (dB) | Result Level (dBμV/m) | Limit Line (dBμV/m) | Over Limit (dB) | Detector | Polarization |
|-------------|-------------|-------------------|-----------------------|-----------------|-----------------|--------------------|-----------------------|---------------------|-----------------|----------|--------------|
| 1 | 1144.00 | 50.70 | 25.47 | 38.12 | 1.18 | 0.53 | 39.76 | 74.00 | -34.24 | Peak | VERTICAL |
| 2 | 1322.00 | 49.94 | 25.44 | 38.38 | 1.28 | 0.56 | 38.84 | 74.00 | -35.16 | Peak | VERTICAL |
| 3 | 1594.00 | 53.26 | 25.64 | 38.79 | 1.42 | 0.61 | 42.14 | 74.00 | -31.86 | Peak | VERTICAL |
| 4 | 1968.00 | 49.41 | 26.62 | 39.35 | 1.59 | 0.67 | 38.94 | 74.00 | -35.06 | Peak | VERTICAL |
| 5 | 2398.00 | 52.86 | 27.42 | 39.60 | 1.71 | 0.72 | 43.11 | 74.00 | -30.89 | Peak | VERTICAL |
| 6 | 2786.00 | 49.87 | 28.69 | 39.79 | 1.81 | 0.77 | 41.35 | 74.00 | -32.65 | Peak | VERTICAL |

Note: 1. Result Level = Read Level + Antenna Factor + Cable loss + Filter Factor - PRM Factor.
 2. If Peak Result complies with AV limit, AV Result is deemed to comply with AV limit.
 3. Test setup: RBW: 1 MHz, VBW: 3 MHz, Sweep time: auto.

TR-4-E-009 Radiated Emission Test Result

Test Site : DDT 3m Chamber 3#

D:\E3 6.111\2022 Report Data\Q22061414-4E
aGROOVE-MINI\FCC ABOVE 1G.EM6

Test Date : 2022-06-30

Tested By : Bairong

EUT : Bluetooth Speaker

Model Number : aGROOVE MINI

Power Supply : Battery

Test Mode : Tx Mode

Condition : Temp:22°C,Humi:59.4%,Press:100.3kPa

Antenna/Distance : 2021 BBHA 9120D
3#/3m/HORIZONTAL

Memo : 2DH5 2480

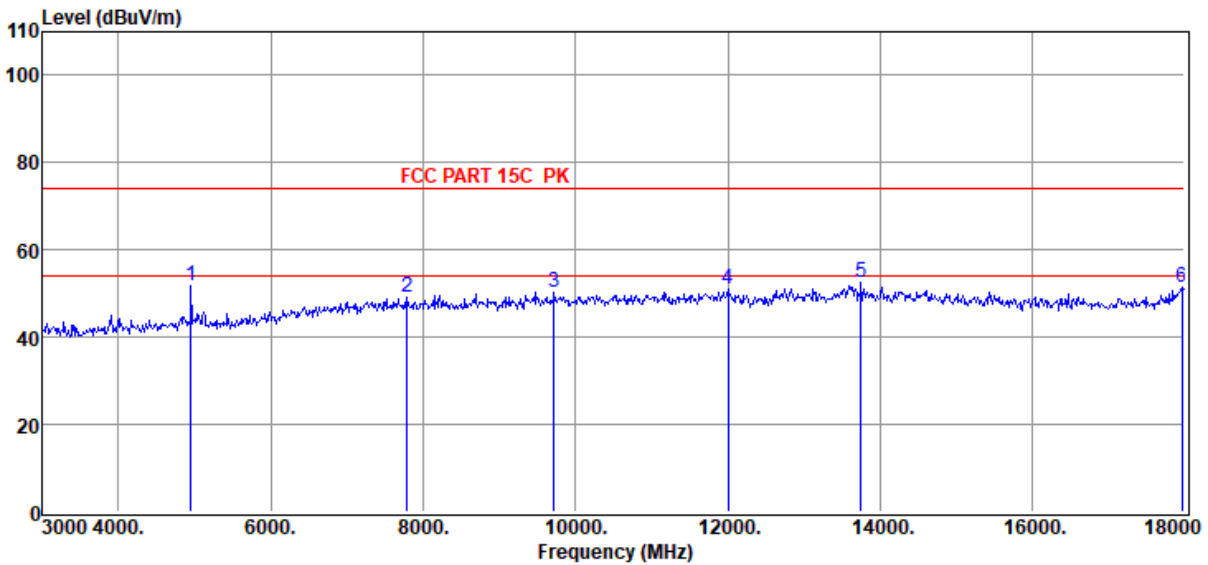

| Item (Mark) | Freq. (MHz) | Read Level (dBuV) | Antenna Factor (dB/m) | PRM Factor (dB) | Cable Loss (dB) | Filter Factor (dB) | Result Level (dBuV/m) | Limit Line (dBuV/m) | Over Limit (dB) | Detector | Polarization |
|-------------|-------------|-------------------|-----------------------|-----------------|-----------------|--------------------|-----------------------|---------------------|-----------------|----------|--------------|
| 1 | 4950.00 | 54.68 | 32.94 | 40.39 | 2.52 | 2.18 | 51.93 | 74.00 | -22.07 | Peak | HORIZONTAL |
| 2 | 7785.00 | 46.83 | 36.74 | 39.78 | 3.17 | 2.28 | 49.24 | 74.00 | -24.76 | Peak | HORIZONTAL |
| 3 | 9720.00 | 46.03 | 38.57 | 40.40 | 3.64 | 2.40 | 50.24 | 74.00 | -23.76 | Peak | HORIZONTAL |
| 4 | 12000.00 | 45.58 | 39.20 | 40.10 | 4.05 | 2.40 | 51.13 | 74.00 | -22.87 | Peak | HORIZONTAL |
| 5 | 13755.00 | 45.32 | 39.95 | 39.87 | 4.27 | 2.91 | 52.58 | 74.00 | -21.42 | Peak | HORIZONTAL |
| 6 | 17970.00 | 40.97 | 42.31 | 40.68 | 4.95 | 3.78 | 51.33 | 74.00 | -22.67 | Peak | HORIZONTAL |

Note: 1. Result Level = Read Level + Antenna Factor + Cable loss + Filter Factor - PRM Factor.
 2. If Peak Result complies with AV limit, AV Result is deemed to comply with AV limit.
 3. Test setup: RBW: 1 MHz, VBW: 3 MHz, Sweep time: auto.

TR-4-E-009 Radiated Emission Test Result

Test Site : DDT 3m Chamber 3#
Test Date : 2022-06-30
EUT : Bluetooth Speaker
Power Supply : Battery
Condition : Temp:22°C,Humi:59.4%,Press:100.3kPa
Memo : 2DH5 2480

Tested By : Bairong
Model Number : aGROOVE MINI
Test Mode : Tx Mode
Antenna/Distance : 2021 BBHA 9120D 3#/3m/VERTICAL

D:\E3 6.111\2022 Report Data\Q22061414-4E
 aGROOVE-MINI\FCC ABOVE 1G.EM6

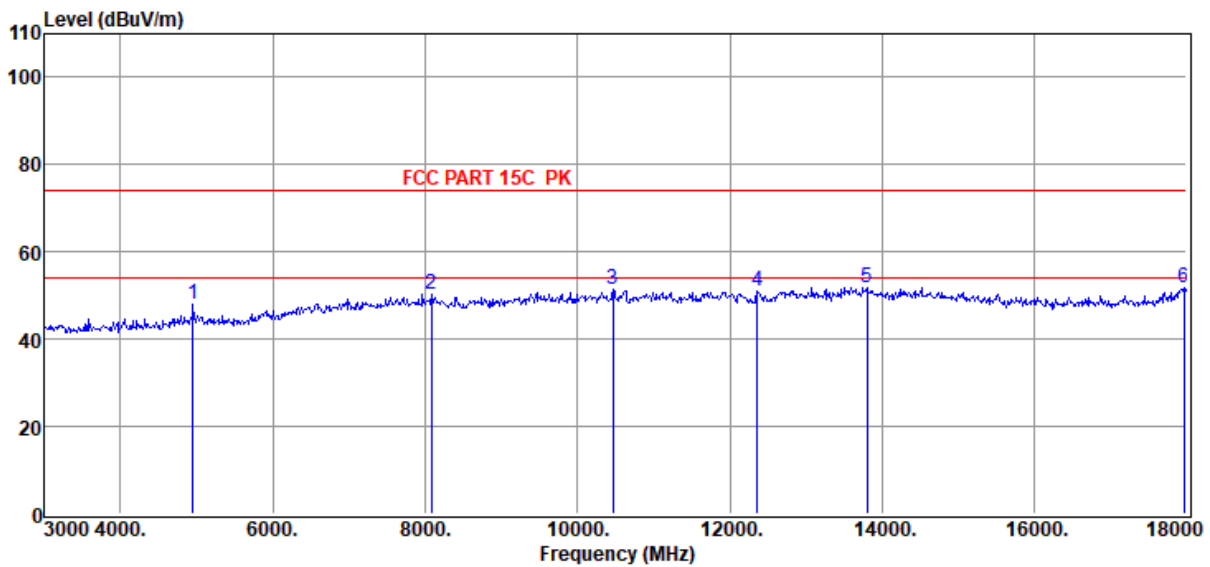

| Item (Mark) | Freq. (MHz) | Read Level (dBμV) | Antenna Factor (dB/m) | PRM Factor (dB) | Cable Loss (dB) | Filter Factor (dB) | Result Level (dBμV/m) | Limit Line (dBμV/m) | Over Limit (dB) | Detector | Polarization |
|-------------|-------------|-------------------|-----------------------|-----------------|-----------------|--------------------|-----------------------|---------------------|-----------------|----------|--------------|
| 1 | 4950.00 | 50.87 | 32.94 | 40.39 | 2.52 | 2.18 | 48.12 | 74.00 | -25.88 | Peak | VERTICAL |
| 2 | 8085.00 | 47.48 | 37.14 | 39.81 | 3.20 | 2.27 | 50.28 | 74.00 | -23.72 | Peak | VERTICAL |
| 3 | 10470.00 | 46.94 | 38.96 | 40.41 | 3.67 | 2.43 | 51.59 | 74.00 | -22.41 | Peak | VERTICAL |
| 4 | 12360.00 | 45.66 | 39.06 | 40.21 | 3.81 | 2.60 | 50.92 | 74.00 | -23.08 | Peak | VERTICAL |
| 5 | 13800.00 | 44.65 | 39.94 | 39.84 | 4.31 | 2.91 | 51.97 | 74.00 | -22.03 | Peak | VERTICAL |
| 6 | 17970.00 | 41.60 | 42.31 | 40.68 | 4.95 | 3.78 | 51.96 | 74.00 | -22.04 | Peak | VERTICAL |

Note: 1. Result Level = Read Level + Antenna Factor + Cable loss + Filter Factor - PRM Factor.
 2. If Peak Result complies with AV limit, AV Result is deemed to comply with AV limit.
 3. Test setup: RBW: 1 MHz, VBW: 3 MHz, Sweep time: auto.

11. RF Conducted Spurious Emissions

11.1. Block diagram of test setup

Same as section 4.1

11.2. Limits

In any 100 kHz bandwidth outside the frequency bands in which the spread spectrum intentional radiator is operating, the radio frequency power that is produced by the intentional radiator shall be at least 20 dB below that in the 100 kHz bandwidth within the band that contains the highest level of the desired power.

11.3. Test procedure

(1) Connect EUT's antenna output to spectrum analyzer by RF cable.

(2) Establish a reference level by using the following procedure:

| | |
|------------------|---------------------------------------------------------------|
| Center frequency | Test frequency |
| RBW: | 100 kHz |
| VBW: | 300 kHz |
| Span | Wide enough to capture the peak level of the in-band emission |
| Detector Mode: | Peak |
| Sweep time: | auto |
| Trace mode | Max hold |

(3) Allow the trace to stabilize, use the peak marker function to determine the maximum peak power level to establish the reference level.

(4) Set the spectrum analyzer as follows:

| | |
|------------------------------|------------------------------------------|
| RBW: | 100 kHz |
| VBW: | 300 kHz |
| Span | Encompass frequency range to be measured |
| Number of measurement points | $\geq \text{span}/\text{RBW}$ |
| Detector Mode: | Peak |
| Sweep time: | auto |
| Trace mode | Max hold |

(5) Allow the trace to stabilize, use the peak marker function to determine the maximum amplitude of all unwanted emissions outside of the authorized frequency band

11.4. Test result

| Mode | Freq. (MHz) | Verdict |
|----------------|------------------|---------|
| GFSK | Hopping off 2402 | Pass |
| | Hopping off 2441 | Pass |
| | Hopping off 2480 | Pass |
| $\pi/4$ -DQPSK | Hopping off 2402 | Pass |
| | Hopping off 2441 | Pass |
| | Hopping off 2480 | Pass |

11.5. Original test data

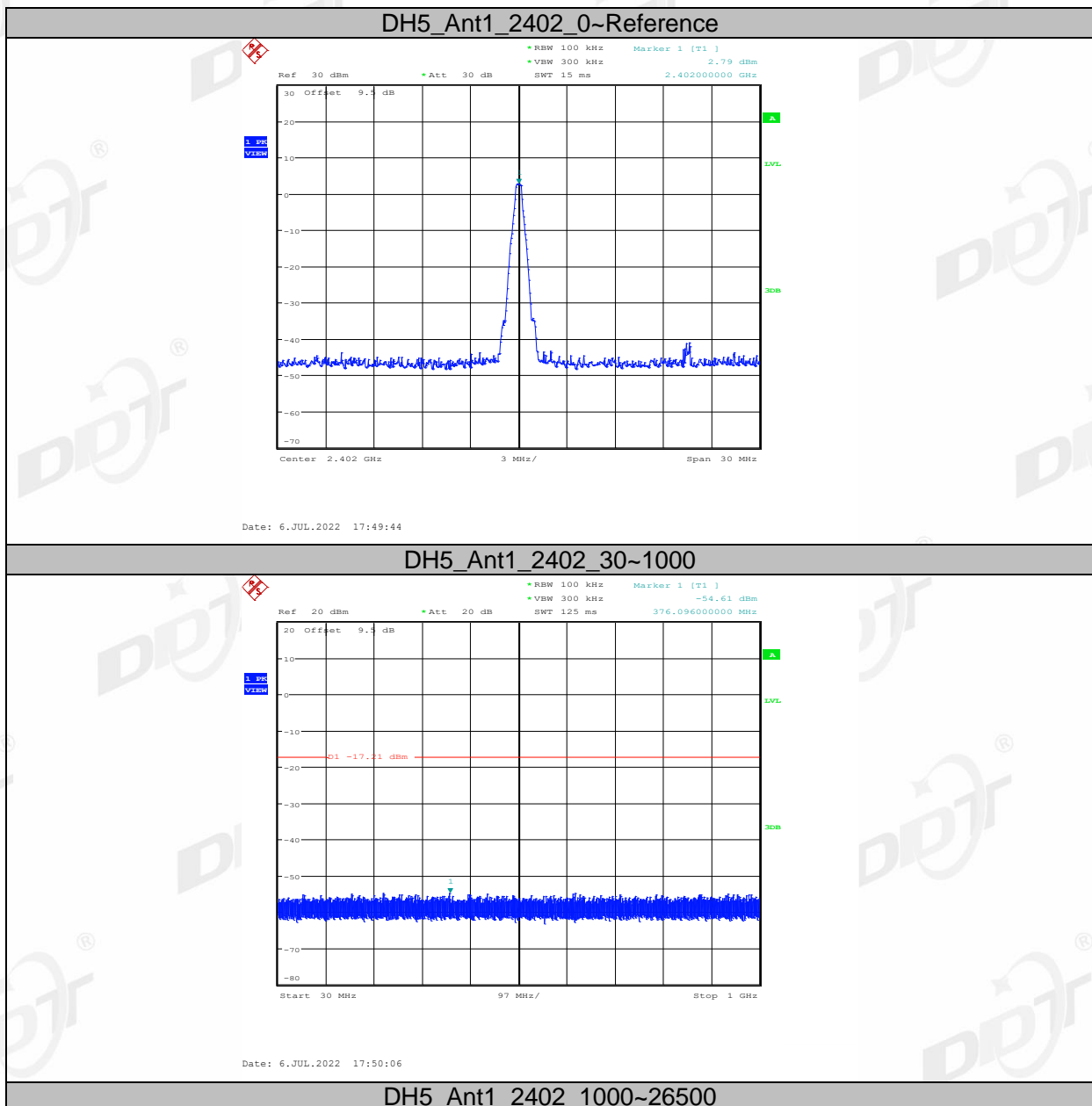

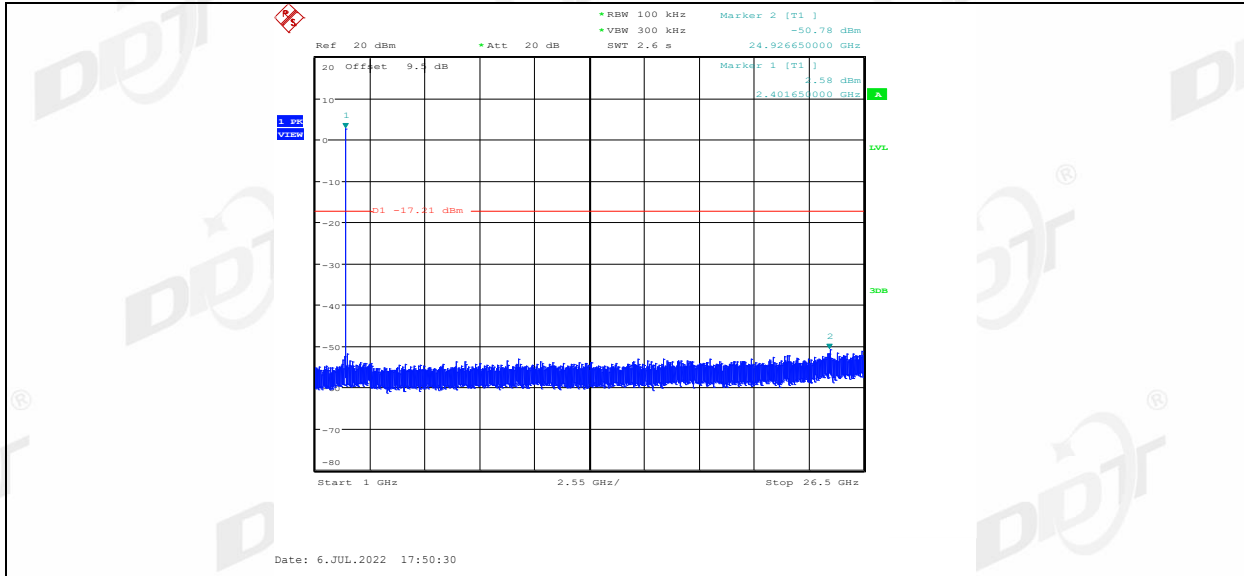

DH5_Ant1_2441_0~Reference

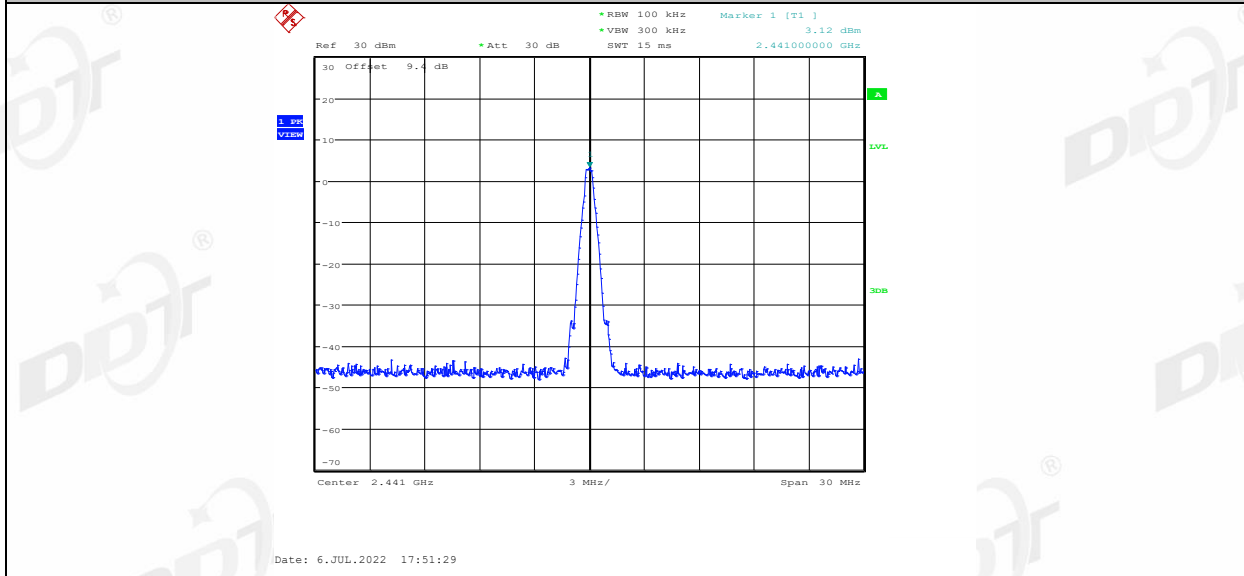

DH5_Ant1_2441_30~1000

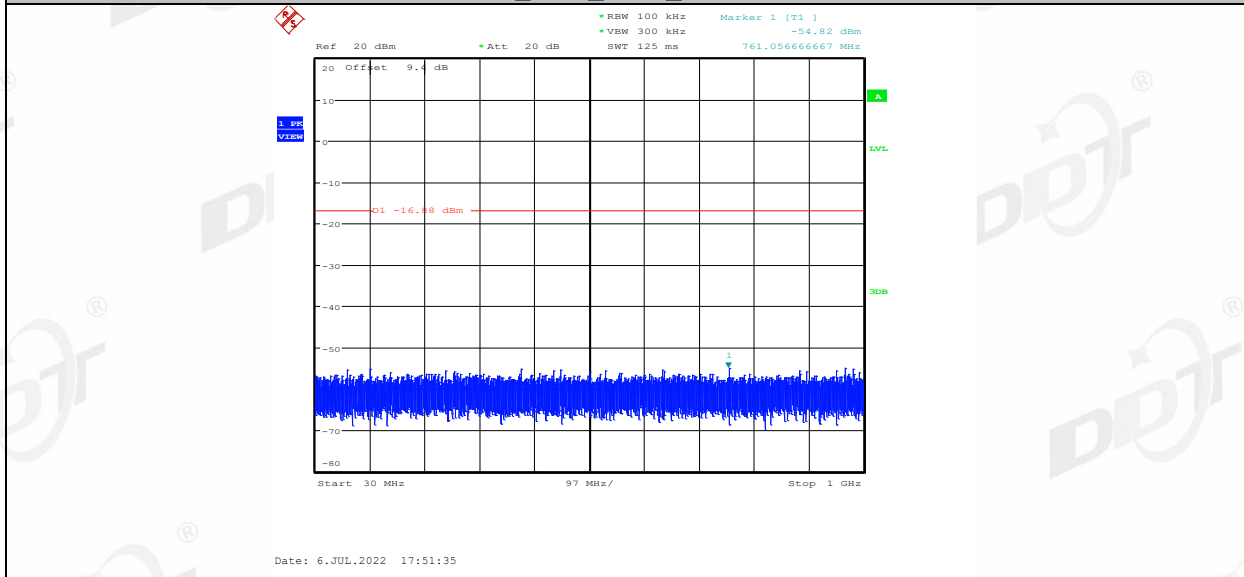

DH5_Ant1_2441_1000~26500

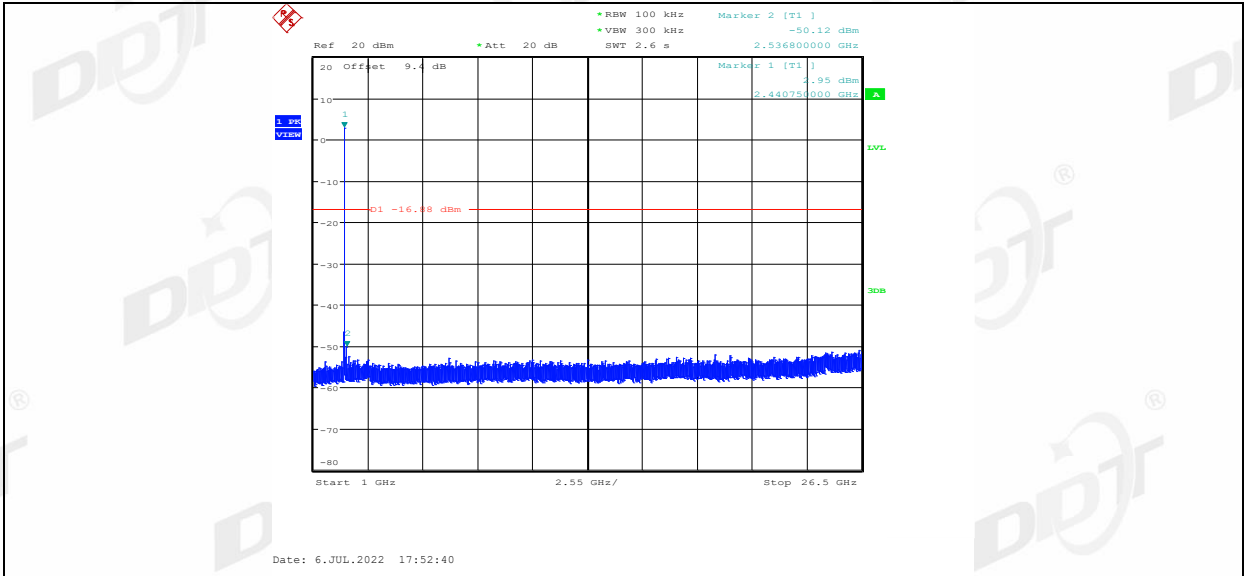

DH5_Ant1_2480_0~Reference

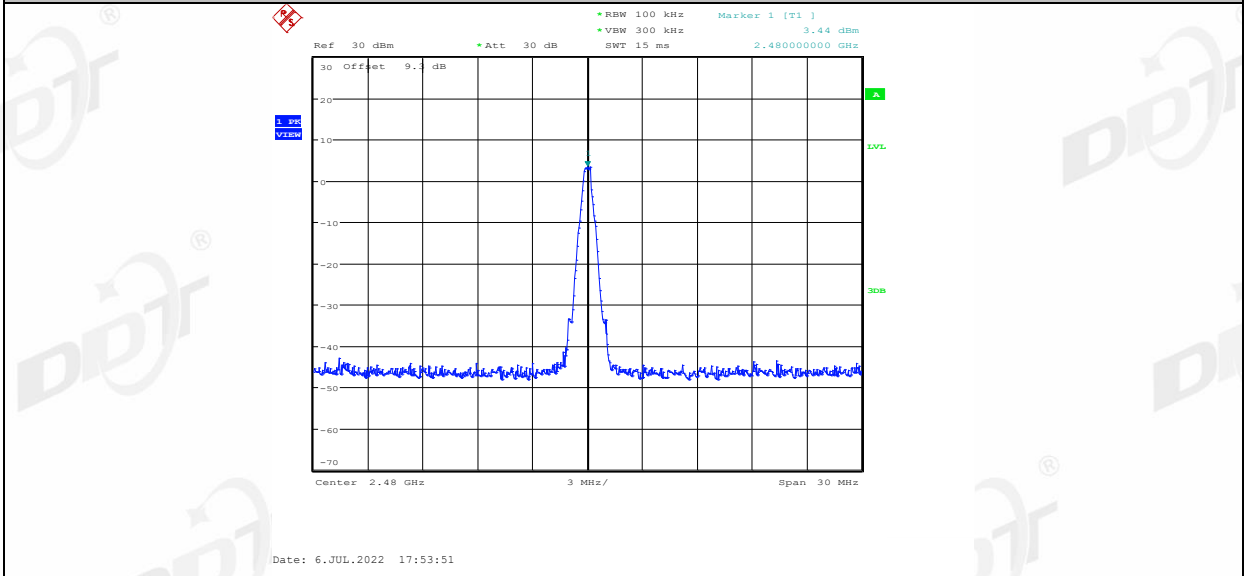

DH5_Ant1_2480_30~1000

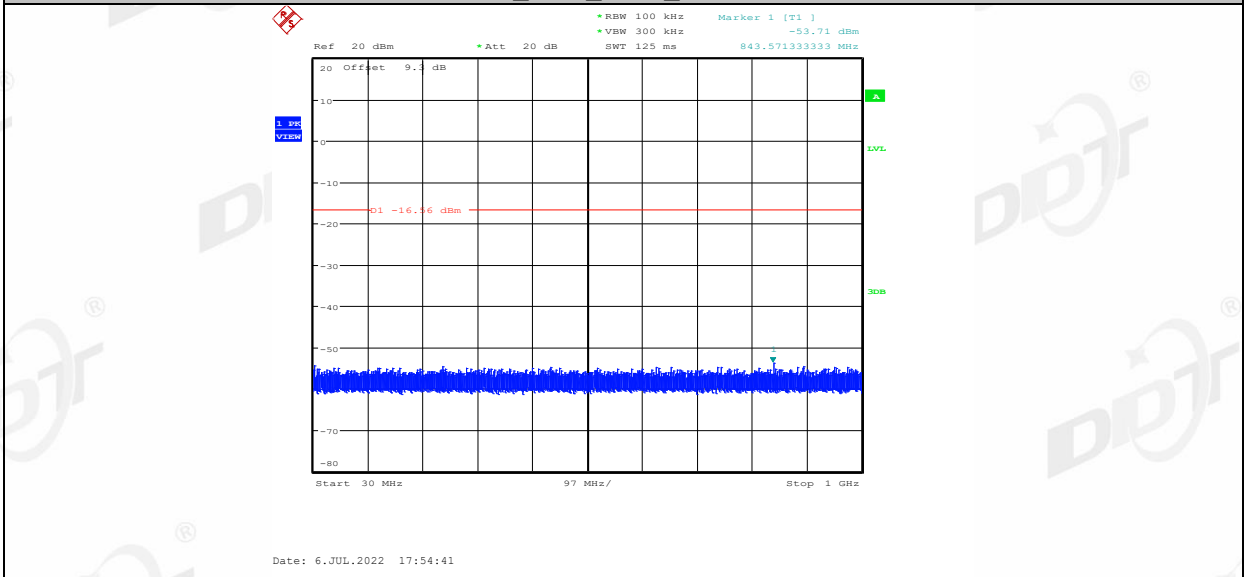

DH5_Ant1_2480_1000~26500

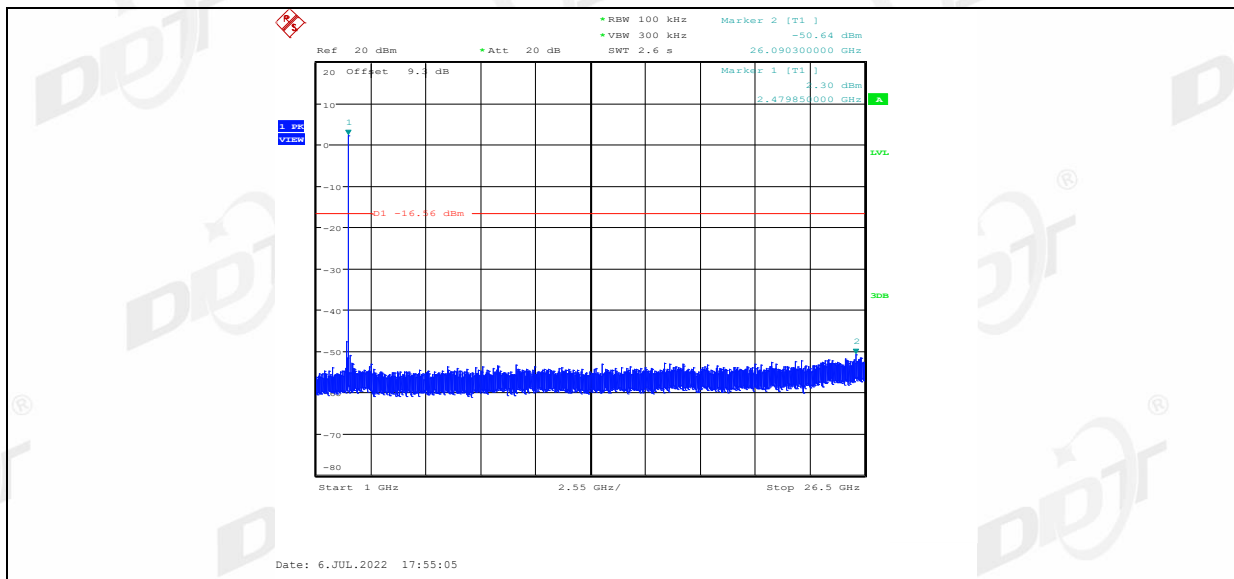

2DH5_Ant1_2402_0~Reference

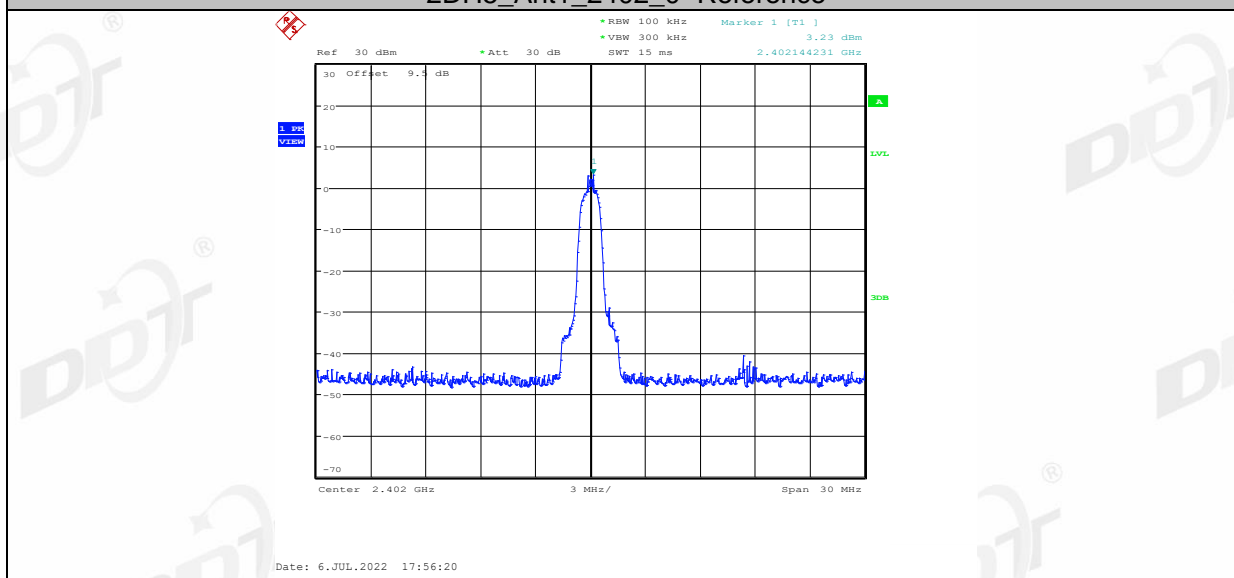

2DH5_Ant1_2402_30~1000

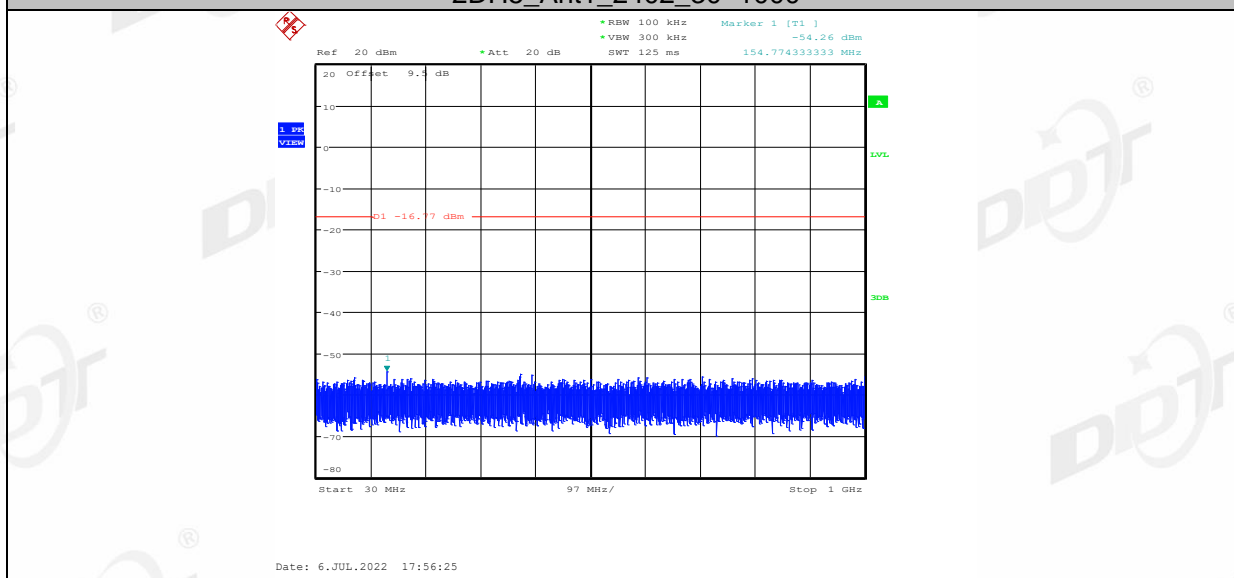

2DH5_Ant1_2402_1000~26500

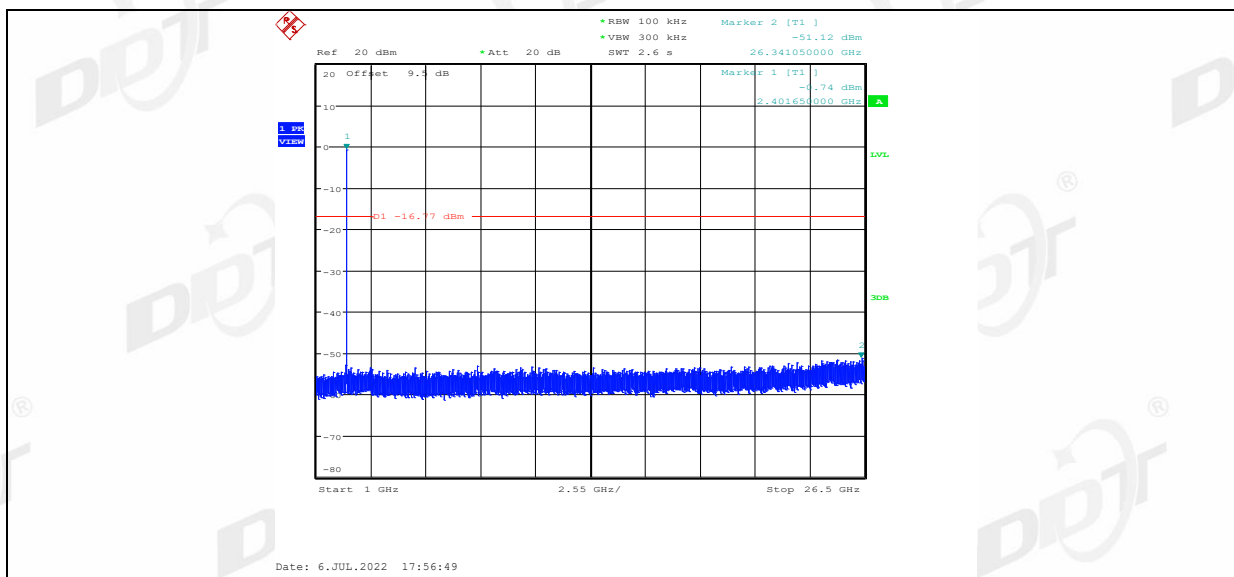

2DH5_Ant1_2441_0~Reference

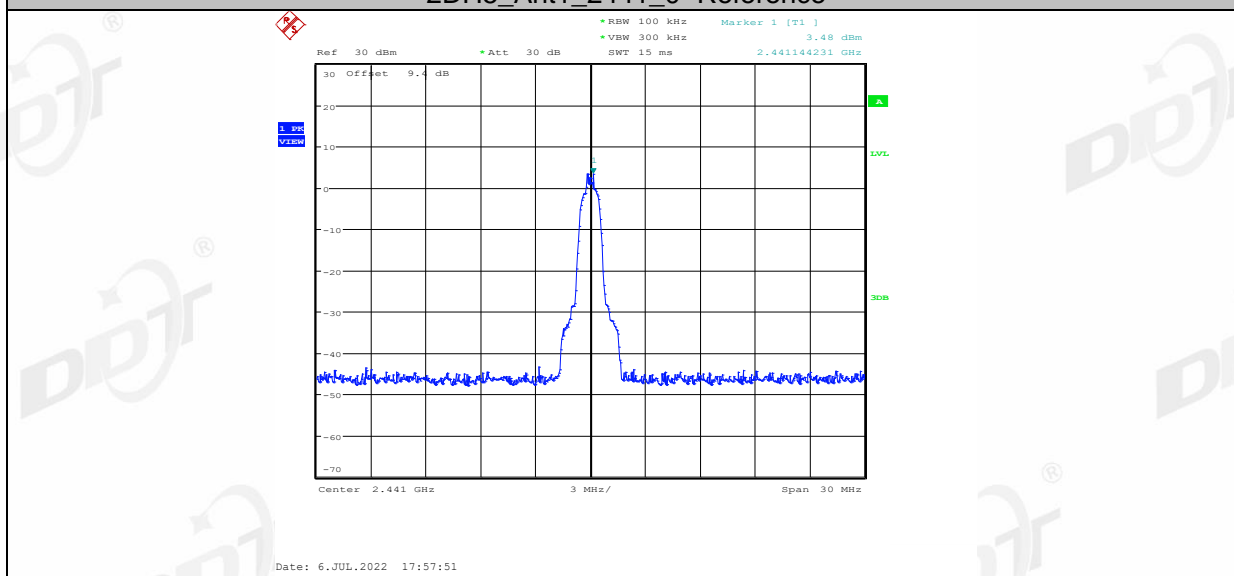

2DH5_Ant1_2441_30~1000

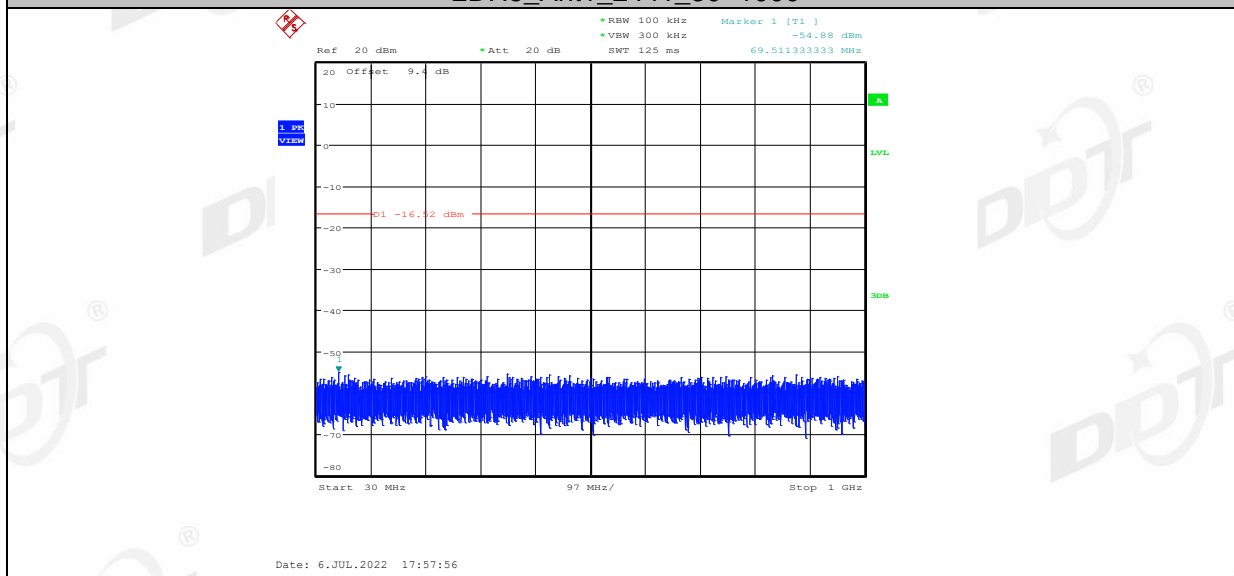

2DH5_Ant1_2441_1000~26500

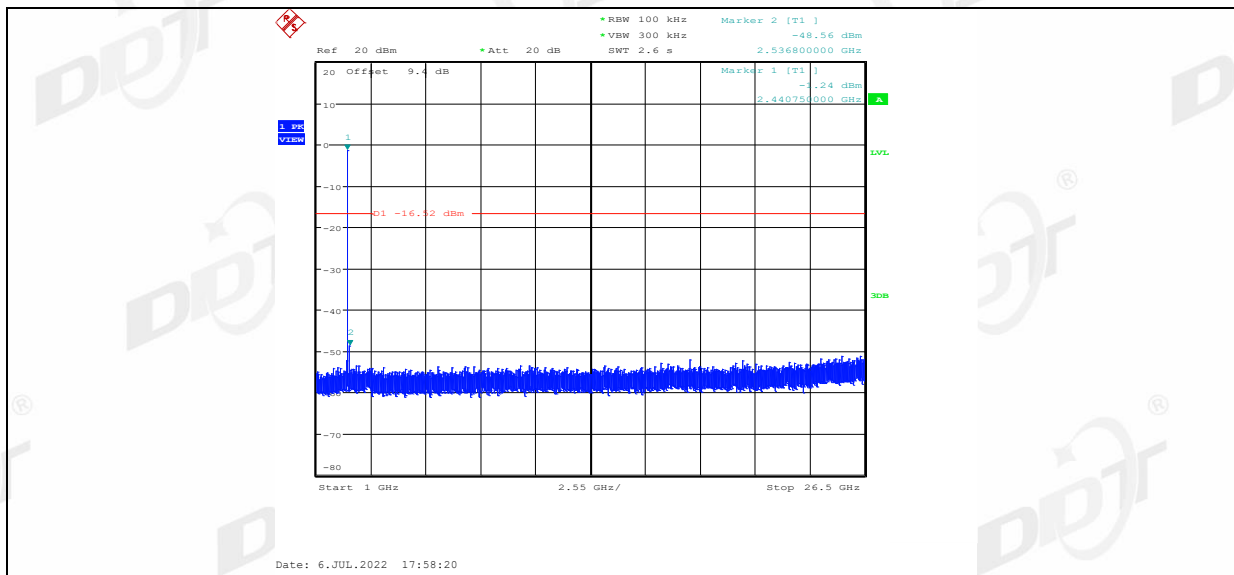

2DH5_Ant1_2480_0-Reference

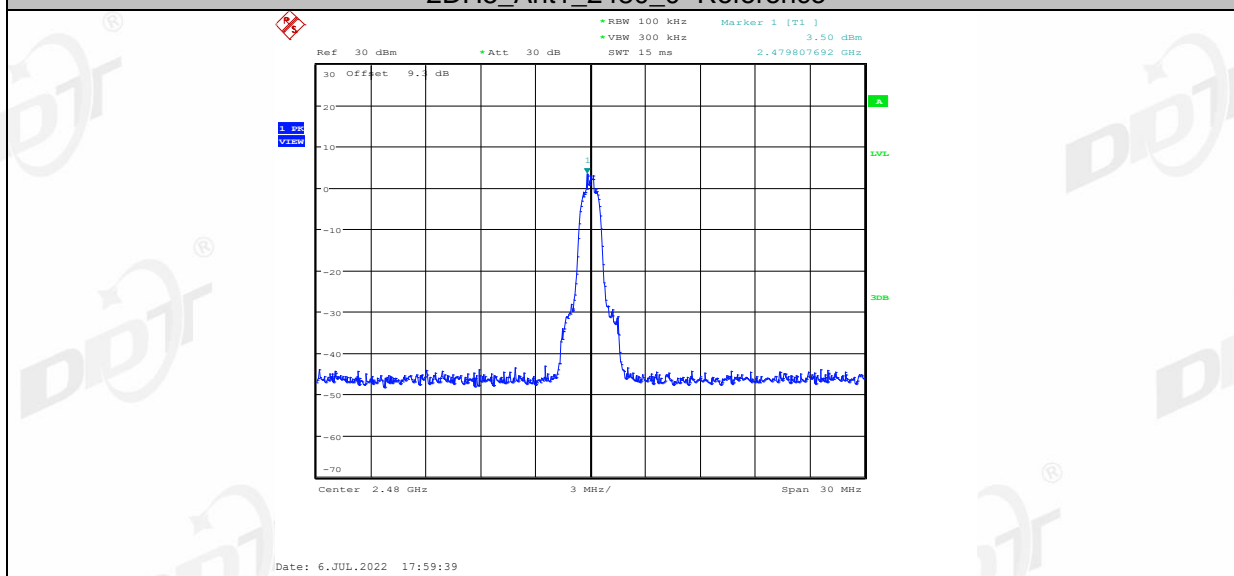

2DH5_Ant1_2480_30~1000

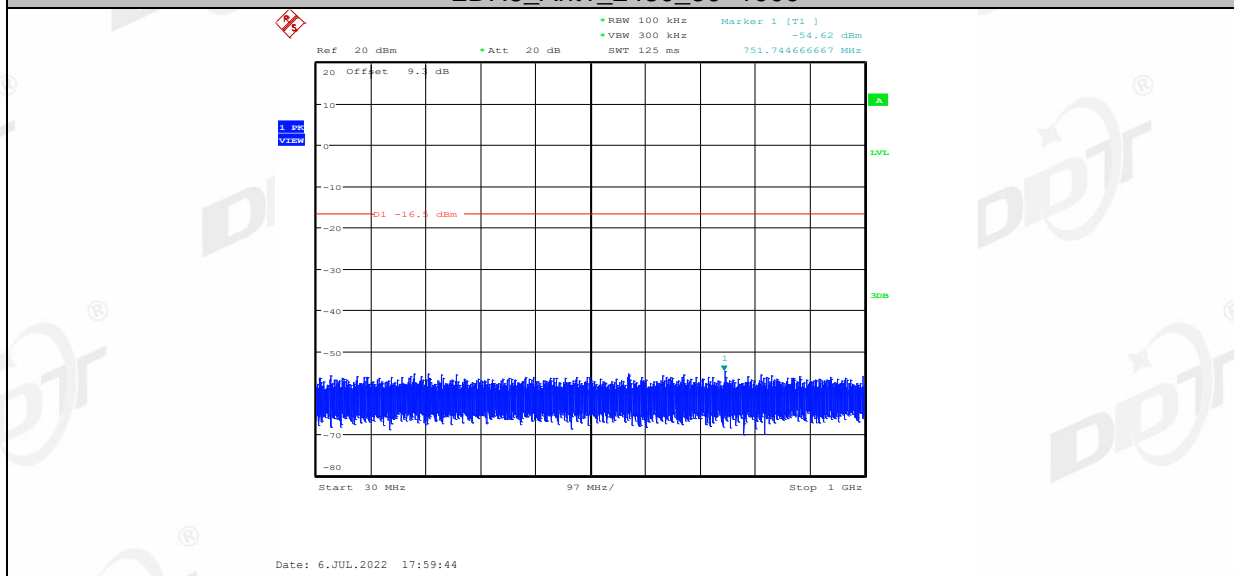

2DH5_Ant1_2480_1000~26500

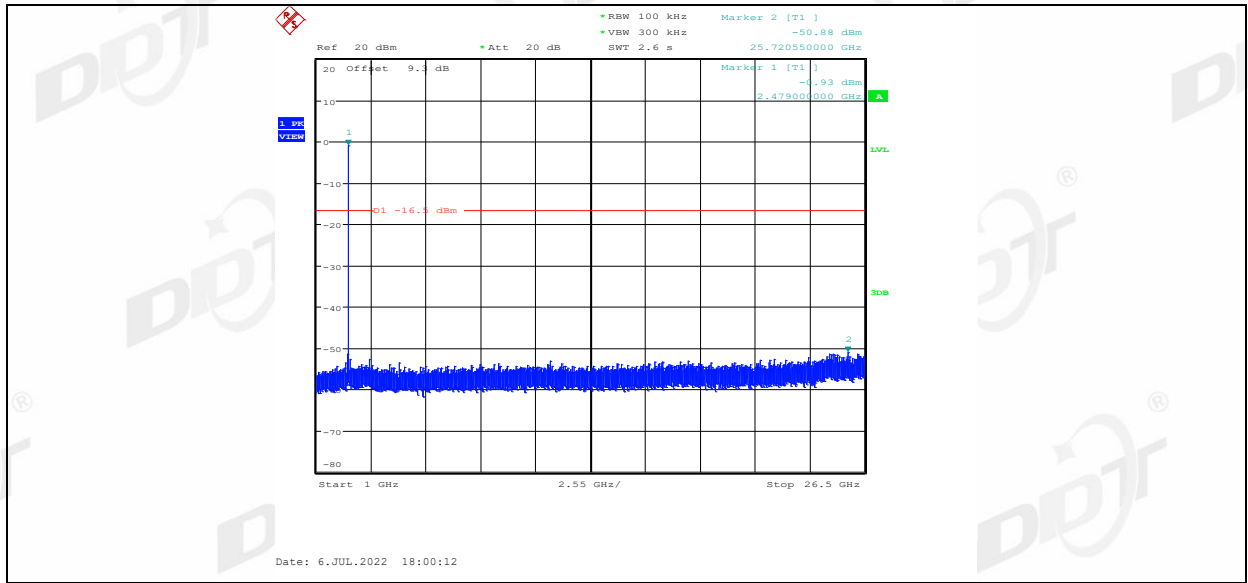

12. Band Edge Compliance (Radiated Method)

12.1. Block diagram of test setup

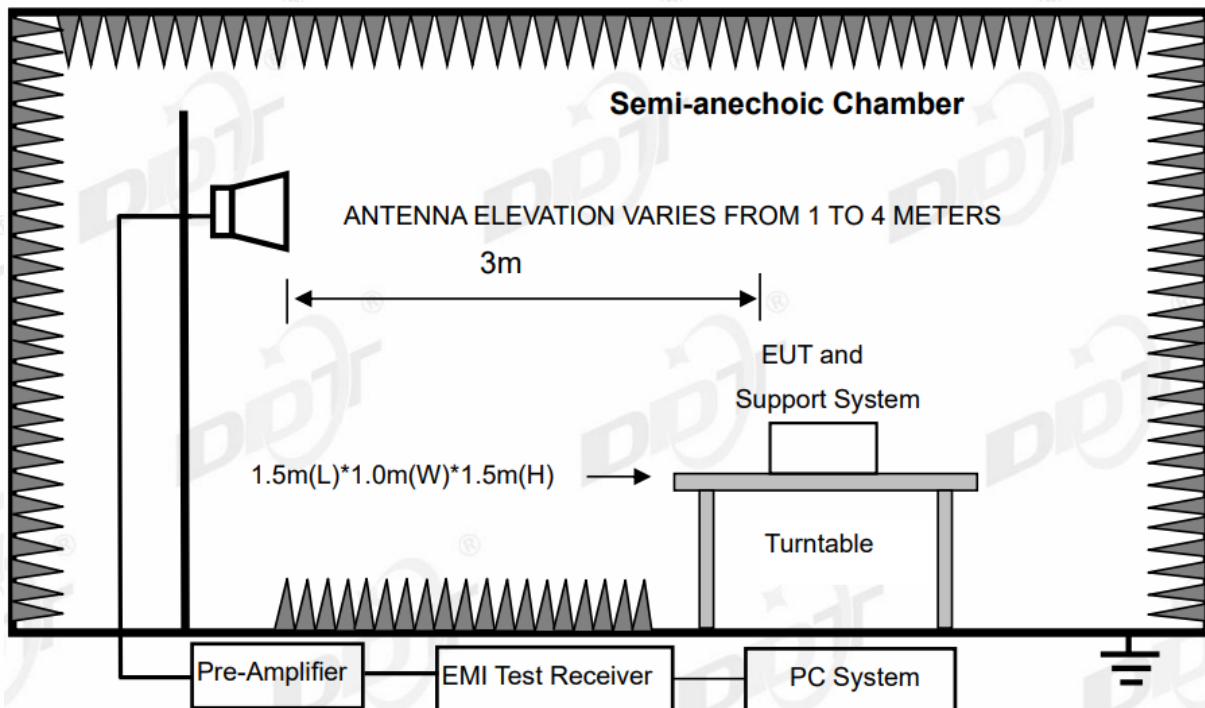

12.2. Limit

All restriction band should comply with 15.209, other emission should be at least 20 dB below the fundamental.

12.3. Test procedure

Same with clause 10.3 except change investigated frequency range from 2310 MHz to 2410 MHz and 2475 MHz to 2500 MHz.

Remark: All restriction band have been tested, and only the worst case is shown in report.

12.4. Test result

Pass. (See below detailed test result)

Remark: hopping on and hopping off mode all have been test, hopping off mode is worse and reported only, the worst case recorded in this report.

TR-4-E-009 Radiated Emission Test Result

Test Site : DDT 3m Chamber 3# D:\E3 6.111\2022 Report Data\Q22061414-4E aGROOVE-MINI\FCC ABOVE 1G.EM6
Test Date : 2022-06-30 **Tested By** : Bairong
EUT : Bluetooth Speaker **Model Number** : aGROOVE MINI
Power Supply : Battery **Test Mode** : Tx Mode
Condition : Temp:22°C,Humi:59.4%,Press:100.3kPa **Antenna/Distance** : 2021 BBHA 9120D
3#/3m/HORIZONTAL
Memo : DH5 2402

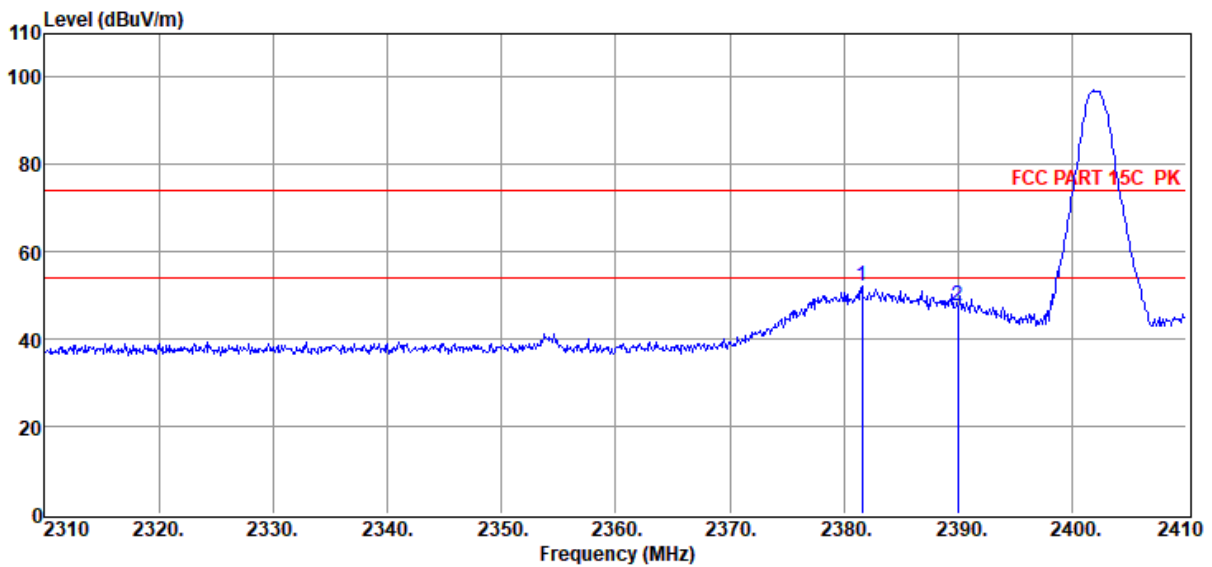

| Item (Mark) | Freq. (MHz) | Read Level (dBμV) | Antenna Factor (dB/m) | PRM Factor (dB) | Cable Loss (dB) | Filter Factor (dB) | Result Level (dBμV/m) | Limit Line (dBμV/m) | Over Limit (dB) | Detector | Polarization |
|-------------|-------------|-------------------|-----------------------|-----------------|-----------------|--------------------|-----------------------|---------------------|-----------------|----------|--------------|
| 1 | 2381.60 | 61.75 | 27.39 | 39.59 | 1.71 | 0.72 | 51.98 | 74.00 | -22.02 | Peak | HORIZONTAL |
| 2 | 2390.00 | 57.46 | 27.40 | 39.60 | 1.71 | 0.72 | 47.69 | 74.00 | -26.31 | Peak | HORIZONTAL |

Note: 1. Result Level = Read Level + Antenna Factor + Cable loss + Filter Factor - PRM Factor.
 2. If Peak Result complies with AV limit, AV Result is deemed to comply with AV limit.
 3. Test setup: RBW: 1 MHz, VBW: 3 MHz, Sweep time: auto.

TR-4-E-009 Radiated Emission Test Result

Test Site : DDT 3m Chamber 3# D:\E3 6.111\2022 Report Data\Q22061414-4E aGROOVE-MINI\FCC ABOVE 1G.EM6
Test Date : 2022-06-30 **Tested By** : Bairong
EUT : Bluetooth Speaker **Model Number** : aGROOVE MINI
Power Supply : Battery **Test Mode** : Tx Mode
Condition : Temp:22°C,Humi:59.4%,Press:100.3kPa **Antenna/Distance** : 2021 BBHA 9120D 3#/3m/VERTICAL
Memo : DH5 2402

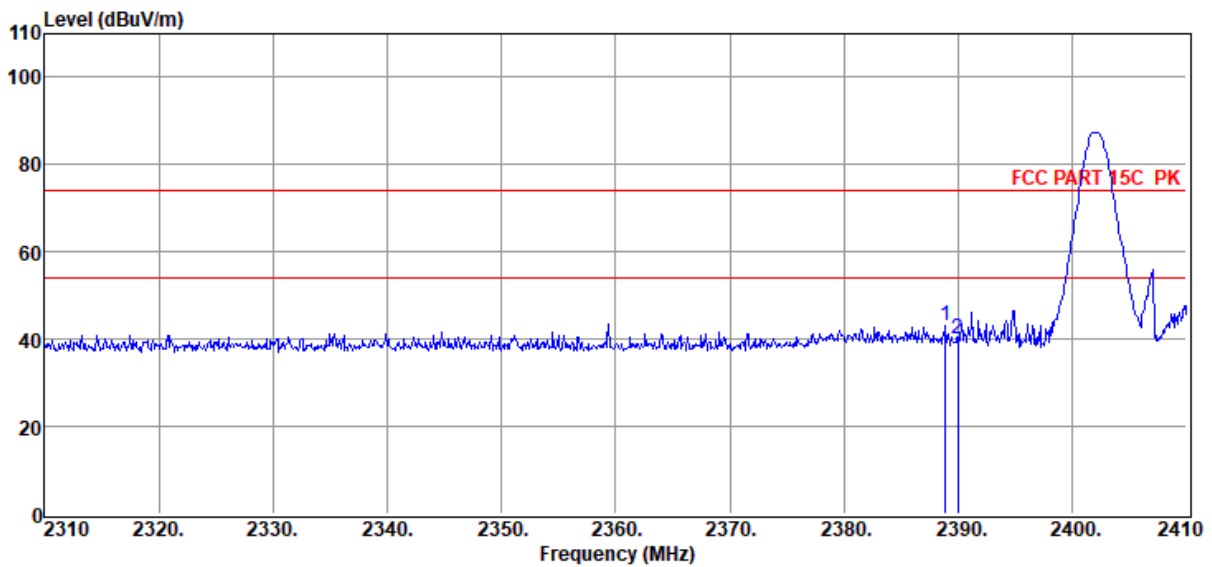

| Item (Mark) | Freq. (MHz) | Read Level (dBµV) | Antenna Factor (dB/m) | PRM Factor (dB) | Cable Loss (dB) | Filter Factor (dB) | Result Level (dBµV/m) | Limit Line (dBµV/m) | Over Limit (dB) | Detector | Polarization |
|-------------|-------------|-------------------|-----------------------|-----------------|-----------------|--------------------|-----------------------|---------------------|-----------------|----------|--------------|
| 1 | 2388.90 | 52.77 | 27.40 | 39.59 | 1.71 | 0.72 | 43.01 | 74.00 | -30.99 | Peak | VERTICAL |
| 2 | 2390.00 | 50.00 | 27.40 | 39.60 | 1.71 | 0.72 | 40.23 | 74.00 | -33.77 | Peak | VERTICAL |

Note: 1. Result Level = Read Level + Antenna Factor + Cable loss + Filter Factor - PRM Factor.
 2. If Peak Result complies with AV limit, AV Result is deemed to comply with AV limit.
 3. Test setup: RBW: 1 MHz, VBW: 3 MHz, Sweep time: auto.

TR-4-E-009 Radiated Emission Test Result

Test Site : DDT 3m Chamber 3#

D:\E3 6.111\2022 Report Data\Q22061414-4E
aGROOVE-MINI\FCC ABOVE 1G.EM6

Test Date : 2022-06-30

Tested By : Bairong

EUT : Bluetooth Speaker

Model Number : aGROOVE MINI

Power Supply : Battery

Test Mode : Tx Mode

Condition : Temp:22°C,Humi:59.4%,Press:100.3kPa

Antenna/Distance : 2021 BBHA 9120D
3#/3m/HORIZONTAL

Memo : DH5 2480

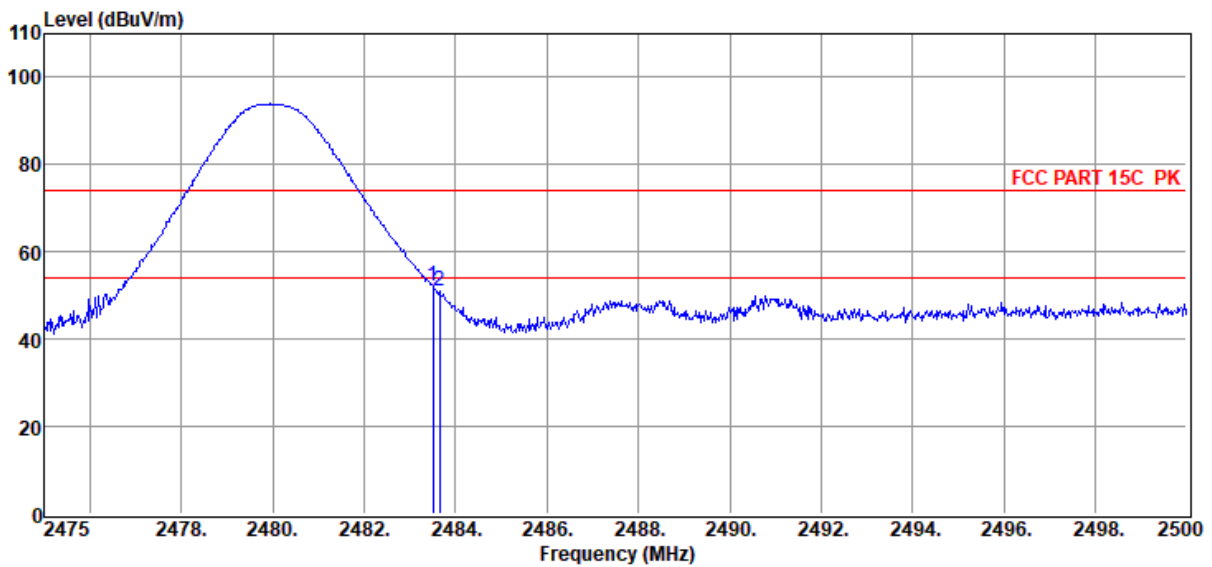

| Item (Mark) | Freq. (MHz) | Read Level (dBµV) | Antenna Factor (dB/m) | PRM Factor (dB) | Cable Loss (dB) | Filter Factor (dB) | Result Level (dBµV/m) | Limit Line (dBµV/m) | Over Limit (dB) | Detector | Polarization |
|-------------|-------------|-------------------|-----------------------|-----------------|-----------------|--------------------|-----------------------|---------------------|-----------------|----------|--------------|
| 1 | 2483.50 | 61.59 | 27.57 | 39.64 | 1.74 | 0.73 | 51.99 | 74.00 | -22.01 | Peak | HORIZONTAL |
| 2 | 2483.65 | 60.46 | 27.57 | 39.64 | 1.74 | 0.73 | 50.86 | 74.00 | -23.14 | Peak | HORIZONTAL |

- Note: 1. Result Level = Read Level + Antenna Factor + Cable loss + Filter Factor - PRM Factor.
 2. If Peak Result complies with AV limit, AV Result is deemed to comply with AV limit.
 3. Test setup: RBW: 1 MHz, VBW: 3 MHz, Sweep time: auto.

TR-4-E-009 Radiated Emission Test Result

Test Site : DDT 3m Chamber 3# D:\E3 6.111\2022 Report Data\Q22061414-4E aGROOVE-MINI\FCC ABOVE 1G.EM6
Test Date : 2022-06-30 **Tested By** : Bairong
EUT : Bluetooth Speaker **Model Number** : aGROOVE MINI
Power Supply : Battery **Test Mode** : Tx Mode
Condition : Temp:22°C,Humi:59.4%,Press:100.3kPa **Antenna/Distance** : 2021 BBHA 9120D 3#/3m/VERTICAL
Memo : DH5 2480

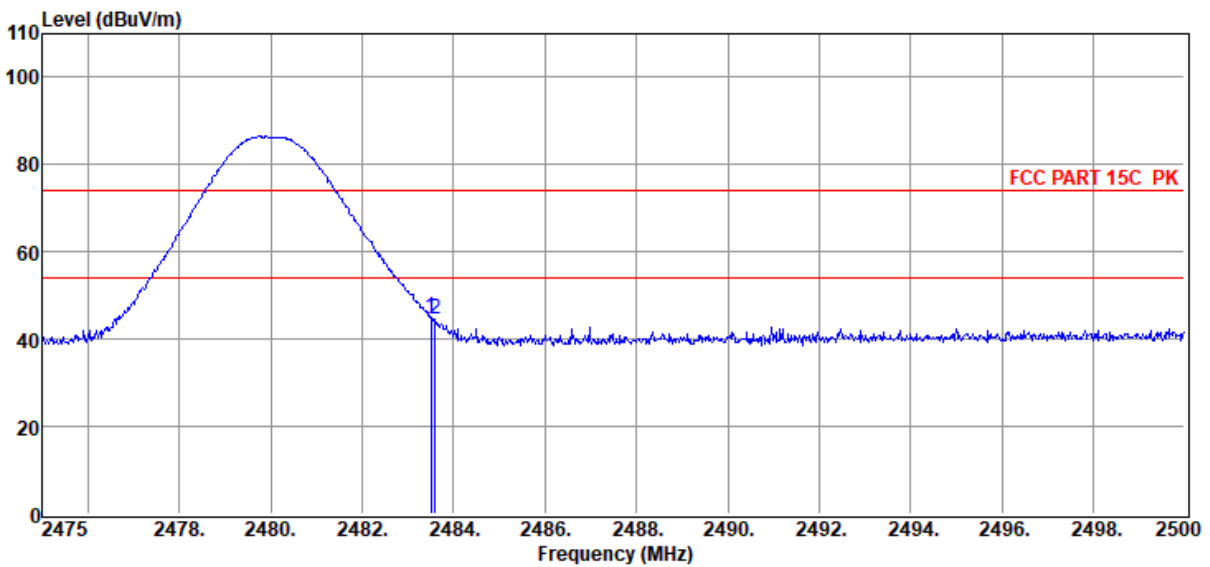

| Item (Mark) | Freq. (MHz) | Read Level (dBuV) | Antenna Factor (dB/m) | PRM Factor (dB) | Cable Loss (dB) | Filter Factor (dB) | Result Level (dBuV/m) | Limit Line (dBuV/m) | Over Limit (dB) | Detector | Polarization |
|-------------|-------------|-------------------|-----------------------|-----------------|-----------------|--------------------|-----------------------|---------------------|-----------------|----------|--------------|
| 1 | 2483.50 | 54.61 | 27.57 | 39.64 | 1.74 | 0.73 | 45.01 | 74.00 | -28.99 | Peak | VERTICAL |
| 2 | 2483.60 | 54.17 | 27.57 | 39.64 | 1.74 | 0.73 | 44.57 | 74.00 | -29.43 | Peak | VERTICAL |

Note: 1. Result Level = Read Level + Antenna Factor + Cable loss + Filter Factor - PRM Factor.
 2. If Peak Result complies with AV limit, AV Result is deemed to comply with AV limit.
 3. Test setup: RBW: 1 MHz, VBW: 3 MHz, Sweep time: auto.

TR-4-E-009 Radiated Emission Test Result

| | | | |
|---------------------|---------------------------------------|-------------------------|---------------------------------------|
| Test Site | : DDT 3m Chamber 3# | Tested By | : Bairong |
| Test Date | : 2022-06-30 | Model Number | : aGROOVE MINI |
| EUT | : Bluetooth Speaker | Test Mode | : Tx Mode |
| Power Supply | : Battery | Antenna/Distance | : 2021 BBHA 9120D 3#/3m/HORIZONTAL |
| Condition | : Temp:22°C,Humi:59.4%,Press:100.3kPa | | |
| Memo | : 2DH5 2402 | | |

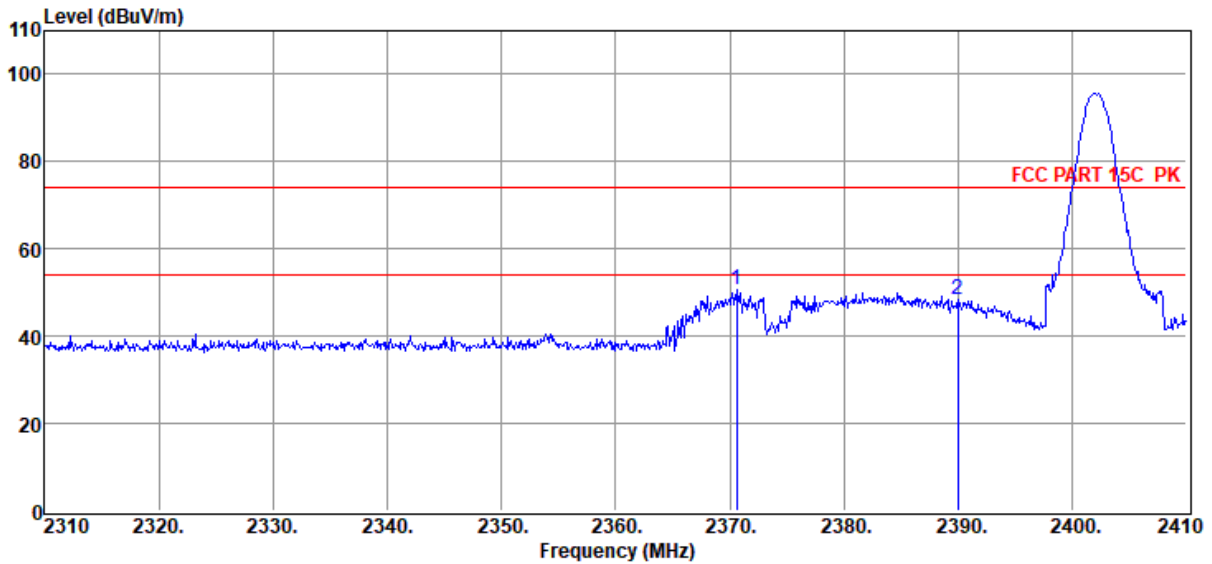

| Item (Mark) | Freq. (MHz) | Read Level (dBuV) | Antenna Factor (dB/m) | PRM Factor (dB) | Cable Loss (dB) | Filter Factor (dB) | Result Level (dBuV/m) | Limit Line (dBuV/m) | Over Limit (dB) | Detector | Polarization |
|-------------|-------------|-------------------|-----------------------|-----------------|-----------------|--------------------|-----------------------|---------------------|-----------------|----------|--------------|
| 1 | 2370.60 | 60.32 | 27.37 | 39.59 | 1.70 | 0.72 | 50.52 | 74.00 | -23.48 | Peak | HORIZONTAL |
| 2 | 2390.00 | 57.98 | 27.40 | 39.60 | 1.71 | 0.72 | 48.21 | 74.00 | -25.79 | Peak | HORIZONTAL |

Note: 1. Result Level = Read Level + Antenna Factor + Cable loss + Filter Factor - PRM Factor.
 2. If Peak Result complies with AV limit, AV Result is deemed to comply with AV limit.
 3. Test setup: RBW: 1 MHz, VBW: 3 MHz, Sweep time: auto.

TR-4-E-009 Radiated Emission Test Result

Test Site : DDT 3m Chamber 3# D:\E3 6.111\2022 Report Data\Q22061414-4E aGROOVE-MINI\FCC ABOVE 1G.EM6
Test Date : 2022-06-30 **Tested By** : Bairong
EUT : Bluetooth Speaker **Model Number** : aGROOVE MINI
Power Supply : Battery **Test Mode** : Tx Mode
Condition : Temp:22°C,Humi:59.4%,Press:100.3kPa **Antenna/Distance** : 2021 BBHA 9120D 3#/3m/VERTICAL
Memo : 2DH5 2402

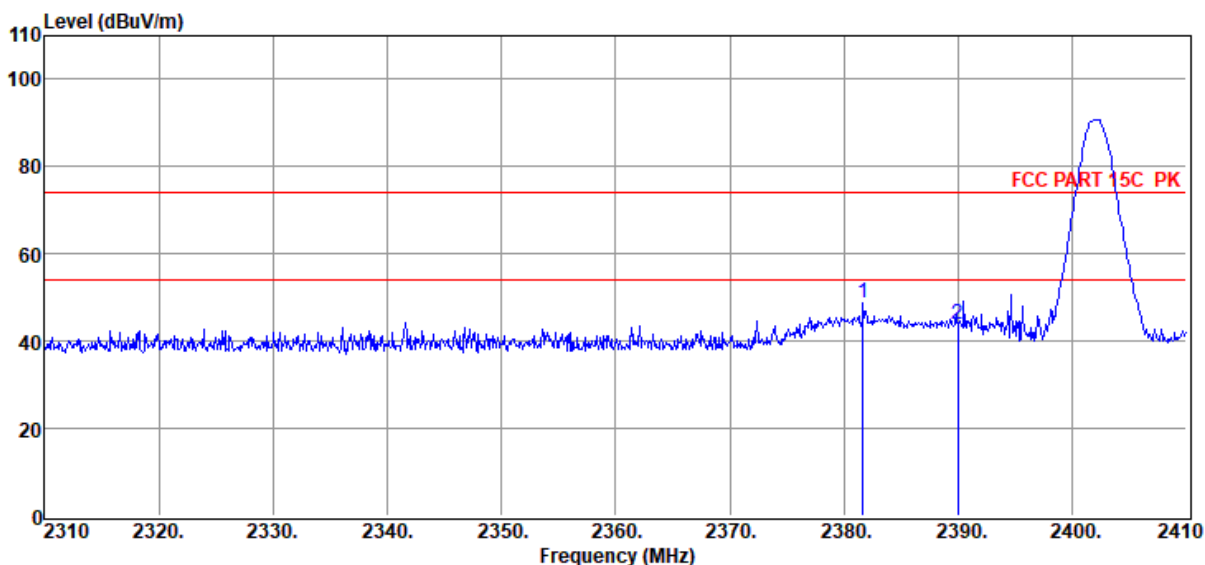

| Item (Mark) | Freq. (MHz) | Read Level (dBμV) | Antenna Factor (dB/m) | PRM Factor (dB) | Cable Loss (dB) | Filter Factor (dB) | Result Level (dBμV/m) | Limit Line (dBμV/m) | Over Limit (dB) | Detector | Polarization |
|-------------|-------------|-------------------|-----------------------|-----------------|-----------------|--------------------|-----------------------|---------------------|-----------------|----------|--------------|
| 1 | 2381.70 | 58.49 | 27.39 | 39.59 | 1.71 | 0.72 | 48.72 | 74.00 | -25.28 | Peak | VERTICAL |
| 2 | 2390.00 | 53.53 | 27.40 | 39.60 | 1.71 | 0.72 | 43.76 | 74.00 | -30.24 | Peak | VERTICAL |

Note: 1. Result Level = Read Level + Antenna Factor + Cable loss + Filter Factor - PRM Factor.
 2. If Peak Result complies with AV limit, AV Result is deemed to comply with AV limit.
 3. Test setup: RBW: 1 MHz, VBW: 3 MHz, Sweep time: auto.

TR-4-E-009 Radiated Emission Test Result

Test Site : DDT 3m Chamber 3#

D:\E3 6.111\2022 Report Data\Q22061414-4E aGROOVE-MINI\FCC ABOVE 1G.EM6

Test Date : 2022-06-30

Tested By : Bairong

EUT : Bluetooth Speaker

Model Number : aGROOVE MINI

Power Supply : Battery

Test Mode : Tx Mode

Condition : Temp:22°C,Humi:59.4%,Press:100.3kPa

Antenna/Distance : 2021 BBHA 9120D
3#/3m/HORIZONTAL

Memo : 2DH5 2480

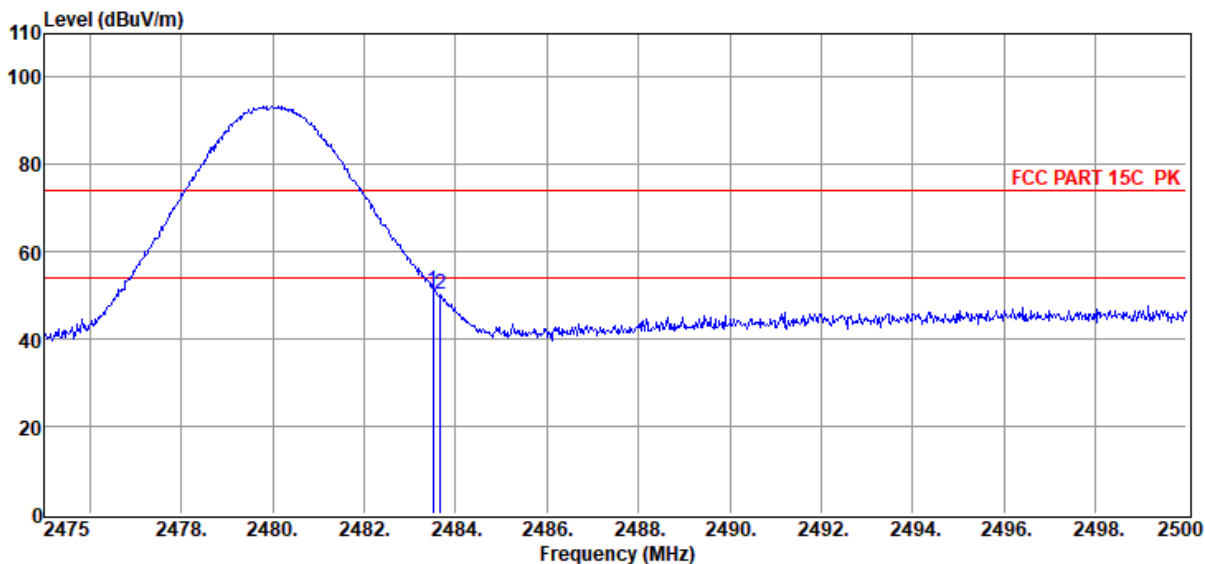

| Item (Mark) | Freq. (MHz) | Read Level (dBμV) | Antenna Factor (dB/m) | PRM Factor dB | Cable Loss dB | Filter Factor dB | Result Level (dBμV/m) | Limit Line (dBμV/m) | Over Limit (dB) | Detector | Polarization |
|-------------|-------------|-------------------|-----------------------|---------------|---------------|------------------|-----------------------|---------------------|-----------------|----------|--------------|
| 1 | 2483.50 | 60.76 | 27.57 | 39.64 | 1.74 | 0.73 | 51.16 | 74.00 | -22.84 | Peak | HORIZONTAL |
| 2 | 2483.68 | 60.01 | 27.57 | 39.64 | 1.74 | 0.73 | 50.41 | 74.00 | -23.59 | Peak | HORIZONTAL |

- Note: 1. Result Level = Read Level + Antenna Factor + Cable loss + Filter Factor - PRM Factor.
 2. If Peak Result complies with AV limit, AV Result is deemed to comply with AV limit.
 3. Test setup: RBW: 1 MHz, VBW: 3 MHz, Sweep time: auto.

TR-4-E-009 Radiated Emission Test Result

Test Site : DDT 3m Chamber 3# D:\E3 6.111\2022 Report Data\Q22061414-4E aGROOVE-MINI\FCC ABOVE 1G.EM6
Test Date : 2022-06-30 **Tested By** : Bairong
EUT : Bluetooth Speaker **Model Number** : aGROOVE MINI
Power Supply : Battery **Test Mode** : Tx Mode
Condition : Temp:22°C,Humi:59.4%,Press:100.3kPa **Antenna/Distance** : 2021 BBHA 9120D 3#/3m/VERTICAL
Memo : 2DH5 2480

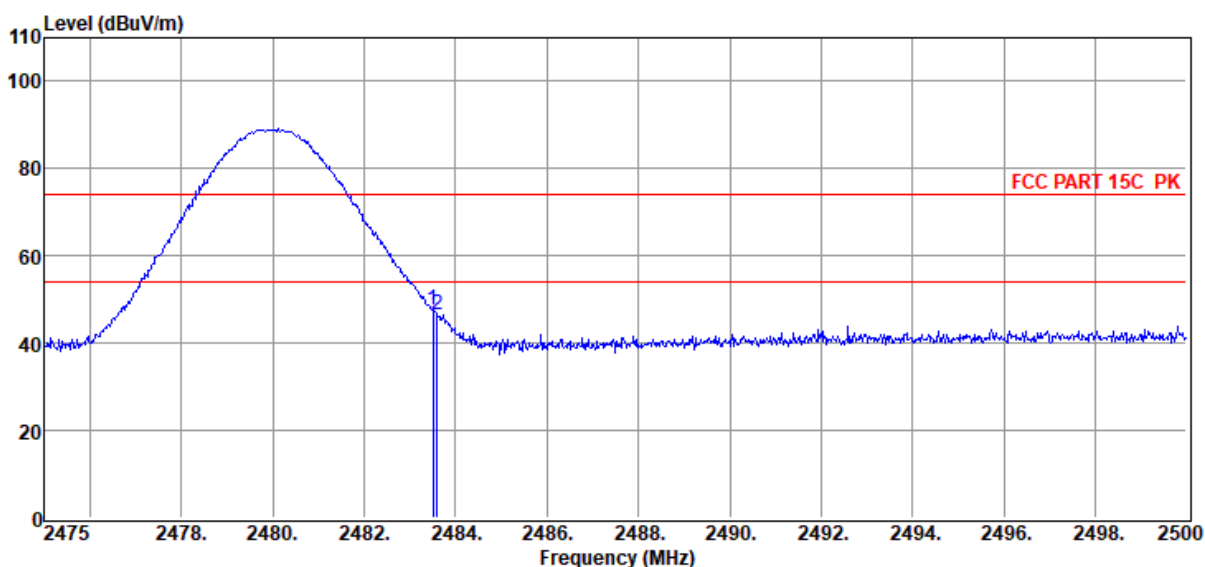

| Item (Mark) | Freq. (MHz) | Read Level (dBµV) | Antenna Factor (dB/m) | PRM Factor (dB) | Cable Loss (dB) | Filter Factor (dB) | Result Level (dBµV/m) | Limit Line (dBµV/m) | Over Limit (dB) | Detector | Polarization |
|-------------|-------------|-------------------|-----------------------|-----------------|-----------------|--------------------|-----------------------|---------------------|-----------------|----------|--------------|
| 1 | 2483.50 | 57.08 | 27.57 | 39.64 | 1.74 | 0.73 | 47.48 | 74.00 | -26.52 | Peak | VERTICAL |
| 2 | 2483.60 | 55.98 | 27.57 | 39.64 | 1.74 | 0.73 | 46.38 | 74.00 | -27.62 | Peak | VERTICAL |

Note: 1. Result Level = Read Level + Antenna Factor + Cable loss + Filter Factor - PRM Factor.
 2. If Peak Result complies with AV limit, AV Result is deemed to comply with AV limit.
 3. Test setup: RBW: 1 MHz, VBW: 3 MHz, Sweep time: auto.

13. Power Line Conducted Emission

13.1. Block diagram of test setup

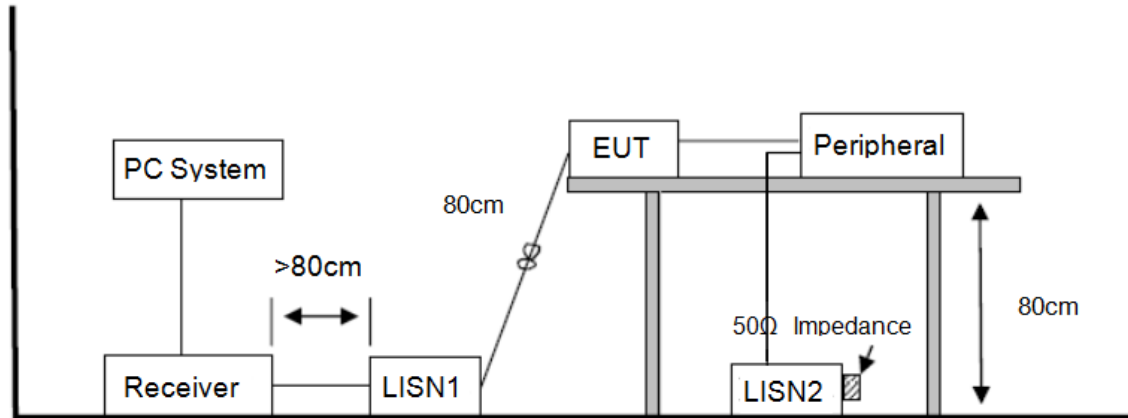

13.2. Power line conducted emission limits

| Frequency | Quasi-Peak Level dB(μ V) | Average Level dB(μ V) |
|-------------------|----------------------------------|-------------------------------|
| 150 kHz ~ 500 kHz | 66 ~ 56* | 56 ~ 46* |
| 500 kHz ~ 5 MHz | 56 | 46 |
| 5 MHz ~ 30 MHz | 60 | 50 |

Note 1: * Decreasing linearly with logarithm of frequency.

Note 2: The lower limit shall apply at the transition frequencies.

13.3. Test procedure

The EUT and Support equipment, if needed, were put placed on a non-metallic table, 80cm above the ground plane.

Configuration EUT to simulate typical usage as described in clause 2.4 and test equipment as described in clause 13.1 of this report.

All I/O cables were positioned to simulate typical actual usage as per ANSI C63.10.

All support equipment power received from a second LISN.

Emissions were measured on each current carrying line of the EUT using an EMI Test Receiver connected to the LISN powering the EUT.

The Receiver scanned from 150 kHz to 30 MHz for emissions in each of the test modes.

During the above scans, the emissions were maximized by cable manipulation.

The test mode(s) described in clause 2.4 were scanned during the preliminary test.

After the preliminary scan, we found the test mode producing the highest emission level.

The EUT configuration and worse cable configuration of the above highest emission levels were recorded for reference of the final test.

EUT and support equipment were set up on the test bench as per the configuration with highest emission level in the preliminary test.

A scan was taken on both power lines, Neutral and Line, recording at least the six highest emissions.

Emission frequency and amplitude were recorded into a computer in which correction factors were used to calculate the emission level and compare reading to the applicable limit.

The test data of the worst-case condition(s) was recorded.

The bandwidth of test receiver is set at 9 kHz.

13.4. Test result

Pass. (See below detailed test result)

Note1: All emissions not reported below are too low against the prescribed limits.

Note2: "-----" means Peak detection; "-----" means Average detection.

Note3: Pre-test AC conducted emission at both voltage AC 120V/60Hz and AC 240V/50Hz, recorded worse case.

TR-4-E-010 Conducted Emission Test Result

Test Site : DDT 1# Shield Room D:\2022 CE report date\Q220614141-4E aROOVE MINI\FCC.EM6
Test Date : 2022-07-06 **Tested By** : Bairong
EUT : Bluetooth Speaker **Model Number** : aGROOVE MINI
Power Supply : AC 120V/60Hz **Test Mode** : TX mode
Condition : TEMP:23.8°C, RH:62.0%, BP:101.2kPa **LISN** : 2021 1# ENV216/LINE
Memo :

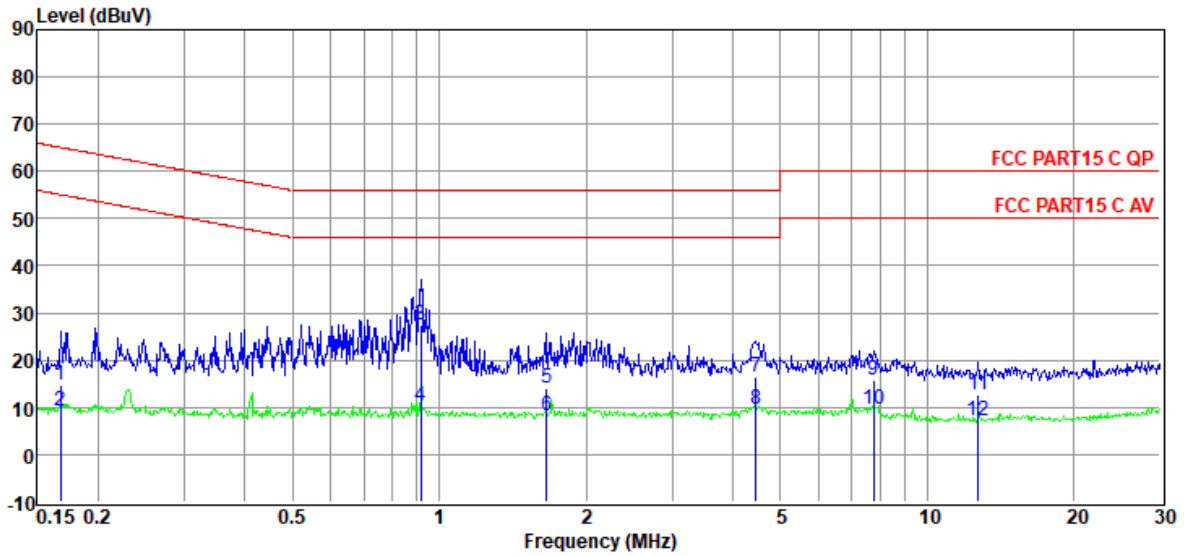

| Item (Mark) | Freq. (MHz) | Read Level (dBμV) | LISN Factor (dB) | Cable Loss (dB) | Pulse Limiter Factor (dB) | Result Level (dBμV) | Limit Line (dBμV) | Over Limit (dB) | Detector | Phase |
|-------------|-------------|-------------------|------------------|-----------------|---------------------------|---------------------|-------------------|-----------------|----------|-------|
| 1 | 0.17 | -5.00 | 9.68 | 0.01 | 9.92 | 14.61 | 65.08 | -50.47 | QP | LINE |
| 2 | 0.17 | -10.28 | 9.68 | 0.01 | 9.92 | 9.33 | 55.08 | -45.75 | Average | LINE |
| 3 | 0.92 | 7.99 | 9.58 | 0.03 | 9.89 | 27.49 | 56.00 | -28.51 | QP | LINE |
| 4 | 0.92 | -9.26 | 9.58 | 0.03 | 9.89 | 10.24 | 46.00 | -35.76 | Average | LINE |
| 5 | 1.66 | -5.38 | 9.53 | 0.04 | 9.89 | 14.08 | 56.00 | -41.92 | QP | LINE |
| 6 | 1.66 | -11.26 | 9.53 | 0.04 | 9.89 | 8.20 | 46.00 | -37.80 | Average | LINE |
| 7 | 4.45 | -3.26 | 9.58 | 0.06 | 9.92 | 16.30 | 56.00 | -39.70 | QP | LINE |
| 8 | 4.45 | -9.87 | 9.58 | 0.06 | 9.92 | 9.69 | 46.00 | -36.31 | Average | LINE |
| 9 | 7.77 | -3.87 | 9.50 | 0.09 | 9.94 | 15.66 | 60.00 | -44.34 | QP | LINE |
| 10 | 7.77 | -9.85 | 9.50 | 0.09 | 9.94 | 9.68 | 50.00 | -40.32 | Average | LINE |
| 11 | 12.72 | -7.11 | 9.68 | 0.13 | 9.93 | 12.63 | 60.00 | -47.37 | QP | LINE |
| 12 | 12.72 | -12.56 | 9.68 | 0.13 | 9.93 | 7.18 | 50.00 | -42.82 | Average | LINE |

Note:

1. Result Level = Read Level + LISN Factor + Pulse Limiter Factor + Cable loss.
2. If QP Result complies with AV limit, AV Result is deemed to comply with AV limit.
3. Test setup: RBW: 200 Hz (9 kHz—150 kHz), 9 kHz (150 kHz—30 MHz).
4. Step size: 80Hz (0.009MHz-0.15MHz), 4 kHz (0.15MHz-30MHz), Scan time: auto.

TR-4-E-010 Conducted Emission Test Result

Test Site : DDT 1# Shield Room D:\2022 CE report date\Q220614141-4E aROOVE MINI\FCC.EM6
Test Date : 2022-07-06 **Tested By** : Bairong
EUT : Bluetooth Speaker **Model Number** : aGROOVE MINI
Power Supply : AC 120V/60Hz **Test Mode** : TX mode
Condition : TEMP:23.8°C, RH:62.0%, BP:101.2kPa **LISN** : 2021 1# ENV216/NEUTRAL
Memo :

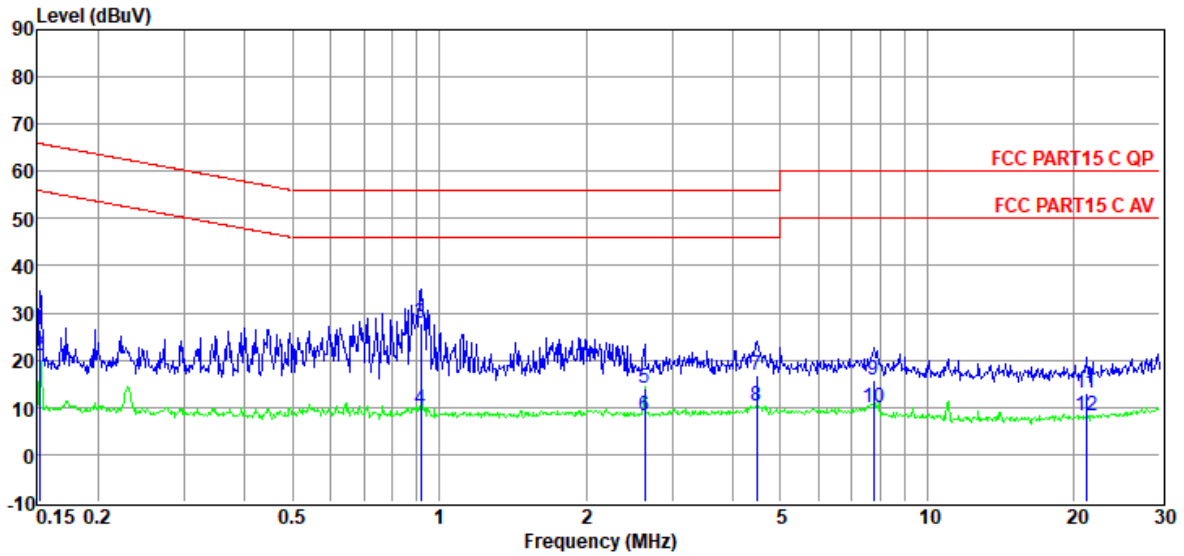

| Item (Mark) | Freq. (MHz) | Read Level (dBμV) | LISN Factor (dB) | Cable Loss (dB) | Pulse Limiter Factor (dB) | Result Level (dBμV) | Limit Line (dBμV) | Over Limit (dB) | Detector | Phase |
|-------------|-------------|-------------------|------------------|-----------------|---------------------------|---------------------|-------------------|-----------------|----------|---------|
| 1 | 0.15 | 6.59 | 9.80 | 0.01 | 9.92 | 26.32 | 65.91 | -39.59 | QP | NEUTRAL |
| 2 | 0.15 | 1.21 | 9.80 | 0.01 | 9.92 | 20.94 | 55.91 | -34.97 | Average | NEUTRAL |
| 3 | 0.92 | 8.16 | 9.72 | 0.03 | 9.89 | 27.80 | 56.00 | -28.20 | QP | NEUTRAL |
| 4 | 0.92 | -10.13 | 9.72 | 0.03 | 9.89 | 9.51 | 46.00 | -36.49 | Average | NEUTRAL |
| 5 | 2.64 | -5.61 | 9.68 | 0.05 | 9.90 | 14.02 | 56.00 | -41.98 | QP | NEUTRAL |
| 6 | 2.64 | -11.42 | 9.68 | 0.05 | 9.90 | 8.21 | 46.00 | -37.79 | Average | NEUTRAL |
| 7 | 4.48 | -3.04 | 9.76 | 0.06 | 9.92 | 16.70 | 56.00 | -39.30 | QP | NEUTRAL |
| 8 | 4.48 | -9.63 | 9.76 | 0.06 | 9.92 | 10.11 | 46.00 | -35.89 | Average | NEUTRAL |
| 9 | 7.77 | -4.07 | 9.66 | 0.09 | 9.94 | 15.62 | 60.00 | -44.38 | QP | NEUTRAL |
| 10 | 7.77 | -9.70 | 9.66 | 0.09 | 9.94 | 9.99 | 50.00 | -40.01 | Average | NEUTRAL |
| 11 | 21.15 | -6.95 | 9.81 | 0.18 | 9.97 | 13.01 | 60.00 | -46.99 | QP | NEUTRAL |
| 12 | 21.15 | -11.91 | 9.81 | 0.18 | 9.97 | 8.05 | 50.00 | -41.95 | Average | NEUTRAL |

Note:

1. Result Level = Read Level + LISN Factor + Pulse Limiter Factor + Cable loss.
2. If QP Result complies with AV limit, AV Result is deemed to comply with AV limit.
3. Test setup: RBW: 200 Hz (9 kHz—150 kHz), 9 kHz (150 kHz—30 MHz).
4. Step size: 80Hz (0.009MHz-0.15MHz), 4 kHz (0.15MHz-30MHz), Scan time: auto.

14. Antenna Requirements

14.1. Limit

For intentional device, according to FCC 47 CFR Section 15.203, an intentional radiator shall be designed to ensure that no antenna other than that furnished by the responsible party shall be used with the device. And according to FCC 47 CFR Section 15.247 (b), if transmitting antennas of directional gain greater than 6 dBi are used, the power shall be reduced by the amount in dB that the directional gain of the antenna exceeds 6 dBi.

14.2. Result

The antenna used for this product and that no antenna other than that furnished by the responsible party shall be used with the device, the maximum peak gain is -0.58 dBi.