

Radiated Emission test (below 1 GHz)

TR-4-E-009 Radiated Emission Test Result

Test Site : DDT 3m Chamber 3#
Test Date : 2022-05-23
EUT : Wireless Speaker
Power Supply : Battery
Condition : Temp:23.2°C,Humi:59.2%,Press:100.3kPa
Memo :

D:\E3 6.11\2022 Report Data\Q22031115-2E aGO
MINI NEW FCC BELOW 1G.EM6
Tested By : James Gan
Model Number : aGO MINI
Test Mode : Tx Mode
Antenna/Distance : 2021 VLUB 9163 3#/3m/HORIZONTAL

Data:
1

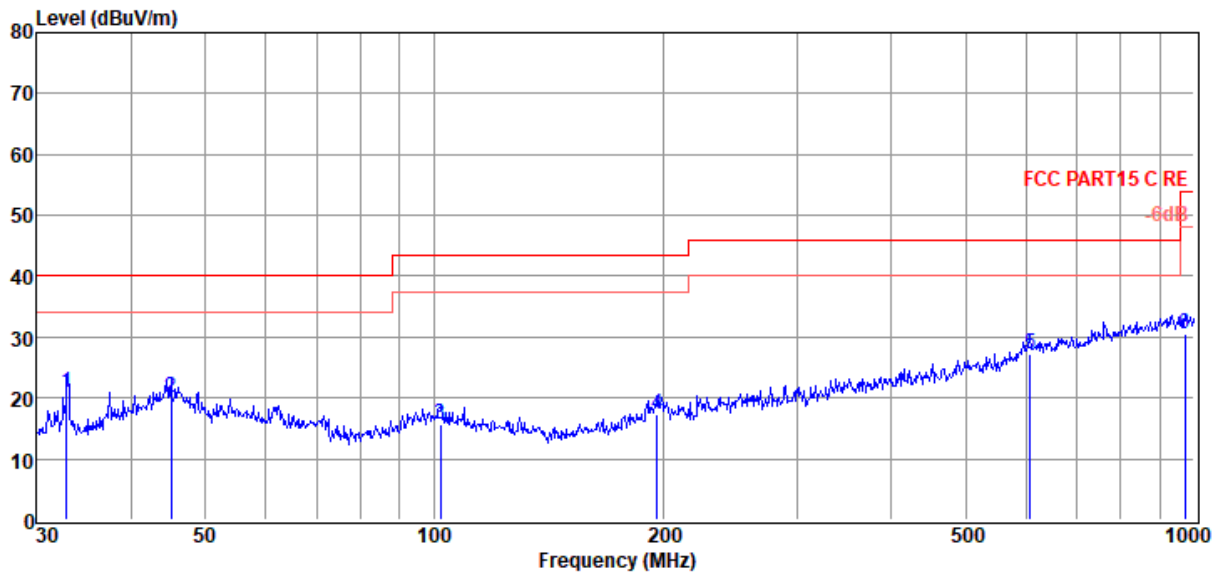

Item (Mark)	Freq. (MHz)	Read Level (dBuV)	Antenna Factor (dB/m)	Cable Loss (dB)	Result Level (dBuV/m)	Limit Line (dBuV/m)	Over Limit (dB)	Detector	Polarization
1	32.86	8.52	8.91	3.57	21.00	40.00	-19.00	QP	HORIZONTAL
2	45.06	1.48	15.07	3.64	20.19	40.00	-19.81	QP	HORIZONTAL
3	102.00	0.09	11.60	3.99	15.68	43.50	-27.82	QP	HORIZONTAL
4	196.51	1.17	11.80	4.44	17.41	43.50	-26.09	QP	HORIZONTAL
5	607.79	2.18	19.20	5.76	27.14	46.00	-18.86	QP	HORIZONTAL
6	972.34	1.66	22.25	6.69	30.60	54.00	-23.40	QP	HORIZONTAL

Note: 1. Result Level = Read Level + Antenna Factor + Cable loss.

2. If Peak Result complies with QP limit, QP Result is deemed to comply with QP limit.

3. Test setup: RBW: 120 kHz, VBW: 300 kHz, Sweep time: auto.

TR-4-E-009 Radiated Emission Test Result

Test Site : DDT 3m Chamber 3#

D:\E3 6.11\2022 Report Data\Q22031115-2E aGO
MINI\NEW\FCC BELOW 1G.EM6

Test Date : 2022-05-23

Tested By : James Gan

EUT : Wireless Speaker

Model Number : aGO MINI

Power Supply : Battery

Test Mode : Tx Mode

Condition : Temp:23.2°C,Humi:59.2%,Press:100.3kPa

Antenna/Distance : 2021 VLUB 9163 3#/3m/VERTICAL

Memo :

Data:
2

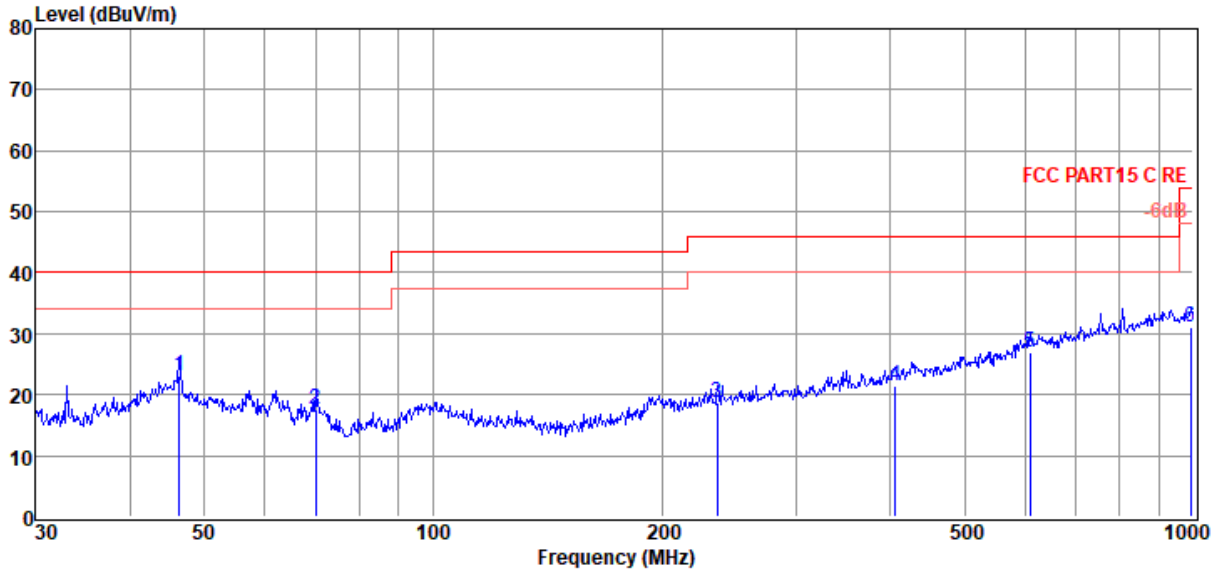

Item (Mark)	Freq. (MHz)	Read Level (dBμV)	Antenna Factor (dB/m)	Cable Loss (dB)	Result Level (dBμV/m)	Limit Line (dBμV/m)	Over Limit (dB)	Detector	Polarization
1	46.34	5.11	14.40	3.65	23.16	40.00	-16.84	QP	VERTICAL
2	70.09	4.90	8.99	3.82	17.71	40.00	-22.29	QP	VERTICAL
3	236.65	1.59	12.37	4.60	18.56	46.00	-27.44	QP	VERTICAL
4	406.09	0.58	15.64	5.17	21.39	46.00	-24.61	QP	VERTICAL
5	609.92	1.90	19.20	5.76	26.86	46.00	-19.14	QP	VERTICAL
6	993.01	1.95	22.40	6.80	31.15	54.00	-22.85	QP	VERTICAL

Note: 1. Result Level = Read Level + Antenna Factor + Cable loss.

2. If Peak Result complies with QP limit, QP Result is deemed to comply with QP limit.

3. Test setup: RBW: 120 kHz, VBW: 300 kHz, Sweep time: auto.

Radiated Emission test (above 1 GHz)

TR-4-E-009 Radiated Emission Test Result

Test Site : DDT 3m Chamber 3#
Test Date : 2022-05-23
EUT : Wireless Speaker
Power Supply : Battery
Condition : Temp:22.8°C,Humi:53%,Press:100.1kPa
Memo : 2402

Tested By : Kennys Zhang
Model Number : aGO MINI
Test Mode : Tx Mode
Antenna/Distance : 2021 BBHA 9120D
 3#/3m/HORIZONTAL

D:\E3 6.111\2022 Report Data\Q22031115-2E aGO
 MINI\NEW\FCC ABOVE 1G .EM6

Data: 1

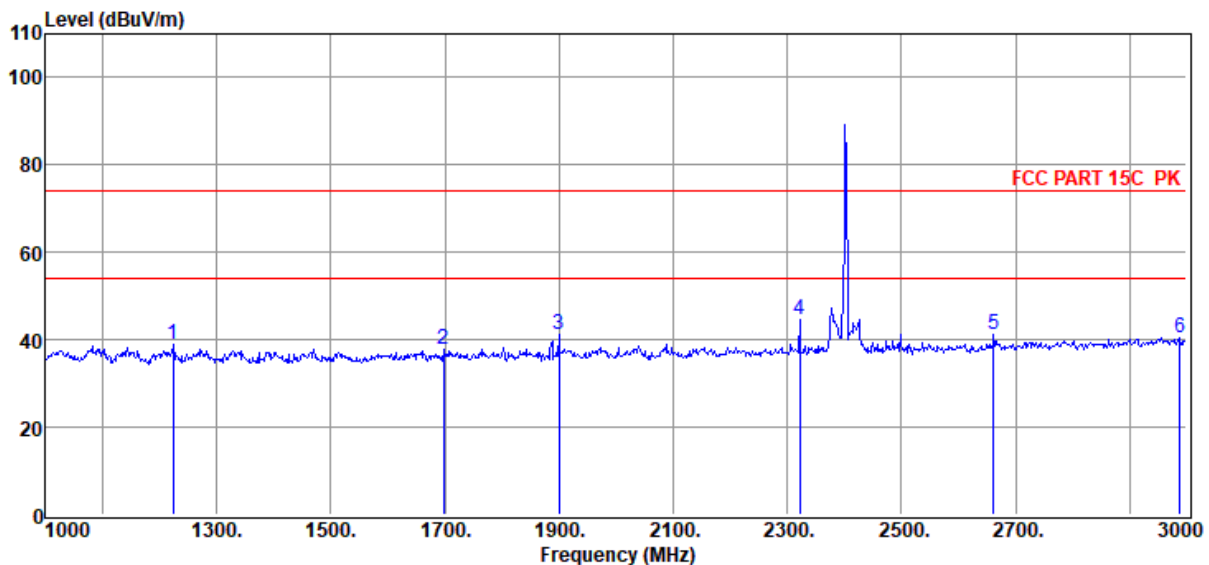

Item (Mark)	Freq. (MHz)	Read Level (dBuV)	Antenna Factor (dB/m)	PRM Factor dB	Cable Loss dB	Filter Factor dB	Result Level (dBuV/m)	Limit Line (dBuV/m)	Over Limit (dB)	Detector	Polarization
1	1224.00	49.79	25.46	38.24	1.23	0.54	38.78	74.00	-35.22	Peak	HORIZONTAL
2	1698.00	48.57	25.91	38.95	1.47	0.63	37.63	74.00	-36.37	Peak	HORIZONTAL
3	1900.00	51.68	26.44	39.25	1.56	0.66	41.09	74.00	-32.91	Peak	HORIZONTAL
4	2322.00	54.56	27.28	39.56	1.69	0.72	44.69	74.00	-29.31	Peak	HORIZONTAL
5	2662.00	50.00	28.22	39.73	1.78	0.75	41.02	74.00	-32.98	Peak	HORIZONTAL
6	2988.00	48.08	29.45	39.89	1.87	0.79	40.30	74.00	-33.70	Peak	HORIZONTAL

Note: 1. Result Level = Read Level + Antenna Factor + Cable loss + Filter Factor - PRM Factor.

2. If Peak Result complies with AV limit, AV Result is deemed to comply with AV limit.

3. Test setup: RBW: 1 MHz, VBW: 3 MHz, Sweep time: auto.

TR-4-E-009 Radiated Emission Test Result

Test Site : DDT 3m Chamber 3#

D:\E3 6.111\2022 Report Data\Q22031115-2E aGO
MINI\NEW\FCC ABOVE 1G .EM6

Test Date : 2022-05-23

Tested By : Kennys Zhang

EUT : Wireless Speaker

Model Number : aGO MINI

Power Supply : Battery

Test Mode : Tx Mode

Condition : Temp:22.8°C,Humi:53%,Press:100.1kPa

Antenna/Distance : 2021 BBHA 9120D 3#/3m/VERTICAL

Memo : 2402

Data: 2

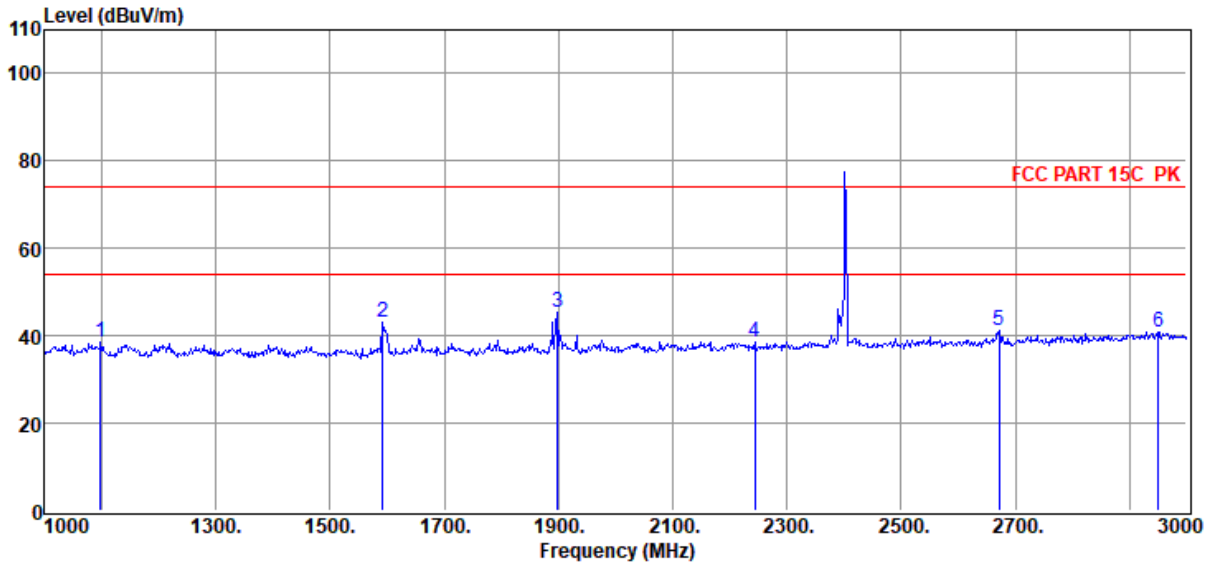

Item (Mark)	Freq. (MHz)	Read Level (dBμV)	Antenna Factor (dB/m)	PRM Factor (dB)	Cable Loss (dB)	Filter Factor (dB)	Result Level (dBμV/m)	Limit Line (dBμV/m)	Over Limit (dB)	Detector	Polarization
1	1098.00	49.34	25.48	38.05	1.15	0.52	38.44	74.00	-35.56	Peak	VERTICAL
2	1592.00	54.35	25.64	38.79	1.42	0.61	43.23	74.00	-30.77	Peak	VERTICAL
3	1898.00	55.77	26.43	39.25	1.56	0.66	45.17	74.00	-28.83	Peak	VERTICAL
4	2244.00	48.74	27.14	39.52	1.67	0.71	38.74	74.00	-35.26	Peak	VERTICAL
5	2672.00	50.10	28.25	39.74	1.78	0.75	41.14	74.00	-32.86	Peak	VERTICAL
6	2950.00	48.76	29.31	39.88	1.86	0.78	40.83	74.00	-33.17	Peak	VERTICAL

- Note: 1. Result Level = Read Level + Antenna Factor + Cable loss + Filter Factor - PRM Factor.
 2. If Peak Result complies with AV limit, AV Result is deemed to comply with AV limit.
 3. Test setup: RBW: 1 MHz, VBW: 3 MHz, Sweep time: auto.

TR-4-E-009 Radiated Emission Test Result

Test Site : DDT 3m Chamber 3#

D:\E3 6.111\2022 Report Data\Q22031115-2E aGO
MINI\NEW\FCC ABOVE 1G .EM6

Test Date : 2022-05-23

Tested By : Kennys Zhang

EUT : Wireless Speaker

Model Number : aGO MINI

Power Supply : Battery

Test Mode : Tx Mode

Condition : Temp:22.8°C,Humi:53%,Press:100.1kPa

Antenna/Distance : 2021 BBHA 9120D
3#/3m/HORIZONTAL

Memo : 2441

Data: 3

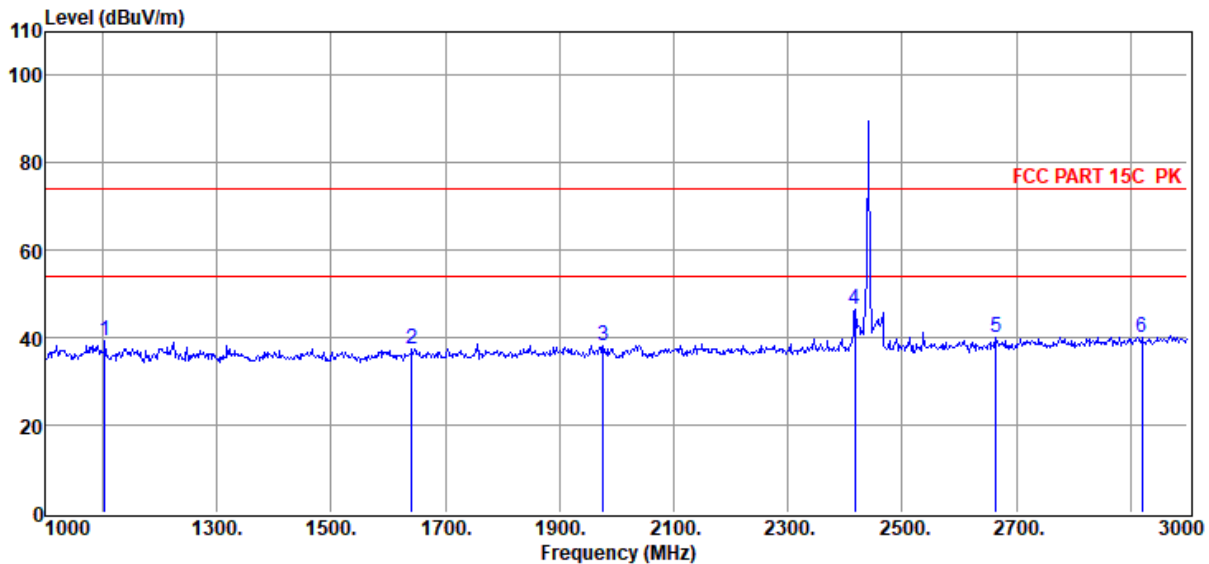

Item (Mark)	Freq. (MHz)	Read Level (dBuV)	Antenna Factor (dB/m)	PRM Factor dB	Cable Loss dB	Filter Factor dB	Result Level (dBuV/m)	Limit Line (dBuV/m)	Over Limit (dB)	Detector	Polarization
1	1104.00	50.04	25.48	38.06	1.16	0.52	39.14	74.00	-34.86	Peak	HORIZONTAL
2	1642.00	48.46	25.77	38.86	1.44	0.62	37.43	74.00	-36.57	Peak	HORIZONTAL
3	1976.00	48.57	26.64	39.36	1.59	0.68	38.12	74.00	-35.88	Peak	HORIZONTAL
4	2418.00	56.20	27.45	39.61	1.72	0.73	46.49	74.00	-27.51	Peak	HORIZONTAL
5	2664.00	49.01	28.22	39.73	1.78	0.75	40.03	74.00	-33.97	Peak	HORIZONTAL
6	2920.00	48.27	29.20	39.86	1.85	0.78	40.24	74.00	-33.76	Peak	HORIZONTAL

Note: 1. Result Level = Read Level + Antenna Factor + Cable loss + Filter Factor - PRM Factor.

2. If Peak Result complies with AV limit, AV Result is deemed to comply with AV limit.

3. Test setup: RBW: 1 MHz, VBW: 3 MHz, Sweep time: auto.

TR-4-E-009 Radiated Emission Test Result

Test Site : DDT 3m Chamber 3#

D:\E3 6.111\2022 Report Data\Q22031115-2E aGO
MINI\NEW\FCC ABOVE 1G .EM6

Test Date : 2022-05-23

Tested By : Kennys Zhang

EUT : Wireless Speaker

Model Number : aGO MINI

Power Supply : Battery

Test Mode : Tx Mode

Condition : Temp:22.8°C,Humi:53%,Press:100.1kPa

Antenna/Distance : 2021 BBHA 9120D 3#/3m/VERTICAL

Memo : 2441

Data: 4

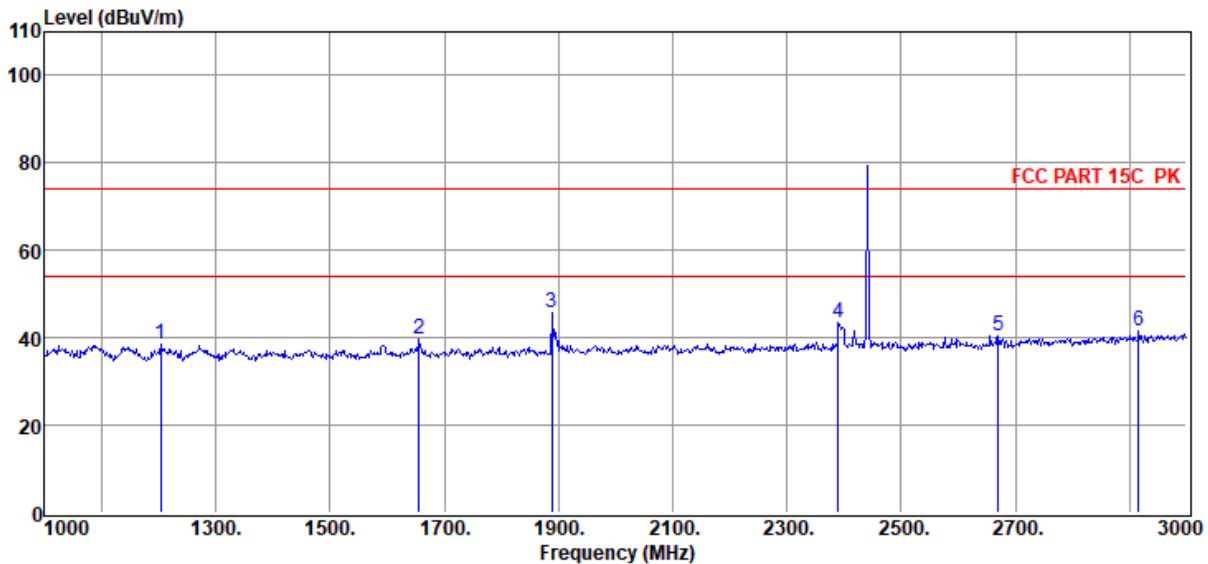

Item (Mark)	Freq. (MHz)	Read Level (dBuV)	Antenna Factor (dB/m)	PRM Factor dB	Cable Loss dB	Filter Factor dB	Result Level (dBuV/m)	Limit Line (dBuV/m)	Over Limit (dB)	Detector	Polarization
1	1204.00	49.43	25.46	38.21	1.21	0.54	38.43	74.00	-35.57	Peak	VERTICAL
2	1656.00	50.81	25.81	38.88	1.45	0.62	39.81	74.00	-34.19	Peak	VERTICAL
3	1888.00	56.46	26.41	39.23	1.55	0.66	45.85	74.00	-28.15	Peak	VERTICAL
4	2390.00	53.39	27.40	39.60	1.71	0.72	43.62	74.00	-30.38	Peak	VERTICAL
5	2670.00	49.23	28.25	39.74	1.78	0.75	40.27	74.00	-33.73	Peak	VERTICAL
6	2916.00	49.47	29.18	39.86	1.85	0.78	41.42	74.00	-32.58	Peak	VERTICAL

Note: 1. Result Level = Read Level + Antenna Factor + Cable loss + Filter Factor - PRM Factor.

2. If Peak Result complies with AV limit, AV Result is deemed to comply with AV limit.

3. Test setup: RBW: 1 MHz, VBW: 3 MHz, Sweep time: auto.

TR-4-E-009 Radiated Emission Test Result

Test Site : DDT 3m Chamber 3#

D:\E3 6.111\2022 Report Data\Q22031115-2E aGO
MINI\NEW\FCC ABOVE 1G .EM6

Test Date : 2022-05-23

Tested By : Kennys Zhang

EUT : Wireless Speaker

Model Number : aGO MINI

Power Supply : Battery

Test Mode : Tx Mode

Condition : Temp:22.8°C,Humi:53%,Press:100.1kPa

Antenna/Distance : 2021 BBHA 9120D
3#/3m/HORIZONTAL

Memo : 2480

Data: 5

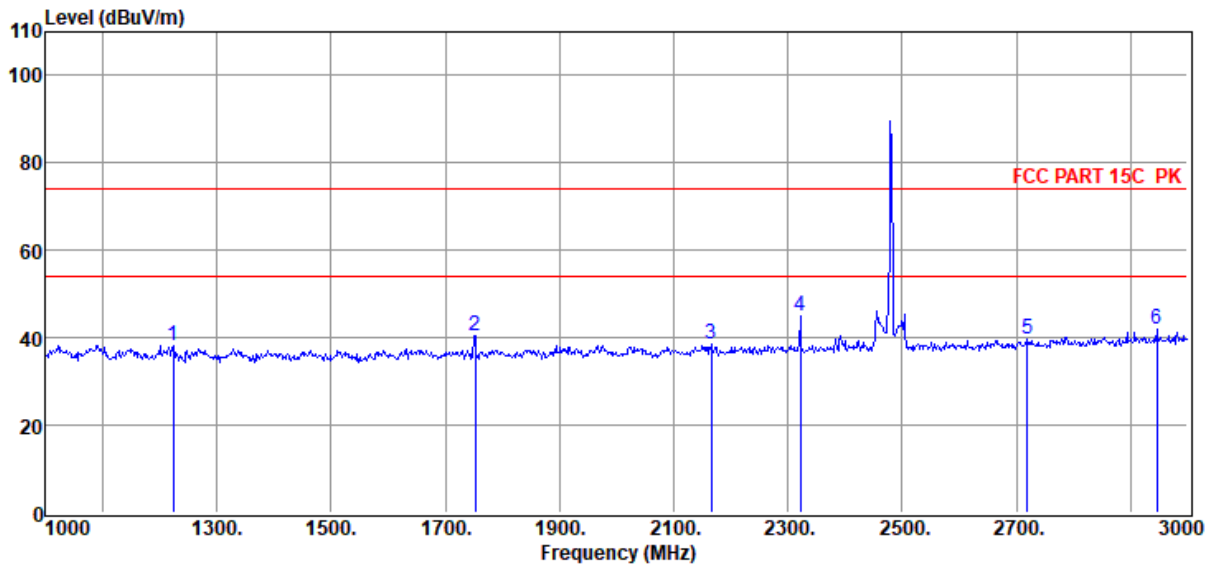

Item (Mark)	Freq. (MHz)	Read Level (dBμV)	Antenna Factor (dB/m)	PRM Factor dB	Cable Loss dB	Filter Factor dB	Result Level (dBμV/m)	Limit Line (dBμV/m)	Over Limit (dB)	Detector	Polarization
1	1224.00	49.03	25.46	38.24	1.23	0.54	38.02	74.00	-35.98	Peak	HORIZONTAL
2	1752.00	51.36	26.06	39.03	1.49	0.64	40.52	74.00	-33.48	Peak	HORIZONTAL
3	2166.00	48.68	27.00	39.48	1.65	0.70	38.55	74.00	-35.45	Peak	HORIZONTAL
4	2322.00	54.73	27.28	39.56	1.69	0.72	44.86	74.00	-29.14	Peak	HORIZONTAL
5	2720.00	48.36	28.44	39.76	1.80	0.76	39.60	74.00	-34.40	Peak	HORIZONTAL
6	2946.00	49.76	29.29	39.87	1.86	0.78	41.82	74.00	-32.18	Peak	HORIZONTAL

Note: 1. Result Level = Read Level + Antenna Factor + Cable loss + Filter Factor - PRM Factor.

2. If Peak Result complies with AV limit, AV Result is deemed to comply with AV limit.

3. Test setup: RBW: 1 MHz, VBW: 3 MHz, Sweep time: auto.

TR-4-E-009 Radiated Emission Test Result

Test Site : DDT 3m Chamber 3#

D:\E3 6.111\2022 Report Data\Q22031115-2E aGO
MINI\NEW\FCC ABOVE 1G .EM6

Test Date : 2022-05-23

Tested By : Kennys Zhang

EUT : Wireless Speaker

Model Number : aGO MINI

Power Supply : Battery

Test Mode : Tx Mode

Condition : Temp:22.8°C,Humi:53%,Press:100.1kPa

Antenna/Distance : 2021 BBHA 9120D 3#/3m/VERTICAL

Memo : 2480

Data: 6

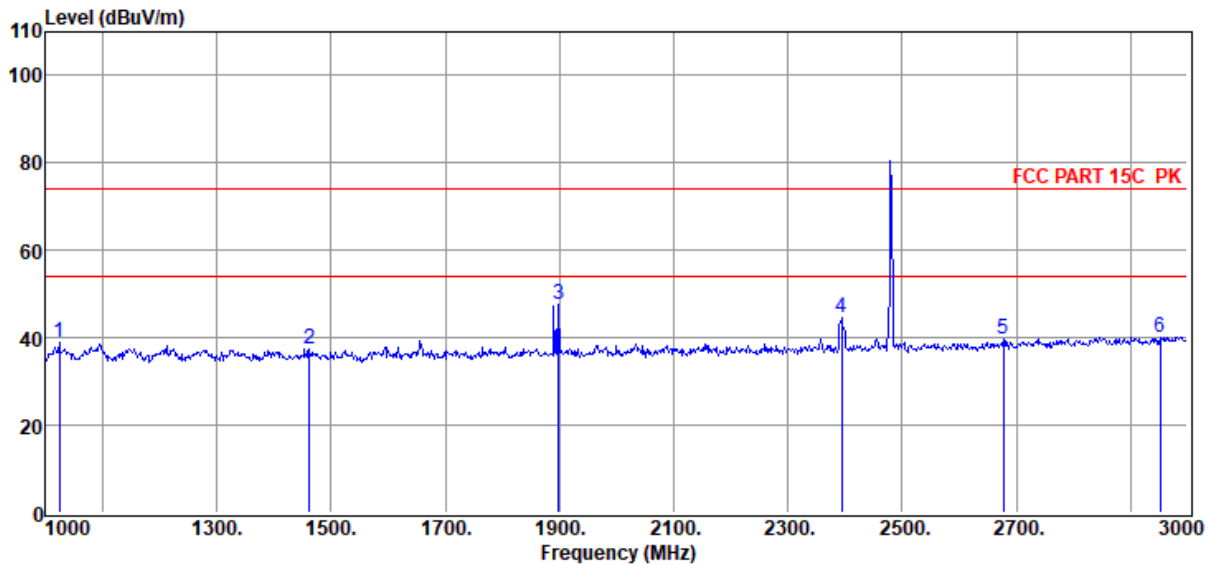

Item (Mark)	Freq. (MHz)	Read Level (dB μ V)	Antenna Factor (dB/m)	PRM Factor dB	Cable Loss dB	Filter Factor dB	Result Level (dB μ V/m)	Limit Line (dB μ V/m)	Over Limit (dB)	Detector	Polarization
1	1024.00	49.81	25.50	37.94	1.11	0.50	38.98	74.00	-35.02	Peak	VERTICAL
2	1462.00	48.61	25.41	38.59	1.36	0.58	37.37	74.00	-36.63	Peak	VERTICAL
3	1898.00	58.31	26.43	39.25	1.56	0.66	47.71	74.00	-26.29	Peak	VERTICAL
4	2394.00	54.26	27.41	39.60	1.71	0.72	44.50	74.00	-29.50	Peak	VERTICAL
5	2678.00	48.64	28.28	39.74	1.79	0.75	39.72	74.00	-34.28	Peak	VERTICAL
6	2952.00	47.90	29.32	39.88	1.86	0.78	39.98	74.00	-34.02	Peak	VERTICAL

Note: 1. Result Level = Read Level + Antenna Factor + Cable loss + Filter Factor - PRM Factor.

2. If Peak Result complies with AV limit, AV Result is deemed to comply with AV limit.

3. Test setup: RBW: 1 MHz, VBW: 3 MHz, Sweep time: auto.

TR-4-E-009 Radiated Emission Test Result

Test Site : DDT 3m Chamber 3#

D:\E3 6.111\2022 Report Data\Q22031115-2E aGO
MINI\NEW\FCC ABOVE 1G .EM6

Test Date : 2022-05-23

Tested By : Kennys Zhang

EUT : Wireless Speaker

Model Number : aGO MINI

Power Supply : Battery

Test Mode : Tx Mode

Condition : Temp:22.8°C,Humi:53%,Press:100.1kPa

Antenna/Distance : 2021 BBHA 9120D
3#/3m/HORIZONTAL

Memo : 2402

Data: 19

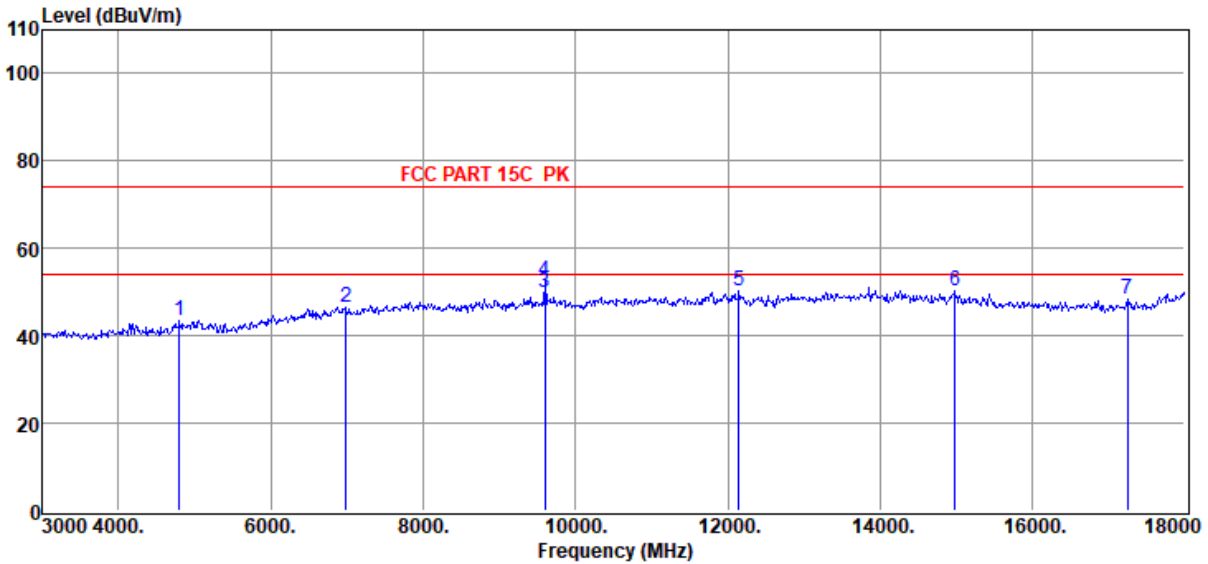

Item (Mark)	Freq. (MHz)	Read Level (dBμV)	Antenna Factor (dB/m)	PRM Factor dB	Cable Loss dB	Filter Factor dB	Result Level (dBμV/m)	Limit Line (dBμV/m)	Over Limit (dB)	Detector	Polarization
1	4800.00	47.98	32.46	40.36	2.47	0.90	43.45	74.00	-30.55	Peak	HORIZONTAL
2	6990.00	46.30	35.98	39.71	3.03	0.93	46.53	74.00	-27.47	Peak	HORIZONTAL
3	9600.00	46.84	38.64	40.32	3.63	1.29	50.08	54.00	-3.92	Average	HORIZONTAL
4	9600.00	49.38	38.64	40.32	3.63	1.29	52.62	74.00	-21.38	Peak	HORIZONTAL
5	12150.00	45.91	39.14	40.15	3.95	1.27	50.12	74.00	-23.88	Peak	HORIZONTAL
6	14985.00	44.56	39.51	39.60	4.47	1.44	50.38	74.00	-23.62	Peak	HORIZONTAL
7	17250.00	43.18	38.95	40.25	4.77	1.71	48.36	74.00	-25.64	Peak	HORIZONTAL

- Note: 1. Result Level = Read Level + Antenna Factor + Cable loss + Filter Factor - PRM Factor.
 2. If Peak Result complies with AV limit, AV Result is deemed to comply with AV limit.
 3. Test setup: RBW: 1 MHz, VBW: 3 MHz, Sweep time: auto.

TR-4-E-009 Radiated Emission Test Result

Test Site : DDT 3m Chamber 3#

D:\E3 6.111\2022 Report Data\Q22031115-2E aGO
MINI\NEW\FCC ABOVE 1G .EM6

Test Date : 2022-05-23

Tested By : Kennys Zhang

EUT : Wireless Speaker

Model Number : aGO MINI

Power Supply : Battery

Test Mode : Tx Mode

Condition : Temp:22.8°C,Humi:53%,Press:100.1kPa

Antenna/Distance : 2021 BBHA 9120D 3#/3m/VERTICAL

Memo : 2402

Data: 20

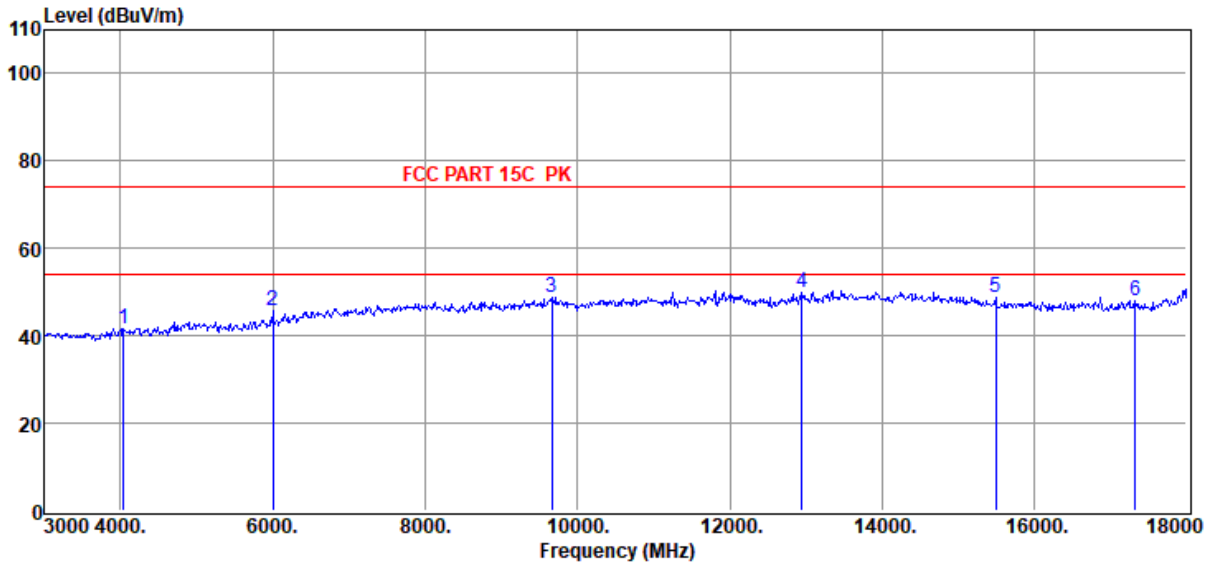

Item (Mark)	Freq. (MHz)	Read Level (dBμV)	Antenna Factor (dB/m)	PRM Factor dB	Cable Loss dB	Filter Factor dB	Result Level (dBμV/m)	Limit Line (dBμV/m)	Over Limit (dB)	Detector	Polarization
1	4035.00	47.83	31.13	40.21	2.13	0.86	41.74	74.00	-32.26	Peak	VERTICAL
2	6000.00	48.21	34.00	40.50	3.03	1.14	45.88	74.00	-28.12	Peak	VERTICAL
3	9660.00	45.76	38.60	40.36	3.64	1.31	48.95	74.00	-25.05	Peak	VERTICAL
4	12945.00	44.97	39.53	40.38	4.32	1.43	49.87	74.00	-24.13	Peak	VERTICAL
5	15495.00	43.49	38.81	39.75	4.56	1.57	48.68	74.00	-25.32	Peak	VERTICAL
6	17325.00	42.88	39.08	40.29	4.78	1.72	48.17	74.00	-25.83	Peak	VERTICAL

- Note: 1. Result Level = Read Level + Antenna Factor + Cable loss + Filter Factor - PRM Factor.
 2. If Peak Result complies with AV limit, AV Result is deemed to comply with AV limit.
 3. Test setup: RBW: 1 MHz, VBW: 3 MHz, Sweep time: auto.

TR-4-E-009 Radiated Emission Test Result

Test Site : DDT 3m Chamber 3#

D:\E3 6.111\2022 Report Data\Q22031115-2E aGO
MINI\NEW\FCC ABOVE 1G .EM6

Test Date : 2022-05-23

Tested By : Kennys Zhang

EUT : Wireless Speaker

Model Number : aGO MINI

Power Supply : Battery

Test Mode : Tx Mode

Condition : Temp:22.8°C,Humi:53%,Press:100.1kPa

Antenna/Distance : 2021 BBHA 9120D
3#/3m/HORIZONTAL

Memo : 2441

Data: 21

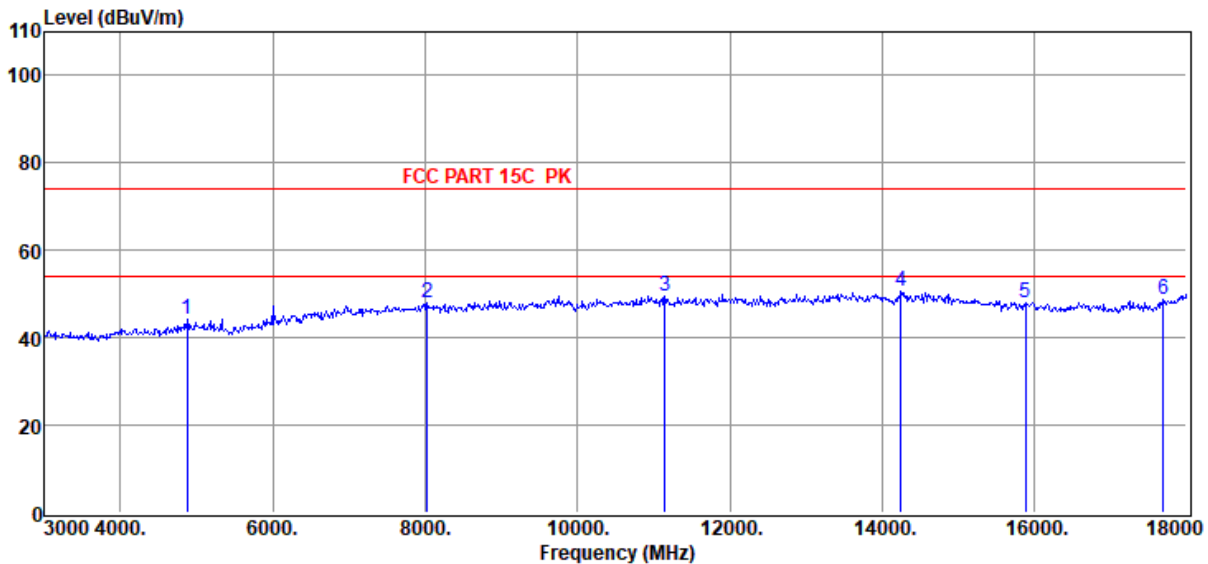

Item (Mark)	Freq. (MHz)	Read Level (dB μ V)	Antenna Factor (dB/m)	PRM Factor dB	Cable Loss dB	Filter Factor dB	Result Level (dB μ V/m)	Limit Line (dB μ V/m)	Over Limit (dB)	Detector	Polarization
1	4875.00	48.64	32.70	40.38	2.49	0.90	44.35	74.00	-29.65	Peak	HORIZONTAL
2	8025.00	46.21	37.04	39.80	3.19	1.18	47.82	74.00	-26.18	Peak	HORIZONTAL
3	11145.00	45.27	39.21	40.19	3.85	1.36	49.50	74.00	-24.50	Peak	HORIZONTAL
4	14250.00	44.47	39.90	39.67	4.44	1.48	50.62	74.00	-23.38	Peak	HORIZONTAL
5	15885.00	43.54	38.11	39.87	4.59	1.68	48.05	74.00	-25.95	Peak	HORIZONTAL
6	17700.00	41.92	40.64	40.52	4.88	1.77	48.69	74.00	-25.31	Peak	HORIZONTAL

Note: 1. Result Level = Read Level + Antenna Factor + Cable loss + Filter Factor - PRM Factor.

2. If Peak Result complies with AV limit, AV Result is deemed to comply with AV limit.

3. Test setup: RBW: 1 MHz, VBW: 3 MHz, Sweep time: auto.

TR-4-E-009 Radiated Emission Test Result

Test Site : DDT 3m Chamber 3#

D:\E3 6.111\2022 Report Data\Q22031115-2E aGO
MINI\NEW\FCC ABOVE 1G .EM6

Test Date : 2022-05-23

Tested By : Kennys Zhang

EUT : Wireless Speaker

Model Number : aGO MINI

Power Supply : Battery

Test Mode : Tx Mode

Condition : Temp:22.8°C,Humi:53%,Press:100.1kPa

Antenna/Distance : 2021 BBHA 9120D 3#/3m/VERTICAL

Memo : 2441

Data: 22

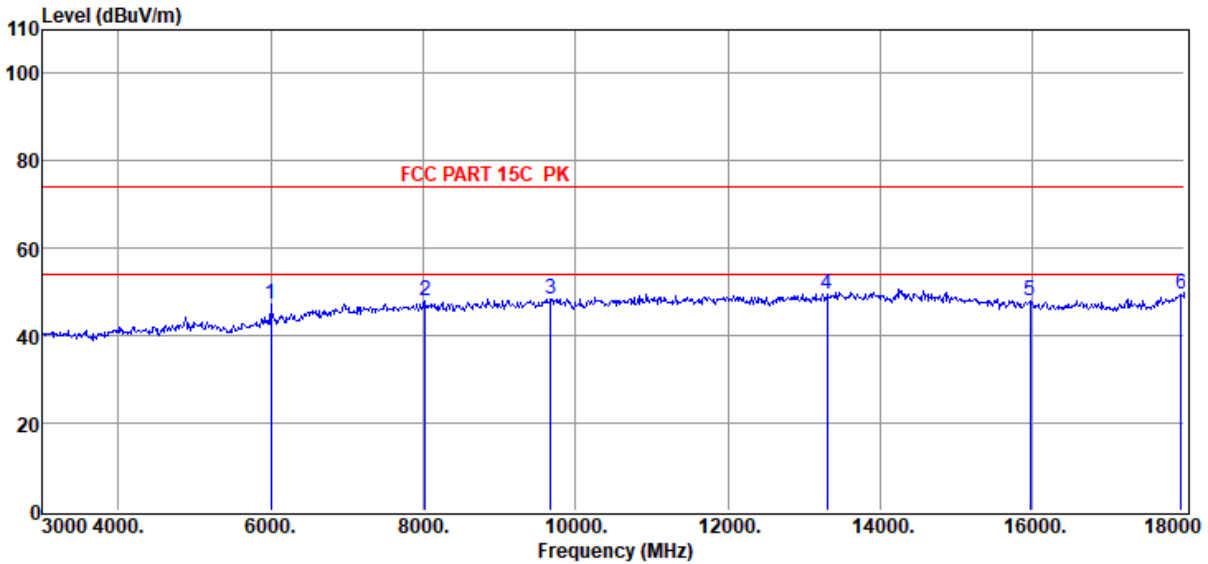

Item (Mark)	Freq. (MHz)	Read Level (dBuV)	Antenna Factor (dB/m)	PRM Factor (dB)	Cable Loss (dB)	Filter Factor (dB)	Result Level (dBuV/m)	Limit Line (dBuV/m)	Over Limit (dB)	Detector	Polarization
1	6000.00	49.47	34.00	40.50	3.03	1.14	47.14	74.00	-26.86	Peak	VERTICAL
2	8025.00	46.21	37.04	39.80	3.19	1.18	47.82	74.00	-26.18	Peak	VERTICAL
3	9675.00	45.33	38.60	40.37	3.64	1.31	48.51	74.00	-25.49	Peak	VERTICAL
4	13305.00	44.43	39.84	40.19	4.15	1.46	49.69	74.00	-24.31	Peak	VERTICAL
5	15975.00	43.50	37.94	39.89	4.60	1.70	47.85	74.00	-26.15	Peak	VERTICAL
6	17955.00	41.12	42.22	40.67	4.95	1.81	49.43	74.00	-24.57	Peak	VERTICAL

- Note: 1. Result Level = Read Level + Antenna Factor + Cable loss + Filter Factor - PRM Factor.
 2. If Peak Result complies with AV limit, AV Result is deemed to comply with AV limit.
 3. Test setup: RBW: 1 MHz, VBW: 3 MHz, Sweep time: auto.

TR-4-E-009 Radiated Emission Test Result

Test Site : DDT 3m Chamber 3#

D:\E3 6.111\2022 Report Data\Q22031115-2E aGO
MINI\NEW\FCC ABOVE 1G .EM6

Test Date : 2022-05-23

Tested By : Kennys Zhang

EUT : Wireless Speaker

Model Number : aGO MINI

Power Supply : Battery

Test Mode : Tx Mode

Condition : Temp:22.8°C,Humi:53%,Press:100.1kPa

Antenna/Distance : 2021 BBHA 9120D
3#/3m/HORIZONTAL

Memo : 2480

Data: 23

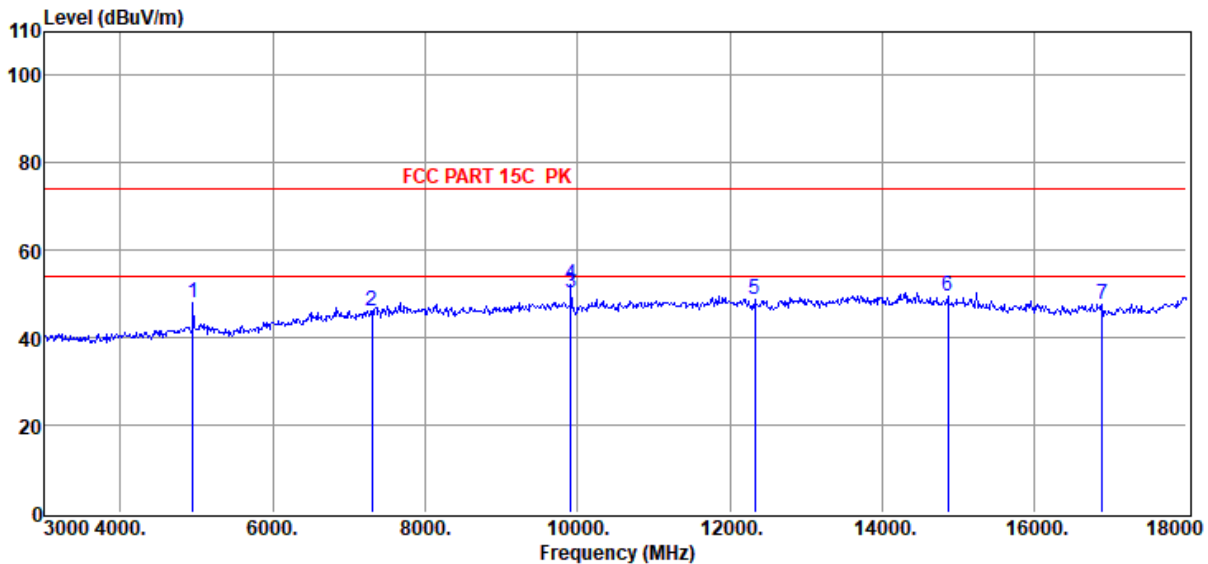

Item (Mark)	Freq. (MHz)	Read Level (dB μ V)	Antenna Factor (dB/m)	PRM Factor dB	Cable Loss dB	Filter Factor dB	Result Level (dB μ V/m)	Limit Line (dB μ V/m)	Over Limit (dB)	Detector	Polarization
1	4950.00	52.12	32.94	40.39	2.52	0.91	48.10	74.00	-25.90	Peak	HORIZONTAL
2	7305.00	45.66	36.24	39.73	3.09	1.01	46.27	74.00	-27.73	Peak	HORIZONTAL
3	9915.00	47.26	38.45	40.54	3.66	1.35	50.18	54.00	-3.82	Average	HORIZONTAL
4	9915.00	49.25	38.45	40.54	3.66	1.35	52.17	74.00	-21.83	Peak	HORIZONTAL
5	12330.00	44.91	39.07	40.20	3.83	1.31	48.92	74.00	-25.08	Peak	HORIZONTAL
6	14865.00	43.76	39.61	39.61	4.44	1.45	49.65	74.00	-24.35	Peak	HORIZONTAL
7	16890.00	43.02	38.37	40.08	4.71	1.67	47.69	74.00	-26.31	Peak	HORIZONTAL

Note: 1. Result Level = Read Level + Antenna Factor + Cable loss + Filter Factor - PRM Factor.

2. If Peak Result complies with AV limit, AV Result is deemed to comply with AV limit.

3. Test setup: RBW: 1 MHz, VBW: 3 MHz, Sweep time: auto.

TR-4-E-009 Radiated Emission Test Result

Test Site : DDT 3m Chamber 3#

D:\E3 6.111\2022 Report Data\Q22031115-2E aGO
MINI\NEW\FCC ABOVE 1G .EM6

Test Date : 2022-05-23

Tested By : Kennys Zhang

EUT : Wireless Speaker

Model Number : aGO MINI

Power Supply : Battery

Test Mode : Tx Mode

Condition : Temp:22.8°C,Humi:53%,Press:100.1kPa

Antenna/Distance : 2021 BBHA 9120D 3#/3m/VERTICAL

Memo : 2480

Data: 24

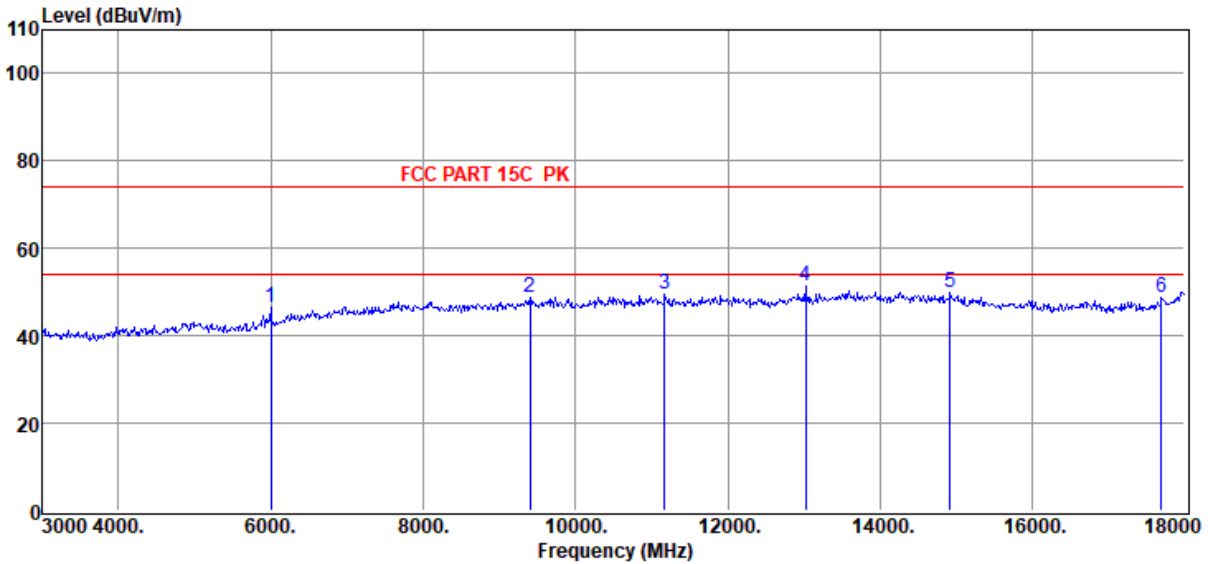

Item (Mark)	Freq. (MHz)	Read Level (dBuV)	Antenna Factor (dB/m)	PRM Factor dB	Cable Loss dB	Filter Factor dB	Result Level (dBuV/m)	Limit Line (dBuV/m)	Over Limit (dB)	Detector	Polarization
1	6000.00	48.92	34.00	40.50	3.03	1.14	46.59	74.00	-27.41	Peak	VERTICAL
2	9405.00	45.34	38.62	40.18	3.56	1.26	48.60	74.00	-25.40	Peak	VERTICAL
3	11175.00	45.12	39.19	40.18	3.86	1.36	49.35	74.00	-24.65	Peak	VERTICAL
4	13020.00	46.33	39.62	40.39	4.38	1.44	51.38	74.00	-22.62	Peak	VERTICAL
5	14925.00	44.11	39.56	39.61	4.45	1.44	49.95	74.00	-24.05	Peak	VERTICAL
6	17700.00	41.81	40.64	40.52	4.88	1.77	48.58	74.00	-25.42	Peak	VERTICAL

- Note: 1. Result Level = Read Level + Antenna Factor + Cable loss + Filter Factor - PRM Factor.
 2. If Peak Result complies with AV limit, AV Result is deemed to comply with AV limit.
 3. Test setup: RBW: 1 MHz, VBW: 3 MHz, Sweep time: auto.

11. RF Conducted Spurious Emissions

11.1. Block diagram of test setup

Same as section 4.1

11.2. Limits

In any 100 kHz bandwidth outside the frequency bands in which the spread spectrum intentional radiator is operating, the radio frequency power that is produced by the intentional radiator shall be at least 20 dB below that in the 100 kHz bandwidth within the band that contains the highest level of the desired power.

11.3. Test procedure

(1) Connect EUT's antenna output to spectrum analyzer by RF cable.

(2) Establish a reference level by using the following procedure:

Center frequency	Test frequency
RBW:	100 kHz
VBW:	300 kHz
Span	Wide enough to capture the peak level of the in-band emission
Detector Mode:	Peak
Sweep time:	auto
Trace mode	Max hold

(3) Allow the trace to stabilize, use the peak marker function to determine the maximum peak power level to establish the reference level.

(4) Set the spectrum analyzer as follows:

RBW:	100 kHz
VBW:	300 kHz
Span	Encompass frequency range to be measured
Number of measurement points	$\geq \text{span}/\text{RBW}$
Detector Mode:	Peak
Sweep time:	auto
Trace mode	Max hold

(5) Allow the trace to stabilize, use the peak marker function to determine the maximum amplitude of all unwanted emissions outside of the authorized frequency band

11.4. Test result

Mode	Freq. (MHz)	Verdict
GFSK	Hopping off 2402	Pass
	Hopping off 2441	Pass
	Hopping off 2480	Pass
$\pi/4$ -DQPSK	Hopping off 2402	Pass
	Hopping off 2441	Pass
	Hopping off 2480	Pass
8DPSK	Hopping off 2402	Pass
	Hopping off 2441	Pass
	Hopping off 2480	Pass

11.5. Original test data

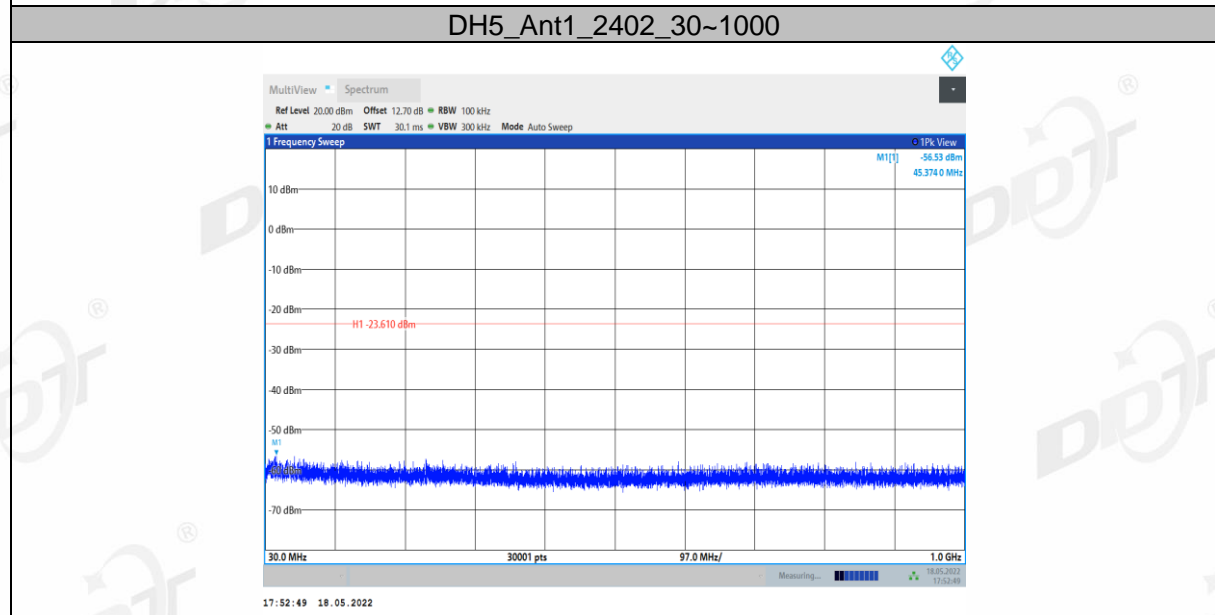
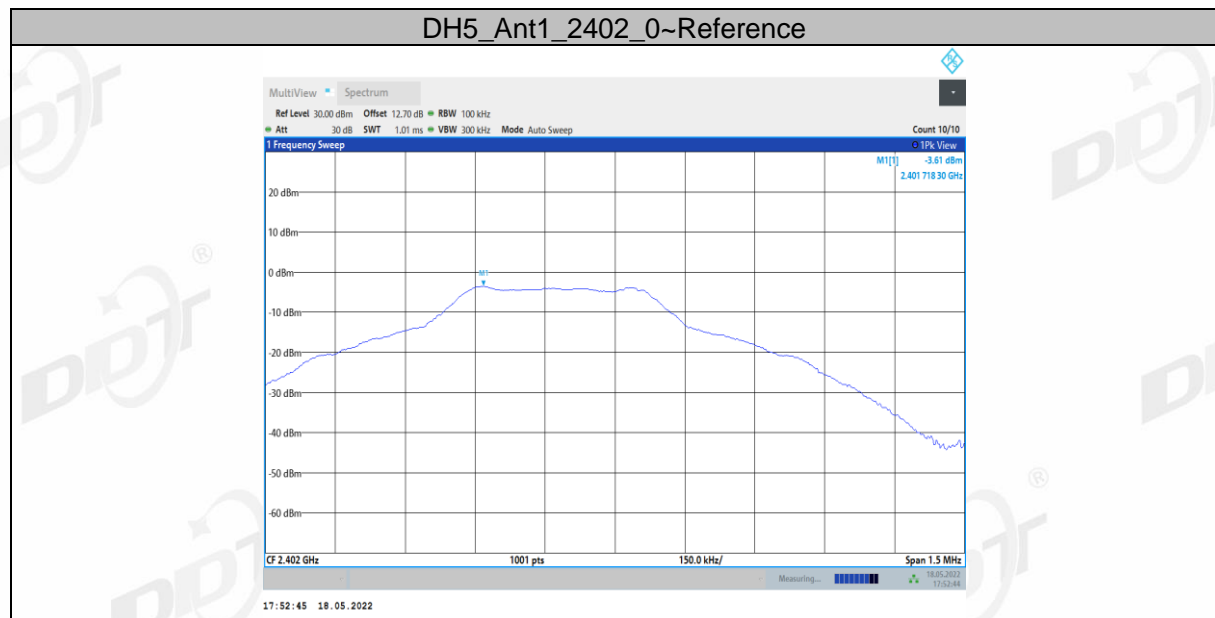

DH5_Ant1_2402_1000~26500

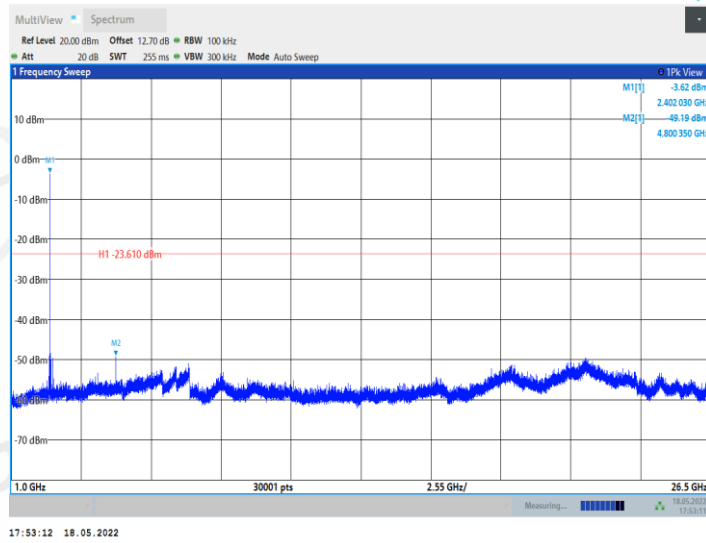

DH5_Ant1_2441_0~Reference

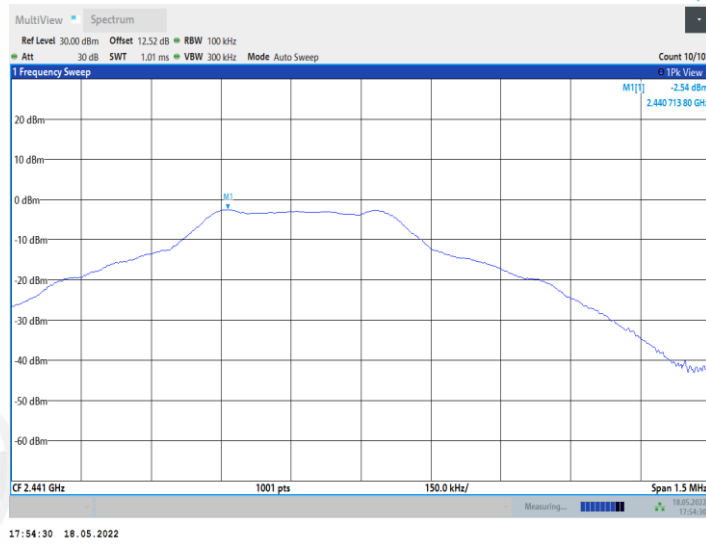

DH5_Ant1_2441_30~1000

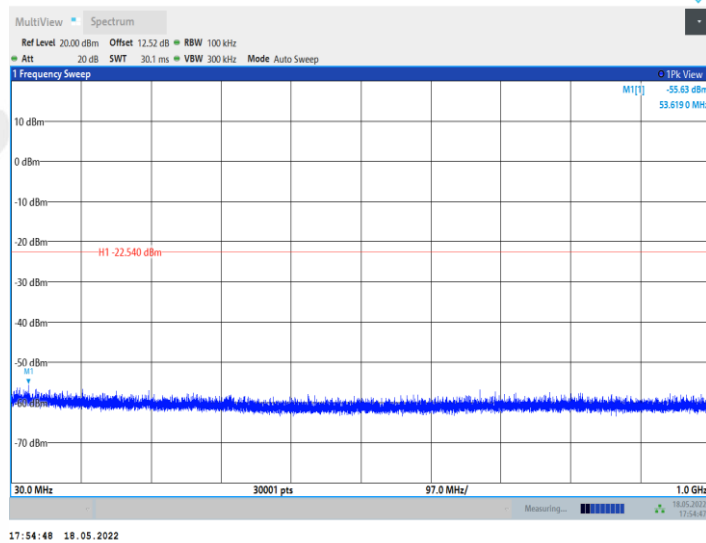

DH5_Ant1_2441_1000~26500

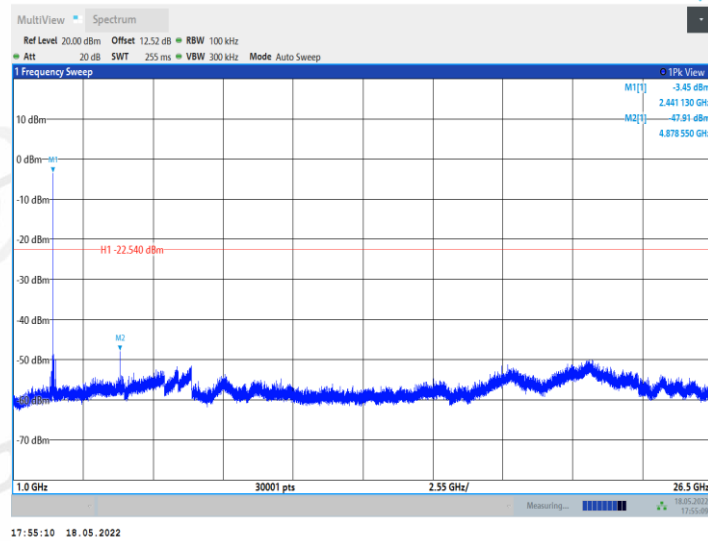

DH5_Ant1_2480_0~Reference

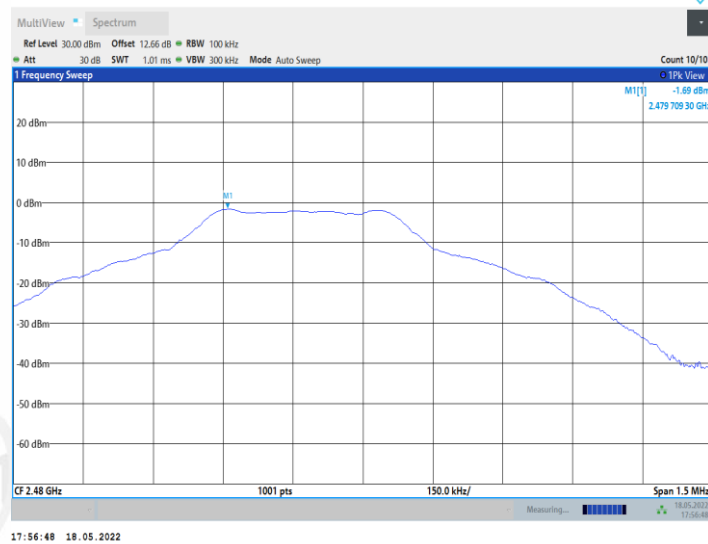

DH5_Ant1_2480_30~1000

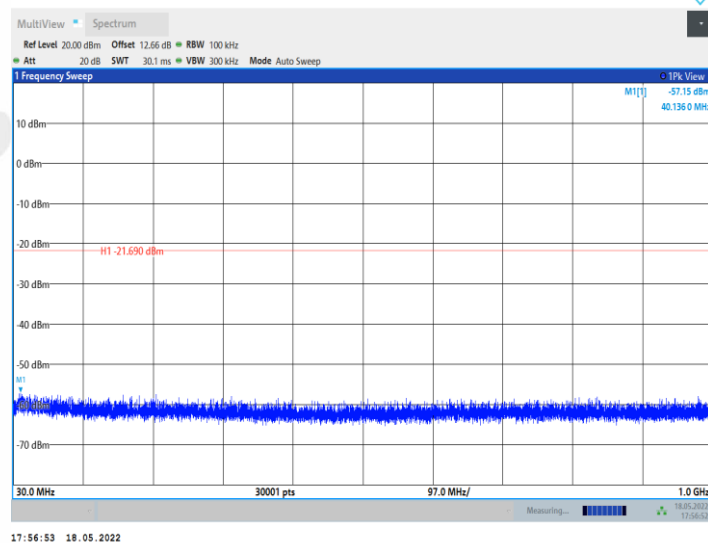

DH5_Ant1_2480_1000~26500

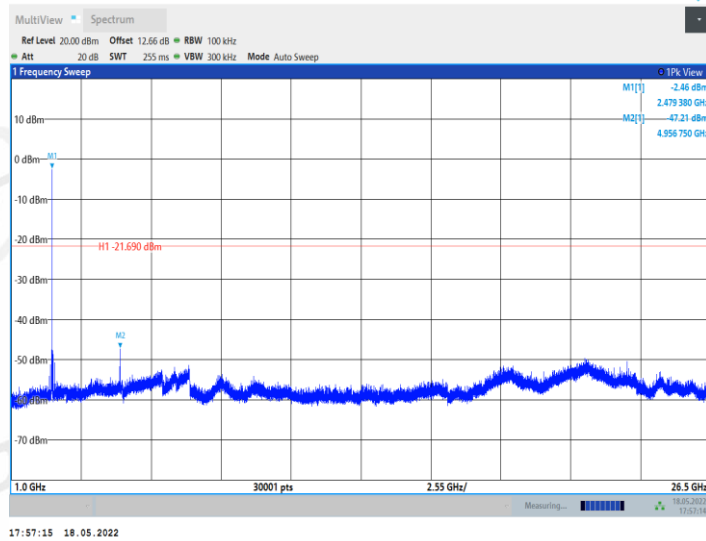

2DH5_Ant1_2402_0~Reference

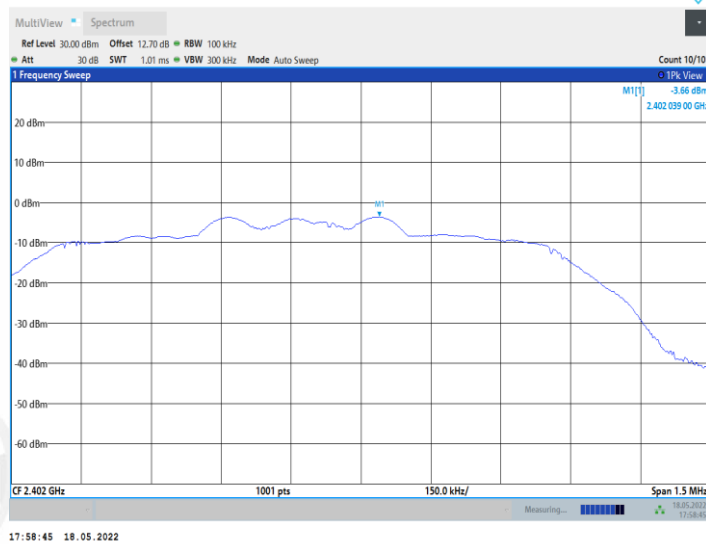

2DH5_Ant1_2402_30~1000

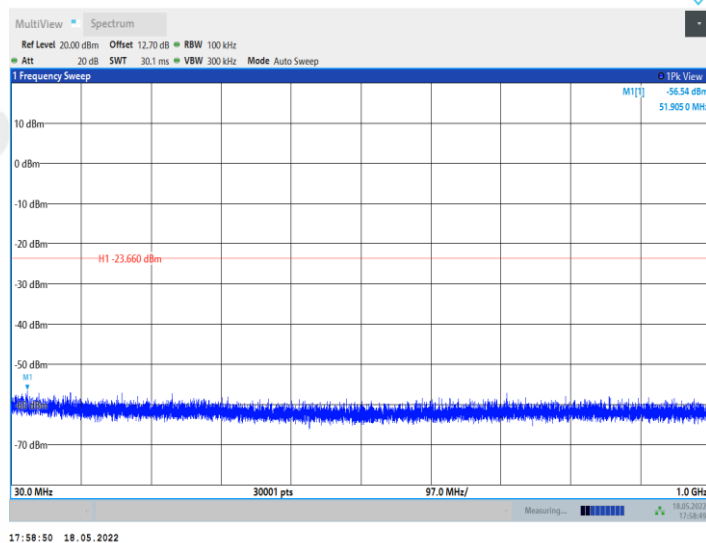

2DH5_Ant1_2402_1000~26500

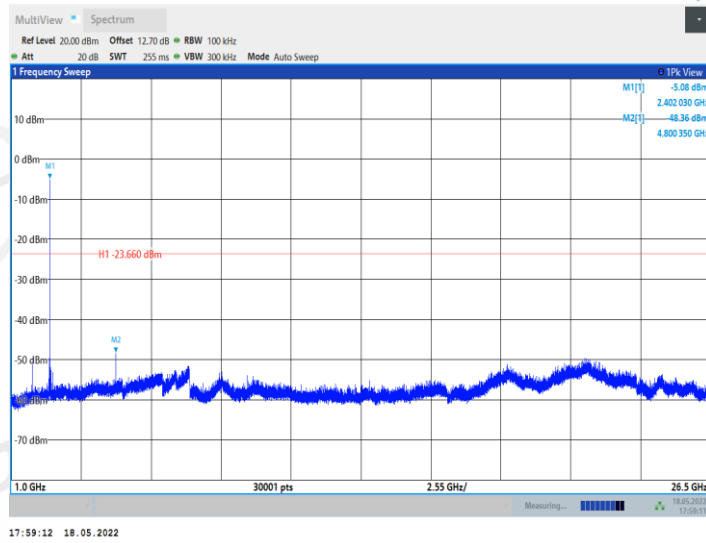

2DH5_Ant1_2441_0~Reference

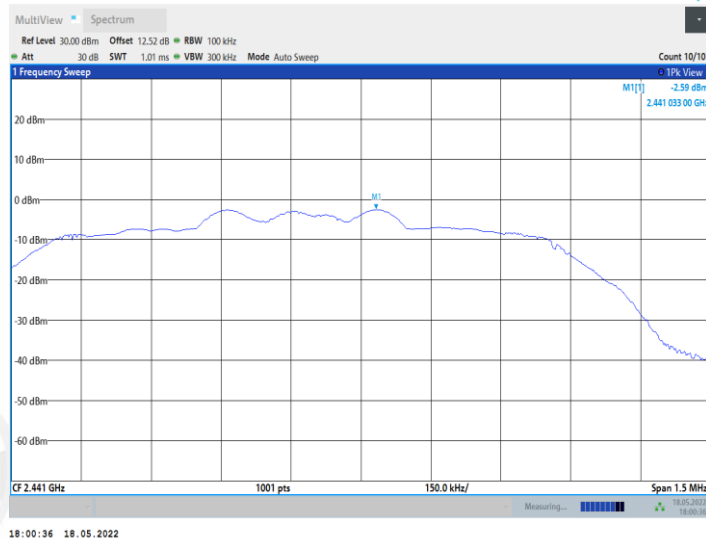

2DH5_Ant1_2441_30~1000

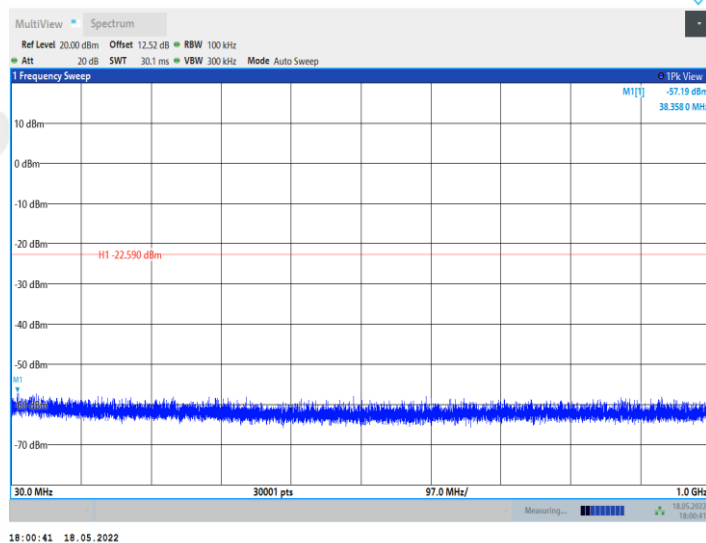

2DH5_Ant1_2441_1000~26500

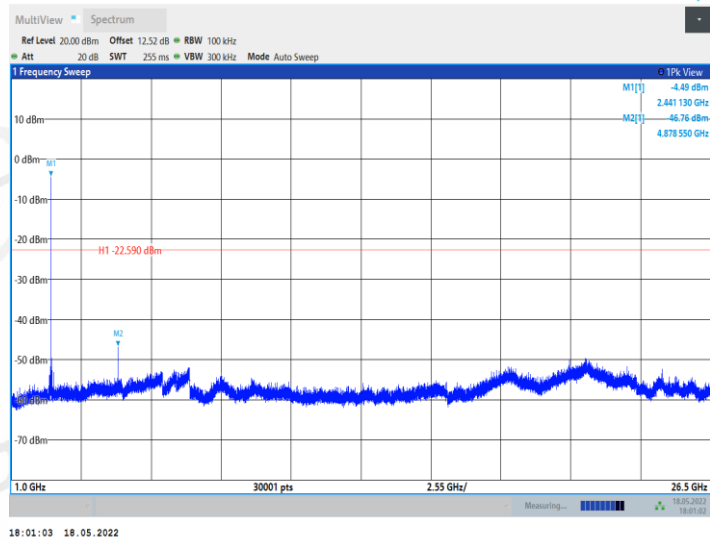

2DH5_Ant1_2480_0~Reference

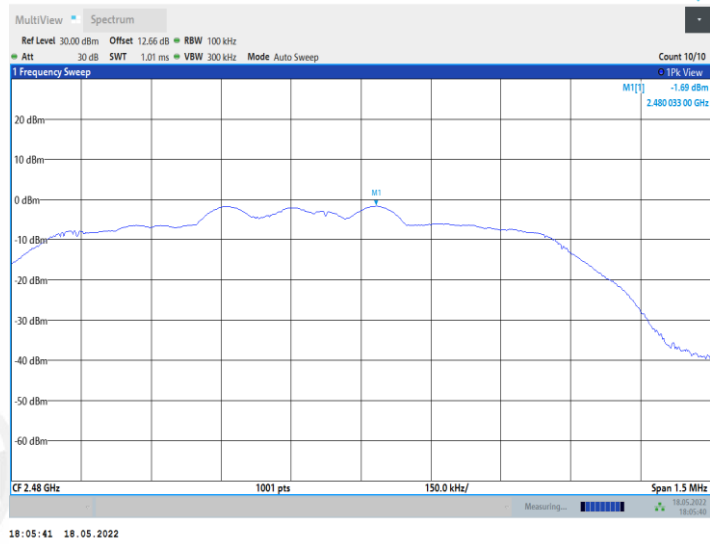

2DH5_Ant1_2480_30~1000

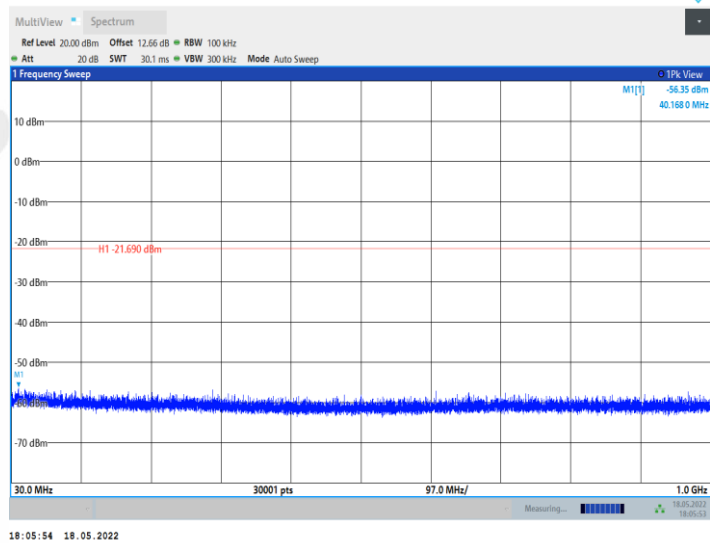

2DH5_Ant1_2480_1000~26500

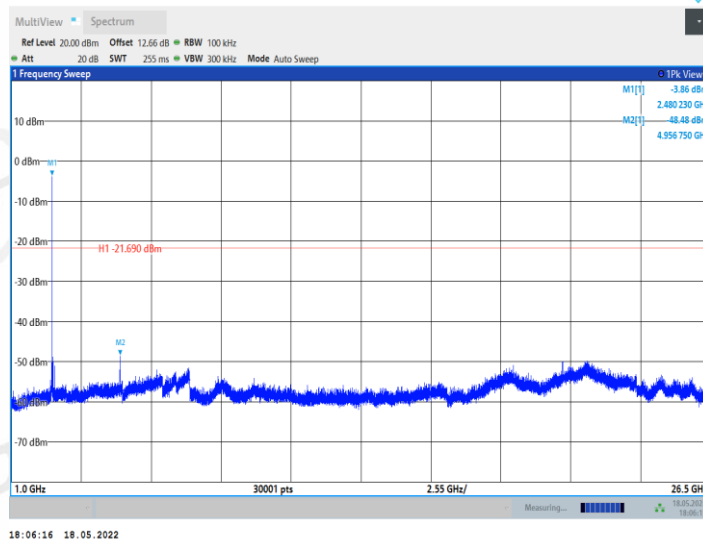

3DH5_Ant1_2402_0~Reference

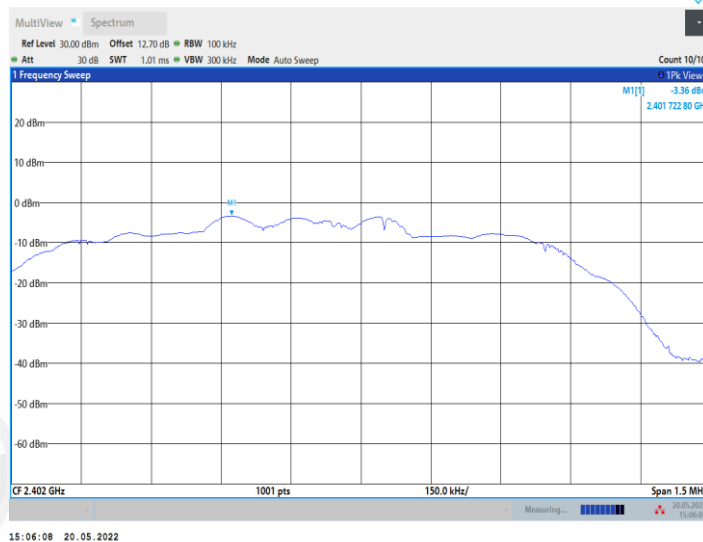

3DH5_Ant1_2402_30~1000

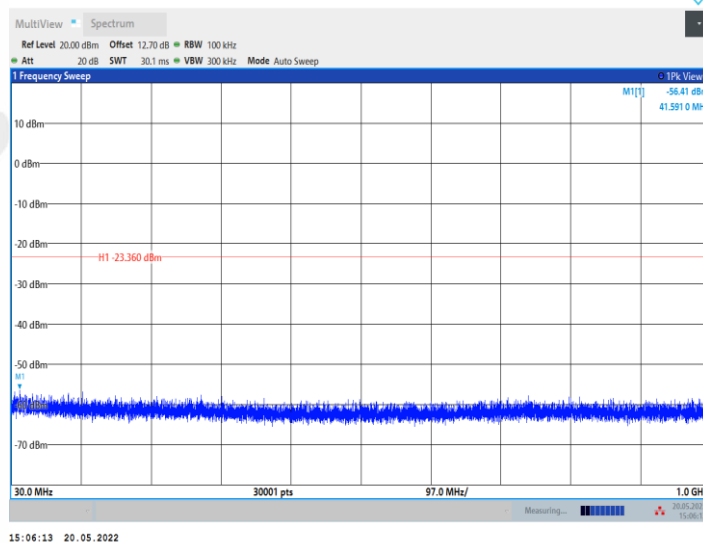

3DH5_Ant1_2402_1000~26500

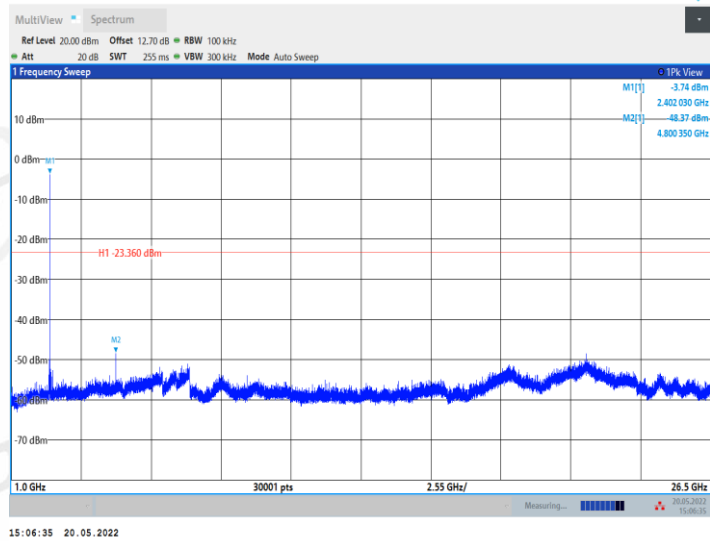

3DH5_Ant1_2441_0~Reference

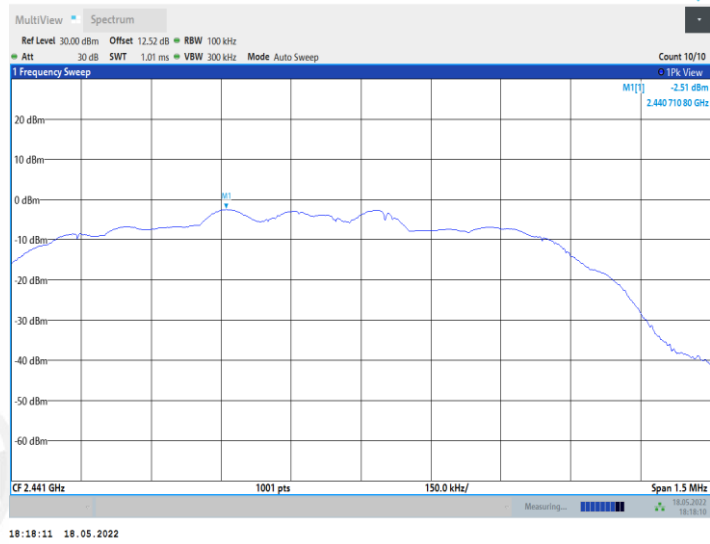

3DH5_Ant1_2441_30~1000

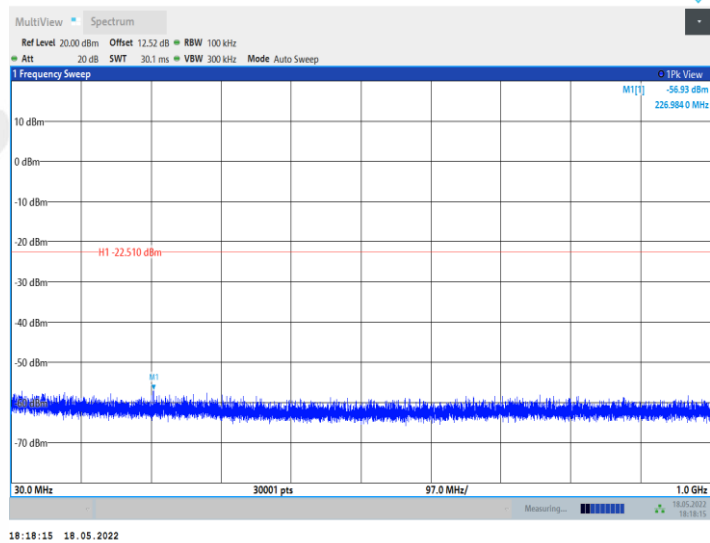

3DH5_Ant1_2441_1000~26500

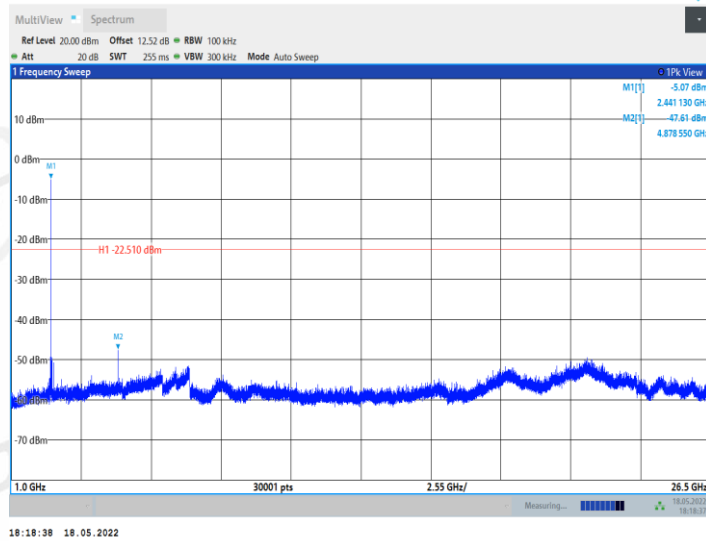

3DH5_Ant1_2480_0~Reference

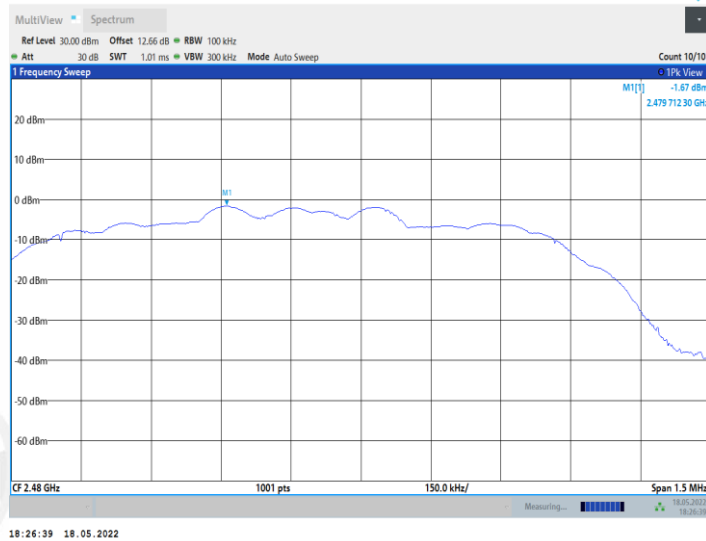

3DH5_Ant1_2480_30~1000

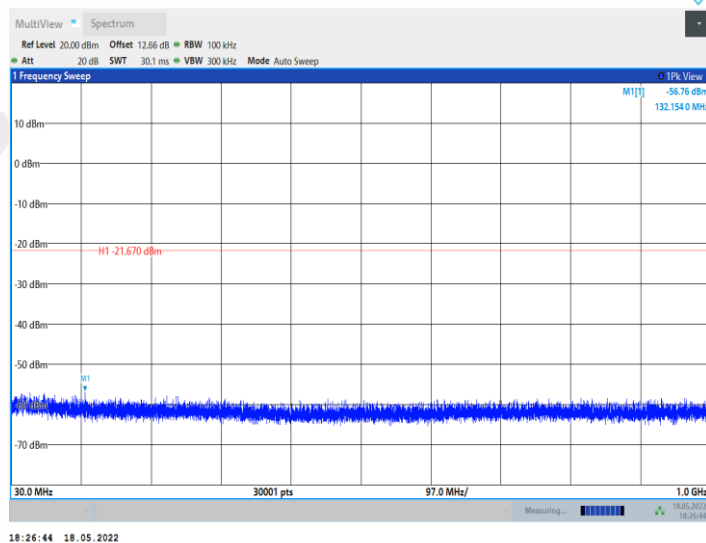

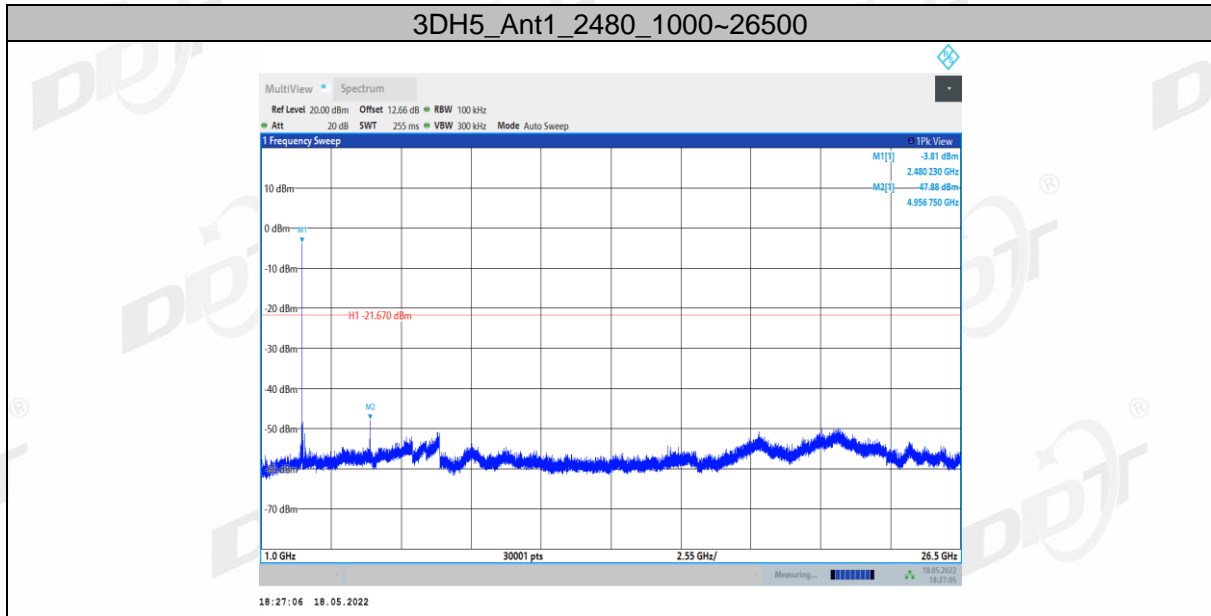

12. Band Edge Compliance (Radiated Method)

12.1. Block diagram of test setup

In 3 m Anechoic Chamber, test setup diagram for frequency above 1 GHz:

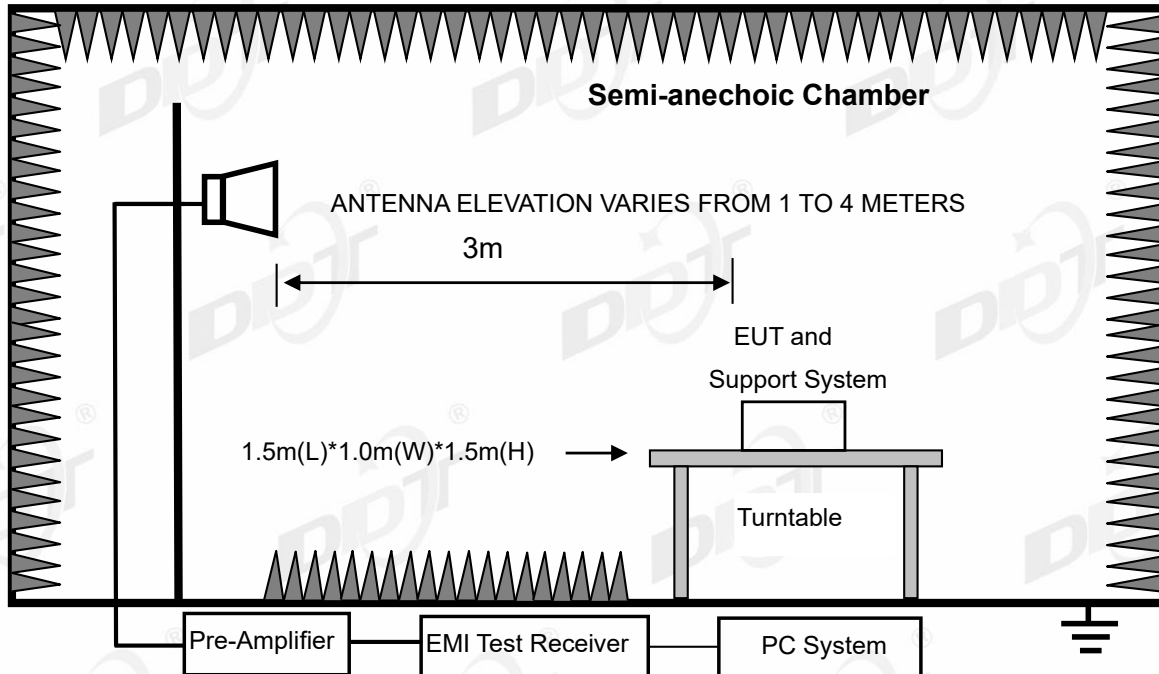

12.2. Limit

All restriction band should comply with 15.209 limits, other emission should be at least 20 dB below the fundamental.

12.3. Test procedure

Same with clause 10.3 except change investigated frequency range from 2310 MHz to 2410 MHz and 2475 MHz to 2500 MHz.

Remark: All restriction band have been tested, and only the worst case is shown in report.

12.4. Test result

Pass. (See below detailed test result)

Remark: hopping on and hopping off mode all have been test, hopping off mode is worse and reported only. Scan with all mode, the worst case is recorded in this report.

TR-4-E-009 Radiated Emission Test Result

Test Site : DDT 3m Chamber 3#

D:\E3 6.111\2022 Report Data\Q22031115-2E aGO
MINI\NEW\FCC ABOVE 1G .EM6

Test Date : 2022-05-23

Tested By : Kennys Zhang

EUT : Wireless Speaker

Model Number : aGO MINI

Power Supply : Battery

Test Mode : Tx Mode

Condition : Temp:22.8°C,Humi:53%,Press:100.1kPa

Antenna/Distance : 2021 BBHA 9120D
3#/3m/HORIZONTAL

Memo : DH5 2402

Data: 7

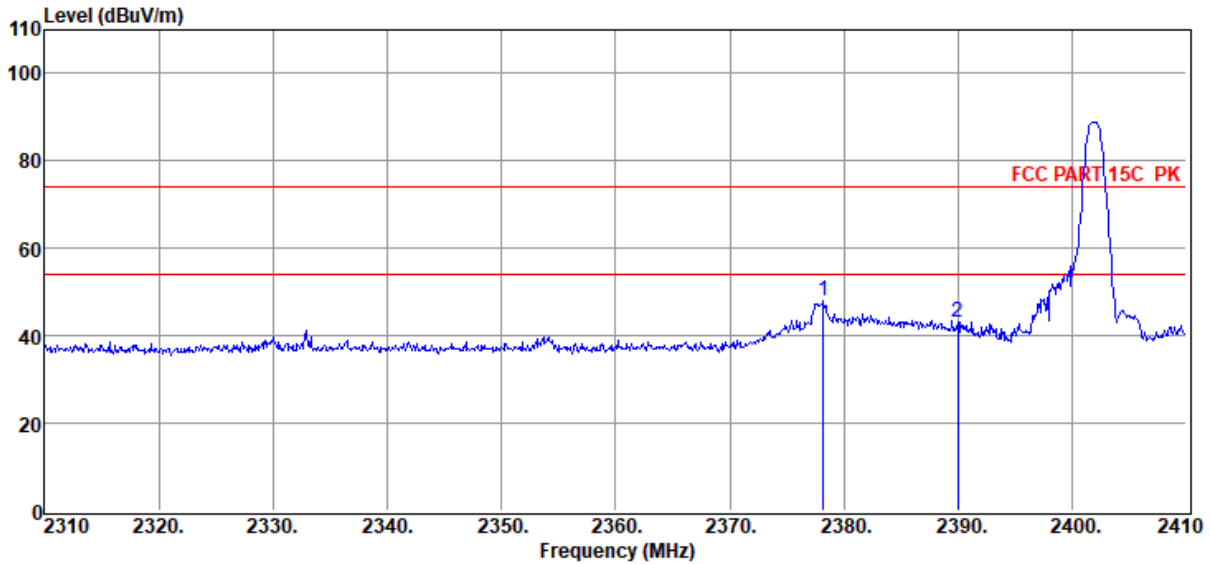

Item (Mark)	Freq. (MHz)	Read Level (dBuV)	Antenna Factor (dB/m)	PRM Factor dB	Cable Loss dB	Filter Factor dB	Result Level (dBuV/m)	Limit Line (dBuV/m)	Over Limit (dB)	Detector	Polarization
1	2378.20	57.64	27.38	39.59	1.71	0.72	47.86	74.00	-26.14	Peak	HORIZONTAL
2	2390.00	52.78	27.40	39.60	1.71	0.72	43.01	74.00	-30.99	Peak	HORIZONTAL

Note: 1. Result Level = Read Level + Antenna Factor + Cable loss + Filter Factor - PRM Factor.

2. If Peak Result complies with AV limit, AV Result is deemed to comply with AV limit.

3. Test setup: RBW: 1 MHz, VBW: 3 MHz, Sweep time: auto.

TR-4-E-009 Radiated Emission Test Result

Test Site : DDT 3m Chamber 3#

D:\E3 6.111\2022 Report Data\Q22031115-2E aGO
MINI\NEW\FCC ABOVE 1G .EM6

Test Date : 2022-05-23

Tested By : Kennys Zhang

EUT : Wireless Speaker

Model Number : aGO MINI

Power Supply : Battery

Test Mode : Tx Mode

Condition : Temp:22.8°C,Humi:53%,Press:100.1kPa

Antenna/Distance : 2021 BBHA 9120D 3#/3m/VERTICAL

Memo : DH5 2402

Data: 8

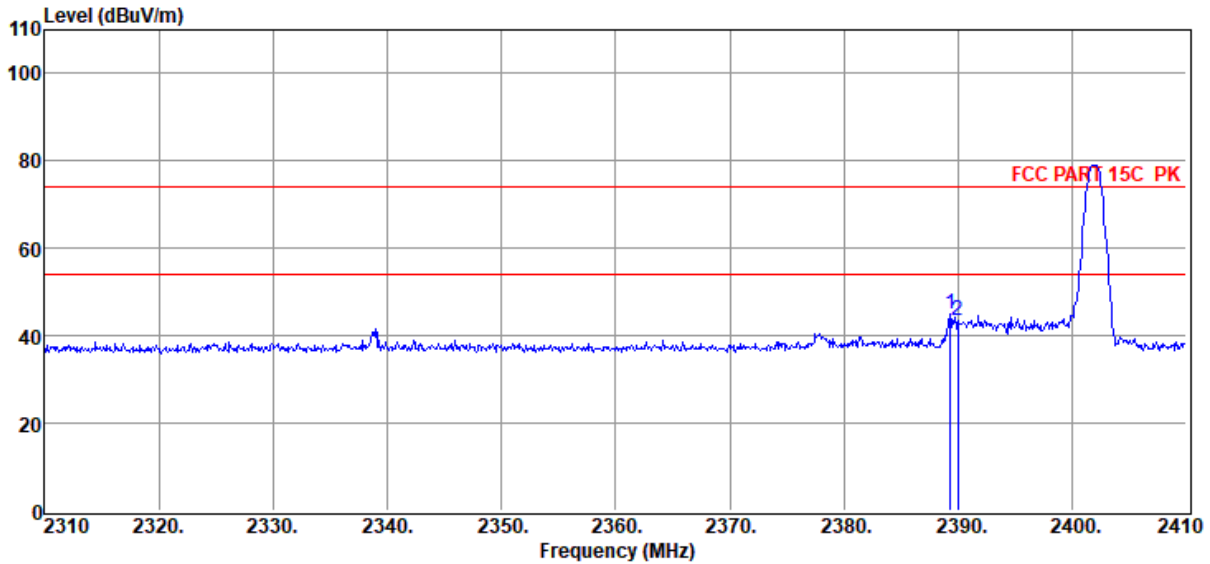

Item (Mark)	Freq. (MHz)	Read Level (dBμV)	Antenna Factor (dB/m)	PRM Factor dB	Cable Loss dB	Filter Factor dB	Result Level (dBμV/m)	Limit Line (dBμV/m)	Over Limit (dB)	Detector	Polarization
1	2389.30	54.62	27.40	39.59	1.71	0.72	44.86	74.00	-29.14	Peak	VERTICAL
2	2390.00	53.16	27.40	39.60	1.71	0.72	43.39	74.00	-30.61	Peak	VERTICAL

Note: 1. Result Level = Read Level + Antenna Factor + Cable loss + Filter Factor - PRM Factor.

2. If Peak Result complies with AV limit, AV Result is deemed to comply with AV limit.

3. Test setup: RBW: 1 MHz, VBW: 3 MHz, Sweep time: auto.

TR-4-E-009 Radiated Emission Test Result

Test Site : DDT 3m Chamber 3#

D:\E3 6.111\2022 Report Data\Q22031115-2E aGO
MINI\NEW\FCC ABOVE 1G .EM6

Test Date : 2022-05-23

Tested By : Kennys Zhang

EUT : Wireless Speaker

Model Number : aGO MINI

Power Supply : Battery

Test Mode : Tx Mode

Condition : Temp:22.8°C,Humi:53%,Press:100.1kPa

Antenna/Distance : 2021 BBHA 9120D
3#/3m/HORIZONTAL

Memo : DH5 2480

Data: 9

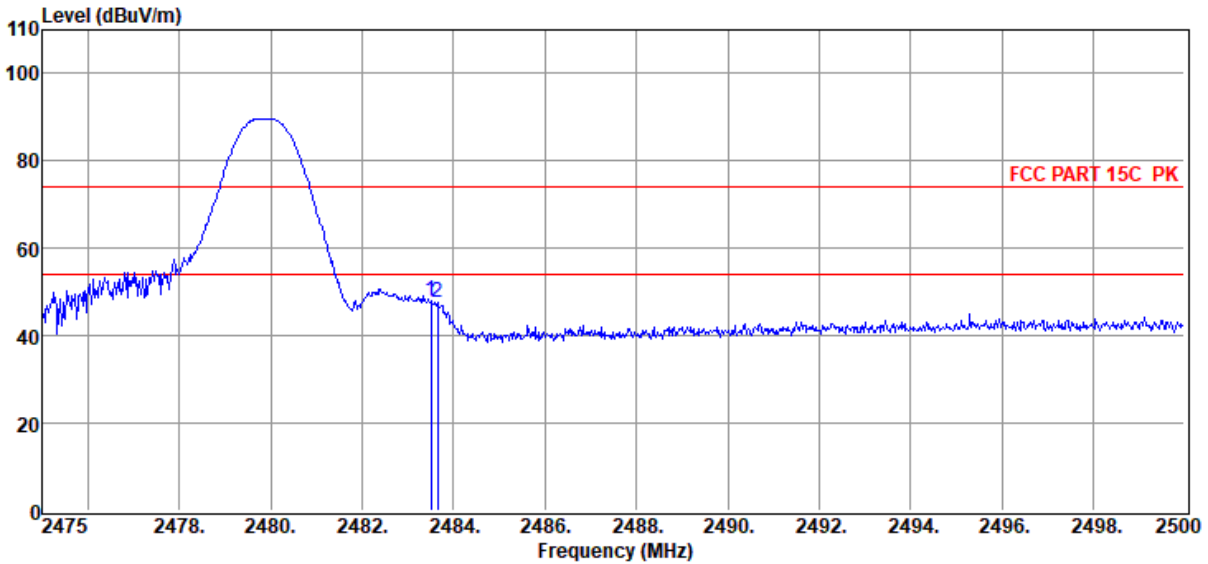

Item (Mark)	Freq. (MHz)	Read Level (dBμV)	Antenna Factor (dB/m)	PRM Factor dB	Cable Loss dB	Filter Factor dB	Result Level (dBμV/m)	Limit Line (dBμV/m)	Over Limit (dB)	Detector	Polarization
1	2483.50	57.49	27.57	39.64	1.74	0.73	47.89	74.00	-26.11	Peak	HORIZONTAL
2	2483.65	57.19	27.57	39.64	1.74	0.73	47.59	74.00	-26.41	Peak	HORIZONTAL

Note: 1. Result Level = Read Level + Antenna Factor + Cable loss + Filter Factor - PRM Factor.

2. If Peak Result complies with AV limit, AV Result is deemed to comply with AV limit.

3. Test setup: RBW: 1 MHz, VBW: 3 MHz, Sweep time: auto.

TR-4-E-009 Radiated Emission Test Result

Test Site : DDT 3m Chamber 3#

D:\E3 6.111\2022 Report Data\Q22031115-2E aGO
MINI\NEW\FCC ABOVE 1G .EM6

Test Date : 2022-05-23

Tested By : Kennys Zhang

EUT : Wireless Speaker

Model Number : aGO MINI

Power Supply : Battery

Test Mode : Tx Mode

Condition : Temp:22.8°C,Humi:53%,Press:100.1kPa

Antenna/Distance : 2021 BBHA 9120D 3#/3m/VERTICAL

Memo : DH5 2480

Data: 10

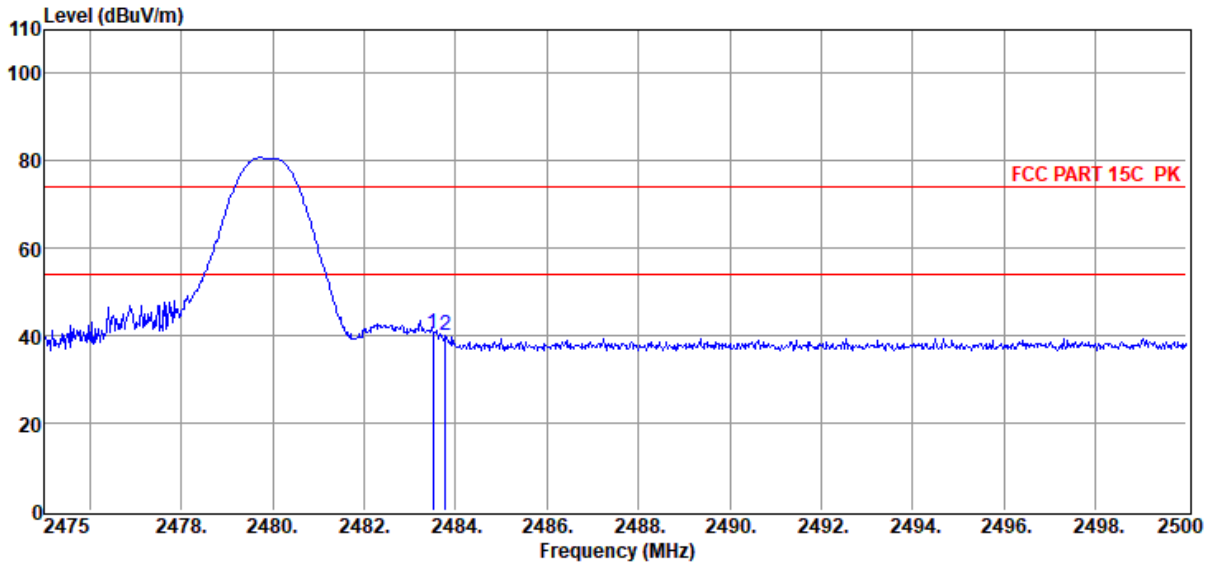

Item (Mark)	Freq. (MHz)	Read Level (dBuV)	Antenna Factor (dB/m)	PRM Factor dB	Cable Loss dB	Filter Factor dB	Result Level (dBuV/m)	Limit Line (dBuV/m)	Over Limit (dB)	Detector	Polarization
1	2483.50	50.17	27.57	39.64	1.74	0.73	40.57	74.00	-33.43	Peak	VERTICAL
2	2483.78	49.49	27.57	39.64	1.74	0.73	39.89	74.00	-34.11	Peak	VERTICAL

Note: 1. Result Level = Read Level + Antenna Factor + Cable loss + Filter Factor - PRM Factor.

2. If Peak Result complies with AV limit, AV Result is deemed to comply with AV limit.

3. Test setup: RBW: 1 MHz, VBW: 3 MHz, Sweep time: auto.

TR-4-E-009 Radiated Emission Test Result

Test Site : DDT 3m Chamber 3#

D:\E3 6.111\2022 Report Data\Q22031115-2E aGO
MINI\NEW\FCC ABOVE 1G .EM6

Test Date : 2022-05-23

Tested By : Kennys Zhang

EUT : Wireless Speaker

Model Number : aGO MINI

Power Supply : Battery

Test Mode : Tx Mode

Condition : Temp:22.8°C,Humi:53%,Press:100.1kPa

Antenna/Distance : 2021 BBHA 9120D
3#/3m/HORIZONTAL

Memo : 2DH5 2402

Data: 11

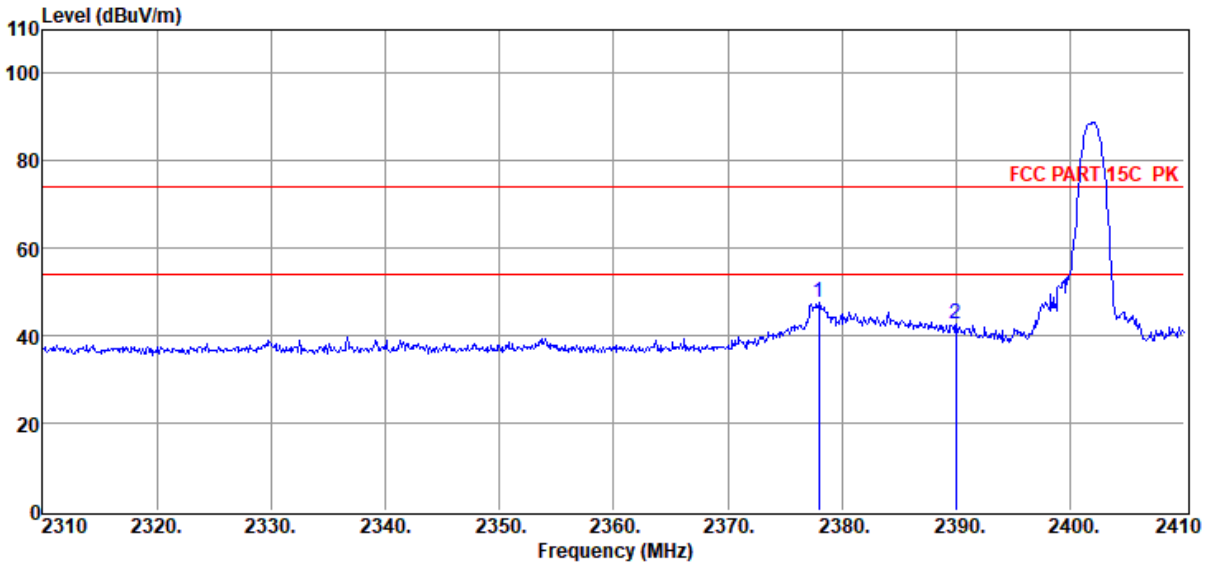

Item (Mark)	Freq. (MHz)	Read Level (dBμV)	Antenna Factor (dB/m)	PRM Factor dB	Cable Loss dB	Filter Factor dB	Result Level (dBμV/m)	Limit Line (dBμV/m)	Over Limit (dB)	Detector	Polarization
1	2378.00	57.33	27.38	39.59	1.71	0.72	47.55	74.00	-26.45	Peak	HORIZONTAL
2	2390.00	52.51	27.40	39.60	1.71	0.72	42.74	74.00	-31.26	Peak	HORIZONTAL

Note: 1. Result Level = Read Level + Antenna Factor + Cable loss + Filter Factor - PRM Factor.

2. If Peak Result complies with AV limit, AV Result is deemed to comply with AV limit.

3. Test setup: RBW: 1 MHz, VBW: 3 MHz, Sweep time: auto.

TR-4-E-009 Radiated Emission Test Result

Test Site : DDT 3m Chamber 3#

D:\E3 6.111\2022 Report Data\Q22031115-2E aGO
MINI\NEW\FCC ABOVE 1G .EM6

Test Date : 2022-05-23

Tested By : Kennys Zhang

EUT : Wireless Speaker

Model Number : aGO MINI

Power Supply : Battery

Test Mode : Tx Mode

Condition : Temp:22.8°C,Humi:53%,Press:100.1kPa

Antenna/Distance : 2021 BBHA 9120D 3#/3m/VERTICAL

Memo : 2DH5 2402

Data: 12

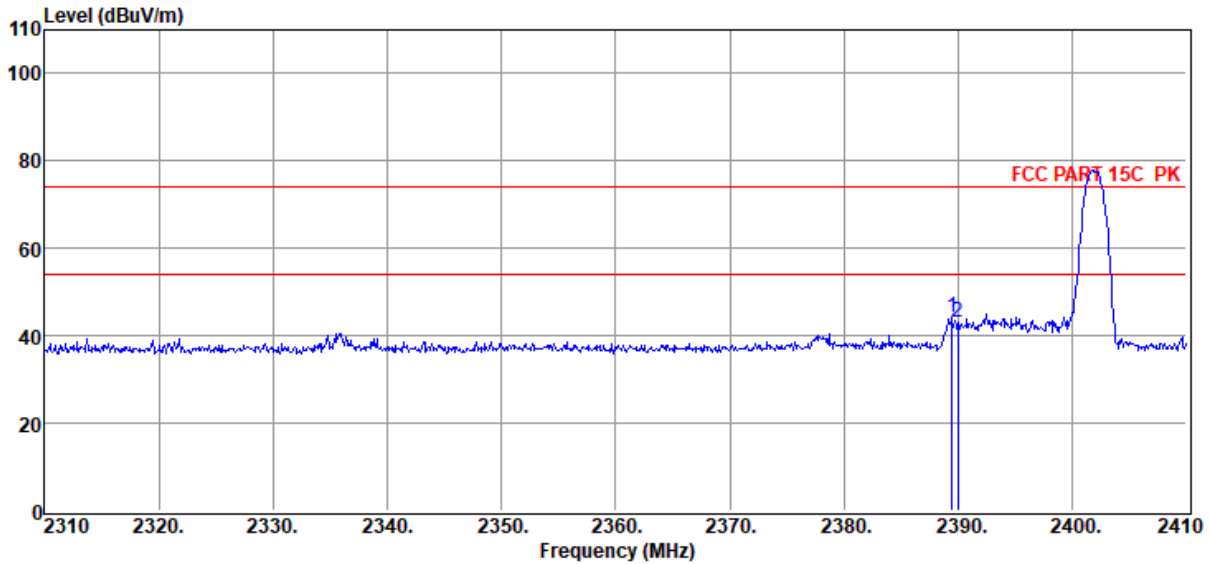

Item (Mark)	Freq. (MHz)	Read Level (dBuV)	Antenna Factor (dB/m)	PRM Factor dB	Cable Loss dB	Filter Factor dB	Result Level (dBuV/m)	Limit Line (dBuV/m)	Over Limit (dB)	Detector	Polarization
1	2389.50	53.82	27.40	39.59	1.71	0.72	44.06	74.00	-29.94	Peak	VERTICAL
2	2390.00	52.91	27.40	39.60	1.71	0.72	43.14	74.00	-30.86	Peak	VERTICAL

Note: 1. Result Level = Read Level + Antenna Factor + Cable loss + Filter Factor - PRM Factor.

2. If Peak Result complies with AV limit, AV Result is deemed to comply with AV limit.

3. Test setup: RBW: 1 MHz, VBW: 3 MHz, Sweep time: auto.

TR-4-E-009 Radiated Emission Test Result

Test Site : DDT 3m Chamber 3#

D:\E3 6.111\2022 Report Data\Q22031115-2E aGO
MINI\NEW\FCC ABOVE 1G .EM6

Test Date : 2022-05-23

Tested By : Kennys Zhang

EUT : Wireless Speaker

Model Number : aGO MINI

Power Supply : Battery

Test Mode : Tx Mode

Condition : Temp:22.8°C,Humi:53%,Press:100.1kPa

Antenna/Distance : 2021 BBHA 9120D
3#/3m/HORIZONTAL

Memo : 2DH5 2480

Data: 13

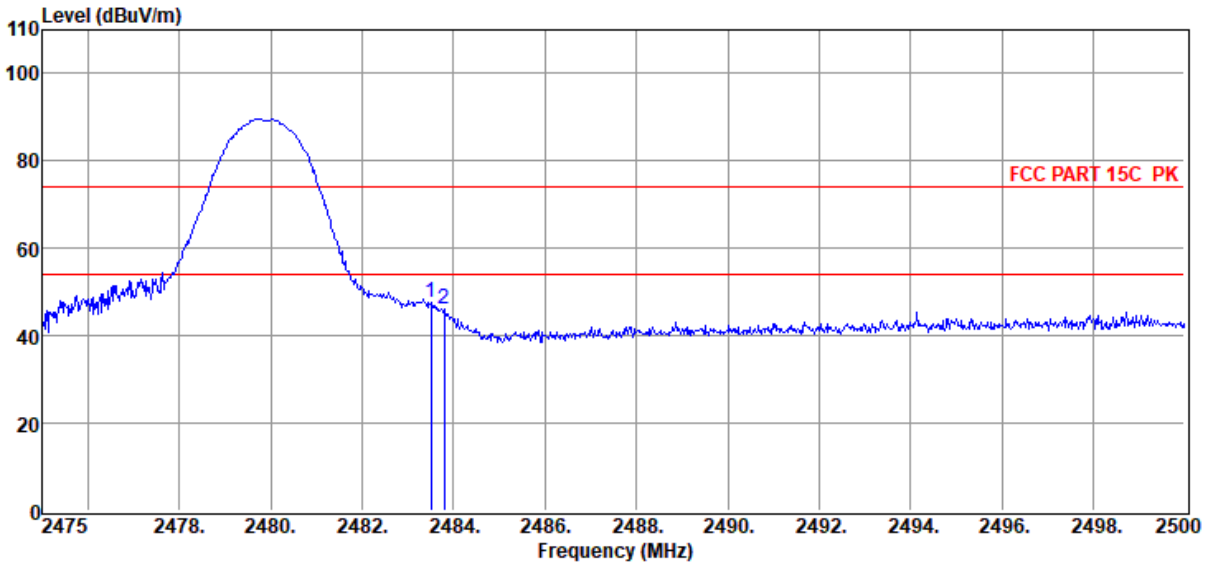

Item (Mark)	Freq. (MHz)	Read Level (dBuV)	Antenna Factor (dB/m)	PRM Factor dB	Cable Loss dB	Filter Factor dB	Result Level (dBuV/m)	Limit Line (dBuV/m)	Over Limit (dB)	Detector	Polarization
1	2483.50	57.34	27.57	39.64	1.74	0.73	47.74	74.00	-26.26	Peak	HORIZONTAL
2	2483.80	55.57	27.57	39.64	1.74	0.73	45.97	74.00	-28.03	Peak	HORIZONTAL

Note: 1. Result Level = Read Level + Antenna Factor + Cable loss + Filter Factor - PRM Factor.

2. If Peak Result complies with AV limit, AV Result is deemed to comply with AV limit.

3. Test setup: RBW: 1 MHz, VBW: 3 MHz, Sweep time: auto.

TR-4-E-009 Radiated Emission Test Result

Test Site : DDT 3m Chamber 3#

D:\E3 6.111\2022 Report Data\Q22031115-2E aGO
MINI\NEW\FCC ABOVE 1G .EM6

Test Date : 2022-05-23

Tested By : Kennys Zhang

EUT : Wireless Speaker

Model Number : aGO MINI

Power Supply : Battery

Test Mode : Tx Mode

Condition : Temp:22.8°C,Humi:53%,Press:100.1kPa

Antenna/Distance : 2021 BBHA 9120D 3#/3m/VERTICAL

Memo : 2DH5 2480

Data: 14

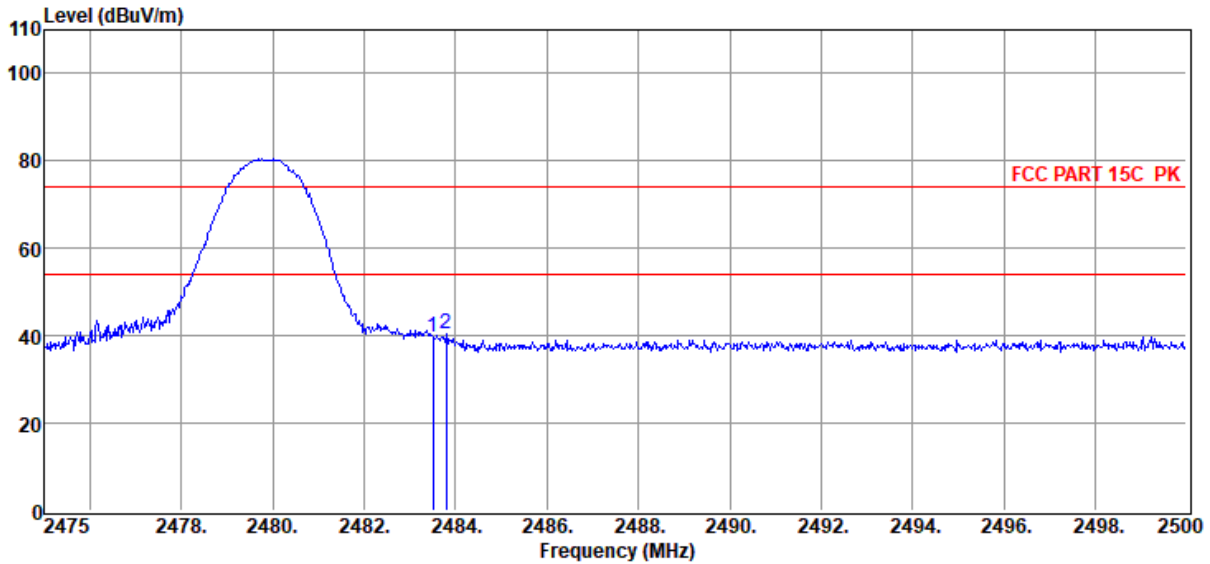

Item (Mark)	Freq. (MHz)	Read Level (dBμV)	Antenna Factor (dB/m)	PRM Factor dB	Cable Loss dB	Filter Factor dB	Result Level (dBμV/m)	Limit Line (dBμV/m)	Over Limit (dB)	Detector	Polarization
1	2483.50	49.18	27.57	39.64	1.74	0.73	39.58	74.00	-34.42	Peak	VERTICAL
2	2483.80	49.95	27.57	39.64	1.74	0.73	40.35	74.00	-33.65	Peak	VERTICAL

- Note: 1. Result Level = Read Level + Antenna Factor + Cable loss + Filter Factor - PRM Factor.
 2. If Peak Result complies with AV limit, AV Result is deemed to comply with AV limit.
 3. Test setup: RBW: 1 MHz, VBW: 3 MHz, Sweep time: auto.

TR-4-E-009 Radiated Emission Test Result

Test Site : DDT 3m Chamber 3#

D:\E3 6.111\2022 Report Data\Q22031115-2E aGO
MINI\NEW\FCC ABOVE 1G .EM6

Test Date : 2022-05-23

Tested By : Kennys Zhang

EUT : Wireless Speaker

Model Number : aGO MINI

Power Supply : Battery

Test Mode : Tx Mode

Condition : Temp:22.8°C,Humi:53%,Press:100.1kPa

Antenna/Distance : 2021 BBHA 9120D
3#/3m/HORIZONTAL

Memo : 3DH5 2402

Data: 15

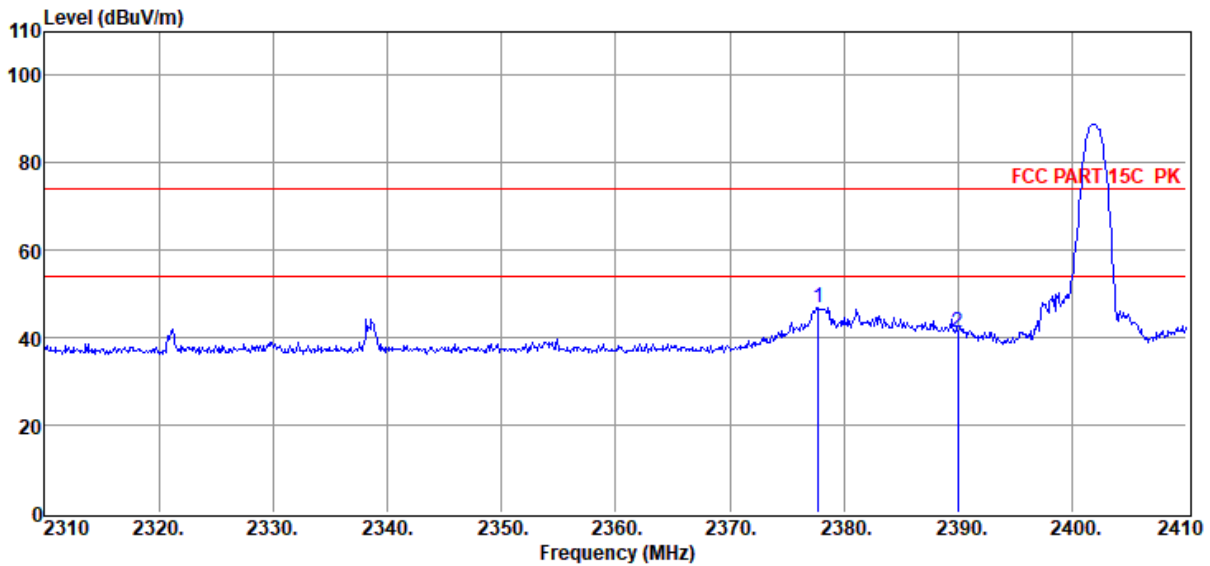

Item (Mark)	Freq. (MHz)	Read Level (dBuV)	Antenna Factor (dB/m)	PRM Factor dB	Cable Loss dB	Filter Factor dB	Result Level (dBuV/m)	Limit Line (dBuV/m)	Over Limit (dB)	Detector	Polarization
1	2377.80	56.57	27.38	39.59	1.71	0.72	46.79	74.00	-27.21	Peak	HORIZONTAL
2	2390.00	51.07	27.40	39.60	1.71	0.72	41.30	74.00	-32.70	Peak	HORIZONTAL

Note: 1. Result Level = Read Level + Antenna Factor + Cable loss + Filter Factor - PRM Factor.

2. If Peak Result complies with AV limit, AV Result is deemed to comply with AV limit.

3. Test setup: RBW: 1 MHz, VBW: 3 MHz, Sweep time: auto.

TR-4-E-009 Radiated Emission Test Result

Test Site : DDT 3m Chamber 3#

D:\E3 6.111\2022 Report Data\Q22031115-2E aGO
MINI\NEW\FCC ABOVE 1G .EM6

Test Date : 2022-05-23

Tested By : Kennys Zhang

EUT : Wireless Speaker

Model Number : aGO MINI

Power Supply : Battery

Test Mode : Tx Mode

Condition : Temp:22.8°C,Humi:53%,Press:100.1kPa

Antenna/Distance : 2021 BBHA 9120D 3#/3m/VERTICAL

Memo : 3DH5 2402

Data: 16

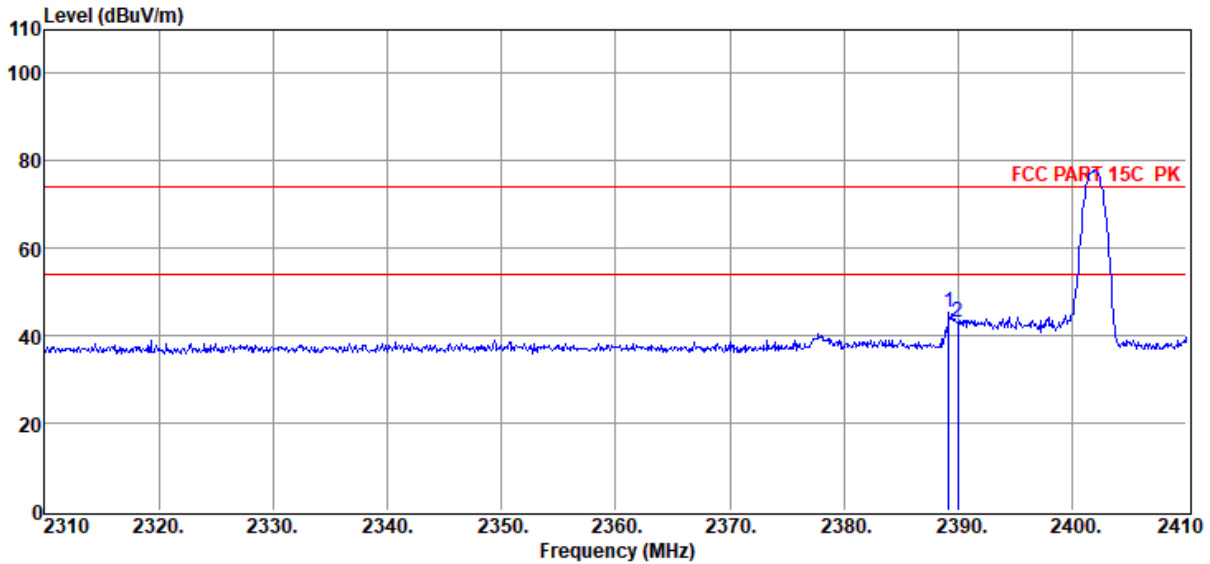

Item (Mark)	Freq. (MHz)	Read Level (dBμV)	Antenna Factor (dB/m)	PRM Factor dB	Cable Loss dB	Filter Factor dB	Result Level (dBμV/m)	Limit Line (dBμV/m)	Over Limit (dB)	Detector	Polarization
1	2389.20	55.12	27.40	39.59	1.71	0.72	45.36	74.00	-28.64	Peak	VERTICAL
2	2390.00	52.70	27.40	39.60	1.71	0.72	42.93	74.00	-31.07	Peak	VERTICAL

Note: 1. Result Level = Read Level + Antenna Factor + Cable loss + Filter Factor - PRM Factor.

2. If Peak Result complies with AV limit, AV Result is deemed to comply with AV limit.

3. Test setup: RBW: 1 MHz, VBW: 3 MHz, Sweep time: auto.

TR-4-E-009 Radiated Emission Test Result

Test Site : DDT 3m Chamber 3#

D:\E3 6.111\2022 Report Data\Q22031115-2E aGO
MINI\NEW\FCC ABOVE 1G .EM6

Test Date : 2022-05-23

Tested By : Kennys Zhang

EUT : Wireless Speaker

Model Number : aGO MINI

Power Supply : Battery

Test Mode : Tx Mode

Condition : Temp:22.8°C,Humi:53%,Press:100.1kPa

Antenna/Distance : 2021 BBHA 9120D
3#/3m/HORIZONTAL

Memo : 3DH5 2480

Data: 17

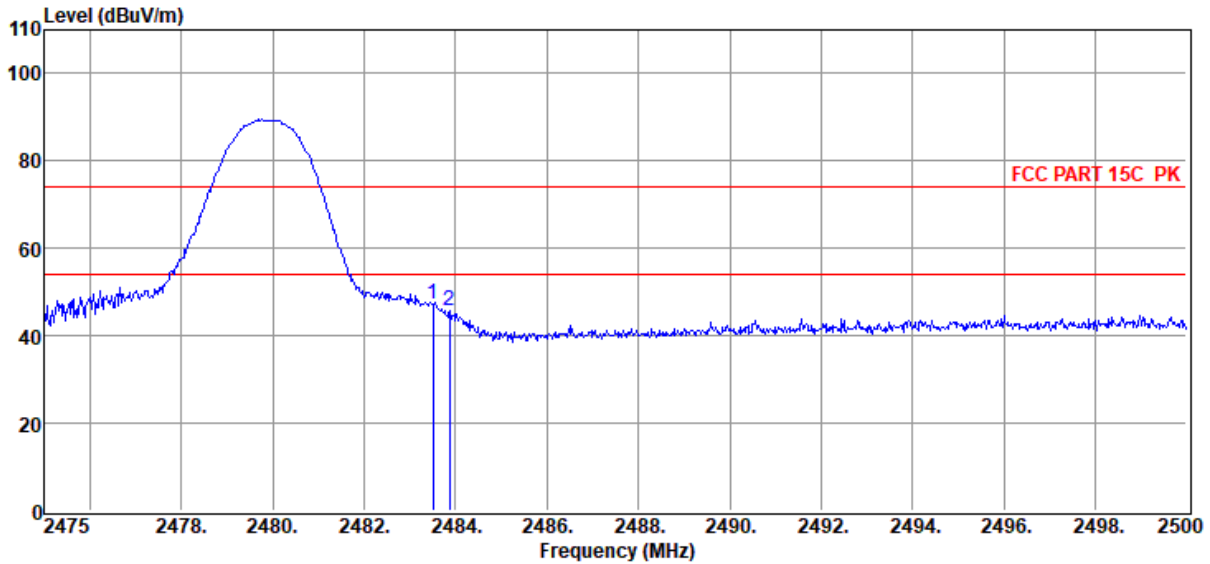

Item (Mark)	Freq. (MHz)	Read Level (dBuV)	Antenna Factor (dB/m)	PRM Factor dB	Cable Loss dB	Filter Factor dB	Result Level (dBuV/m)	Limit Line (dBuV/m)	Over Limit (dB)	Detector	Polarization
1	2483.50	56.94	27.57	39.64	1.74	0.73	47.34	74.00	-26.66	Peak	HORIZONTAL
2	2483.88	55.26	27.57	39.64	1.74	0.73	45.66	74.00	-28.34	Peak	HORIZONTAL

Note: 1. Result Level = Read Level + Antenna Factor + Cable loss + Filter Factor - PRM Factor.

2. If Peak Result complies with AV limit, AV Result is deemed to comply with AV limit.

3. Test setup: RBW: 1 MHz, VBW: 3 MHz, Sweep time: auto.

TR-4-E-009 Radiated Emission Test Result

Test Site : DDT 3m Chamber 3#

D:\E3 6.111\2022 Report Data\Q22031115-2E aGO
MINI\NEW\FCC ABOVE 1G .EM6

Test Date : 2022-05-23

Tested By : Kennys Zhang

EUT : Wireless Speaker

Model Number : aGO MINI

Power Supply : Battery

Test Mode : Tx Mode

Condition : Temp:22.8°C,Humi:53%,Press:100.1kPa

Antenna/Distance : 2021 BBHA 9120D 3#/3m/VERTICAL

Memo : 3DH5 2480

Data: 18

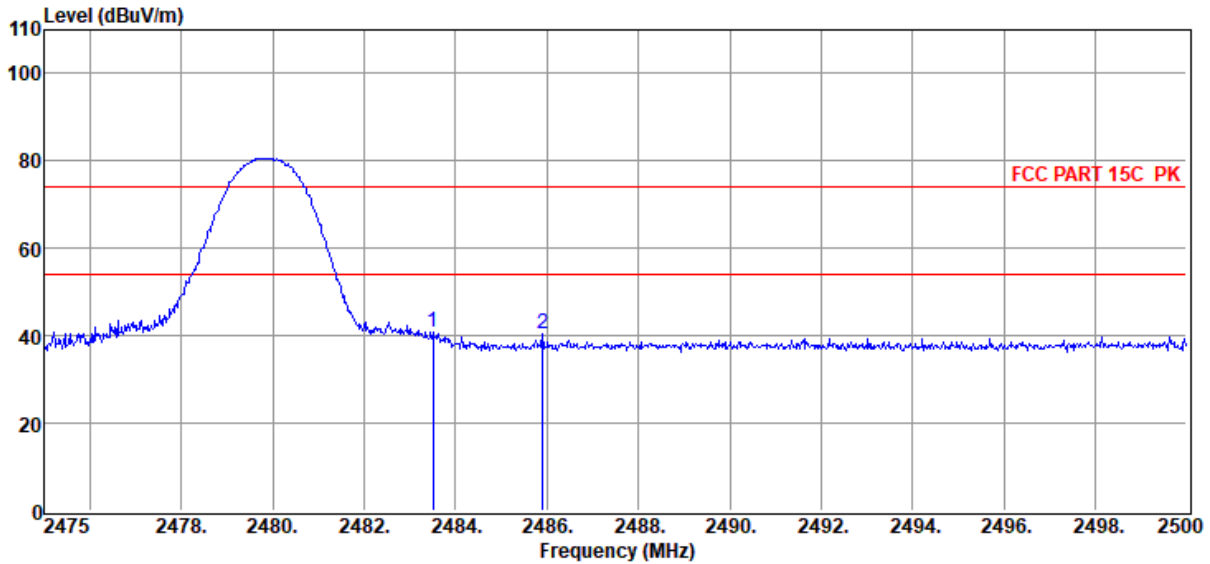

Item (Mark)	Freq. (MHz)	Read Level (dBuV)	Antenna Factor (dB/m)	PRM Factor (dB)	Cable Loss (dB)	Filter Factor (dB)	Result Level (dBuV/m)	Limit Line (dBuV/m)	Over Limit (dB)	Detector	Polarization
1	2483.50	50.47	27.57	39.64	1.74	0.73	40.87	74.00	-33.13	Peak	VERTICAL
2	2485.90	49.91	27.57	39.64	1.74	0.73	40.31	74.00	-33.69	Peak	VERTICAL

Note: 1. Result Level = Read Level + Antenna Factor + Cable loss + Filter Factor - PRM Factor.

2. If Peak Result complies with AV limit, AV Result is deemed to comply with AV limit.

3. Test setup: RBW: 1 MHz, VBW: 3 MHz, Sweep time: auto.

13. Power Line Conducted Emission

13.1. Block diagram of test setup

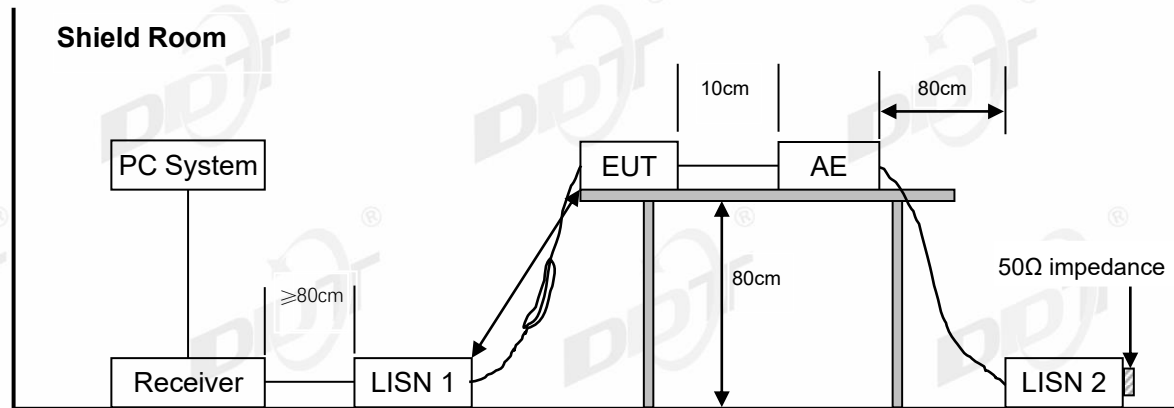

13.2. Power line conducted emission limits

Frequency	Quasi-Peak Level dB(μ V)	Average Level dB(μ V)
150 kHz ~ 500 kHz	66 ~ 56*	56 ~ 46*
500 kHz ~ 5 MHz	56	46
5 MHz ~ 30 MHz	60	50

Note 1: * Decreasing linearly with logarithm of frequency.

Note 2: The lower limit shall apply at the transition frequencies.

13.3. Test procedure

The EUT and Support equipment, if needed, were put placed on a non-metallic table, 80cm above the ground plane.

Configuration EUT to simulate typical usage as described in clause 2.4 and test equipment as described in clause 10.2 of this report.

All I/O cables were positioned to simulate typical actual usage as per ANSI C63.10.

All support equipment power received from a second LISN.

Emissions were measured on each current carrying line of the EUT using an EMI Test Receiver connected to the LISN powering the EUT.

The Receiver scanned from 150 kHz to 30 MHz for emissions in each of the test modes.

During the above scans, the emissions were maximized by cable manipulation.

The test mode(s) described in clause 2.4 were scanned during the preliminary test.

After the preliminary scan, we found the test mode producing the highest emission level.

The EUT configuration and worse cable configuration of the above highest emission levels were recorded for reference of the final test.

EUT and support equipment were set up on the test bench as per the configuration with highest

emission level in the preliminary test.

A scan was taken on both power lines, Neutral and Line, recording at least the six highest emissions.

Emission frequency and amplitude were recorded into a computer in which correction factors were used to calculate the emission level and compare reading to the applicable limit.

The test data of the worst-case condition(s) was recorded.

The bandwidth of test receiver is set at 9 kHz.

13.4. Test result

Pass. (See below detailed test result)

Note1: All emissions not reported below are too low against the prescribed limits.

Note2: "----" means Peak detection; "----" means Average detection.

Note3: Pre-test AC conducted emission at both voltage AC 120V/60Hz and AC 240V/50Hz, recorded worse case.

TR-4-E-010 Conducted Emission Test Result

Test Site : DDT 5# Shield Room

D:\2022 Report Data\Q22031115-2E aGO

Test Date : 2022-05-26

Tested By : Kennys ZHANG

EUT : Wireless Speaker

Model : aGO MINI

Number

Test Mode : Tx Mode

Power Supply : AC 120V/60Hz

Condition : Temp:23.4°C,Humi:56.2%,Press:101.2kPa

LISN : 2021 ENV 216 3#/NEUTRAL

Memo :

Data: 2

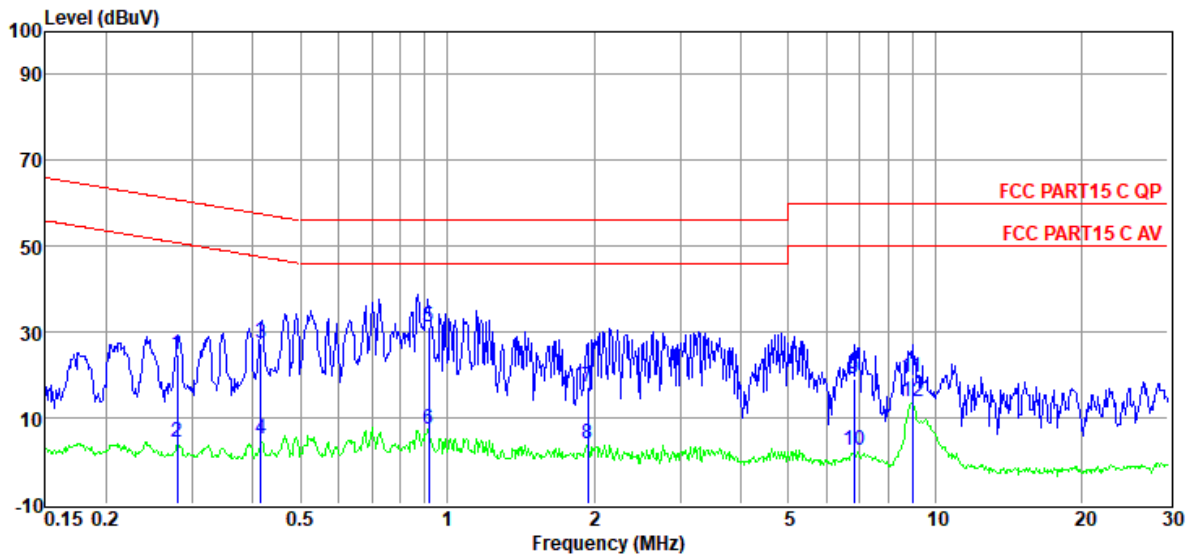

Item (Mark)	Freq. (MHz)	Read Level (dBμV)	LISN Factor (dB)	Cable Loss (dB)	Result Level (dBμV)	Limit Line (dBμV)	Over Limit (dB)	Detector	Phase
1	0.28	5.56	9.33	9.83	24.72	60.81	-36.09	QP	NEUTRAL
2	0.28	-14.89	9.33	9.83	4.27	50.81	-46.54	Average	NEUTRAL
3	0.41	8.36	9.24	9.84	27.44	57.55	-30.11	QP	NEUTRAL
4	0.41	-14.11	9.24	9.84	4.97	47.55	-42.58	Average	NEUTRAL
5	0.92	11.79	9.43	9.85	31.07	56.00	-24.93	QP	NEUTRAL
6	0.92	-11.79	9.43	9.85	7.49	46.00	-38.51	Average	NEUTRAL
7	1.94	-1.73	9.21	9.92	17.40	56.00	-38.60	QP	NEUTRAL
8	1.94	-15.33	9.21	9.92	3.80	46.00	-42.20	Average	NEUTRAL
9	6.81	-0.16	9.39	9.94	19.17	60.00	-40.83	QP	NEUTRAL
10	6.81	-16.88	9.39	9.94	2.45	50.00	-47.55	Average	NEUTRAL
11	8.96	0.03	9.40	9.95	19.38	60.00	-40.62	QP	NEUTRAL
12	8.96	-5.47	9.40	9.95	13.88	50.00	-36.12	Average	NEUTRAL

Note:

1. Result Level = Read Level + LISN Factor + Pulse Limiter Factor + Cable loss.
2. If QP Result complies with AV limit, AV Result is deemed to comply with AV limit.
3. Test setup: RBW: 200 Hz (9 kHz—150 kHz), 9 kHz (150 kHz—30 MHz).
4. Step size: 80Hz (0.009MHz-0.15MHz), 4 kHz (0.15MHz-30MHz), Scan time: auto.

TR-4-E-010 Conducted Emission Test Result

Test Site : DDT 5# Shield Room

D:\2022 Report Data\Q22031115-2E aGO

Test Date : 2022-05-26

Tested By : Kennys ZHANG

EUT : Wireless Speaker

Model : aGO MINI

Power Supply : AC 120V/60Hz

Number

Test Mode : Tx Mode

Condition : Temp:23.4°C,Humi:56.2%,Press:101.2kPa

LISN : 2021 ENV 216 3#/LINE

Memo :

Data: 4

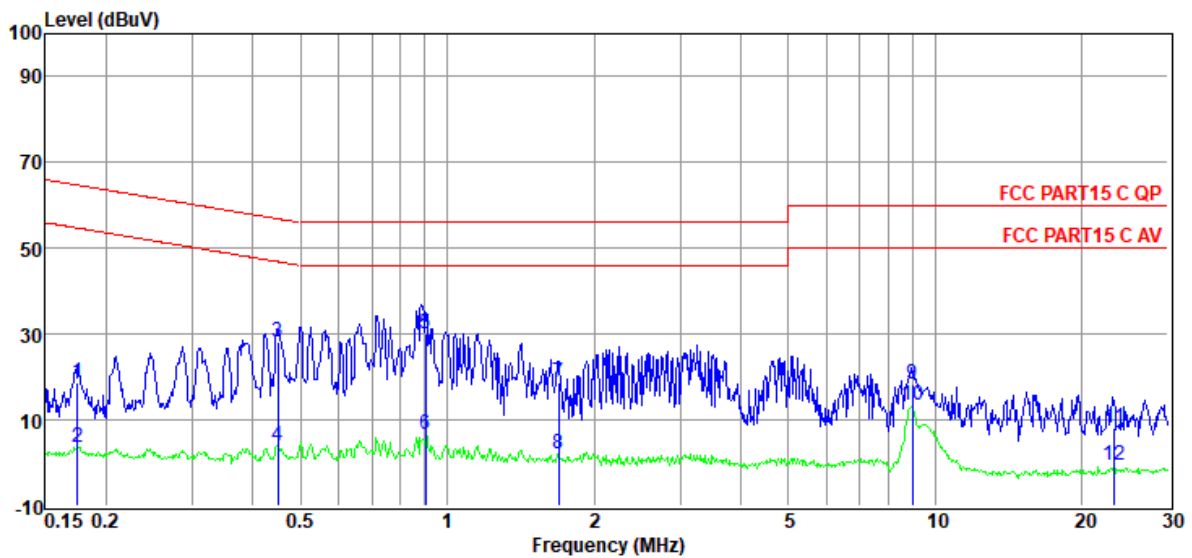

Item (Mark)	Freq. (MHz)	Read Level (dBμV)	LISN Factor (dB)	Cable Loss (dB)	Result Level (dBμV)	Limit Line (dBμV)	Over Limit (dB)	Detector	Phase
1	0.17	-0.75	9.50	9.83	18.58	64.72	-46.14	QP	LINE
2	0.17	-15.88	9.50	9.83	3.45	54.72	-51.27	Average	LINE
3	0.45	8.87	9.50	9.84	28.21	56.89	-28.68	QP	LINE
4	0.45	-15.18	9.50	9.84	4.16	46.89	-42.73	Average	LINE
5	0.90	10.93	9.43	9.85	30.21	56.00	-25.79	QP	LINE
6	0.90	-12.58	9.43	9.85	6.70	46.00	-39.30	Average	LINE
7	1.69	-0.69	9.48	9.90	18.69	56.00	-37.31	QP	LINE
8	1.69	-17.12	9.48	9.90	2.26	46.00	-43.74	Average	LINE
9	8.96	-1.16	9.46	9.95	18.25	60.00	-41.75	QP	LINE
10	8.96	-5.93	9.46	9.95	13.48	50.00	-36.52	Average	LINE
11	23.26	-10.92	9.20	10.04	8.32	60.00	-51.68	QP	LINE
12	23.26	-19.87	9.20	10.04	-0.63	50.00	-50.63	Average	LINE

Note:

1. Result Level = Read Level + LISN Factor + Pulse Limiter Factor + Cable loss.
2. If QP Result complies with AV limit, AV Result is deemed to comply with AV limit.
3. Test setup: RBW: 200 Hz (9 kHz—150 kHz), 9 kHz (150 kHz—30 MHz).
4. Step size: 80Hz (0.009MHz-0.15MHz), 4 kHz (0.15MHz-30MHz), Scan time: auto.

14. Antenna Requirements

14.1. Limit

For intentional device, according to FCC 47 CFR Section 15.203, an intentional radiator shall be designed to ensure that no antenna other than that furnished by the responsible party shall be used with the device. And according to FCC 47 CFR Section 15.247 (b), if transmitting antennas of directional gain greater than 6 dBi are used, the power shall be reduced by the amount in dB that the directional gain of the antenna exceeds 6 dBi.

14.2. Result

The product is that no antenna other than that furnished by the responsible party shall be used with the device, the maximum peak gain of the transmit antenna is 0 dBi.