

# FCC CERTIFICATION TEST REPORT

## FOR

<b>Applicant</b>	:	KREAFUNK APS
<b>Address</b>	:	Klamsagervej 35 A, st.8230 Åbyhøj, Denmark
<b>Equipment under Test</b>	:	Bluetooth Speaker
<b>Model No.</b>	:	aCAPPELLA
<b>Trade Mark</b>	:	KREAFUNK
<b>FCC ID</b>	:	2ACVC-ACAPPELLA
<b>Manufacturer</b>	:	Shenzhen Winnershine Electronics Co., Ltd
<b>Address</b>	:	101.32# Yuanhu Road, zhangbei community, LongCheng Street, LongGang district, Shenzhen

**Issued By: Dongguan Dongdian Testing Service Co., Ltd.**

**Add.:** No. 17, Zongbu Road 2, Songshan Lake Sci&Tech, Industry Park,  
Dongguan City, Guangdong Province, China, 523808

**Tel.:** +86-0769-38826678, **E-mail:** ddt@dgddt.com, <http://www.dgddt.com>

# REPORT

## Table of Contents

	Test report declares.....	4
1.	Summary of Test Results .....	6
2.	General Test Information .....	7
2.1.	Description of EUT.....	7
2.2.	Accessories of EUT .....	7
2.3.	Assistant equipment used for test.....	8
2.4.	Block diagram of EUT configuration for test .....	8
2.5.	Deviations of test standard .....	8
2.6.	Test environment conditions .....	8
2.7.	Test laboratory.....	9
2.8.	Measurement uncertainty .....	9
3.	Equipment Used During Test.....	10
4.	Maximum Peak Output Power .....	12
4.1.	Block diagram of test setup .....	12
4.2.	Limits .....	12
4.3.	Test procedure.....	12
4.4.	Test result.....	12
4.5.	Original test data.....	13
5.	20 dB Bandwidth and 99% Bandwidth.....	16
5.1.	Block diagram of test setup .....	16
5.2.	Limits .....	16
5.3.	Test procedure.....	16
5.4.	Test result.....	16
5.5.	Original test data.....	17
6.	Carrier Frequency Separation.....	20
6.1.	Block diagram of test setup .....	20
6.2.	Limits .....	20
6.3.	Test procedure.....	20
6.4.	Test result.....	20
6.5.	Original test data.....	21
7.	Number of Hopping Channel .....	22
7.1.	Block diagram of test setup .....	22
7.2.	Limits .....	22
7.3.	Test procedure.....	22
7.4.	Test result.....	22
7.5.	Original test data.....	22
8.	Dwell Time.....	24

8.1.	Block diagram of test setup .....	24
8.2.	Limits .....	24
8.3.	Test procedure.....	24
8.4.	Test result.....	24
8.5.	Original test data.....	25
9.	Band Edge Compliance (Conducted Method).....	31
9.1.	Block diagram of test setup .....	31
9.2.	Limit .....	31
9.3.	Test result.....	31
9.4.	Original test data.....	31
10.	Radiated Emission.....	36
10.1.	Block diagram of test setup .....	36
10.2.	Limit.....	37
10.3.	Test procedure.....	38
10.4.	Test result.....	40
11.	RF Conducted Spurious Emissions .....	45
11.1.	Block diagram of test setup .....	45
11.2.	Limits .....	45
11.3.	Test procedure.....	45
11.4.	Test result.....	46
11.5.	Original test data.....	46
12.	Band Edge Compliance (Radiated Method) .....	56
12.1.	Block diagram of test setup .....	56
12.2.	Limit.....	56
12.3.	Test procedure.....	56
12.4.	Test result.....	56
13.	Power Line Conducted Emission.....	69
13.1.	Block diagram of test setup .....	69
13.2.	Power line conducted emission limits .....	69
13.3.	Test procedure.....	69
13.4.	Test result.....	70
14.	Antenna Requirements .....	73
14.1.	Limit.....	73
14.2.	Result .....	73
15.	Test Setup Photograph.....	74
16.	Photos of the EUT .....	76

## Test Report Declare

<b>Applicant</b>	:	KREAFUNK APS
<b>Address</b>	:	Klamsagervej 35 A, st.8230 Åbyhøj, Denmark
<b>Equipment under Test</b>	:	Bluetooth Speaker
<b>Model No.</b>	:	aCAPPELLA
<b>Trade Mark</b>	:	KREAFUNK
<b>Manufacturer</b>	:	Shenzhen Winnershine Electronics Co., Ltd
<b>Address</b>	:	101.32# Yuanhu Road, zhangbei community, LongCheng Street, LongGang district, Shenzhen

### Test Standard Used:

FCC Rules and Regulations Part 15 Subpart C.

### Test Procedure Used:

ANSI C63.10:2013.

### We Declare:

The equipment described above is tested by Dongguan Dongdian Testing Service Co., Ltd. and in the configuration tested the equipment complied with the standards specified above. The test results are contained in this test report and Dongguan Dongdian Testing Service Co., Ltd. is assumed of full responsibility for the accuracy and completeness of these tests.

**After test and evaluation, our opinion is that the equipment provided for test compliance with the requirement of the above FCC standards.**

<b>Report No.:</b>	DDT-R21022514-14E1		
<b>Date of Receipt:</b>	Mar. 15, 2021	<b>Date of Test:</b>	Mar. 15, 2021 ~ May 06, 2021

**Prepared By:**

*Sam Li*  
 \_\_\_\_\_  
**Sam Li/Engineer**

**Approved By:**

  
 \_\_\_\_\_  
**Damon Hu/EMC Manager**

Note: This report applies to above tested sample only. This report shall not be reproduced in parts without written approval of Dongguan Dongdian Testing Service Co., Ltd.

### Revision History

Rev.	Revisions	Issue Date	Revised By
---	Initial issue	May 06, 2021	

## 1. Summary of Test Results

Description of Test Item	Standard	Results
Maximum Peak Output Power	FCC Part 15: 15.247(b)(1) ANSI C63.10:2013	Pass
20 dB Bandwidth and 99% Bandwidth	FCC Part 15: 15.215 ANSI C63.10:2013	Pass
Carrier Frequency Separation	FCC Part 15: 15.247(a)(1) ANSI C63.10:2013	Pass
Number of Hopping Channel	FCC Part 15: 15.247(a)(1)(iii) ANSI C63.10:2013	Pass
Dwell Time	FCC Part 15: 15.247(a)(1)(iii) ANSI C63.10:2013	Pass
Radiated Emission	FCC Part 15: 15.209 FCC Part 15: 15.247(d) ANSI C63.10:2013	Pass
Band Edge Compliance	FCC Part 15: 15.247(d) ANSI C63.10:2013	Pass
Power Line Conducted Emissions	FCC Part 15: 15.207 ANSI C63.10:2013	Pass
Antenna Requirement	FCC Part 15: 15.203	Pass

## 2. General Test Information

### 2.1. Description of EUT

EUT* Name	: Bluetooth Speaker
Model Number	: aCAPPELLA
EUT Function Description	: Please reference user manual of this device
Power Supply	: DC 5V by USB : DC 7.4V by Polymer Li-ion built-in battery
Radio Specification	: Bluetooth V5.0
Operation Frequency	: 2402 MHz - 2480 MHz
Modulation	: GFSK, $\pi/4$ -DQPSK, 8DPSK
Data Rate	: 1 Mbps, 2 Mbps, 3 Mbps
Antenna Type	: PCB antenna, maximum PK gain: 2.9 dBi
Serial Number	: N/A

Note: EUT is the abbreviation of equipment under test.

Channel Information					
Channel	Frequency (MHz)	Channel	Frequency (MHz)	Channel	Frequency (MHz)
0	2402	27	2429	54	2456
1	2403	28	2430	55	2457
2	2404	29	2431	56	2458
3	2405	30	2432	57	2459
4	2406	31	2433	58	2460
5	2407	32	2434	59	2461
6	2408	33	2435	60	2462
7	2409	34	2436	61	2463
8	2410	35	2437	62	2464
9	2411	36	2438	63	2465
10	2412	37	2439	64	2466
11	2413	38	2440	65	2467
12	2414	39	2441	66	2468
13	2415	40	2442	67	2469
14	2416	41	2443	68	2470
15	2417	42	2444	69	2471
16	2418	43	2445	70	2472
17	2419	44	2446	71	2473
18	2420	45	2447	72	2474
19	2421	46	2448	73	2475
20	2422	47	2449	74	2476
21	2423	48	2450	75	2477
22	2424	49	2451	76	2478
23	2425	50	2452	77	2479
24	2426	51	2453	78	2480
25	2427	52	2454		
26	2428	53	2455		

## 2.2. Accessories of EUT

Description of Accessories	Manufacturer	Model number	Description	Remark
USB cable	N/A	N/A	N/A	Length: 80 cm, unshielded

## 2.3. Assistant equipment used for test

Assistant equipment	Manufacturer	Model number	EMC Compliance	SN
Notebook	Lenovo Beijing Co. Ltd.	ThinkPad	FCC/CE	TP00015A
Adapter	SAMSUNG	EP-TA200	N/A	Input: 100-240~, 50/60Hz, 0.5A; Output: 9V/1.67A or 5V/2A

## 2.4. Block diagram of EUT configuration for test

EUT

Test software: BK32xx RF Test\_V1.8.2

The test software was used to control EUT work in Continuous Tx mode, and select test channel, wireless mode as below table.

Tested mode, channel, information			
Mode	Setting Tx Power	Channel	Frequency (MHz)
GFSK hopping on Tx mode	/	CH0 to CH78	2402 to 2480
$\pi/4$ -DQPSK hopping on Tx mode	/	CH0 to CH78	2402 to 2480
8DPSK hopping on Tx mode	/	CH0 to CH78	2402 to 2480
GFSK hopping off Tx mode	/	CH0	2402
	/	CH39	2441
	/	CH78	2480
$\pi/4$ -DQPSK hopping off Tx mode	/	CH0	2402
	/	CH39	2441
	/	CH78	2480
8DPSK hopping off Tx mode	/	CH0	2402
	/	CH39	2441
	/	CH78	2480

## 2.5. Deviations of test standard

No deviation.



## 2.6. Test environment conditions

During the measurement the environmental conditions were within the listed ranges:

Temperature range:	21-25 °C
Humidity range:	40-75%
Pressure range:	86-106 kPa

## 2.7. Test laboratory

®Dongguan Dongdian Testing Service Co., Ltd.

Add.: No. 17, Zongbu Road 2, Songshan Lake Sci&Tech, Industry Park, Dongguan City, Guangdong Province, China, 523808

Tel.: +86-0769-38826678, <http://www.dgddt.com>, Email: [ddt@dgddt.com](mailto:ddt@dgddt.com)

CNAS Registration No. CNAS L6451; A2LA Certificate Number: 3870.01;

FCC Designation Number: CN1182; FCC Test Firm Registration Number: 540522

Industry Canada Site Registration Number: 10288A-1; CAB identifier: CN0048

## 2.8. Measurement uncertainty

Test Item	Uncertainty
Bandwidth	1.1%
Peak Output Power (Conducted) (Spectrum Analyzer)	0.86 dB (10 MHz ≤ f < 3.6 GHz);
	1.38 dB (3.6 GHz ≤ f < 8 GHz)
Peak Output Power (Conducted) (Power Sensor)	0.74 dB
Power Spectral Density	0.74 dB (10 MHz ≤ f < 3.6 GHz);
	1.38 dB (3.6 GHz ≤ f < 8 GHz)
Frequencies Stability	6.7 × 10 <sup>-8</sup> (Antenna couple method)
	5.5 × 10 <sup>-8</sup> (Conducted method)
Conducted Spurious Emissions	0.86 dB (10 MHz ≤ f < 3.6 GHz);
	1.40 dB (3.6 GHz ≤ f < 8 GHz)
	1.66 dB (8 GHz ≤ f < 22 GHz)
Uncertainty for Radio Frequency (RBW < 20 kHz)	3×10 <sup>-8</sup>
Temperature	0.4 °C
Humidity	2 %
Uncertainty for Radiation Emission Test (30 MHz - 1 GHz)	4.70 dB (Antenna Polarize: V)
	4.84 dB (Antenna Polarize: H)
Uncertainty for Radiation Emission Test (1 GHz - 40 GHz)	4.10 dB (1-6 GHz)
	4.40 dB (6 GHz - 18 GHz)
	3.54 dB (18 GHz - 26 GHz)
	4.30 dB (26 GHz - 40 GHz)
Uncertainty for Power Line Conduction Emission Test	3.32 dB (150 kHz - 30 MHz)
Note: This uncertainty represents an expanded uncertainty expressed at approximately the 95% confidence level using a coverage factor of k=2.	

### 3. Equipment Used During Test

Equipment	Manufacturer	Model No.	Serial No.	Last Cal.	Cal. Interval
<b>RF Connected Test (Tonscend RF Measurement System 1#)</b>					
Spectrum analyzer	R&S	FSU26	101272	Jul. 01, 2020	1 Year
Spectrum analyzer	Agilent	N9020D	MY49100362	Sep. 28, 2020	1 Year
Wideband Radio Communication tester	R&S	CMW500	117491	Jul. 01, 2020	1 Year
Vector Signal Generator	Agilent	E8267D	US49060192	Sep. 24, 2020	1 Year
Vector Signal Generator	Agilent	N5182A	MY48180737	Jul. 01, 2020	1 Year
Power Sensor	Agilent	U2021XA	MY55150010	Jul. 01, 2020	1 Year
Power Sensor	Agilent	U2021XA	MY55150011	Jul. 01, 2020	1 Year
RF Cable	Micable	C10-01-01-1	100309	Sep. 28, 2020	1 Year
Temp&Humi Programmable	ZHIXIANG	ZXGDJS-150L	ZX170110-A	Jul. 01, 2020	1 Year
Test Software	JS Tonscend	JS1120-3	Ver.2.7	N/A	N/A
<b>RF Connected Test (Tonscend RF Measurement System 2#)</b>					
Spectrum analyzer	R&S	FSU26	200071	Sep. 25, 2020	1 Year
Spectrum analyzer	Agilent	N9020D	MY49100362	Sep. 28, 2020	1 Year
Wideband Radio Communication tester	R&S	CMW500	117491	Jul. 01, 2020	1 Year
Vector Signal Generator	Agilent	N5182A	MY19060405	Jul. 01, 2020	1 Year
Vector Signal Generator	Agilent	N5182A	MY48180912	Jul. 01, 2020	1 Year
RF Control Unit	Tonsend	JS0806-2	DDT-ZC01449	Jul. 01, 2020	1 Year
RF Cable	Micable	C10-01-01-1	100309	Sep. 28, 2020	1 Year
Temp&Humi Programmable	ZHIXIANG	ZXGDJS-150L	ZX170110-A	Jul. 01, 2020	1 Year
Test Software	JS Tonscend	JS1120-3	Ver.2.7	N/A	N/A
<b>Radiation 1#chamber</b>					
EMI Test Receiver	R&S	ESU8	100316	Sep. 24, 2020	1 Year
Spectrum analyzer	Agilent	E4447A	MY50180031	Jul. 01, 2020	1 Year
Trilog Broadband Antenna	Schwarzbeck	VULB9163	9163-462	Nov. 13, 2020	1 Year
Active Loop antenna	Schwarzbeck	FMZB-1519	1519-038	Nov. 13, 2020	1 Year
Double Ridged Horn Antenna	R&S	HF907	100276	Nov. 18, 2020	1 Year
Pre-amplifier	A.H.	PAM-0118	360	Sep. 28, 2020	1 Year
RF Cable	HUBSER	CP-X2+ CP-X1	W11.03+ W12.02	Sep. 24, 2020	1 Year
RF Cable	N/A	5m+6m+1m	06270619	Sep. 30, 2020	1 Year
MI Cable	HUBSER	C10-01-01-1 M	1091629	Sep. 30, 2020	1 Year
Test software	Audix	E3	V 6.11111b	N/A	N/A
<b>Radiation 2#chamber</b>					

EMI Test Receiver	R&S	ESCI	101364	Sep. 28, 2020	1 Year
Spectrum analyzer	Agilent	E4447A	MY50180031	Jul. 01, 2020	1 Year
Trilog Broadband Antenna	Schwarzbeck	VULB 9163	9163-994	Nov. 13, 2020	1 Year
Active Loop antenna	Schwarzbeck	FMZB-1519	1519-038	Nov. 13, 2020	1 Year
Double Ridged Horn Antenna	Schwarzbeck	BBHA9120	02108	Jul. 11, 2020	1 Year
Pre-amplifier	TERA-MW	TRLA-0040 G35	1013 03	Sep. 28, 2020	1 Year
RF Cable	N/A	14+1.5m	06270619	Sep. 28, 2020	1 Year
Test software	Audix	E3	V 6.11111b	N/A	N/A
<b>Power Line Conducted Emissions Test 1#</b>					
EMI Test Receiver	R&S	ESU8	100316	Sep. 24, 2020	1 Year
LISN 1	R&S	ENV216	101109	Sep. 28, 2020	1 Year
LISN 2	R&S	ESH2-Z5	100309	Sep. 28, 2020	1 Year
Pulse Limiter	R&S	ESH3-Z2	101242	Sep. 24, 2020	1 Year
CE Cable 1	HUBSER	N/A	W10.01	Sep. 24, 2020	1 Year
Test software	Audix	E3	V 6.11111b	N/A	N/A
<b>Power Line Conducted Emissions Test 2#</b>					
Test Receiver	R&S	ESPI	101761	Sep. 24, 2020	1 Year
LISN 1	R&S	ENV216	101170	Sep. 28, 2020	1 Year
LISN 2	R&S	ESH2-Z5	100309	Sep. 28, 2020	1 Year
Pulse Limiter	R&S	KH43101	43101180156 8-12#	Jul. 01, 2020	1 Year
CE Cable 2	HUBSER	N/A	W11.02	Sep. 24, 2020	1 Year
Test software	Audix	E3	V 6.11111b	N/A	N/A

## 4. Maximum Peak Output Power

### 4.1. Block diagram of test setup

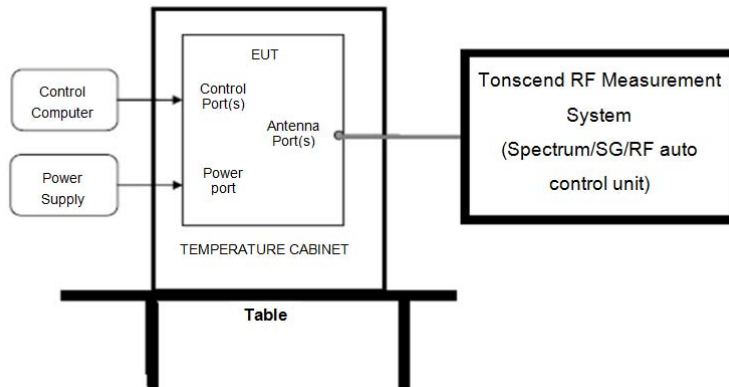

### 4.2. Limits

For frequency hopping systems operating in the 2400-2483.5 MHz band employing at least 75 non-overlapping hopping channels, and all frequency hopping systems in the 5725-5850 MHz band: 1 watt. For all other frequency hopping systems in the 2400-2483.5 MHz band: 0.125 watts, the e.i.r.p shall not exceed 4 W.

### 4.3. Test procedure

- (1) Connect EUT's antenna output to spectrum analyzer by RF cable.
- (2) Measure the maximum output power of EUT by spectrum analyzer with PK detector and RBW = 3 MHz (above 20 dB bandwidth of measured signal), VBW = 10 MHz

Note: The attenuator loss was inputted into spectrum analyzer as amplitude offset.

### 4.4. Test result

Mode	Antenna	Freq. (MHz)	Result (dBm)	Limit (dBm)	Verdict
GFSK	ANT1	2402	3.11	21	Pass
	ANT1	2441	3.84	21	Pass
	ANT1	2480	3.21	21	Pass
$\pi/4$ -DQPSK	ANT1	2402	4.85	21	Pass
	ANT1	2441	5.56	21	Pass
	ANT1	2480	5.21	21	Pass
8DPSK	ANT1	2402	5.34	21	Pass
	ANT1	2441	5.87	21	Pass
	ANT1	2480	5.58	21	Pass

### 4.5. Original test data

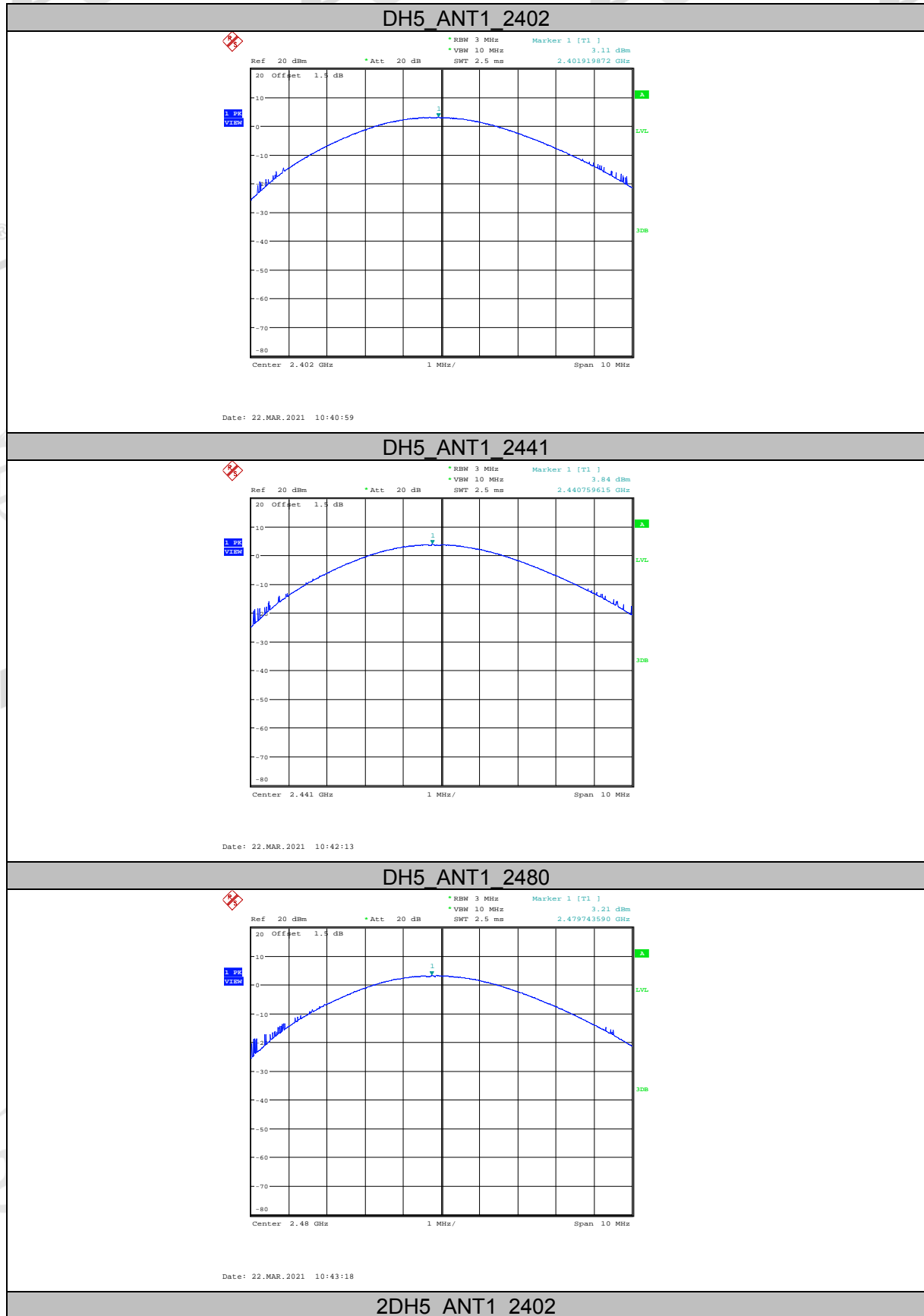

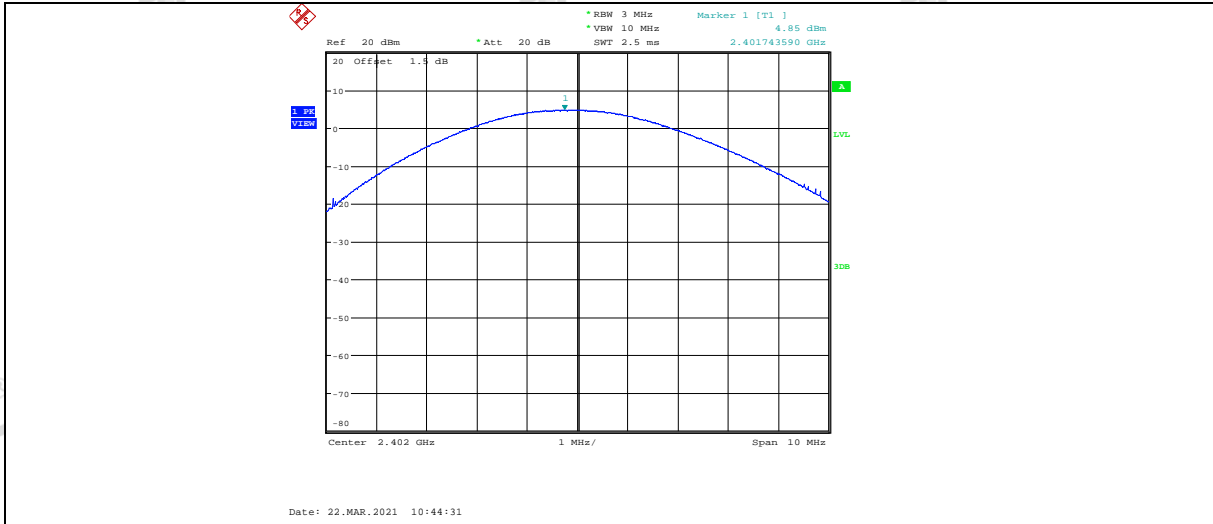

2DH5 ANT1 2441

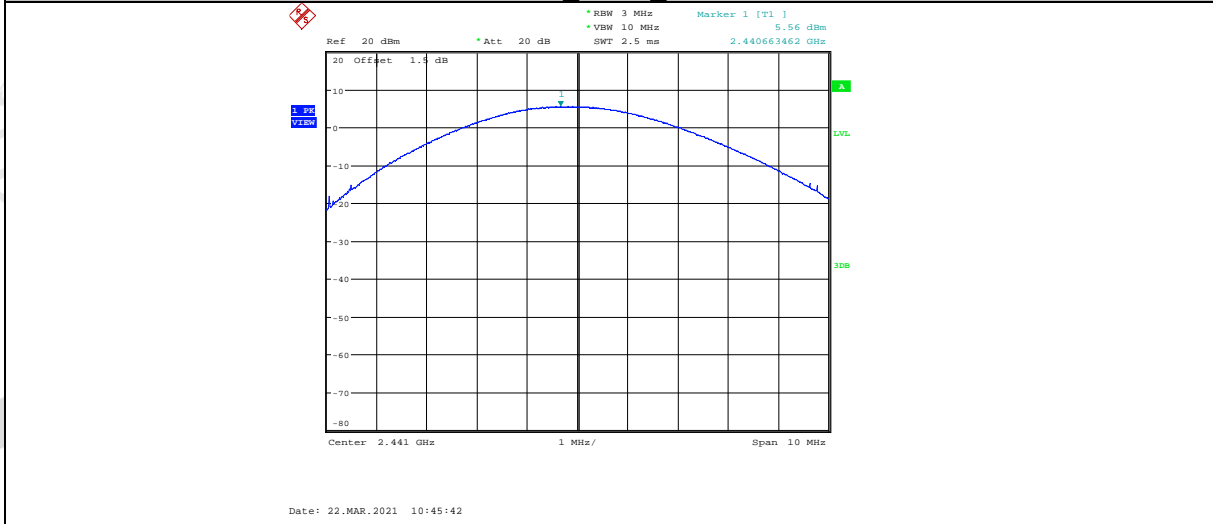

2DH5 ANT1 2480

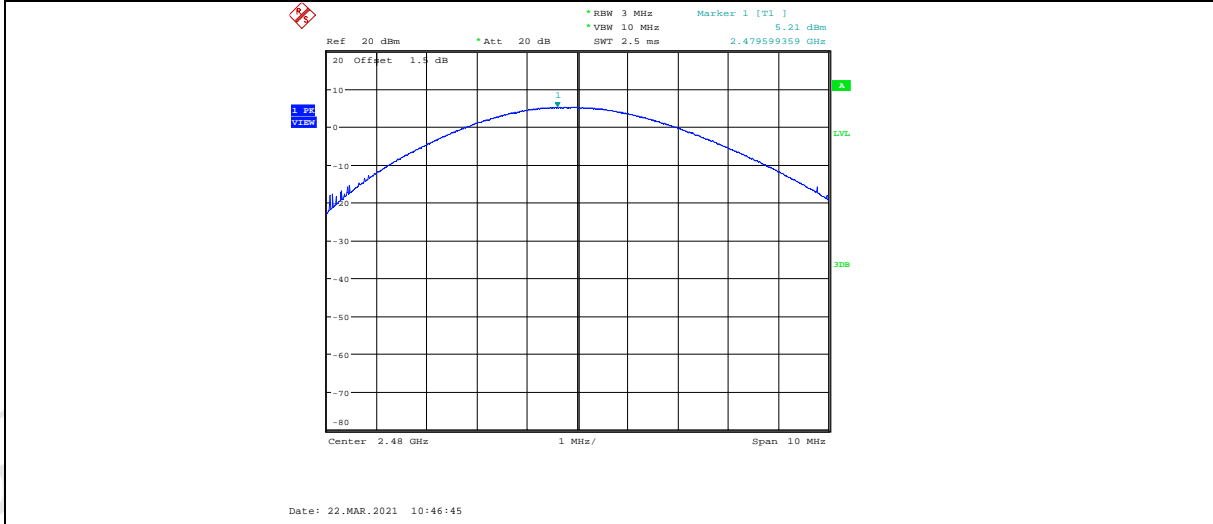

3DH5 ANT1\_2402

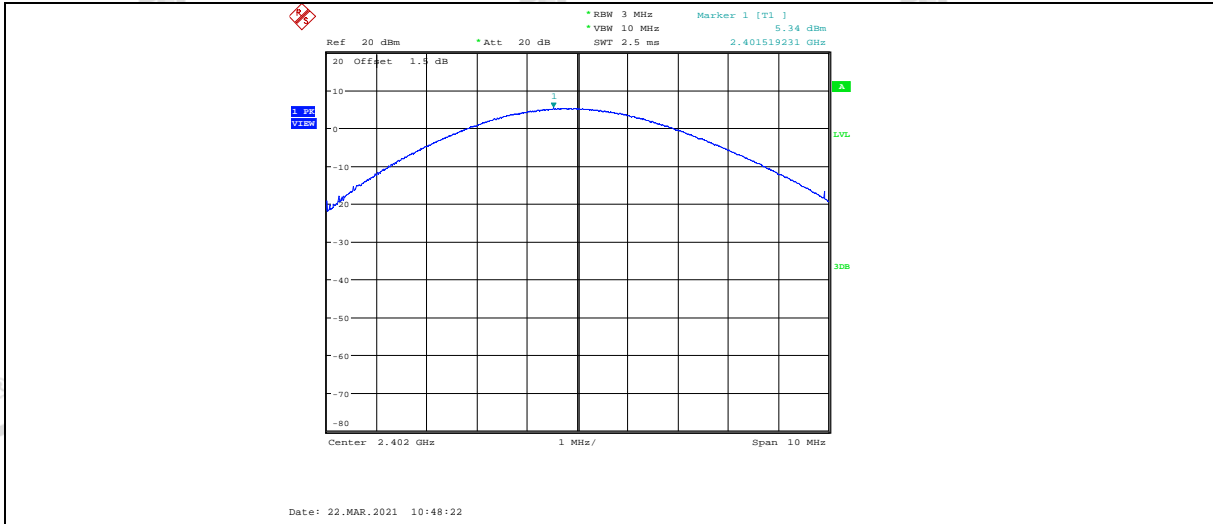

3DH5 ANT1 2441

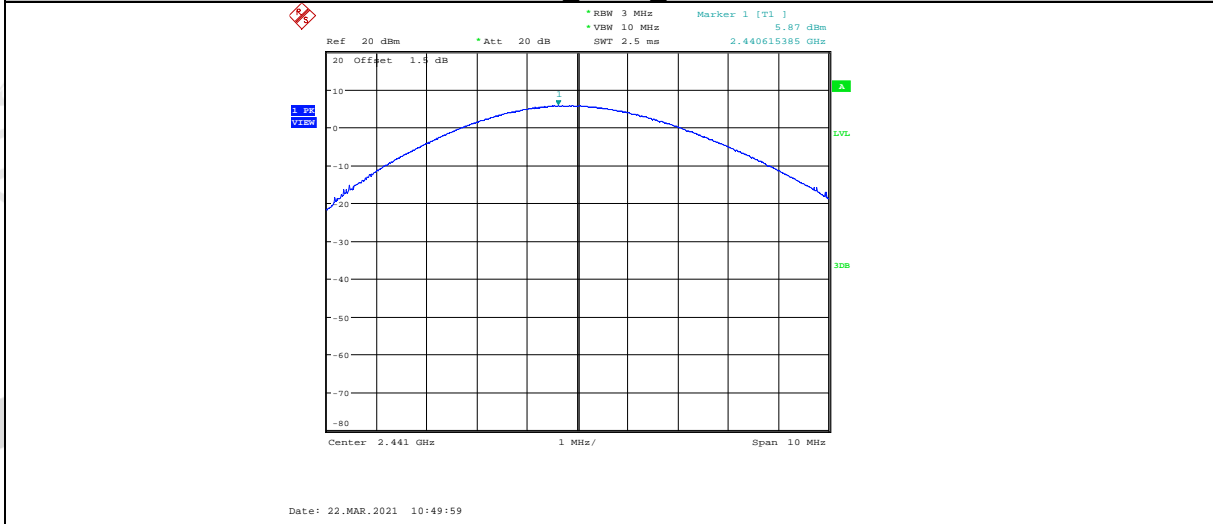

3DH5 ANT1 2480

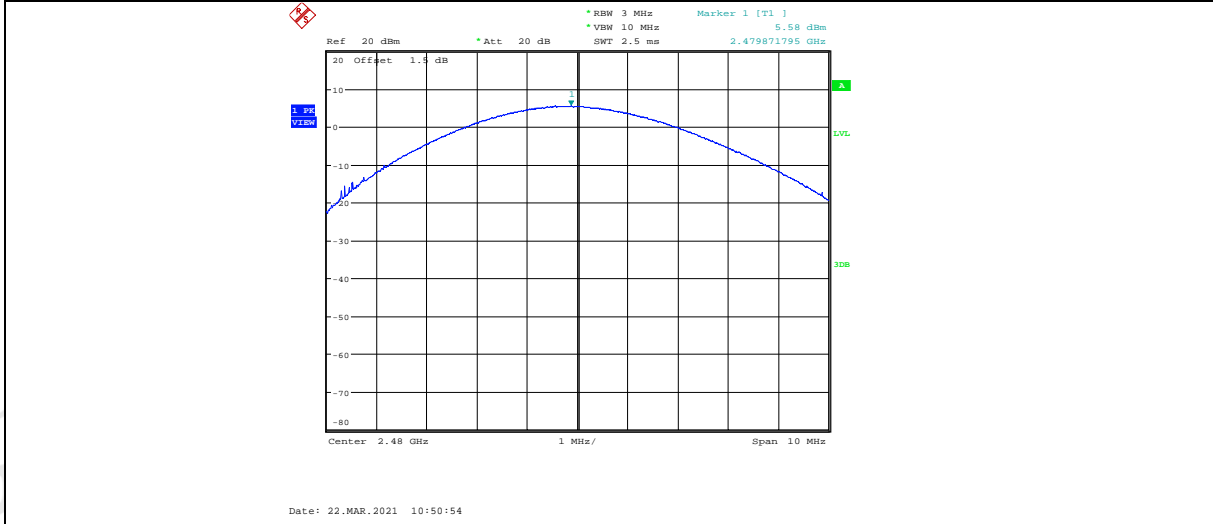

## 5. 20 dB Bandwidth and 99% Bandwidth

### 5.1. Block diagram of test setup

Same as section 4.1

### 5.2. Limits

Intentional radiators operating under the alternative provisions to the general emission limits, as contained in § 15.217 through 15.257 and in Subpart E of this part, must be designed to ensure that the 20 dB bandwidth of the emission, or whatever bandwidth may otherwise be specified in the specific rule section under which the equipment operates, is contained within the frequency band designated in the rule section under which the equipment is operated.

### 5.3. Test procedure

- (1) Connect EUT's antenna output to spectrum analyzer by RF cable.
- (2) The bandwidth of the fundamental frequency was measured by spectrum analyzer with 30 kHz RBW and 100 kHz VBW. The 20 dB bandwidth is defined as the total spectrum the power of which is higher than peak power minus 20 dB.

### 5.4. Test result

Mode	Freq. (MHz)	20 dB bandwidth Result (MHz)	99% bandwidth Result (MHz)	Verdict
GFSK	2402	1.016	0.900	Pass
	2441	1.026	0.902	Pass
	2480	1.026	0.902	Pass
$\pi/4$ -DQPSK	2402	1.368	1.202	Pass
	2441	1.362	1.200	Pass
	2480	1.362	1.194	Pass
8DPSK	2402	1.350	1.206	Pass
	2441	1.346	1.208	Pass
	2480	1.344	1.194	Pass



### 5.5. Original test data

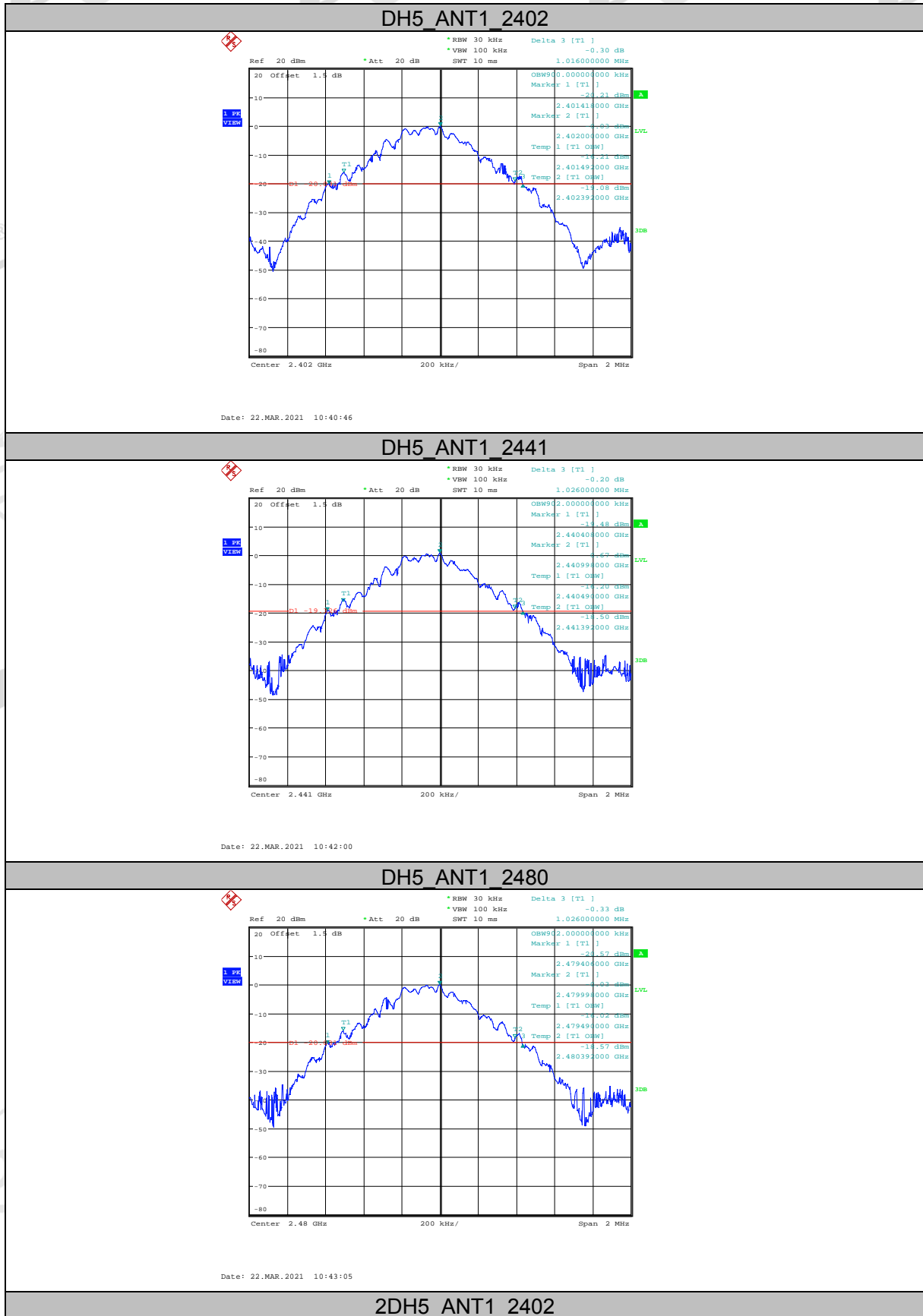

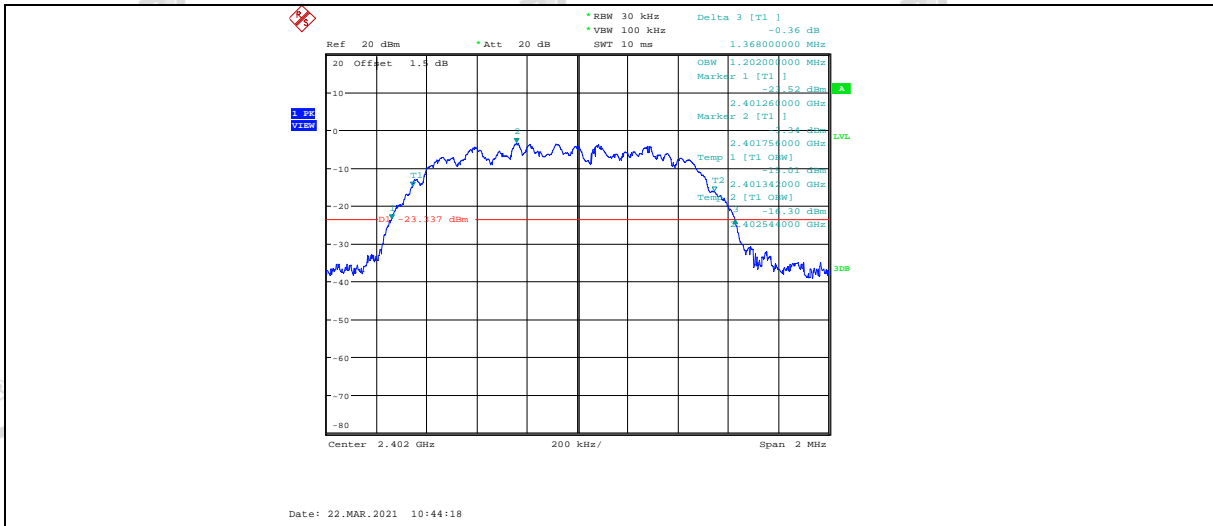

2DH5 ANT1\_2441

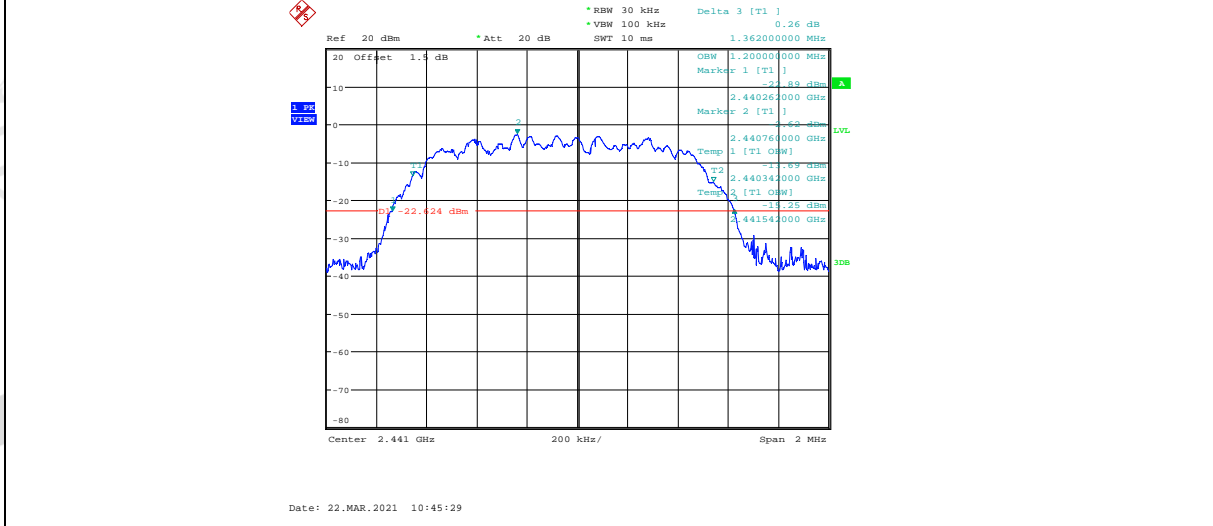

2DH5 ANT1\_2480

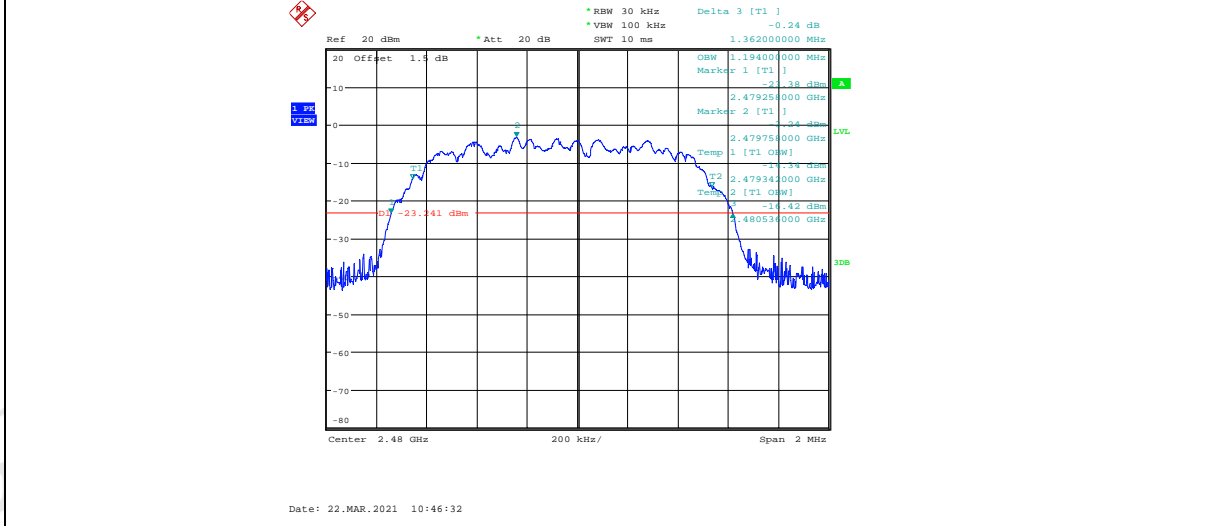

3DH5 ANT1\_2402

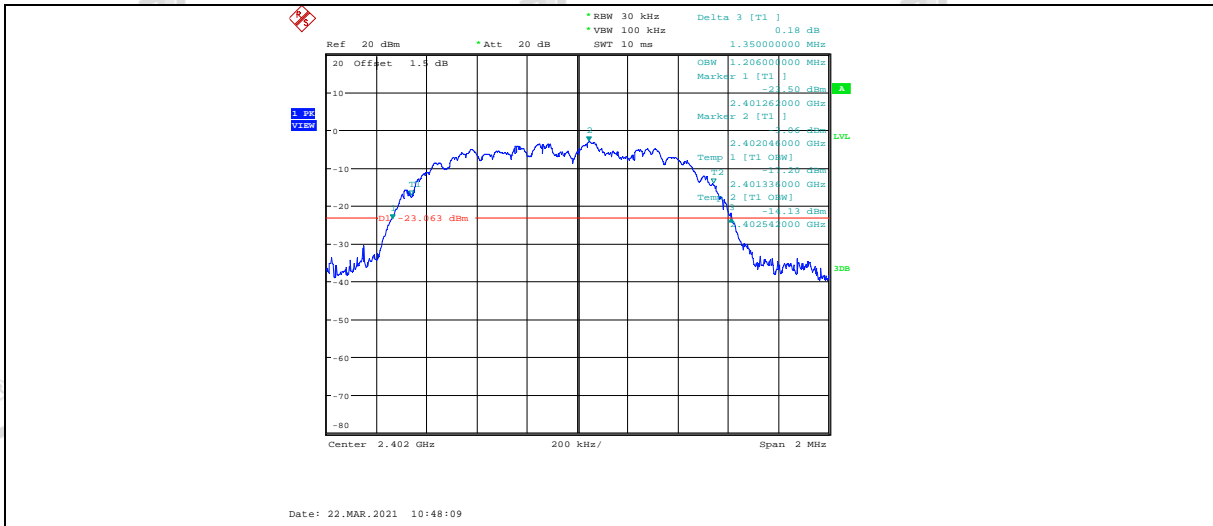

3DH5 ANT1 2441

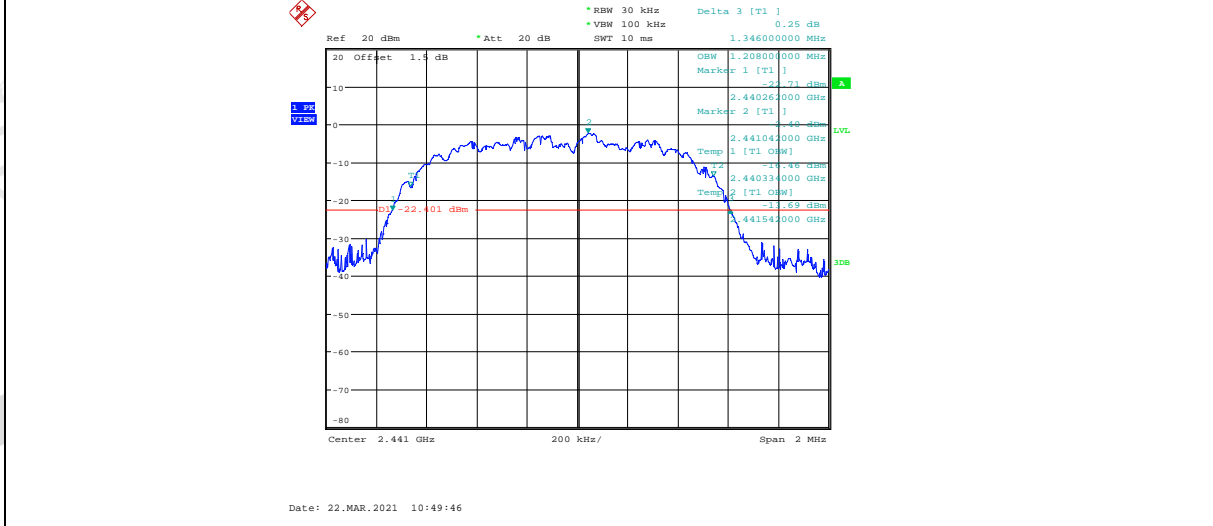

3DH5 ANT1 2480

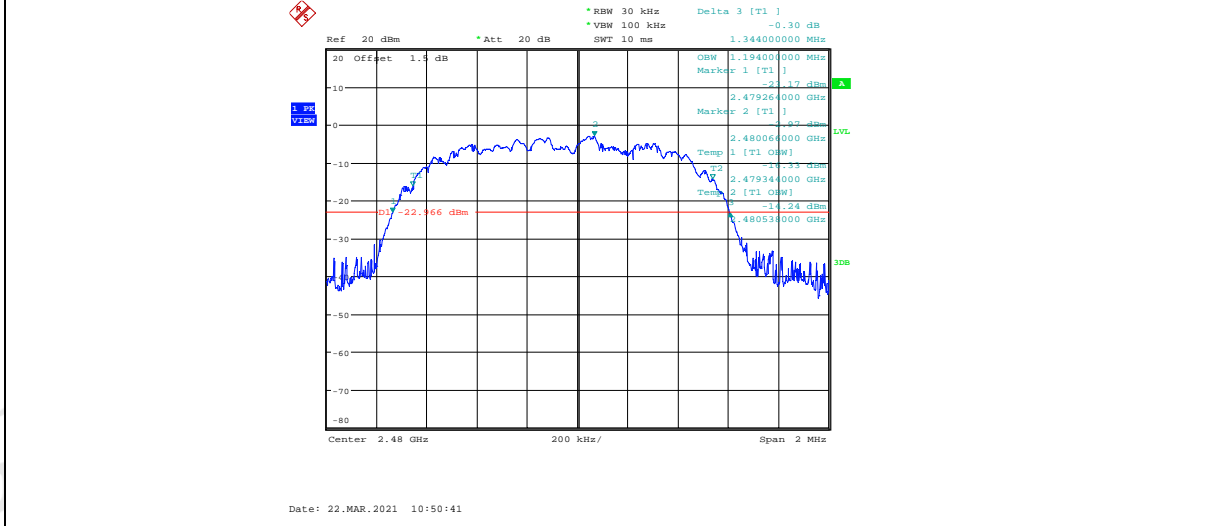

## 6. Carrier Frequency Separation

### 6.1. Block diagram of test setup

Same as section 4.1

### 6.2. Limits

Frequency hopping systems shall have hopping channel carrier frequencies separated by a minimum of 25 kHz or the 20 dB bandwidth of the hopping channel, whichever is greater.

Alternatively, frequency hopping systems operating in the 2400-2483.5 MHz band may have hopping channel carrier frequencies that are separated by 25 kHz or two-thirds of the 20 dB bandwidth of the hopping channel, whichever is greater, provided the systems operate with an output power no greater than 125 mW.

### 6.3. Test procedure

- (1) Connect EUT's antenna output to spectrum analyzer by RF cable.
- (2) The carrier frequency was measured by spectrum analyzer with 100 kHz RBW and 300 kHz VBW.

### 6.4. Test result

Mode	Channel separation (MHz)	20 dB bandwidth (MHz) (worse case)	Limit (MHz) 2/3 of 20 dB bandwidth	Verdict
GFSK	1.000	1.026	≥0.684	Pass
$\pi/4$ -DQPSK	1.010	1.368	≥0.912	Pass
8DPSK	1.003	1.350	≥0.900	Pass

### 6.5. Original test data

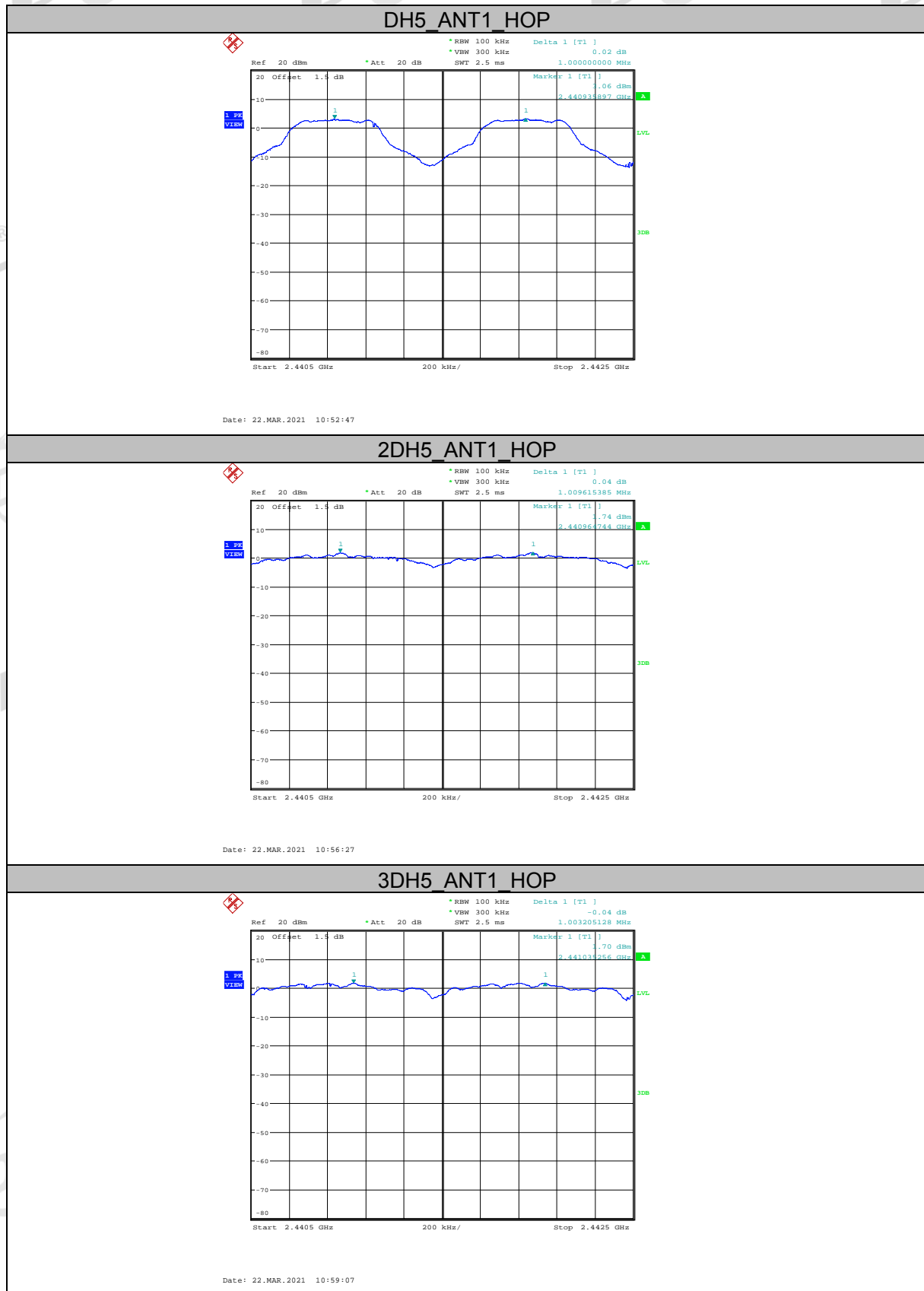

## 7. Number of Hopping Channel

### 7.1. Block diagram of test setup

Same as section 4.1

### 7.2. Limits

Frequency hopping systems in the 2400-2483.5 MHz band shall use at least 15 channels.

### 7.3. Test procedure

- (1) Connect EUT's antenna output to spectrum analyzer by RF cable.
- (2) The number of hopping channels was measured by spectrum analyzer with 100 kHz RBW and 300 kHz VBW.

### 7.4. Test result

Mode	Number of hopping channels	Limit	Verdict
GFSK	79	>15	Pass
$\pi/4$ -DQPSK	79	>15	Pass
8DPSK	79	>15	Pass

### 7.5. Original test data

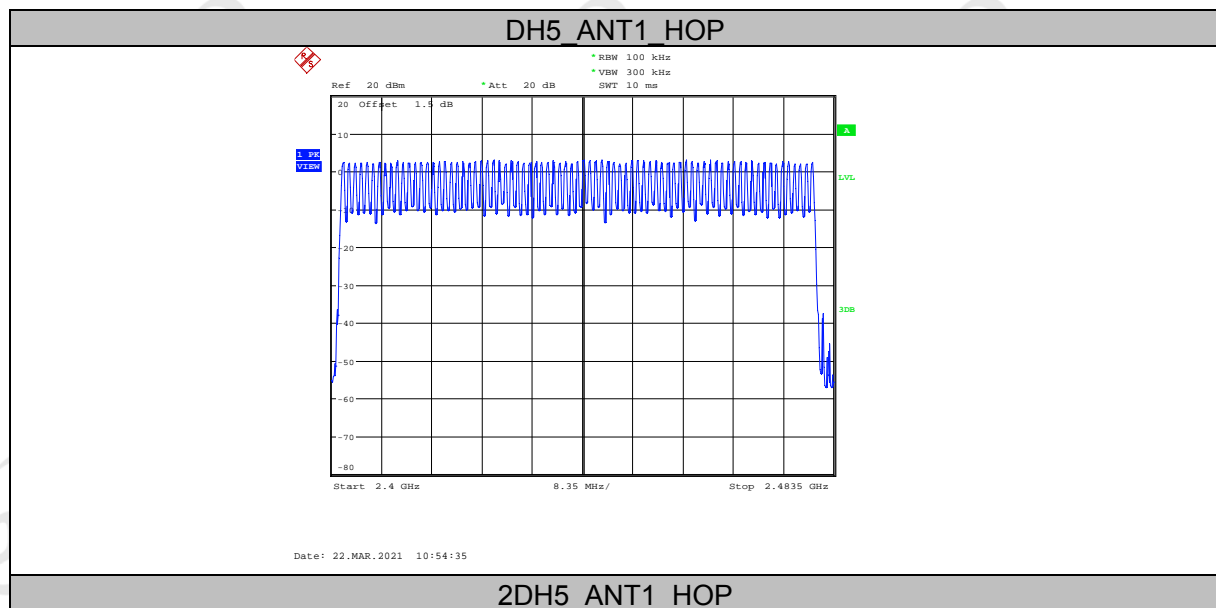

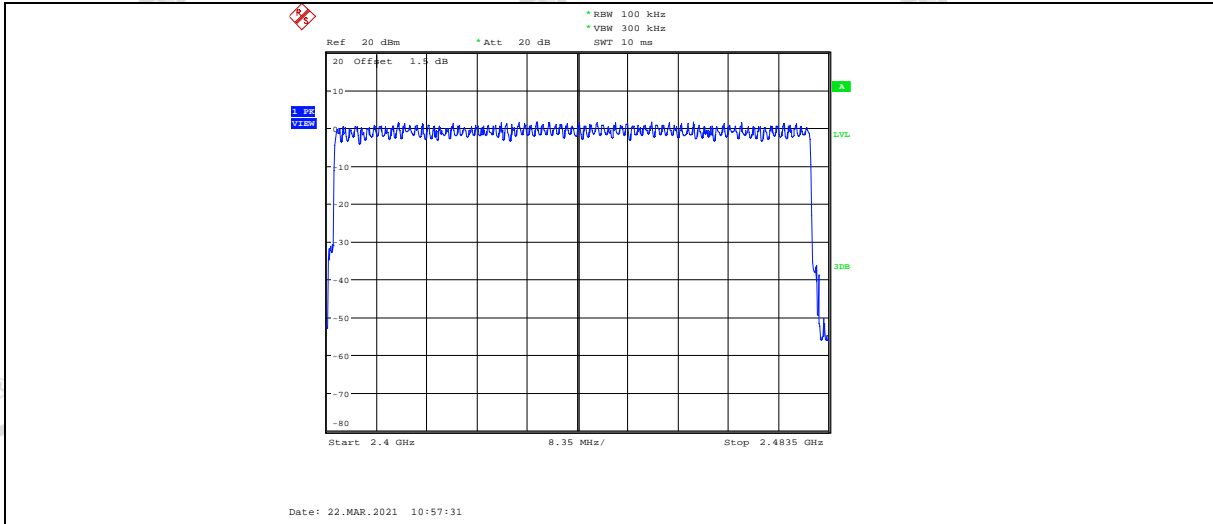

3DH5 ANT1 HOP

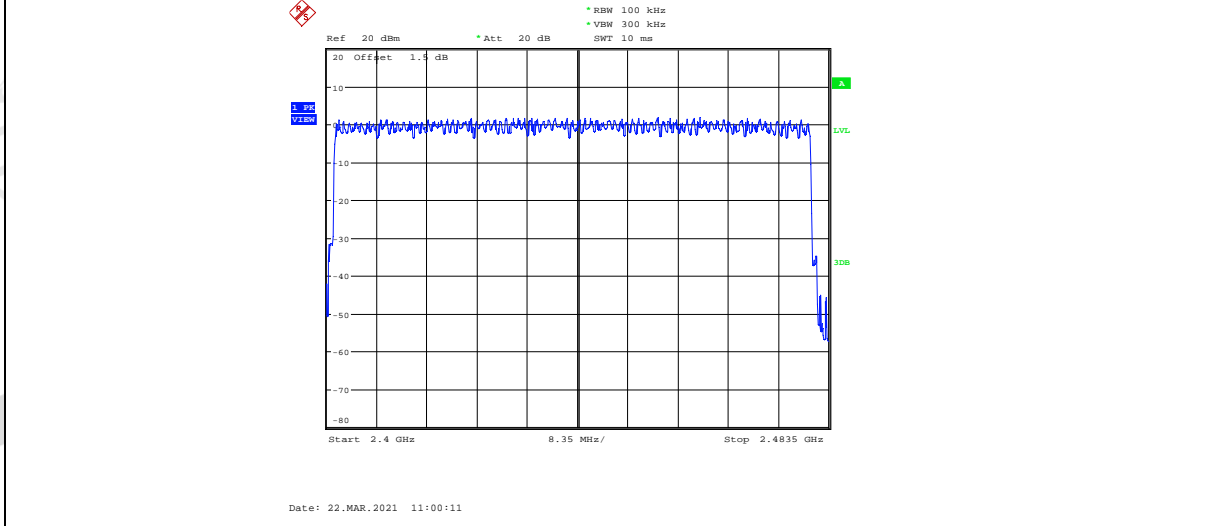

## 8. Dwell Time

### 8.1. Block diagram of test setup

Same as section 4.1

### 8.2. Limits

The average time of occupancy on any channel shall not be greater than 0.4 seconds within a period of 0.4 seconds multiplied by the number of hopping channels employed.

### 8.3. Test procedure

- (1) Connect EUT's antenna output to spectrum analyzer by RF cable.
- (2) The test period:  $T = 0.4 \text{ Second/Channel} \times 79 \text{ Channel} = 31.6 \text{ s}$
- (3) Measure the hopping number and on time of each pulse with spectrum analyzer in zero span set, and calculate dwell time with formula  $\text{Dwell time} = \text{total hops} \times \text{pulse's on time}$ .

### 8.4. Test result

Mode	Dwell time (s)	Pulse's on time (ms)	Total hops	Limit	Verdict
DH1	0.112	0.36	310	<400ms	Pass
DH3	0.251	1.63	154	<400ms	Pass
DH5	0.304	2.92	104	<400ms	Pass
2DH1	0.117	0.38	309	<400ms	Pass
2DH3	0.253	1.63	155	<400ms	Pass
2DH5	0.302	2.93	103	<400ms	Pass
3DH1	0.117	0.38	309	<400ms	Pass
3DH3	0.279	1.65	169	<400ms	Pass
3DH5	0.300	2.91	103	<400ms	Pass

Note:  $\text{Dwell time} = \text{total hops} \times \text{pulse's on time}$ .



### 8.5. Original test data

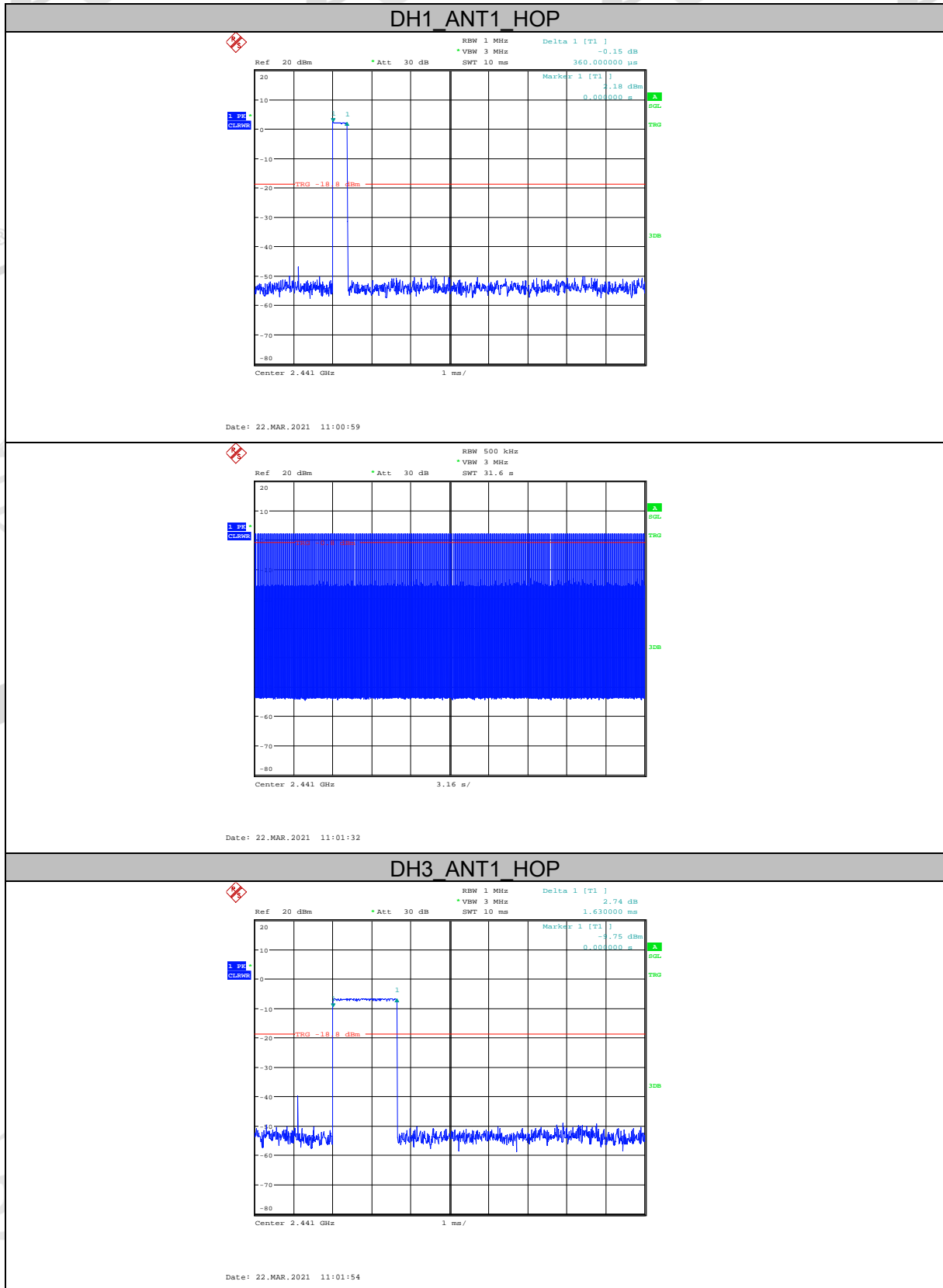

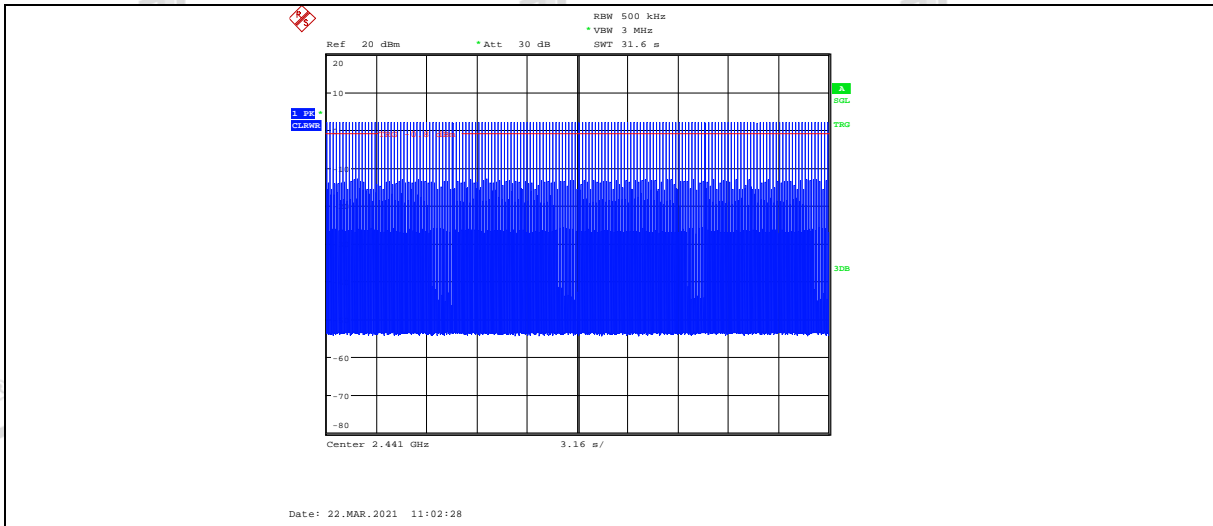

DH5 ANT1 HOP

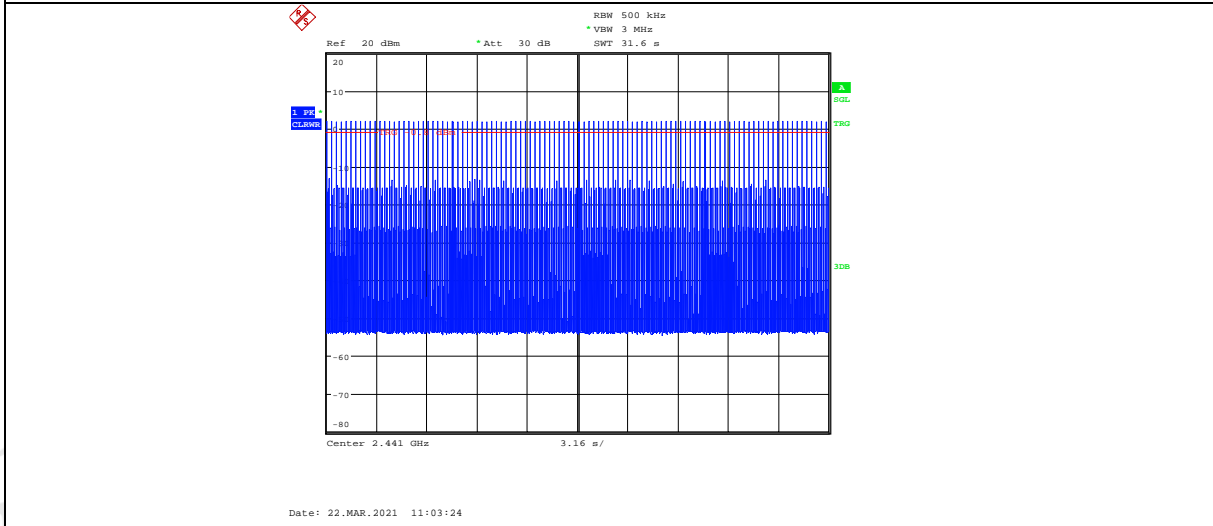
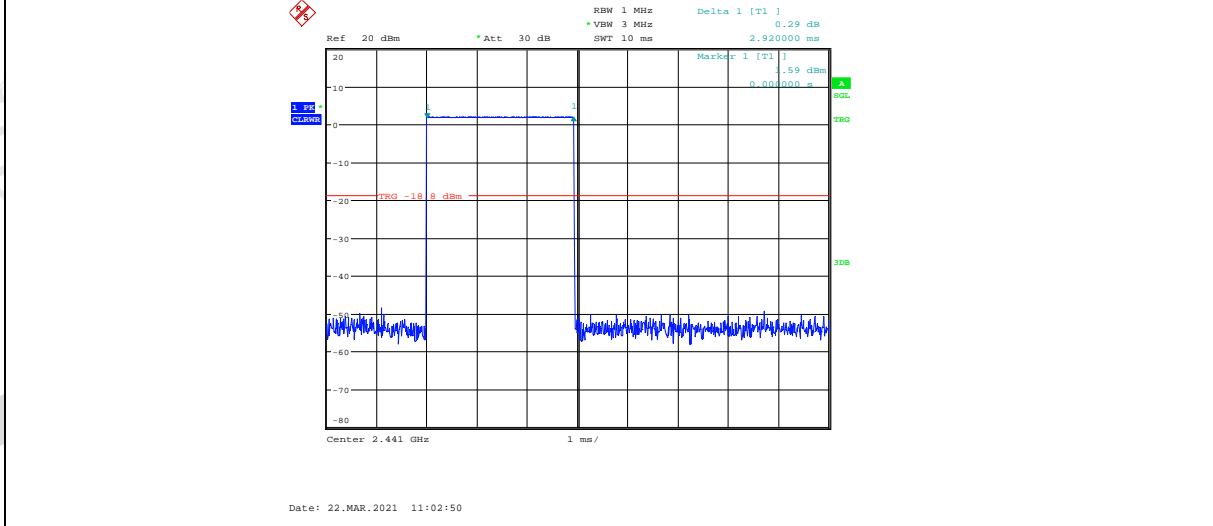

2DH1 ANT1 HOP

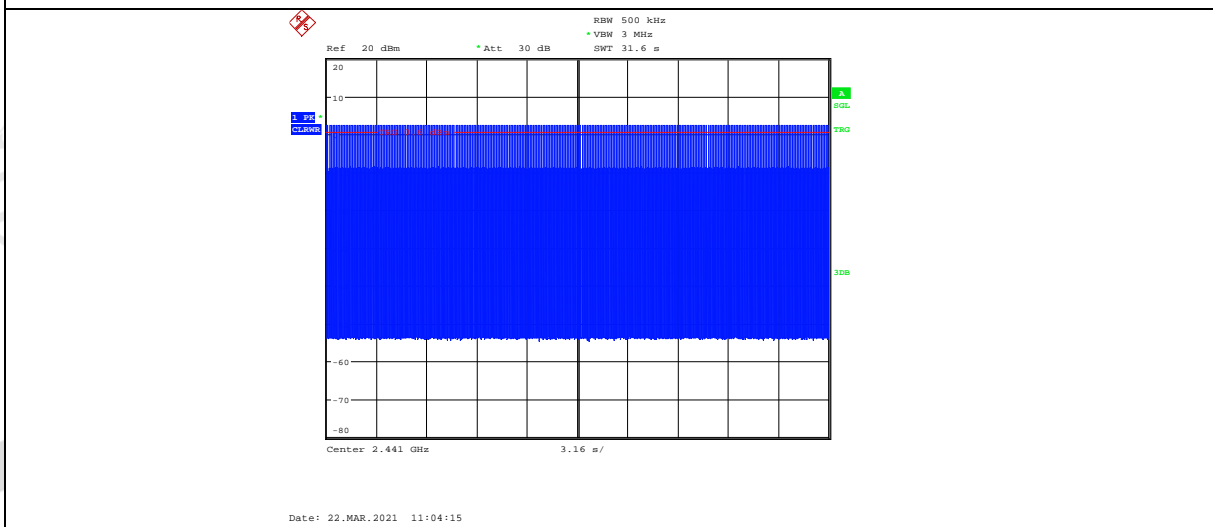
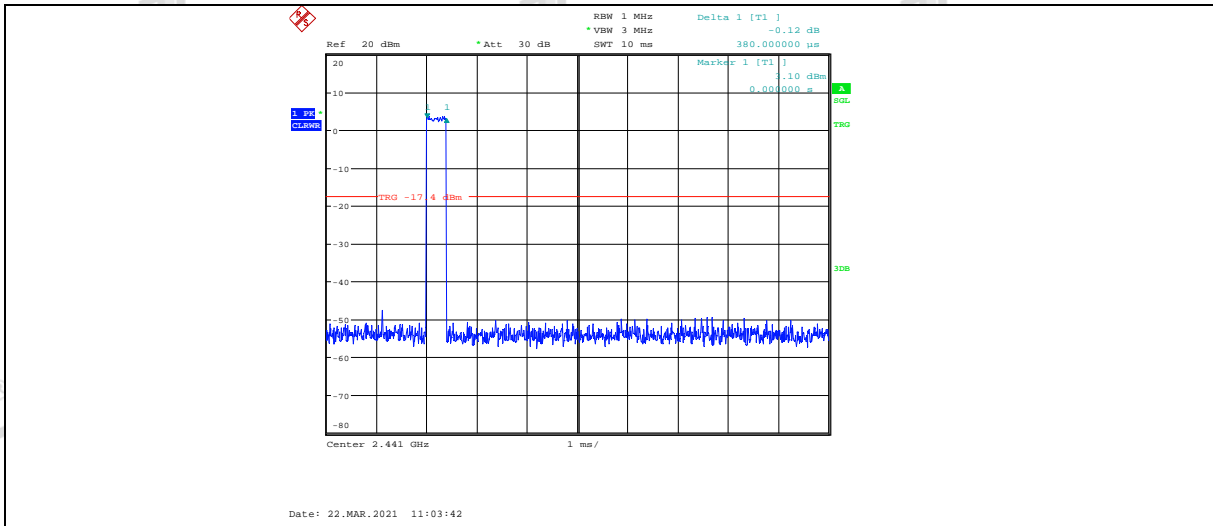

2DH3 ANT1 HOP

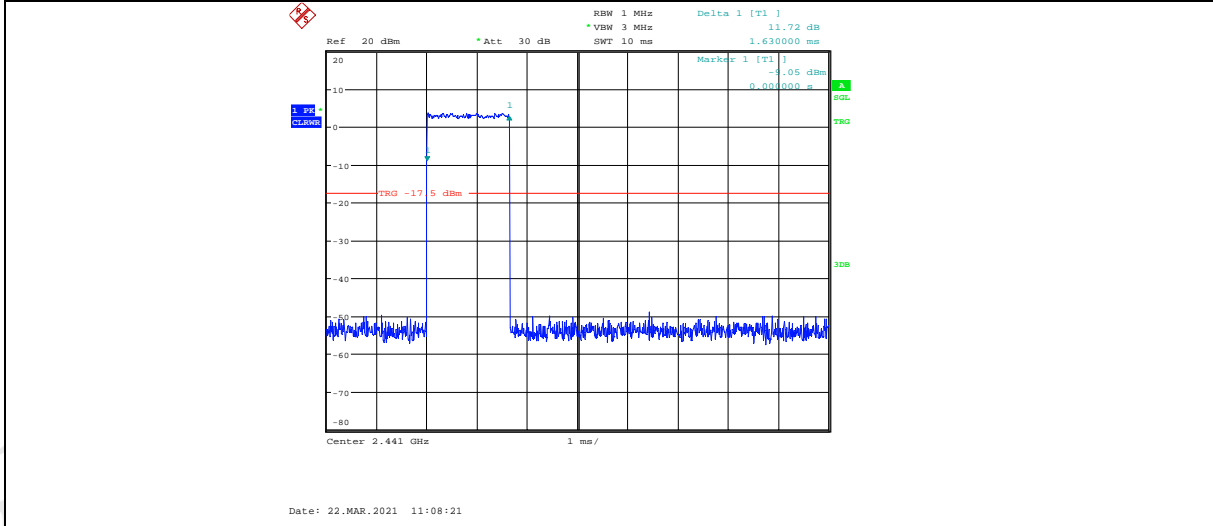

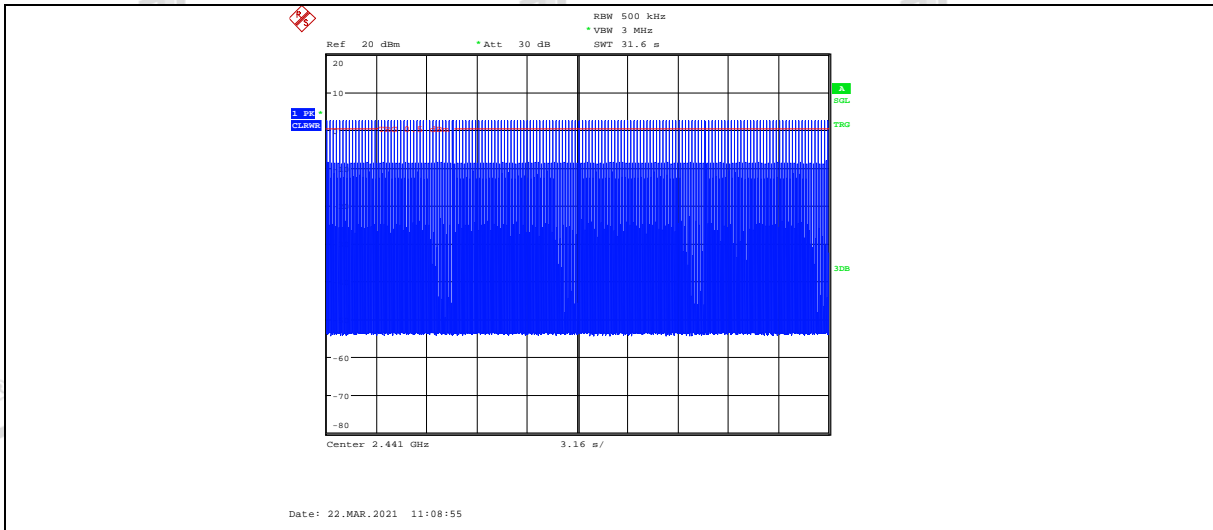

2DH5 ANT1 HOP

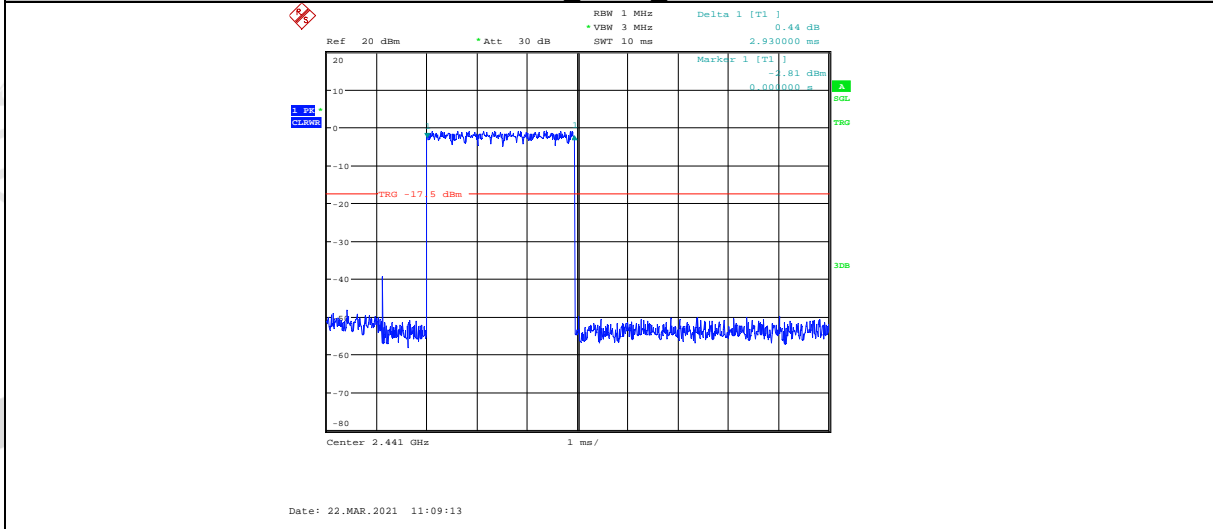

3DH1 ANT1 HOP

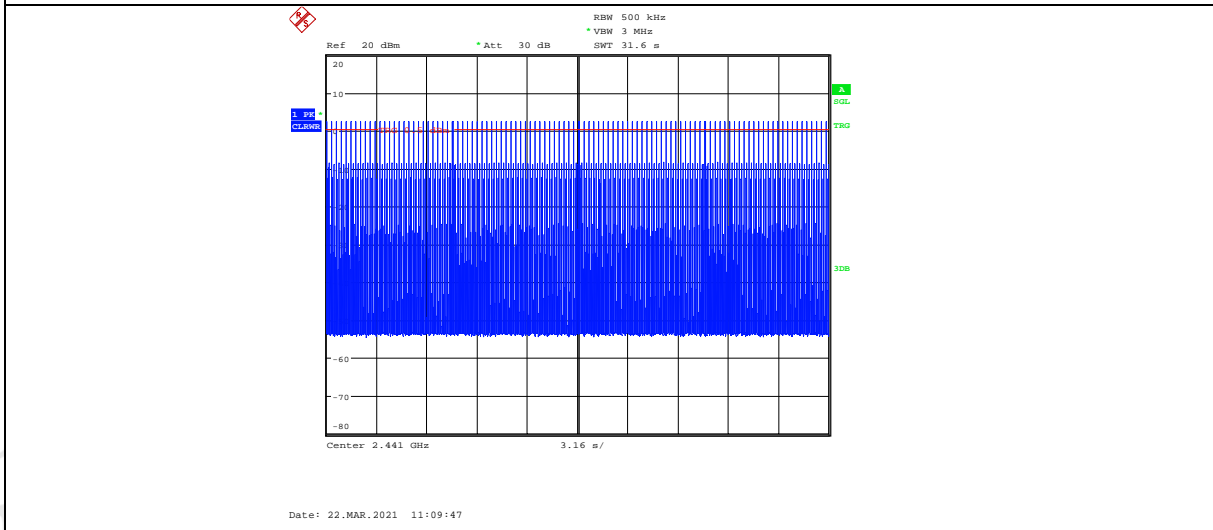

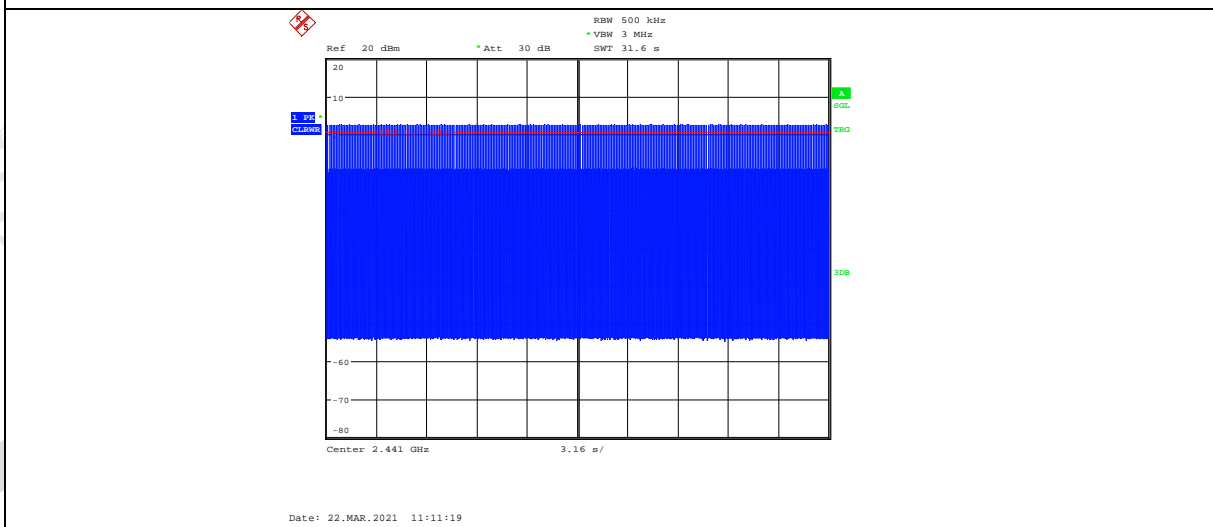
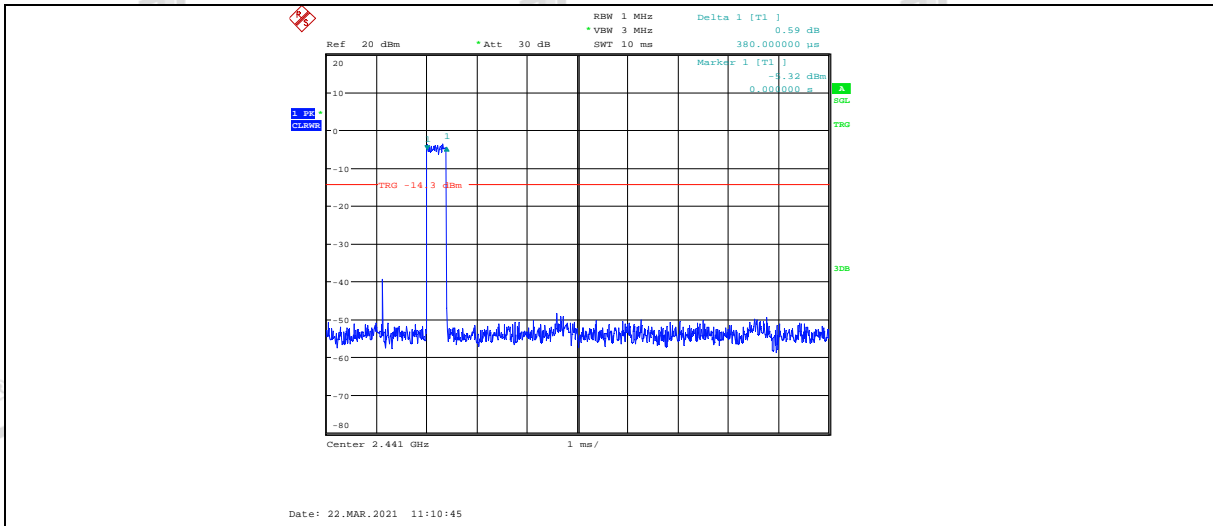

3DH3 ANT1 HOP

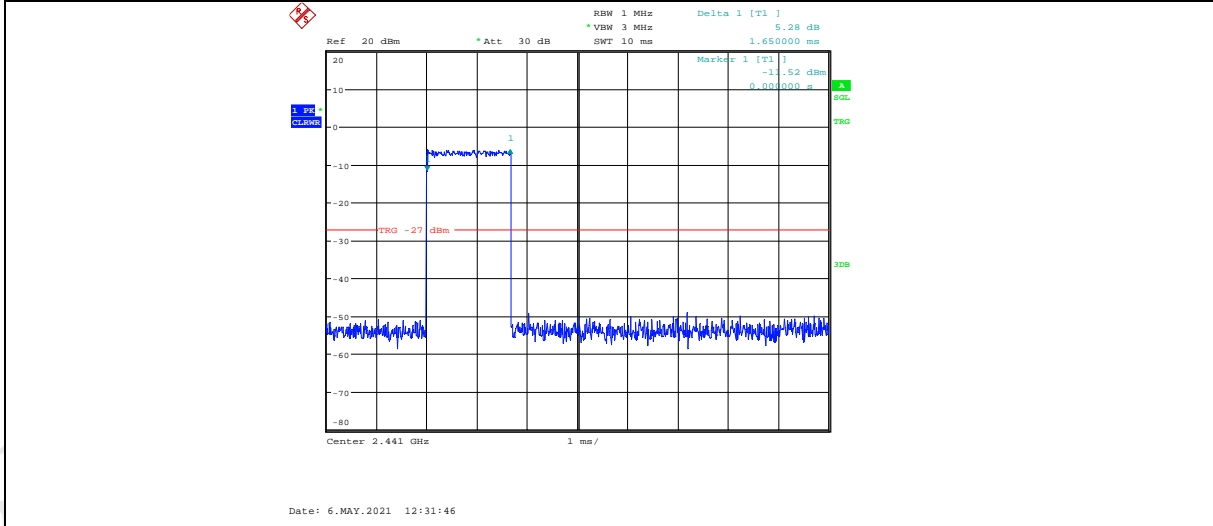

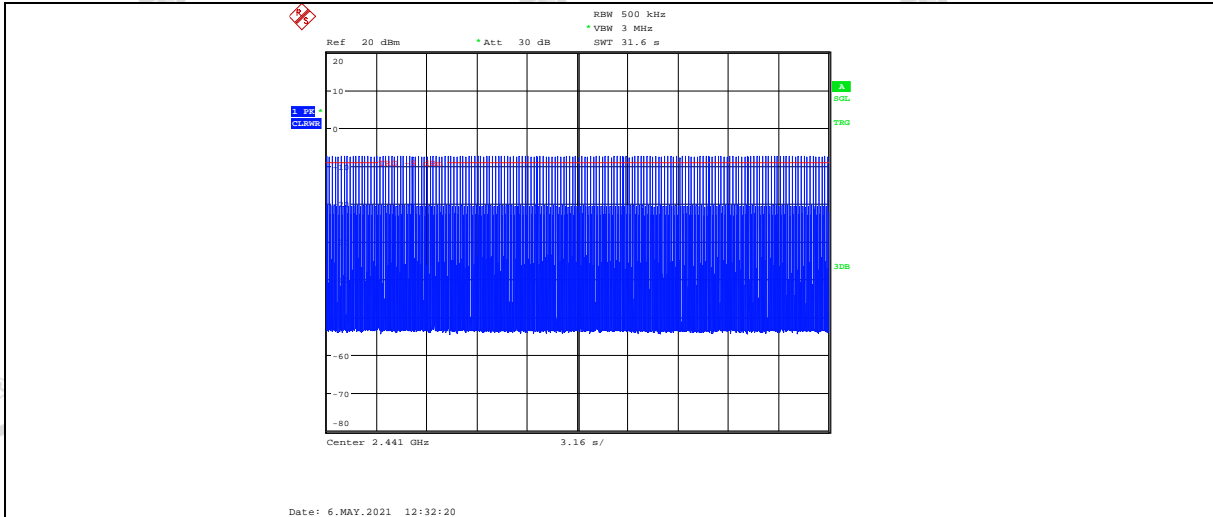

3DH5 ANT1 HOP

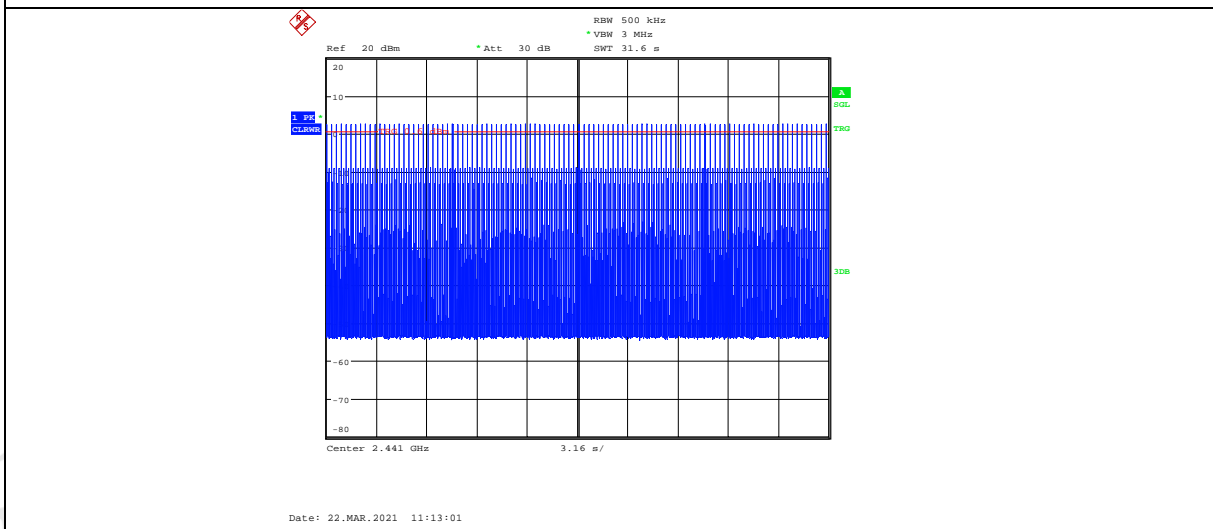
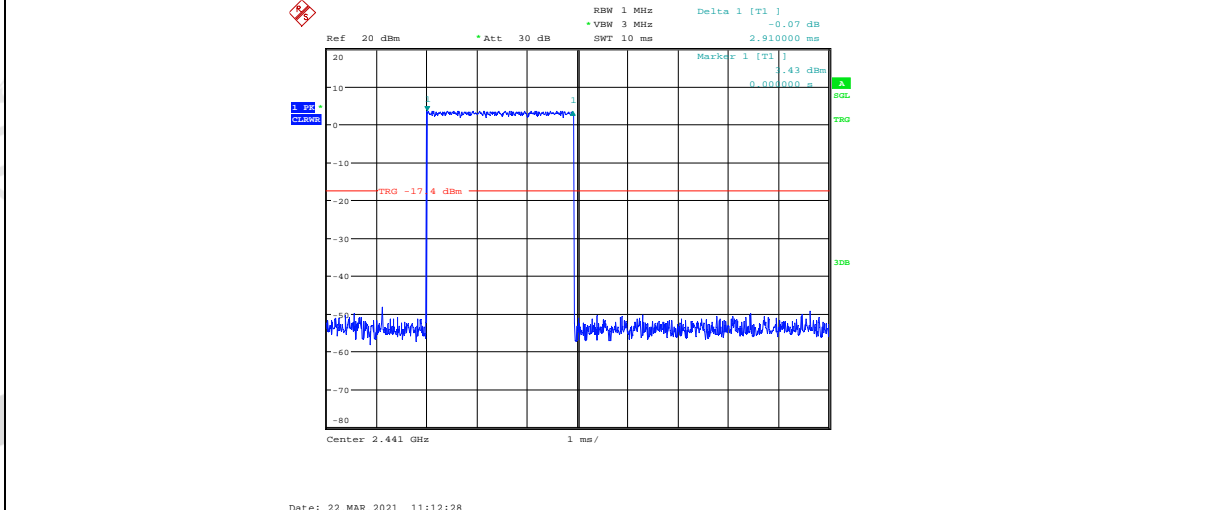

### 9. Band Edge Compliance (Conducted Method)

#### 9.1. Block diagram of test setup

Same as section 4.1

#### 9.2. Limit

All restriction band should comply with 15.209, other emission should be at least 20 dB below the fundamental.

#### 9.3. Test result

Mode	Freq. (MHz)	Verdict
GFSK	Hopping off 2402	Pass
	Hopping off 2480	Pass
	Hopping on	Pass
$\pi/4$ -DQPSK	Hopping off 2402	Pass
	Hopping off 2480	Pass
	Hopping on	Pass
8DPSK	Hopping off 2402	Pass
	Hopping off 2480	Pass
	Hopping on	Pass

#### 9.4. Original test data

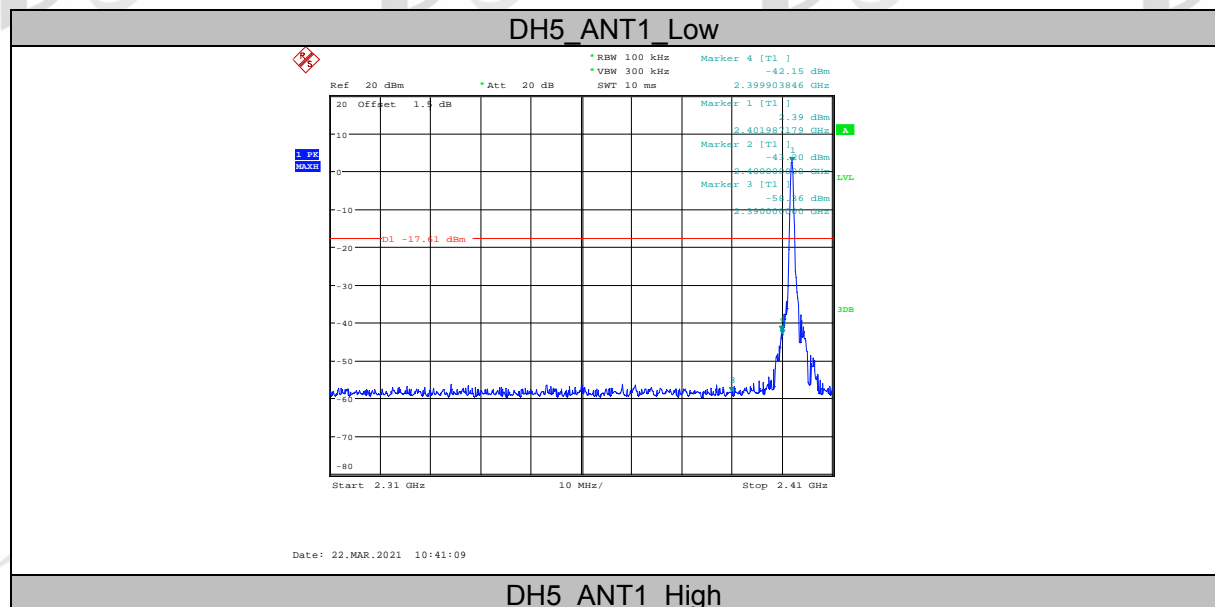

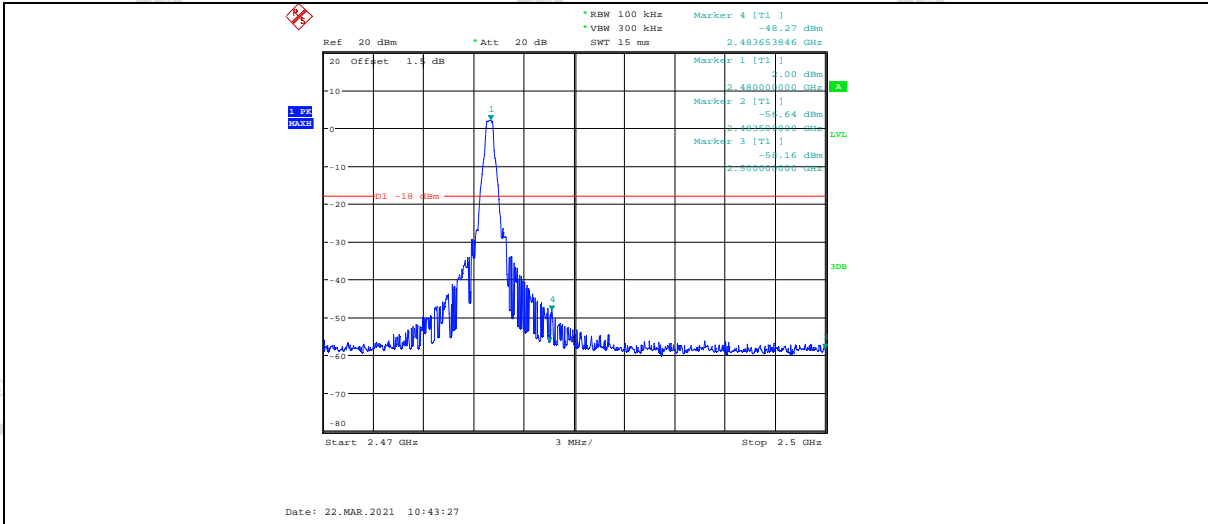

DH5\_ANT1\_Low

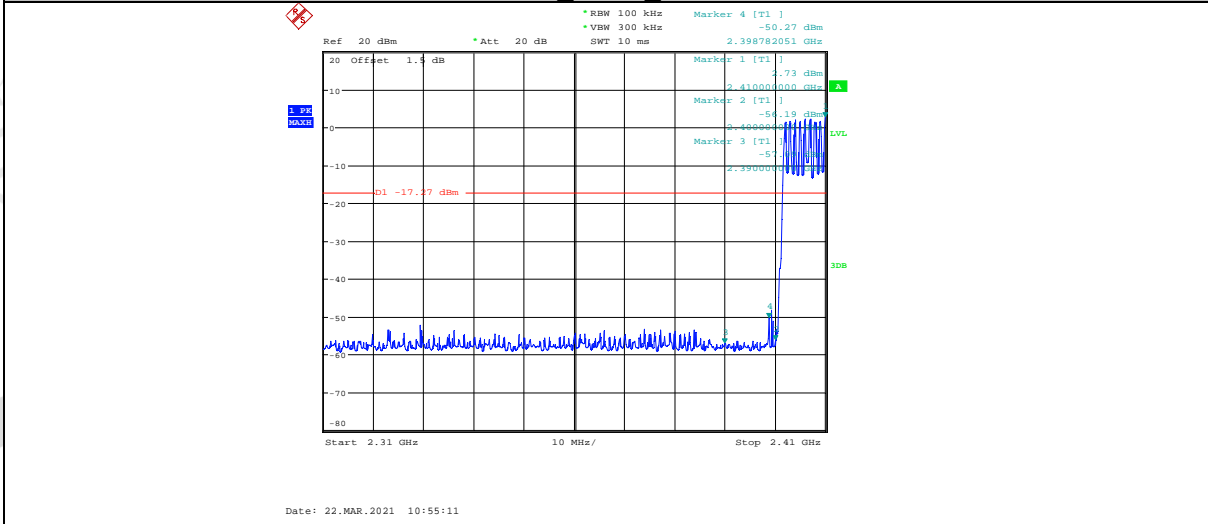

DH5\_ANT1\_High

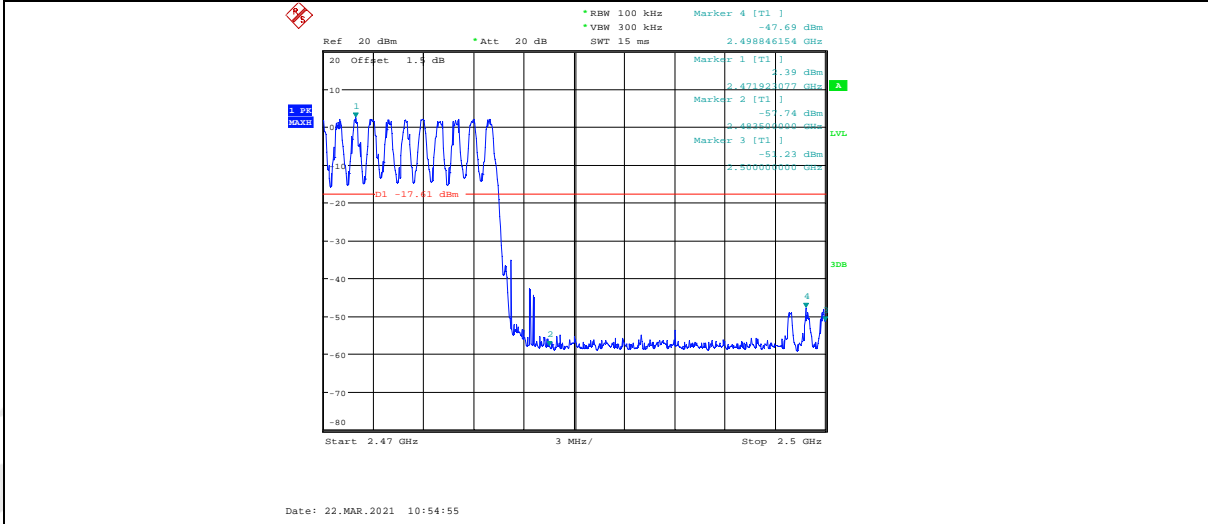

2DH5\_ANT1\_Low



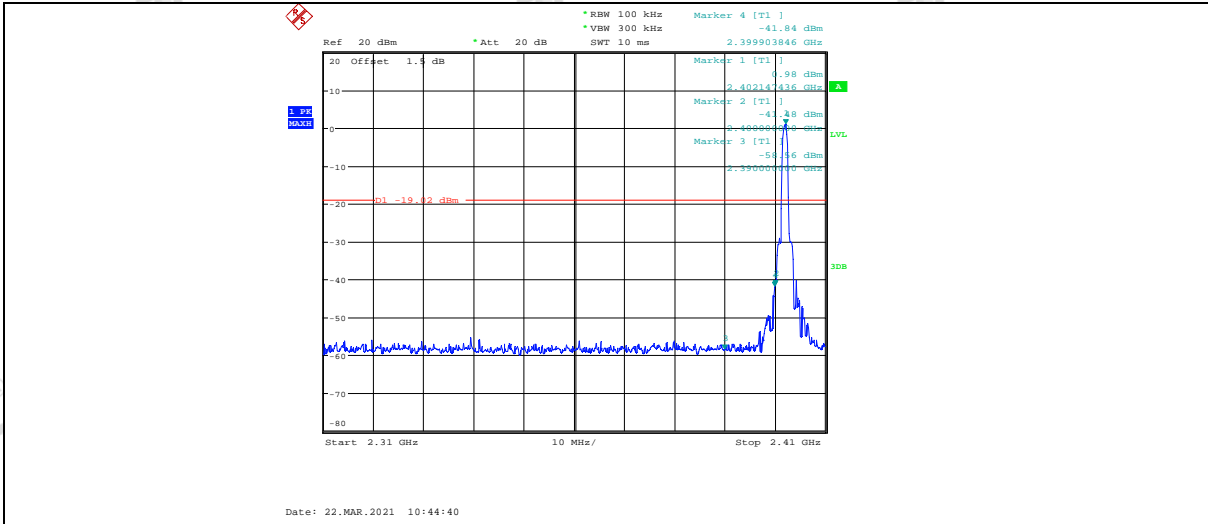

2DH5 ANT1 High

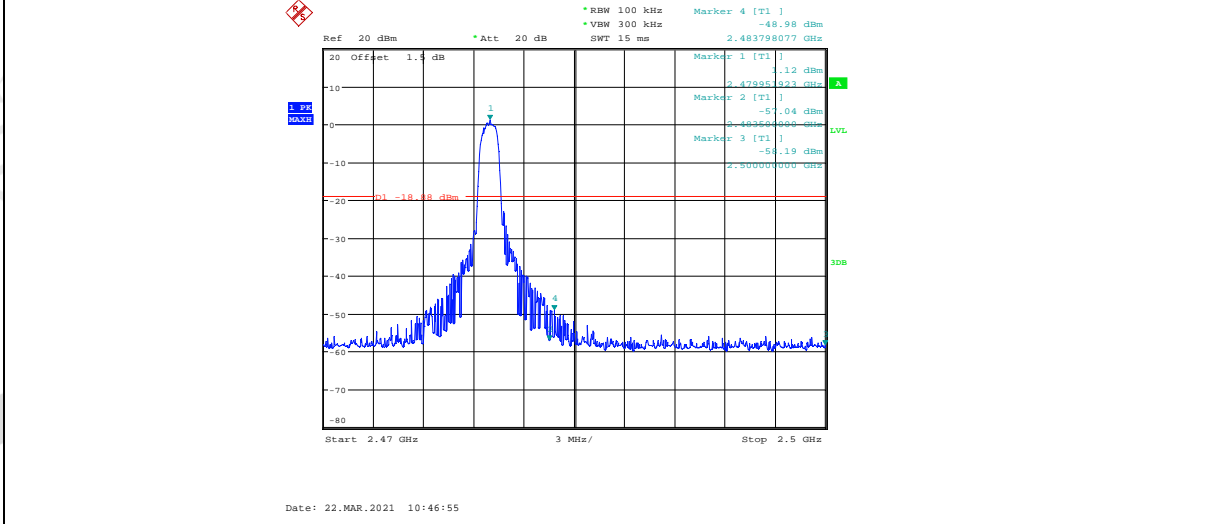

2DH5 ANT1 Low

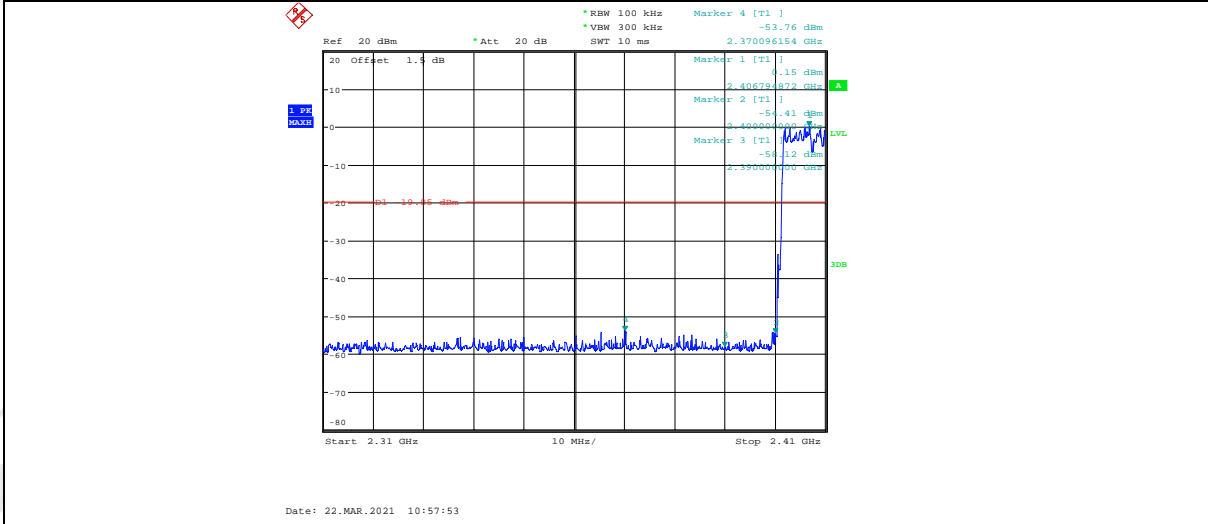

2DH5 ANT1 High

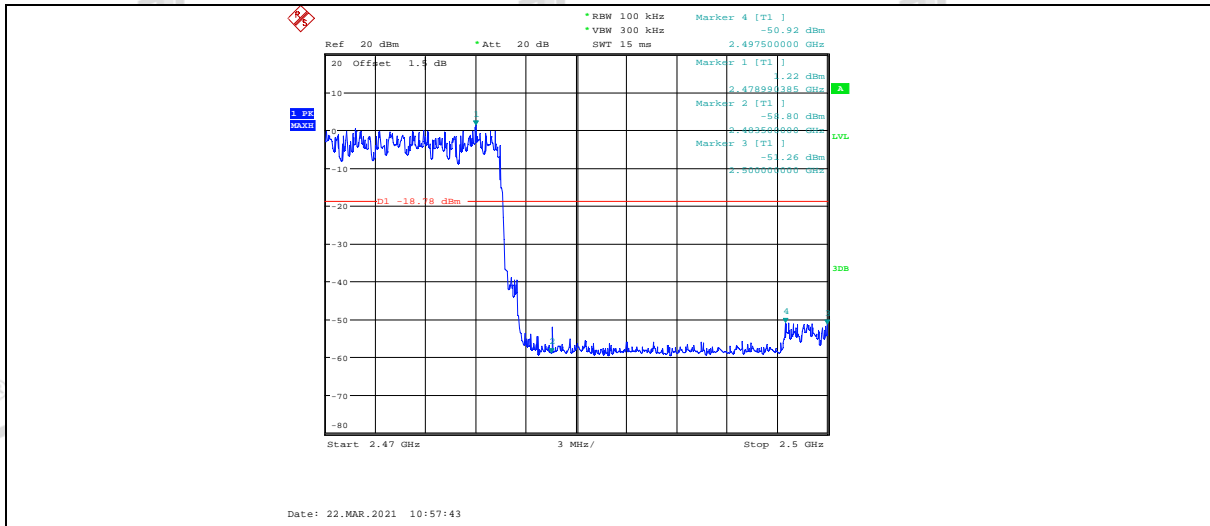

3DH5 ANT1 Low

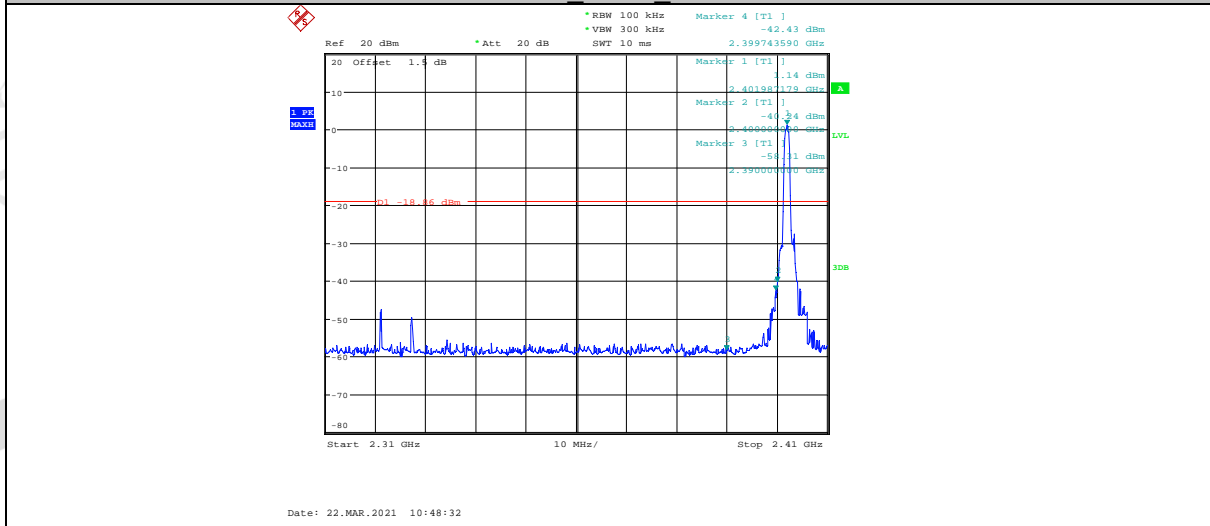

3DH5 ANT1 High

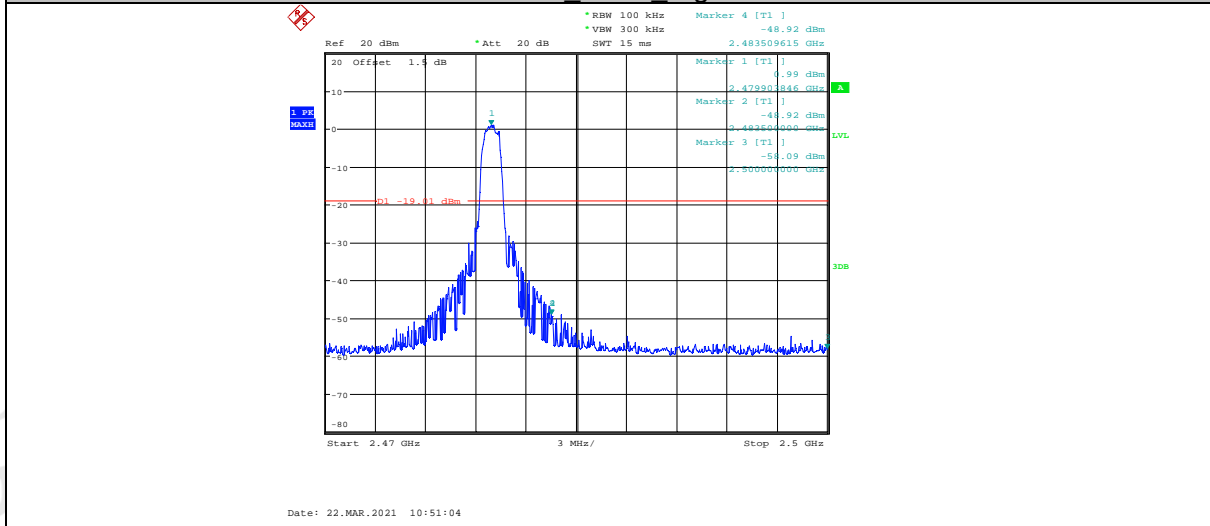

3DH5 ANT1 Low

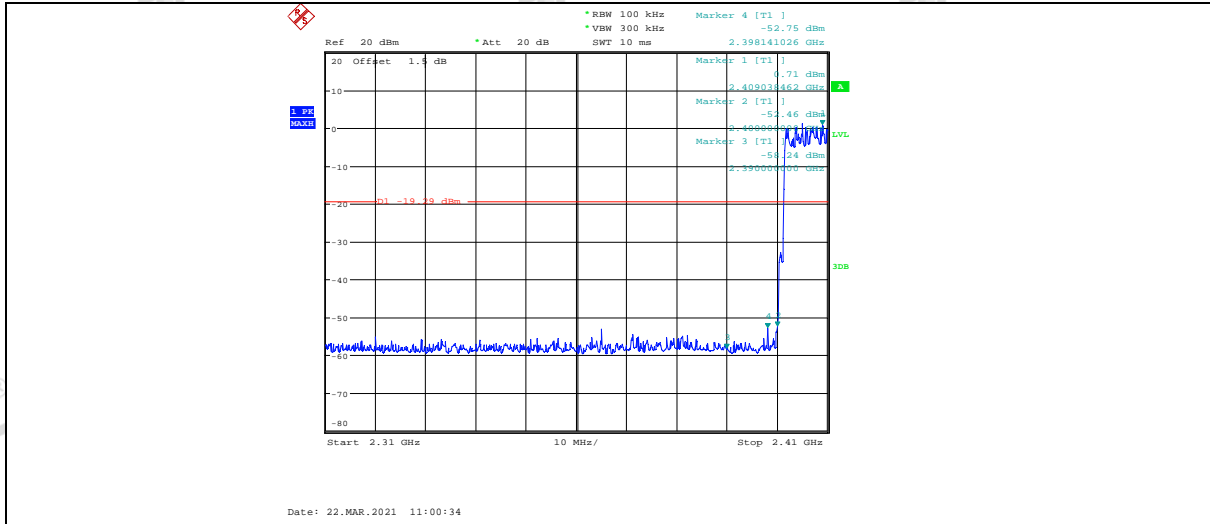

3DH5 ANT1 High

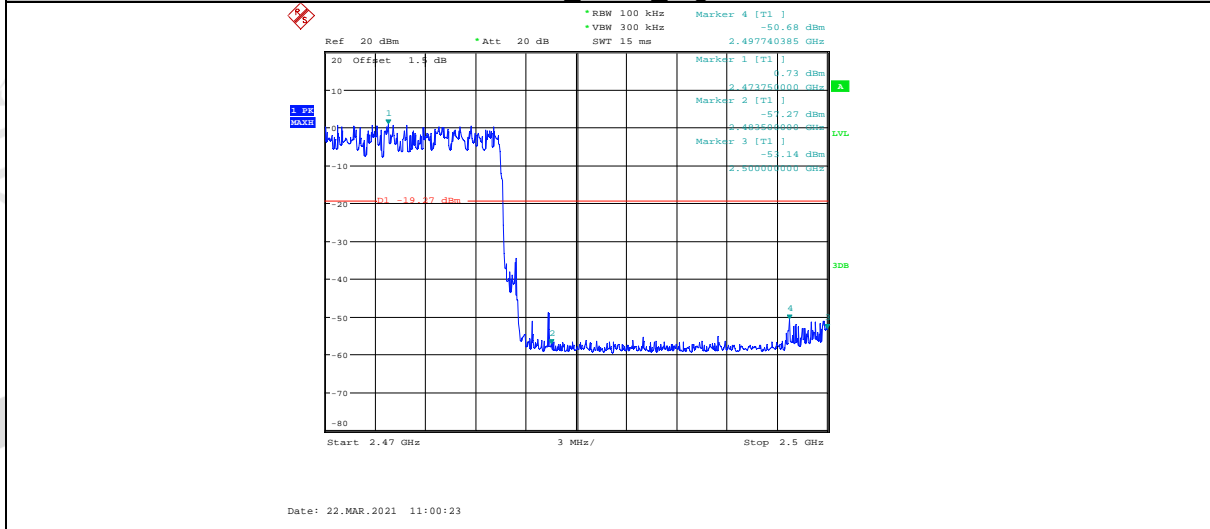

### 10. Radiated Emission

#### 10.1. Block diagram of test setup

In 3 m Anechoic Chamber, test setup diagram for 9 kHz - 30 MHz

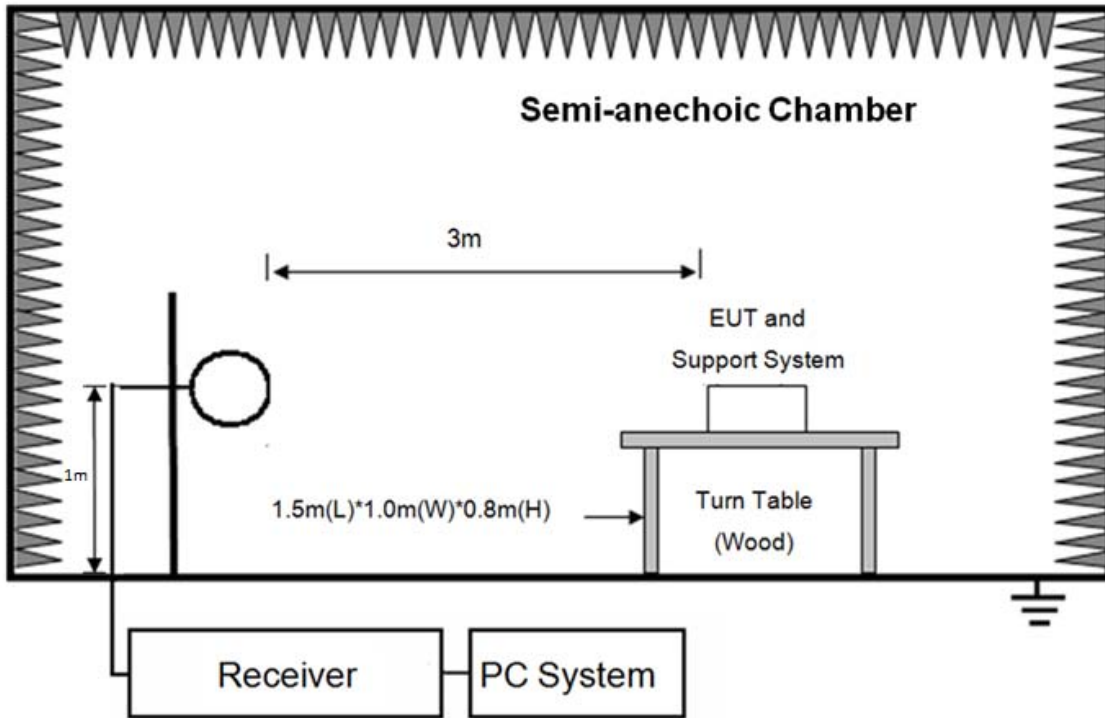

In 3 m Anechoic Chamber, test setup diagram for below 1 GHz

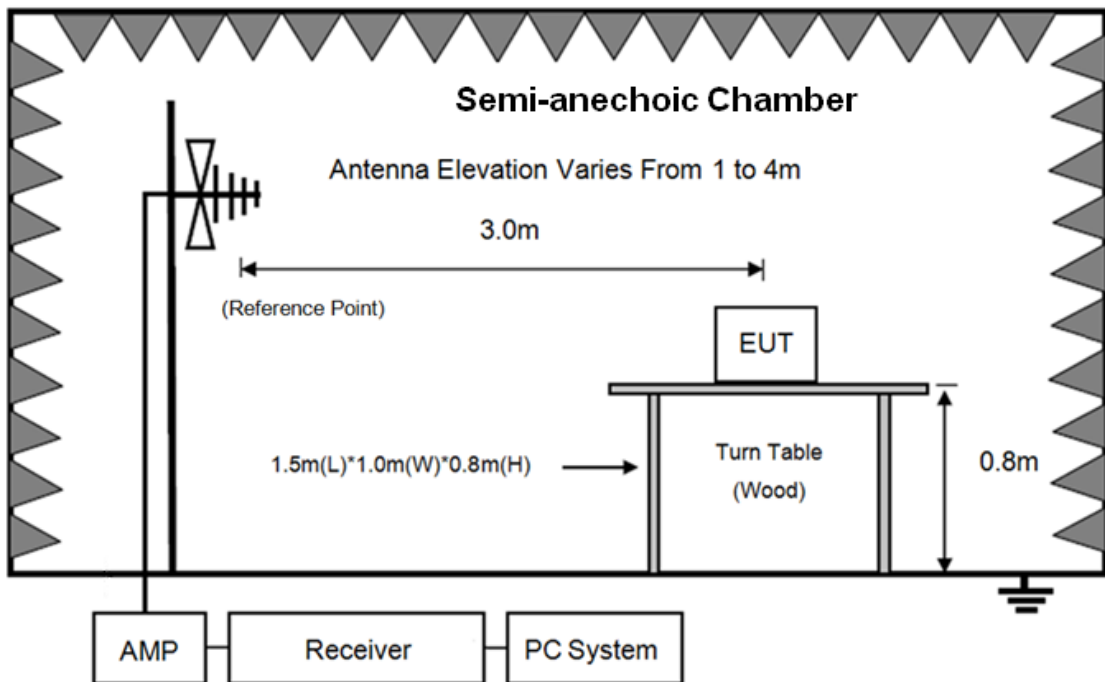

In 3 m Anechoic Chamber, test setup diagram for frequency above 1 GHz

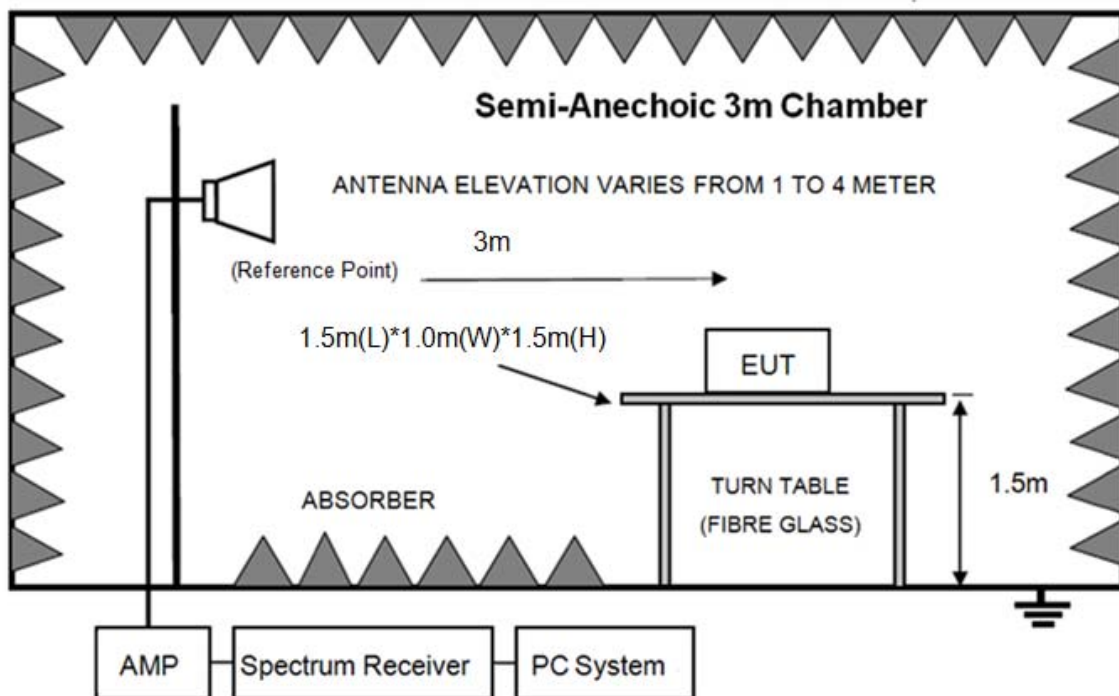

Note: For harmonic emissions test an appropriate high pass filter was inserted in the input port of AMP.

## 10.2. Limit

(1) FCC 15.205 Restricted frequency band

MHz	MHz	MHz	GHz
0.090-0.110	16.42-16.423	399.9-410	4.5-5.15
10.495-0.505	16.69475-16.69525	608-614	5.35-5.46
2.1735-2.1905	16.80425-16.80475	960-1240	7.25-7.75
4.125-4.128	25.5-25.67	1300-1427	8.025-8.5
4.1772&4.17775	37.5-38.25	1435-1626.5	9.0-9.2
4.2072&4.20775	73-74.6	1645.5-1646.5	9.3-9.5
6.215-6.218	74.8-75.2	1660-1710	10.6-12.7
6.26775-6.26825	108-121.94	1718.8-1722.2	13.25-13.4
6.31175-6.31225	123-138	2200-2300	14.47-14.5
8.291-8.294	149.9-150.05	2310-2390	15.35-16.2
8.362-8.366	156.52475-156.52525	2483.5-2500	17.7-21.4
8.37625-8.38675	156.7-156.9	2690-2900	22.01-23.12
8.41425-8.41475	162.0125-167.17	3260-3267	23.6-24.0
12.29-12.293	167.72-173.2	3332-3339	31.2-31.8
12.51975-12.52025	240-285	3345.8-3358	36.43-36.5
12.57675-12.57725	322-335.4	3600-4400	( <sup>2</sup> )
13.36-13.41			

<sup>1</sup>Until February 1, 1999, this restricted band shall be 0.490-0.510 MHz.

<sup>2</sup>Above 38.6

## (2) FCC 15.209 Limit.

Frequency (MHz)	Measurement distance (meters)	Field strength limit	
		$\mu\text{V}/\text{m}$	$\text{dB}(\mu\text{V})/\text{m}$
0.009 ~ 0.490	300	2400/F(kHz)	67.6-20log(F)
0.490 ~ 1.705	30	24000/F(kHz)	87.6-20log(F)
1.705 ~ 30.0	30	30	29.54
30 ~ 88	3	100	40.0
88 ~ 216	3	150	43.5
216 ~ 960	3	200	46.0
960 ~ 1000	3	500	54.0
Above 1000	3	74.0 dB( $\mu\text{V}$ )/m (Peak) 54.0 dB( $\mu\text{V}$ )/m (Average)	

Note: (1) The emission limits shown in the above table are based on measurements employing a CISPR QP detector except for the frequency bands 9-90 kHz, 110-490 kHz and above 1000 MHz, radiated emissions limits in these three bands are based on measurements employing an average detector.

(2) At frequencies below 30 MHz, measurement may be performed at a distance closer than that specified, and the limit at closer measurement distance can be extrapolated by below formula:

$$\text{Limit}_{3\text{m}}(\text{dB}\mu\text{V}/\text{m}) = \text{Limit}_{30\text{m}}(\text{dB}\mu\text{V}/\text{m}) + 40\text{Log}(30\text{m}/3\text{m})$$

## (3) Limit for this EUT

All the emissions appearing within 15.205 restricted frequency bands shall not exceed the limits shown in 15.209, all the other emissions shall be at least 20 dB below the fundamental emissions or comply with 15.209 limits.

**10.3. Test procedure**

- (1) EUT was placed on a non-metallic table, 80 cm above the ground plane inside a semi-anechoic chamber for below 1 G and 150 cm above the ground plane inside a semi-anechoic chamber for above 1 G.
- (2) Test antenna was located 3 m from the EUT on an adjustable mast, and the antenna used as below table.

Test frequency range	Test antenna used	Test antenna distance
9 kHz - 30 MHz	Active Loop antenna	3 m
30 MHz - 1 GHz	Trilog Broadband Antenna	3 m
1 GHz - 18 GHz	Double Ridged Horn Antenna (1 GHz - 18 GHz)	3 m
18 GHz - 40 GHz	Horn Antenna (18 GHz - 40 GHz)	1 m

According ANSI C63.10:2013 clause 6.4.4.2 and 6.5.3, for measurements below 30 MHz, the loop antenna was positioned with its plane vertical from the EUT and rotated about its vertical

axis for maximum response at each azimuth position around the EUT. And the loop antenna also is positioned with its plane horizontal at the specified distance from the EUT. The center of the loop is 1 m above the ground. For measurement above 30 MHz, the trilog Broadband Antenna or Horn Antenna was located 3 m from EUT, Measurements were made with the antenna positioned in both the horizontal and vertical planes of Polarization, and the measurement antenna was varied from 1 m to 4 m. in height above the reference ground plane to obtain the maximum signal strength.

(3) Below pre-scan procedure was first performed in order to find prominent frequency spectrum radiated emissions from 9 kHz to 25 GHz:

(a) Scanning the peak frequency spectrum with the antenna specified in step (3), and the EUT was rotated 360 degree, the antenna height was varied from 1 m to 4 m (Except loop antenna, it's fixed 1 m above ground.)

(b) Change work frequency or channel of device if practicable.

(c) Change modulation type of device if practicable.

(d) Change power supply range from 85% to 115% of the rated supply voltage

(e) Rotated EUT though three orthogonal axes to determine the attitude of EUT arrangement produces highest emissions.

Spectrum frequency from 9 kHz to 25 GHz (tenth harmonic of fundamental frequency) was investigated, and no any obvious emission were detected from 18 GHz to 25 GHz, so below final test was performed with frequency range from 9 kHz to 18 GHz.

(4) For final emissions measurements at each frequency of interest, the EUT was rotated and the antenna height was varied between 1 m and 4 m in order to maximize the emission.

Measurements in both horizontal and vertical polarities were made and the data was recorded.

In order to find the maximum emission, the relative positions of equipment and all of the interface cables were changed according to ANSI C63.10:2013 on Radiated Emission test.

(5) The emissions from 9 kHz to 1 GHz were measured based on CISPR QP detector except for the frequency bands 9-90 kHz, 110-490 kHz, for emissions from 9 kHz - 90 kHz, 110 kHz - 490 kHz and above 1 GHz were measured based on average detector, for emissions above 1 GHz, peak emissions also be measured and need comply with Peak limit.

(6) The emissions from 9 kHz to 1 GHz, QP or average values were measured with EMI receiver with below RBW.

Frequency band	RBW
9 kHz - 150 kHz	200 Hz
150 kHz - 30 MHz	9 kHz
30 MHz - 1 GHz	120 kHz

(7) For emissions above 1 GHz, both Peak and Average level were measured with Spectrum Analyzer, and the RBW is set at 1 MHz, VBW is set at 3 MHz for Peak measure; according ANSI C63.10:2013 clause 4.1.4.2 procedure for average measure.

(8) X axis, Y axis, Z axis are tested, and worse setup X axis is reported.

#### 10.4. Test result

Pass. (See below detailed test result)

All the emissions except fundamental emission from 9 kHz to 25 GHz were comply with 15.209 limits.

Note1: According exploratory test no any obvious emission was detected from 9 kHz to 30 MHz and 18 GHz to 25 GHz.

Note2: For emissions below 1 GHz, according exploratory explorer test, when change Tx mode and channel, have no distinct influence on emissions level, so for emissions below 1 GHz, the final test was only performed with EUT working in 8DPSK, Tx 2441 MHz mode.

Note3: For emissions above 1 GHz. If peak results comply with AV limit, AV Result is deemed to comply with AV limit.



## Radiated Emission test (below 1 GHz)

## TR-4-E-009 Radiated Emission Test Result

Test Site : DDT 3m Chamber 2#

D:\2021 RE2# Report Data\Q21022514- HUYINBIN-14E  
ACAPPELLA\FCC BELOW 1G.EM6

Test Date : 2021-03-20

Tested By : Zora

EUT : Bluetooth Speaker

Model Number : aCAPPELLA

Power Supply : Battery

Test Mode : Tx mode

Condition : Temp:24.5°C,Humi:55%,Press:101.4kPa

Antenna/Distance : 2020 VULB 9163 2#/3m/VERTICAL

Memo :

Data:

1

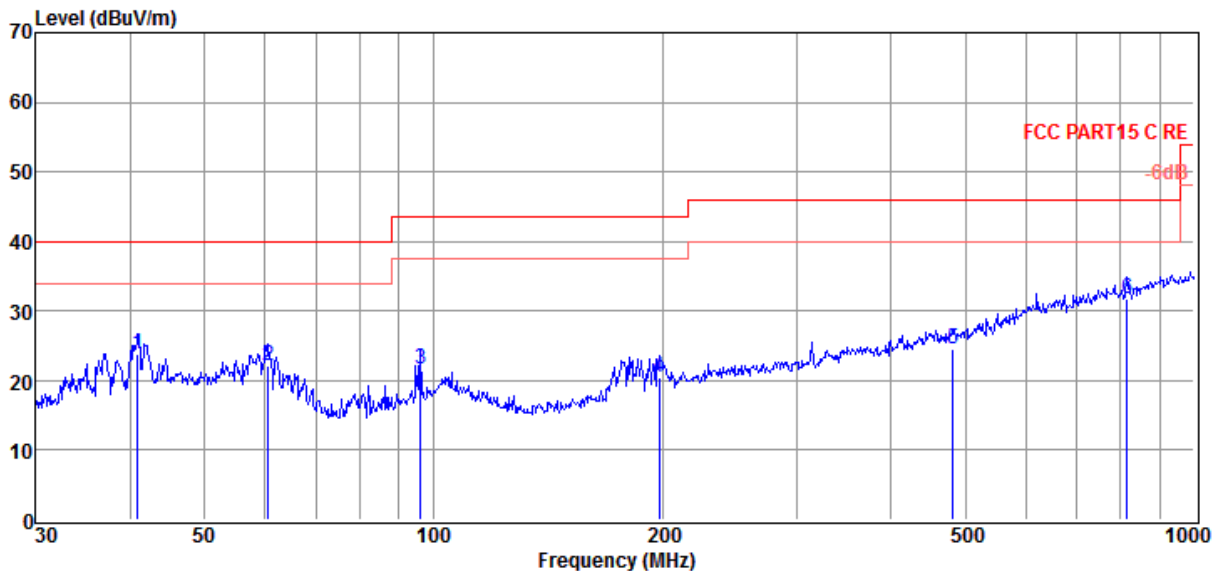

Item (Mark)	Freq. (MHz)	Read Level (dB $\mu$ V)	Antenna Factor (dB/m)	Cable Loss dB	Result Level (dB $\mu$ V/m)	Limit Line (dB $\mu$ V/m)	Over Limit (dB)	Detector	Polarization
1	40.85	8.26	11.74	3.77	23.77	40.00	-16.23	QP	VERTICAL
2	60.70	7.45	10.72	3.97	22.14	40.00	-17.86	QP	VERTICAL
3	96.10	7.33	9.95	4.37	21.65	43.50	-21.85	QP	VERTICAL
4	197.89	4.90	10.54	5.03	20.47	43.50	-23.03	QP	VERTICAL
5	482.22	1.73	16.53	6.23	24.49	46.00	-21.51	QP	VERTICAL
6	815.97	3.36	21.03	7.41	31.80	46.00	-14.20	QP	VERTICAL

Note: 1. Result Level = Read Level + Antenna Factor + Cable loss.

2. If Peak Result complies with QP limit, QP Result is deemed to comply with QP limit.

3. Test setup: RBW: 120 kHz, VBW: 300 kHz, Sweep time: auto.

# TR-4-E-009 Radiated Emission Test Result

**Test Site** : DDT 3m Chamber 2#

D:\2021 RE2# Report Data\Q21022514- HUYINBIN\14E ACAPPELLA\FCC BELOW 1G.EM6

**Test Date** : 2021-03-20

**Tested By** : Zora

**EUT** : Bluetooth Speaker

**Model Number** : aCAPPELLA

**Power Supply** : Battery

**Test Mode** : Tx mode

**Condition** : Temp:24.5°C,Humi:55%,Press:101.4kPa

**Antenna/Distance** : 2020 VULB 9163 2#/3m/HORIZONTAL

**Memo** :

Data:  
2

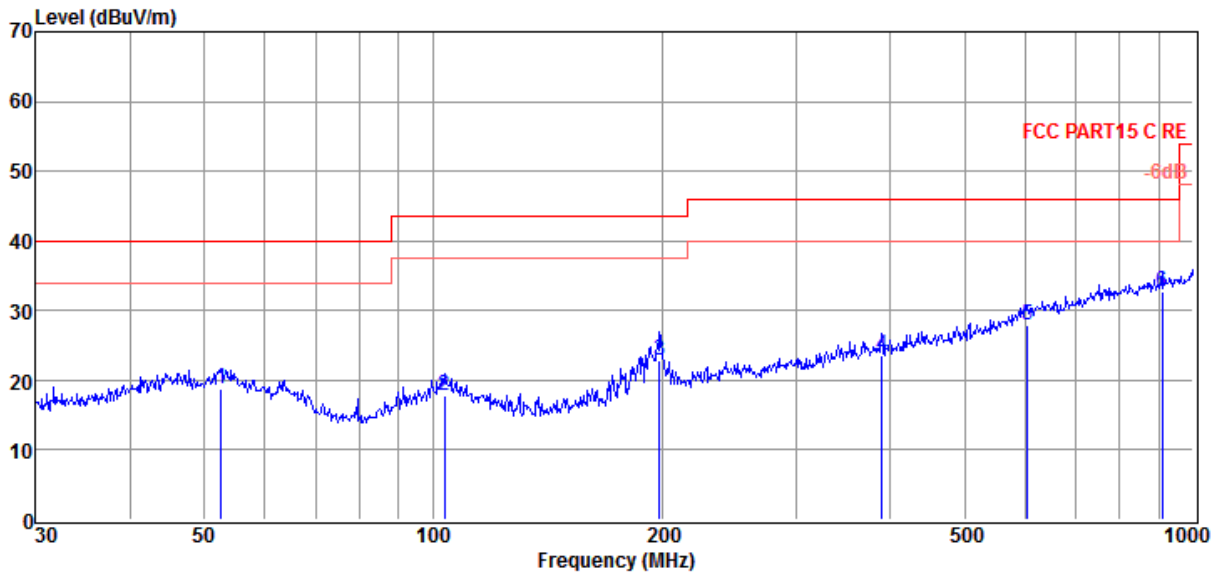

Item (Mark)	Freq. (MHz)	Read Level (dBμV)	Antenna Factor (dB/m)	Cable Loss (dB)	Result Level (dBμV/m)	Limit Line (dBμV/m)	Over Limit (dB)	Detector	Polarization
1	52.58	1.17	13.59	3.88	18.64	40.00	-21.36	QP	HORIZONTAL
2	103.44	1.39	12.00	4.43	17.82	43.50	-25.68	QP	HORIZONTAL
3	198.59	7.36	10.56	5.03	22.95	43.50	-20.55	QP	HORIZONTAL
4	389.36	2.39	15.32	5.88	23.59	46.00	-22.41	QP	HORIZONTAL
5	605.66	1.92	19.21	6.74	27.87	46.00	-18.13	QP	HORIZONTAL
6	909.67	3.03	21.92	7.73	32.68	46.00	-13.32	QP	HORIZONTAL

Note: 1. Result Level = Read Level + Antenna Factor + Cable loss.

2. If Peak Result complies with QP limit, QP Result is deemed to comply with QP limit.

3. Test setup: RBW: 120 kHz, VBW: 300 kHz, Sweep time: auto.

**Radiated Emission test (above 1 GHz)**

Freq. (MHz)	Read level (dB $\mu$ V)	Antenna Factor (dB/m)	PRM Factor (dB)	Cable Loss (dB)	Result Level (dB $\mu$ V/m)	Limit (dB $\mu$ V/ m)	Margin (dB)	Detector type	Polarization
Tx mode 2402 MHz									
4804.00	51.12	32.31	43.34	6.80	46.89	74.00	-27.11	Peak	HORIZONTAL
7494.00	46.06	37.09	42.64	8.83	49.34	74.00	-24.66	Peak	HORIZONTAL
9670.00	45.63	38.80	42.07	9.87	52.23	74.00	-21.77	Peak	HORIZONTAL
11999.00	45.44	39.60	41.40	11.07	54.71	74.00	-19.29	Peak	HORIZONTAL
11999.00	37.49	39.60	41.40	11.07	46.76	54.00	-7.24	Average	HORIZONTAL
14141.00	43.97	41.44	42.38	12.22	55.25	74.00	-18.75	Peak	HORIZONTAL
14141.00	35.79	41.44	42.38	12.22	47.07	54.00	-6.93	Average	HORIZONTAL
4804.00	49.09	32.31	43.34	6.80	44.86	74.00	-29.14	Peak	VERTICAL
7494.00	44.98	37.09	42.64	8.83	48.26	74.00	-25.74	Peak	VERTICAL
9636.00	46.18	38.80	42.06	9.83	52.75	74.00	-21.25	Peak	VERTICAL
11540.00	46.02	39.78	42.07	11.12	54.85	74.00	-19.15	Peak	VERTICAL
11540.00	38.37	39.78	42.07	11.12	47.20	54.00	-6.80	Average	VERTICAL
14770.00	43.04	40.81	41.88	12.61	54.58	74.00	-19.42	Peak	VERTICAL
14770.00	35.90	40.81	41.88	12.61	47.44	54.00	-6.56	Average	VERTICAL
Tx mode 2441 MHz									
4882.00	54.04	32.46	43.29	6.89	50.10	74.00	-23.90	Peak	HORIZONTAL
7290.00	46.01	36.76	42.79	8.48	48.46	74.00	-25.54	Peak	HORIZONTAL
9687.00	45.42	38.80	42.08	9.90	52.04	74.00	-21.96	Peak	HORIZONTAL
11897.00	44.95	39.64	41.55	11.08	54.12	74.00	-19.88	Peak	HORIZONTAL
11897.00	38.97	39.64	41.55	11.08	48.14	54.00	-5.86	Average	HORIZONTAL
15450.00	44.82	39.68	41.97	12.45	54.98	74.00	-19.02	Peak	HORIZONTAL
15450.00	36.67	39.68	41.97	12.45	46.83	54.00	-7.17	Average	HORIZONTAL
4882.00	51.58	32.46	43.29	6.89	47.64	74.00	-26.36	Peak	VERTICAL
7205.00	46.20	36.63	42.85	8.33	48.31	74.00	-25.69	Peak	VERTICAL
9704.00	44.81	38.80	42.09	9.92	51.44	74.00	-22.56	Peak	VERTICAL
12101.00	46.07	39.46	41.57	11.28	55.24	74.00	-18.76	Peak	VERTICAL
12101.00	38.96	39.46	41.57	11.28	48.13	54.00	-5.87	Average	VERTICAL
14141.00	41.82	41.44	42.38	12.22	53.10	74.00	-20.90	Peak	VERTICAL
Tx mode 2480 MHz									
4960.00	53.78	32.62	43.23	6.99	50.16	74.00	-23.84	Peak	HORIZONTAL
7426.00	47.24	36.98	42.69	8.71	50.24	74.00	-23.76	Peak	HORIZONTAL
9415.00	46.94	38.72	41.97	9.64	53.33	74.00	-20.67	Peak	HORIZONTAL
11863.00	44.00	39.65	41.60	11.08	53.13	74.00	-20.87	Peak	HORIZONTAL
17949.00	42.28	47.79	42.49	14.51	62.09	74.00	-11.91	Peak	HORIZONTAL
17949.00	30.67	47.79	42.49	14.51	50.48	54.00	-3.52	Average	HORIZONTAL
4960.00	52.94	32.62	43.23	6.99	49.32	74.00	-24.68	Peak	VERTICAL
7630.00	46.47	37.31	42.55	8.78	50.01	74.00	-23.99	Peak	VERTICAL
10180.00	45.87	39.09	42.33	10.31	52.94	74.00	-21.06	Peak	VERTICAL
12101.00	46.11	39.46	41.57	11.28	55.28	74.00	-18.72	Peak	VERTICAL
12101.00	38.79	39.46	41.57	11.28	47.96	54.00	-6.04	Average	VERTICAL
14481.00	44.03	41.31	42.11	12.05	55.28	74.00	-18.72	Peak	VERTICAL
14481.00	36.95	41.31	42.11	12.05	48.20	54.00	-5.80	Average	VERTICAL
Result: Pass									

- Note: 1. 30 MHz ~ 25 GHz: (Scan with GFSK,  $\pi/4$ -DQPSK and 8DPSK, the worst case is 8DPSK Mode)  
2. Result Level = Read Level + Antenna Factor + Cable loss - PRM Factor.  
3. For emissions above 1 GHz. If peak results comply with AV limit, AV Result is deemed to comply with AV limit.

## 11. RF Conducted Spurious Emissions

### 11.1. Block diagram of test setup

Same as section 4.1

### 11.2. Limits

In any 100 kHz bandwidth outside the frequency bands in which the spread spectrum intentional radiator is operating, the radio frequency power that is produced by the intentional radiator shall be at least 20 dB below that in the 100 kHz bandwidth within the band that contains the highest level of the desired power.

### 11.3. Test procedure

(1) Connect EUT's antenna output to spectrum analyzer by RF cable.

(2) Establish a reference level by using the following procedure:

Center frequency	Test frequency
RBW:	100 kHz
VBW:	300 kHz
Span	Wide enough to capture the peak level of the in-band emission
Detector Mode:	Peak
Sweep time:	auto
Trace mode	Max hold

(3) Allow the trace to stabilize, use the peak marker function to determine the maximum peak power level to establish the reference level.

(4) Set the spectrum analyzer as follows:

RBW:	100 kHz
VBW:	300 kHz
Span	Encompass frequency range to be measured
Number of measurement points	$\geq \text{span}/\text{RBW}$
Detector Mode:	Peak
Sweep time:	auto
Trace mode	Max hold

(5) Allow the trace to stabilize, use the peak marker function to determine the maximum amplitude of all unwanted emissions outside of the authorized frequency band

### 11.4. Test result

Mode	Freq. (MHz)	Verdict
GFSK	Hopping off 2402	Pass
	Hopping off 2441	Pass
	Hopping off 2480	Pass
$\pi/4$ -DQPSK	Hopping off 2402	Pass
	Hopping off 2441	Pass
	Hopping off 2480	Pass
8DPSK	Hopping off 2402	Pass
	Hopping off 2441	Pass
	Hopping off 2480	Pass

### 11.5. Original test data

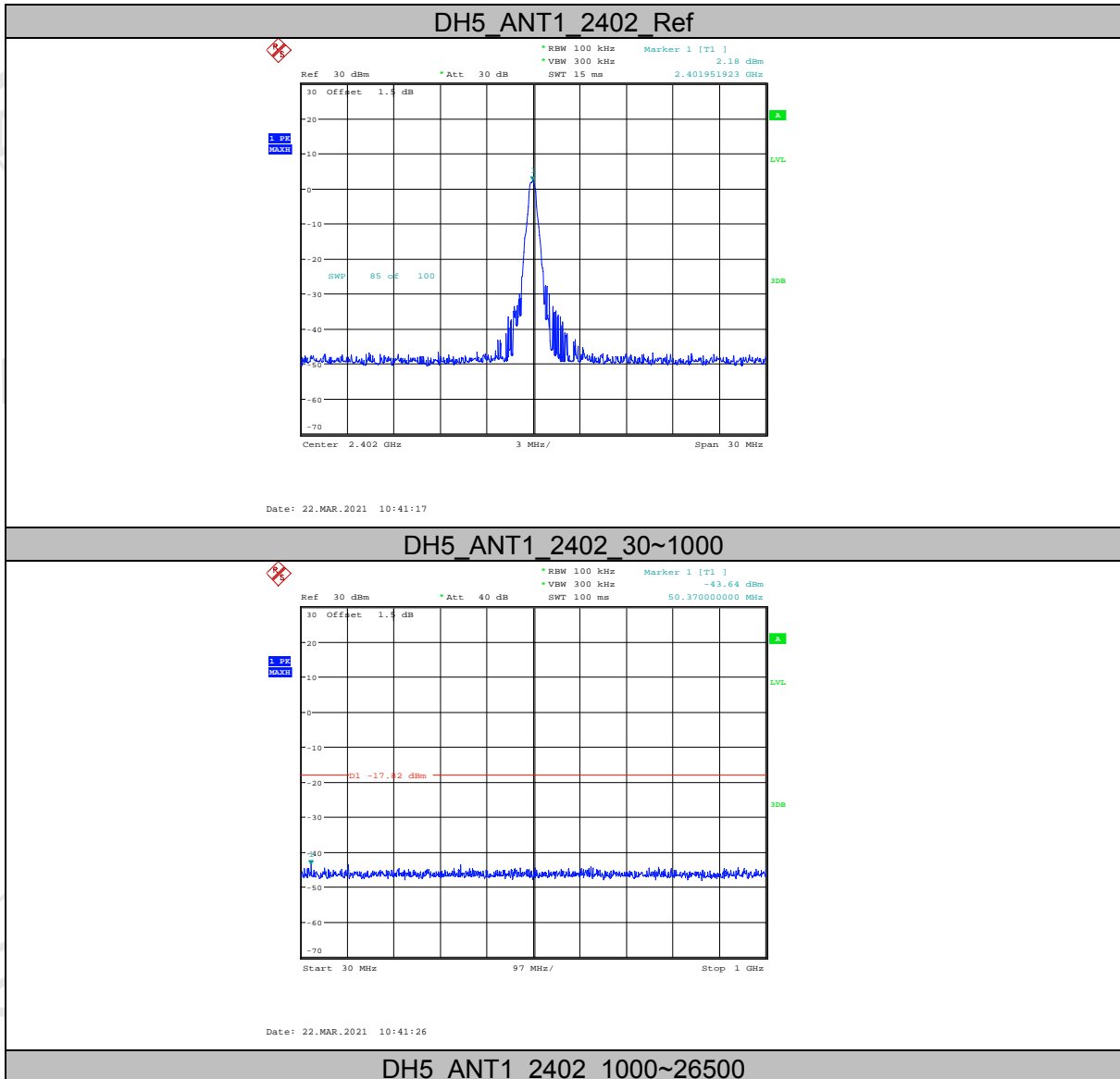

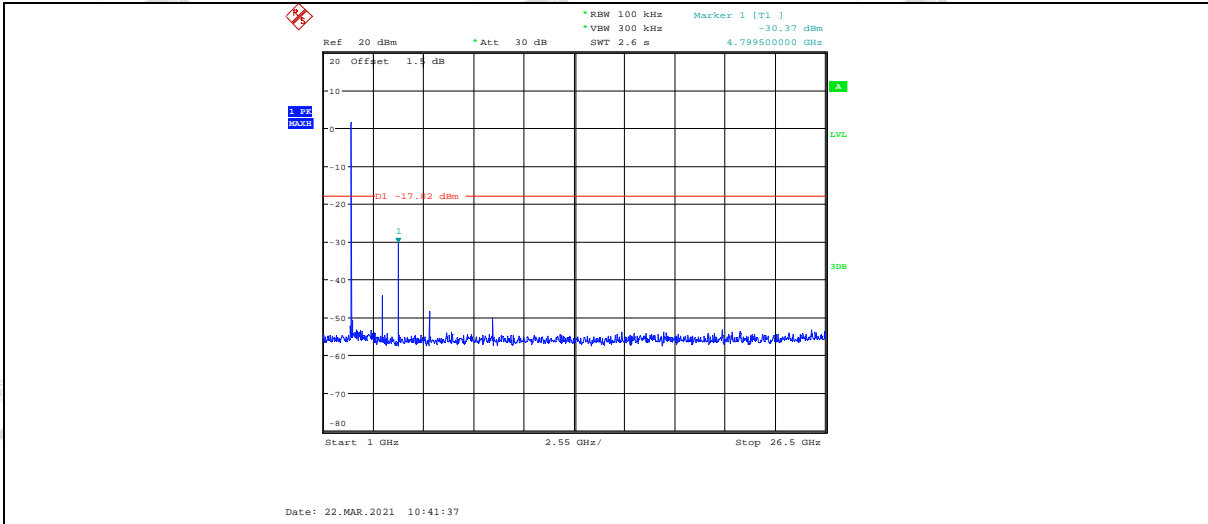

DH5 ANT1 2441 Ref

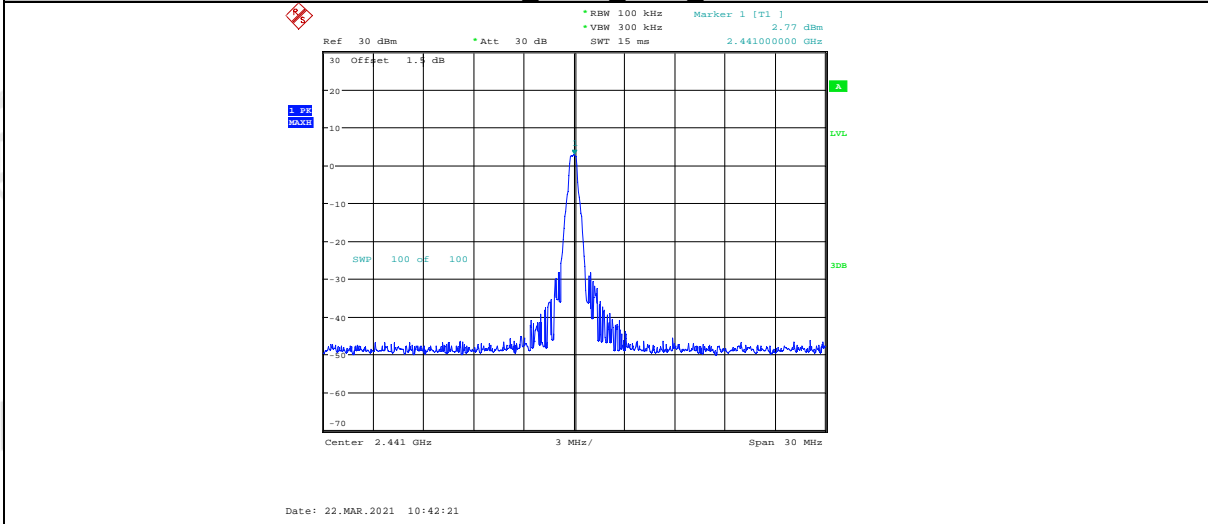

DH5 ANT1 2441 30~1000

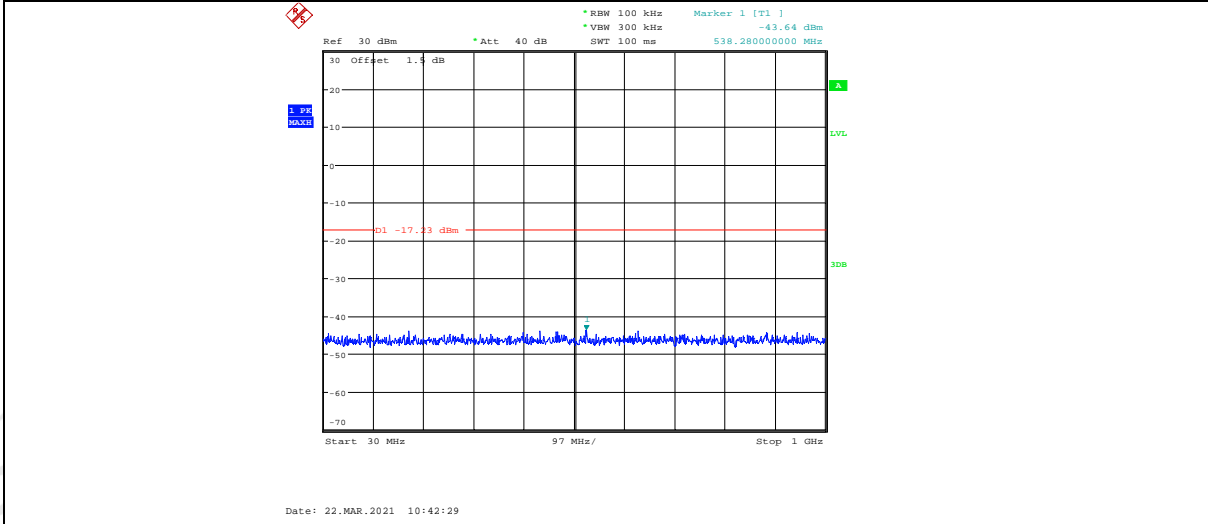

DH5 ANT1\_2441\_1000~26500

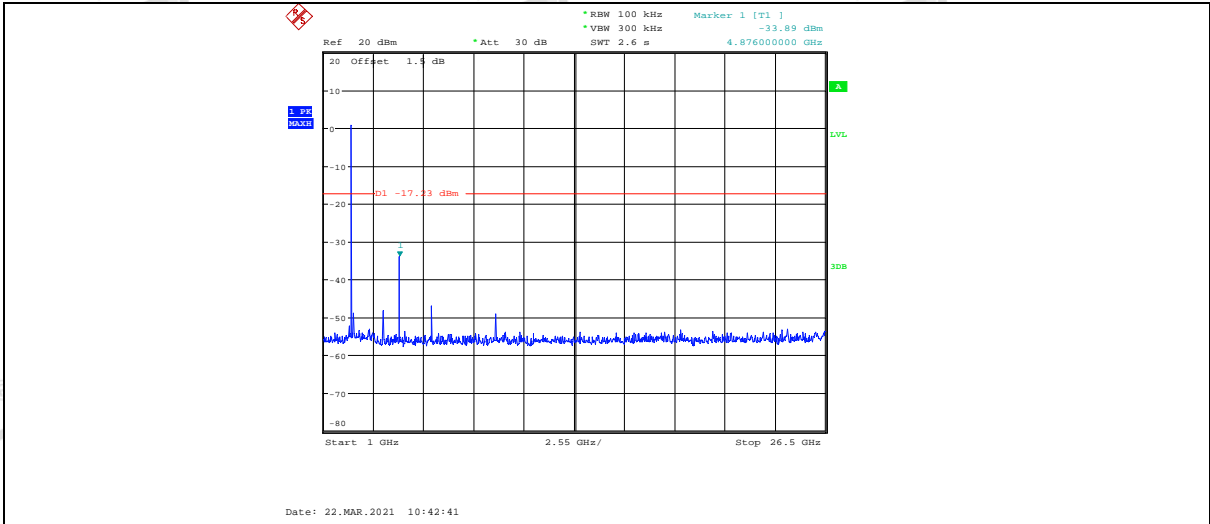

DH5 ANT1 2480 Ref

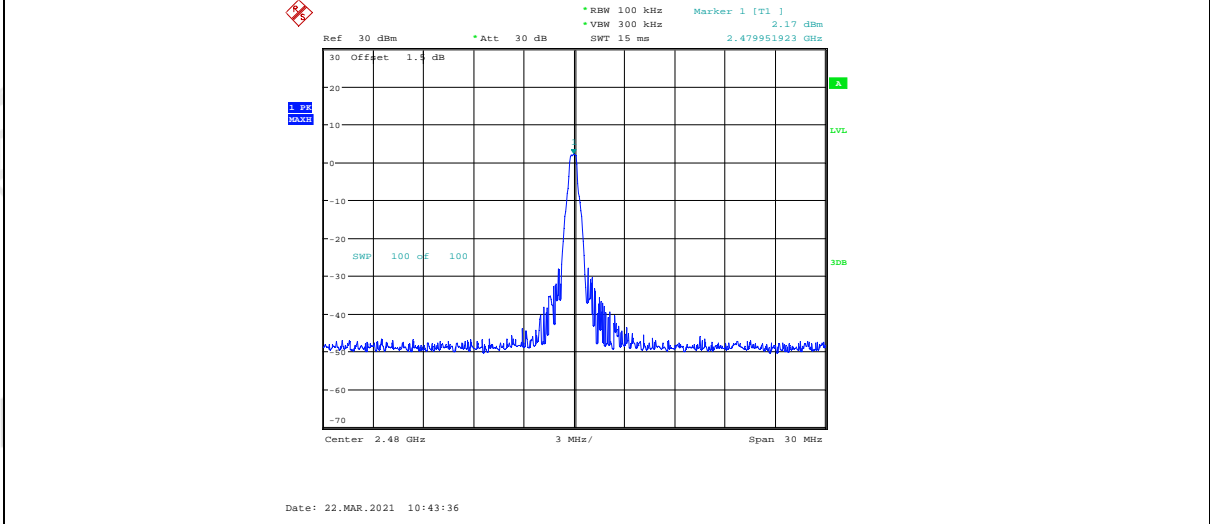

DH5 ANT1 2480 30~1000

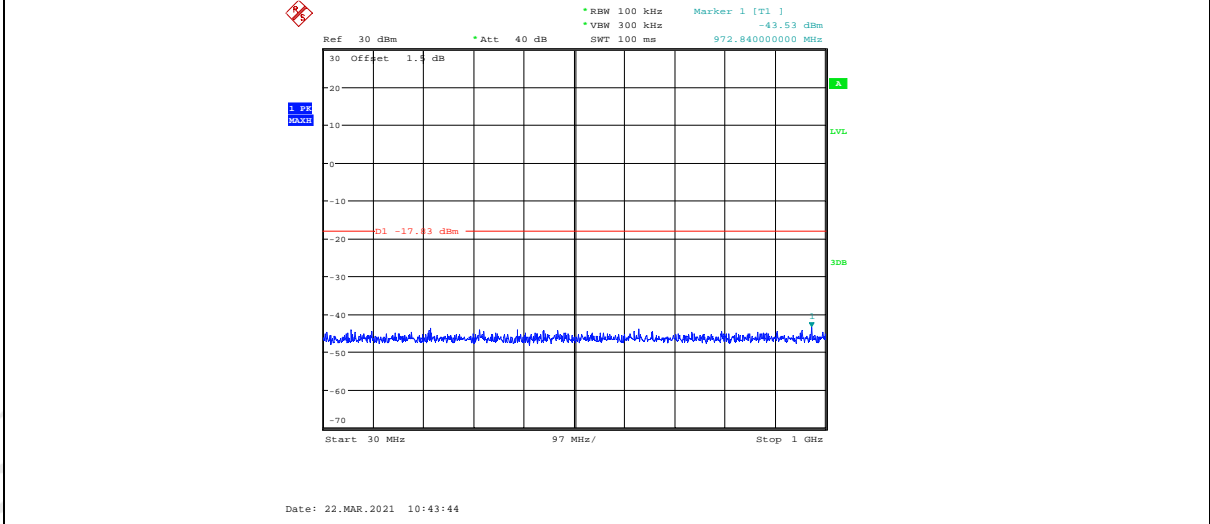

DH5 ANT1 2480 1000~26500



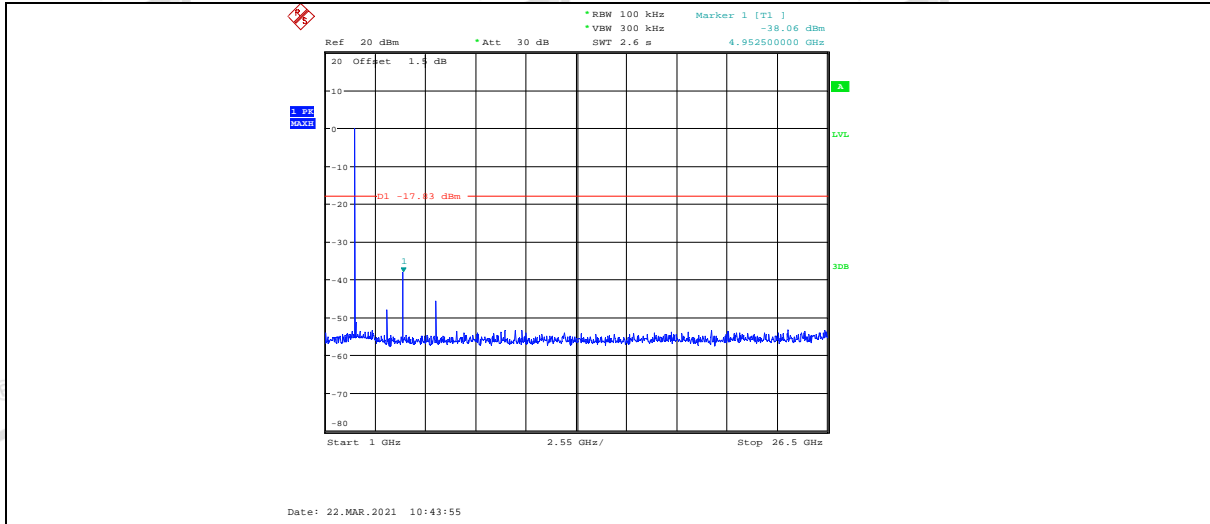

2DH5 ANT1 2402 Ref

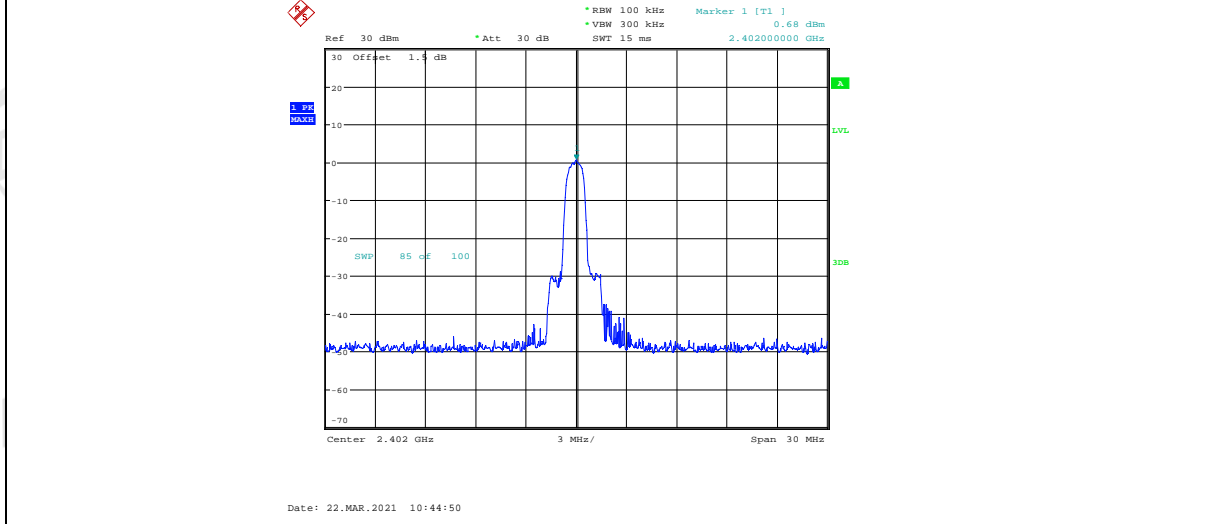

2DH5 ANT1 2402 30~1000

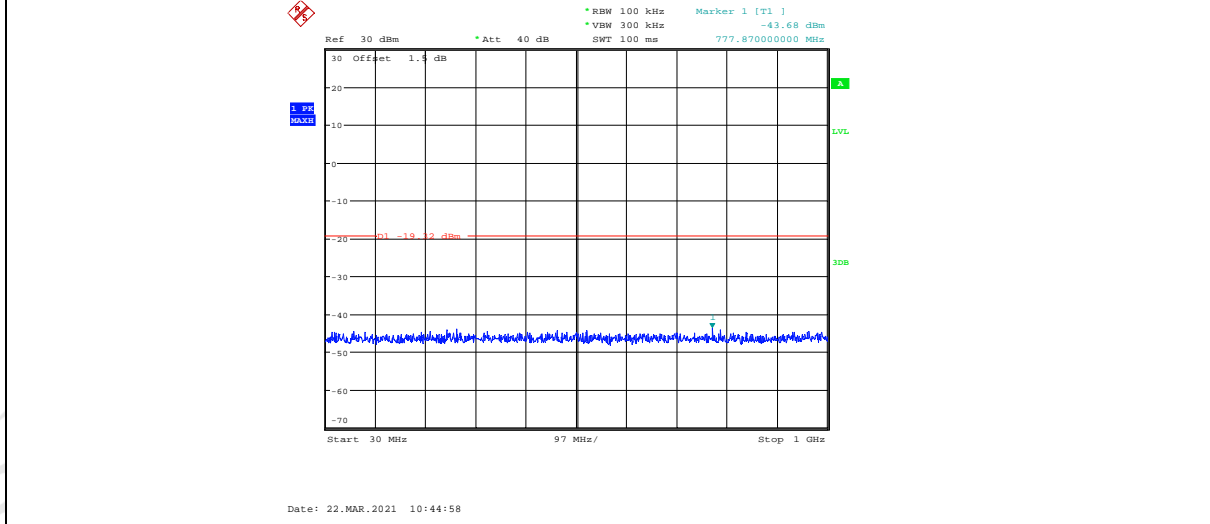

2DH5 ANT1 2402 1000~26500

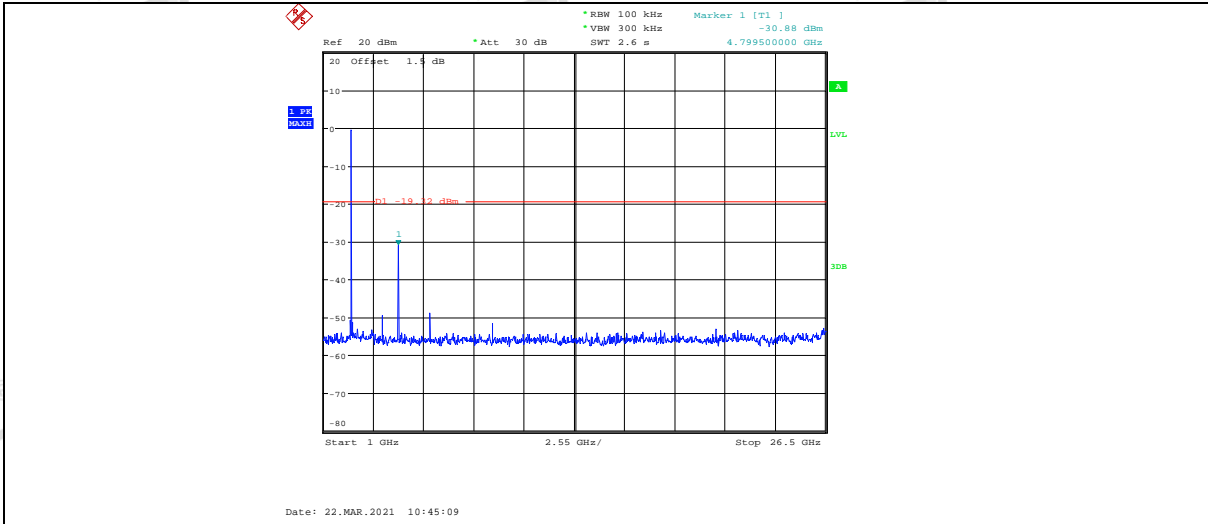

2DH5 ANT1 2441 Ref

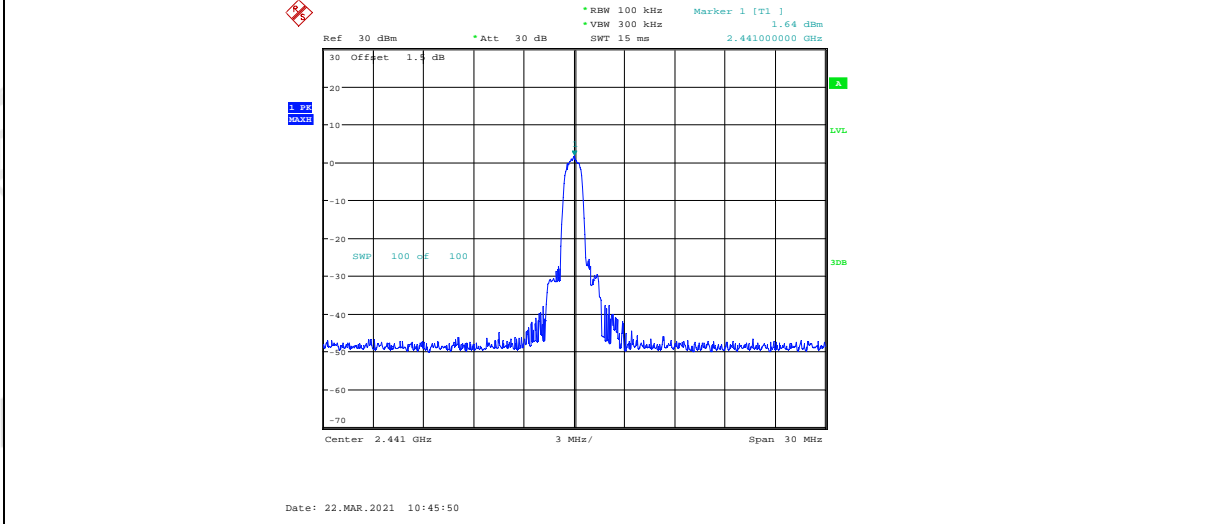

2DH5 ANT1 2441 30~1000

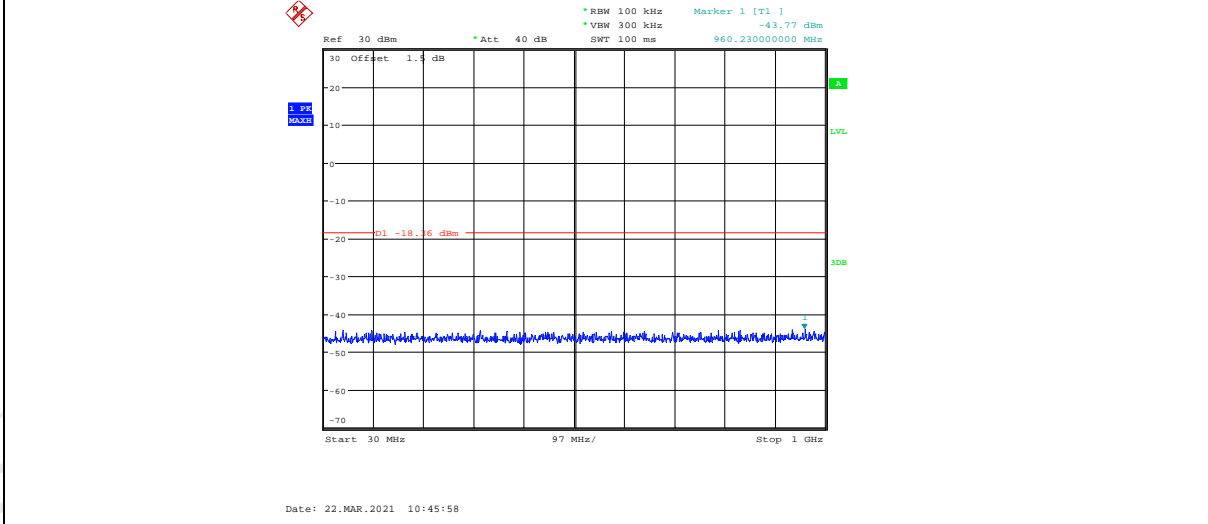

2DH5 ANT1 2441 1000~26500

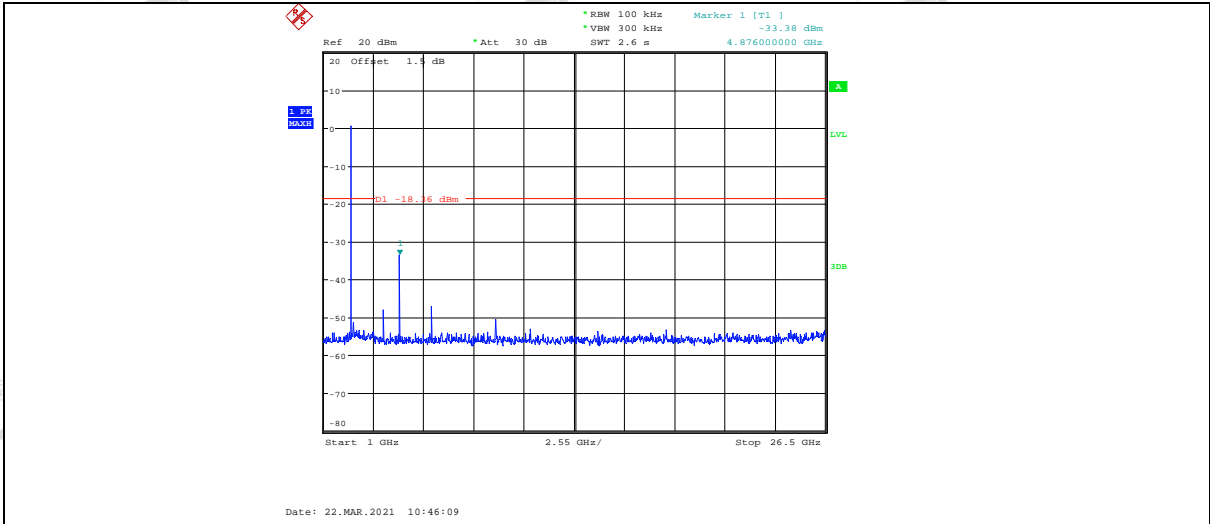

2DH5 ANT1 2480 Ref

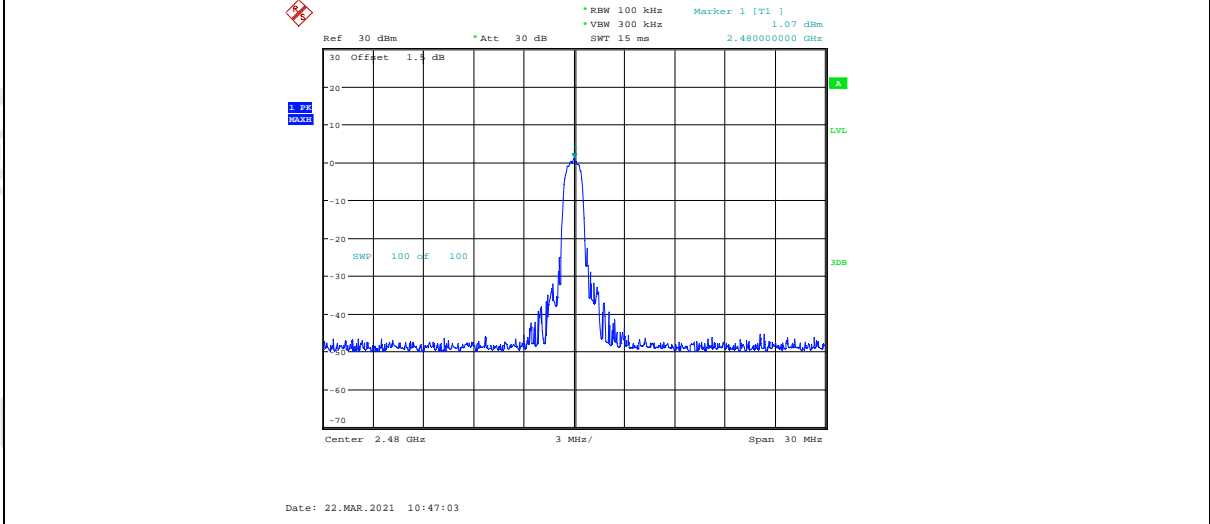

2DH5 ANT1 2480 30~1000

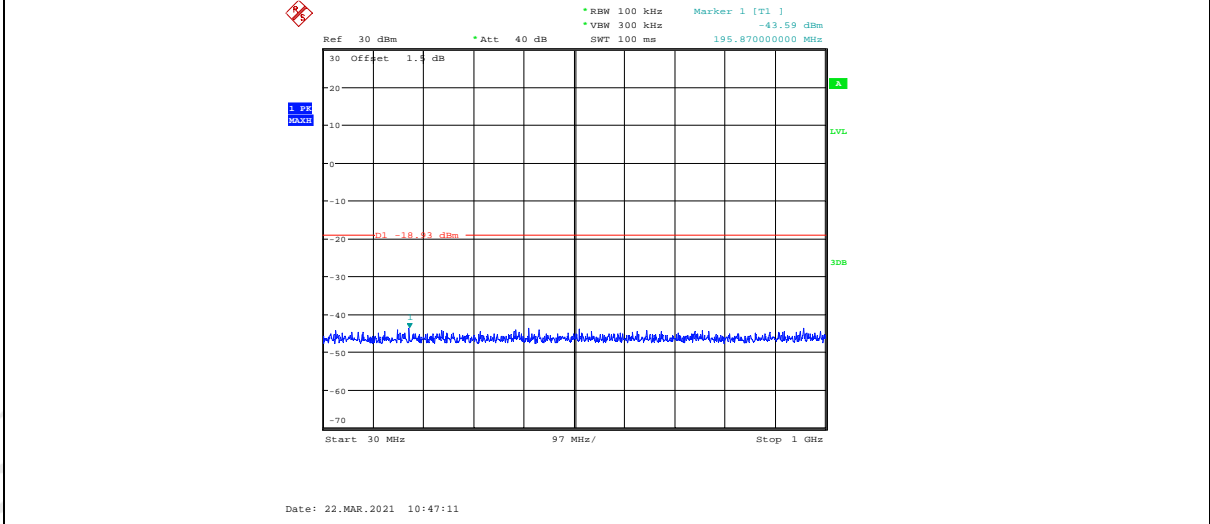

2DH5 ANT1 2480 1000~26500

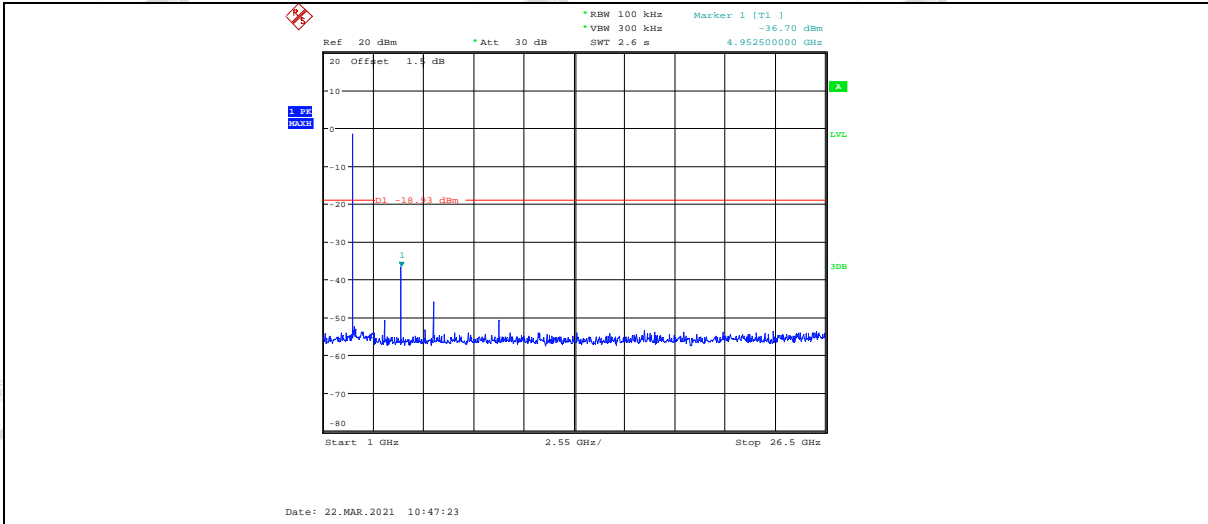

3DH5 ANT1 2402 Ref

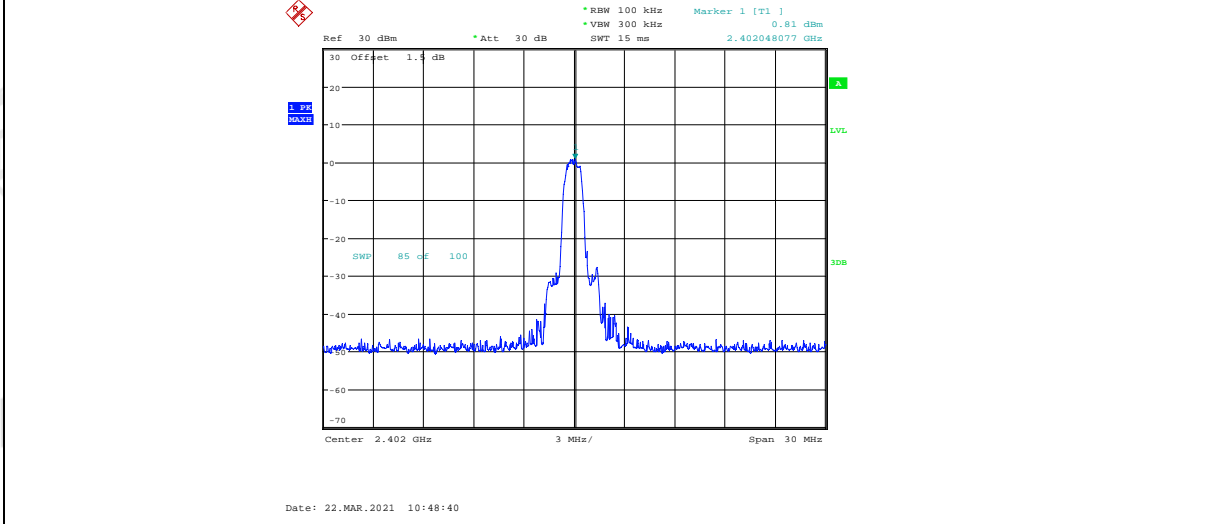

3DH5 ANT1 2402 30~1000

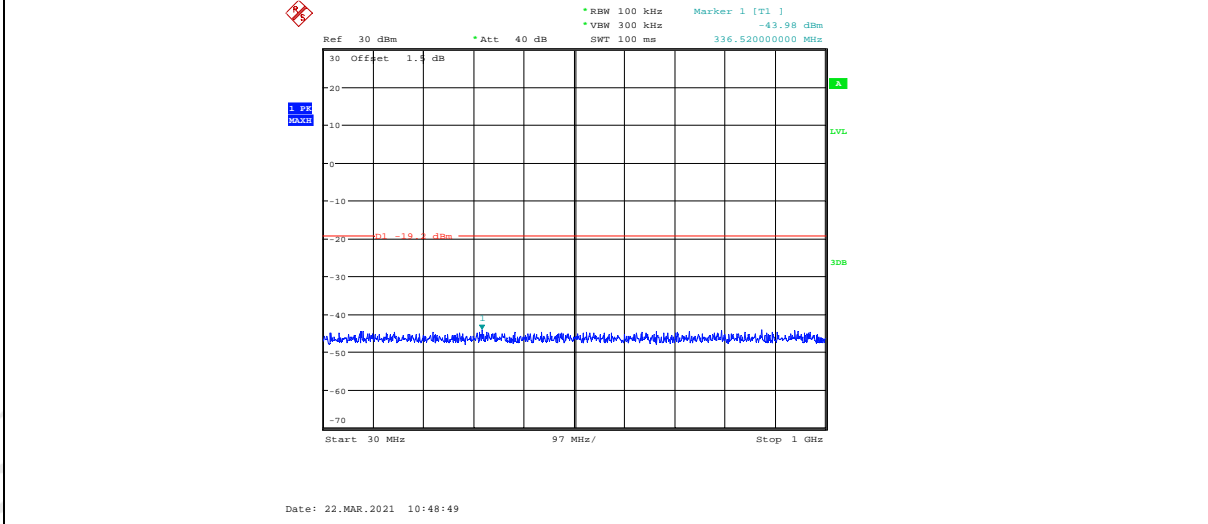

3DH5 ANT1 2402 1000~26500

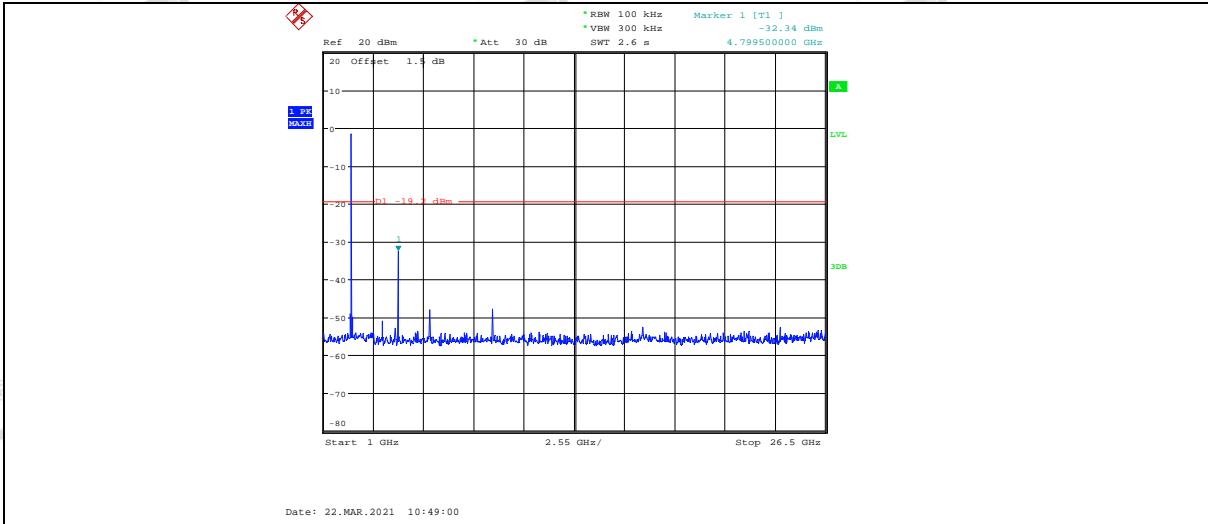

3DH5 ANT1 2441 Ref

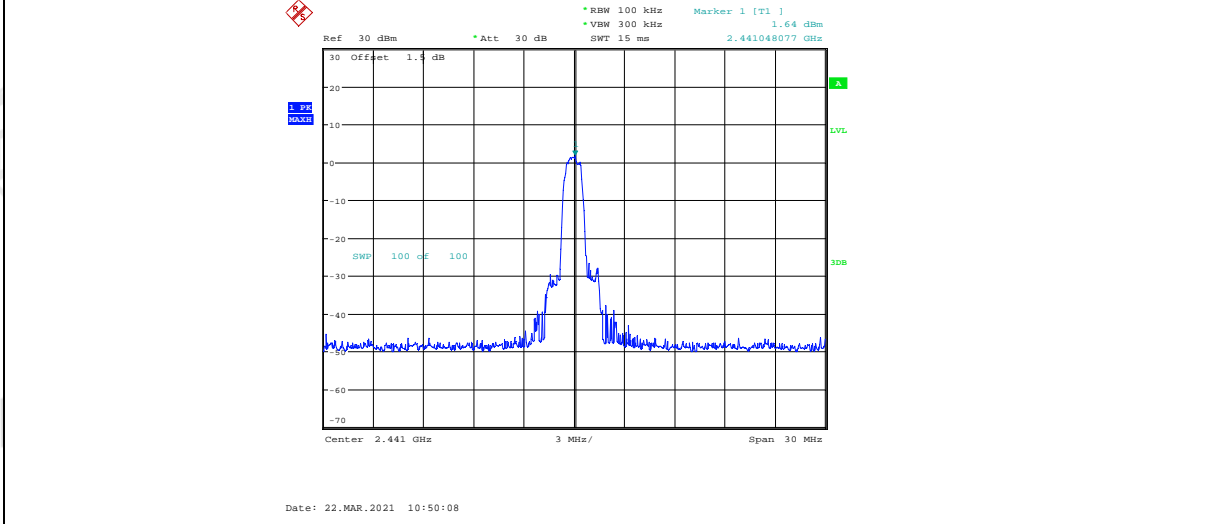

3DH5 ANT1 2441 30~1000

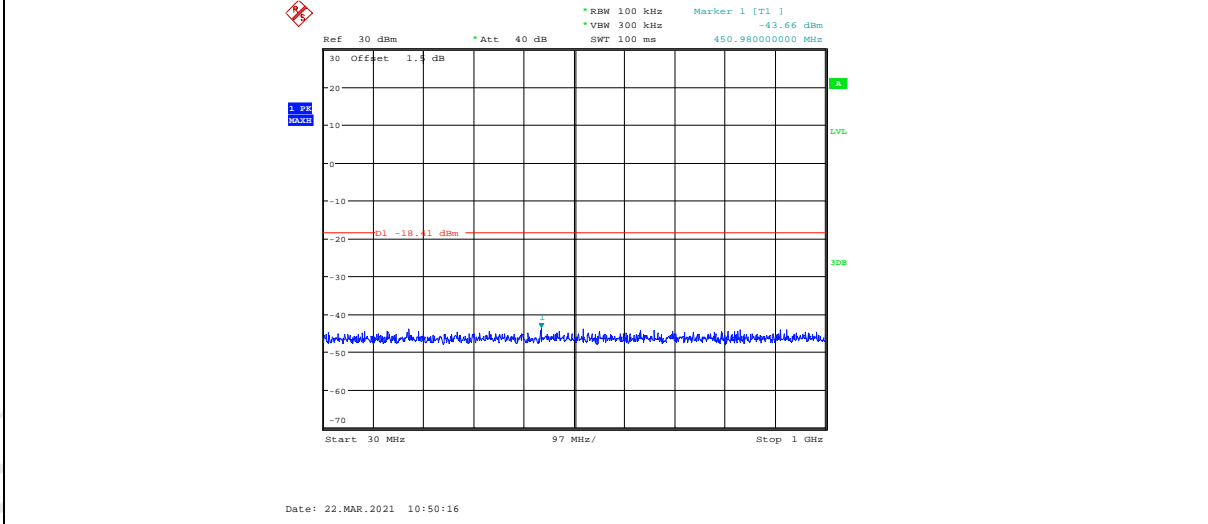

3DH5 ANT1 2441 1000~26500

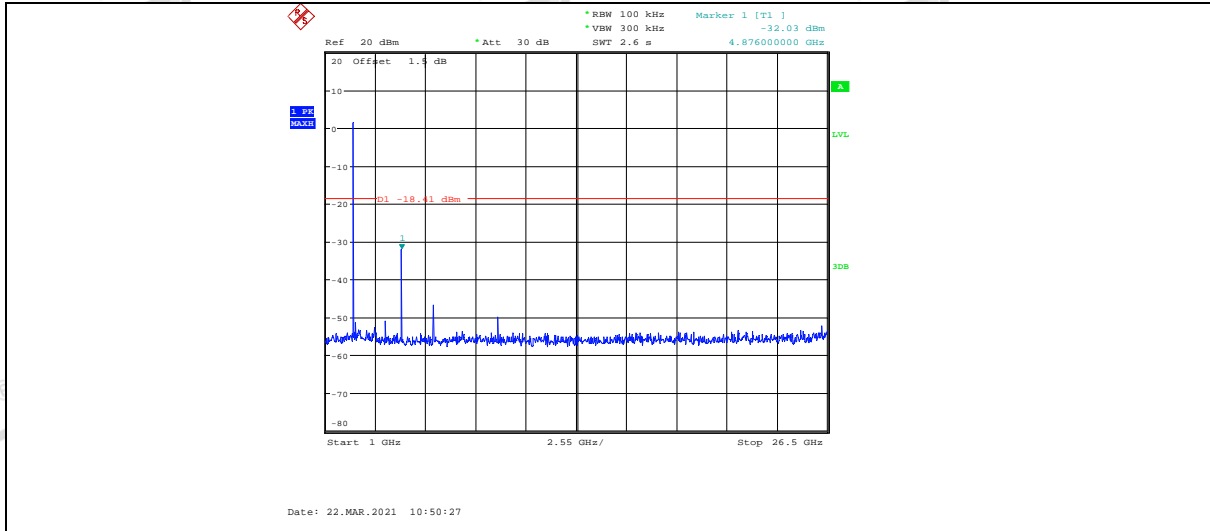

3DH5 ANT1 2480 Ref

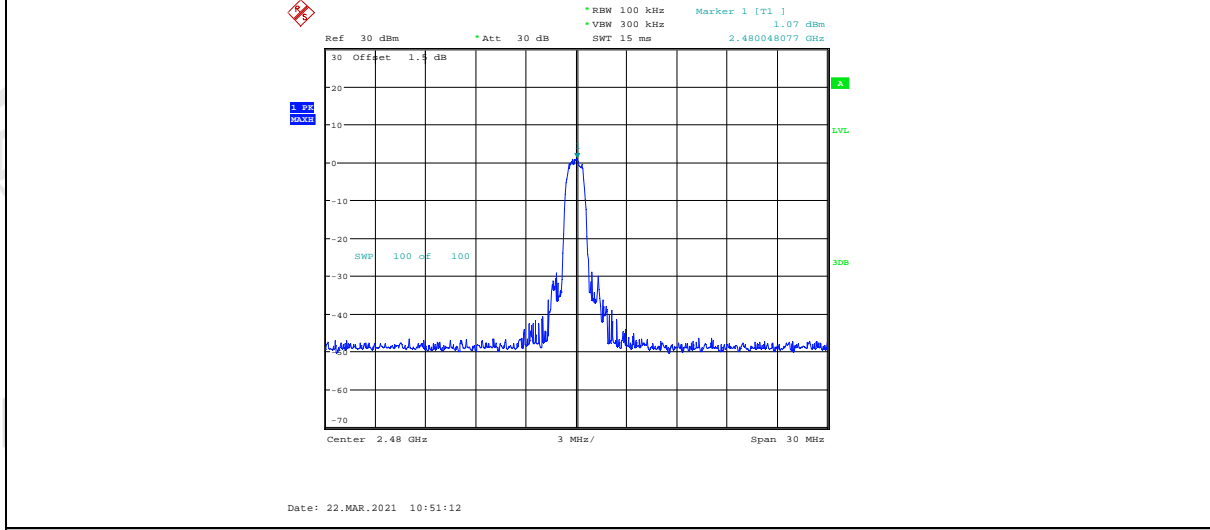

3DH5 ANT1 2480 30~1000

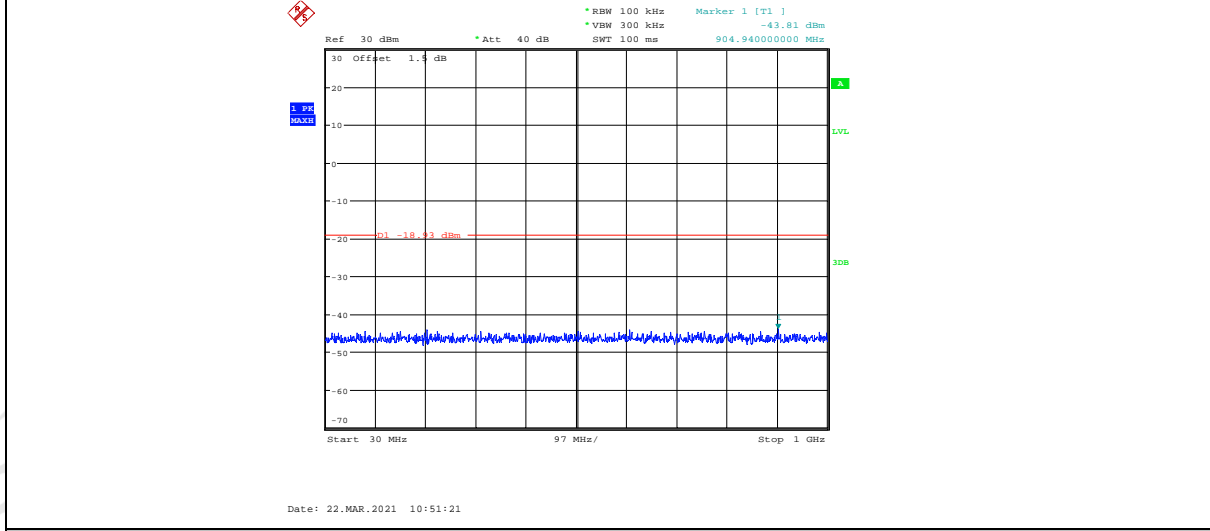

3DH5 ANT1 2480 1000~26500

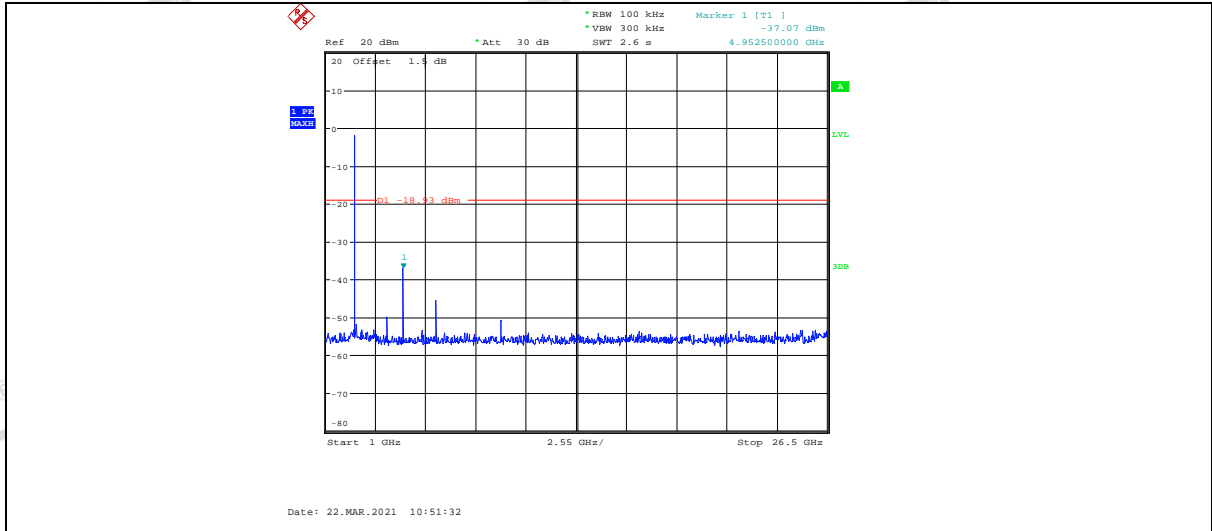

## 12. Band Edge Compliance (Radiated Method)

### 12.1. Block diagram of test setup

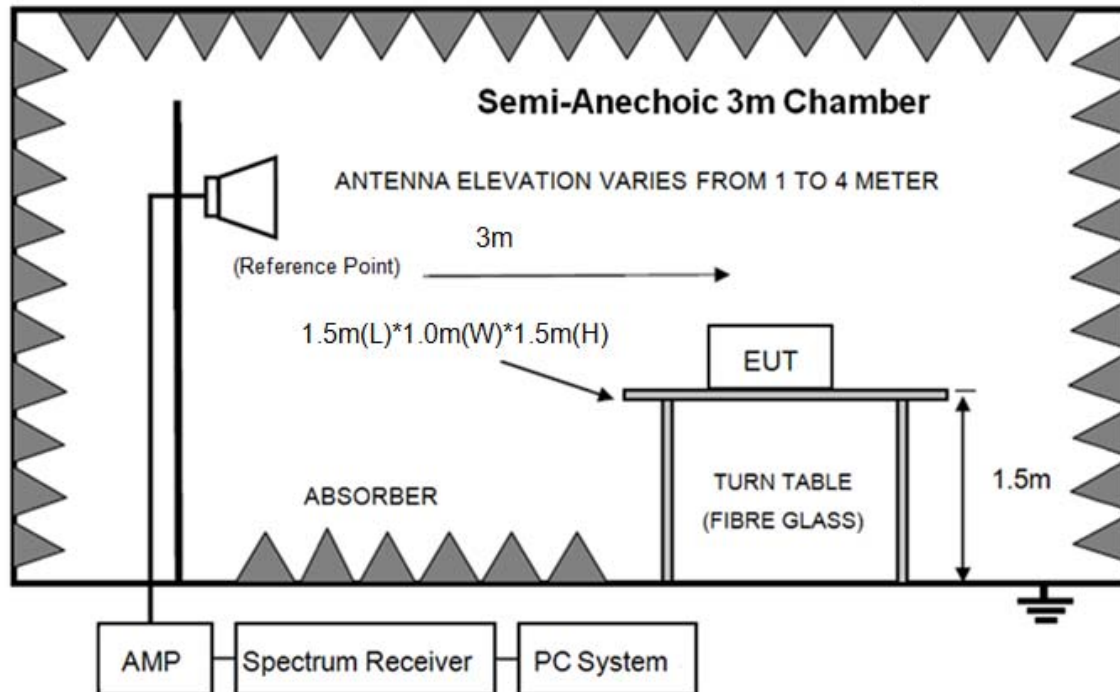

### 12.2. Limit

All restriction band should comply with 15.209, other emission should be at least 20 dB below the fundamental.

### 12.3. Test procedure

Same with clause 10.3 except change investigated frequency range from 2310 MHz to 2410 MHz and 2475 MHz to 2500 MHz.

Remark: All restriction band have been tested, and only the worst case is shown in report.

### 12.4. Test result

Pass. (See below detailed test result)

Remark: hopping on and hopping off mode all have been test, hopping off mode is worse and reported only, the worst case recorded in this report.



# TR-4-E-009 Radiated Emission Test Result

**Test Site** : DDT 3m Chamber 2#

D:\2021 RE2# Report Data\Q21022514- HUYINBIN\14E ACAPPELLA\FCC ABOVE 1G.EM6

**Test Date** : 2021-04-26

**Tested By** : Zora

**EUT** : Bluetooth Speaker

**Model Number** : aCAPPELLA

**Power Supply** : Battery

**Test Mode** : Tx mode

**Condition** : Temp:24.5°C,Humi:55%,Press:100.1kPa

**Antenna/Distance** : 2020 BBHA9120D/3m/VERTICAL

**Memo** : DH5 2402

Data: 1

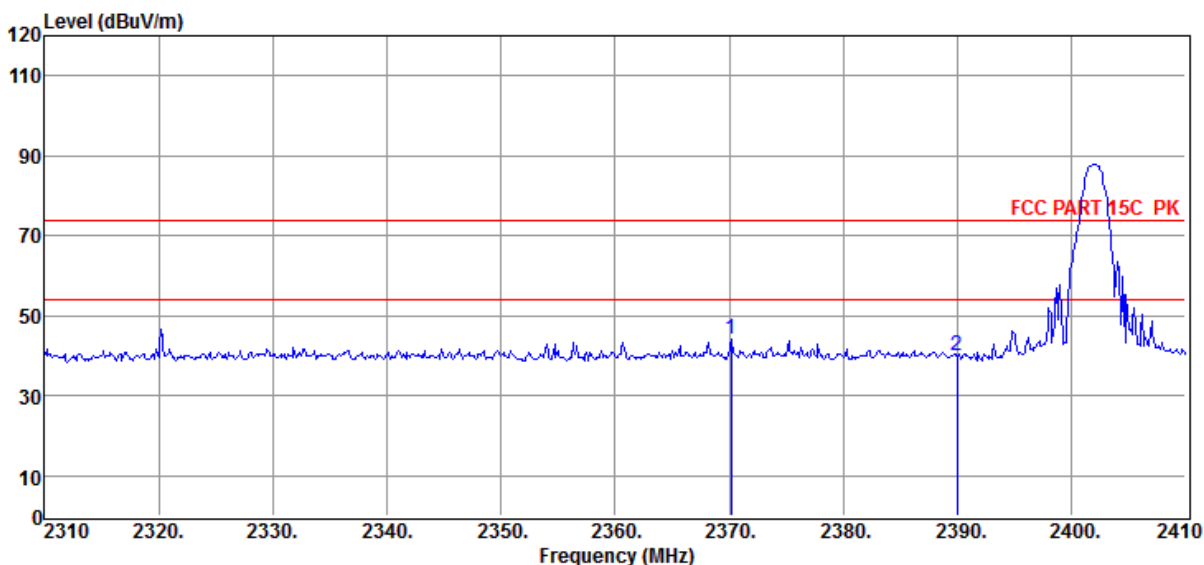

Item (Mark)	Freq. (MHz)	Read Level (dBμV)	Antenna Factor (dB/m)	PRM Factor (dB)	Cable Loss (dB)	Result Level (dBμV/m)	Limit Line (dBμV/m)	Over Limit (dB)	Detector	Polarization
1	2370.20	54.51	27.87	43.12	4.78	44.04	74.00	-29.96	Peak	VERTICAL
2	2390.00	50.58	27.89	43.14	4.80	40.13	74.00	-33.87	Peak	VERTICAL

Note: 1. Result Level = Read Level + Antenna Factor + Cable loss - PRM Factor.

2. If Peak Result complies with AV limit, AV Result is deemed to comply with AV limit.

3. Test setup: RBW: 1 MHz, VBW: 3 MHz, Sweep time: auto.

# TR-4-E-009 Radiated Emission Test Result

**Test Site** : DDT 3m Chamber 2# D:\2021 RE2# Report Data\Q21022514- HUYINBIN\14E  
ACAPPELLA\FCC ABOVE 1G.EM6  
**Test Date** : 2021-04-26 **Tested By** : Zora  
**EUT** : Bluetooth Speaker **Model Number** : aCAPPELLA  
**Power Supply** : Battery **Test Mode** : Tx mode  
**Condition** : Temp:24.5°C,Humi:55%,Press:100.1kPa **Antenna/Distance** : 2020 BBHA9120D/3m/HORIZONTAL  
**Memo** : DH5 2402

Data: 2

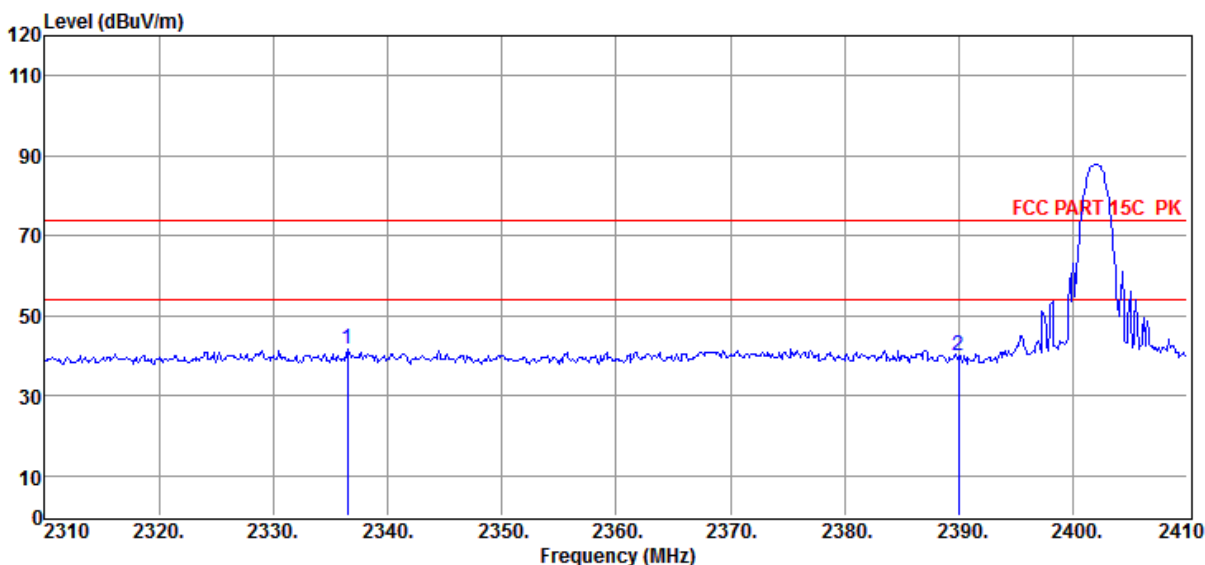

Item (Mark)	Freq. (MHz)	Read Level (dBμV)	Antenna Factor (dB/m)	PRM Factor (dB)	Cable Loss (dB)	Result Level (dBμV/m)	Limit Line (dBμV/m)	Over Limit (dB)	Detector	Polarization
1	2336.50	52.21	27.84	43.08	4.74	41.71	74.00	-32.29	Peak	HORIZONTAL
2	2390.00	50.39	27.89	43.14	4.80	39.94	74.00	-34.06	Peak	HORIZONTAL

- Note: 1. Result Level = Read Level + Antenna Factor + Cable loss - PRM Factor.  
 2. If Peak Result complies with AV limit, AV Result is deemed to comply with AV limit.  
 3. Test setup: RBW: 1 MHz, VBW: 3 MHz, Sweep time: auto.

# TR-4-E-009 Radiated Emission Test Result

**Test Site** : DDT 3m Chamber 2#

D:\2021 RE2# Report Data\Q21022514- HUYINBIN\14E ACAPPELLA\FCC ABOVE 1G.EM6

**Test Date** : 2021-04-26

**Tested By** : Zora

**EUT** : Bluetooth Speaker

**Model Number** : aCAPPELLA

**Power Supply** : Battery

**Test Mode** : Tx mode

**Condition** : Temp:24.5°C,Humi:55%,Press:100.1kPa

**Antenna/Distance** : 2020 BBHA9120D/3m/VERTICAL

**Memo** : DH5 2480

Data: 3

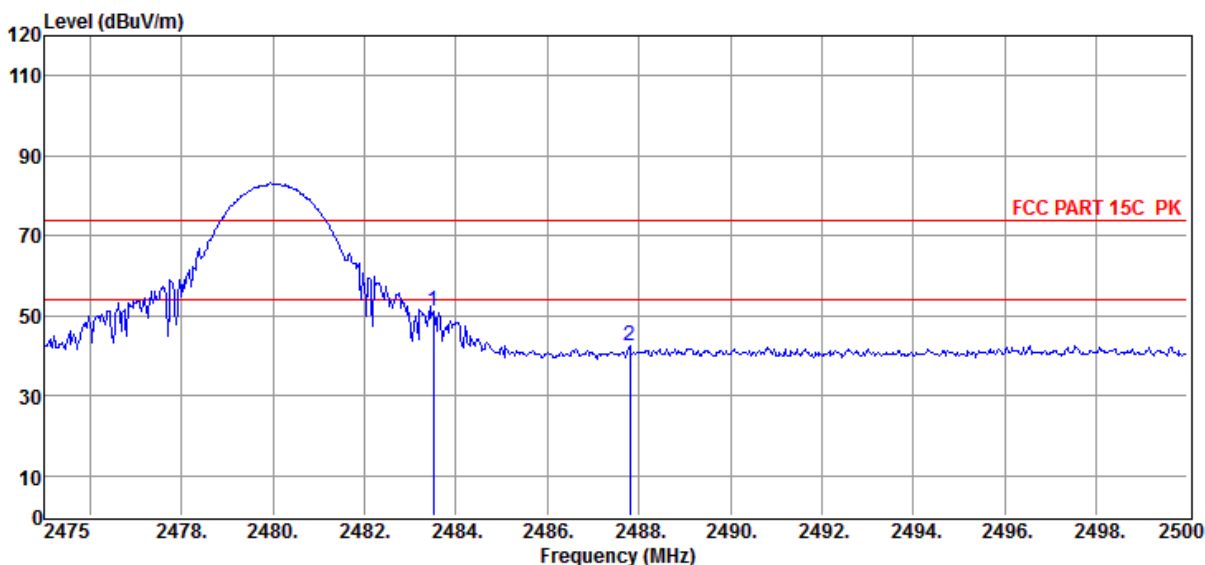

Item (Mark)	Freq. (MHz)	Read Level (dBμV)	Antenna Factor (dB/m)	PRM Factor (dB)	Cable Loss (dB)	Result Level (dBμV/m)	Limit Line (dBμV/m)	Over Limit (dB)	Detector	Polarization
1	2483.50	61.50	27.98	43.23	4.90	51.15	74.00	-22.85	Peak	VERTICAL
2	2487.80	52.65	27.99	43.24	4.91	42.31	74.00	-31.69	Peak	VERTICAL

Note: 1. Result Level = Read Level + Antenna Factor + Cable loss - PRM Factor.

2. If Peak Result complies with AV limit, AV Result is deemed to comply with AV limit.

3. Test setup: RBW: 1 MHz, VBW: 3 MHz, Sweep time: auto.

# TR-4-E-009 Radiated Emission Test Result

**Test Site** : DDT 3m Chamber 2# **D:\2021 RE2# Report Data\Q21022514- HUYINBIN\14E ACAPPELLA\FCC ABOVE 1G.EM6**  
**Test Date** : 2021-04-26 **Tested By** : Zora  
**EUT** : Bluetooth Speaker **Model Number** : aCAPPELLA  
**Power Supply** : Battery **Test Mode** : Tx mode  
**Condition** : Temp:24.5°C,Humi:55%,Press:100.1kPa **Antenna/Distance** : 2020 BBHA9120D/3m/HORIZONTAL  
**Memo** : DH5 2480

Data: 4

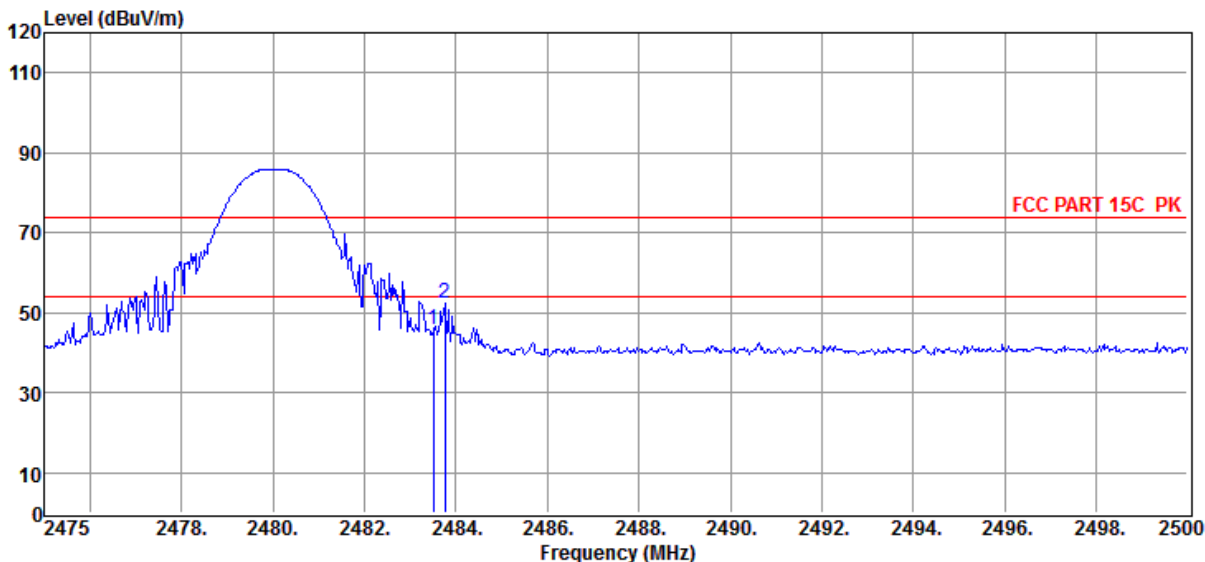

Item (Mark)	Freq. (MHz)	Read Level (dBuV)	Antenna Factor (dB/m)	PRM Factor (dB)	Cable Loss (dB)	Result Level (dBuV/m)	Limit Line (dBuV/m)	Over Limit (dB)	Detector	Polarization
1	2483.50	56.16	27.98	43.23	4.90	45.81	74.00	-28.19	Peak	HORIZONTAL
2	2483.75	62.78	27.98	43.23	4.90	52.43	74.00	-21.57	Peak	HORIZONTAL

- Note: 1. Result Level = Read Level + Antenna Factor + Cable loss - PRM Factor.  
 2. If Peak Result complies with AV limit, AV Result is deemed to comply with AV limit.  
 3. Test setup: RBW: 1 MHz, VBW: 3 MHz, Sweep time: auto.

# TR-4-E-009 Radiated Emission Test Result

**Test Site** : DDT 3m Chamber 2#

D:\2021 RE2# Report Data\Q21022514- HUYINBIN\14E  
ACAPPELLA\FCC ABOVE 1G.EM6

**Test Date** : 2021-04-26

**Tested By** : Zora

**EUT** : Bluetooth Speaker

**Model Number** : aCAPPELLA

**Power Supply** : Battery

**Test Mode** : Tx mode

**Condition** : Temp:24.5°C,Humi:55%,Press:100.1kPa

**Antenna/Distance** : 2020 BBHA9120D/3m/VERTICAL

**Memo** : 2DH5 2402

Data: 5

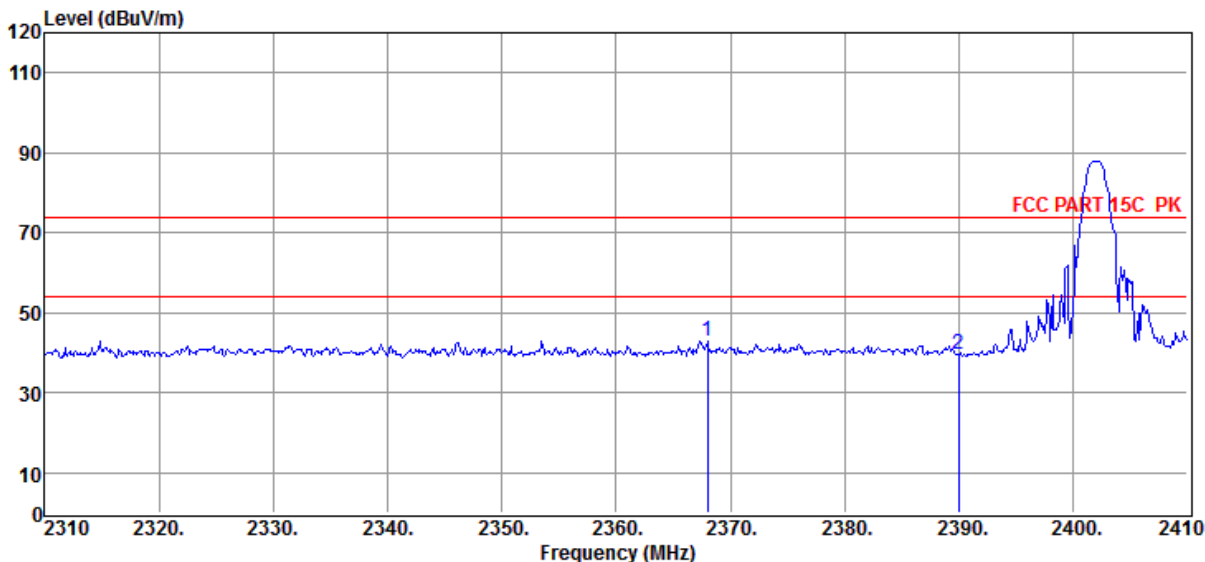

Item (Mark)	Freq. (MHz)	Read Level (dBμV)	Antenna Factor (dB/m)	PRM Factor (dB)	Cable Loss (dB)	Result Level (dBμV/m)	Limit Line (dBμV/m)	Over Limit (dB)	Detector	Polarization
1	2368.00	53.25	27.87	43.12	4.77	42.77	74.00	-31.23	Peak	VERTICAL
2	2390.00	50.02	27.89	43.14	4.80	39.57	74.00	-34.43	Peak	VERTICAL

Note: 1. Result Level = Read Level + Antenna Factor + Cable loss - PRM Factor.

2. If Peak Result complies with AV limit, AV Result is deemed to comply with AV limit.

3. Test setup: RBW: 1 MHz, VBW: 3 MHz, Sweep time: auto.

# TR-4-E-009 Radiated Emission Test Result

**Test Site** : DDT 3m Chamber 2#

D:\2021 RE2# Report Data\Q21022514- HUYINBIN\14E  
ACAPPELLA\FCC ABOVE 1G.EM6

**Test Date** : 2021-04-26

**Tested By** : Zora

**EUT** : Bluetooth Speaker

**Model Number** : aCAPPELLA

**Power Supply** : Battery

**Test Mode** : Tx mode

**Condition** : Temp:24.5°C,Humi:55%,Press:100.1kPa

**Antenna/Distance** : 2020 BBHA9120D/3m/HORIZONTAL

**Memo** : 2DH5 2402

Data: 6

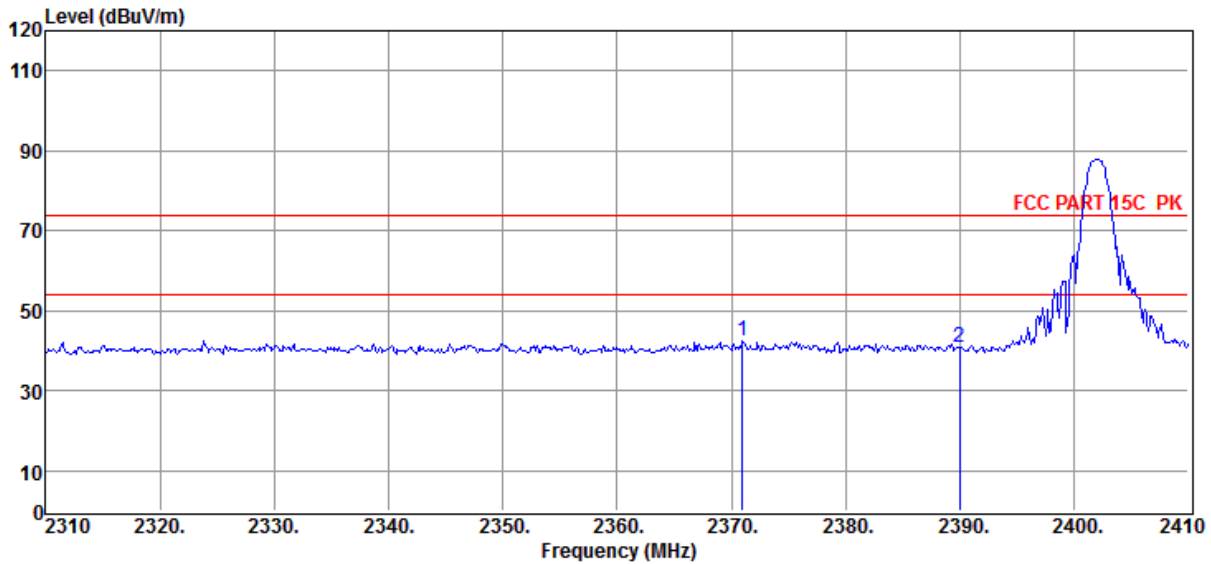

Item (Mark)	Freq. (MHz)	Read Level (dBμV)	Antenna Factor (dB/m)	PRM Factor dB	Cable Loss dB	Result Level (dBμV/m)	Limit Line (dBμV/m)	Over Limit (dB)	Detector	Polarization
1	2371.00	52.82	27.87	43.12	4.78	42.35	74.00	-31.65	Peak	HORIZONTAL
2	2390.00	51.38	27.89	43.14	4.80	40.93	74.00	-33.07	Peak	HORIZONTAL

Note: 1. Result Level = Read Level + Antenna Factor + Cable loss - PRM Factor.

2. If Peak Result complies with AV limit, AV Result is deemed to comply with AV limit.

3. Test setup: RBW: 1 MHz, VBW: 3 MHz, Sweep time: auto.

# TR-4-E-009 Radiated Emission Test Result

**Test Site** : DDT 3m Chamber 2#

D:\2021 RE2# Report Data\Q21022514- HUYINBIN\14E  
ACAPPELLA\FCC ABOVE 1G.EM6

**Test Date** : 2021-04-26

**Tested By** : Zora

**EUT** : Bluetooth Speaker

**Model Number** : aCAPPELLA

**Power Supply** : Battery

**Test Mode** : Tx mode

**Condition** : Temp:24.5°C,Humi:55%,Press:100.1kPa

**Antenna/Distance** : 2020 BBHA9120D/3m/VERTICAL

**Memo** : 2DH5 2480

Data: 7

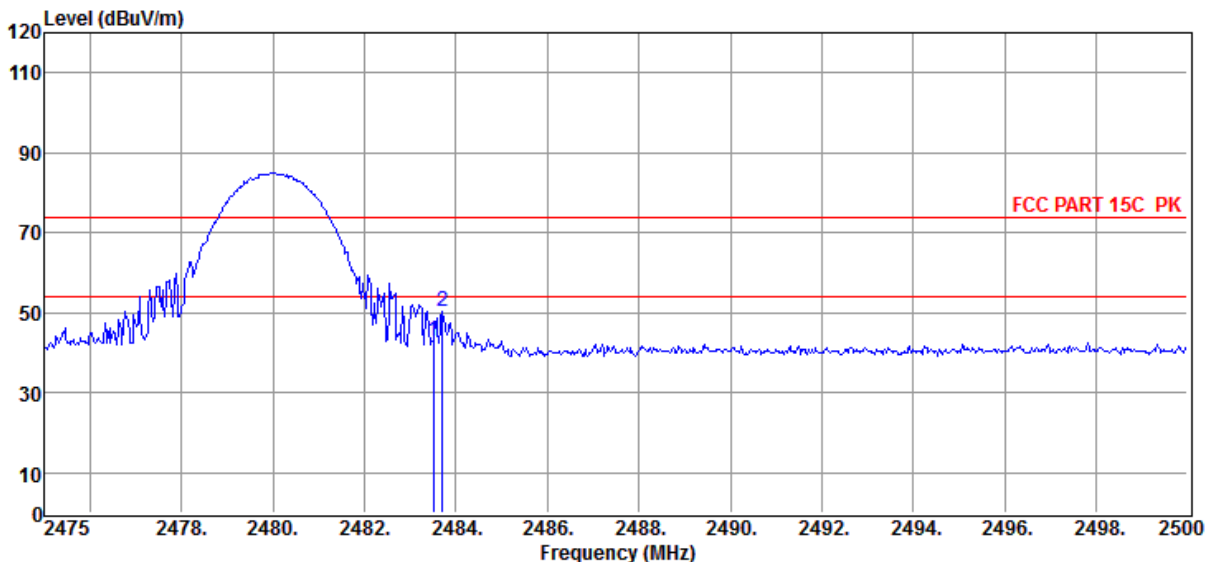

Item (Mark)	Freq. (MHz)	Read Level (dBμV)	Antenna Factor (dB/m)	PRM Factor dB	Cable Loss dB	Result Level (dBμV/m)	Limit Line (dBμV/m)	Over Limit (dB)	Detector	Polarization
1	2483.50	53.31	27.98	43.23	4.90	42.96	74.00	-31.04	Peak	VERTICAL
2	2483.70	60.77	27.98	43.23	4.90	50.42	74.00	-23.58	Peak	VERTICAL

Note: 1. Result Level = Read Level + Antenna Factor + Cable loss - PRM Factor.

2. If Peak Result complies with AV limit, AV Result is deemed to comply with AV limit.

3. Test setup: RBW: 1 MHz, VBW: 3 MHz, Sweep time: auto.



# TR-4-E-009 Radiated Emission Test Result

**Test Site** : DDT 3m Chamber 2#

D:\2021 RE2# Report Data\Q21022514- HUYINBIN\14E  
ACAPPELLA\FCC ABOVE 1G.EM6

**Test Date** : 2021-04-26

**Tested By** : Zora

**EUT** : Bluetooth Speaker

**Model Number** : aCAPPELLA

**Power Supply** : Battery

**Test Mode** : Tx mode

**Condition** : Temp:24.5°C,Humi:55%,Press:100.1kPa

**Antenna/Distance** : 2020 BBHA9120D/3m/HORIZONTAL

**Memo** : 2DH5 2480

Data: 8

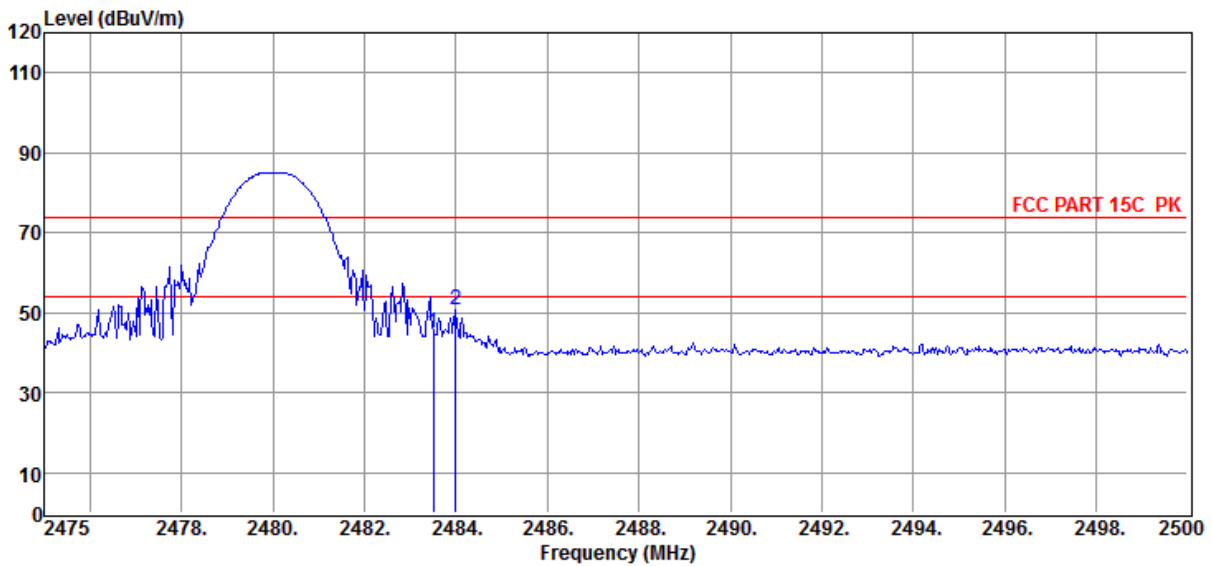

Item (Mark)	Freq. (MHz)	Read Level (dBμV)	Antenna Factor (dB/m)	PRM Factor (dB)	Cable Loss (dB)	Result Level (dBμV/m)	Limit Line (dBμV/m)	Over Limit (dB)	Detector	Polarization
1	2483.50	55.17	27.98	43.23	4.90	44.82	74.00	-29.18	Peak	HORIZONTAL
2	2484.00	61.06	27.98	43.23	4.90	50.71	74.00	-23.29	Peak	HORIZONTAL

Note: 1. Result Level = Read Level + Antenna Factor + Cable loss - PRM Factor.

2. If Peak Result complies with AV limit, AV Result is deemed to comply with AV limit.

3. Test setup: RBW: 1 MHz, VBW: 3 MHz, Sweep time: auto.



# TR-4-E-009 Radiated Emission Test Result

**Test Site** : DDT 3m Chamber 2#

D:\2021 RE2# Report Data\Q21022514- HUYINBIN\14E  
ACAPPELLA\FCC ABOVE 1G.EM6

**Test Date** : 2021-04-26

**Tested By** : Zora

**EUT** : Bluetooth Speaker

**Model Number** : aCAPPELLA

**Power Supply** : Battery

**Test Mode** : Tx mode

**Condition** : Temp:24.5°C,Humi:55%,Press:100.1kPa

**Antenna/Distance** : 2020 BBHA9120D/3m/VERTICAL

**Memo** : 3DH5 2402

Data: 9

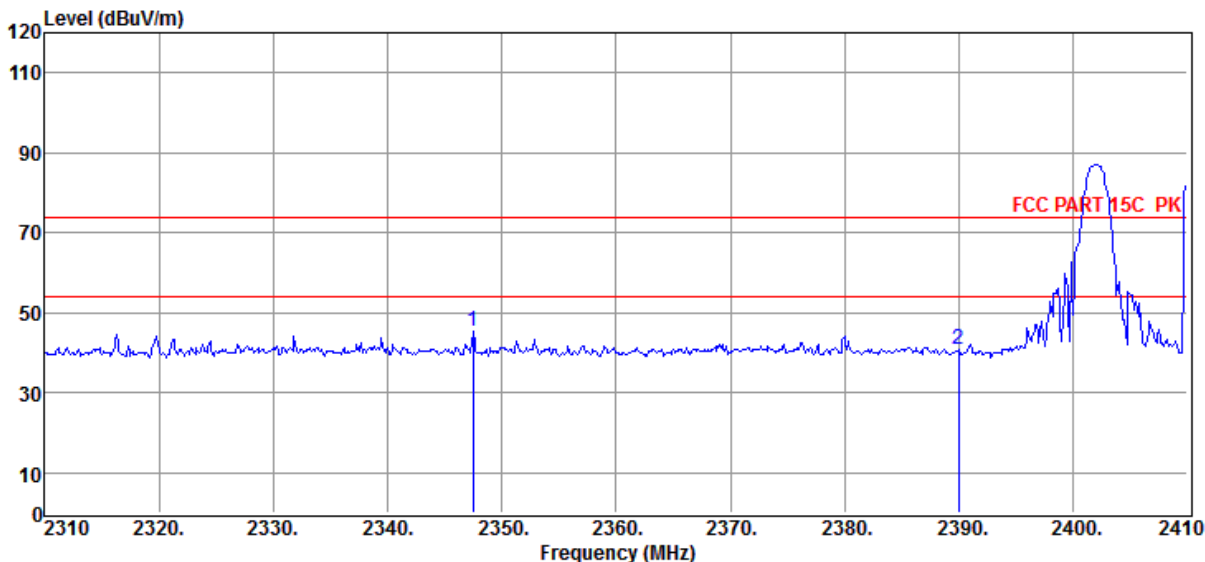

Item (Mark)	Freq. (MHz)	Read Level (dBμV)	Antenna Factor (dB/m)	PRM Factor (dB)	Cable Loss (dB)	Result Level (dBμV/m)	Limit Line (dBμV/m)	Over Limit (dB)	Detector	Polarization
1	2347.50	55.84	27.85	43.10	4.75	45.34	74.00	-28.66	Peak	VERTICAL
2	2390.00	51.08	27.89	43.14	4.80	40.63	74.00	-33.37	Peak	VERTICAL

Note: 1. Result Level = Read Level + Antenna Factor + Cable loss - PRM Factor.

2. If Peak Result complies with AV limit, AV Result is deemed to comply with AV limit.

3. Test setup: RBW: 1 MHz, VBW: 3 MHz, Sweep time: auto.

# TR-4-E-009 Radiated Emission Test Result

**Test Site** : DDT 3m Chamber 2#

D:\2021 RE2# Report Data\Q21022514- HUYINBIN\14E  
ACAPPELLA\FCC ABOVE 1G.EM6

**Test Date** : 2021-04-26

**Tested By** : Zora

**EUT** : Bluetooth Speaker

**Model Number** : aCAPPELLA

**Power Supply** : Battery

**Test Mode** : Tx mode

**Condition** : Temp:24.5°C,Humi:55%,Press:100.1kPa

**Antenna/Distance** : 2020 BBHA9120D/3m/HORIZONTAL

**Memo** : 3DH5 2402

Data: 10

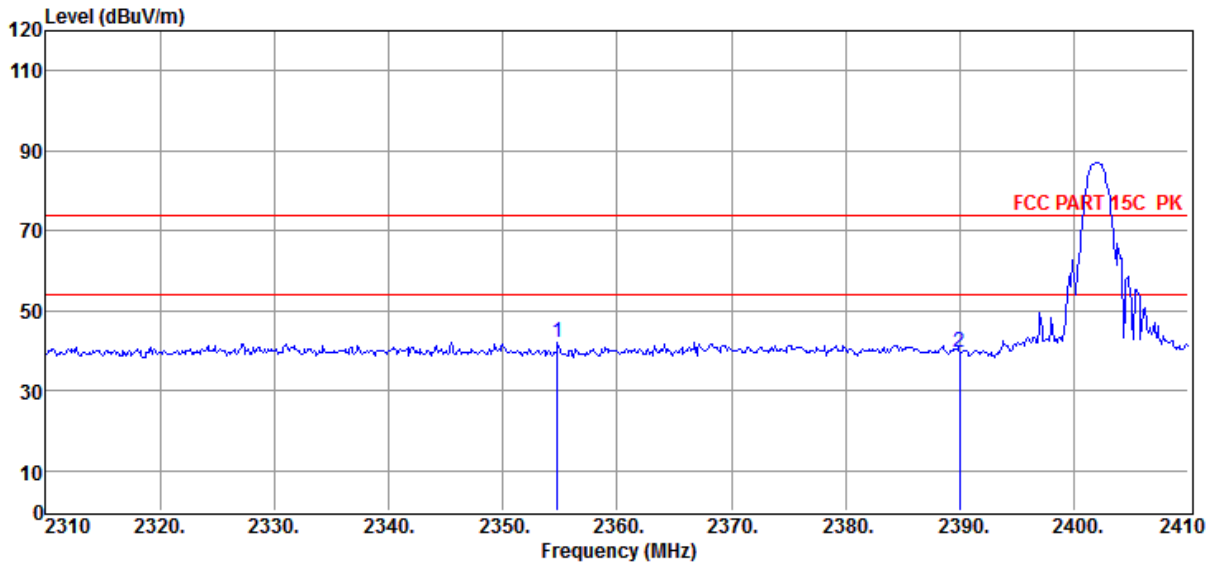

Item (Mark)	Freq. (MHz)	Read Level (dBμV)	Antenna Factor (dB/m)	PRM Factor (dB)	Cable Loss (dB)	Result Level (dBμV/m)	Limit Line (dBμV/m)	Over Limit (dB)	Detector	Polarization
1	2354.80	52.62	27.85	43.10	4.76	42.13	74.00	-31.87	Peak	HORIZONTAL
2	2390.00	50.01	27.89	43.14	4.80	39.56	74.00	-34.44	Peak	HORIZONTAL

Note: 1. Result Level = Read Level + Antenna Factor + Cable loss - PRM Factor.

2. If Peak Result complies with AV limit, AV Result is deemed to comply with AV limit.

3. Test setup: RBW: 1 MHz, VBW: 3 MHz, Sweep time: auto.

# TR-4-E-009 Radiated Emission Test Result

**Test Site** : DDT 3m Chamber 2#

D:\2021 RE2# Report Data\Q21022514- HUYINBIN\14E  
ACAPPELLA\FCC ABOVE 1G.EM6

**Test Date** : 2021-04-26

**Tested By** : Zora

**EUT** : Bluetooth Speaker

**Model Number** : aCAPPELLA

**Power Supply** : Battery

**Test Mode** : Tx mode

**Condition** : Temp:24.5°C,Humi:55%,Press:100.1kPa

**Antenna/Distance** : 2020 BBHA9120D/3m/HORIZONTAL

**Memo** : 3DH5 2480

Data: 11

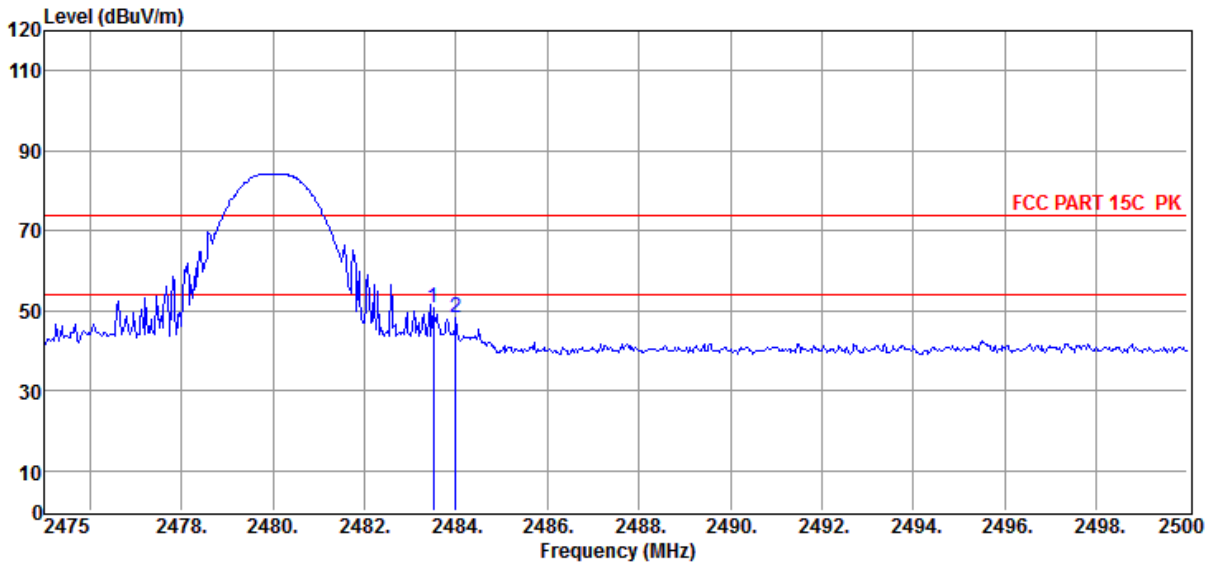

Item (Mark)	Freq. (MHz)	Read Level (dBμV)	Antenna Factor (dB/m)	PRM Factor (dB)	Cable Loss (dB)	Result Level (dBμV/m)	Limit Line (dBμV/m)	Over Limit (dB)	Detector	Polarization
1	2483.50	60.91	27.98	43.23	4.90	50.56	74.00	-23.44	Peak	HORIZONTAL
2	2484.00	58.67	27.98	43.23	4.90	48.32	74.00	-25.68	Peak	HORIZONTAL

Note: 1. Result Level = Read Level + Antenna Factor + Cable loss - PRM Factor.

2. If Peak Result complies with AV limit, AV Result is deemed to comply with AV limit.

3. Test setup: RBW: 1 MHz, VBW: 3 MHz, Sweep time: auto.

# TR-4-E-009 Radiated Emission Test Result

**Test Site** : DDT 3m Chamber 2#

D:\2021 RE2# Report Data\Q21022514- HUYINBIN\14E ACAPPELLA\FCC ABOVE 1G.EM6

**Test Date** : 2021-04-26

**Tested By** : Zora

**EUT** : Bluetooth Speaker

**Model Number** : aCAPPELLA

**Power Supply** : Battery

**Test Mode** : Tx mode

**Condition** : Temp:24.5°C,Humi:55%,Press:100.1kPa

**Antenna/Distance** : 2020 BBHA9120D/3m/VERTICAL

**Memo** : 3DH5 2480

Data: 12

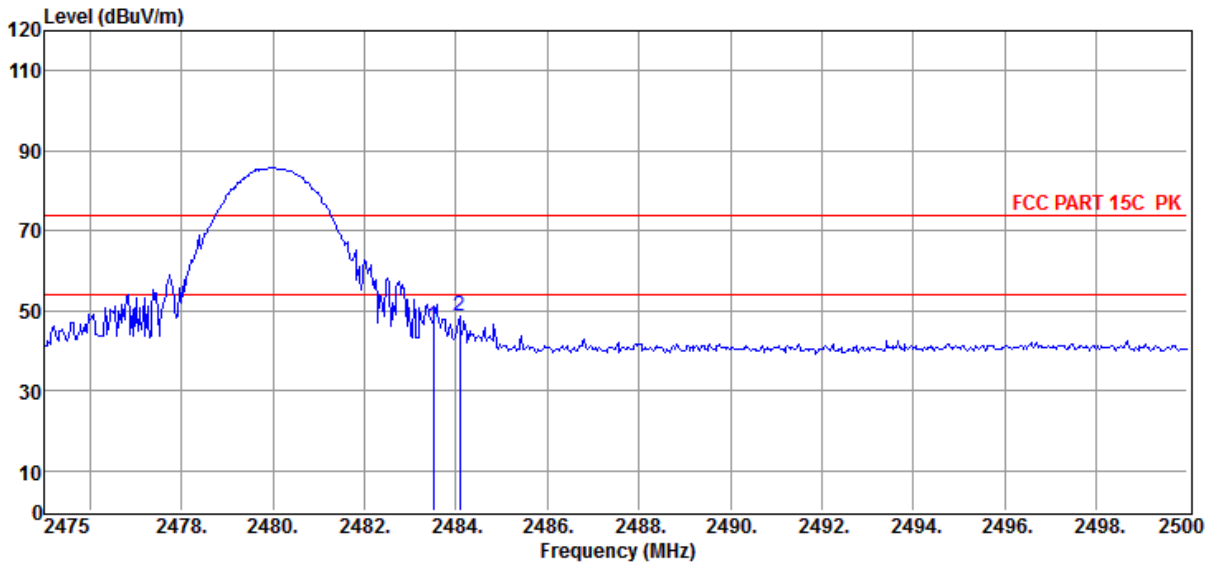

Item (Mark)	Freq. (MHz)	Read Level (dBμV)	Antenna Factor (dB/m)	PRM Factor (dB)	Cable Loss (dB)	Result Level (dBμV/m)	Limit Line (dBμV/m)	Over Limit (dB)	Detector	Polarization
1	2483.50	56.44	27.98	43.23	4.90	46.09	74.00	-27.91	Peak	VERTICAL
2	2484.08	59.07	27.98	43.23	4.90	48.72	74.00	-25.28	Peak	VERTICAL

Note: 1. Result Level = Read Level + Antenna Factor + Cable loss - PRM Factor.

2. If Peak Result complies with AV limit, AV Result is deemed to comply with AV limit.

3. Test setup: RBW: 1 MHz, VBW: 3 MHz, Sweep time: auto.

## 13. Power Line Conducted Emission

### 13.1. Block diagram of test setup

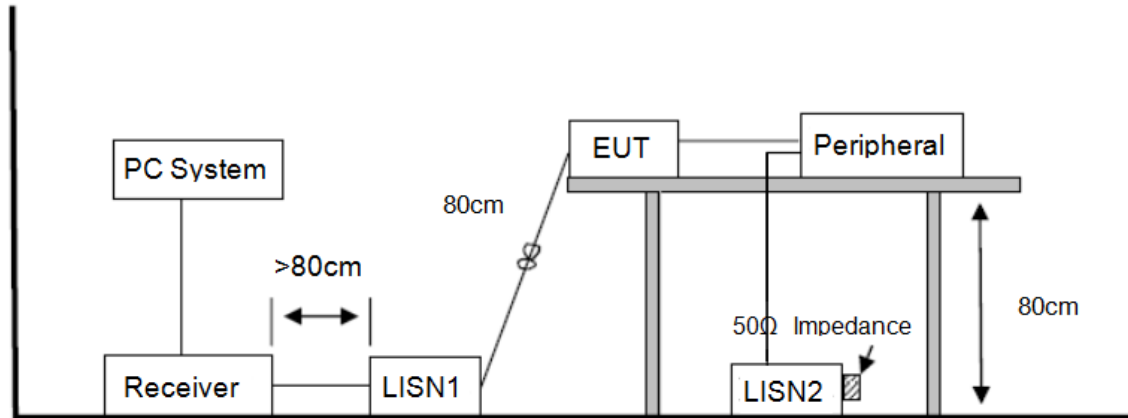

### 13.2. Power line conducted emission limits

Frequency	Quasi-Peak Level dB( $\mu$ V)	Average Level dB( $\mu$ V)
150 kHz ~ 500 kHz	66 ~ 56*	56 ~ 46*
500 kHz ~ 5 MHz	56	46
5 MHz ~ 30 MHz	60	50

Note 1: \* Decreasing linearly with logarithm of frequency.

Note 2: The lower limit shall apply at the transition frequencies.

### 13.3. Test procedure

The EUT and Support equipment, if needed, were put placed on a non-metallic table, 80cm above the ground plane.

Configuration EUT to simulate typical usage as described in clause 2.4 and test equipment as described in clause 10.2 of this report.

All I/O cables were positioned to simulate typical actual usage as per ANSI C63.10.

All support equipment power received from a second LISN.

Emissions were measured on each current carrying line of the EUT using an EMI Test Receiver connected to the LISN powering the EUT.

The Receiver scanned from 150 kHz to 30 MHz for emissions in each of the test modes.

During the above scans, the emissions were maximized by cable manipulation.

The test mode(s) described in clause 2.4 were scanned during the preliminary test.

After the preliminary scan, we found the test mode producing the highest emission level.

The EUT configuration and worse cable configuration of the above highest emission levels were recorded for reference of the final test.

EUT and support equipment were set up on the test bench as per the configuration with highest emission level in the preliminary test.

A scan was taken on both power lines, Neutral and Line, recording at least the six highest emissions.

Emission frequency and amplitude were recorded into a computer in which correction factors were used to calculate the emission level and compare reading to the applicable limit.

The test data of the worst-case condition(s) was recorded.

The bandwidth of test receiver is set at 9 kHz.

#### 13.4. Test result

Pass. (See below detailed test result)

Note1: All emissions not reported below are too low against the prescribed limits.

Note2: "----" means Peak detection; "----" means Average detection.

Note3: Pre-test AC conducted emission at both voltage AC 120V/60Hz and AC 240V/50Hz, recorded worse case.

# TR-4-E-010 Conducted Emission Test Result

**Test Site** : DDT 1# Shield Room D:\2021 CE report date\Q21022514-11E\20210316.EM6  
**Test Date** : 2021-03-16 **Tested By** : Chunchieh Huang  
**EUT** : Bluetooth Speaker **Model Number** : aCAPPELLA  
**Power Supply** : AC 120V/60Hz **Test Mode** : Tx mode  
**Condition** : TEMP:24.8°C, RH:53.8%,  
**LISN** : 2020 ENV 216 1#/LINE  
BP:101.4kPa

**Memo** :

Data: 56

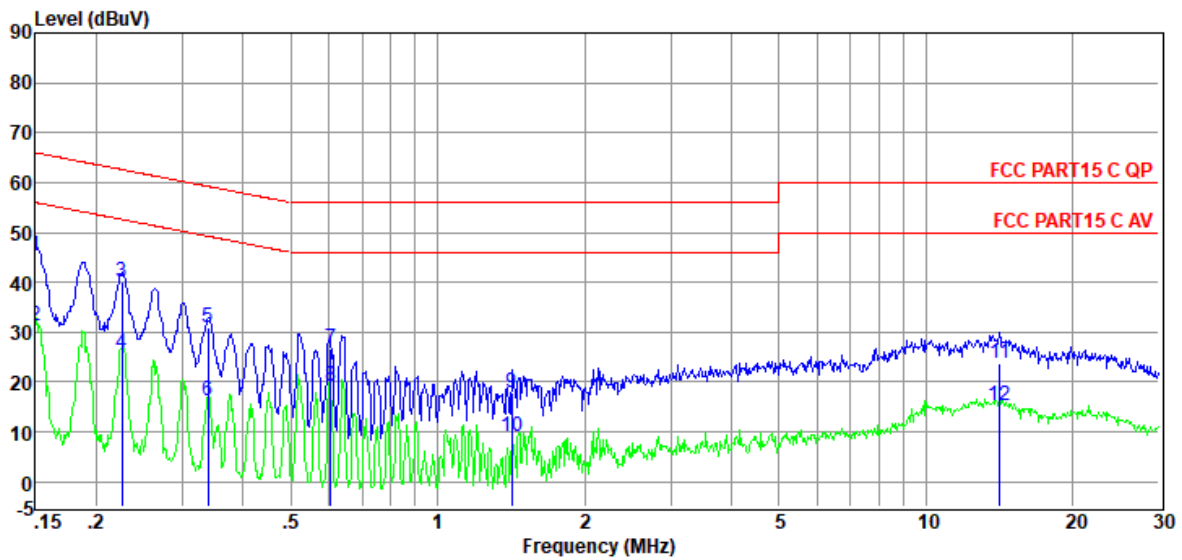

Item (Mark)	Freq. (MHz)	Read Level (dBμV)	LISN Factor (dB)	Cable Loss (dB)	Pulse Limiter Factor (dB)	Result Level (dBμV)	Limit Line (dBμV)	Over Limit (dB)	Detector	Phase
1	0.15	26.16	9.39	0.02	9.86	45.43	66.00	-20.57	QP	LINE
2	0.15	11.97	9.39	0.02	9.86	31.24	56.00	-24.76	Average	LINE
3	0.23	20.64	9.40	0.02	9.86	39.92	62.61	-22.69	QP	LINE
4	0.23	6.38	9.40	0.02	9.86	25.66	52.61	-26.95	Average	LINE
5	0.34	11.64	9.41	0.02	9.86	30.93	59.22	-28.29	QP	LINE
6	0.34	-3.11	9.41	0.02	9.86	16.18	49.22	-33.04	Average	LINE
7	0.60	7.44	9.42	0.02	9.86	26.74	56.00	-29.26	QP	LINE
8	0.60	-0.06	9.42	0.02	9.86	19.24	46.00	-26.76	Average	LINE
9	1.42	-1.62	9.42	0.04	9.86	17.70	56.00	-38.30	QP	LINE
10	1.42	-10.21	9.42	0.04	9.86	9.11	46.00	-36.89	Average	LINE
11	14.14	4.18	9.63	0.13	9.92	23.86	60.00	-36.14	QP	LINE
12	14.14	-4.41	9.63	0.13	9.92	15.27	50.00	-34.73	Average	LINE

Note:

1. Result Level = Read Level + LISN Factor + Pulse Limiter Factor + Cable loss.
2. If QP Result complies with AV limit, AV Result is deemed to comply with AV limit.
3. Test setup: RBW: 200 Hz (9 kHz—150 kHz), 9 kHz (150 kHz—30 MHz).
4. Step size: 80Hz (0.009MHz-0.15MHz), 4 kHz (0.15MHz-30MHz), Scan time: auto.



# TR-4-E-010 Conducted Emission Test Result

**Test Site** : DDT 1# Shield Room D:\2021 CE report date\Q21022514-11E\20210316.EM6  
**Test Date** : 2021-03-16 **Tested By** : Chunchieh Huang  
**EUT** : Bluetooth Speaker **Model Number** : aCAPPELLA  
**Power Supply** : AC 120V/60Hz **Test Mode** : Tx mode  
**Condition** : TEMP:24.8°C, RH:53.8%,  
**LISN** : 2020 ENV 216 1#/LINE  
BP:101.4kPa

**Memo** :

Data: 58

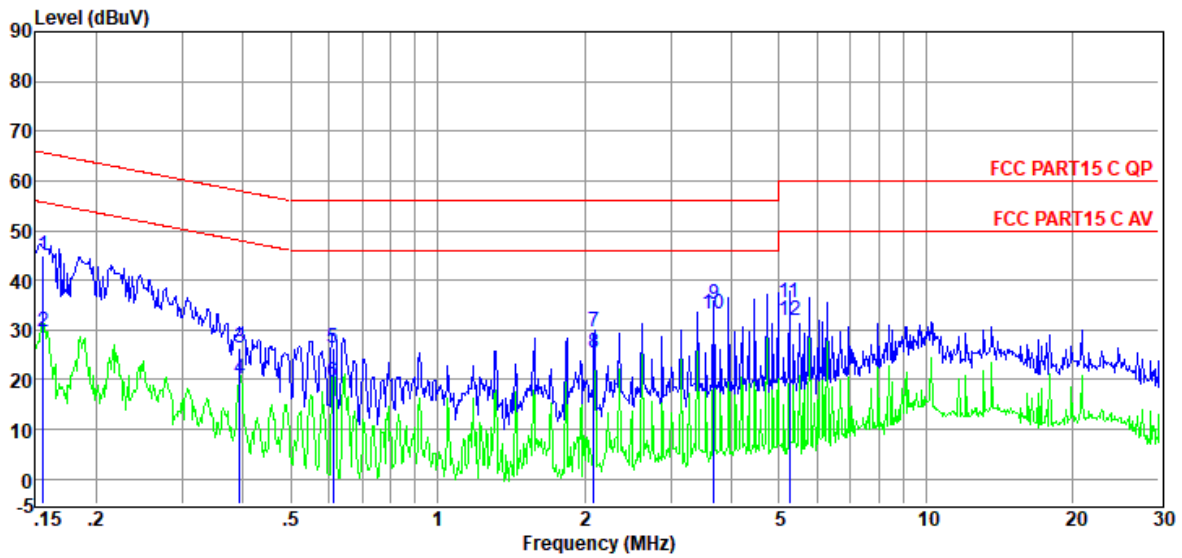

Item (Mark)	Freq. (MHz)	Read Level (dBµV)	LISN Factor (dB)	Cable Loss (dB)	Pulse Limiter Factor (dB)	Result Level (dBµV)	Limit Line (dBµV)	Over Limit (dB)	Detector	Phase
1	0.16	25.68	9.39	0.02	9.86	44.95	65.69	-20.74	QP	LINE
2	0.16	10.47	9.39	0.02	9.86	29.74	55.69	-25.95	Average	LINE
3	0.39	7.05	9.41	0.02	9.86	26.34	57.99	-31.65	QP	LINE
4	0.39	0.70	9.41	0.02	9.86	19.99	47.99	-28.00	Average	LINE
5	0.61	7.15	9.42	0.02	9.86	26.45	56.00	-29.55	QP	LINE
6	0.61	0.06	9.42	0.02	9.86	19.36	46.00	-26.64	Average	LINE
7	2.09	10.15	9.42	0.05	9.87	29.49	56.00	-26.51	QP	LINE
8	2.09	5.87	9.42	0.05	9.87	25.21	46.00	-20.79	Average	LINE
9	3.68	15.74	9.46	0.07	9.87	35.14	56.00	-20.86	QP	LINE
10	3.68	13.75	9.46	0.07	9.87	33.15	46.00	-12.85	Average	LINE
11	5.25	16.19	9.50	0.08	9.87	35.64	60.00	-24.36	QP	LINE
12	5.25	12.59	9.50	0.08	9.87	32.04	50.00	-17.96	Average	LINE

Note:

1. Result Level = Read Level + LISN Factor + Pulse Limiter Factor + Cable loss.
2. If QP Result complies with AV limit, AV Result is deemed to comply with AV limit.
3. Test setup: RBW: 200 Hz (9 kHz—150 kHz), 9 kHz (150 kHz—30 MHz).
4. Step size: 80Hz (0.009MHz-0.15MHz), 4 kHz (0.15MHz-30MHz), Scan time: auto.



## 14. Antenna Requirements

### 14.1. Limit

For intentional device, according to FCC 47 CFR Section 15.203, an intentional radiator shall be designed to ensure that no antenna other than that furnished by the responsible party shall be used with the device. And according to FCC 47 CFR Section 15.247 (b), if transmitting antennas of directional gain greater than 6 dBi are used, the power shall be reduced by the amount in dB that the directional gain of the antenna exceeds 6 dBi.

### 14.2. Result

The antenna used for this product is PCB antenna and that no antenna other than that furnished by the responsible party shall be used with the device, the maximum peak gain is 2.9 dBi.