

(2) FCC 15.209 Limit.

Frequency (MHz)	Measurement distance (meters)	Field strength limit	
		$\mu\text{V}/\text{m}$	$\text{dB}(\mu\text{V})/\text{m}$
0.009 ~ 0.490	300	2400/F(kHz)	67.6-20log(F)
0.490 ~ 1.705	30	24000/F(kHz)	87.6-20log(F)
1.705 ~ 30.0	30	30	29.54
30 ~ 88	3	100	40.0
88 ~ 216	3	150	43.5
216 ~ 960	3	200	46.0
960 ~ 1000	3	500	54.0
Above 1000	3	74.0 dB(μV)/m (Peak) 54.0 dB(μV)/m (Average)	

Note: (1) The emission limits shown in the above table are based on measurements employing a CISPR QP detector except for the frequency bands 9-90 kHz, 110-490 kHz and above 1000 MHz, radiated emissions limits in these three bands are based on measurements employing an average detector.

(2) At frequencies below 30 MHz, measurement may be performed at a distance closer than that specified, and the limit at closer measurement distance can be extrapolated by below formula:

$$\text{Limit}_{3\text{m}}(\text{dB}\mu\text{V}/\text{m}) = \text{Limit}_{30\text{m}}(\text{dB}\mu\text{V}/\text{m}) + 40\text{Log}(30\text{m}/3\text{m})$$

(3) Limit for this EUT

All the emissions appearing within 15.205 restricted frequency bands shall not exceed the limits shown in 15.209, all the other emissions shall be at least 20 dB below the fundamental emissions or comply with 15.209 limits.

10.3. Test procedure

- (1) EUT was placed on a non-metallic table, 80 cm above the ground plane inside a semi-anechoic chamber for below 1 G and 150 cm above the ground plane inside a semi-anechoic chamber for above 1 G.
- (2) Test antenna was located 3 m from the EUT on an adjustable mast, and the antenna used as below table.

Test frequency range	Test antenna used	Test antenna distance
9 kHz - 30 MHz	Active Loop antenna	3 m
30 MHz - 1 GHz	Trilog Broadband Antenna	3 m
1 GHz - 18 GHz	Double Ridged Horn Antenna (1 GHz - 18 GHz)	3 m
18 GHz - 40 GHz	Horn Antenna (18 GHz - 40 GHz)	1 m

According ANSI C63.10:2013 clause 6.4.4.2 and 6.5.3, for measurements below 30 MHz, the loop antenna was located 3 m from EUT, the loop antenna was positioned in three antenna

orientations (parallel, perpendicular, and round-parallel), for each measurement antenna alignment, the EUT shall be rotated through 0° to 360° on a turntable, and the lowest height of the magnetic antenna shall be 1 m above the ground. For measurement above 30 MHz, the Broadband Antenna or Horn Antenna was located 3 m from EUT, Measurements were made with the antenna positioned in both the horizontal and vertical planes of Polarization, and the measurement antenna was varied from 1 m to 4 m. in height above the reference ground plane to obtain the maximum signal strength.

(3) Below pre-scan procedure was first performed in order to find prominent frequency spectrum radiated emissions from 9 kHz to 25 GHz:

(a) Scanning the peak frequency spectrum with the antenna specified in step (3), and the EUT was rotated 360 degree, the antenna height was varied from 1 m to 4 m (Except loop antenna, it's fixed 1 m above ground.)

(b) Change work frequency or channel of device if practicable.

(c) Change modulation type of device if practicable.

(d) Change power supply range from 85% to 115% of the rated supply voltage

(e) Rotated EUT though three orthogonal axes to determine the attitude of EUT arrangement produces highest emissions.

Spectrum frequency from 9 kHz to 25 GHz (tenth harmonic of fundamental frequency) was investigated, and no any obvious emission were detected from 18 GHz to 25 GHz, so below final test was performed with frequency range from 9 kHz to 18 GHz.

(4) For final emissions measurements at each frequency of interest, the EUT was rotated and the antenna height was varied between 1 m and 4 m in order to maximize the emission.

Measurements in both horizontal and vertical polarities were made and the data was recorded.

In order to find the maximum emission, the relative positions of equipment and all of the interface cables were changed according to ANSI C63.10:2013 on Radiated Emission test.

(5) The emissions from 9 kHz to 1 GHz were measured based on CISPR QP detector except for the frequency bands 9-90 kHz, 110-490 kHz, for emissions from 9 kHz - 90 kHz, 110 kHz - 490 kHz and above 1 GHz were measured based on average detector, for emissions above 1 GHz, peak emissions also be measured and need comply with Peak limit.

(6) The emissions from 9 kHz to 1 GHz, QP or average values were measured with EMI receiver with below RBW.

Frequency band	RBW
9 kHz - 150 kHz	200 Hz
150 kHz - 30 MHz	9 kHz
30 MHz - 1 GHz	120 kHz

(7) For emissions above 1 GHz, both Peak and Average level were measured with Spectrum Analyzer, and the RBW is set at 1 MHz, VBW is set at 3 MHz for Peak measure; according ANSI C63.10:2013 clause 4.1.4.2 procedure for average measure.

10.4. Test result

Pass. (See below detailed test result)

All the emissions except fundamental emission from 9 kHz to 25 GHz were comply with 15.209 limits.

Note1: According exploratory test, the emission levels are 20 dB below the limit detected from 9 kHz to 30 MHz and 18 GHz to 25 GHz, so the final test was performed with frequency range from 30 MHz to 18 GHz and recorded in below.

Note2: For emissions below 1 GHz, according exploratory explorer test, when change Tx mode and channel, have no distinct influence on emissions level, so for emissions below 1 GHz, the final test was only performed with EUT working in 8DPSK, Tx 2480 MHz mode.

Note3: For emissions above 1 GHz, Scan with GFSK, $\pi/4$ -DQPSK and 8DPSK, the worst case is 8DPSK mode. If peak results comply with AV limit, AV Result is deemed to comply with AV limit.

Other emissions are attenuated 20 dB below the limits, so it does not record.

Radiated Emission test (below 1 GHz)

TR-4-E-009 Radiated Emission Test Result

Test Site : DDT 3m Chamber 3#

D:\E3 6.111\2022 Report Data\Q22061414-23E aBOOM+FCC BELOW 1G.EM6

Test Date : 2022-09-21

Tested By : James Gan

EUT : Bluetooth Speaker

Model Number : aBOOM+

Power Supply : AC 120V/60Hz

Test Mode : Tx Mode

Condition : Temp:23.5°C,Humi:54.8%,Press:100.3kPa

Antenna/Distance : 2022 VLUB9163 #3/3m/VERTICAL

Memo :

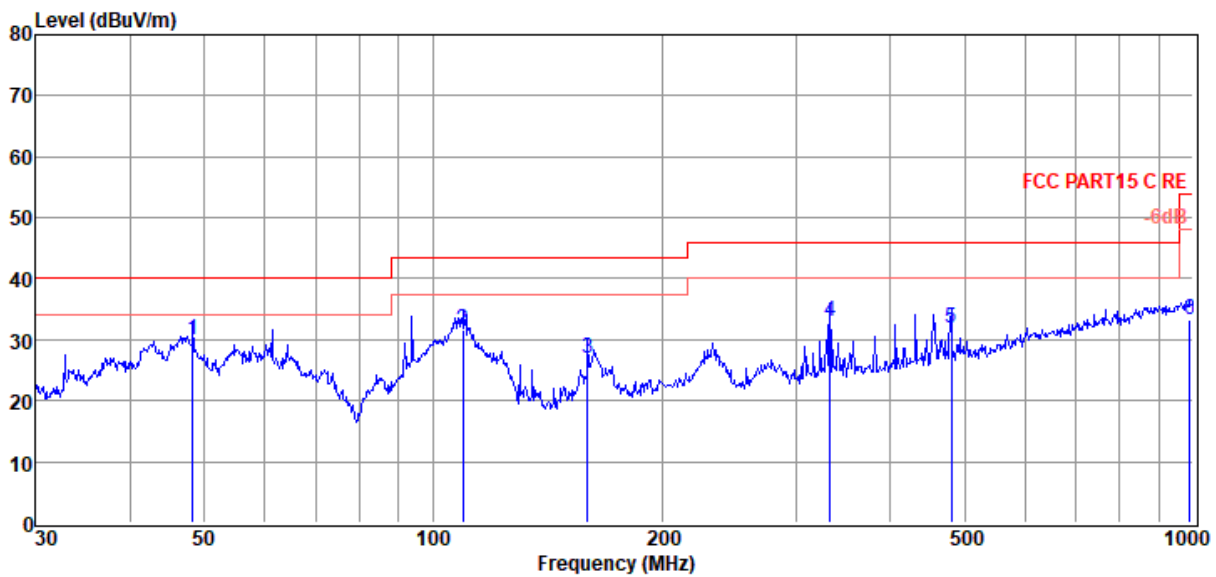

Item (Mark)	Freq. (MHz)	Read Level (dBμV)	Antenna Factor (dB/m)	Cable Loss (dB)	Result Level (dBμV/m)	Limit Line (dBμV/m)	Over Limit (dB)	Detector	Polarization
1	48.33	13.19	13.20	3.66	30.05	40.00	-9.95	QP	VERTICAL
2	109.41	16.95	10.56	4.04	31.55	43.50	-11.95	QP	VERTICAL
3	159.78	14.60	7.98	4.30	26.88	43.50	-16.62	QP	VERTICAL
4	332.52	13.79	14.15	4.94	32.88	46.00	-13.12	QP	VERTICAL
5	480.53	9.80	16.61	5.42	31.83	46.00	-14.17	QP	VERTICAL
6	989.54	3.59	22.99	6.78	33.36	54.00	-20.64	QP	VERTICAL

Note: 1. Result Level = Read Level + Antenna Factor + Cable loss.

2. If Peak Result complies with QP limit, QP Result is deemed to comply with QP limit.

3. Test setup: RBW: 120 kHz, VBW: 300 kHz, Sweep time: auto.

TR-4-E-009 Radiated Emission Test Result

Test Site : DDT 3m Chamber 3# D:\E3 6.111\2022 Report Data\Q22061414-23E aBOOM+FCC BELOW 1G.EM6
Test Date : 2022-09-21 **Tested By** : James Gan
EUT : Bluetooth Speaker **Model Number** : aBOOM+
Power Supply : AC 120V/60Hz **Test Mode** : Tx Mode
Condition : Temp:23.5°C,Humi:54.8%,Press:100.3kPa **Antenna/Distance** : 2022 VLUB9163 #3/3m/HORIZONTAL
Memo :

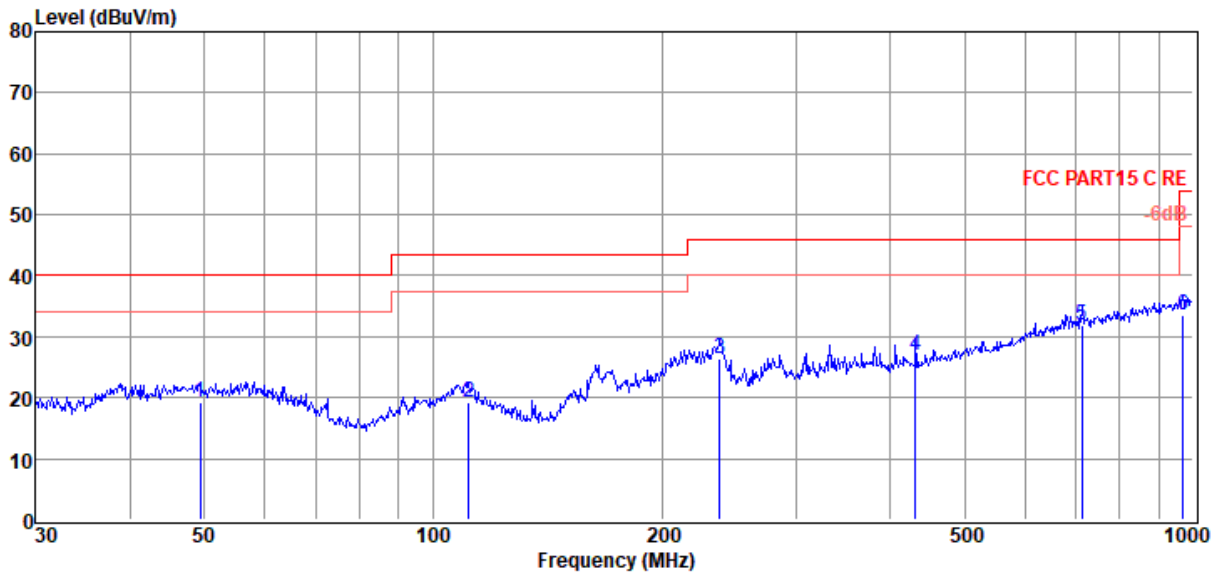

Item (Mark)	Freq. (MHz)	Read Level (dBμV)	Antenna Factor (dB/m)	Cable Loss (dB)	Result Level (dBμV/m)	Limit Line (dBμV/m)	Over Limit (dB)	Detector	Polarization
1	49.36	2.47	13.16	3.67	19.30	40.00	-20.70	QP	HORIZONTAL
2	111.35	5.05	10.27	4.05	19.37	43.50	-24.13	QP	HORIZONTAL
3	238.31	9.90	11.97	4.61	26.48	46.00	-19.52	QP	HORIZONTAL
4	431.03	5.70	15.86	5.26	26.82	46.00	-19.18	QP	HORIZONTAL
5	714.17	5.73	20.20	6.02	31.95	46.00	-14.05	QP	HORIZONTAL
6	968.93	4.19	22.80	6.67	33.66	54.00	-20.34	QP	HORIZONTAL

Note: 1. Result Level = Read Level + Antenna Factor + Cable loss.
 2. If Peak Result complies with QP limit, QP Result is deemed to comply with QP limit.
 3. Test setup: RBW: 120 kHz, VBW: 300 kHz, Sweep time: auto.

Radiated Emission test (above 1 GHz)

TR-4-E-009 Radiated Emission Test Result

Test Site : DDT 3m Chamber 3#
Test Date : 2022-09-06
EUT : Bluetooth Speaker
Power Supply : AC 120V/60Hz
Condition : Temp:22°C,Humi:59.4%,Press:100.3kPa
Memo : 3DH5 2402

Tested By : Bairong
Model Number : aBOOM+
Test Mode : Tx Mode
Antenna/Distance : 2021 BBHA 9120D
 3#/3m/HORIZONTAL

D:\E3 6.111\2022 Report Data\Q22061414-23E
 aBOOM+\FCC ABOVE 1G .EM6

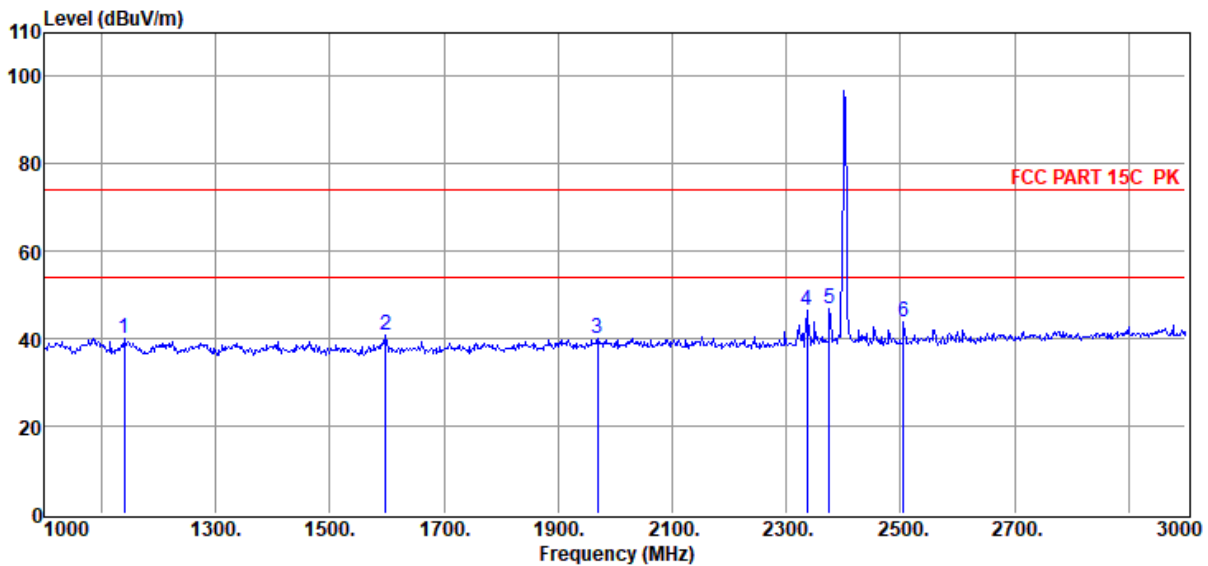

Item (Mark)	Freq. (MHz)	Read Level (dBuV)	Antenna Factor (dB/m)	PRM Factor (dB)	Cable Loss (dB)	Filter Factor (dB)	Result Level (dBuV/m)	Limit Line (dBuV/m)	Over Limit (dB)	Detector	Polarization
1	1140.00	51.10	25.47	38.11	1.18	0.53	40.17	74.00	-33.83	Peak	HORIZONTAL
2	1598.00	51.86	25.65	38.80	1.42	0.61	40.74	74.00	-33.26	Peak	HORIZONTAL
3	1970.00	50.60	26.62	39.36	1.59	0.67	40.12	74.00	-33.88	Peak	HORIZONTAL
4	2336.00	56.29	27.30	39.57	1.69	0.72	46.43	74.00	-27.57	Peak	HORIZONTAL
5	2376.00	56.75	27.38	39.59	1.71	0.72	46.97	74.00	-27.03	Peak	HORIZONTAL
6	2506.00	53.57	27.62	39.65	1.74	0.74	44.02	74.00	-29.98	Peak	HORIZONTAL

Note: 1. Result Level = Read Level + Antenna Factor + Cable loss + Filter Factor - PRM Factor.
 2. If Peak Result complies with AV limit, AV Result is deemed to comply with AV limit.
 3. Test setup: RBW: 1 MHz, VBW: 3 MHz, Sweep time: auto.

TR-4-E-009 Radiated Emission Test Result

Test Site : DDT 3m Chamber 3#

D:\E3 6.111\2022 Report Data\Q22061414-23E
aBOOM+\FCC ABOVE 1G .EM6

Test Date : 2022-09-06

Tested By : Bairong

EUT : Bluetooth Speaker

Model Number : aBOOM+

Power Supply : AC 120V/60Hz

Test Mode : Tx Mode

Condition : Temp:22°C,Humi:59.4%,Press:100.3kPa

Antenna/Distance : 2021 BBHA 9120D 3#/3m/VERTICAL

Memo : 3DH5 2402

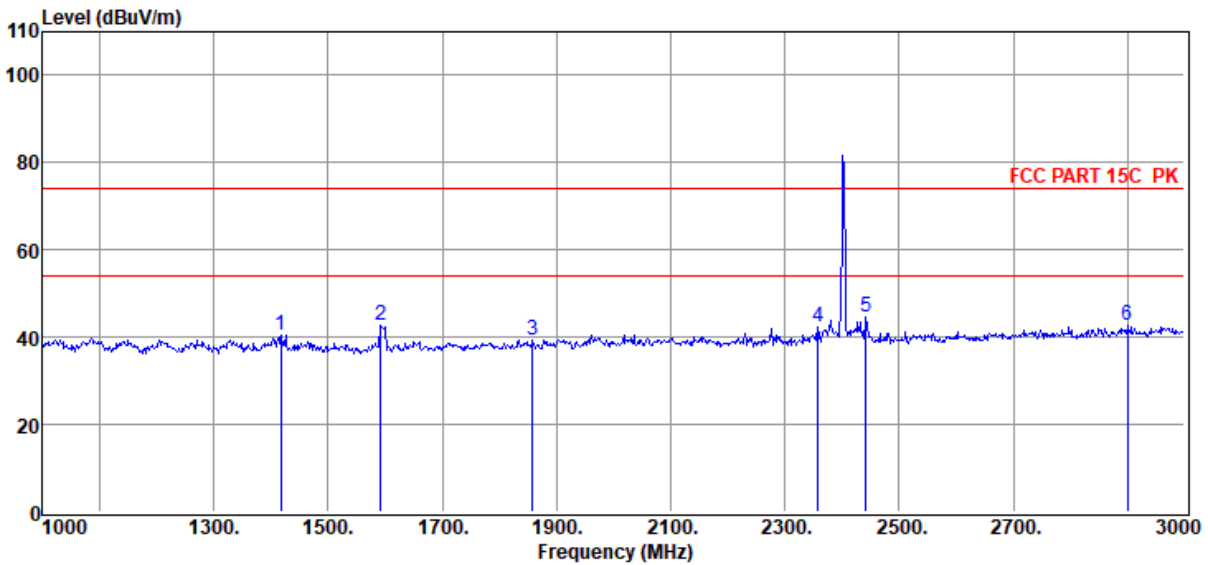

Item (Mark)	Freq. (MHz)	Read Level (dBµV)	Antenna Factor (dB/m)	PRM Factor (dB)	Cable Loss (dB)	Filter Factor (dB)	Result Level (dBµV/m)	Limit Line (dBµV/m)	Over Limit (dB)	Detector	Polarization
1	1418.00	51.64	25.42	38.53	1.33	0.58	40.44	74.00	-33.56	Peak	VERTICAL
2	1592.00	53.89	25.64	38.79	1.42	0.61	42.77	74.00	-31.23	Peak	VERTICAL
3	1858.00	50.05	26.33	39.19	1.54	0.65	39.38	74.00	-34.62	Peak	VERTICAL
4	2358.00	52.32	27.34	39.58	1.70	0.72	42.50	74.00	-31.50	Peak	VERTICAL
5	2442.00	54.39	27.50	39.62	1.72	0.73	44.72	74.00	-29.28	Peak	VERTICAL
6	2900.00	50.76	29.12	39.85	1.84	0.78	42.65	74.00	-31.35	Peak	VERTICAL

Note: 1. Result Level = Read Level + Antenna Factor + Cable loss + Filter Factor - PRM Factor.
 2. If Peak Result complies with AV limit, AV Result is deemed to comply with AV limit.
 3. Test setup: RBW: 1 MHz, VBW: 3 MHz, Sweep time: auto.

TR-4-E-009 Radiated Emission Test Result

Test Site : DDT 3m Chamber 3# D:\E3 6.111\2022 Report Data\Q22061414-23E
aBOOM+\FCC ABOVE 1G .EM6
Test Date : 2022-09-06 **Tested By** : Bairong
EUT : Bluetooth Speaker **Model Number** : aBOOM+
Power Supply : AC 120V/60Hz **Test Mode** : Tx Mode
Condition : Temp:22°C,Humi:59.4%,Press:100.3kPa **Antenna/Distance** : 2021 BBHA 9120D
3#/3m/HORIZONTAL
Memo : 3DH5 2402

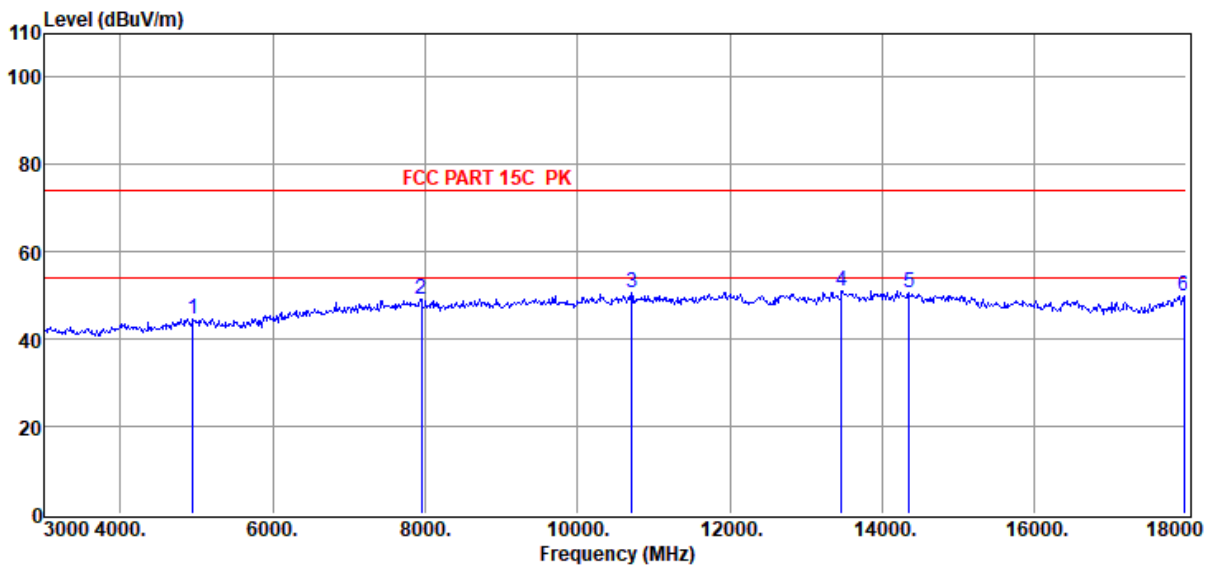

Item (Mark)	Freq. (MHz)	Read Level (dBμV)	Antenna Factor (dB/m)	PRM Factor (dB)	Cable Loss (dB)	Filter Factor (dB)	Result Level (dBμV/m)	Limit Line (dBμV/m)	Over Limit (dB)	Detector	Polarization
1	4950.00	47.49	32.94	40.39	2.52	2.18	44.74	74.00	-29.26	Peak	HORIZONTAL
2	7950.00	46.60	36.94	39.79	3.18	2.28	49.21	74.00	-24.79	Peak	HORIZONTAL
3	10710.00	45.71	39.13	40.32	3.72	2.41	50.65	74.00	-23.35	Peak	HORIZONTAL
4	13470.00	44.32	39.98	40.07	4.01	2.93	51.17	74.00	-22.83	Peak	HORIZONTAL
5	14355.00	43.04	39.90	39.66	4.40	2.80	50.48	74.00	-23.52	Peak	HORIZONTAL
6	17970.00	39.65	42.31	40.68	4.95	3.78	50.01	74.00	-23.99	Peak	HORIZONTAL

Note: 1. Result Level = Read Level + Antenna Factor + Cable loss + Filter Factor - PRM Factor.
 2. If Peak Result complies with AV limit, AV Result is deemed to comply with AV limit.
 3. Test setup: RBW: 1 MHz, VBW: 3 MHz, Sweep time: auto.

TR-4-E-009 Radiated Emission Test Result

Test Site : DDT 3m Chamber 3# D:\E3 6.111\2022 Report Data\Q22061414-23E
aBOOM+\FCC ABOVE 1G .EM6
Test Date : 2022-09-06 **Tested By** : Bairong
EUT : Bluetooth Speaker **Model Number** : aBOOM+
Power Supply : AC 120V/60Hz **Test Mode** : Tx Mode
Condition : Temp:22°C,Humi:59.4%,Press:100.3kPa **Antenna/Distance** : 2021 BBHA 9120D 3#/3m/VERTICAL
Memo : 3DH5 2402

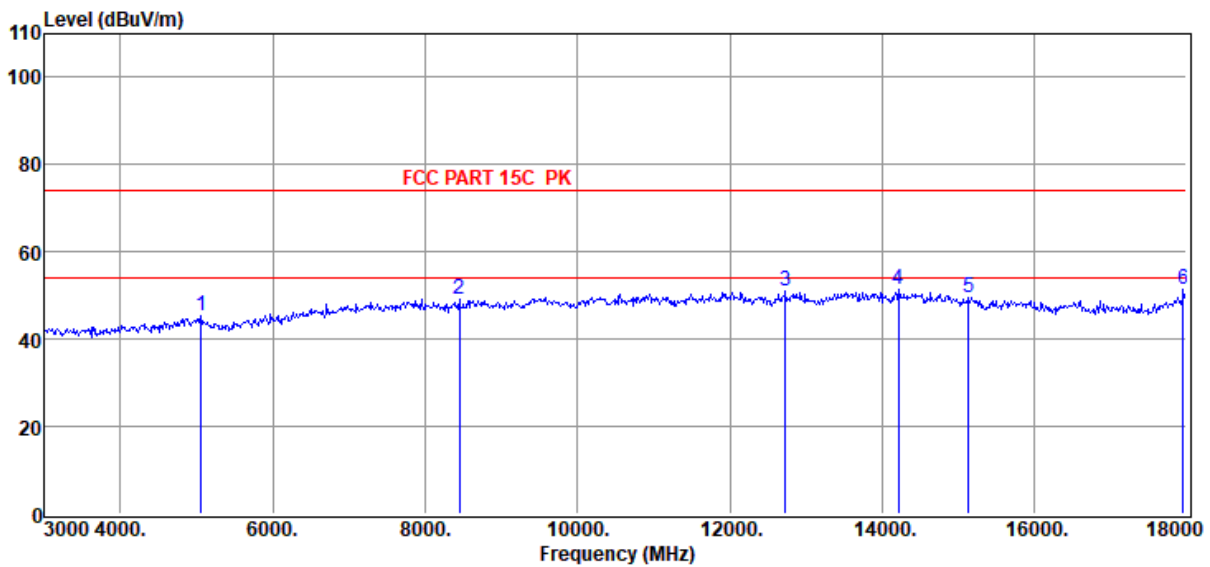

Item (Mark)	Freq. (MHz)	Read Level (dBμV)	Antenna Factor (dB/m)	PRM Factor (dB)	Cable Loss (dB)	Filter Factor (dB)	Result Level (dBμV/m)	Limit Line (dBμV/m)	Over Limit (dB)	Detector	Polarization
1	5055.00	47.75	33.07	40.41	2.54	2.22	45.17	74.00	-28.83	Peak	VERTICAL
2	8445.00	45.63	37.71	39.84	3.22	2.24	48.96	74.00	-25.04	Peak	VERTICAL
3	12735.00	45.42	39.28	40.32	4.03	2.81	51.22	74.00	-22.78	Peak	VERTICAL
4	14220.00	43.73	39.90	39.68	4.45	2.84	51.24	74.00	-22.76	Peak	VERTICAL
5	15135.00	42.64	39.31	39.64	4.49	2.69	49.49	74.00	-24.51	Peak	VERTICAL
6	17955.00	41.17	42.22	40.67	4.95	3.78	51.45	74.00	-22.55	Peak	VERTICAL

Note: 1. Result Level = Read Level + Antenna Factor + Cable loss + Filter Factor - PRM Factor.
 2. If Peak Result complies with AV limit, AV Result is deemed to comply with AV limit.
 3. Test setup: RBW: 1 MHz, VBW: 3 MHz, Sweep time: auto.

TR-4-E-009 Radiated Emission Test Result

Test Site : DDT 3m Chamber 3#

D:\E3 6.111\2022 Report Data\Q22061414-23E
aBOOM+\FCC ABOVE 1G .EM6

Test Date : 2022-09-06

Tested By : Bairong

EUT : Bluetooth Speaker

Model Number : aBOOM+

Power Supply : AC 120V/60Hz

Test Mode : Tx Mode

Condition : Temp:22°C,Humi:59.4%,Press:100.3kPa

Antenna/Distance : 2021 BBHA 9120D
3#/3m/HORIZONTAL

Memo : 3DH5 2441

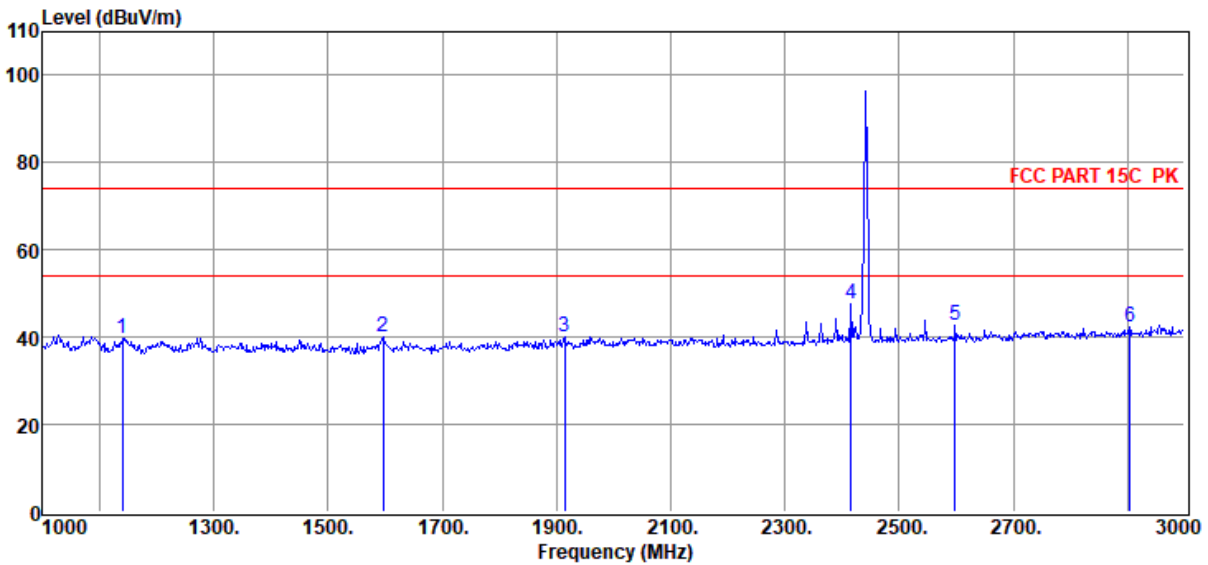

Item (Mark)	Freq. (MHz)	Read Level (dBμV)	Antenna Factor (dB/m)	PRM Factor (dB)	Cable Loss (dB)	Filter Factor (dB)	Result Level (dBμV/m)	Limit Line (dBμV/m)	Over Limit (dB)	Detector	Polarization
1	1140.00	50.50	25.47	38.11	1.18	0.53	39.57	74.00	-34.43	Peak	HORIZONTAL
2	1596.00	51.12	25.65	38.79	1.42	0.61	40.01	74.00	-33.99	Peak	HORIZONTAL
3	1914.00	50.68	26.48	39.27	1.56	0.66	40.11	74.00	-33.89	Peak	HORIZONTAL
4	2416.00	57.19	27.45	39.61	1.72	0.73	47.48	74.00	-26.52	Peak	HORIZONTAL
5	2598.00	51.91	27.97	39.70	1.77	0.75	42.70	74.00	-31.30	Peak	HORIZONTAL
6	2904.00	50.58	29.14	39.85	1.85	0.78	42.50	74.00	-31.50	Peak	HORIZONTAL

Note: 1. Result Level = Read Level + Antenna Factor + Cable loss + Filter Factor - PRM Factor.
 2. If Peak Result complies with AV limit, AV Result is deemed to comply with AV limit.
 3. Test setup: RBW: 1 MHz, VBW: 3 MHz, Sweep time: auto.

TR-4-E-009 Radiated Emission Test Result

Test Site : DDT 3m Chamber 3# D:\E3 6.111\2022 Report Data\Q22061414-23E
aBOOM+\FCC ABOVE 1G .EM6
Test Date : 2022-09-06 **Tested By** : Bairong
EUT : Bluetooth Speaker **Model Number** : aBOOM+
Power Supply : AC 120V/60Hz **Test Mode** : Tx Mode
Condition : Temp:22°C,Humi:59.4%,Press:100.3kPa **Antenna/Distance** : 2021 BBHA 9120D 3#/3m/VERTICAL
Memo : 3DH5 2441

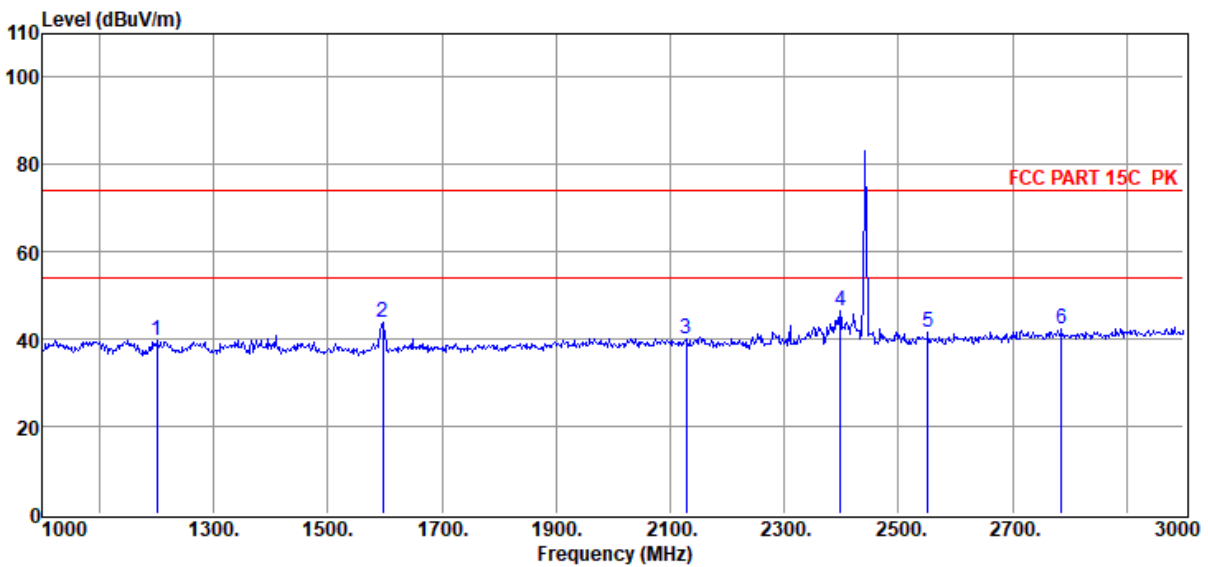

Item (Mark)	Freq. (MHz)	Read Level (dBμV)	Antenna Factor (dB/m)	PRM Factor (dB)	Cable Loss (dB)	Filter Factor (dB)	Result Level (dBμV/m)	Limit Line (dBμV/m)	Over Limit (dB)	Detector	Polarization
1	1200.00	50.70	25.46	38.20	1.21	0.54	39.71	74.00	-34.29	Peak	VERTICAL
2	1596.00	54.79	25.65	38.79	1.42	0.61	43.68	74.00	-30.32	Peak	VERTICAL
3	2128.00	50.37	26.93	39.46	1.64	0.69	40.17	74.00	-33.83	Peak	VERTICAL
4	2398.00	56.37	27.42	39.60	1.71	0.72	46.62	74.00	-27.38	Peak	VERTICAL
5	2552.00	50.95	27.80	39.68	1.75	0.74	41.56	74.00	-32.44	Peak	VERTICAL
6	2786.00	50.72	28.69	39.79	1.81	0.77	42.20	74.00	-31.80	Peak	VERTICAL

Note:

1. Result Level = Read Level + Antenna Factor + Cable loss + Filter Factor - PRM Factor.
2. If Peak Result complies with AV limit, AV Result is deemed to comply with AV limit.
3. Test setup: RBW: 1 MHz, VBW: 3 MHz, Sweep time: auto.

TR-4-E-009 Radiated Emission Test Result

Test Site : DDT 3m Chamber 3#

D:\E3 6.111\2022 Report Data\Q22061414-23E
aBOOM+\FCC ABOVE 1G .EM6

Test Date : 2022-09-06

Tested By : Bairong

EUT : Bluetooth Speaker

Model Number : aBOOM+

Power Supply : AC 120V/60Hz

Test Mode : Tx Mode

Condition : Temp:22°C,Humi:59.4%,Press:100.3kPa

Antenna/Distance : 2021 BBHA 9120D
3#/3m/HORIZONTAL

Memo : 3DH5 2441

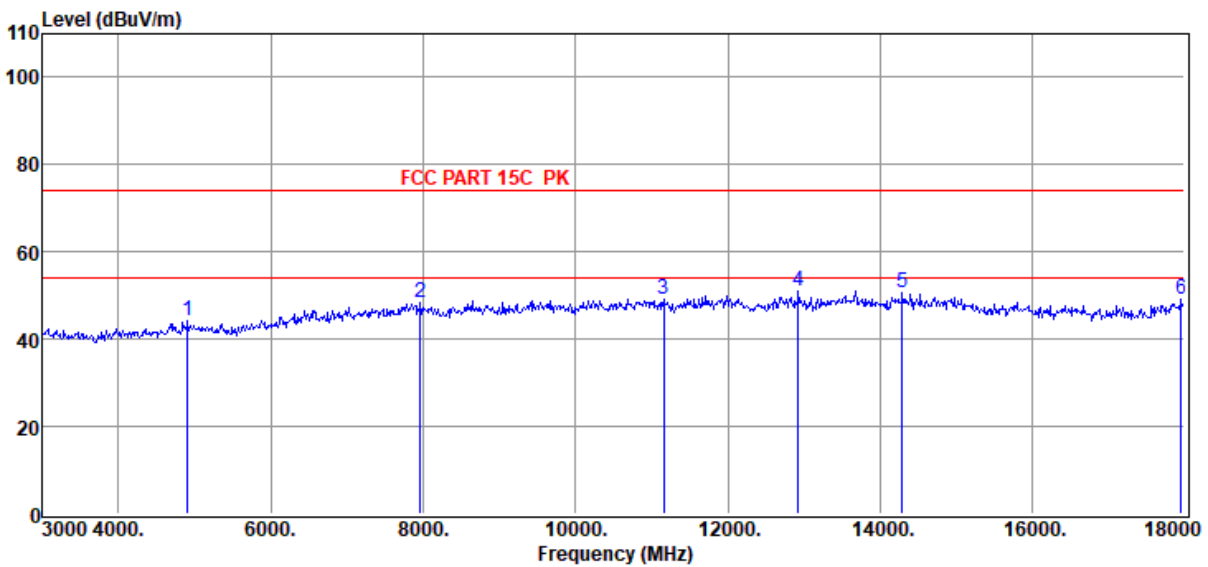

Item (Mark)	Freq. (MHz)	Read Level (dBµV)	Antenna Factor (dB/m)	PRM Factor (dB)	Cable Loss (dB)	Filter Factor (dB)	Result Level (dBµV/m)	Limit Line (dBµV/m)	Over Limit (dB)	Detector	Polarization
1	4905.00	46.94	32.80	40.38	2.51	2.18	44.05	74.00	-29.95	Peak	HORIZONTAL
2	7965.00	45.73	36.96	39.80	3.19	2.28	48.36	74.00	-25.64	Peak	HORIZONTAL
3	11160.00	44.01	39.20	40.18	3.85	2.38	49.26	74.00	-24.74	Peak	HORIZONTAL
4	12930.00	44.79	39.52	40.38	4.30	2.92	51.15	74.00	-22.85	Peak	HORIZONTAL
5	14295.00	43.01	39.90	39.67	4.42	2.82	50.48	74.00	-23.52	Peak	HORIZONTAL
6	17955.00	38.67	42.22	40.67	4.95	3.78	48.95	74.00	-25.05	Peak	HORIZONTAL

Note: 1. Result Level = Read Level + Antenna Factor + Cable loss + Filter Factor - PRM Factor.
 2. If Peak Result complies with AV limit, AV Result is deemed to comply with AV limit.
 3. Test setup: RBW: 1 MHz, VBW: 3 MHz, Sweep time: auto.

TR-4-E-009 Radiated Emission Test Result

Test Site : DDT 3m Chamber 3# D:\E3 6.111\2022 Report Data\Q22061414-23E
aBOOM+\FCC ABOVE 1G .EM6
Test Date : 2022-09-06 **Tested By** : Bairong
EUT : Bluetooth Speaker **Model Number** : aBOOM+
Power Supply : AC 120V/60Hz **Test Mode** : Tx Mode
Condition : Temp:22°C,Humi:59.4%,Press:100.3kPa **Antenna/Distance** : 2021 BBHA 9120D 3#/3m/VERTICAL
Memo : 3DH5 2441

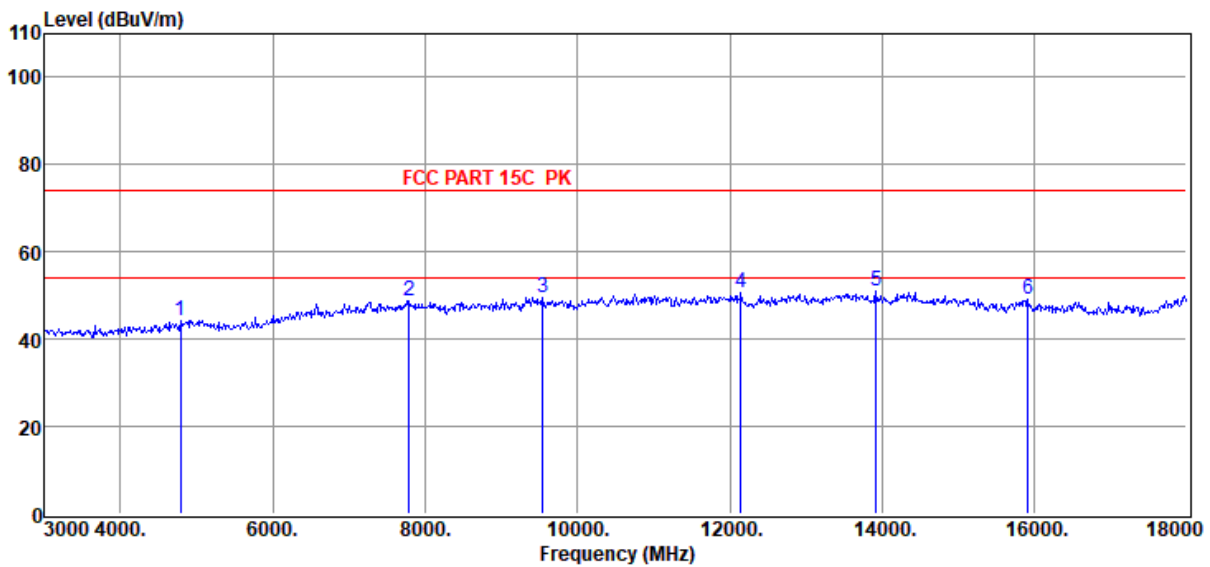

Item (Mark)	Freq. (MHz)	Read Level (dBµV)	Antenna Factor (dB/m)	PRM Factor (dB)	Cable Loss (dB)	Filter Factor (dB)	Result Level (dBµV/m)	Limit Line (dBµV/m)	Over Limit (dB)	Detector	Polarization
1	4785.00	47.74	32.41	40.36	2.46	2.16	44.41	74.00	-29.59	Peak	VERTICAL
2	7785.00	46.34	36.74	39.78	3.17	2.28	48.75	74.00	-25.25	Peak	VERTICAL
3	9540.00	45.34	38.68	40.28	3.62	2.34	49.70	74.00	-24.30	Peak	VERTICAL
4	12150.00	45.34	39.14	40.15	3.95	2.48	50.76	74.00	-23.24	Peak	VERTICAL
5	13920.00	43.34	39.92	39.76	4.44	2.90	50.84	74.00	-23.16	Peak	VERTICAL
6	15915.00	43.23	38.05	39.87	4.59	3.08	49.08	74.00	-24.92	Peak	VERTICAL

Note: 1. Result Level = Read Level + Antenna Factor + Cable loss + Filter Factor - PRM Factor.
 2. If Peak Result complies with AV limit, AV Result is deemed to comply with AV limit.
 3. Test setup: RBW: 1 MHz, VBW: 3 MHz, Sweep time: auto.

TR-4-E-009 Radiated Emission Test Result

Test Site : DDT 3m Chamber 3#

D:\E3 6.111\2022 Report Data\Q22061414-23E
aBOOM+\FCC ABOVE 1G .EM6

Test Date : 2022-09-06

Tested By : Bairong

EUT : Bluetooth Speaker

Model Number : aBOOM+

Power Supply : AC 120V/60Hz

Test Mode : Tx Mode

Condition : Temp:22°C,Humi:59.4%,Press:100.3kPa

Antenna/Distance : 2021 BBHA 9120D
3#/3m/HORIZONTAL

Memo : 3DH5 2480

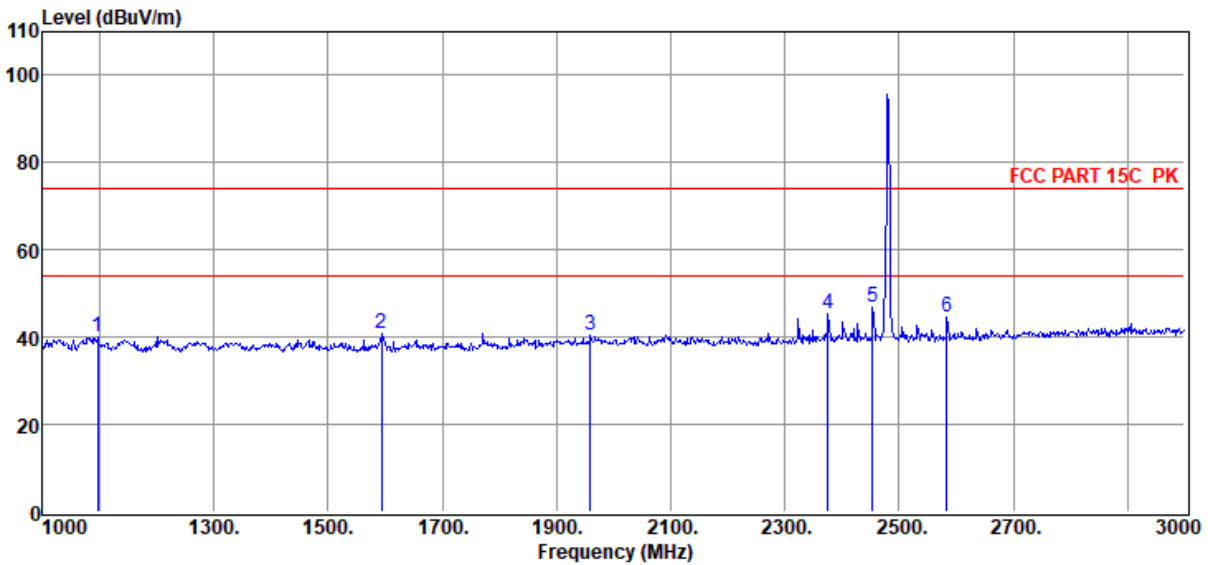

Item (Mark)	Freq. (MHz)	Read Level (dBµV)	Antenna Factor (dB/m)	PRM Factor (dB)	Cable Loss (dB)	Filter Factor (dB)	Result Level (dBµV/m)	Limit Line (dBµV/m)	Over Limit (dB)	Detector	Polarization
1	1096.00	50.86	25.48	38.04	1.15	0.52	39.97	74.00	-34.03	Peak	HORIZONTAL
2	1594.00	51.87	25.64	38.79	1.42	0.61	40.75	74.00	-33.25	Peak	HORIZONTAL
3	1960.00	50.93	26.60	39.34	1.58	0.67	40.44	74.00	-33.56	Peak	HORIZONTAL
4	2376.00	55.32	27.38	39.59	1.71	0.72	45.54	74.00	-28.46	Peak	HORIZONTAL
5	2454.00	56.54	27.52	39.63	1.73	0.73	46.89	74.00	-27.11	Peak	HORIZONTAL
6	2584.00	53.86	27.92	39.69	1.76	0.74	44.59	74.00	-29.41	Peak	HORIZONTAL

Note: 1. Result Level = Read Level + Antenna Factor + Cable loss + Filter Factor - PRM Factor.
 2. If Peak Result complies with AV limit, AV Result is deemed to comply with AV limit.
 3. Test setup: RBW: 1 MHz, VBW: 3 MHz, Sweep time: auto.

TR-4-E-009 Radiated Emission Test Result

Test Site : DDT 3m Chamber 3# D:\E3 6.111\2022 Report Data\Q22061414-23E
aBOOM+\FCC ABOVE 1G .EM6
Test Date : 2022-09-06 **Tested By** : Bairong
EUT : Bluetooth Speaker **Model Number** : aBOOM+
Power Supply : AC 120V/60Hz **Test Mode** : Tx Mode
Condition : Temp:22°C,Humi:59.4%,Press:100.3kPa **Antenna/Distance** : 2021 BBHA 9120D 3#/3m/VERTICAL
Memo : 3DH5 2480

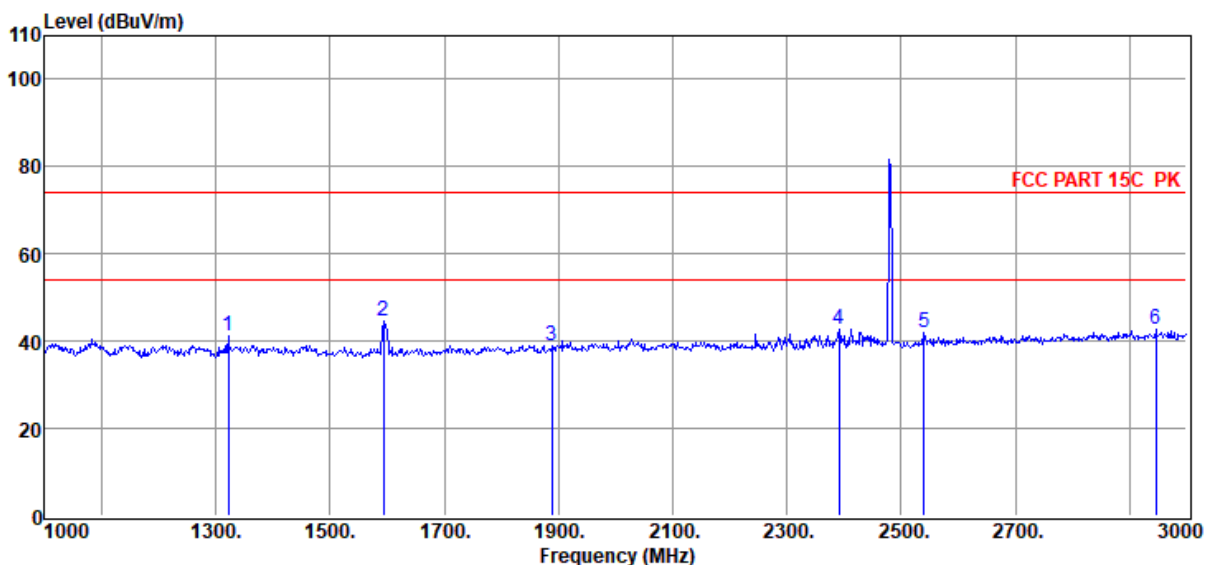

Item (Mark)	Freq. (MHz)	Read Level (dBuV)	Antenna Factor (dB/m)	PRM Factor (dB)	Cable Loss (dB)	Filter Factor (dB)	Result Level (dBuV/m)	Limit Line (dBuV/m)	Over Limit (dB)	Detector	Polarization
1	1322.00	52.14	25.44	38.38	1.28	0.56	41.04	74.00	-32.96	Peak	VERTICAL
2	1594.00	55.68	25.64	38.79	1.42	0.61	44.56	74.00	-29.44	Peak	VERTICAL
3	1888.00	49.56	26.41	39.23	1.55	0.66	38.95	74.00	-35.05	Peak	VERTICAL
4	2392.00	52.55	27.41	39.60	1.71	0.72	42.79	74.00	-31.21	Peak	VERTICAL
5	2540.00	51.54	27.75	39.67	1.75	0.74	42.11	74.00	-31.89	Peak	VERTICAL
6	2946.00	50.75	29.29	39.87	1.86	0.78	42.81	74.00	-31.19	Peak	VERTICAL

Note: 1. Result Level = Read Level + Antenna Factor + Cable loss + Filter Factor - PRM Factor.
 2. If Peak Result complies with AV limit, AV Result is deemed to comply with AV limit.
 3. Test setup: RBW: 1 MHz, VBW: 3 MHz, Sweep time: auto.

TR-4-E-009 Radiated Emission Test Result

Test Site : DDT 3m Chamber 3#

D:\E3 6.111\2022 Report Data\Q22061414-23E
aBOOM+\FCC ABOVE 1G .EM6

Test Date : 2022-09-06

Tested By : Bairong

EUT : Bluetooth Speaker

Model Number : aBOOM+

Power Supply : AC 120V/60Hz

Test Mode : Tx Mode

Condition : Temp:22°C,Humi:59.4%,Press:100.3kPa

Antenna/Distance : 2021 BBHA 9120D
3#/3m/HORIZONTAL

Memo : 3DH5 2480

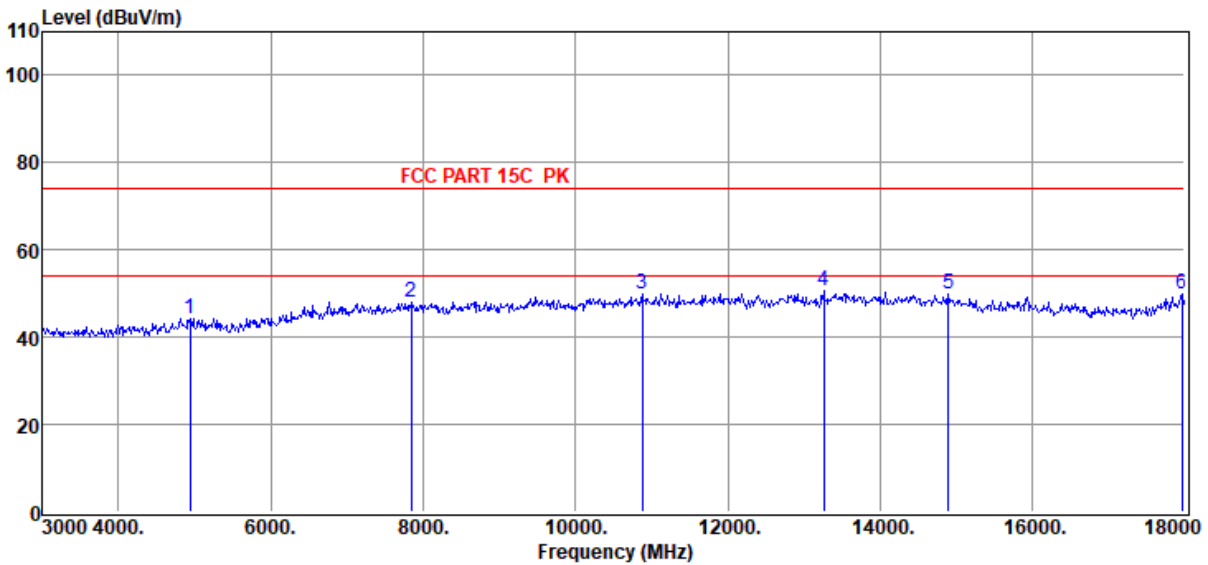

Item (Mark)	Freq. (MHz)	Read Level (dBμV)	Antenna Factor (dB/m)	PRM Factor (dB)	Cable Loss (dB)	Filter Factor (dB)	Result Level (dBμV/m)	Limit Line (dBμV/m)	Over Limit (dB)	Detector	Polarization
1	4935.00	47.16	32.89	40.39	2.52	2.18	44.36	74.00	-29.64	Peak	HORIZONTAL
2	7845.00	45.71	36.81	39.78	3.17	2.28	48.19	74.00	-25.81	Peak	HORIZONTAL
3	10875.00	44.81	39.22	40.25	3.77	2.39	49.94	74.00	-24.06	Peak	HORIZONTAL
4	13260.00	43.74	39.81	40.22	4.19	2.94	50.46	74.00	-23.54	Peak	HORIZONTAL
5	14895.00	42.83	39.58	39.61	4.44	2.65	49.89	74.00	-24.11	Peak	HORIZONTAL
6	17970.00	39.43	42.31	40.68	4.95	3.78	49.79	74.00	-24.21	Peak	HORIZONTAL

Note: 1. Result Level = Read Level + Antenna Factor + Cable loss + Filter Factor - PRM Factor.
 2. If Peak Result complies with AV limit, AV Result is deemed to comply with AV limit.
 3. Test setup: RBW: 1 MHz, VBW: 3 MHz, Sweep time: auto.

TR-4-E-009 Radiated Emission Test Result

Test Site : DDT 3m Chamber 3#

D:\E3 6.111\2022 Report Data\Q22061414-23E
aBOOM+\FCC ABOVE 1G .EM6

Test Date : 2022-09-06

Tested By : Bairong

EUT : Bluetooth Speaker

Model Number : aBOOM+

Power Supply : AC 120V/60Hz

Test Mode : Tx Mode

Condition : Temp:22°C,Humi:59.4%,Press:100.3kPa

Antenna/Distance : 2021 BBHA 9120D 3#/3m/VERTICAL

Memo : 3DH5 2480

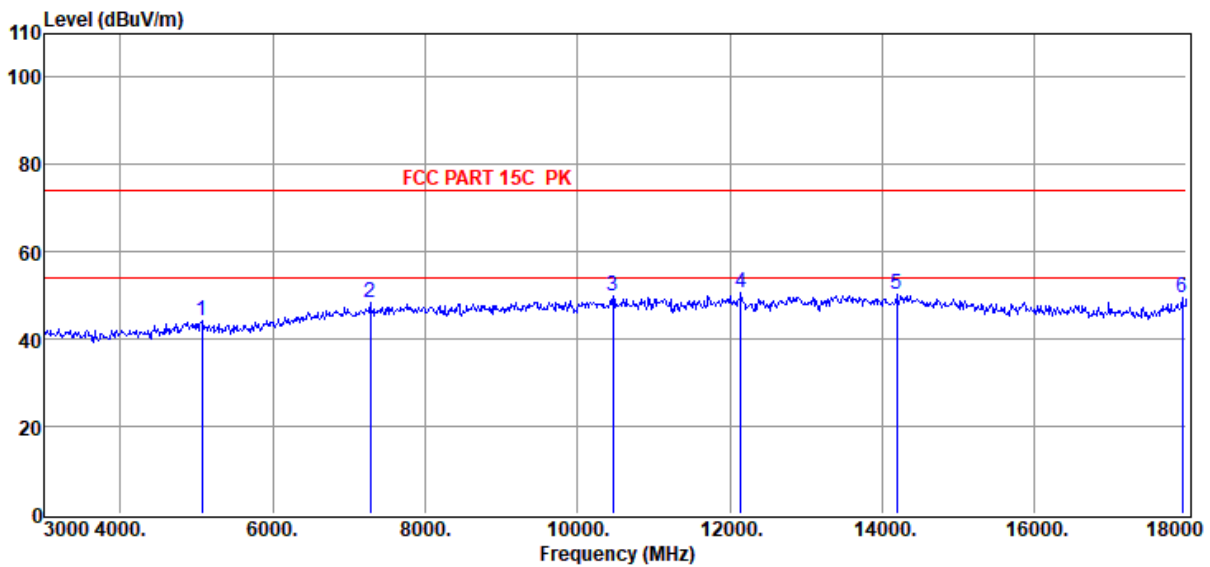

Item (Mark)	Freq. (MHz)	Read Level (dBuV)	Antenna Factor (dB/m)	PRM Factor (dB)	Cable Loss (dB)	Filter Factor (dB)	Result Level (dBuV/m)	Limit Line (dBuV/m)	Over Limit (dB)	Detector	Polarization
1	5070.00	46.88	33.06	40.41	2.54	2.23	44.30	74.00	-29.70	Peak	VERTICAL
2	7275.00	46.39	36.22	39.73	3.09	2.27	48.24	74.00	-25.76	Peak	VERTICAL
3	10470.00	45.19	38.96	40.41	3.67	2.43	49.84	74.00	-24.16	Peak	VERTICAL
4	12150.00	45.34	39.14	40.15	3.95	2.48	50.76	74.00	-23.24	Peak	VERTICAL
5	14190.00	42.84	39.90	39.68	4.46	2.85	50.37	74.00	-23.63	Peak	VERTICAL
6	17940.00	39.19	42.13	40.66	4.94	3.77	49.37	74.00	-24.63	Peak	VERTICAL

Note: 1. Result Level = Read Level + Antenna Factor + Cable loss + Filter Factor - PRM Factor.
 2. If Peak Result complies with AV limit, AV Result is deemed to comply with AV limit.
 3. Test setup: RBW: 1 MHz, VBW: 3 MHz, Sweep time: auto.

11. RF Conducted Spurious Emissions

11.1. Block diagram of test setup

Same as section 4.1

11.2. Limits

In any 100 kHz bandwidth outside the frequency bands in which the spread spectrum intentional radiator is operating, the radio frequency power that is produced by the intentional radiator shall be at least 20 dB below that in the 100 kHz bandwidth within the band that contains the highest level of the desired power.

11.3. Test procedure

(1) Connect EUT's antenna output to spectrum analyzer by RF cable.

(2) Establish a reference level by using the following procedure:

Center frequency	Test frequency
RBW:	100 kHz
VBW:	300 kHz
Span	Wide enough to capture the peak level of the in-band emission
Detector Mode:	Peak
Sweep time:	auto
Trace mode	Max hold

(3) Allow the trace to stabilize, use the peak marker function to determine the maximum peak power level to establish the reference level.

(4) Set the spectrum analyzer as follows:

RBW:	100 kHz
VBW:	300 kHz
Span	Encompass frequency range to be measured
Number of measurement points	$\geq \text{span}/\text{RBW}$
Detector Mode:	Peak
Sweep time:	auto
Trace mode	Max hold

(5) Allow the trace to stabilize, use the peak marker function to determine the maximum amplitude of all unwanted emissions outside of the authorized frequency band

11.4. Test result

Mode	Freq. (MHz)	Verdict
GFSK	Hopping off 2402	Pass
	Hopping off 2441	Pass
	Hopping off 2480	Pass
$\pi/4$ -DQPSK	Hopping off 2402	Pass
	Hopping off 2441	Pass
	Hopping off 2480	Pass
8DPSK	Hopping off 2402	Pass
	Hopping off 2441	Pass
	Hopping off 2480	Pass

11.5. Original test data

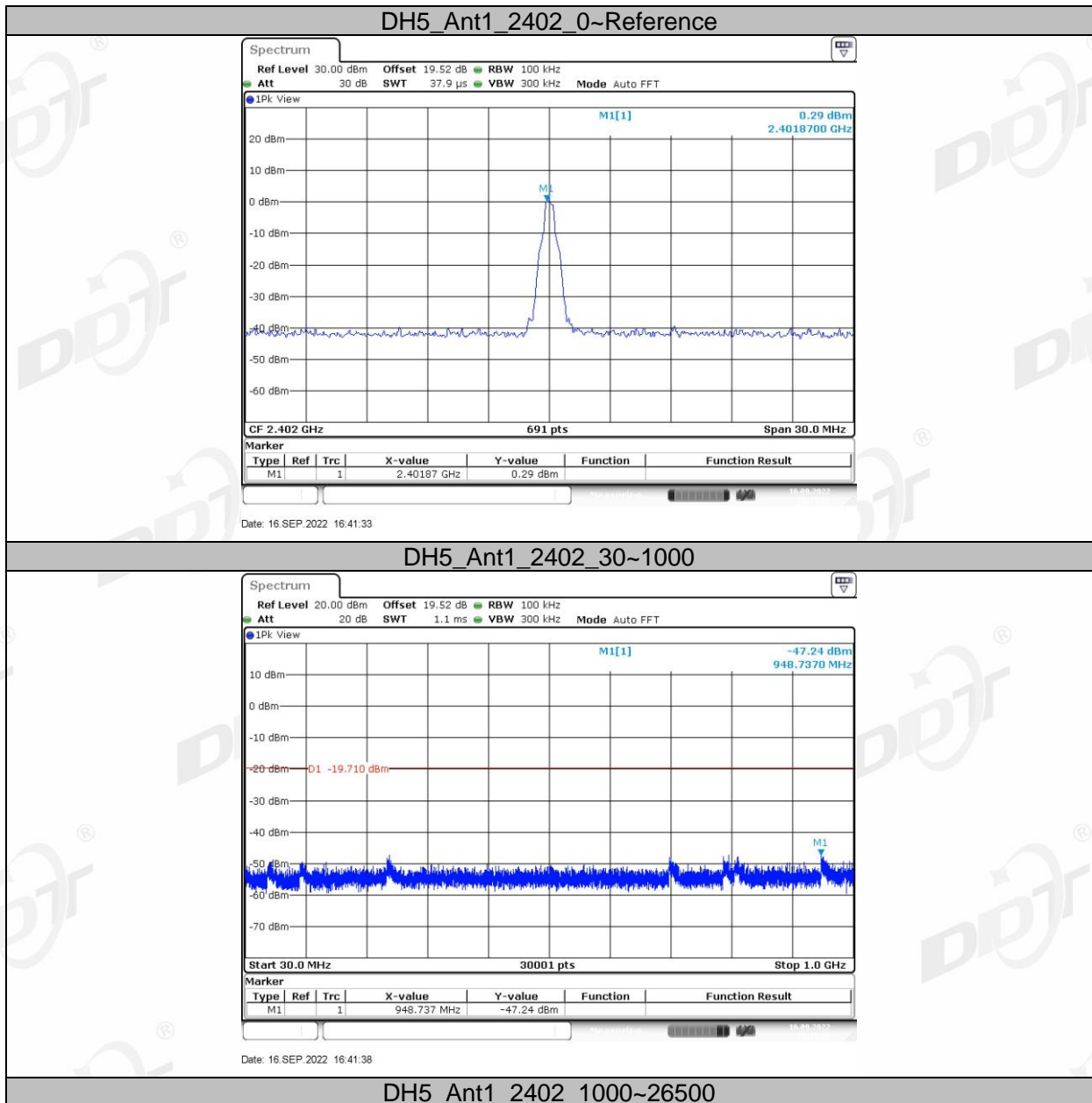

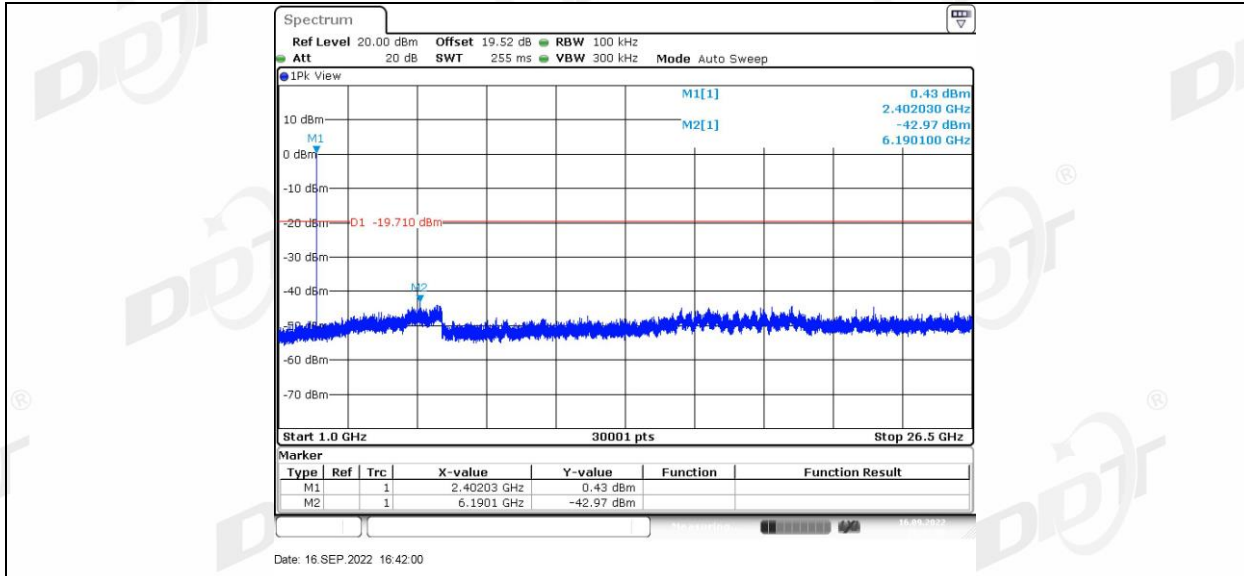

DH5_Ant1_2441_0~Reference

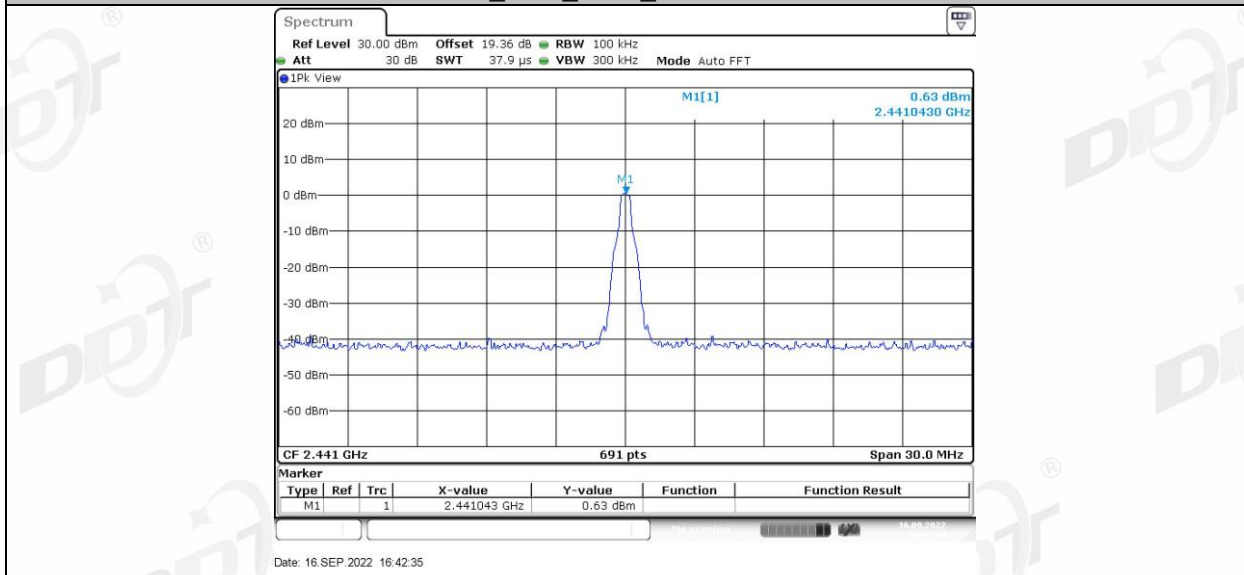

DH5_Ant1_2441_30~1000

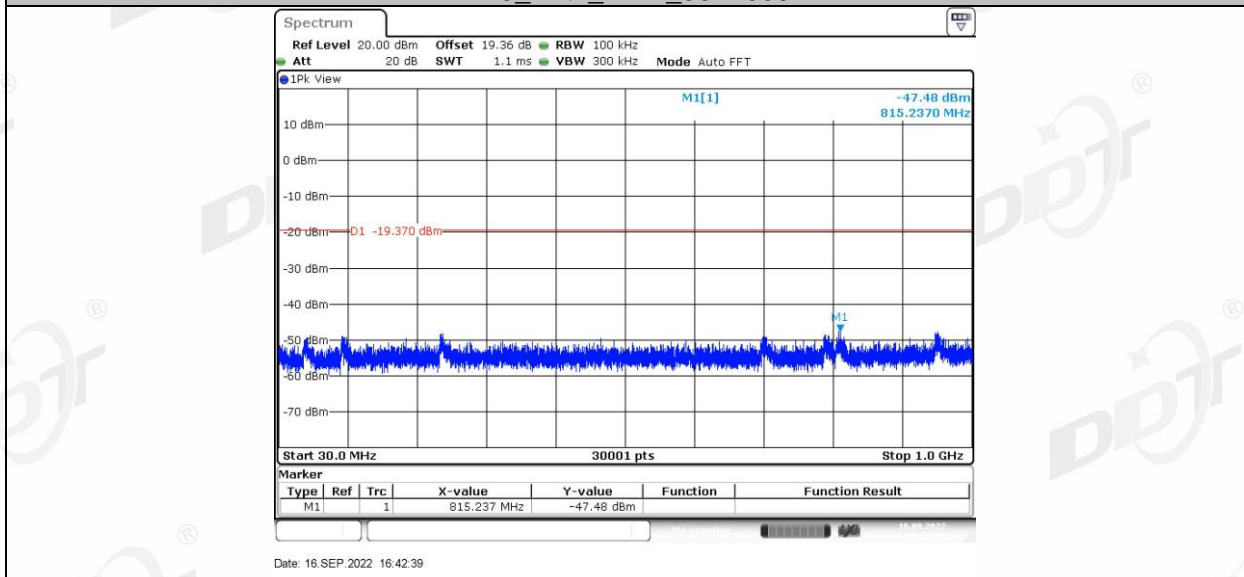

DH5_Ant1_2441_1000~26500

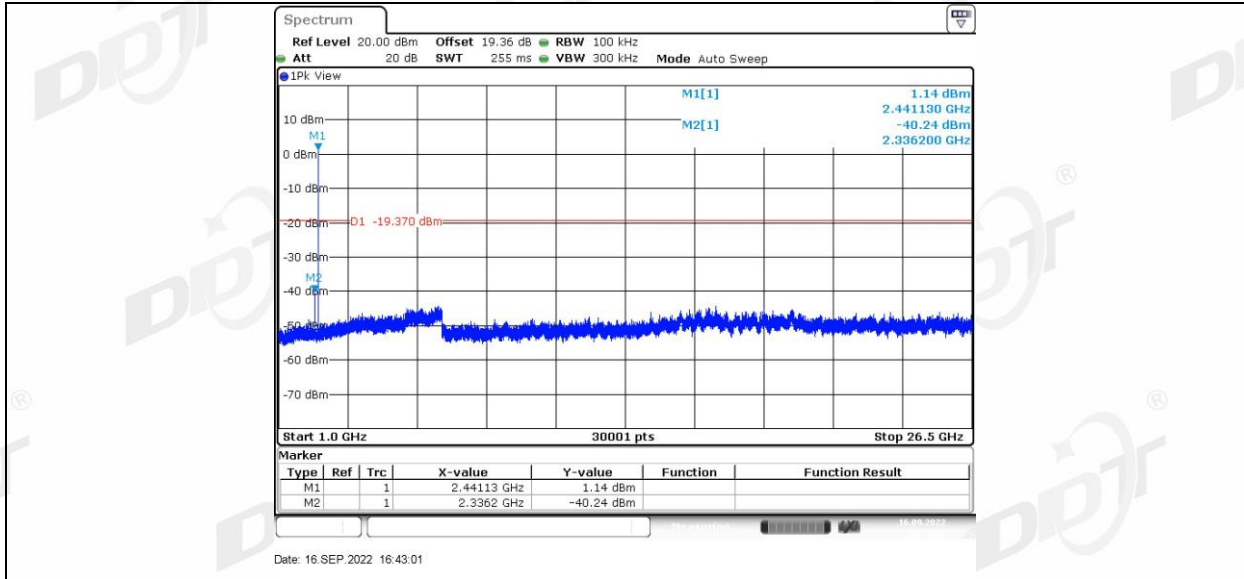

DH5_Ant1_2480_0~Reference

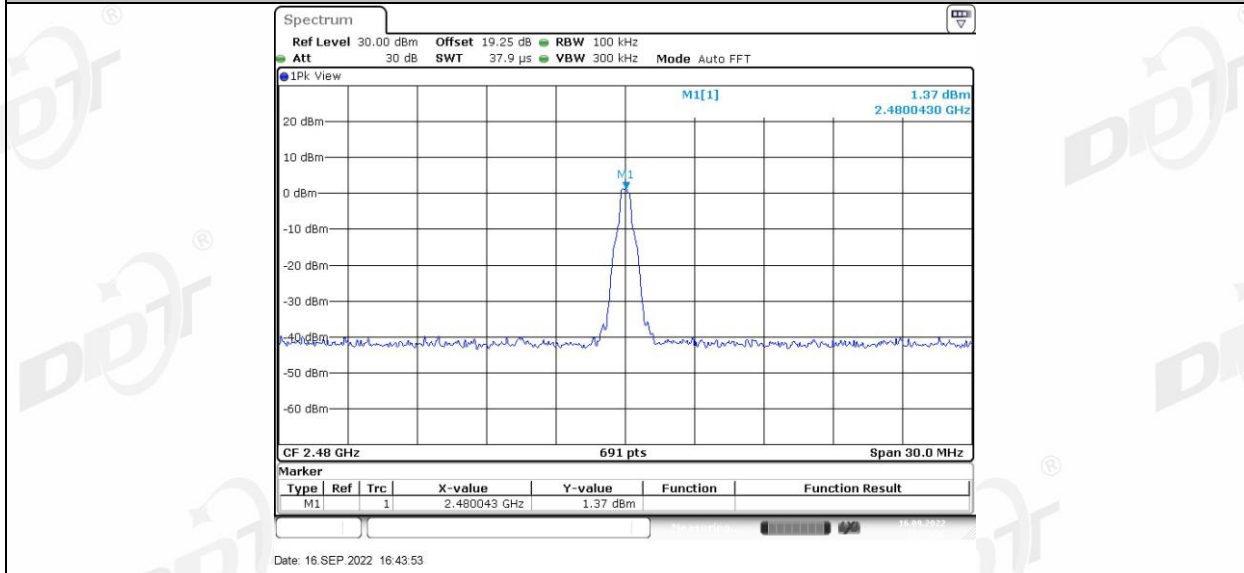

DH5_Ant1_2480_30~1000

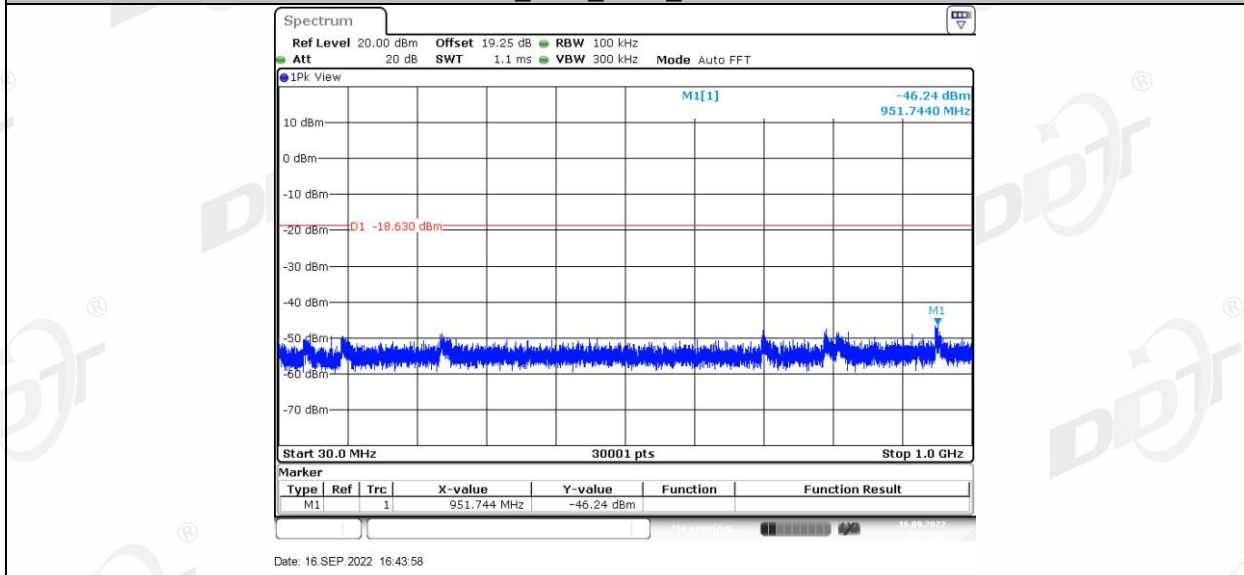

DH5_Ant1_2480_1000~26500

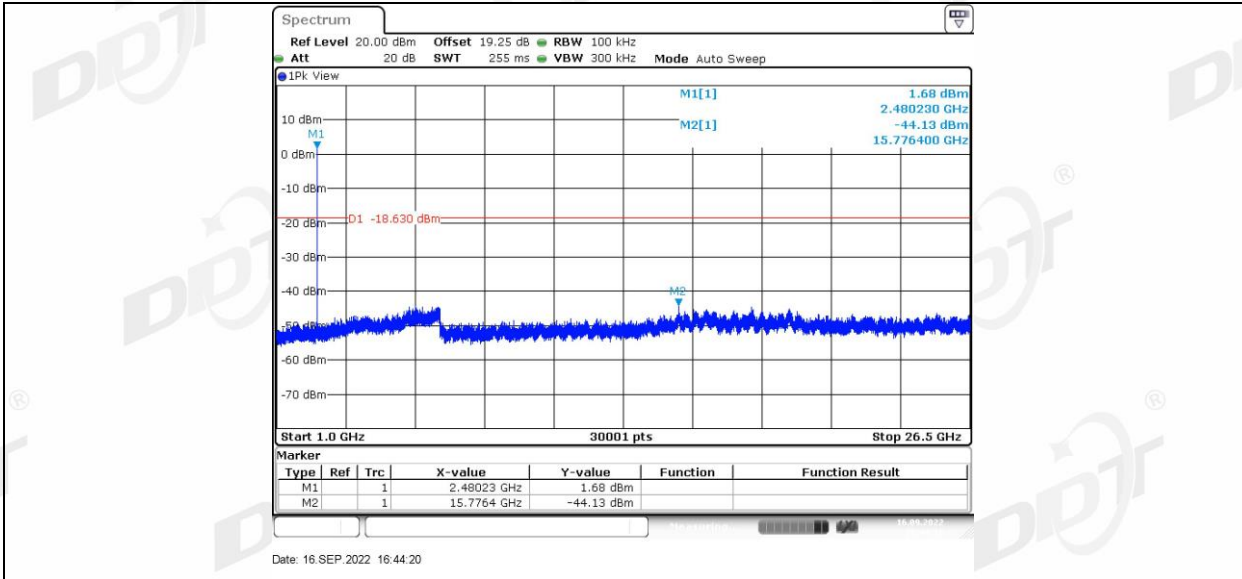

2DH5_Ant1_2402_0-Reference

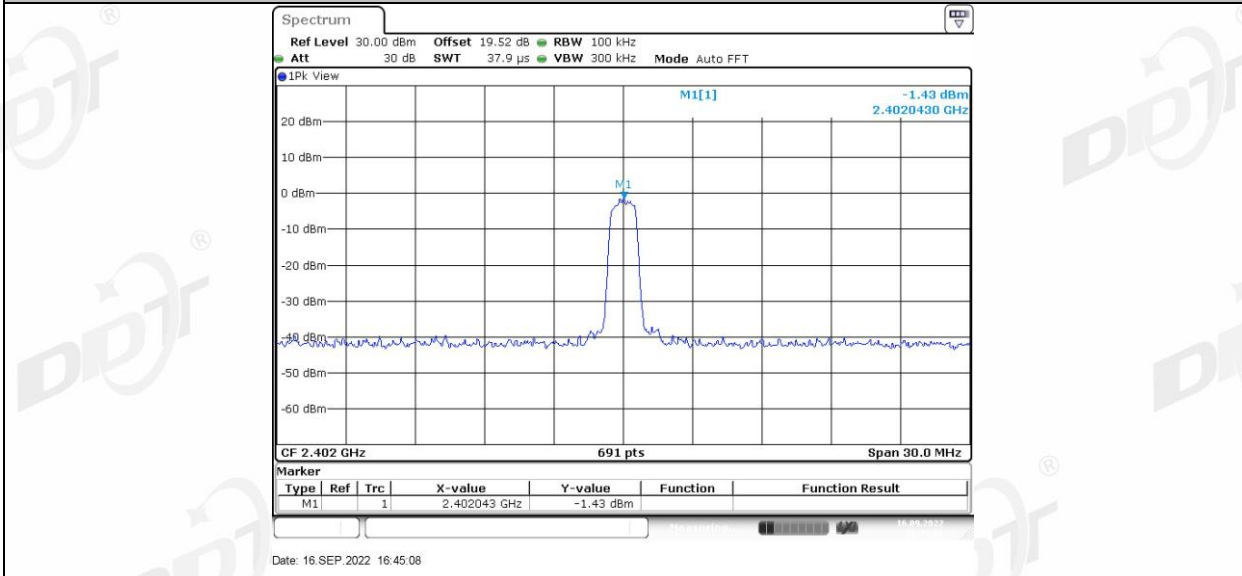

2DH5_Ant1_2402_30~1000

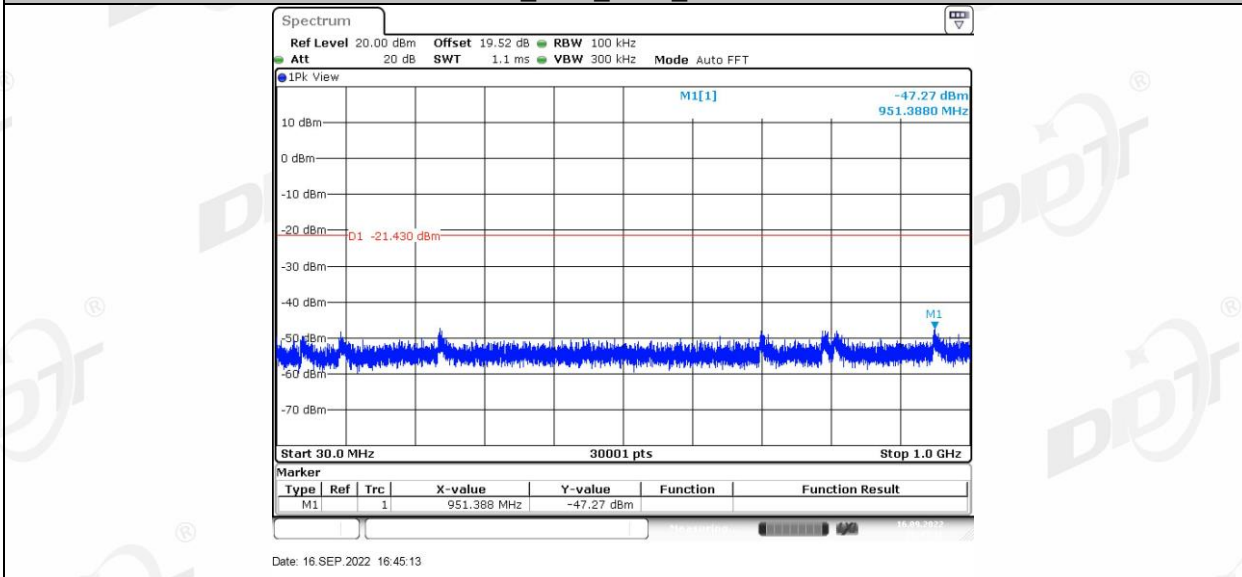

2DH5_Ant1_2402_1000~26500

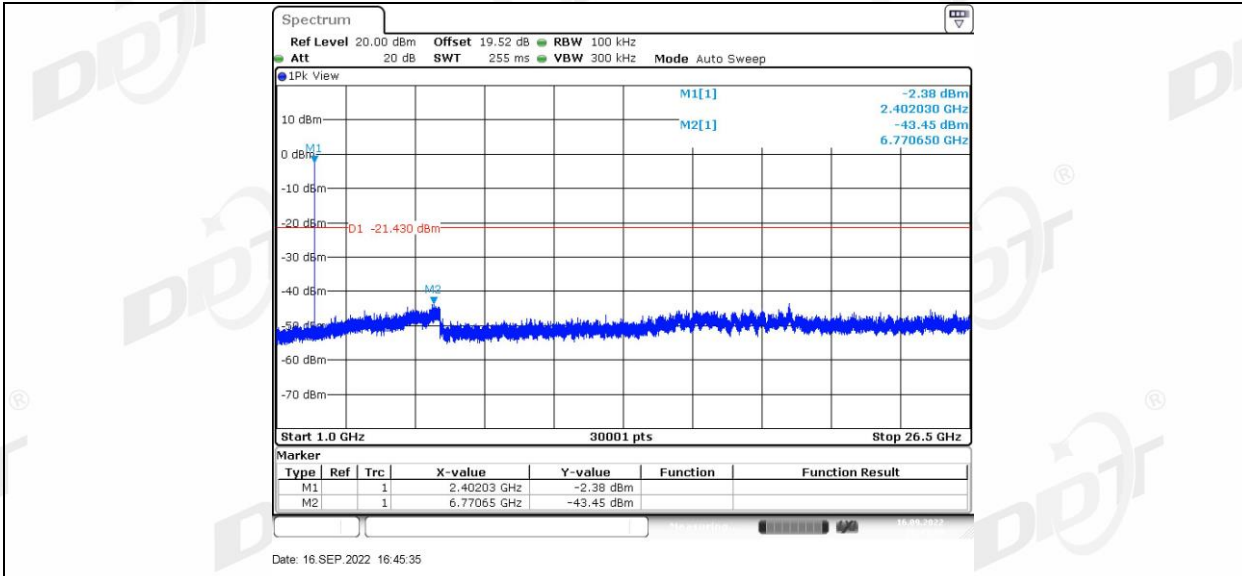

2DH5_Ant1_2441_0-Reference

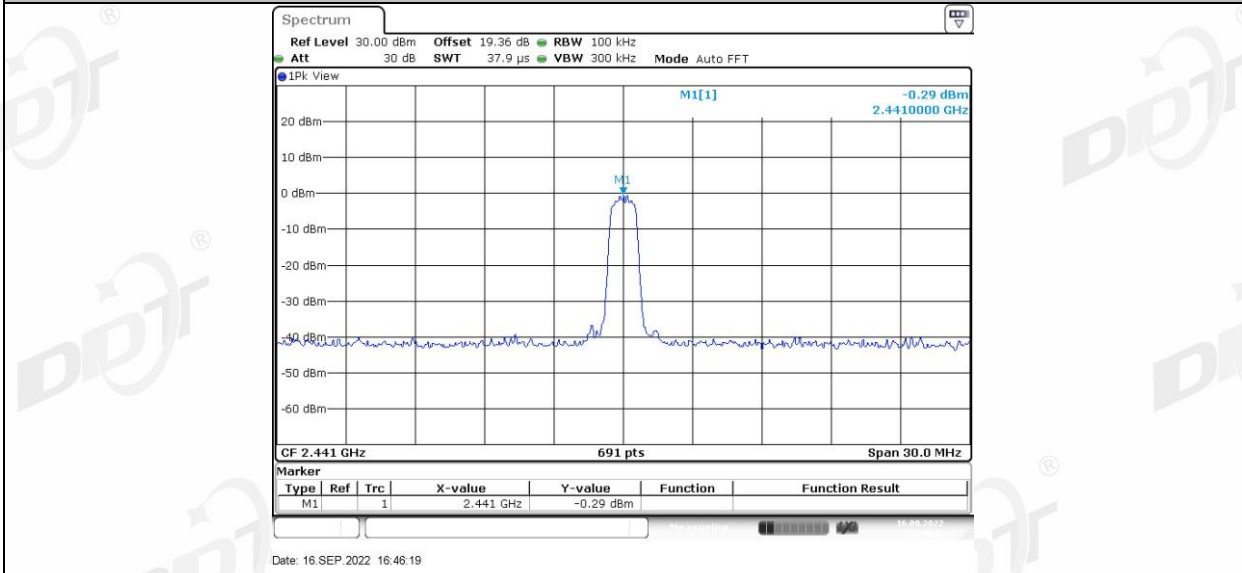

2DH5_Ant1_2441_30~1000

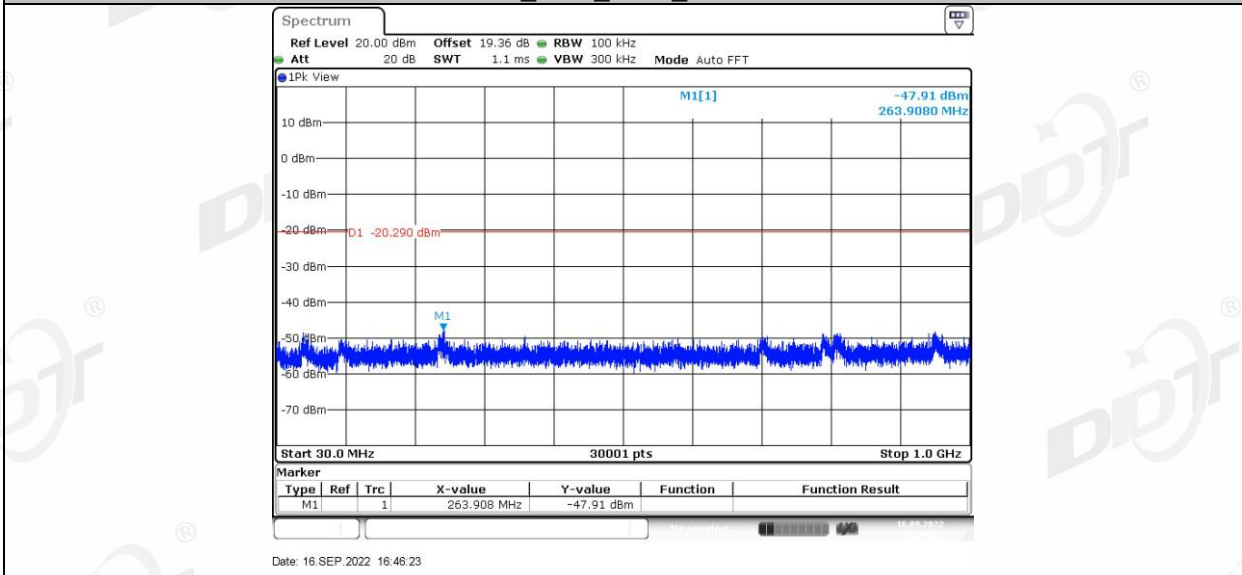

2DH5_Ant1_2441_1000~26500

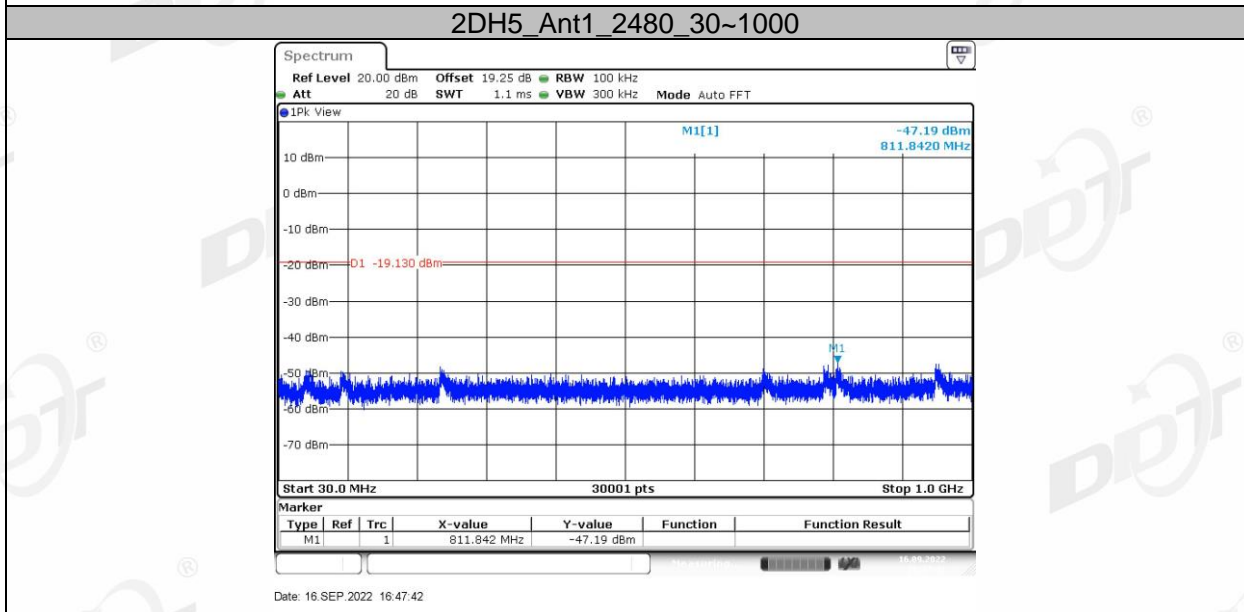
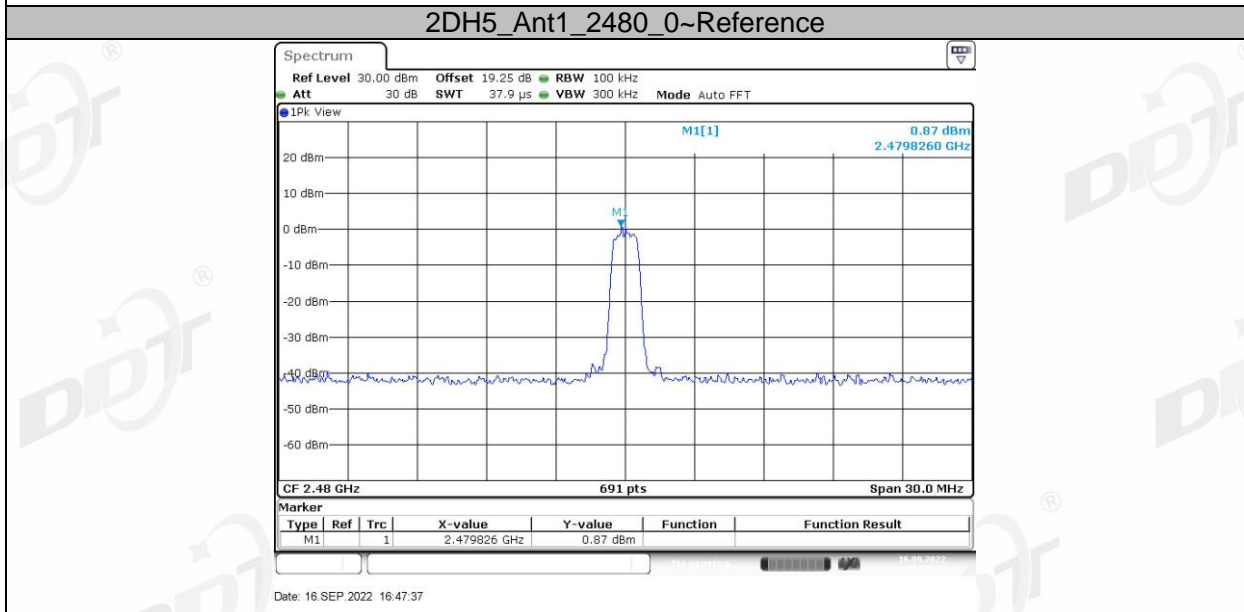
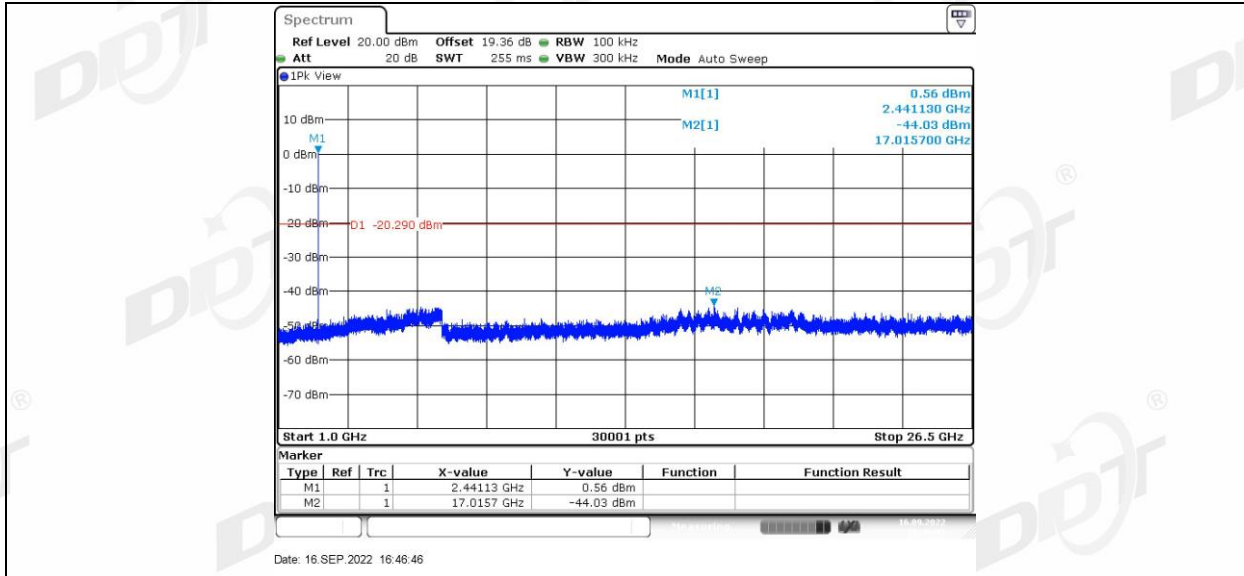

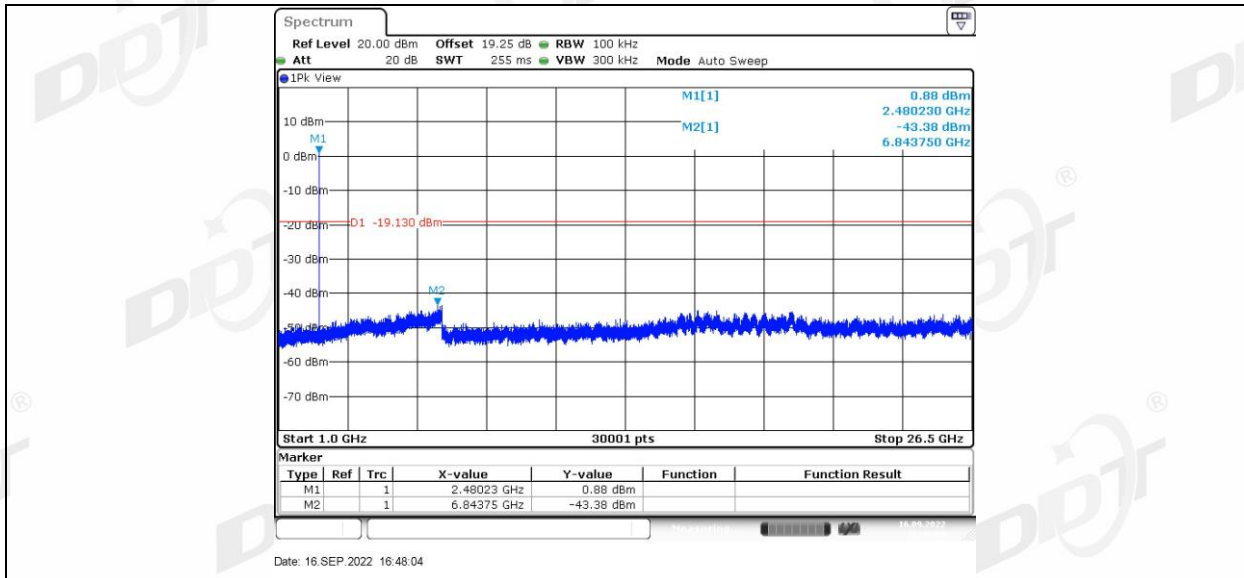

3DH5_Ant1_2402_0-Reference

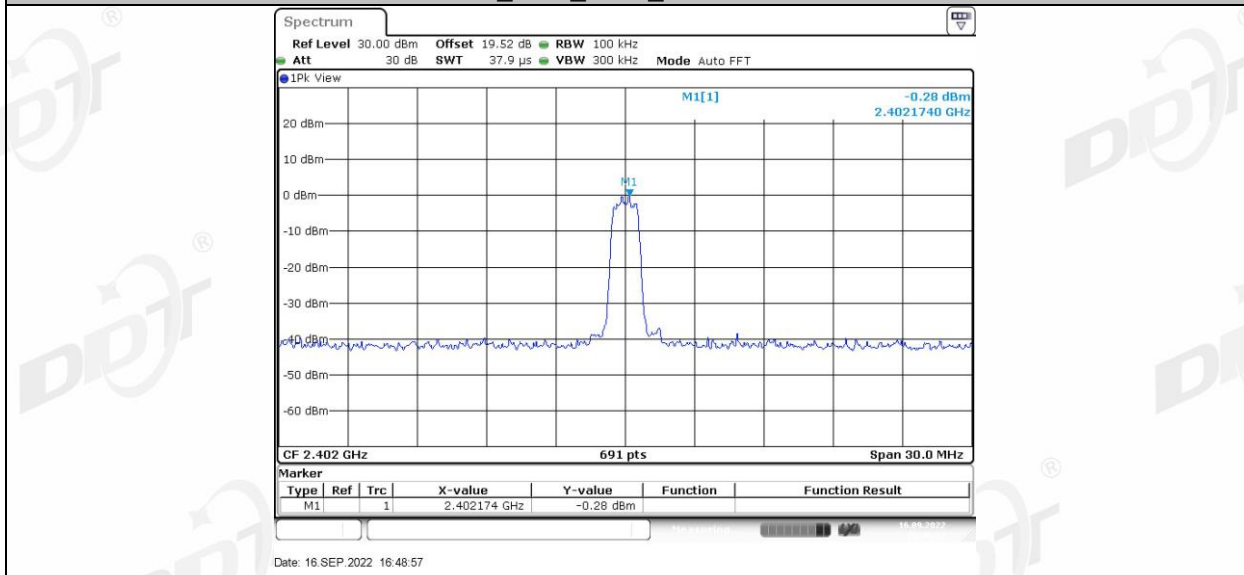

3DH5_Ant1_2402_30~1000

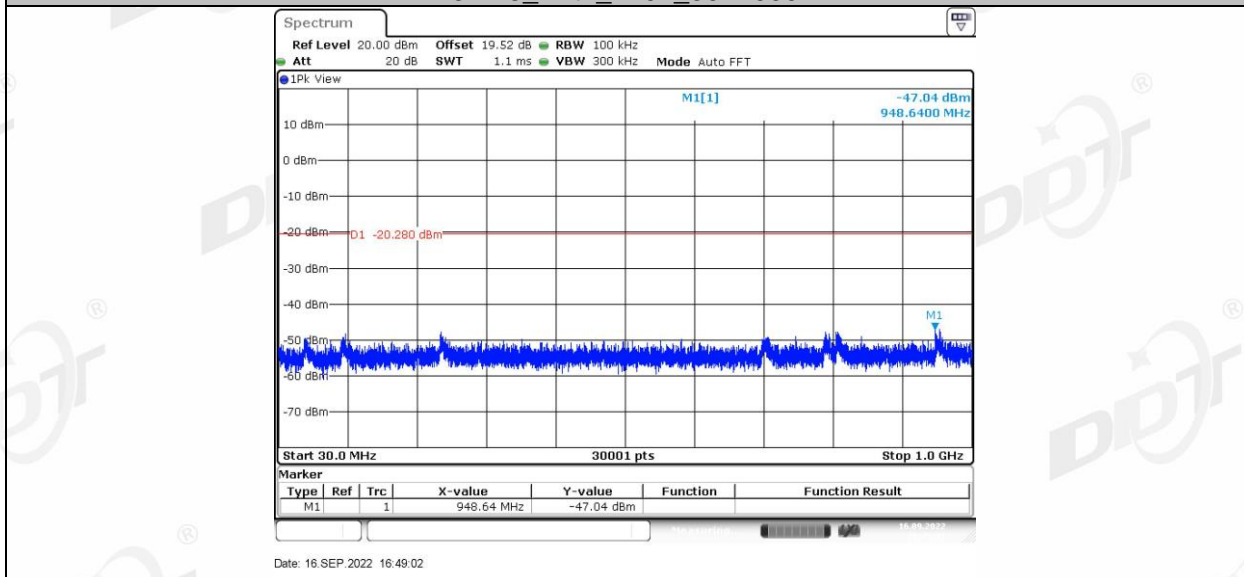

3DH5_Ant1_2402_1000~26500

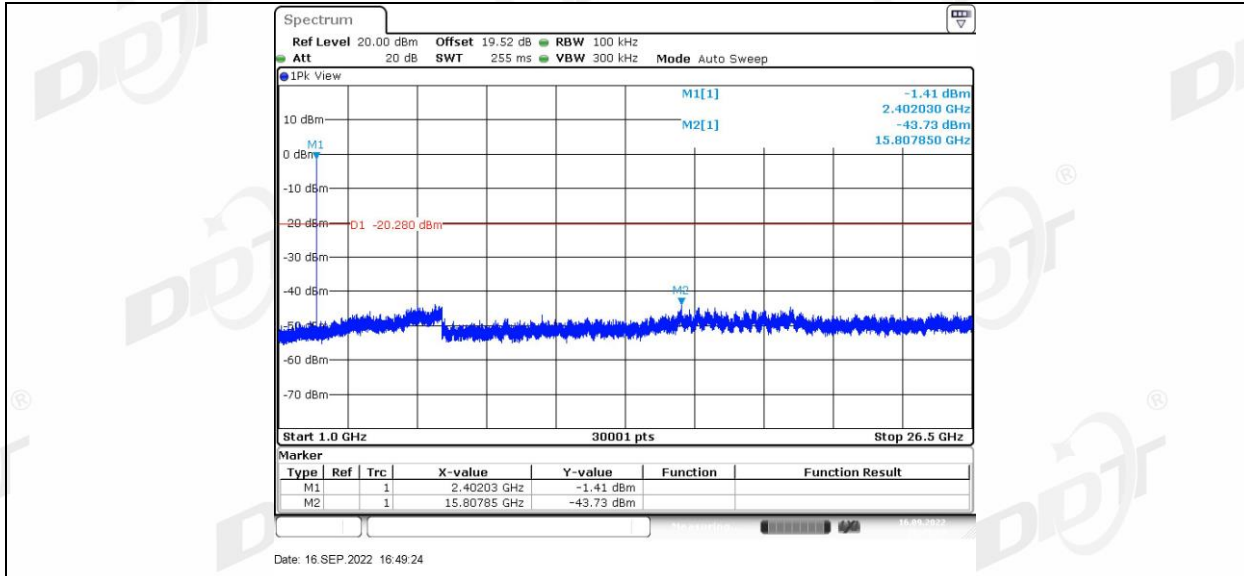

3DH5_Ant1_2441_0-Reference

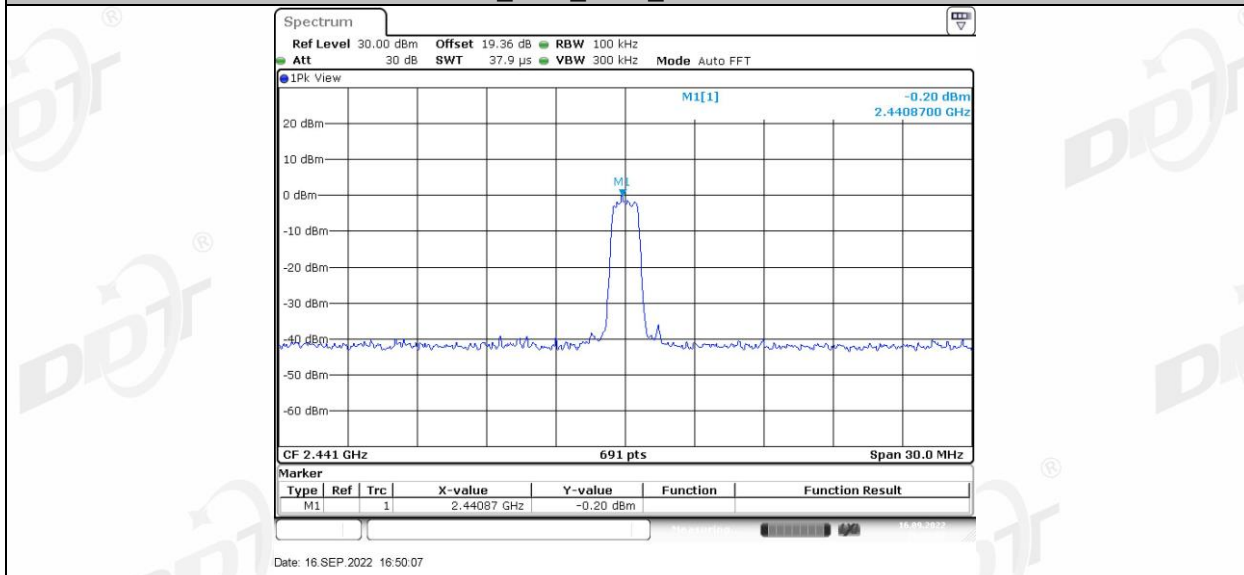

3DH5_Ant1_2441_30~1000

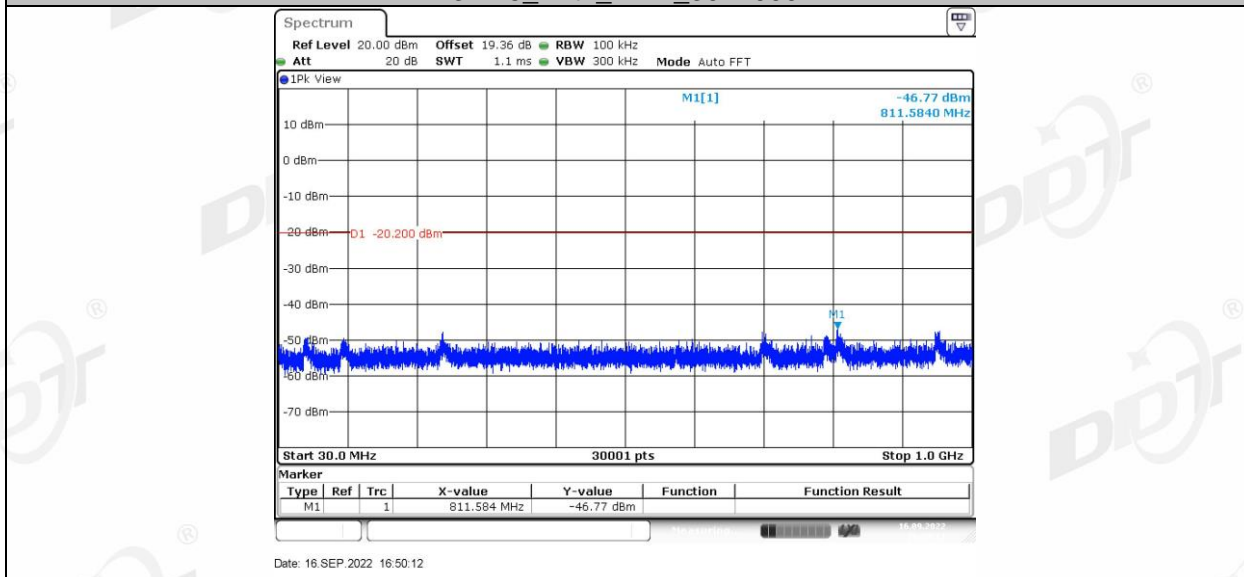

3DH5_Ant1_2441_1000~26500

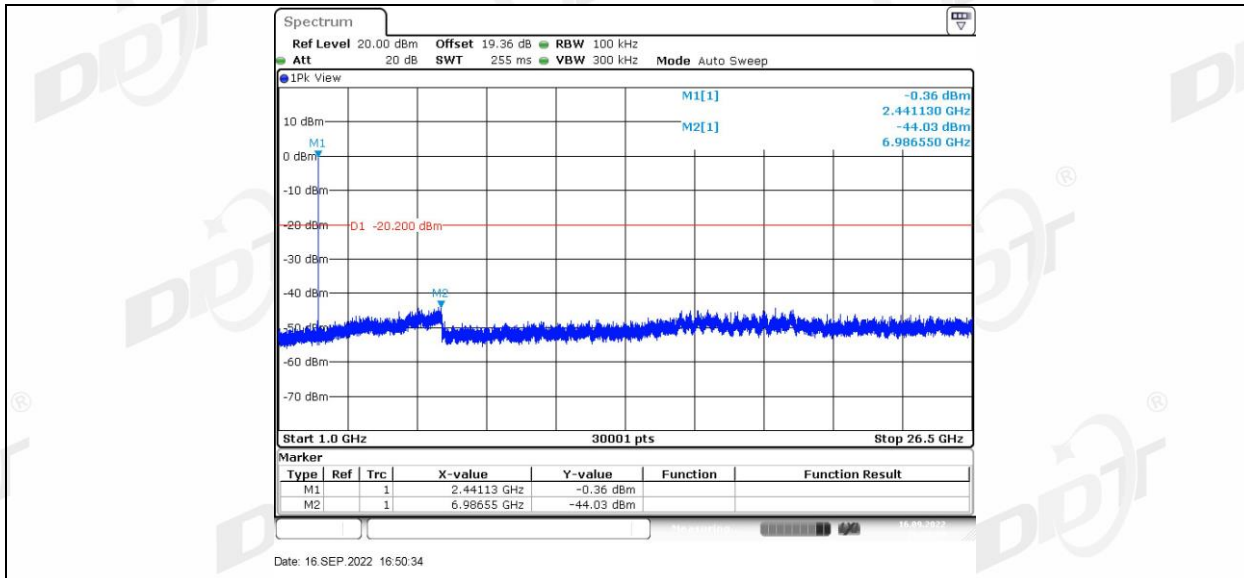

3DH5_Ant1_2480_0-Reference

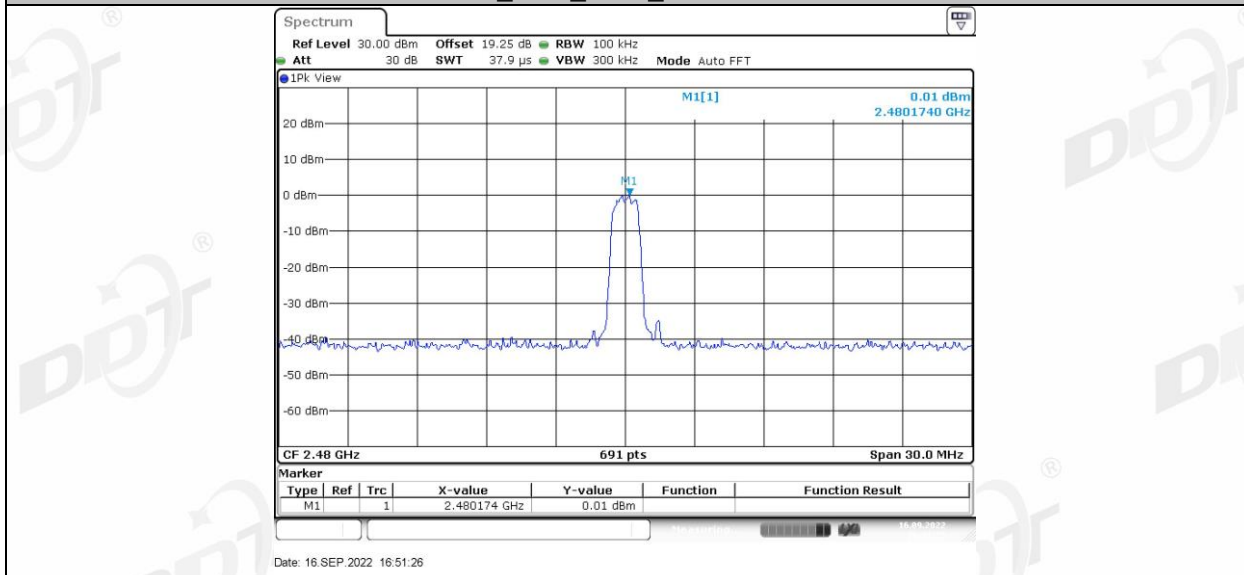

3DH5_Ant1_2480_30~1000

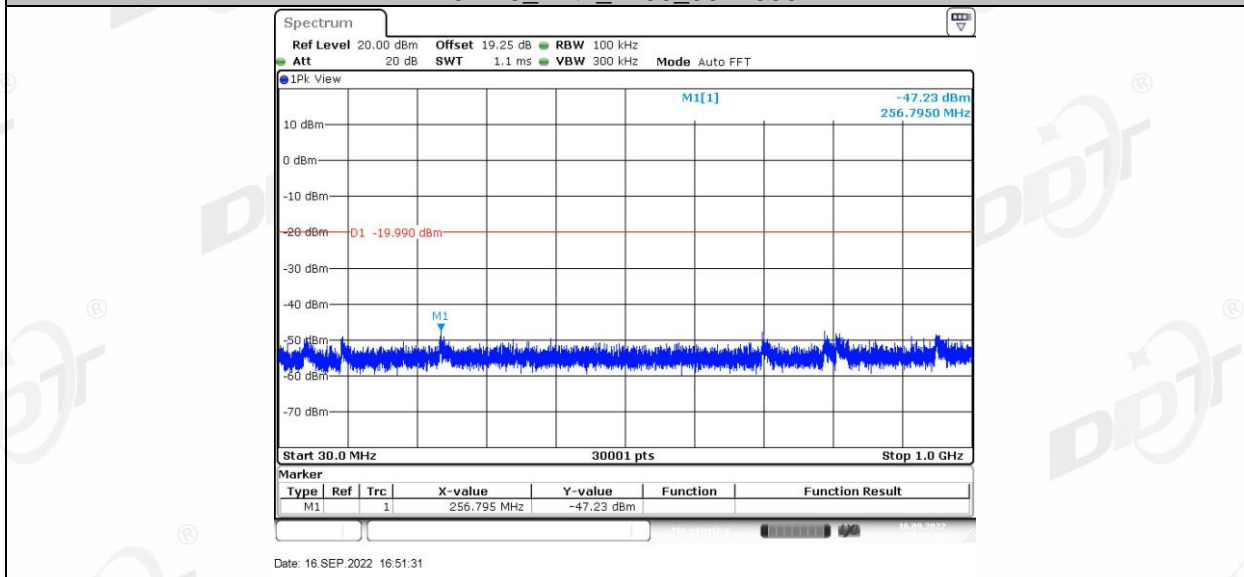

3DH5_Ant1_2480_1000~26500

12. Band Edge Compliance (Radiated Method)

12.1. Block diagram of test setup

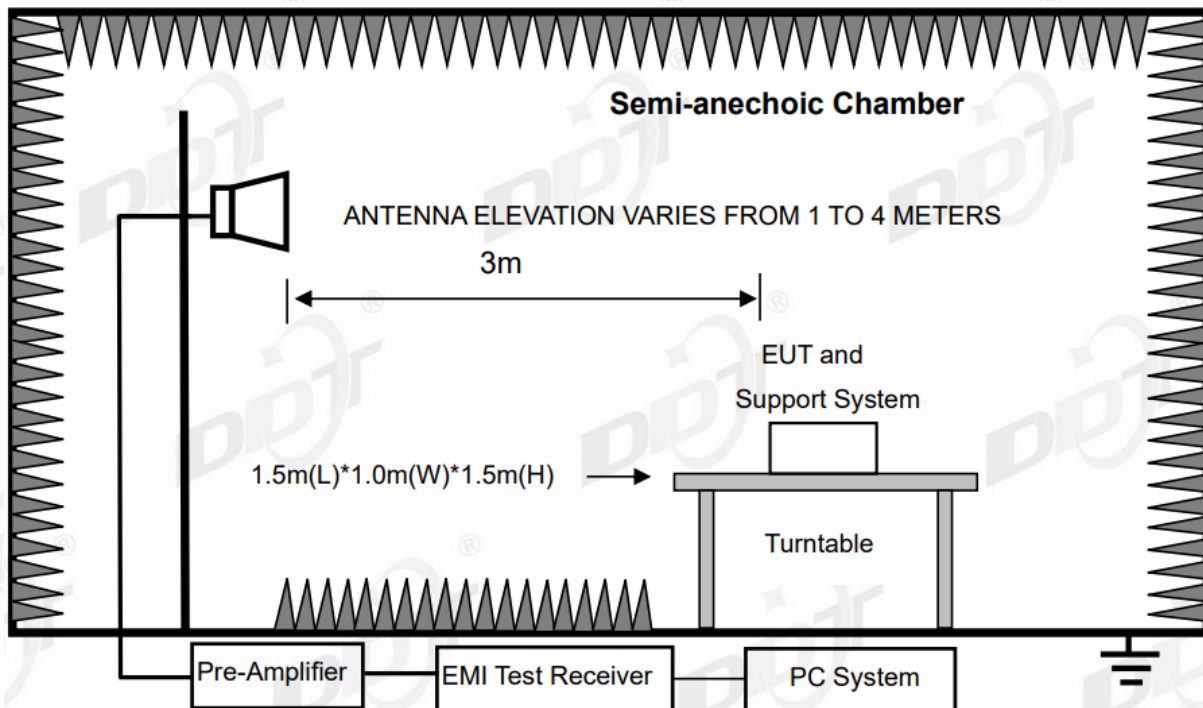

12.2. Limit

All restriction band should comply with 15.209, other emission should be at least 20 dB below the fundamental.

12.3. Test procedure

Same with clause 10.3 except change investigated frequency range from 2310 MHz to 2410 MHz and 2475 MHz to 2500 MHz.

Remark: All restriction band have been tested, and only the worst case is shown in report.

12.4. Test result

Pass. (See below detailed test result)

Remark: hopping on and hopping off mode all have been test, hopping off mode is worse and reported only, the worst case recorded in this report.

TR-4-E-009 Radiated Emission Test Result

Test Site : DDT 3m Chamber 3# D:\E3 6.111\2022 Report Data\Q22061414-23E aBOOM+\FCC ABOVE 1G .EM6
Test Date : 2022-09-06 **Tested By** : Bairong
EUT : Bluetooth Speaker **Model Number** : aBOOM+
Power Supply : AC 120V/60Hz **Test Mode** : Tx Mode
Condition : Temp:22°C,Humi:59.4%,Press:100.3kPa **Antenna/Distance** : 2021 BBHA 9120D
3#/3m/HORIZONTAL
Memo : DH5 2402

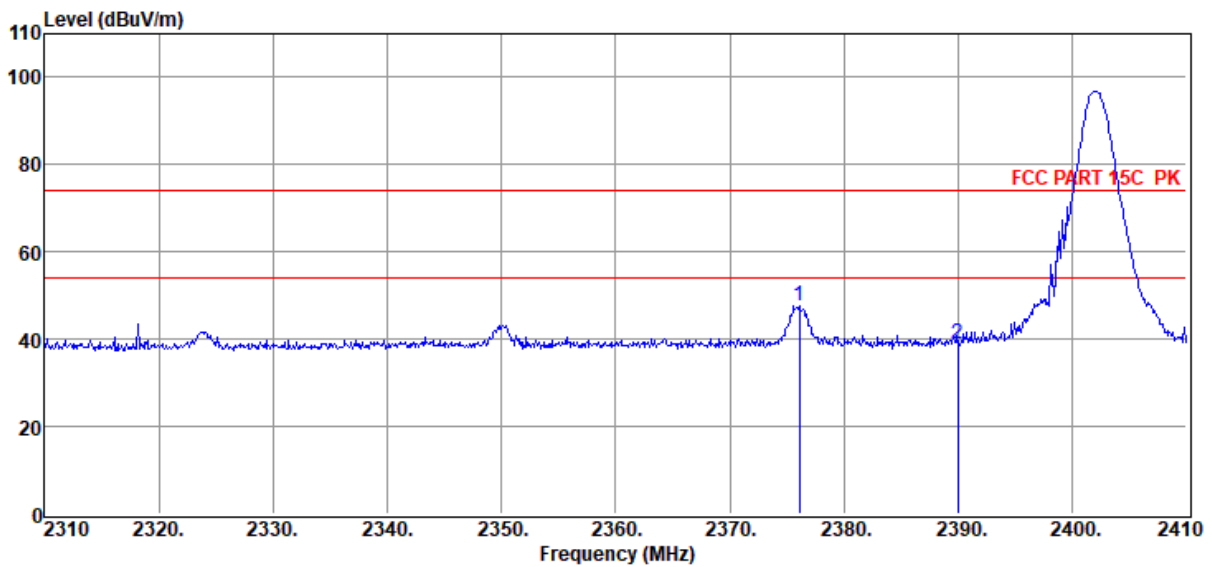

Item (Mark)	Freq. (MHz)	Read Level (dBµV)	Antenna Factor (dB/m)	PRM Factor (dB)	Cable Loss (dB)	Filter Factor (dB)	Result Level (dBµV/m)	Limit Line (dBµV/m)	Over Limit (dB)	Detector	Polarization
1	2376.10	57.53	27.38	39.59	1.71	0.72	47.75	74.00	-26.25	Peak	HORIZONTAL
2	2390.00	48.70	27.40	39.60	1.71	0.72	38.93	74.00	-35.07	Peak	HORIZONTAL

Note: 1. Result Level = Read Level + Antenna Factor + Cable loss + Filter Factor - PRM Factor.
 2. If Peak Result complies with AV limit, AV Result is deemed to comply with AV limit.
 3. Test setup: RBW: 1 MHz, VBW: 3 MHz, Sweep time: auto.

TR-4-E-009 Radiated Emission Test Result

Test Site : DDT 3m Chamber 3# D:\E3 6.111\2022 Report Data\Q22061414-23E aBOOM+\FCC ABOVE 1G .EM6
Test Date : 2022-09-06 **Tested By** : Bairong
EUT : Bluetooth Speaker **Model Number** : aBOOM+
Power Supply : AC 120V/60Hz **Test Mode** : Tx Mode
Condition : Temp:22°C,Humi:59.4%,Press:100.3kPa **Antenna/Distance** : 2021 BBHA 9120D 3#/3m/VERTICAL
Memo : DH5 2402

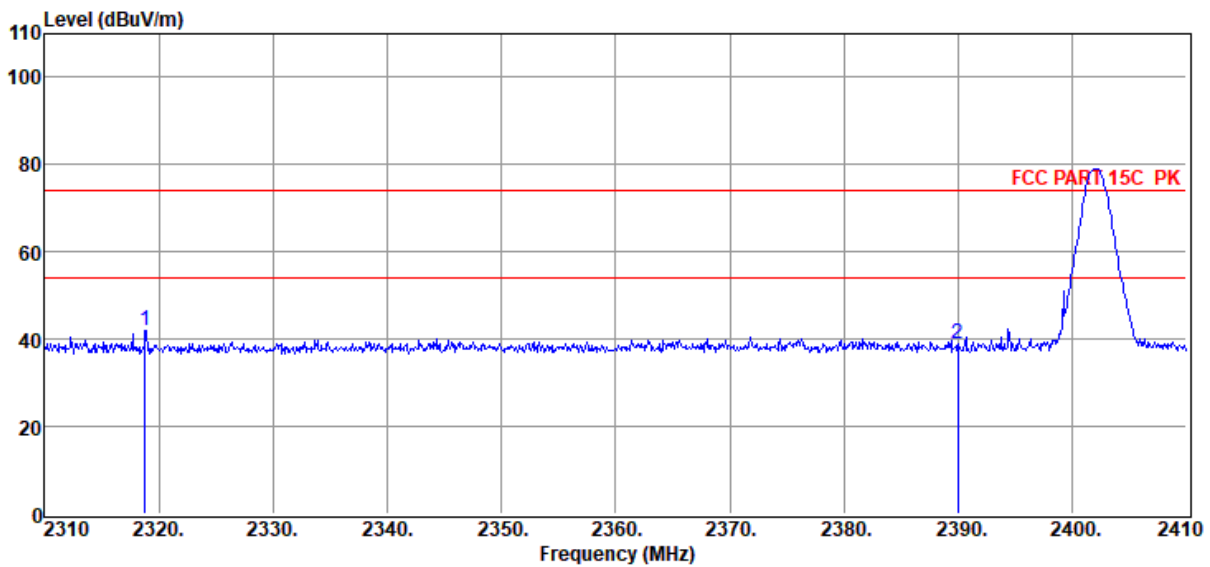

Item (Mark)	Freq. (MHz)	Read Level (dBµV)	Antenna Factor (dB/m)	PRM Factor (dB)	Cable Loss (dB)	Filter Factor (dB)	Result Level (dBµV/m)	Limit Line (dBµV/m)	Over Limit (dB)	Detector	Polarization
1	2318.80	51.98	27.27	39.56	1.69	0.72	42.10	74.00	-31.90	Peak	VERTICAL
2	2390.00	48.88	27.40	39.60	1.71	0.72	39.11	74.00	-34.89	Peak	VERTICAL

Note: 1. Result Level = Read Level + Antenna Factor + Cable loss + Filter Factor - PRM Factor.
 2. If Peak Result complies with AV limit, AV Result is deemed to comply with AV limit.
 3. Test setup: RBW: 1 MHz, VBW: 3 MHz, Sweep time: auto.

TR-4-E-009 Radiated Emission Test Result

Test Site : DDT 3m Chamber 3# D:\E3 6.111\2022 Report Data\Q22061414-23E aBOOM+\FCC ABOVE 1G .EM6
Test Date : 2022-09-06 **Tested By** : Bairong
EUT : Bluetooth Speaker **Model Number** : aBOOM+
Power Supply : AC 120V/60Hz **Test Mode** : Tx Mode
Condition : Temp:22°C,Humi:59.4%,Press:100.3kPa **Antenna/Distance** : 2021 BBHA 9120D
3#/3m/HORIZONTAL
Memo : 2DH5 2402

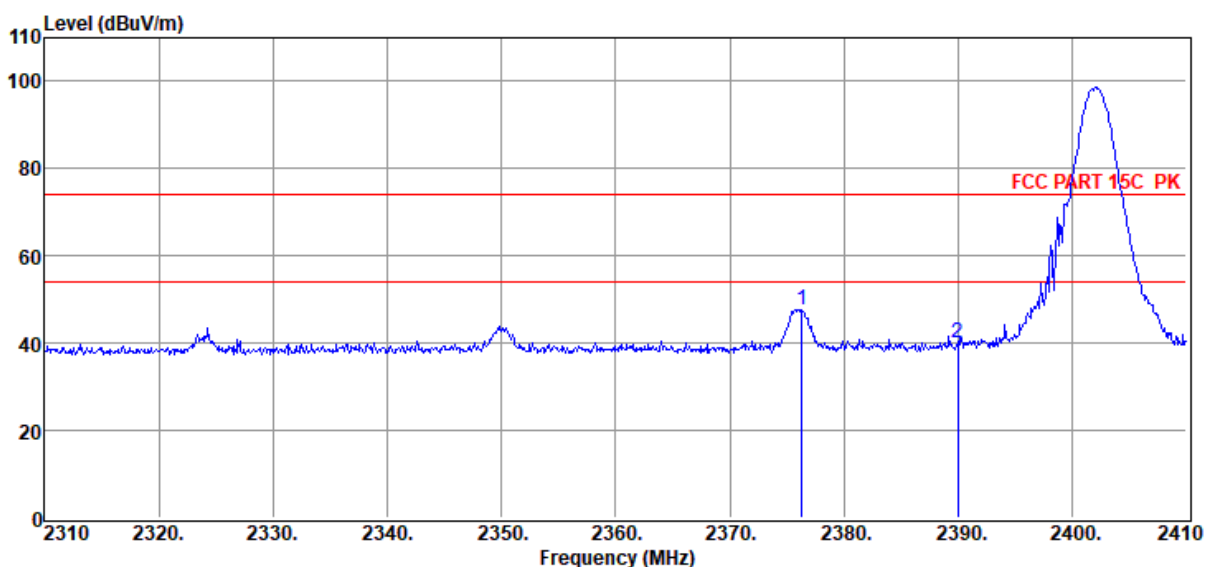

Item (Mark)	Freq. (MHz)	Read Level (dBµV)	Antenna Factor (dB/m)	PRM Factor (dB)	Cable Loss (dB)	Filter Factor (dB)	Result Level (dBµV/m)	Limit Line (dBµV/m)	Over Limit (dB)	Detector	Polarization
1	2376.30	57.49	27.38	39.59	1.71	0.72	47.71	74.00	-26.29	Peak	HORIZONTAL
2	2390.00	49.76	27.40	39.60	1.71	0.72	39.99	74.00	-34.01	Peak	HORIZONTAL

Note: 1. Result Level = Read Level + Antenna Factor + Cable loss + Filter Factor - PRM Factor.
 2. If Peak Result complies with AV limit, AV Result is deemed to comply with AV limit.
 3. Test setup: RBW: 1 MHz, VBW: 3 MHz, Sweep time: auto.

TR-4-E-009 Radiated Emission Test Result

Test Site : DDT 3m Chamber 3# D:\E3 6.111\2022 Report Data\Q22061414-23E
aBOOM+\FCC ABOVE 1G .EM6
Test Date : 2022-09-06 **Tested By** : Bairong
EUT : Bluetooth Speaker **Model Number** : aBOOM+
Power Supply : AC 120V/60Hz **Test Mode** : Tx Mode
Condition : Temp:22°C,Humi:59.4%,Press:100.3kPa **Antenna/Distance** : 2021 BBHA 9120D 3#/3m/VERTICAL
Memo : 2DH5 2402

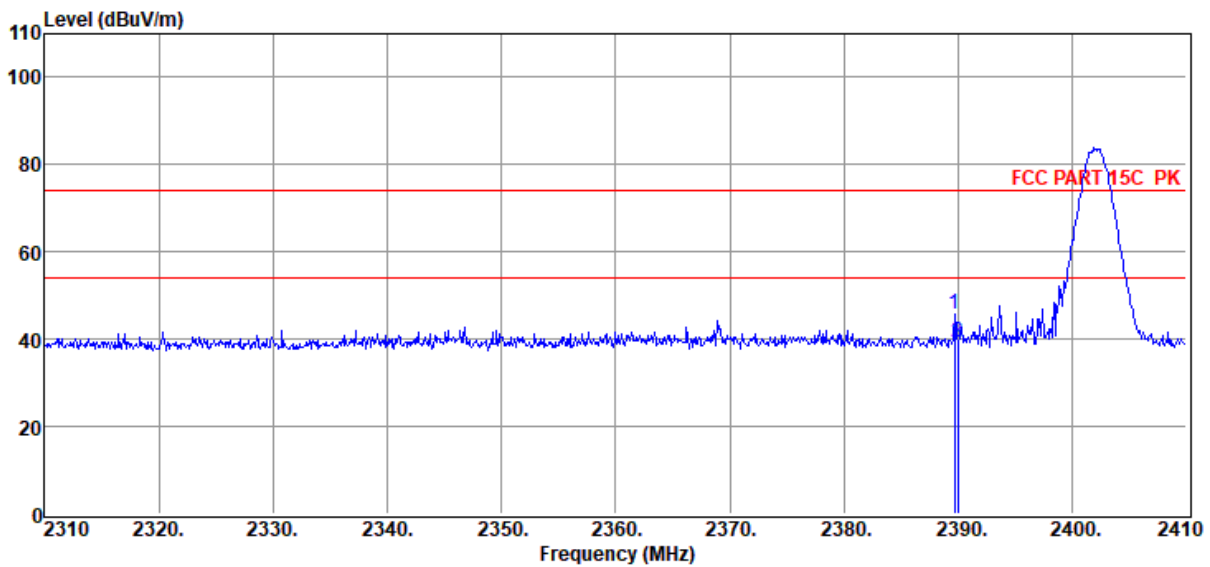

Item (Mark)	Freq. (MHz)	Read Level (dBµV)	Antenna Factor (dB/m)	PRM Factor (dB)	Cable Loss (dB)	Filter Factor (dB)	Result Level (dBµV/m)	Limit Line (dBµV/m)	Over Limit (dB)	Detector	Polarization
1	2389.70	55.53	27.40	39.59	1.71	0.72	45.77	74.00	-28.23	Peak	VERTICAL
2	2390.00	49.11	27.40	39.60	1.71	0.72	39.34	74.00	-34.66	Peak	VERTICAL

- Note: 1. Result Level = Read Level + Antenna Factor + Cable loss + Filter Factor - PRM Factor.
 2. If Peak Result complies with AV limit, AV Result is deemed to comply with AV limit.
 3. Test setup: RBW: 1 MHz, VBW: 3 MHz, Sweep time: auto.

TR-4-E-009 Radiated Emission Test Result

Test Site : DDT 3m Chamber 3# D:\E3 6.111\2022 Report Data\Q22061414-23E aBOOM+\FCC ABOVE 1G .EM6
Test Date : 2022-09-06 **Tested By** : Bairong
EUT : Bluetooth Speaker **Model Number** : aBOOM+
Power Supply : AC 120V/60Hz **Test Mode** : Tx Mode
Condition : Temp:22°C,Humi:59.4%,Press:100.3kPa **Antenna/Distance** : 2021 BBHA 9120D
3#/3m/HORIZONTAL
Memo : 3DH5 2402

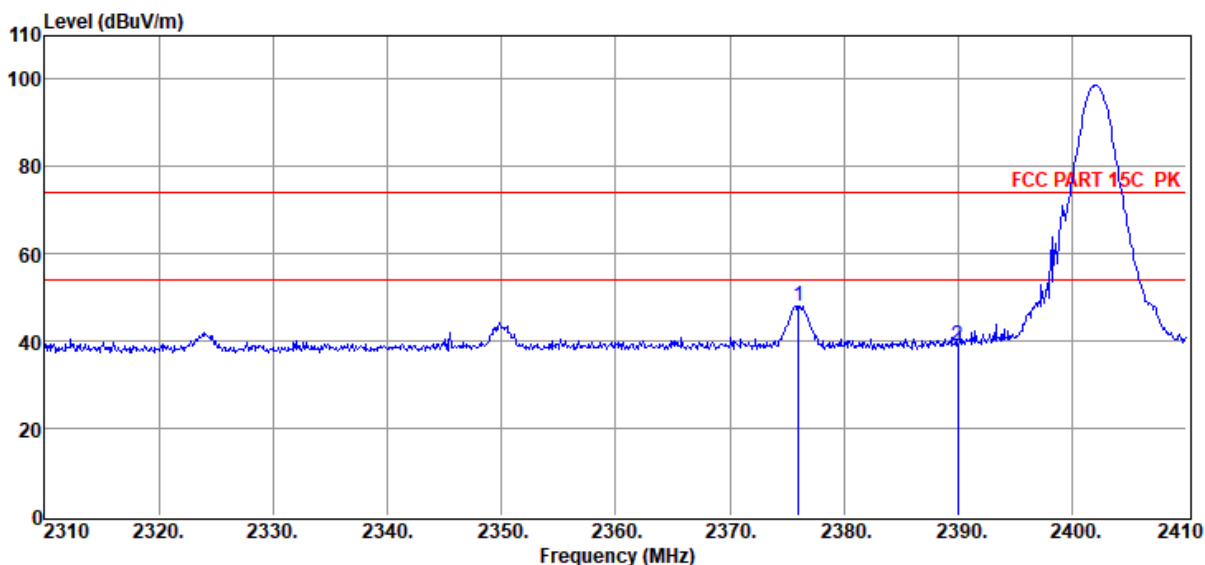

Item (Mark)	Freq. (MHz)	Read Level (dBµV)	Antenna Factor (dB/m)	PRM Factor (dB)	Cable Loss (dB)	Filter Factor (dB)	Result Level (dBµV/m)	Limit Line (dBµV/m)	Over Limit (dB)	Detector	Polarization
1	2376.00	57.89	27.38	39.59	1.71	0.72	48.11	74.00	-25.89	Peak	HORIZONTAL
2	2390.00	48.62	27.40	39.60	1.71	0.72	38.85	74.00	-35.15	Peak	HORIZONTAL

Note: 1. Result Level = Read Level + Antenna Factor + Cable loss + Filter Factor - PRM Factor.
 2. If Peak Result complies with AV limit, AV Result is deemed to comply with AV limit.
 3. Test setup: RBW: 1 MHz, VBW: 3 MHz, Sweep time: auto.

TR-4-E-009 Radiated Emission Test Result

Test Site : DDT 3m Chamber 3#

D:\E3 6.111\2022 Report Data\Q22061414-23E
aBOOM+\FCC ABOVE 1G .EM6

Test Date : 2022-09-06

Tested By : Bairong

EUT : Bluetooth Speaker

Model Number : aBOOM+

Power Supply : AC 120V/60Hz

Test Mode : Tx Mode

Condition : Temp:22°C,Humi:59.4%,Press:100.3kPa

Antenna/Distance : 2021 BBHA 9120D 3#/3m/VERTICAL

Memo : 3DH5 2402

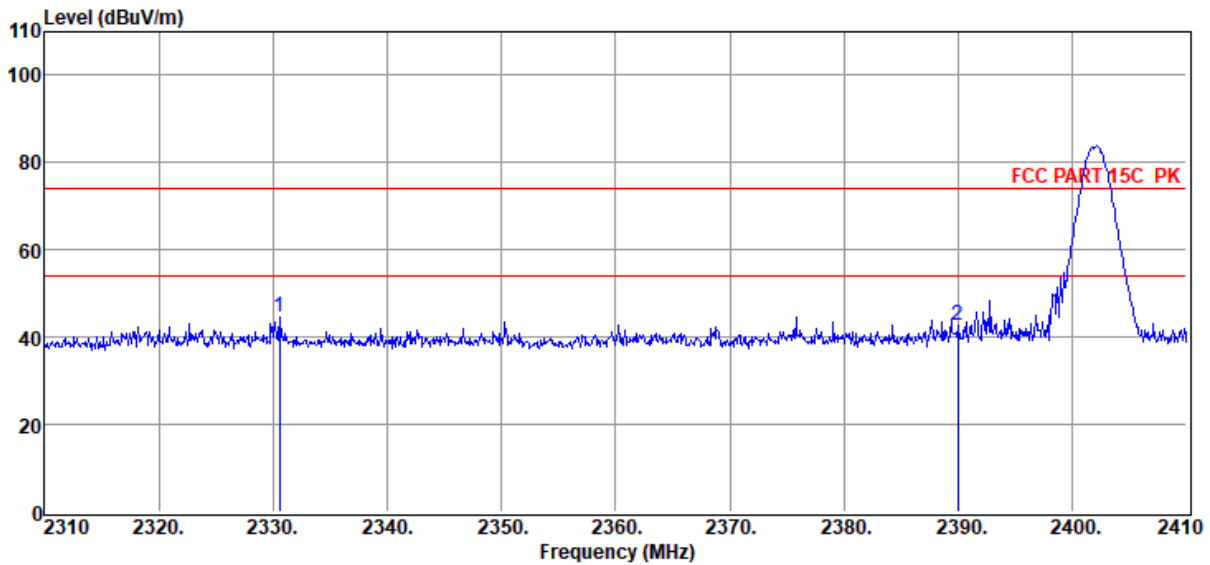

Item (Mark)	Freq. (MHz)	Read Level (dBµV)	Antenna Factor (dB/m)	PRM Factor (dB)	Cable Loss (dB)	Filter Factor (dB)	Result Level (dBµV/m)	Limit Line (dBµV/m)	Over Limit (dB)	Detector	Polarization
1	2330.60	54.41	27.30	39.57	1.69	0.72	44.55	74.00	-29.45	Peak	VERTICAL
2	2390.00	52.49	27.40	39.60	1.71	0.72	42.72	74.00	-31.28	Peak	VERTICAL

- Note: 1. Result Level = Read Level + Antenna Factor + Cable loss + Filter Factor - PRM Factor.
 2. If Peak Result complies with AV limit, AV Result is deemed to comply with AV limit.
 3. Test setup: RBW: 1 MHz, VBW: 3 MHz, Sweep time: auto.

TR-4-E-009 Radiated Emission Test Result

Test Site : DDT 3m Chamber 3# D:\E3 6.111\2022 Report Data\Q22061414-23E
aBOOM+\FCC ABOVE 1G .EM6
Test Date : 2022-09-06 **Tested By** : Bairong
EUT : Bluetooth Speaker **Model Number** : aBOOM+
Power Supply : AC 120V/60Hz **Test Mode** : Tx Mode
Condition : Temp:22°C,Humi:59.4%,Press:100.3kPa **Antenna/Distance** : 2021 BBHA 9120D
3#/3m/HORIZONTAL
Memo : DH5 2480

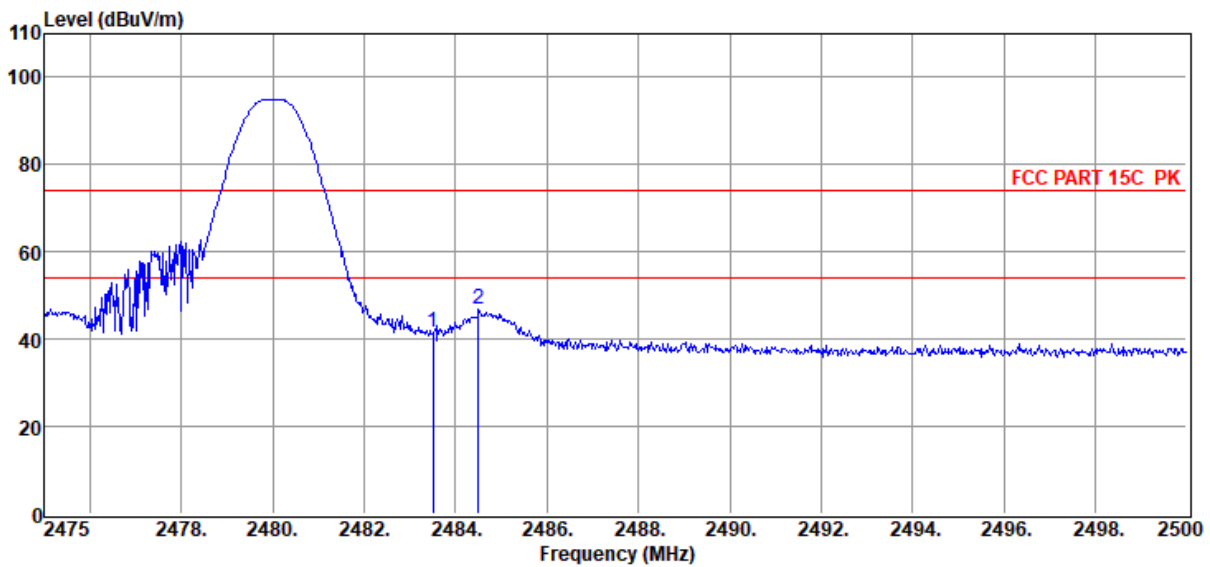

Item (Mark)	Freq. (MHz)	Read Level (dBµV)	Antenna Factor (dB/m)	PRM Factor dB	Cable Loss dB	Filter Factor dB	Result Level (dBµV/m)	Limit Line (dBµV/m)	Over Limit (dB)	Detector	Polarization
1	2483.50	51.33	27.57	39.64	1.74	0.73	41.73	74.00	-32.27	Peak	HORIZONTAL
2	2484.50	56.39	27.57	39.64	1.74	0.73	46.79	74.00	-27.21	Peak	HORIZONTAL

Note: 1. Result Level = Read Level + Antenna Factor + Cable loss + Filter Factor - PRM Factor.
 2. If Peak Result complies with AV limit, AV Result is deemed to comply with AV limit.
 3. Test setup: RBW: 1 MHz, VBW: 3 MHz, Sweep time: auto.

TR-4-E-009 Radiated Emission Test Result

Test Site : DDT 3m Chamber 3# D:\E3 6.111\2022 Report Data\Q22061414-23E
aBOOM+\FCC ABOVE 1G .EM6
Test Date : 2022-09-06 **Tested By** : Bairong
EUT : Bluetooth Speaker **Model Number** : aBOOM+
Power Supply : AC 120V/60Hz **Test Mode** : Tx Mode
Condition : Temp:22°C,Humi:59.4%,Press:100.3kPa **Antenna/Distance** : 2021 BBHA 9120D 3#/3m/VERTICAL
Memo : DH5 2480

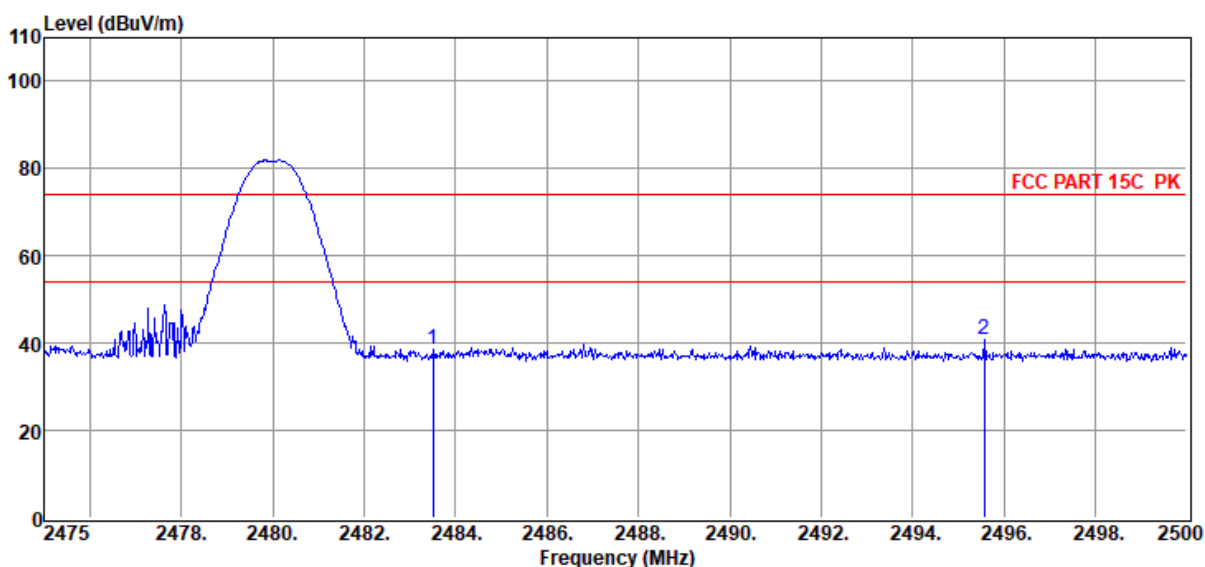

Item (Mark)	Freq. (MHz)	Read Level (dBμV)	Antenna Factor (dB/m)	PRM Factor (dB)	Cable Loss (dB)	Filter Factor (dB)	Result Level (dBμV/m)	Limit Line (dBμV/m)	Over Limit (dB)	Detector	Polarization
1	2483.50	48.12	27.57	39.64	1.74	0.73	38.52	74.00	-35.48	Peak	VERTICAL
2	2495.58	50.38	27.59	39.65	1.74	0.73	40.79	74.00	-33.21	Peak	VERTICAL

Note: 1. Result Level = Read Level + Antenna Factor + Cable loss + Filter Factor - PRM Factor.
 2. If Peak Result complies with AV limit, AV Result is deemed to comply with AV limit.
 3. Test setup: RBW: 1 MHz, VBW: 3 MHz, Sweep time: auto.

TR-4-E-009 Radiated Emission Test Result

Test Site : DDT 3m Chamber 3# D:\E3 6.111\2022 Report Data\Q22061414-23E aBOOM+\FCC ABOVE 1G .EM6
Test Date : 2022-09-06 **Tested By** : Bairong
EUT : Bluetooth Speaker **Model Number** : aBOOM+
Power Supply : AC 120V/60Hz **Test Mode** : Tx Mode
Condition : Temp:22°C,Humi:59.4%,Press:100.3kPa **Antenna/Distance** : 2021 BBHA 9120D
3#/3m/HORIZONTAL
Memo : 2DH5 2480

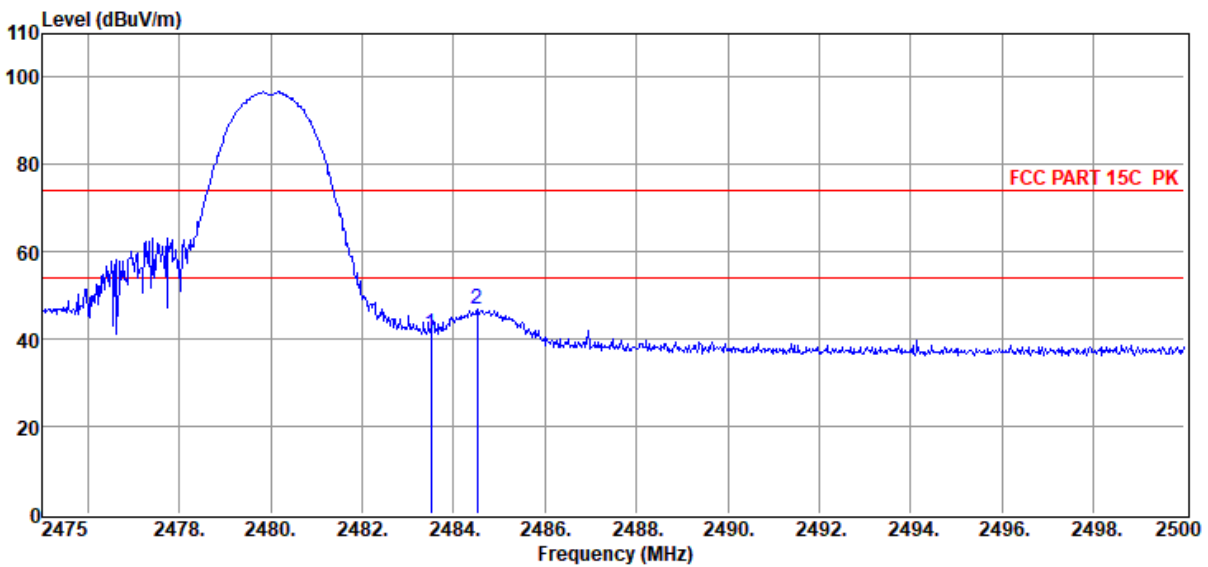

Item (Mark)	Freq. (MHz)	Read Level (dBµV)	Antenna Factor (dB/m)	PRM Factor dB	Cable Loss dB	Filter Factor dB	Result Level (dBµV/m)	Limit Line (dBµV/m)	Over Limit (dB)	Detector	Polarization
1	2483.50	50.81	27.57	39.64	1.74	0.73	41.21	74.00	-32.79	Peak	HORIZONTAL
2	2484.53	56.37	27.57	39.64	1.74	0.73	46.77	74.00	-27.23	Peak	HORIZONTAL

Note: 1. Result Level = Read Level + Antenna Factor + Cable loss + Filter Factor - PRM Factor.
 2. If Peak Result complies with AV limit, AV Result is deemed to comply with AV limit.
 3. Test setup: RBW: 1 MHz, VBW: 3 MHz, Sweep time: auto.

TR-4-E-009 Radiated Emission Test Result

Test Site : DDT 3m Chamber 3# D:\E3 6.111\2022 Report Data\Q22061414-23E aBOOM+\FCC ABOVE 1G .EM6
Test Date : 2022-09-06 **Tested By** : Bairong
EUT : Bluetooth Speaker **Model Number** : aBOOM+
Power Supply : AC 120V/60Hz **Test Mode** : Tx Mode
Condition : Temp:22°C,Humi:59.4%,Press:100.3kPa **Antenna/Distance** : 2021 BBHA 9120D 3#/3m/VERTICAL
Memo : 2DH5 2480

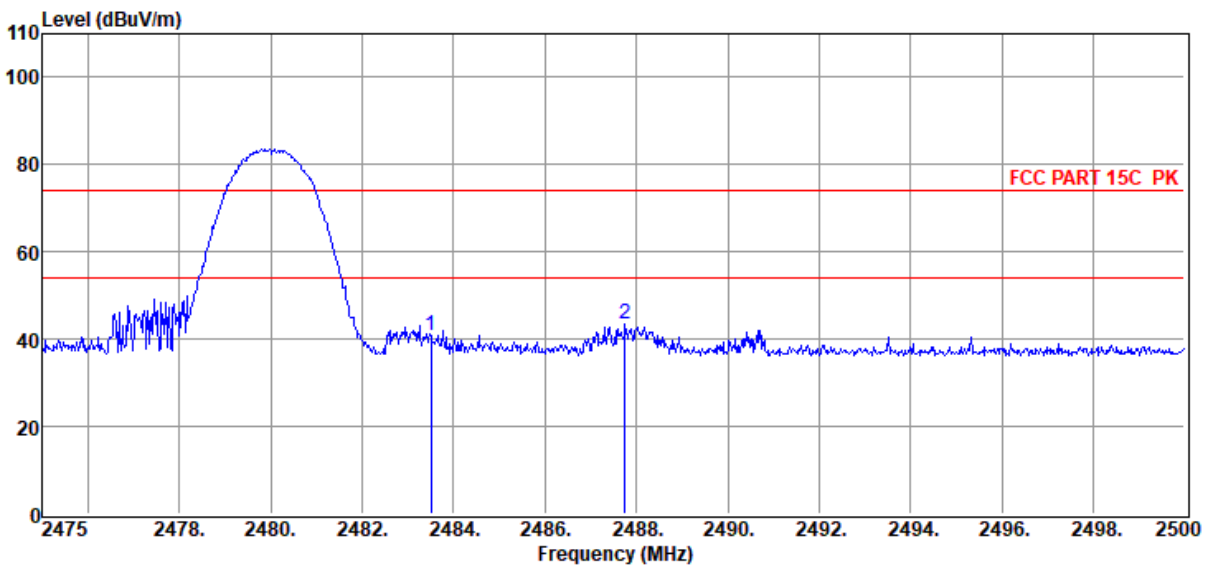

Item (Mark)	Freq. (MHz)	Read Level (dBµV)	Antenna Factor (dB/m)	PRM Factor (dB)	Cable Loss (dB)	Filter Factor (dB)	Result Level (dBµV/m)	Limit Line (dBµV/m)	Over Limit (dB)	Detector	Polarization
1	2483.50	50.48	27.57	39.64	1.74	0.73	40.88	74.00	-33.12	Peak	VERTICAL
2	2487.75	52.93	27.58	39.64	1.74	0.73	43.34	74.00	-30.66	Peak	VERTICAL

Note: 1. Result Level = Read Level + Antenna Factor + Cable loss + Filter Factor - PRM Factor.
 2. If Peak Result complies with AV limit, AV Result is deemed to comply with AV limit.
 3. Test setup: RBW: 1 MHz, VBW: 3 MHz, Sweep time: auto.

TR-4-E-009 Radiated Emission Test Result

Test Site : DDT 3m Chamber 3# D:\E3 6.111\2022 Report Data\Q22061414-23E
aBOOM+\FCC ABOVE 1G .EM6
Test Date : 2022-09-06 **Tested By** : Bairong
EUT : Bluetooth Speaker **Model Number** : aBOOM+
Power Supply : AC 120V/60Hz **Test Mode** : Tx Mode
Condition : Temp:22°C,Humi:59.4%,Press:100.3kPa **Antenna/Distance** : 2021 BBHA 9120D
3#/3m/HORIZONTAL
Memo : 3DH5 2480

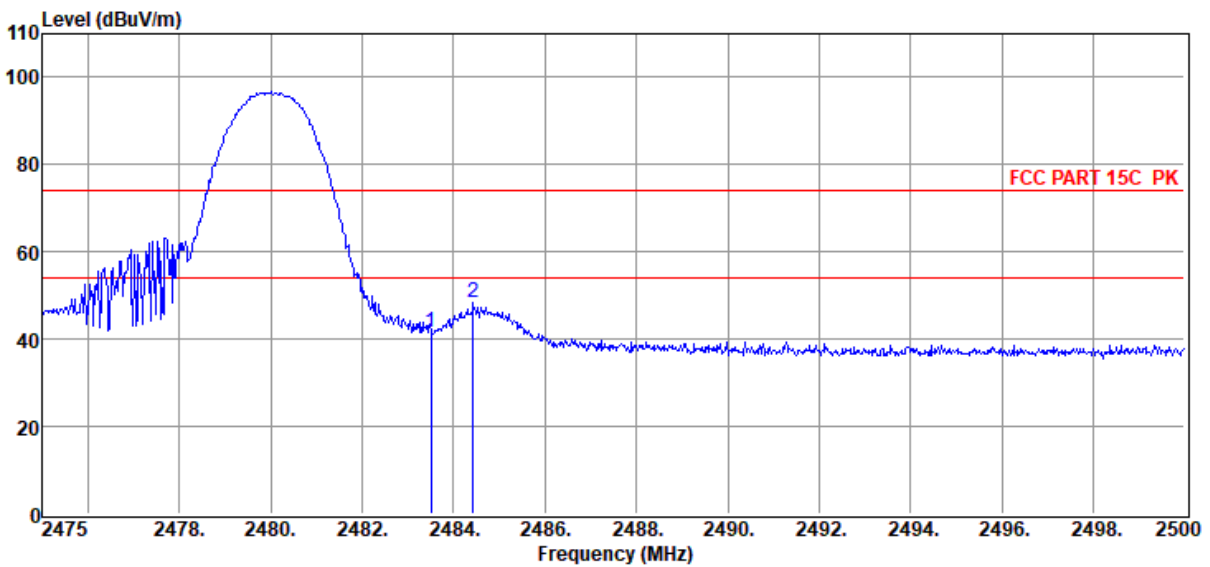

Item (Mark)	Freq. (MHz)	Read Level (dBµV)	Antenna Factor (dB/m)	PRM Factor dB	Cable Loss dB	Filter Factor dB	Result Level (dBµV/m)	Limit Line (dBµV/m)	Over Limit (dB)	Detector	Polarization
1	2483.50	51.07	27.57	39.64	1.74	0.73	41.47	74.00	-32.53	Peak	HORIZONTAL
2	2484.43	58.13	27.57	39.64	1.74	0.73	48.53	74.00	-25.47	Peak	HORIZONTAL

Note: 1. Result Level = Read Level + Antenna Factor + Cable loss + Filter Factor - PRM Factor.
 2. If Peak Result complies with AV limit, AV Result is deemed to comply with AV limit.
 3. Test setup: RBW: 1 MHz, VBW: 3 MHz, Sweep time: auto.

TR-4-E-009 Radiated Emission Test Result

Test Site : DDT 3m Chamber 3# D:\E3 6.111\2022 Report Data\Q22061414-23E
aBOOM+\FCC ABOVE 1G .EM6
Test Date : 2022-09-06 **Tested By** : Bairong
EUT : Bluetooth Speaker **Model Number** : aBOOM+
Power Supply : AC 120V/60Hz **Test Mode** : Tx Mode
Condition : Temp:22°C,Humi:59.4%,Press:100.3kPa **Antenna/Distance** : 2021 BBHA 9120D 3#/3m/VERTICAL
Memo : 3DH5 2480

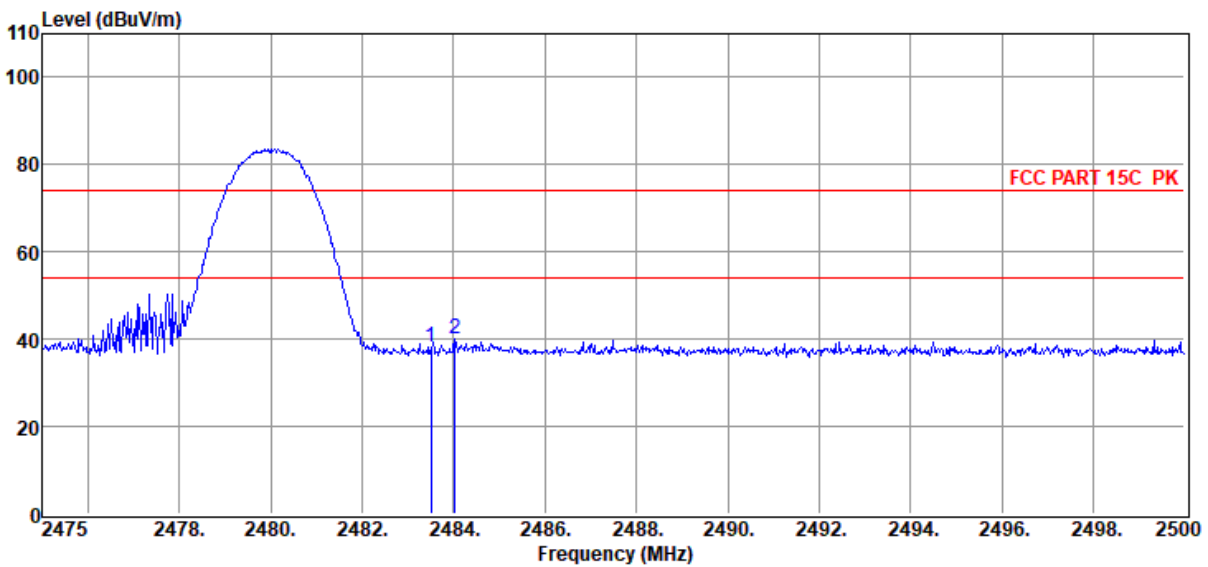

Item (Mark)	Freq. (MHz)	Read Level (dBμV)	Antenna Factor (dB/m)	PRM Factor (dB)	Cable Loss (dB)	Filter Factor (dB)	Result Level (dBμV/m)	Limit Line (dBμV/m)	Over Limit (dB)	Detector	Polarization
1	2483.50	47.76	27.57	39.64	1.74	0.73	38.16	74.00	-35.84	Peak	VERTICAL
2	2484.03	49.50	27.57	39.64	1.74	0.73	39.90	74.00	-34.10	Peak	VERTICAL

Note: 1. Result Level = Read Level + Antenna Factor + Cable loss + Filter Factor - PRM Factor.
 2. If Peak Result complies with AV limit, AV Result is deemed to comply with AV limit.
 3. Test setup: RBW: 1 MHz, VBW: 3 MHz, Sweep time: auto.

13. Power Line Conducted Emission

13.1. Block diagram of test setup

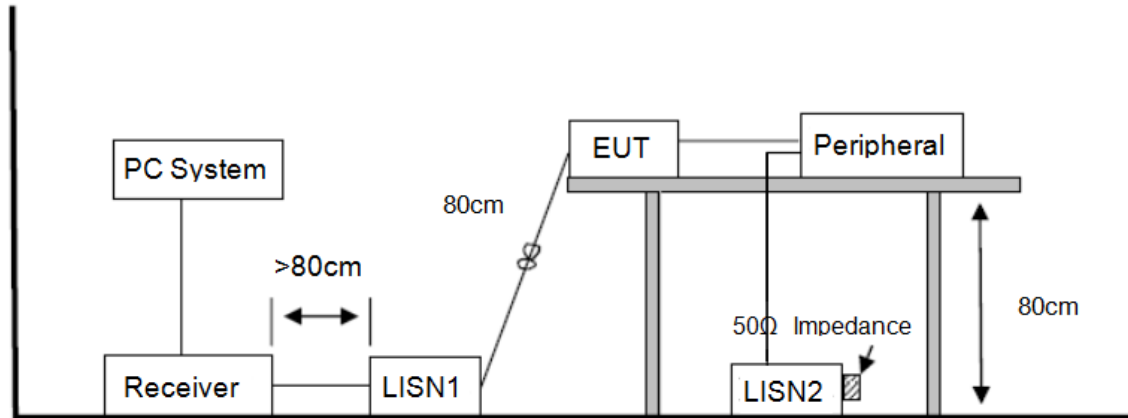

13.2. Power line conducted emission limits

Frequency	Quasi-Peak Level dB(μ V)	Average Level dB(μ V)
150 kHz ~ 500 kHz	66 ~ 56*	56 ~ 46*
500 kHz ~ 5 MHz	56	46
5 MHz ~ 30 MHz	60	50

Note 1: * Decreasing linearly with logarithm of frequency.

Note 2: The lower limit shall apply at the transition frequencies.

13.3. Test procedure

The EUT and Support equipment, if needed, were put placed on a non-metallic table, 80cm above the ground plane.

Configuration EUT to simulate typical usage as described in clause 2.4 and test equipment as described in clause 13.1 of this report.

All I/O cables were positioned to simulate typical actual usage as per ANSI C63.10.

All support equipment power received from a second LISN.

Emissions were measured on each current carrying line of the EUT using an EMI Test Receiver connected to the LISN powering the EUT.

The Receiver scanned from 150 kHz to 30 MHz for emissions in each of the test modes.

During the above scans, the emissions were maximized by cable manipulation.

The test mode(s) described in clause 2.4 were scanned during the preliminary test.

After the preliminary scan, we found the test mode producing the highest emission level.

The EUT configuration and worse cable configuration of the above highest emission levels were recorded for reference of the final test.

EUT and support equipment were set up on the test bench as per the configuration with highest emission level in the preliminary test.

A scan was taken on both power lines, Neutral and Line, recording at least the six highest emissions.

Emission frequency and amplitude were recorded into a computer in which correction factors were used to calculate the emission level and compare reading to the applicable limit.

The test data of the worst-case condition(s) was recorded.

The bandwidth of test receiver is set at 9 kHz.

13.4. Test result

Pass. (See below detailed test result)

Note1: All emissions not reported below are too low against the prescribed limits.

Note2: "----" means Peak detection; "----" means Average detection.

Note3: Pre-test AC conducted emission at both voltage AC 120V/60Hz and AC 240V/50Hz, recorded worse case.

TR-4-E-010 Conducted Emission Test Result

Test Site : DDT 1# Shield Room D:\2022 CE report date\Q22061414-23E aBOOM+FCC.EM6
Test Date : 2022-09-21 **Tested By** : James Gan
EUT : Bluetooth Speaker **Model Number** : aBOOM+
Power Supply : AC 120V/60Hz **Test Mode** : TX mode
Condition : TEMP:22.5°C, RH:58.9%, BP:100.3kPa **LISN** : 2021 1# ENV216/NEUTRAL
Memo :

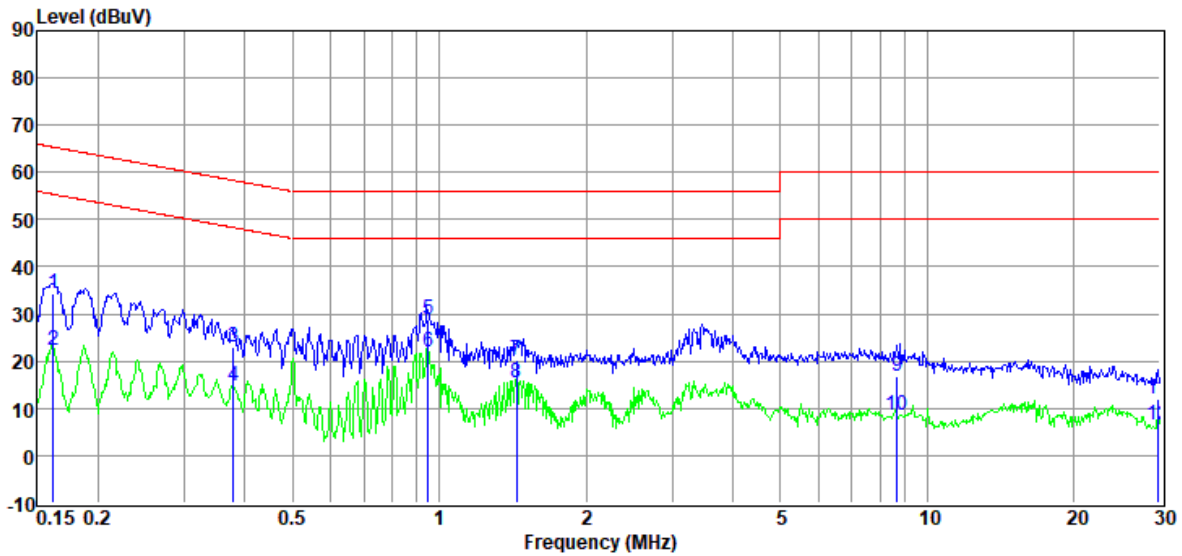

Item (Mark)	Freq. (MHz)	Read Level (dBμV)	LISN Factor (dB)	Cable Loss (dB)	Pulse Limiter Factor (dB)	Result Level (dBμV)	Limit Line (dBμV)	Over Limit (dB)	Detector	Phase
1	0.16	14.70	9.80	0.01	9.92	34.43	65.38	-30.95	QP	NEUTRAL
2	0.16	2.58	9.80	0.01	9.92	22.31	55.38	-33.07	Average	NEUTRAL
3	0.38	3.39	9.59	0.02	9.91	22.91	58.30	-35.39	QP	NEUTRAL
4	0.38	-4.79	9.59	0.02	9.91	14.73	48.30	-33.57	Average	NEUTRAL
5	0.95	9.09	9.71	0.03	9.89	28.72	56.00	-27.28	QP	NEUTRAL
6	0.95	2.46	9.71	0.03	9.89	22.09	46.00	-23.91	Average	NEUTRAL
7	1.44	0.49	9.65	0.04	9.89	20.07	56.00	-35.93	QP	NEUTRAL
8	1.44	-4.02	9.65	0.04	9.89	15.56	46.00	-30.44	Average	NEUTRAL
9	8.68	-2.82	9.72	0.10	9.94	16.94	60.00	-43.06	QP	NEUTRAL
10	8.68	-11.29	9.72	0.10	9.94	8.47	50.00	-41.53	Average	NEUTRAL
11	29.68	-8.26	9.90	0.20	10.00	11.84	60.00	-48.16	QP	NEUTRAL
12	29.68	-13.47	9.90	0.20	10.00	6.63	50.00	-43.37	Average	NEUTRAL

Note:

1. Result Level = Read Level + LISN Factor + Pulse Limiter Factor + Cable loss.
2. If QP Result complies with AV limit, AV Result is deemed to comply with AV limit.
3. Test setup: RBW: 200 Hz (9 kHz—150 kHz), 9 kHz (150 kHz—30 MHz).
4. Step size: 80Hz (0.009MHz-0.15MHz), 4 kHz (0.15MHz-30MHz), Scan time: auto.

TR-4-E-010 Conducted Emission Test Result

Test Site : DDT 1# Shield Room **D:\2022 CE report date\Q22061414-23E aBOOM+FCC.EM6**
Test Date : 2022-09-21 **Tested By** : James Gan
EUT : Bluetooth Speaker **Model Number** : aBOOM+
Power Supply : AC 120V/60Hz **Test Mode** : TX mode
Condition : TEMP:22.5°C, RH:58.9%, BP:100.3kPa **LISN** : 2021 1# ENV216/LINE

Memo :

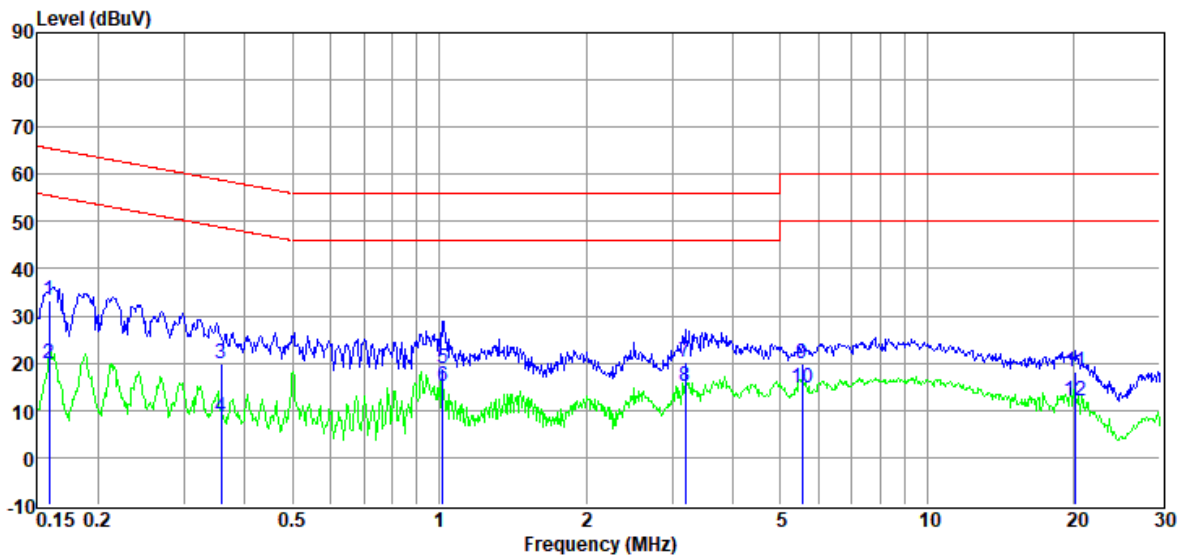

Item (Mark)	Freq. (MHz)	Read Level (dBuV)	LISN Factor (dB)	Cable Loss (dB)	Pulse Limiter Factor (dB)	Result Level (dBuV)	Limit Line (dBuV)	Over Limit (dB)	Detector	Phase
1	0.16	13.67	9.64	0.01	9.92	33.24	65.52	-32.28	QP	LINE
2	0.16	0.35	9.64	0.01	9.92	19.92	55.52	-35.60	Average	LINE
3	0.36	0.31	9.67	0.02	9.91	19.91	58.78	-38.87	QP	LINE
4	0.36	-10.91	9.67	0.02	9.91	8.69	48.78	-40.09	Average	LINE
5	1.02	-0.75	9.60	0.03	9.89	18.77	56.00	-37.23	QP	LINE
6	1.02	-4.50	9.60	0.03	9.89	15.02	46.00	-30.98	Average	LINE
7	3.19	0.58	9.57	0.05	9.91	20.11	56.00	-35.89	QP	LINE
8	3.19	-4.58	9.57	0.05	9.91	14.95	46.00	-31.05	Average	LINE
9	5.54	0.25	9.54	0.07	9.93	19.79	60.00	-40.21	QP	LINE
10	5.54	-4.80	9.54	0.07	9.93	14.74	50.00	-35.26	Average	LINE
11	20.16	-1.54	9.60	0.17	9.96	18.19	60.00	-41.81	QP	LINE
12	20.16	-7.62	9.60	0.17	9.96	12.11	50.00	-37.89	Average	LINE

Note:

1. Result Level = Read Level + LISN Factor + Pulse Limiter Factor + Cable loss.
2. If QP Result complies with AV limit, AV Result is deemed to comply with AV limit.
3. Test setup: RBW: 200 Hz (9 kHz—150 kHz), 9 kHz (150 kHz—30 MHz).
4. Step size: 80Hz (0.009MHz-0.15MHz), 4 kHz (0.15MHz-30MHz), Scan time: auto.

14. Antenna Requirements

14.1. Limit

For intentional device, according to FCC 47 CFR Section 15.203, an intentional radiator shall be designed to ensure that no antenna other than that furnished by the responsible party shall be used with the device. And according to FCC 47 CFR Section 15.247 (b), if transmitting antennas of directional gain greater than 6 dBi are used, the power shall be reduced by the amount in dB that the directional gain of the antenna exceeds 6 dBi.

14.2. Result

The antenna used for this product and that no antenna other than that furnished by the responsible party shall be used with the device, the maximum peak gain is -0.68 dBi.