

FCC Radio Test Report

FCC ID: 2ACVA-BT02B150

Original Grant

Report No. : TB-FCC141134
Applicant : HUIZHOU GAOSHENGDA TECHNOLOGY CO., LTD
Equipment Under Test (EUT)
EUT Name : Bluetooth Module
Model No. : BT02B150
Series Model No. : N/A
Brand Name : N/A
Receipt Date : 2014-07-08
Test Date : 2014-07-09 to 2014-07-24
Issue Date : 2014-07-28
Standards : FCC Part 15, Subpart C (15.247:2012)
Test Method : ANSI C63.4:2003
Conclusions : **PASS**

In the configuration tested, the EUT complied with the standards specified above,

The EUT technically complies with the FCC requirements

Test/Witness Engineer :

IWAN SU

Approved & Authorized :

Ray



This report details the results of the testing carried out on one sample. The results contained in this test report do not relate to other samples of the same product. The manufacturer should ensure that all products in series production are in conformity with the product sample detailed in the report.

Contents

CONTENTS.....	2
1. GENERAL INFORMATION ABOUT EUT	4
1.1 Client Information.....	4
1.2 General Description of EUT (Equipment Under Test)	4
1.3 Block Diagram Showing the Configuration of System Tested.....	5
1.4 Description of Support Units	5
1.5 Description of Test Mode.....	6
1.6 Description of Test Software Setting	6
1.7 Test Facility.....	7
2. TEST SUMMARY	8
3. CONDUCTED EMISSION TEST	9
3.1 Test Standard and Limit.....	9
3.2 Test Setup.....	9
3.3 Test Procedure.....	9
3.4 Test Equipment Used.....	10
3.5 EUT Operating Mode	10
3.6 Test Data.....	10
4. RADIATED EMISSION TEST	13
4.1 Test Standard and Limit.....	13
4.2 Test Setup.....	14
4.3 Test Procedure.....	15
4.4 EUT Operating Condition	15
4.5 Test Equipment	15
4.6 Test Data.....	16
5. RESTRICTED BANDS REQUIREMENT	25
5.1 Test Standard and Limit.....	25
5.2 Test Setup.....	25
5.3 Test Procedure.....	25
5.4 EUT Operating Condition	26
5.5 Test Equipment	26
5.6 Test Data.....	26
6. BANDWIDTH TEST	32
6.1 Test Standard and Limit.....	32
6.2 Test Setup.....	32
6.3 Test Procedure.....	32
6.4 EUT Operating Condition	32
6.5 Test Equipment	32
6.6 Test Data.....	33
7. PEAK OUTPUT POWER TEST.....	35

7.1 Test Standard and Limit.....	35
7.2 Test Setup.....	35
7.3 Test Procedure.....	35
7.4 EUT Operating Condition	35
7.5 Test Equipment	35
7.6 Test Data.....	36
8. POWER SPECTRAL DENSITY TEST	39
8.1 Test Standard and Limit.....	39
8.2 Test Setup.....	39
8.3 Test Procedure.....	39
8.4 EUT Operating Condition	39
8.5 Test Equipment.....	40
8.6 Test Data.....	40
9. ANTENNA CONDUCTED SPURIOUS EMISSION	42
9.1 Test Standard and Limit.....	42
9.2 Test Setup.....	42
9.3 Test Procedure.....	42
9.4 EUT Operating Condition	43
9.5 Test Equipment.....	43
9.6 Test Data.....	43
10. ANTENNA REQUIREMENT.....	47
10.1 Standard Requirement.....	47
10.2 Antenna Connected Construction	47
10.2 Result.....	47

1. General Information about EUT

1.1 Client Information

Applicant : HUIZHOU GAOSHENGDA TECHNOLOGY CO., LTD
Address : HUA YU RD., NO.75, ZHONGKAI HIGH-TECH DEVELOPMENT AREA, HUIZHOU, CHINA
Manufacturer : HUIZHOU GAOSHENGDA TECHNOLOGY CO., LTD
Address : HUA YU RD., NO.75, ZHONGKAI HIGH-TECH DEVELOPMENT AREA, HUIZHOU, CHINA

1.2 General Description of EUT (Equipment Under Test)

EUT Name	:	Bluetooth Module	
Models No.	:	BT02B150	
Model Difference	:	N/A	
Product Description	:	Operation Frequency: 2402MHz~2480MHz	
	:	Number of Channel:	Bluetooth 4.0 (BLE): 40 channels see note(3)
	:	RF Output Power:	3.305 dBm Conducted Power
	:	Antenna Gain:	3 dBi PIFA Antenna
	:	Modulation Type:	GFSK
	:	Bit Rate of Transmitter:	1Mbps(GFSK)
Power Supply	:	DC Voltage supplied from PC System.	
Power Rating	:	DC 5V by USB adapter from PC System.	
Connecting I/O Port(S)	:	Please refer to the User's Manual	
Note: The equipment with Bluetooth Bluetooth 4.0+EDR have test comply with FCC Part 15C Rules. More detailed features description, please refer to the manufacturer's specifications or the User's Manual.			

Note:

- (1) This Test Report is FCC Part 15.247 for Bluetooth BLE, the test procedure follows the FCC KDB 558074 D01 DTS Meas Guidance v03r02.
- (2) For a more detailed features description, please refer to the manufacturer's specifications or the User's Manual.
- (3) Antenna information provided by the applicant.
- (4) Channel List:

Channel	Frequency	Channel	Frequency	Channel	Frequency
---------	-----------	---------	-----------	---------	-----------

	(MHz)		(MHz)		(MHz)
00	2402	14	2430	28	2458
01	2404	15	2432	29	2460
02	2406	16	2434	30	2462
03	2408	17	2436	31	2464
04	2410	18	2438	32	2466
05	2412	19	2440	33	2468
06	2414	Cable 1	2442	34	2470
07	2416	21	2444	35	2472
08	2418	22	2446	36	2474
09	2420	23	2448	37	2476
10	2422	24	2450	38	2478
11	2424	25	2452	39	2480
12	2426	26	2454		
13	2428	27	2456		

1.3 Block Diagram Showing the Configuration of System Tested

TX Mode

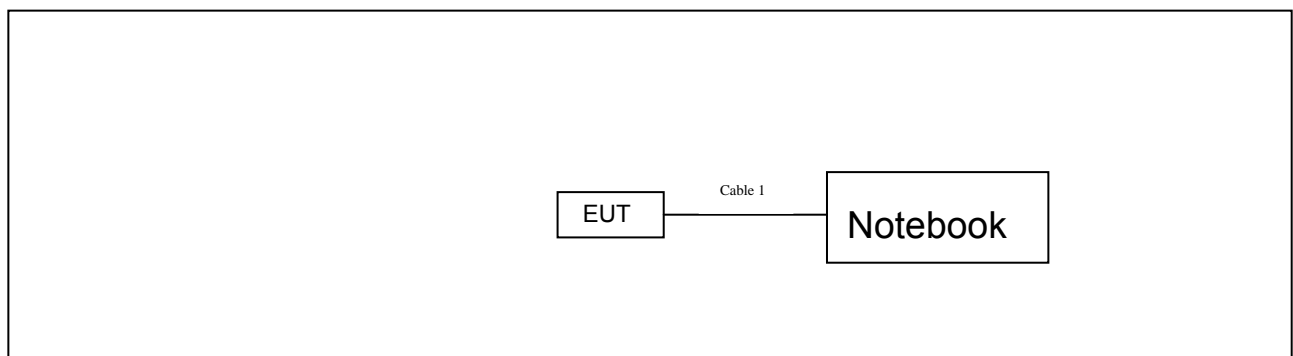

1.4 Description of Support Units

Equipment Information				
Name	Model	S/N	Manufacturer	Used “√”
Notebook	T60P	42W3244	Lenovo	√
Cable Information				
Number	Shielded Type	Ferrite Core	Length	Note
Cable 1	NO	NO	0.35M	

1.5 Description of Test Mode

To investigate the maximum EMI emission characteristics generates from EUT, the test system was pre-scanning tested base on the consideration of following EUT operation mode or test configuration mode which possible have effect on EMI emission level. Each of these EUT operation mode(s) or test configuration mode(s) mentioned follow was evaluated respectively.

For Conducted Test	
Final Test Mode	Description
Mode 1	PC Charging with TX Mode

For Radiated Test	
Final Test Mode	Description
Mode 2	PC Charging with TX Mode
Mode 3	PC Charging with TX Mode (Channel 01/20/39)

Note:

- (1) For all test, we have verified the construction and function in typical operation. And all the test modes were carried out with the EUT in transmitting operation in maximum power with all kinds of data rate.

According to ANSI C63.4 standards, the measurements are performed at the highest, middle, lowest available channels, and the worst case data rate as follows:

Bluetooth BLE Mode: GFSK Modulation Transmitting mode.

- (2) During the testing procedure, the continuously transmitting with the maximum power mode was programmed by the customer.
- (3) The EUT is considered a mobile unit; in normal use it was positioned on X-plane. The worst case was found positioned on X-plane. Therefore only the test data of this X-plane was used for radiated emission measurement test.

1.6 Description of Test Software Setting

During testing channel& Power controlling software provided by the customer was used to control the operating channel as well as the output power level. The RF output power selection is for the setting of RF output power expected by the customer and is going to be fixed on the firmware of the final end product power parameters of RF setting.

Test Software Version	Test Program: Bluesuite 2.4.exe		
Channel	CH 01	CH 20	CH 39
BLE Mode	DEF	DEF	DEF

1.7 Test Facility

The testing was performed by the Shenzhen Toby Technology Co., Ltd., in their facilities located at:

1A/F., Bldg.6, Yusheng Industrial Zone, The National Road No.107 Xixiang Section 467, Xixiang, Bao'an, Shenzhen, Guangdong, China.

At the time of testing, the following bodies accredited the Laboratory:

CNAS (L5813)

The Laboratory has been accredited by CNAS to ISO/IEC 17025: 2005 General Requirements for the Competence of Testing and Calibration Laboratories for the competence in the field of testing. And the Registration No.: CNAS L5813.

FCC List No.: (811562)

The Laboratory is listed in the United States of American Federal Communications Commission (FCC), and the registration number is 811562.

IC Registration No.: (11950A-1)

The Laboratory has been registered by Certification and Engineering Bureau of Industry Canada for radio equipment testing. The site registration: Site# 11950A-1.

2. Test Summary

FCC Part 15 Subpart C(15.247)/RSS-210: 2010				
Standard Section		Test Item	Judgment	Remark
FCC	IC			
15.203	/	Antenna Requirement	PASS	N/A
15.207	RSS-GEN 7.2.4	Conducted Emission	PASS	N/A
15.205	RSS-GEN 7.2.2	Restricted Bands	PASS	N/A
15.247(a)(2)	RSS-210 A.8.2(a)	6dB Bandwidth	PASS	N/A
15.247(b)	RSS-210 A.8.4(4)	Peak Output Power	PASS	N/A
15.247(e)	RSS-210 A.8.2(b)	Power Spectral Density	PASS	N/A
15.247(d)	RSS-210 Annex 8 (A8.5)	Transmitter Radiated Spurious Emission	PASS	N/A
15.247(d)	RSS-210 Annex 8 (A8.5)	Antenna Conducted Spurious Emission	PASS	N/A

Note: "/" for no requirement for this test item.
N/A is an abbreviation for Not Applicable.

3. Conducted Emission Test

3.1 Test Standard and Limit

3.1.1 Test Standard

FCC Part 15.207

3.1.2 Test Limit

Conducted Emission Test Limit

Frequency	Maximum RF Line Voltage (dB μ V)	
	Quasi-peak Level	Average Level
150kHz~500kHz	66 ~ 56 *	56 ~ 46 *
500kHz~5MHz	56	46
5MHz~30MHz	60	50

Notes:

- (1) *Decreasing linearly with logarithm of the frequency.
- (2) The lower limit shall apply at the transition frequencies.
- (3) The limit decrease in line with the logarithm of the frequency in the range of 0.15 to 0.50MHz.

3.2 Test Setup

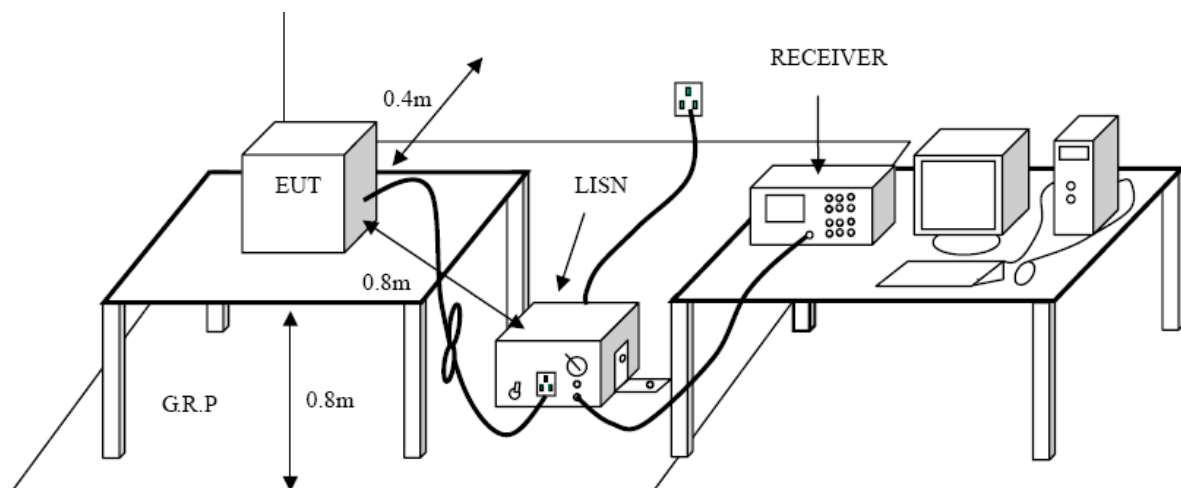

3.3 Test Procedure

The EUT was placed 0.8 meters from the horizontal ground plane with EUT being connected to the power mains through a line impedance stabilization network (LISN). All other support equipments powered from additional LISN(s). The LISN provide 50 Ohm/ 50uH of coupling impedance for the measuring instrument.

Interconnecting cables that hang closer than 40 cm to the ground plane shall be folded back and forth in the center forming a bundle 30 to 40 cm long.

I/O cables that are not connected to a peripheral shall be bundled in the center. The end of the cable may be terminated, if required, using the correct terminating impedance. The overall length shall not exceed 1 m.

LISN at least 80 cm from nearest part of EUT chassis.

The bandwidth of EMI test receiver is set at 9kHz, and the test frequency band is from 0.15MHz to 30MHz.

3.4 Test Equipment Used

Description	Manufacturer	Model No.	Serial No.	Cal. Date	Cal. Due Date
EMI Test Receiver	ROHDE& SCHWARZ	ESCI	100321	2013-08-10	2014-08-09
50ΩCoaxial Switch	Anritsu	MP59B	X10321	2013-08-10	2014-08-09
L.I.S.N	Rohde & Schwarz	ENV216	101131	2013-08-10	2014-08-09
L.I.S.N	SCHWARZBECK	NNBL 8226-2	8226-2/164	2013-08-10	2014-08-09

3.5 EUT Operating Mode

Please refer to the description of test mode.

3.6 Test Data

Please see the next page.

EUT:	Bluetooth Module	Model:	BT02B150
Temperature:	25 °C	Relative Humidity:	55%
Test Voltage:	AC 120V/60 Hz		
Terminal:	Line		
Test Mode:	AC Charging with BLE TX 2402 MHz		
Remark:	Only worse case is reported		

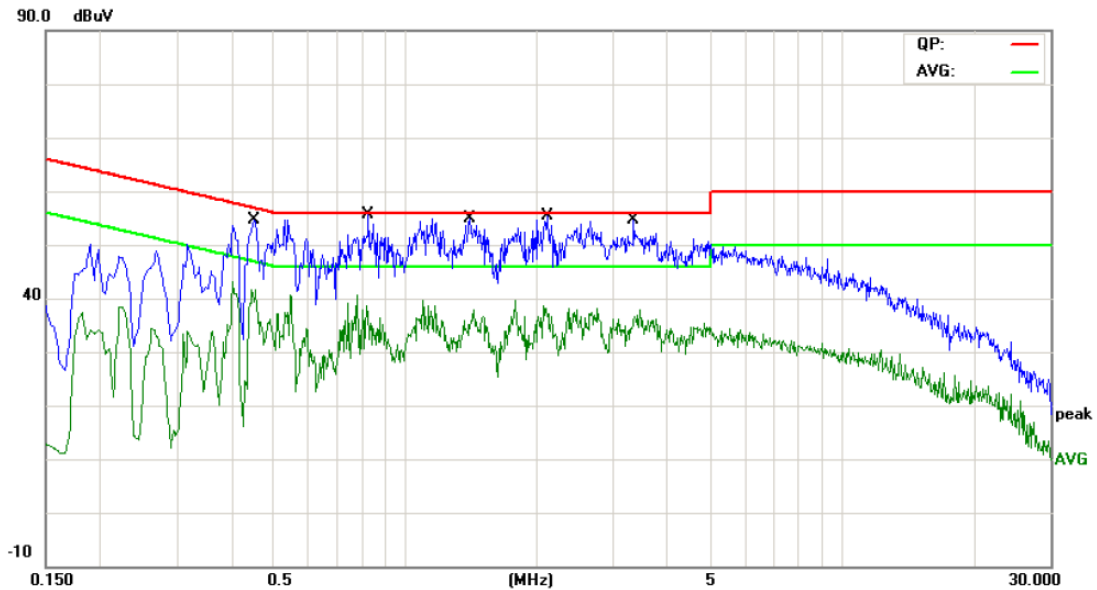

No.	Mk.	Freq.	Reading Level	Correct Factor	Measurement	Limit	Over	Detector	Comment
		MHz	dBuV	dB	dBuV	dBuV	dB		
1	*	0.4500	40.56	10.02	50.58	56.87	-6.29	QP	
2		0.4500	28.38	10.02	38.40	46.87	-8.47	AVG	
3		0.8260	37.97	10.09	48.06	56.00	-7.94	QP	
4		0.8260	22.87	10.09	32.96	46.00	-13.04	AVG	
5		1.4100	37.81	10.06	47.87	56.00	-8.13	QP	
6		1.4100	23.27	10.06	33.33	46.00	-12.67	AVG	
7		2.1140	37.36	10.06	47.42	56.00	-8.58	QP	
8		2.1140	23.78	10.06	33.84	46.00	-12.16	AVG	
9		3.3380	35.71	10.02	45.73	56.00	-10.27	QP	
10		3.3380	21.93	10.02	31.95	46.00	-14.05	AVG	

Emission Level= Read Level+ Correct Factor

EUT:	Bluetooth Module	Model:	BT02B150
Temperature:	25 °C	Relative Humidity:	55%
Test Voltage:	AC 120V/60 Hz		
Terminal:	Neutral		
Test Mode:	AC Charging with BLE TX 2402 MHz		
Remark:	Only worse case is reported		

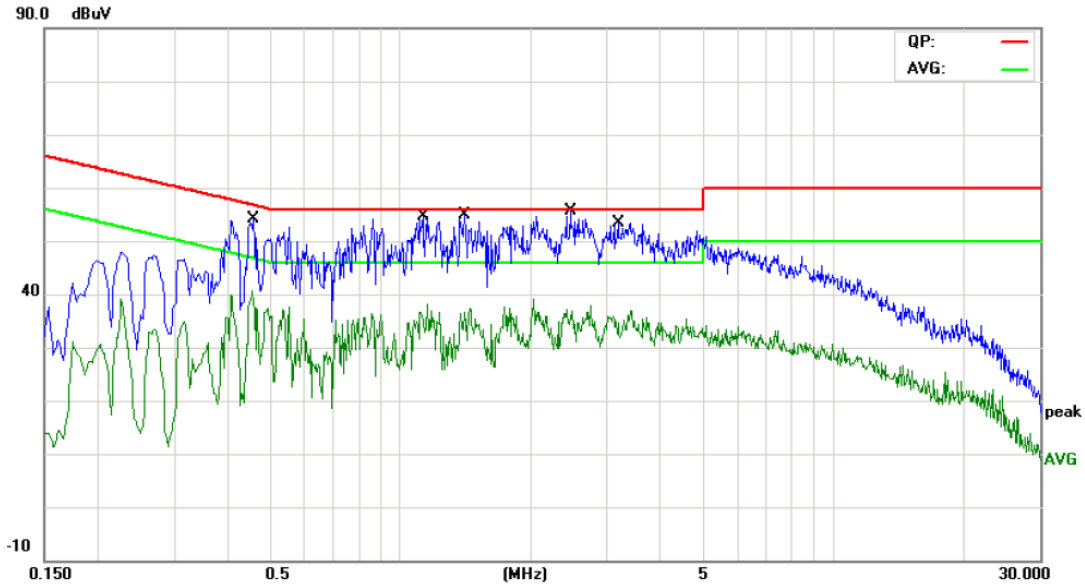

No.	Mk.	Freq. MHz	Reading Level dBuV	Correct Factor dB	Measure- ment dBuV	Limit dBuV	Over dB	Detector	Comment
1	*	0.4580	40.01	10.03	50.04	56.73	-6.69	QP	
2		0.4580	25.68	10.03	35.71	46.73	-11.02	AVG	
3		1.1260	37.81	10.15	47.96	56.00	-8.04	QP	
4		1.1260	21.43	10.15	31.58	46.00	-14.42	AVG	
5		1.4060	36.93	10.12	47.05	56.00	-8.95	QP	
6		1.4060	21.29	10.12	31.41	46.00	-14.59	AVG	
7		2.4620	36.80	10.06	46.86	56.00	-9.14	QP	
8		2.4620	21.90	10.06	31.96	46.00	-14.04	AVG	
9		3.1820	34.60	10.06	44.66	56.00	-11.34	QP	
10		3.1820	19.64	10.06	29.70	46.00	-16.30	AVG	

Emission Level= Read Level+ Correct Factor

4. Radiated Emission Test

4.1 Test Standard and Limit

4.1.1 Test Standard

FCC Part 15.209

4.1.2 Test Limit

Radiated Emission Limits (9kHz~1000MHz)

Frequency (MHz)	Field Strength (microvolt/meter)	Measurement Distance (meters)
0.009~0.490	2400/F(KHz)	300
0.490~1.705	24000/F(KHz)	30
1.705~30.0	30	30
30~88	100	3
88~216	150	3
216~960	200	3
Above 960	500	3

Radiated Emission Limit (Above 1000MHz)

Frequency (MHz)	Class A (dBuV/m)(at 3 M)		Class B (dBuV/m)(at 3 M)	
	Peak	Average	Peak	Average
Above 1000	80	60	74	54

Note:

- (1) The tighter limit applies at the band edges.
- (2) Emission Level(dBuV/m)=20log Emission Level(uV/m)

4.2 Test Setup

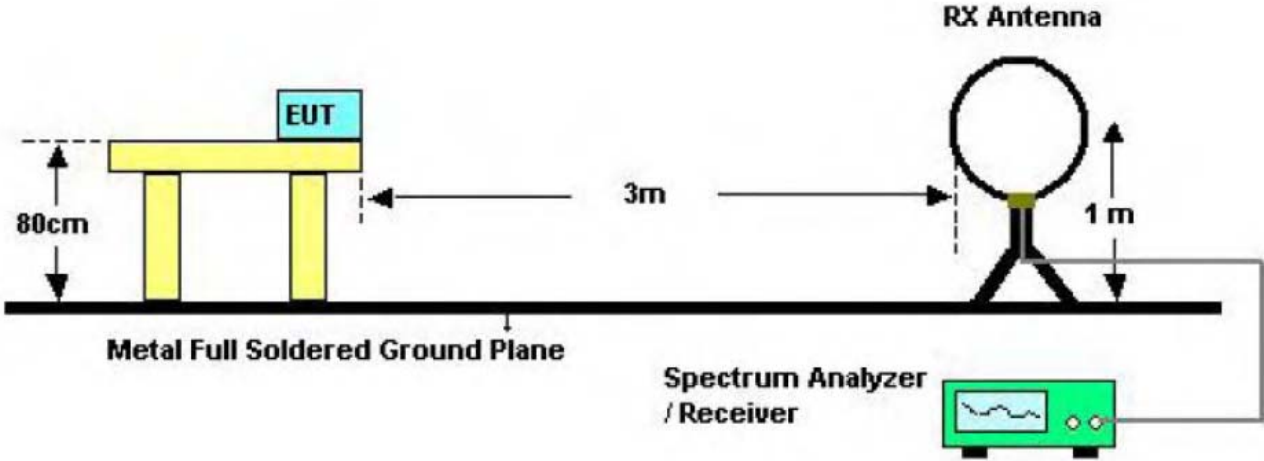

Below 30MHz Test Setup

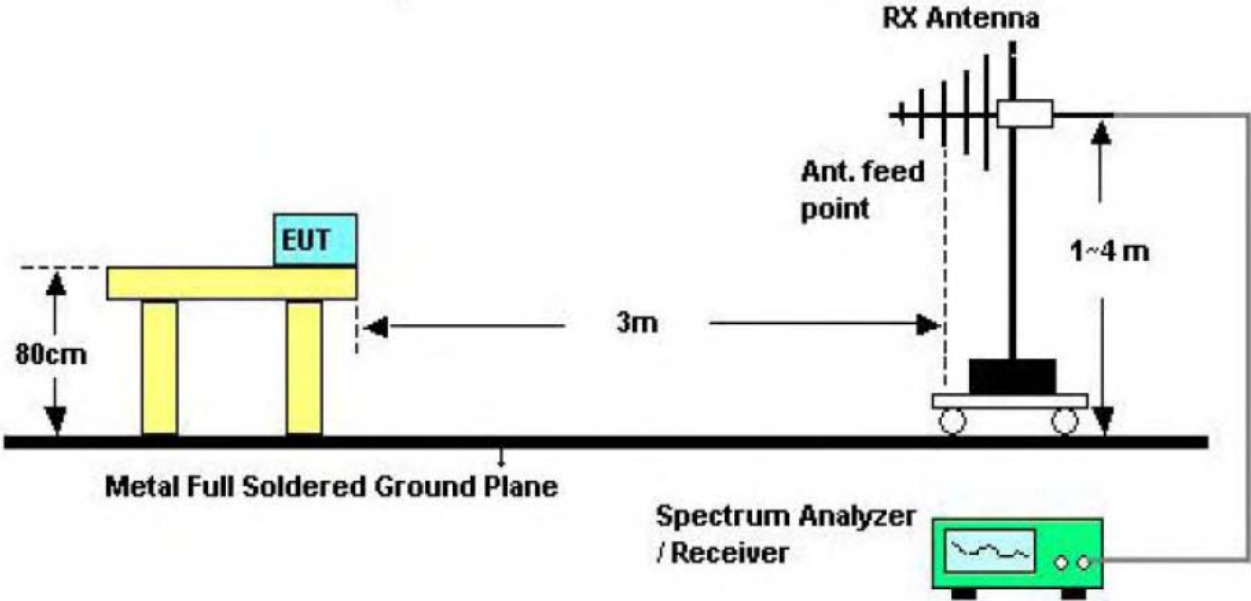

Below 1000MHz Test Setup

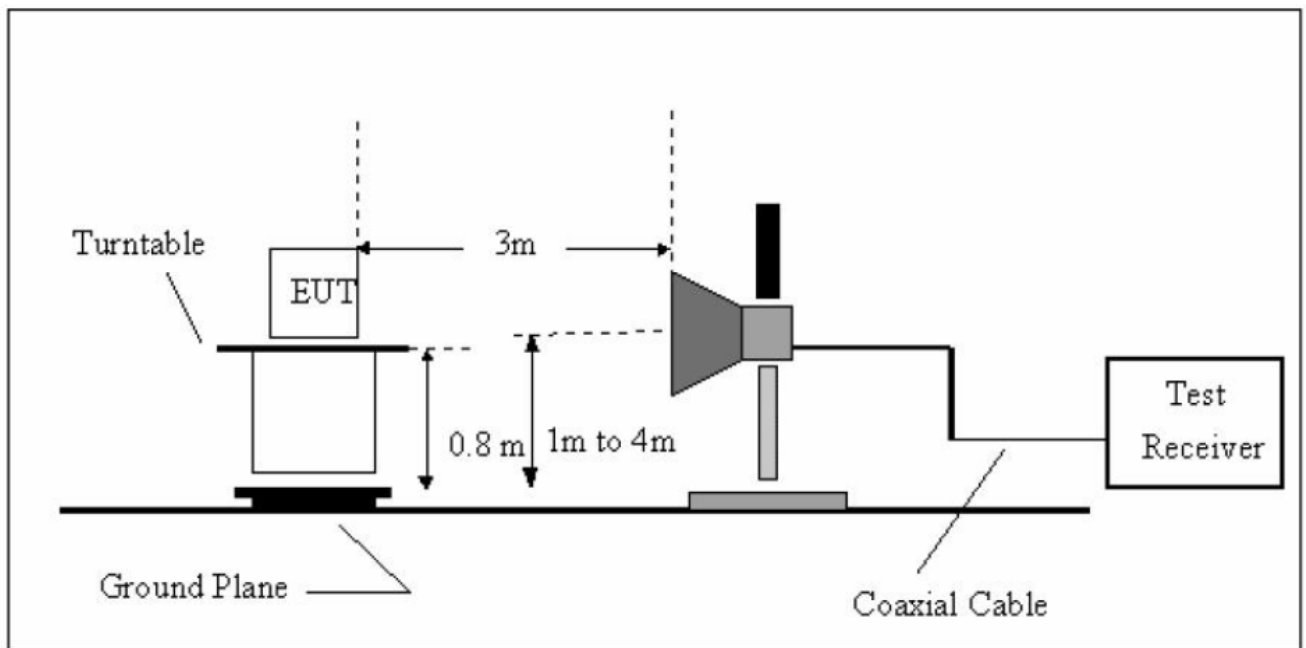

Above 1GHz Test Setup

4.3 Test Procedure

- (1) The measuring distance of 3m shall be used for measurements at frequency up to 1GHz and above 1 GHz. The EUT was placed on a rotating 0.8m high above the ground, the table was rotated 360 degrees to determine the position of the highest radiation.
- (2) The Test antenna shall vary between 1m and 4m, Both Horizontal and Vertical antenna are set to make measurement.
- (3) The initial step in collecting conducted emission data is a spectrum analyzer peak detector mode pre-scanning the measurement frequency range. Significant peaks are then marked and then Quasi Peak detector mode re-measured.
- (4) If the Peak Mode measured value compliance with and lower than Quasi Peak Mode Limit Bellow 1 GHz, the EUT shall be deemed to meet QP Limits and then no additional QP Mode measurement performed. But the Peak Value and average value both need to comply with applicable limit above 1 GHz.
- (5) Testing frequency range above 1GHz the measuring instrument use RBW=1 MHz and VBW=3 MHz with Peak Detector for Peak Values, and use RBW=1 MHz and VBW=10 Hz with Peak Detector for Average Values.
- (6) For the actual test configuration, please see the test setup photo.

4.4 EUT Operating Condition

The Equipment Under Test was set to Continual Transmitting in maximum power.

4.5 Test Equipment

Equipment	Manufacturer	Model No.	Serial No.	Last Cal.	Cal. Due
-----------	--------------	-----------	------------	-----------	----------

					Date
Spectrum Analyzer	Agilent	E4407B	MY45106456	Mar. 20, 2014	Mar. 19, 2015
Spectrum Analyzer	Rohde & Schwarz	FSP30	DE25181	Aug. 10, 2013	Aug.09, 2014
EMI Test Receiver	Rohde & Schwarz	ESCI	101165	Aug. 10, 2013	Aug.09, 2014
Bilog Antenna	ETS-LINDGREN	3142E	00117537	Mar. 07, 2014	Mar.06, 2015
Bilog Antenna	ETS-LINDGREN	3142E	00117542	Mar. 07, 2014	Mar.06, 2015
Horn Antenna	ETS-LINDGREN	3117	00143207	Mar. 07, 2014	Mar.06, 2015
Horn Antenna	ETS-LINDGREN	3117	00143209	Mar. 07, 2014	Mar.06, 2015
Pre-amplifier	HP	11909A	185903	Mar. 07, 2014	Mar.06, 2015
Pre-amplifier	HP	8447B	3008A00849	Mar. 07, 2014	Mar.06, 2015
Cable	HUBER+SUHNER	100	SUCOFLEX	Mar. 07, 2014	Mar.06, 2015
Signal Generator	Rohde & Schwarz	SML03	IKW682-054	Feb. 11, 2014	Feb.10, 2015
Positioning Controller	ETS-LINDGREN	2090	N/A	N/A	N/A

4.6 Test Data

Remark: During testing above 1GHz the measuring instrument use RBW=1 MHz and VBW=3 MHz with Peak Detector for Peak Values, and use RBW=1 MHz and VBW=10 Hz with Peak Detector for Average Values.

Test data please refer the following pages.

EUT:	Bluetooth Module	Model:	BT02B150
Temperature:	25 °C	Relative Humidity:	55%
Test Voltage:	AC 120V/60 Hz		
Ant. Pol.	Horizontal		
Test Mode:	BLE TX 2402 Mode		
Remark:	Only worse case is reported		

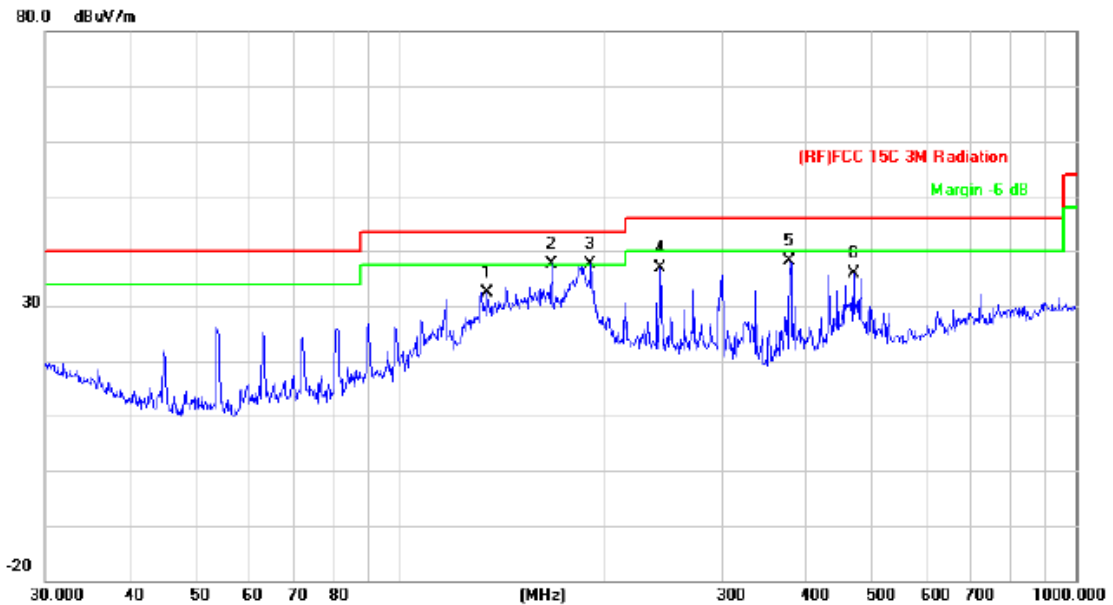

No.	Mk.	Freq.	Reading Level	Correct Factor	Measurement	Limit	Over	Detector
		MHz	dBuV	dB/m	dBuV/m	dBuV/m	dB	
1		134.5592	54.46	-22.09	32.37	43.50	-11.13	peak
2	!	167.8243	58.63	-21.04	37.59	43.50	-5.91	peak
3	*	191.7450	58.53	-20.81	37.72	43.50	-5.78	peak
4		243.3772	55.27	-18.43	36.84	46.00	-9.16	peak
5		377.2591	52.47	-14.31	38.16	46.00	-7.84	peak
6		468.8762	47.73	-11.81	35.92	46.00	-10.08	peak

Emission Level= Read Level+ Correct Factor

EUT:	Bluetooth Module	Model:	BT02B150
Temperature:	25 °C	Relative Humidity:	55%
Test Voltage:	AC 120V/60 Hz		
Ant. Pol.	Vertical		
Test Mode:	BLE TX 2402 Mode		
Remark:	Only worse case is reported		

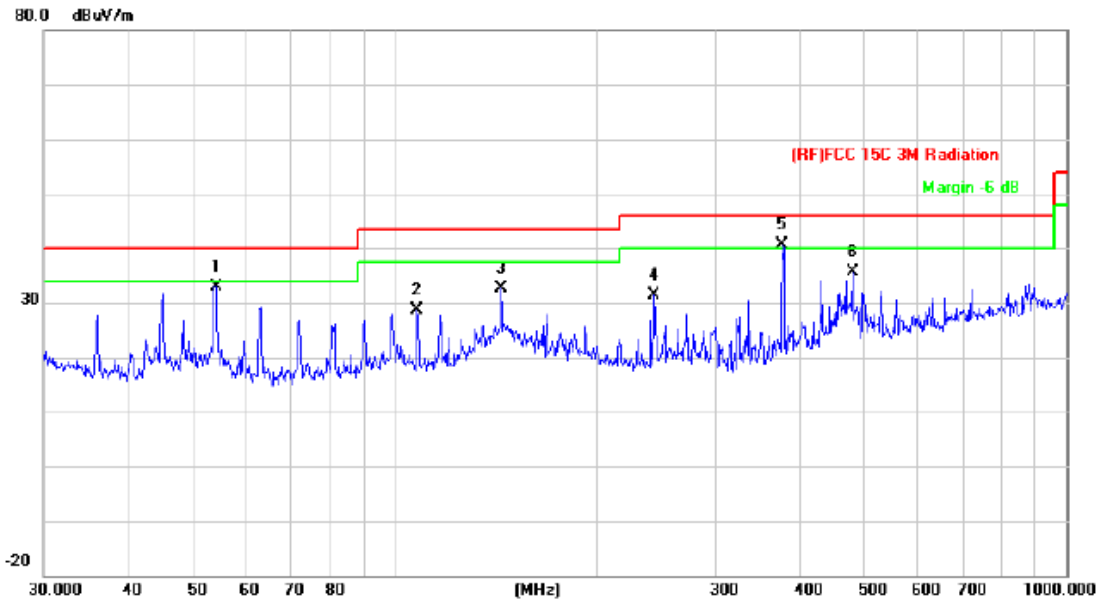

No.	Mk.	Freq.	Reading Level	Correct Factor	Measurement	Limit	Over	Detector
		MHz	dBuV	dB/m	dBuV/m	dBuV/m	dB	
1		54.0711	57.42	-24.45	32.97	40.00	-7.03	peak
2		107.5101	50.51	-21.86	28.65	43.50	-14.85	peak
3		143.8295	54.36	-21.67	32.69	43.50	-10.81	peak
4		243.3772	49.84	-18.43	31.41	46.00	-14.59	peak
5	*	377.2591	54.82	-14.31	40.51	46.00	-5.49	peak
6		480.5276	47.32	-11.62	35.70	46.00	-10.30	peak

Emission Level= Read Level+ Correct Factor

EUT:	Bluetooth Module	Model:	BT02B150
Temperature:	25 °C	Relative Humidity:	55%
Test Voltage:	AC 120V/60 Hz		
Ant. Pol.	Horizontal		
Test Mode:	BLE Mode TX 2402 MHz		
Remark:	No report for the emission which more than 10 dB below the prescribed limit.		

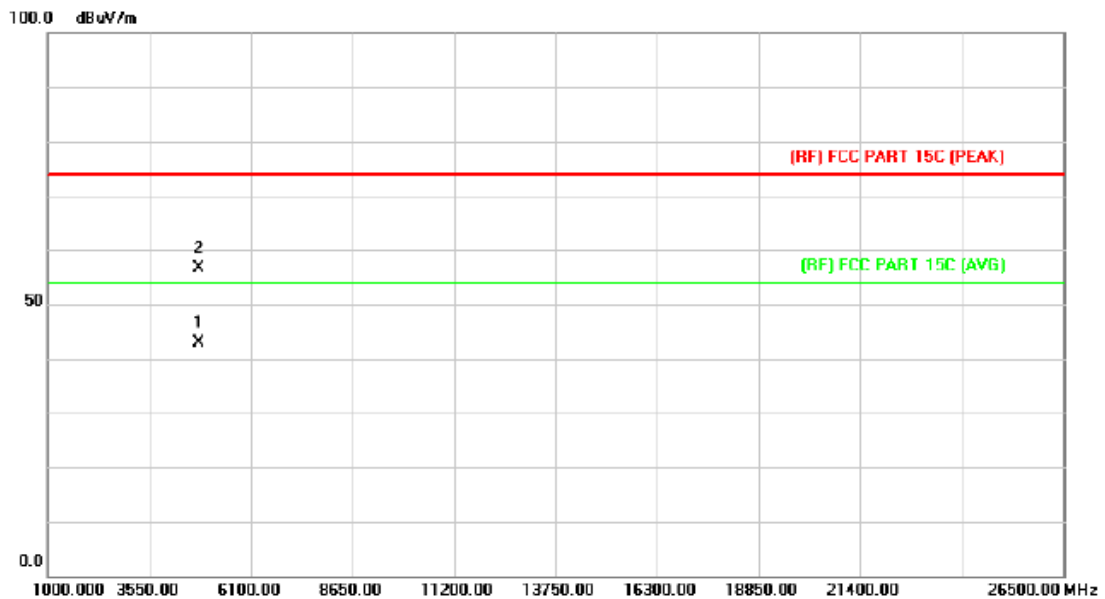

No.	Mk.	Freq.	Reading Level	Correct Factor	Measurement	Limit	Over	Detector
		MHz	dBuV	dB/m	dBuV/m	dBuV/m	dB	
1	*	4803.605	29.53	13.44	42.97	54.00	-11.03	AVG
2		4805.340	43.14	13.45	56.59	74.00	-17.41	peak

Emission Level= Read Level+ Correct Factor

EUT:	Bluetooth Module	Model:	BT02B150
Temperature:	25 °C	Relative Humidity:	55%
Test Voltage:	AC 120V/60 Hz		
Ant. Pol.	Vertical		
Test Mode:	BLE Mode TX 2402 MHz		
Remark:	No report for the emission which more than 10 dB below the prescribed limit.		

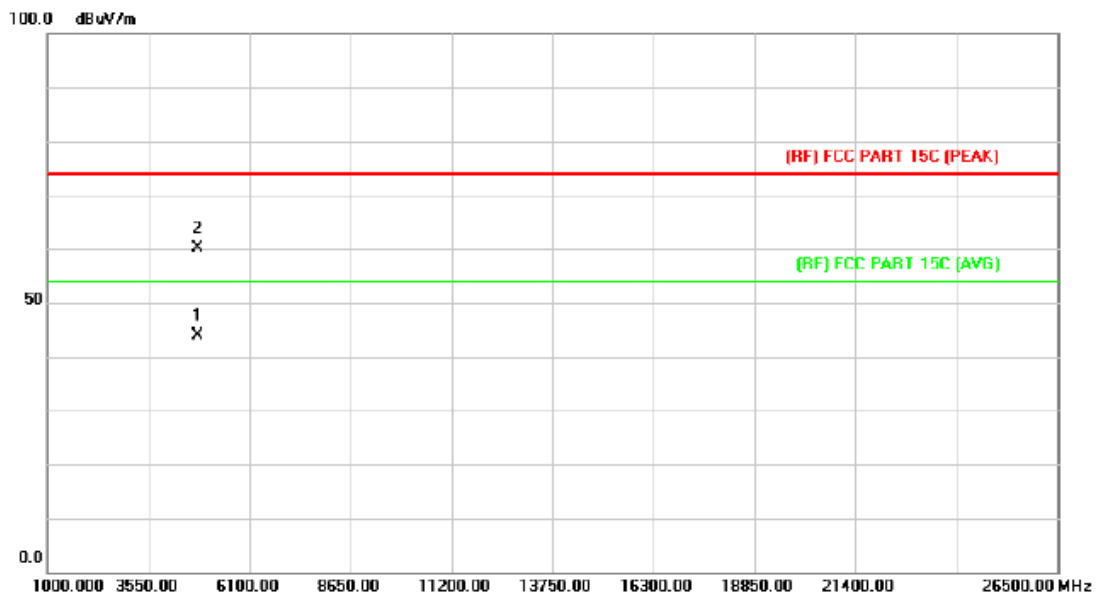

No.	Mk.	Freq.	Reading Level	Correct Factor	Measurement	Limit	Over	Detector
		MHz	dBuV	dB/m	dBuV/m	dBuV/m	dB	
1	*	4803.770	30.49	13.44	43.93	54.00	-10.07	AVG
2		4804.000	46.67	13.44	60.11	74.00	-13.89	peak

Emission Level= Read Level+ Correct Factor

EUT:	Bluetooth Module	Model:	BT02B150
Temperature:	25 °C	Relative Humidity:	55%
Test Voltage:	AC 120V/60 Hz		
Ant. Pol.	Horizontal		
Test Mode:	BLE Mode TX 2442 MHz		
Remark:	No report for the emission which more than 10 dB below the prescribed limit.		

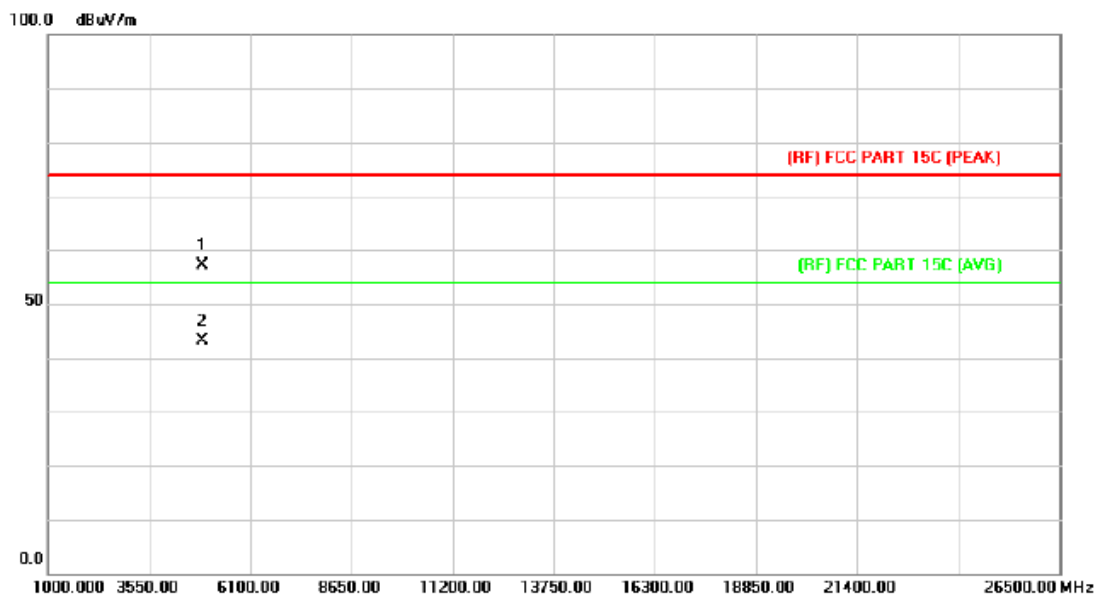

No.	Mk.	Freq. MHz	Reading Level dBuV	Correct Factor dB/m	Measure- ment dBuV/m	Limit dBuV/m	Over dB	Detector
1		4882.160	43.29	13.90	57.19	74.00	-16.81	peak
2	*	4884.140	29.15	13.92	43.07	54.00	-10.93	AVG

Emission Level= Read Level+ Correct Factor

EUT:	Bluetooth Module	Model:	BT02B150
Temperature:	25 °C	Relative Humidity:	55%
Test Voltage:	AC 120V/60 HZ		
Ant. Pol.	Vertical		
Test Mode:	BLE Mode TX 2442 MHz		
Remark:	No report for the emission which more than 10 dB below the prescribed limit.		

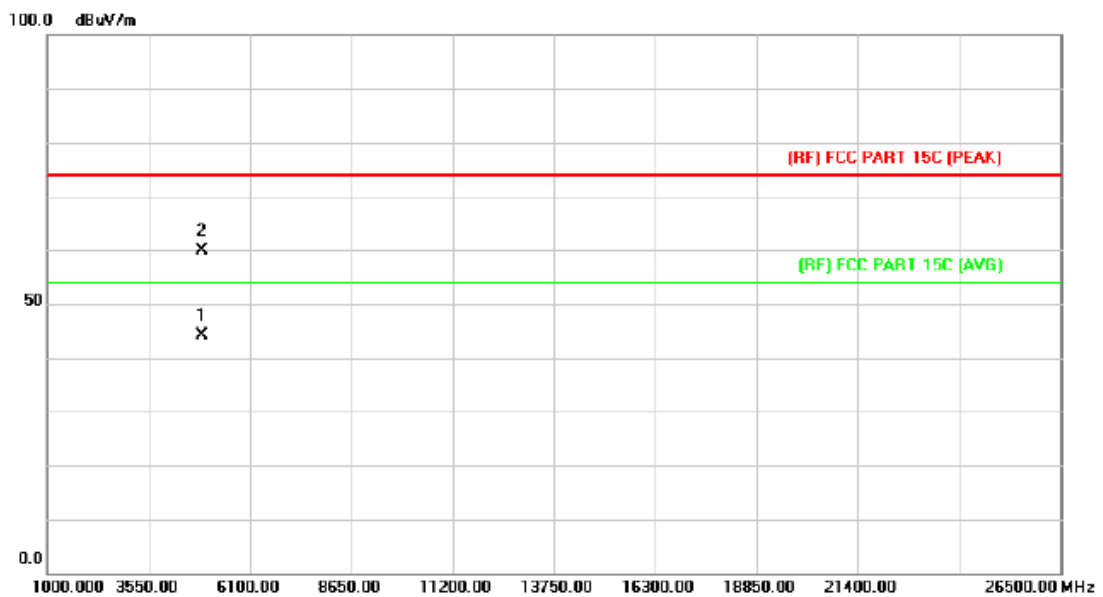

No.	Mk.	Freq.	Reading Level	Correct Factor	Measurement	Limit	Over	Detector
		MHz	dBuV	dB/m	dBuV/m	dBuV/m	dB	
1	*	4883.830	30.25	13.92	44.17	54.00	-9.83	AVG
2		4884.620	45.95	13.92	59.87	74.00	-14.13	peak

Emission Level= Read Level+ Correct Factor

EUT:	Bluetooth Module	Model:	BT02B150
Temperature:	25 °C	Relative Humidity:	55%
Test Voltage:	AC 120V/60 HZ		
Ant. Pol.	Horizontal		
Test Mode:	BLE Mode TX 2480 MHz		
Remark:	No report for the emission which more than 10 dB below the prescribed limit.		

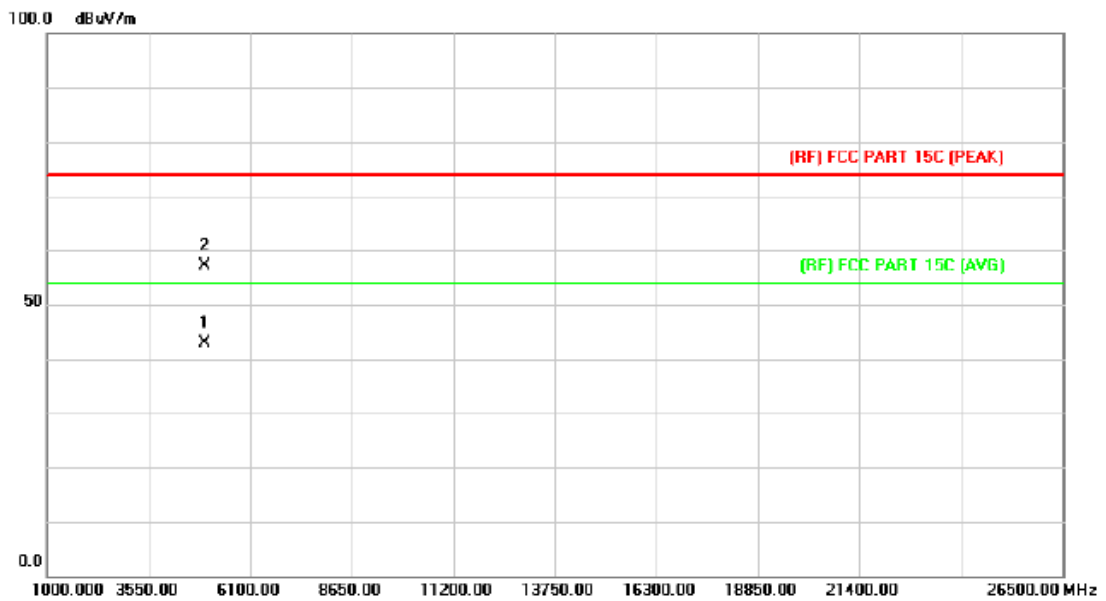

No.	Mk.	Freq.	Reading Level	Correct Factor	Measurement	Limit	Over	Detector
		MHz	dBuV	dB/m	dBuV/m	dBuV/m	dB	
1	*	4960.050	28.53	14.36	42.89	54.00	-11.11	AVG
2		4960.670	42.78	14.36	57.14	74.00	-16.86	peak

Emission Level= Read Level+ Correct Factor

EUT:	Bluetooth Module	Model:	BT02B150
Temperature:	25 °C	Relative Humidity:	55%
Test Voltage:	AC 120V/60 HZ		
Ant. Pol.	Vertical		
Test Mode:	BLE Mode TX 2480 MHz		
Remark:	No report for the emission which more than 10 dB below the prescribed limit.		

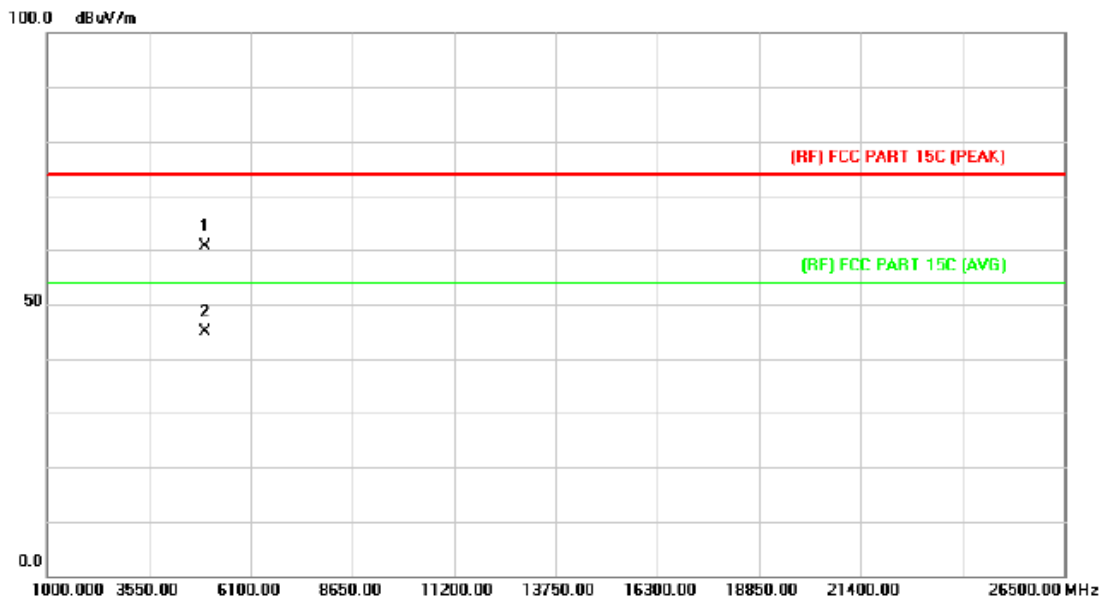

No.	Mk.	Freq.	Reading Level	Correct Factor	Measurement	Limit	Over	Detector
		MHz	dBuV	dB/m	dBuV/m	dBuV/m	dB	
1		4959.200	46.31	14.36	60.67	74.00	-13.33	peak
2	*	4959.880	30.48	14.36	44.84	54.00	-9.16	AVG

Emission Level= Read Level+ Correct Factor

5. Restricted Bands Requirement

5.1 Test Standard and Limit

5.1.1 Test Standard

FCC Part 15.209 FCC Part 15.205

5.1.2 Test Limit

Restricted Frequency Band (MHz)	Class B (dBuV/m)(at 3 M)	
	Peak	Average
2310 ~2390	74	54
2483.5 ~2500	74	54

5.2 Test Setup

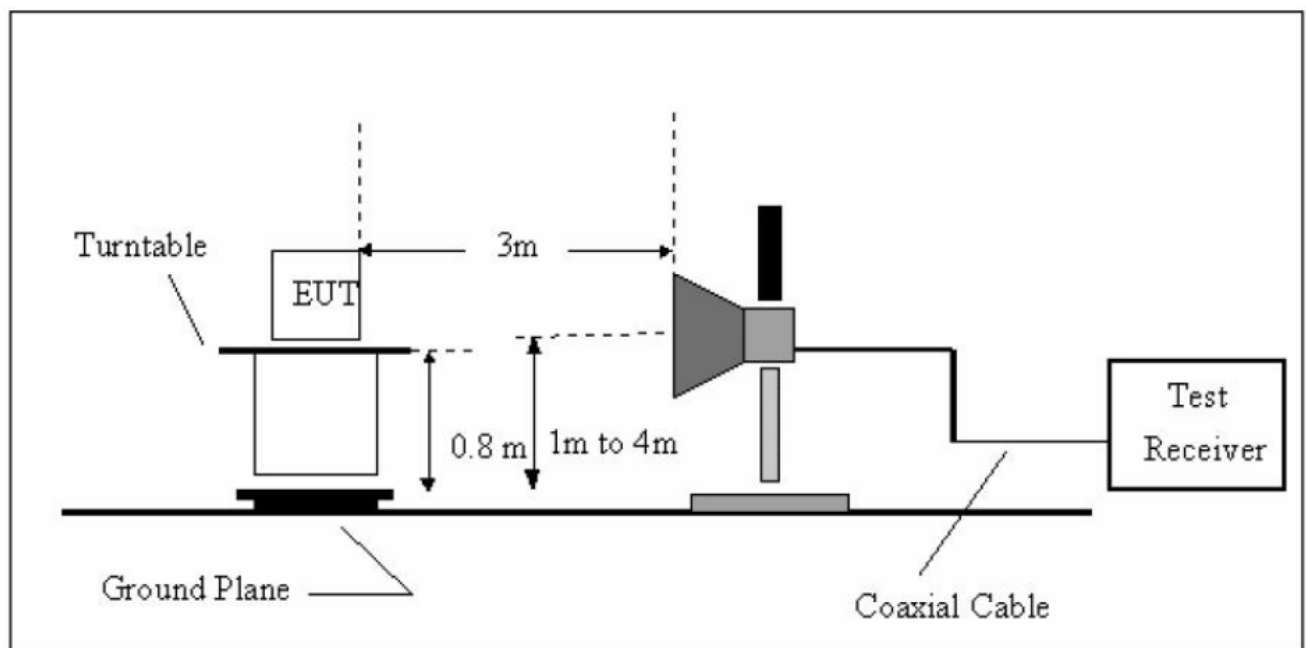

5.3 Test Procedure

- (1) The measuring distance of 3m shall be used for measurements at frequency up to 1GHz and above 1 GHz. The EUT was placed on a rotating 0.8m high above ground, the table was rotated 360 degrees to determine the position of the highest radiation.
- (2) The Test antenna shall vary between 1m and 4m, Both Horizontal and Vertical antenna are set to make measurement.
- (3) The initial step in collecting conducted emission data is a spectrum analyzer peak detector mode pre-scanning the measurement frequency range. Significant peaks are then marked and then Quasi Peak detector mode re-measured.
- (4) If the Peak Mode measured value compliance with and lower than Quasi Peak Mode Limit

Bellow 1 GHz, the EUT shall be deemed to meet QP Limits and then no additional QP Mode measurement performed. But the Peak Value and average value both need to comply with applicable limit above 1 GHz.

- (5) Testing frequency range above 1GHz the measuring instrument use RBW=1 MHz and VBW=3 MHz with Peak Detector for Peak Values, and use RBW=1 MHz and VBW=10 Hz with Peak Detector for Average Values.
- (6) For the actual test configuration, please see the test setup photo.

5.4 EUT Operating Condition

The Equipment Under Test was set to Continual Transmitting in maximum power.

5.5 Test Equipment

Equipment	Manufacturer	Model No.	Serial No.	Last Cal.	Cal. Due Date
Spectrum Analyzer	Agilent	E4407B	MY45106456	Mar. 20, 2014	Mar. 19, 2015
Spectrum Analyzer	Rohde & Schwarz	FSP30	DE25181	Aug. 10, 2013	Aug.09, 2014
EMI Test Receiver	Rohde & Schwarz	ESCI	101165	Aug. 10, 2013	Aug.09, 2014
Bilog Antenna	ETS-LINDGREN	3142E	00117537	Mar. 07, 2014	Mar.06, 2015
Bilog Antenna	ETS-LINDGREN	3142E	00117542	Mar. 07, 2014	Mar.06, 2015
Horn Antenna	ETS-LINDGREN	3117	00143207	Mar. 07, 2014	Mar.06, 2015
Horn Antenna	ETS-LINDGREN	3117	00143209	Mar. 07, 2014	Mar.06, 2015
Pre-amplifier	HP	11909A	185903	Mar. 07, 2014	Mar.06, 2015
Pre-amplifier	HP	8447B	3008A00849	Mar. 07, 2014	Mar.06, 2015
Cable	HUBER+SUHNER	100	SUCOFLEX	Mar. 07, 2014	Mar.06, 2015
Signal Generator	Rohde & Schwarz	SML03	IKW682-054	Feb. 11, 2014	Feb.10, 2015
Positioning Controller	ETS-LINDGREN	2090	N/A	N/A	N/A

5.6 Test Data

Please see the next page.

(1) Radiation Test

EUT:	Bluetooth Module	Model:	BT02B150
Temperature:	25 °C	Relative Humidity:	55%
Test Voltage:	AC 120V/60 HZ		
Ant. Pol.	Horizontal		
Test Mode:	BLE Mode TX 2402 MHz		
Remark:	N/A		

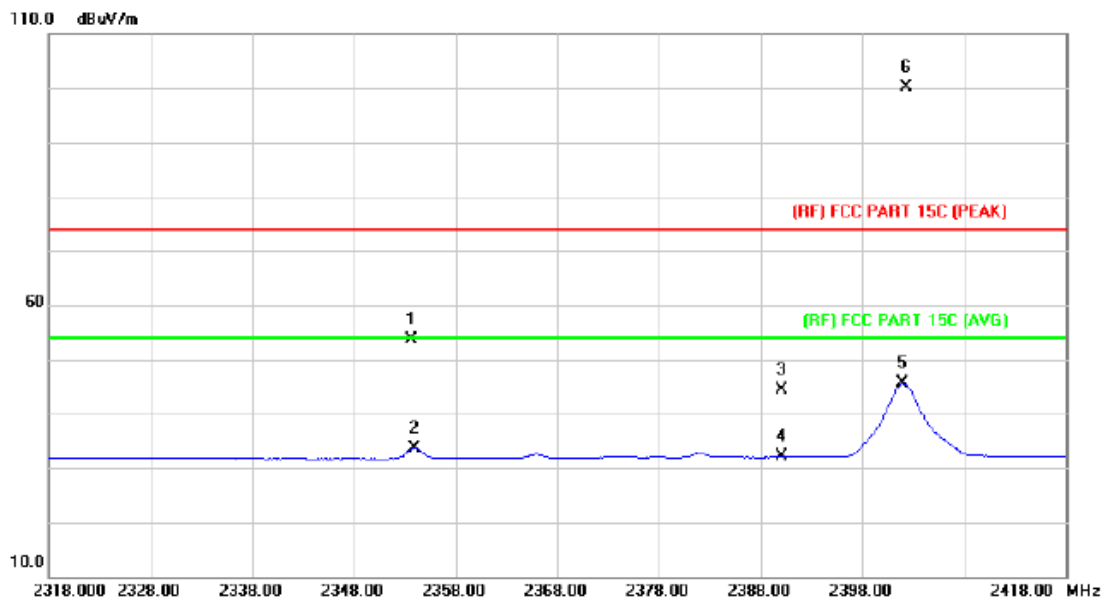

No.	Mk.	Freq. MHz	Reading Level dBuV	Correct Factor dB/m	Measure- ment dBuV/m	Limit dBuV/m	Over dB	Detector
1		2353.700	53.05	0.62	53.67	74.00	-20.33	peak
2		2353.900	33.05	0.62	33.67	54.00	-20.33	AVG
3		2390.000	43.59	0.77	44.36	74.00	-29.64	peak
4		2390.000	31.37	0.77	32.14	54.00	-21.86	AVG
5		2401.900	44.69	0.82	45.51	54.00	-8.49	AVG
6	*	2402.300	99.38	0.82	100.20	74.00	26.20	peak

Emission Level= Read Level+ Correct Factor

EUT:	Bluetooth Module	Model:	BT02B150
Temperature:	25 °C	Relative Humidity:	55%
Test Voltage:	AC 120V/60 HZ		
Ant. Pol.	Vertical		
Test Mode:	BLE Mode TX 2402 MHz		
Remark:	N/A		

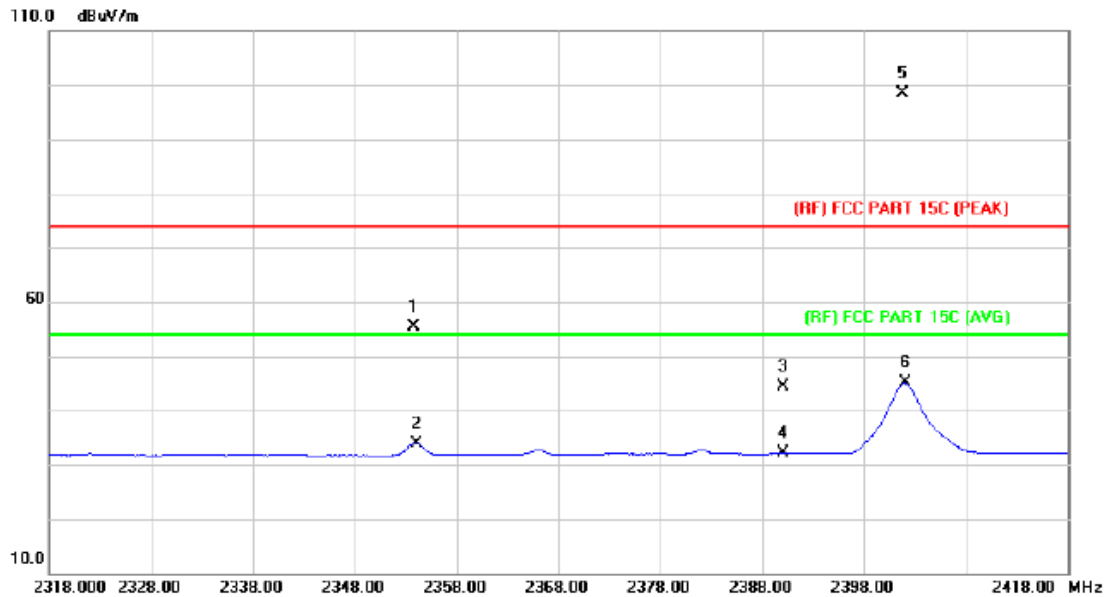

No.	Mk.	Freq. MHz	Reading Level dBuV	Correct Factor dB/m	Measure- ment dBuV/m	Limit dBuV/m	Over dB	Detector
1		2353.800	54.75	0.62	55.37	74.00	-18.63	peak
2		2354.000	33.36	0.62	33.98	54.00	-20.02	AVG
3		2390.000	43.71	0.77	44.48	74.00	-29.52	peak
4		2390.000	31.36	0.77	32.13	54.00	-21.87	AVG
5	*	2401.800	97.44	0.82	98.26	74.00	24.26	peak
6		2402.000	44.21	0.82	45.03	54.00	-8.97	AVG

Emission Level= Read Level+ Correct Factor

EUT:	Bluetooth Module	Model:	BT02B150
Temperature:	25 °C	Relative Humidity:	55%
Test Voltage:	AC 120V/60 HZ		
Ant. Pol.	Horizontal		
Test Mode:	BLE Mode TX 2480 MHz		
Remark:	N/A		

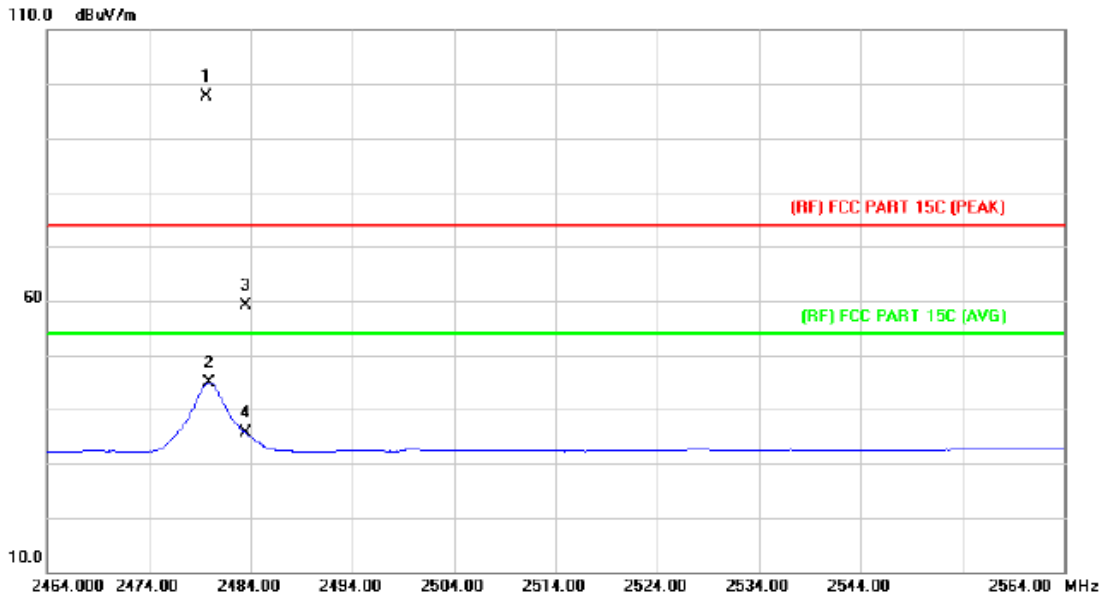

No.	Mk.	Freq. MHz	Reading Level dBuV	Correct Factor dB/m	Measure- ment dBuV/m	Limit dBuV/m	Over dB	Detector
1	*	2479.700	96.58	1.15	97.73	74.00	23.73	peak
2		2479.900	43.78	1.15	44.93	54.00	-9.07	AVG
3		2483.500	58.04	1.17	59.21	74.00	-14.79	peak
4		2483.500	34.45	1.17	35.62	54.00	-18.38	AVG

Emission Level= Read Level+ Correct Factor

EUT:	Bluetooth Module	Model:	BT02B150
Temperature:	25 °C	Relative Humidity:	55%
Test Voltage:	AC 120V/60 HZ		
Ant. Pol.	Vertical		
Test Mode:	BLE Mode TX 2480 MHz		
Remark:	N/A		

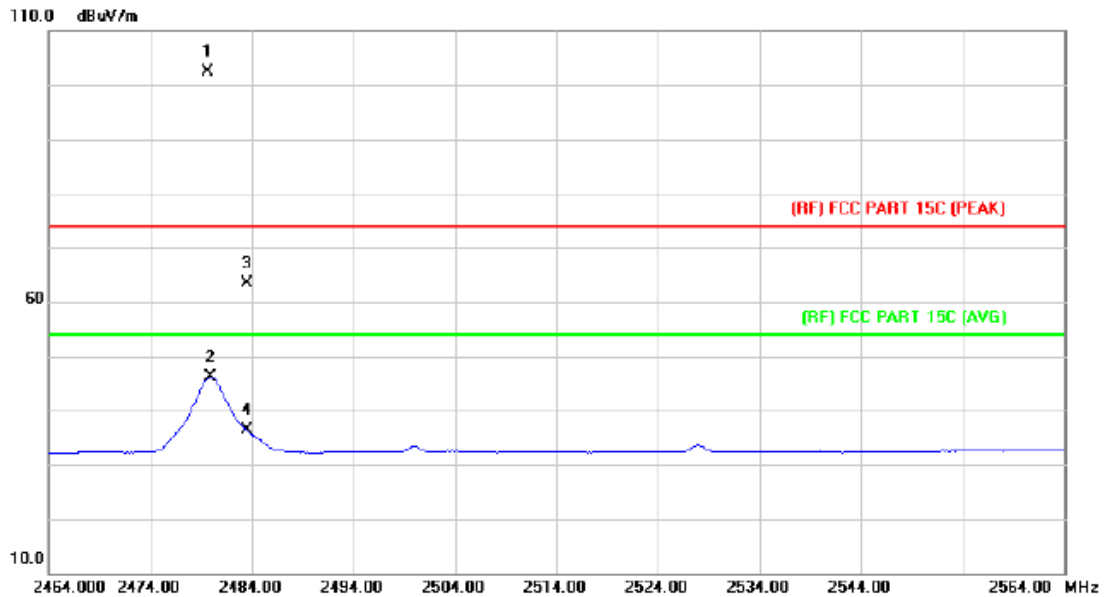

No.	Mk.	Freq.	Reading Level	Correct Factor	Measurement	Limit	Over	Detector
		MHz	dBuV	dB/m	dBuV/m	dBuV/m	dB	
1	*	2479.700	101.15	1.15	102.30	74.00	28.30	peak
2		2479.900	44.93	1.15	46.08	54.00	-7.92	AVG
3		2483.500	62.27	1.17	63.44	74.00	-10.56	peak
4		2483.500	35.15	1.17	36.32	54.00	-17.68	AVG

Emission Level= Read Level+ Correct Factor

(2) Conducted Test

EUT:	Bluetooth Module	Model:	BT02B150
Temperature:	25 °C	Relative Humidity:	55%
Test Voltage:	AC 120V/60 Hz		
Test Mode:	BLE Mode TX 2402MHz / BLE Mode TX 2480MHz		
Remark:	The EUT is programed in continuously transmitting mode		

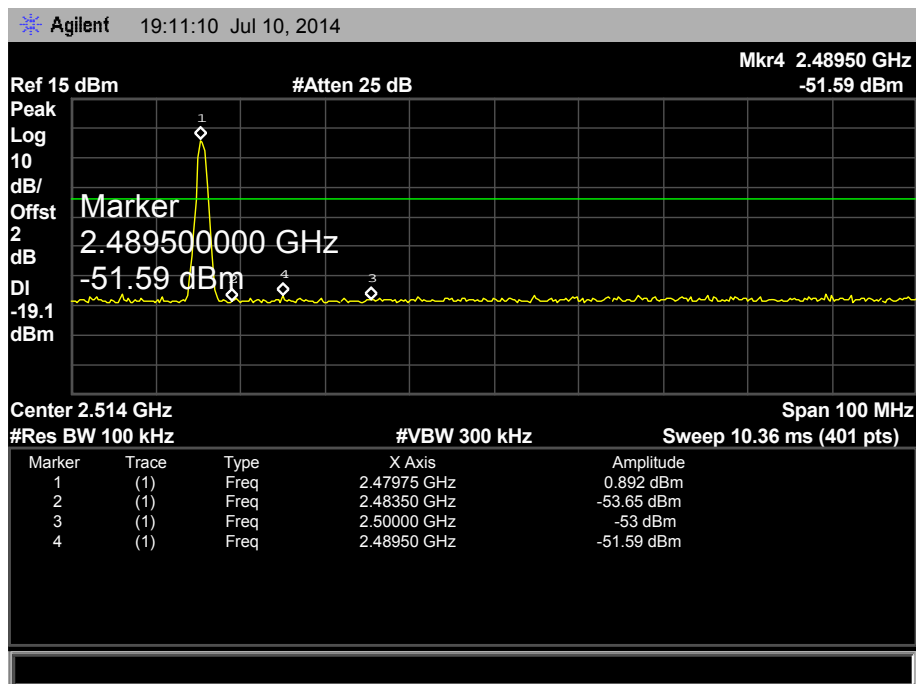
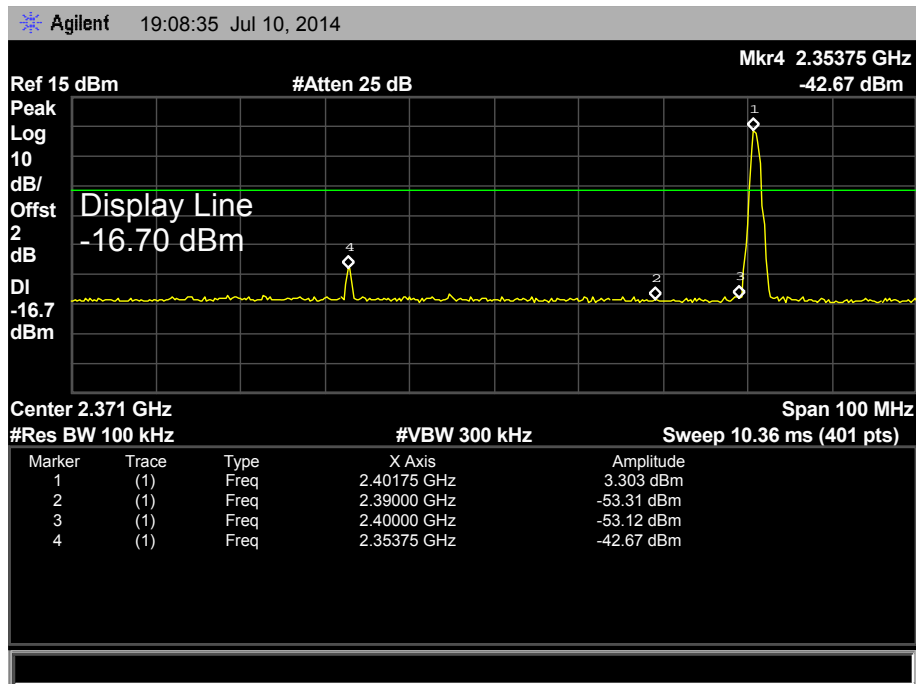

6. Bandwidth Test

6.1 Test Standard and Limit

- 6.1.1 Test Standard
FCC Part 15.247 (a)(2)
- 6.1.2 Test Limit

FCC Part 15 Subpart C(15.247)/RSS-210		
Test Item	Limit	Frequency Range(MHz)
Bandwidth	≥ 500 KHz (6dB bandwidth)	2400~2483.5

6.2 Test Setup

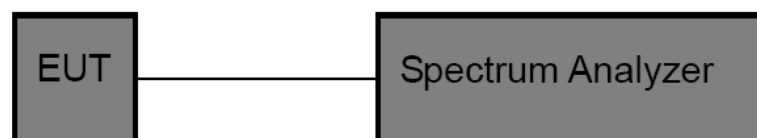

6.3 Test Procedure

- (1) The EUT was directly connected to the spectrum analyzer and antenna output port as show in the block diagram above.
- (2) The bandwidth is measured at an amplitude level reduced 6dB from the reference level. The reference level is the level of the highest amplitude signal observed from the transmitter at the fundamental frequency. Once the reference level is established, the equipment is conditioned with typical modulating signal to produce the worst –case (i.e the widest) bandwidth.
- (3) Measure the channel separation the spectrum analyzer was set to Resolution Bandwidth:100 kHz, and Video Bandwidth:300 kHz, Detector: Peak, Sweep Time set auto.

6.4 EUT Operating Condition

The EUT was set to continuously transmitting in each mode and low, middle and high channel for the test.

6.5 Test Equipment

Equipment	Manufacturer	Model No.	Serial No.	Last Cal.	Cal. Due Date
Spectrum Analyzer	Rohde & Schwarz	FSP30	DE25181	Aug. 10, 2013	Aug.09, 2014

6.6 Test Data

EUT:	Bluetooth Module	Model:	BT02B150
Temperature:	25 °C	Relative Humidity:	55%
Test Voltage:	AC 120V/60 Hz		
Test Mode:	BLE TX Mode		
Channel frequency (MHz)	6dB Bandwidth (kHz)	99% Bandwidth (kHz)	Limit (kHz)
2402	550.244	1095.6	≥500
2442	542.587	1093.3	
2480	545.047	1097.1	
BLE Mode			
2402 MHz			
<p>Agilent 18:56:52 Jul 10, 2014</p> <p>Ref 15 dBm #Atten 25 dB</p> <p>#Peak Log 10 dB/Offst 2 dB</p> <p>Span 5.000000000 MHz</p> <p>Center 2.402 GHz #Res BW 100 kHz #VBW 300 kHz Span 5 MHz Sweep 5 ms (401 pts)</p> <p>Occupied Bandwidth 1.0956 MHz Occ BW % Pwr 99.00 % x dB -6.00 dB</p> <p>Transmit Freq Error -14.841 kHz x dB Bandwidth 550.244 kHz</p>			

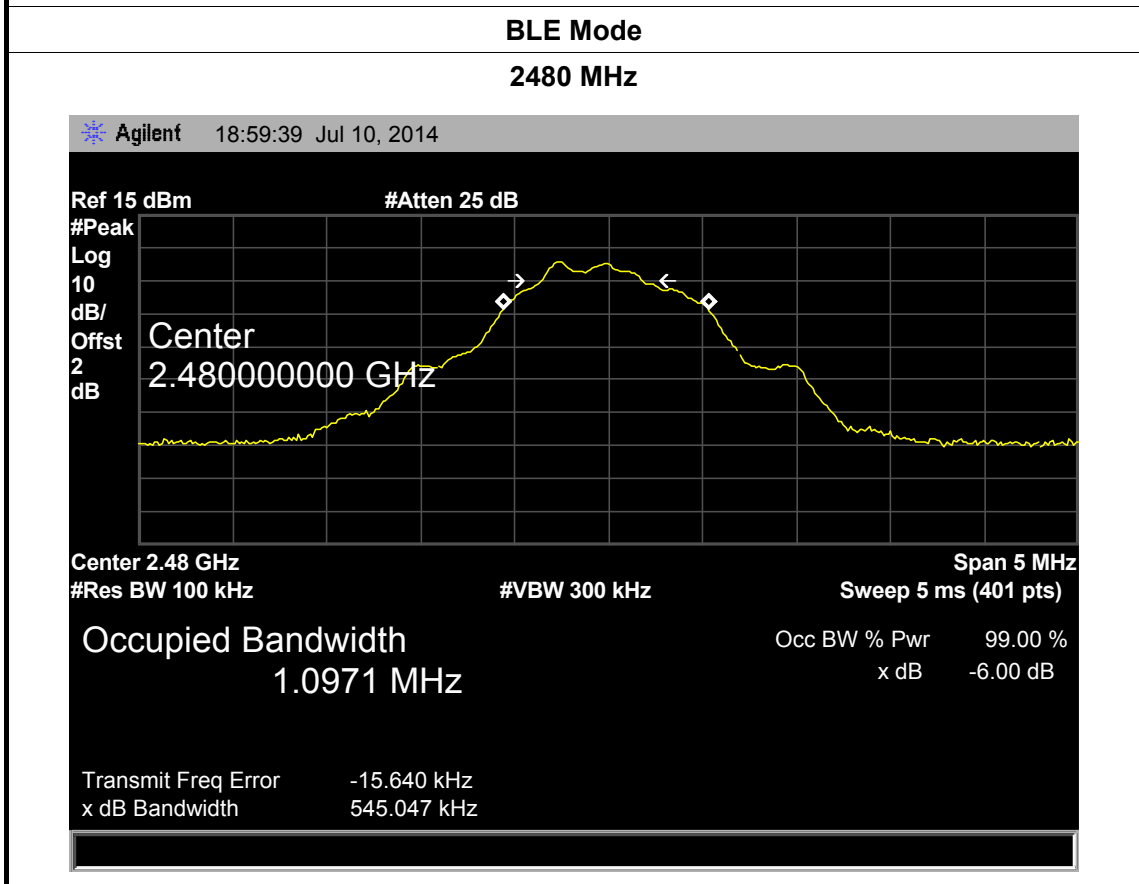
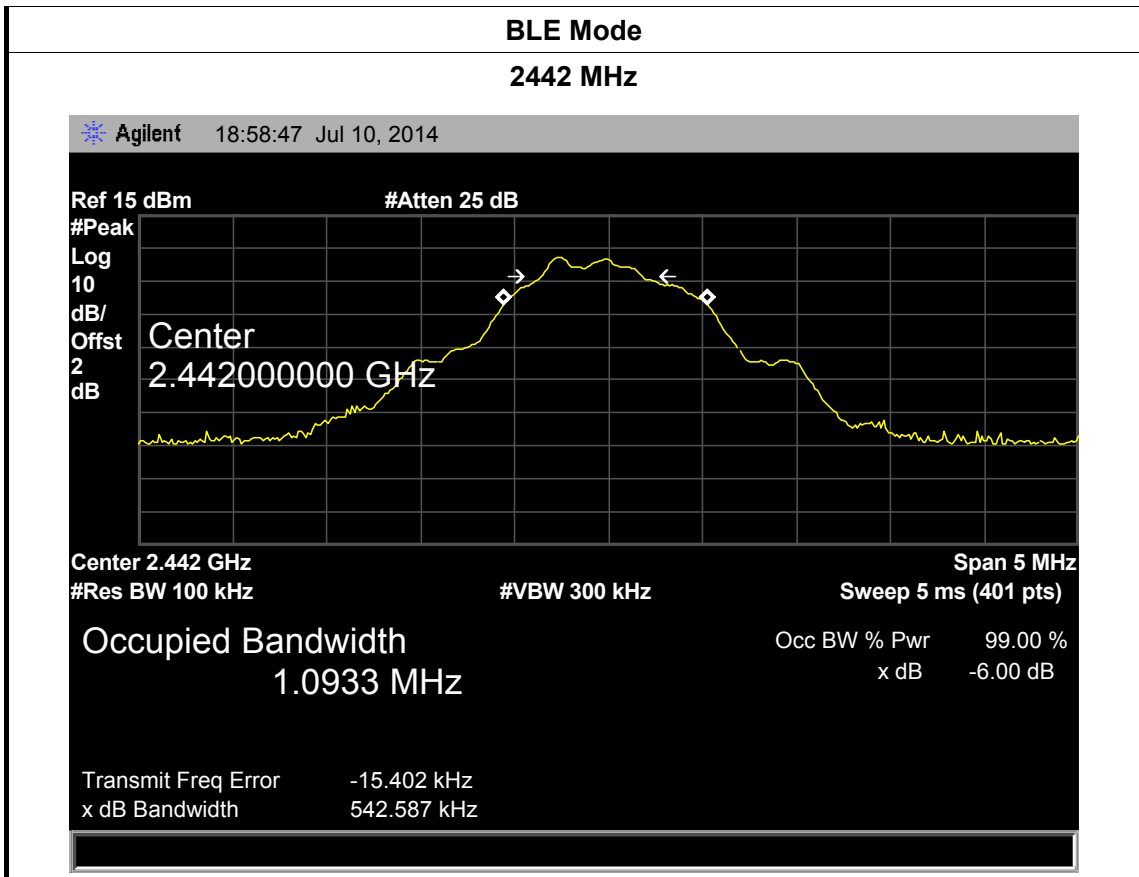

7. Peak Output Power Test

7.1 Test Standard and Limit

7.1.1 Test Standard

FCC Part 15.247 (b)

7.1.2 Test Limit

FCC Part 15 Subpart C(15.247)/RSS-210		
Test Item	Limit	Frequency Range(MHz)
Peak Output Power	1 Watt or 30 dBm	2400~2483.5

7.2 Test Setup

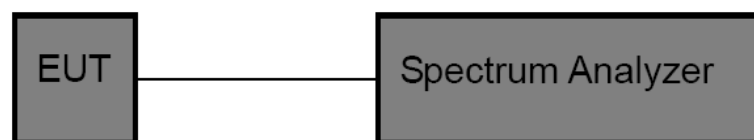

7.3 Test Procedure

The EUT was directly connected to the Spectrum Analyzer and antenna output port as show in the block diagram above. The measurement is according to section 9.1.1 of KDB 558074 D01 DTS Meas Guidance v03r02.

- (1) Set the RBW \geq DTS Bandwidth
- (2) Set VBW \geq 3*RBW
- (3) Set Span \geq 3*RBW
- (4) Sweep time=auto
- (5) Detector= peak
- (6) Trace mode= maxhold.
- (7) Allow trace to fully stabilize, and then use peak marker function to determine the peak amplitude level.

7.4 EUT Operating Condition

The EUT was set to continuously transmitting in the max power during the test.

7.5 Test Equipment

Equipment	Manufacturer	Model No.	Serial No.	Last Cal.	Cal. Due Date
Spectrum	Rohde & Schwarz	FSP30	DE25181	Aug. 10, 2013	Aug.09, 2014

Analyzer					
----------	--	--	--	--	--

7.6 Test Data

EUT:	Bluetooth Module	Model:	BT02B150
Temperature:	25 °C	Relative Humidity:	55%
Test Voltage:	AC 120V/60 HZ		
Test Mode:	BLE TX Mode		
Channel frequency (MHz)	Test Result (dBm)	Limit (dBm)	
2402	3.305	30	
2442	2.550		
2480	1.143		
BLE Mode			
2402 MHz			
<p>Agilent 18:26:12 Jul 10, 2014</p> <p>Ref 15 dBm #Atten 25 dB Mkr1 2.4022025 GHz 3.305 dBm</p> <p>Peak Log 10 dB/Offst 2 dB</p> <p>Marker 2.402202500 GHz 3.305 dBm</p> <p>M1 S2 S3 FC AA</p> <p>Center 2.402 GHz Span 3 MHz #Res BW 1 MHz #VBW 3 MHz Sweep 5 ms (401 pts)</p>			

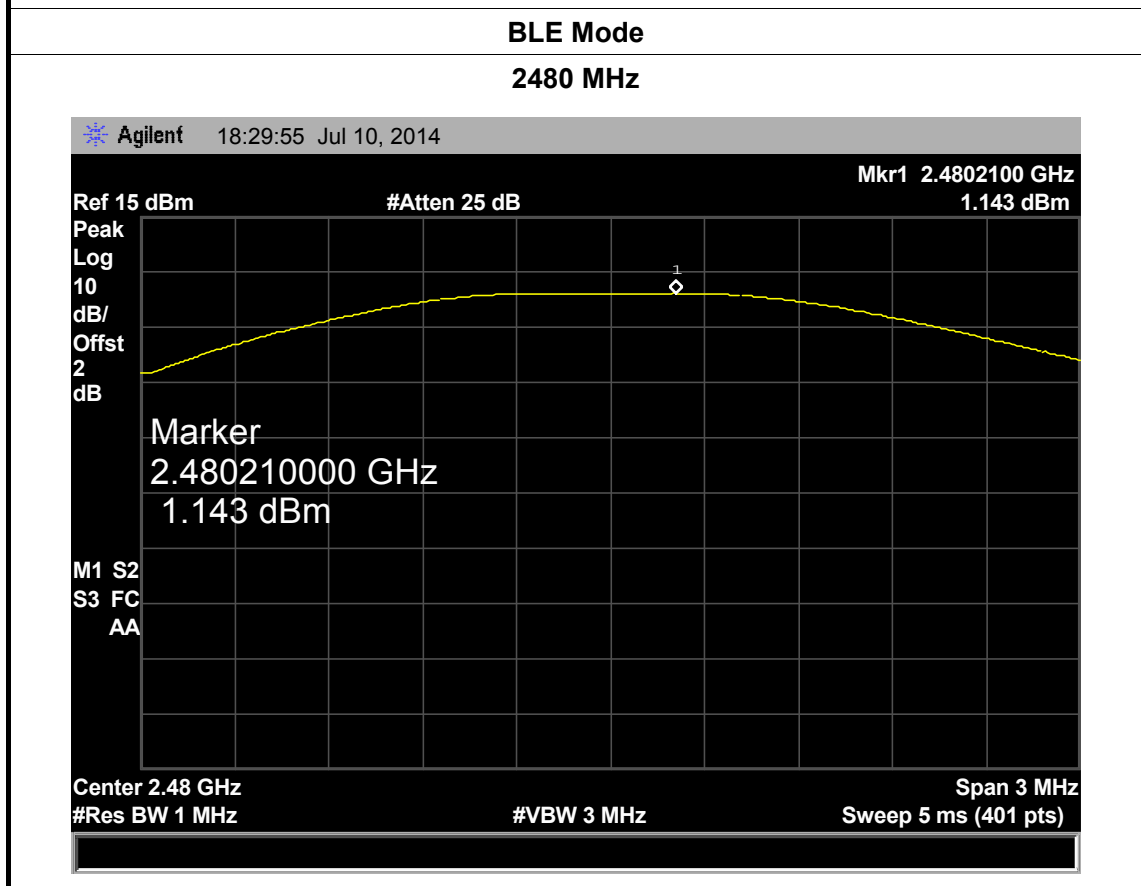
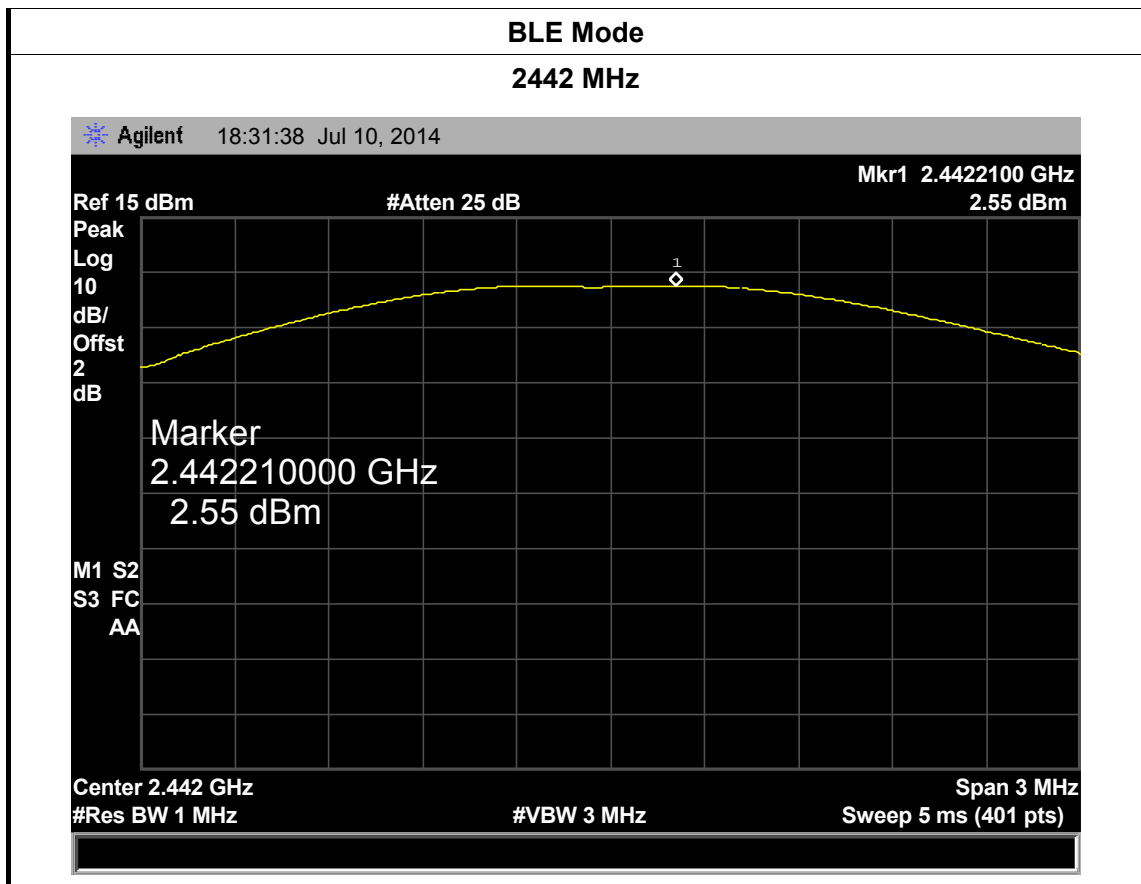

8. Power Spectral Density Test

8.1 Test Standard and Limit

8.1.1 Test Standard

FCC Part 15.247 (e)

8.1.2 Test Limit

FCC Part 15 Subpart C(15.247)		
Test Item	Limit	Frequency Range(MHz)
Power Spectral Density	8dBm(in any 3 kHz)	2400~2483.5

8.2 Test Setup

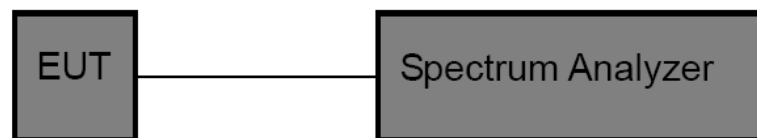

8.3 Test Procedure

The EUT was directly connected to the Spectrum Analyzer and antenna output port as show in the block diagram above. The measurement according to section 10.2 of KDB 558074 D01 DTS Meas Guidance v03r02.

- (1) The EUT was directly connected to the spectrum analyzer and antenna output port as show in the block diagram above.
- (2) Set analyser center frequency to DTS channel center frequenyc.
- (3) Set the span to 1.5 times the DTS bandwidth.
- (4) Set the RBW to: 3 kHz
- (5) Set the VBW to: 10 kHz
- (6) Detector: peak
- (7) Sweep time: auto
- (8) Allow trace to fully stabilize. Then use the peak marker function to determine the maximum amplitude level.

8.4 EUT Operating Condition

The EUT was set to continuously transmitting in each mode and low, Midle and high channel for the test.

8.5 Test Equipment

Equipment	Manufacturer	Model No.	Serial No.	Last Cal.	Cal. Due Date
Spectrum Analyzer	Rohde & Schwarz	FSP30	DE25181	Aug. 10, 2013	Aug.09, 2014

8.6 Test Data

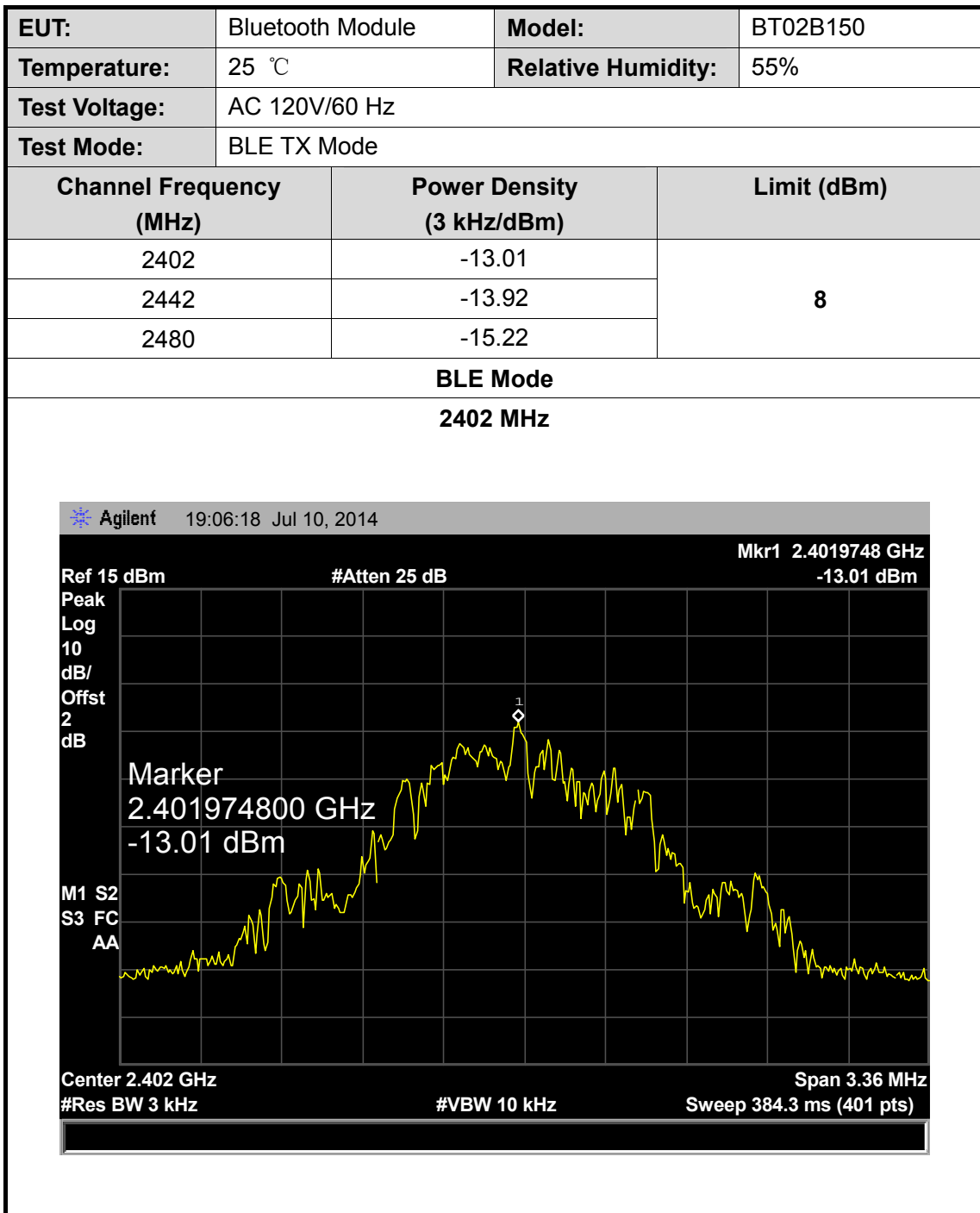

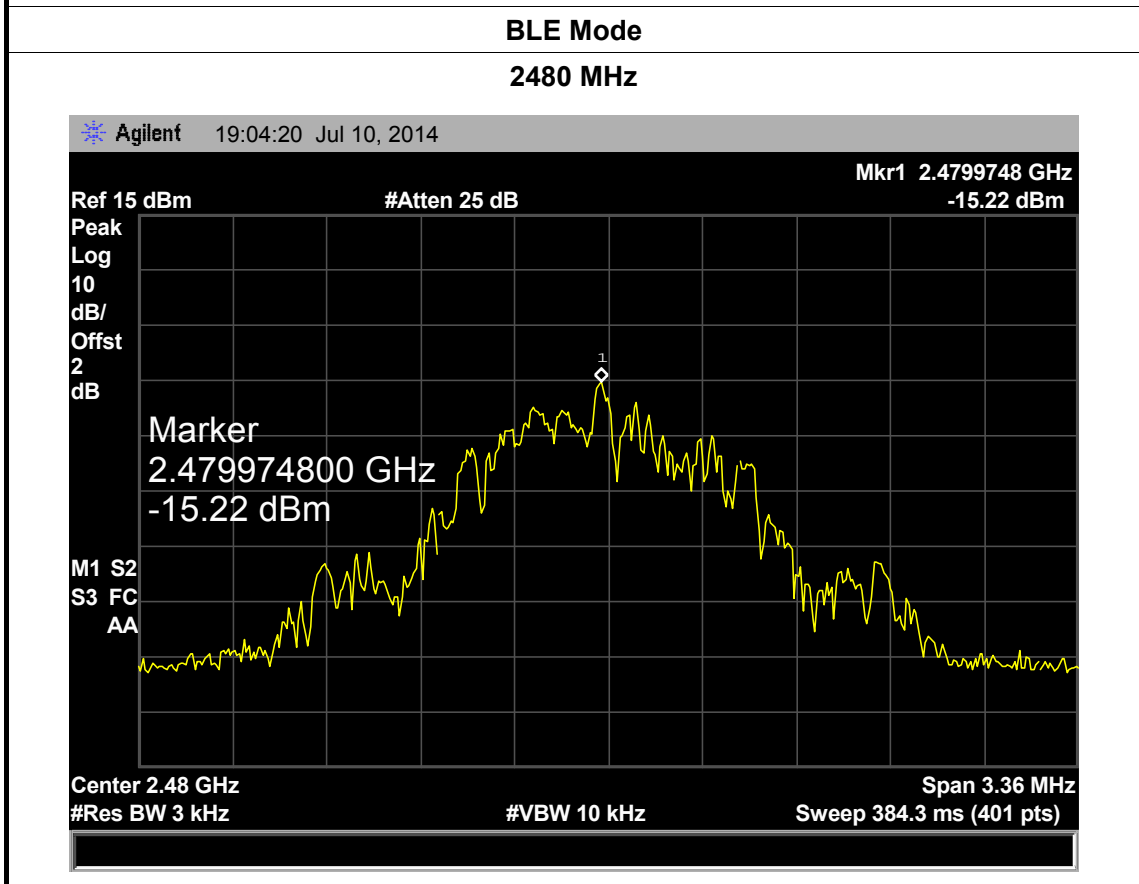
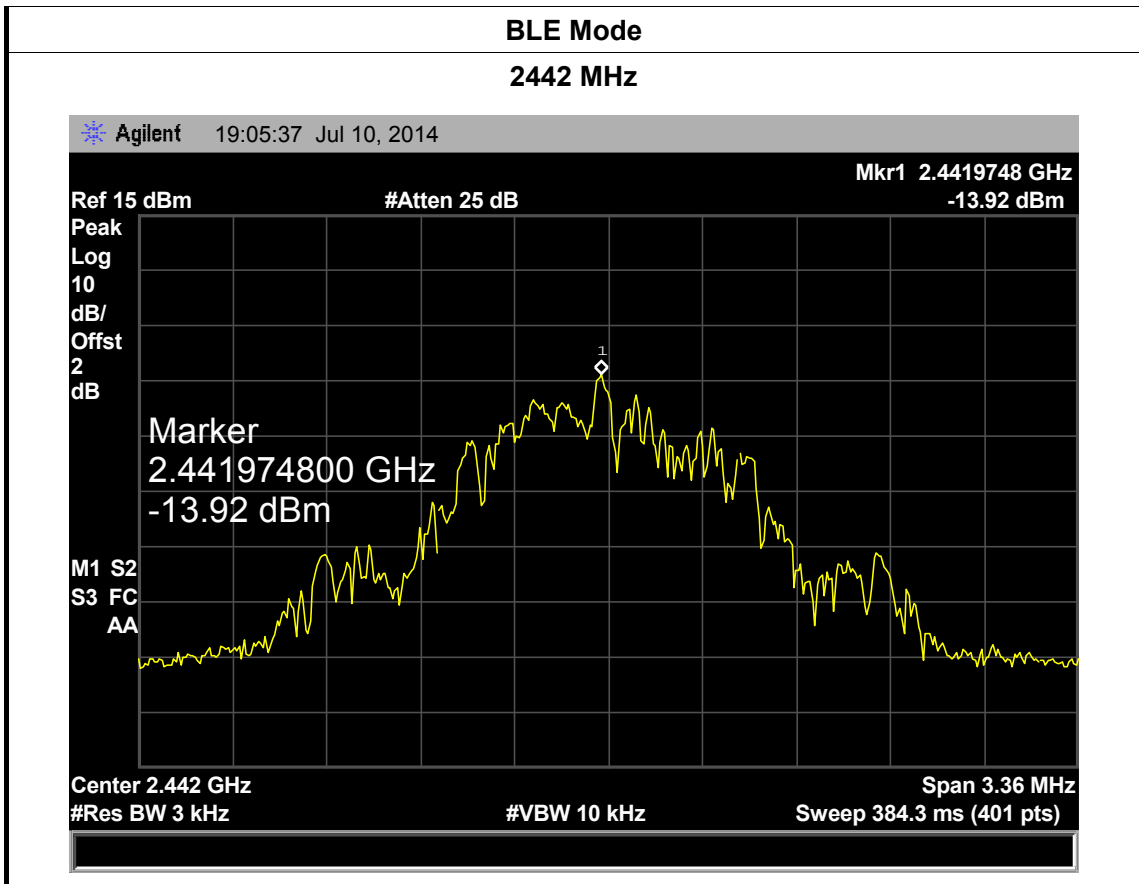

9. Antenna Conducted Spurious Emission

9.1 Test Standard and Limit

10.1.1 Test Standard

FCC Part 15.247 (d)

10.1.2 Test Limit

In any 100 kHz bandwidth outside the frequency band in which the spread spectrum or digitally modulated intentional radiator is operating, the radio frequency power that is produced by the intentional radiator shall be at least 20 dB below that in the 100 kHz bandwidth within the band that contains the highest level of the desired power. In case the emission fall within the restricted band specified on 15.205(a), then the 15.209(a) limit in the table below has to be followed.

Frequencies (MHz)	Field Strength (microvolt/meter)	Measurement Distance (meters)
0.009~0.490	2400/F(KHz)	300
0.490~1.705	24000/F(KHz)	30
1.705~30.0	30	30
30~88	100	3
88~216	150	3
216~960	200	3
Above~960	500	3

(2)If the peak output power procedure is used to measure the fundamental emission power to demonstrate compliance to 15.247(b)(3) requirements, then the peak conducted output power measured within any 100 kHz outside the authorized frequency band shall be attenuated by at least 20 dB relative to the maximum measured in-band peak PSD level.

9.2 Test Setup

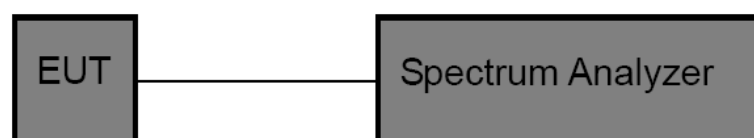

9.3 Test Procedure

(1) The EUT was directly connected to the spectrum analyzer and antenna output port as show in the block diagram above.

(2) Spectrum Setting:

RBW=100 KHz, VBW=300 KHz.

Frequency range: from 30MHz to 26.5 GHz.

9.4 EUT Operating Condition

The EUT was set to continuously transmitting in the max power during the test.

9.5 Test Equipment

Equipment	Manufacturer	Model No.	Serial No.	Last Cal.	Cal. Due Date
Spectrum Analyzer	Agilent	E4407B	MY45106456	Mar. 20, 2014	Mar. 19, 2015

9.6 Test Data

BLE Mode TX CH 00 2402MHz

Above 1 GHz

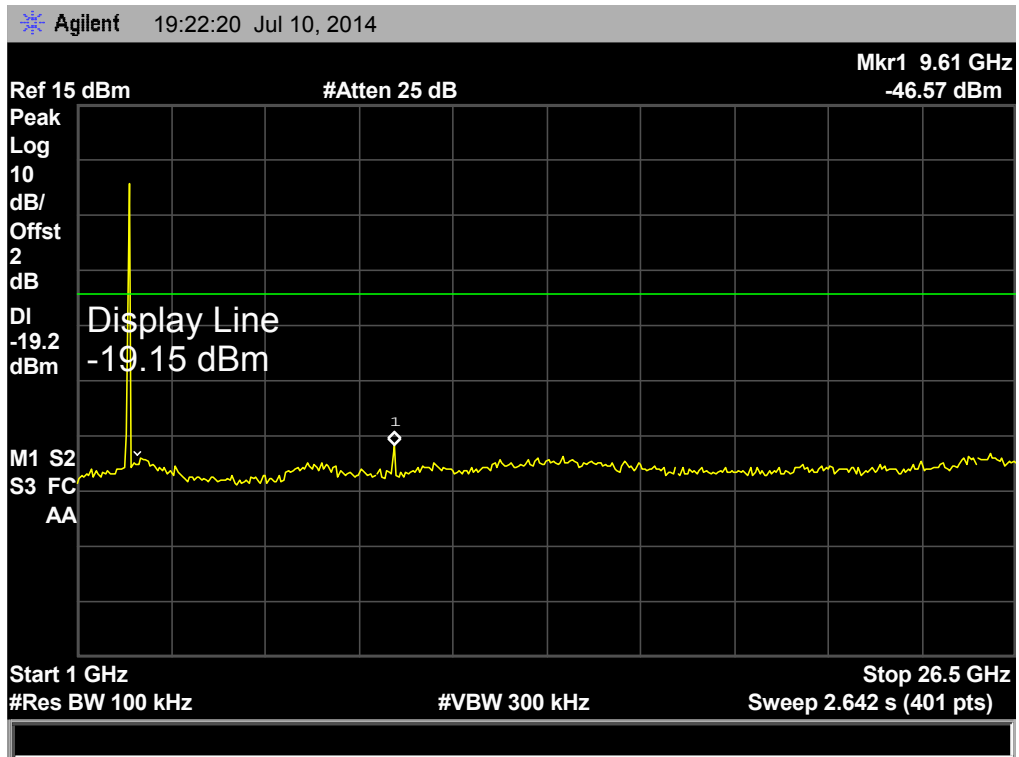

Below 1 GHz

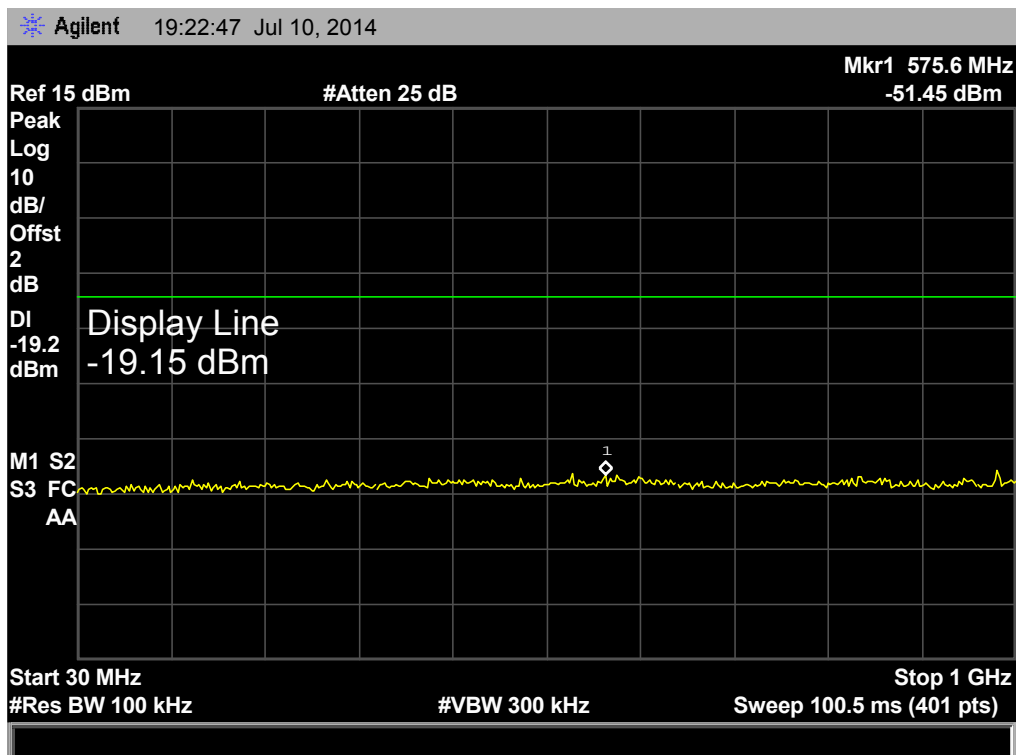

BLE Mode TX CH 20 2442MHz

Above 1 GHz

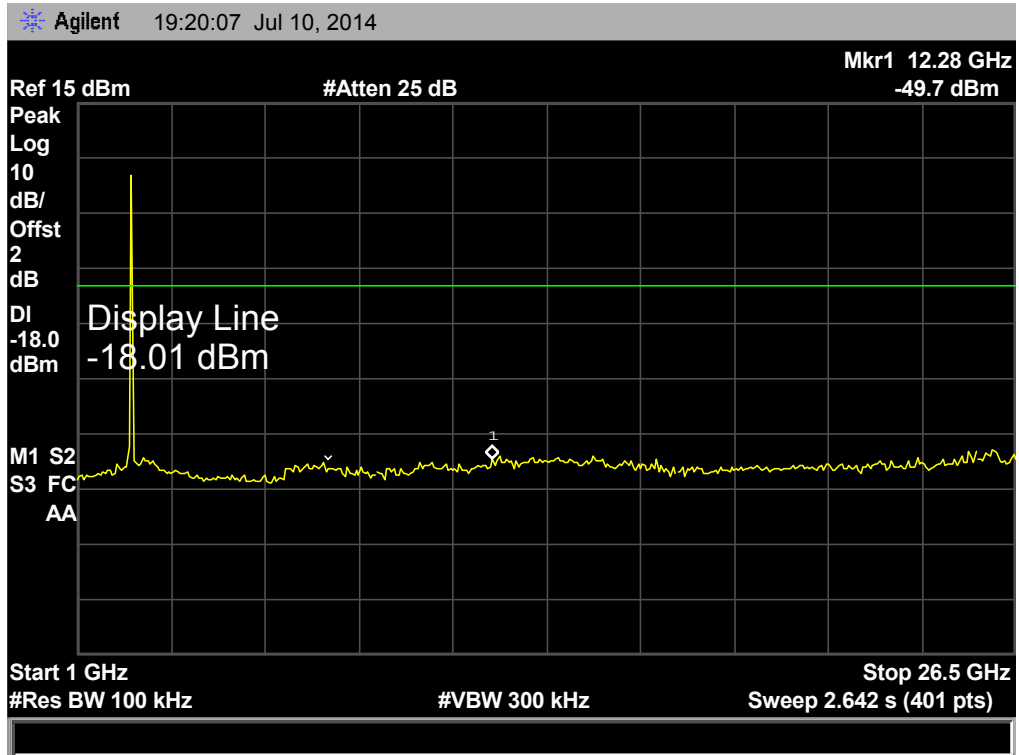

Below 1 GHz

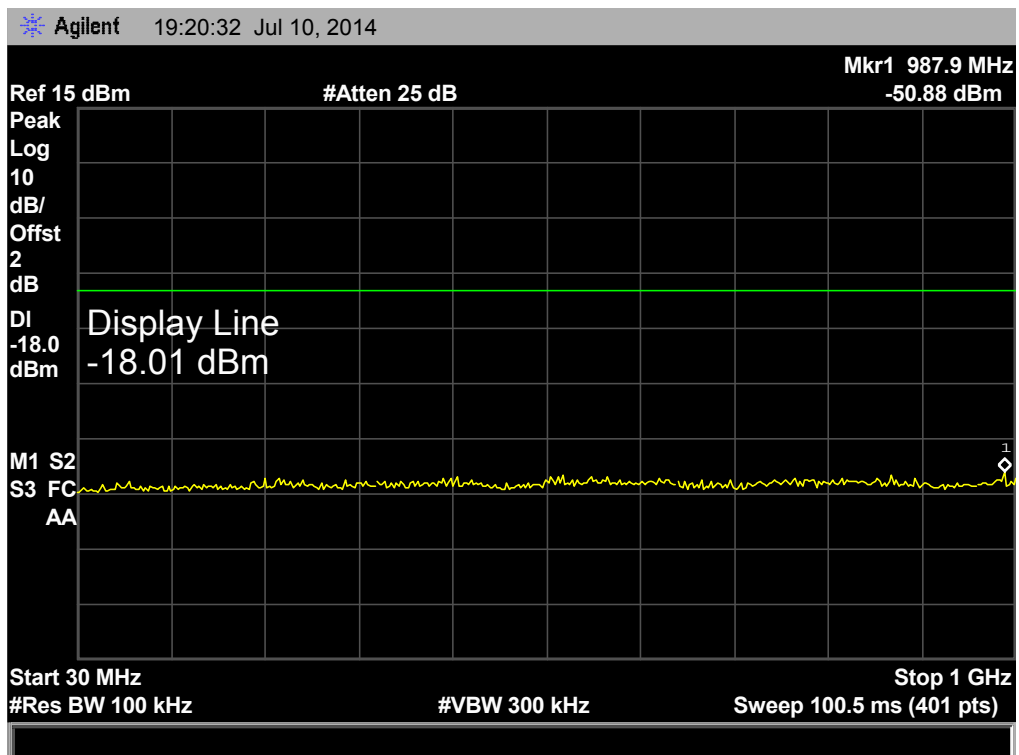

BLE Mode TX CH 39 2480MHz

Above 1 GHz

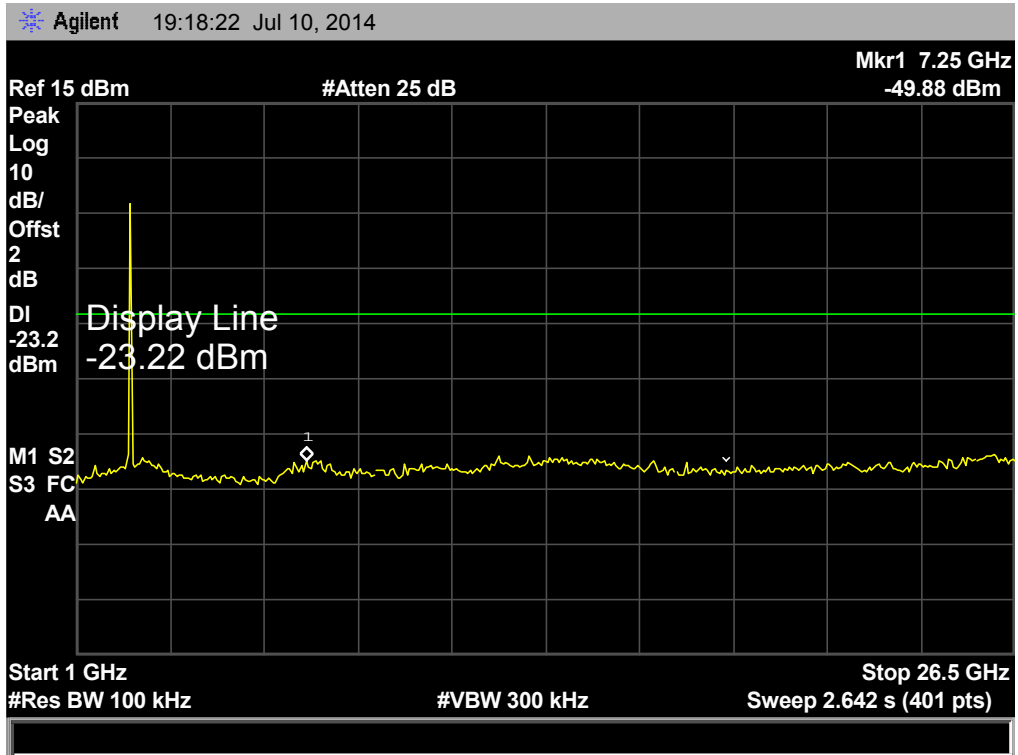

Below 1 GHz

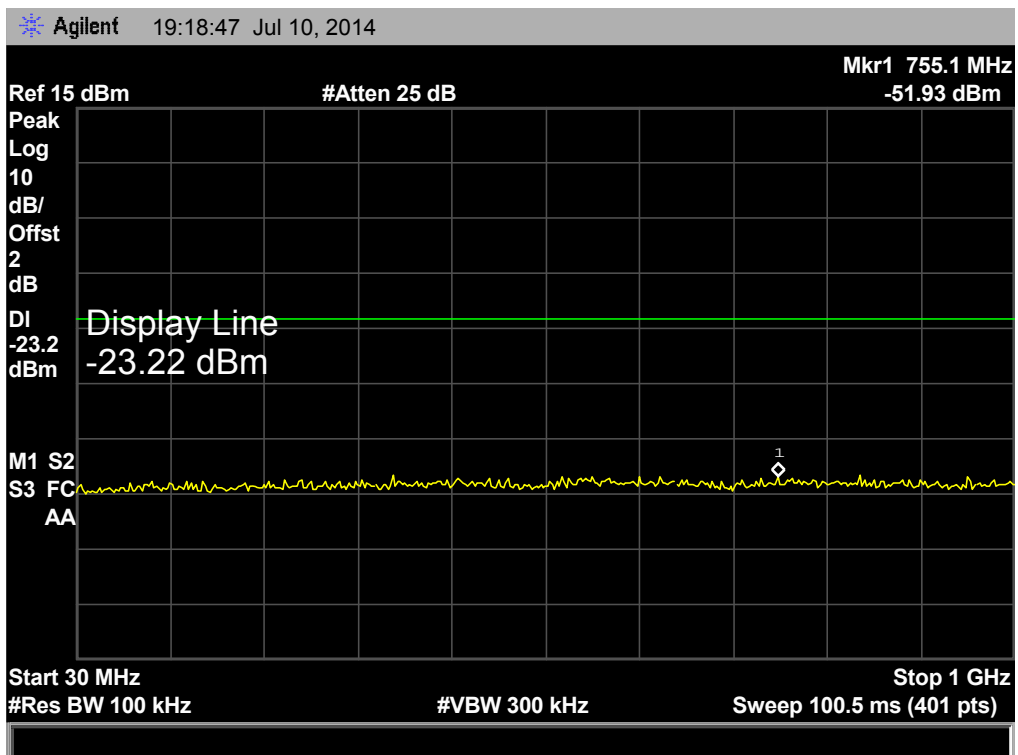

10. Antenna Requirement

10.1 Standard Requirement

11.1.1 Standard

FCC Part 15.203

11.1.2 Requirement

An intentional radiator shall be designed to ensure that no antenna other than that furnished by the responsible party shall be used with the device. The use of a permanently attached antenna or of an antenna that uses a unique coupling to the intentional radiator shall be considered sufficient to comply with the provisions of this Section. The manufacturer may design the unit so that a broken antenna can be replaced by the user, but the use of a standard antenna jack or electrical connector is prohibited.

10.2 Antenna Connected Construction

The directional gains of the antenna used for transmitting is 3 dBi, and the antenna de-signed with permanent attachment and no consideration of replacement. Please see the EUT photo for details.

10.2 Result

The EUT antenna is a PIFA Antenna. It complies with the standard requirement.