



PHOENIX
TESTLAB

Königswinkel 10

32825 Blomberg

Germany

Phone: +49 (0) 52 35 95 00-0

Fax: +49 (0) 52 35 95 00-10

Test Report

Report Number: F150729E2

Applicant:

Miele & Cie. KG

Manufacturer:

Miele & Cie. KG

Equipment under Test (EUT):

EK037

Laboratory accredited by
Deutsche Akkreditierungsstelle GmbH (DAkkS)
in compliance with DIN EN ISO/IEC 17025
under the Reg. No. D-PL-17186-01-02,
FCC Test site registration number 90877 and
Industry Canada Test site registration IC3469A-1

REFERENCES

- [1] **ANSI C63.10-2013** American National Standard of Procedures for Compliance Testing of Unlicensed Wireless Devices
- [2] **FCC CFR 47 Part 15 (April 2016)** Radio Frequency Devices
- [3] **RSS-247 (May 2015)** Digital Transmission Systems (DTSs), Frequency Hopping Systems (FHSs) and Licence-Exempt Local Area Network (LE-LAN) Devices
- [4] **RSS-Gen Issue 4 (November 2014)** General Requirements for Compliance of Radio Apparatus

TEST RESULT

The requirements of the tests performed as shown in the overview (clause 4) were fulfilled by the equipment under test.
The complete test results are presented in the following.

Test engineer:	Paul NEUFELD		14 April 2016
	Name	Signature	Date
Authorized reviewer:	Bernd STEINER		14 April 2016
	Name	Signature	Date

This test report is only valid in its original form.

Any reproduction of its contents in extracts without written permission of the accredited test laboratory PHOENIX TESTLAB GmbH is prohibited.

The test results herein refer only to the tested sample. PHOENIX TESTLAB GmbH is not responsible for any generalisations or conclusions drawn from these test results concerning further samples. Any modification of the tested samples is prohibited and leads to the invalidity of this test report. Each page necessarily contains the PHOENIX TESTLAB Logo and the TEST REPORT NUMBER.

Contents:	Page
1 IDENTIFICATION	4
1.1 Applicant.....	4
1.2 Manufacturer.....	4
1.3 Test laboratory	4
1.4 EUT (Equipment Under Test)	5
1.5 Dates	6
2 OPERATIONAL STATES.....	6
3 ADDITIONAL INFORMATION.....	8
4 OVERVIEW	9
5 TEST RESULTS	10
5.1 Duty Cycle	10
5.1.1 Method of measurement.....	10
5.1.2 Test results	11
5.2 Maximum peak output power.....	12
5.2.1 Method of measurement.....	12
5.2.2 Test results	13
5.3 DTS Bandwidth.....	15
5.3.1 Method of measurement.....	15
5.3.2 Test result	16
5.4 Peak Power Spectral Density.....	17
5.4.1 Method of measurement.....	17
5.4.2 Test result	18
5.5 Band-edge compliance.....	19
5.5.1 Method of measurement (band edges next to unrestricted bands (radiated)).....	19
5.5.2 Test result (band edges next to unrestricted bands (radiated))	20
5.5.3 Method of measurement (band edges next to restricted bands (radiated))	21
5.5.4 Test result (band edges next to restricted bands (radiated)).....	21
5.6 Maximum unwanted emissions.....	23
5.6.1 Method of measurement (radiated emissions)	23
5.6.2 Test results (radiated emissions) – antenna and cabinet emissions	30
5.6.2.1 Preliminary radiated emission measurement.....	30
5.6.2.2 Final radiated emission measurement (9 kHz to 1 GHz).....	35
5.6.2.3 Final radiated emission measurement (1 GHz to 25 GHz).....	35
5.7 Conducted emissions on power supply lines (150 kHz to 30 MHz).....	42
5.7.1 Method of measurement.....	42
5.7.2 Test results (conducted emissions on power supply lines)	43
6 TEST EQUIPMENT AND ANCILLARIES USED FOR TESTS.....	44
7 REPORT HISTORY	46
8 LIST OF ANNEXES	46

1 IDENTIFICATION

1.1 Applicant

Name:	Miele & Cie. KG
Address:	Carl-Miele-Straße 29, 33332 Gütersloh
Country:	Germany
Name for contact purposes:	Gunnar Borgelt
Phone:	05241/89-6292
Fax:	05241/89-786292
eMail Address:	gunnar.borgelt@miele.de
Applicant represented during the test by the following person:	Christian Bömke

1.2 Manufacturer

Name:	Miele & Cie. KG
Address:	Carl-Miele-Straße 29, 33332 Gütersloh
Country:	Germany
Name for contact purposes:	Gunnar Borgelt
Phone:	05241/89-6292
Fax:	05241/89-786292
eMail Address:	gunnar.borgelt@miele.de
Manufacturer represented during the test by the following person:	Christian Bömke

1.3 Test laboratory

The tests were carried out at: **PHOENIX TESTLAB GmbH**
Königswinkel 10
32825 Blomberg
Germany

accredited by Deutsche Akkreditierungsstelle GmbH (DAkkS) in compliance with DIN EN ISO/IEC 17025 under the Reg. No. D-PL-17186-01-02, FCC Test site registration number 90877 and Industry Canada Test site registration IC3469A-1.

1.4 EUT (Equipment Under Test)

Test object: *	WLAN Module
Model / PMN: *	EK037
FCC ID: *	2ACUWEK037
IC: *	5669C-EK037
Serial number: *	Prototype
PCB identifier / HVIN: *	EK037
Hardware version: *	EK037 071114
Software version /FVIN: *	mieleRT V1.0

Channel 01	RX:	2412 MHz	TX:	2412 MHz
Channel 02	RX:	2417 MHz	TX:	2417 MHz
Channel 03	RX:	2422 MHz	TX:	2422 MHz
Channel 04	RX:	2427 MHz	TX:	2427 MHz
Channel 05	RX:	2432 MHz	TX:	2432 MHz
Channel 06	RX:	2437 MHz	TX:	2437 MHz
Channel 07	RX:	2442 MHz	TX:	2442 MHz
Channel 08	RX:	2447 MHz	TX:	2447 MHz
Channel 09	RX:	2452 MHz	TX:	2452 MHz
Channel 10	RX:	2457 MHz	TX:	2457 MHz
Channel 11	RX:	2462 MHz	TX:	2462 MHz

Fulfills Radio specification: *	WLAN IEEE, 802.11b, 802.11g, 802.11n,
Antenna type: *	PCB Antenna
Antenna gain: *	2 dBi
Antenna connector: *	none
Power supply - EUT	3.3 V DC
Type of modulation: *	DSSS; OFDM
Operating frequency range:*	2412 MHz to 2462 MHz
Number of channels: *	11
Temperature range: *	0 °C to +85 °C
Lowest / highest internal clock frequency: *	32768 Hz / 40 MHz

* declared by the applicant.

The following external I/O cables were used:

Identification	Connector		Length
	EUT	Ancillary	
DC in (EUT)	On Board Pin connector	DC Power Supply	2 m *
USB in (EUT)	On Board Pin connector	Laptop computer	2 m *

*: Length during the test if not other specified.

1.5 Dates

Date of receipt of test sample:	03 February 2015
Start of test:	03 February 2015
End of test:	02 November 2015

2 OPERATIONAL STATES

The equipment under test (EUT) is a WLAN module that is intended to be integrated into several applications. The WLAN module is equipped with an integral antenna.

The EUT is connected by solder pads to a Laboratory DC power supply and to a Laptop with a test software to allow different test mode.

If not mentioned otherwise the module was powered by 3.3 VDC from a laboratory power supply

All tests were carried out with an unmodified sample.

With test software which was provided by the applicant the EUT could be set to a continuous transmit mode with a certain modulation scheme and data rate on a certain frequency. Furthermore the equipment could be set to receive mode on a certain frequency. This software was installed on a laptop PC, which was connected to the Equipment under test an USB cable.

For this test report the EUT was tested as a WLAN device in the 2.4 GHz band which was able to operate according to the specification 802.11 b/g/n20. The table below shows the worst case modulation and data rate for appropriate test cases.

The following operation modes were identified as worst case condition and used during the tests:

Operation mode	Description of the operation mode	WLAN mode	WLAN channel	Modulation	Data rate / Mbps
1	Continuous transmitting on 2412 MHz	b	1	CCK	11 MBit/s
2	Continuous transmitting on 2437 MHz	b	6	CCK	11 MBit/s
3	Continuous transmitting on 2462 MHz	b	11	CCK	11 MBit/s
4	Continuous transmitting on 2412 MHz	g	1	OFDM	9 MBit/s
5	Continuous transmitting on 2437 MHz	g	6	OFDM	9 MBit/s
6	Continuous transmitting on 2462 MHz	g	11	OFDM	9 MBit/s
7	Continuous transmitting on 2412 MHz	n 20 MHz	1	OFDM	13 MBit/s
8	Continuous transmitting on 2437 MHz	n 20 MHz	6	OFDM	13 MBit/s
9	Continuous transmitting on 2462 MHz	n 20 MHz	11	OFDM	13 Mbit/s
10	Normal operation mode ping active with ancillary laptop computer	Auto	Auto	Auto	Auto

Preliminary tests were performed to find worst-case configuration and position. The radiated emission measurements were carried out in the positioner angle that emits the highest spurious emission levels.

Each test case was performed in the following operation modes:

Test items	Operation mode
Maximum Peak Output Power	1 - 9
DTS Bandwidth	1 - 9
Peak Power Spectral Density	1 - 9
Band Edge Compliance	1, 3, 4, 6, 7, 9
Maximum Unwanted Emissions	1 - 9
Conducted Emissions on Power Supply	10

3 ADDITIONAL INFORMATION

Photo of the module as marketed:



Powersettings:

WLAN mode	Channel 1 [dBm]	Channel 6 [dBm]	Channel 11 [dBm]
802.11b 1 Mbps	16.5	18.0	16.5
802.11b 2 Mbps	16.5	18.0	16.5
802.11b 5.5 Mbps	16.7	18.3	16.7
802.11b 11 Mbps	16.7	18.3	16.7
802.11g 6 Mbps	14.3	17.3	14.3
802.11g 9 Mbps	14.3	17.3	14.3
802.11g 12 Mbps	13.7	17.0	13.7
802.11g 18 Mbps	13.7	17.0	13.7
802.11g 24 Mbps	12.7	16.0	12.7
802.11g 36 Mbps	12.7	16.0	12.7
802.11g 48 Mbps	12.7	16.0	12.7
802.11g 54 Mbps	12.7	13.5	12.7
802.11n	12.7	13.5	12.7

4 OVERVIEW

Application	Frequency range [MHz]	FCC 47 CFR Part 15 section [2]	RSS 247 [4] or RSS-Gen, Issue 4 [5]	Status	Refer page
Maximum Peak Output Power	2400.0 - 2483.5	15.247 (b) (3), (4)	5.4 (4) [3]	Passed	12 et seq
DTS Bandwidth	2400.0 - 2483.5	15.247 (a) (2)	5.2 (1) [3]	Passed	12 et seq
Peak Power Spectral Density	2400.0 - 2483.5	15.247 (e)	5.2 (2) [3]	Passed	17 et seq
Band edge compliance	2400.0 - 2483.5	15.247 (d)	5.5 [3] 8.9 [4], 8.10 [4]	Passed	19 et seq.
Radiated emissions (transmitter)	0.009 – 26,500	15.247 (d) 15.205 (a) 15.209 (a)	5.5 [3] 8.9 [4], 8.10 [4]	Passed	23 et seq.
Conducted emissions on supply line	0.15 - 30	15.207 (a)	8.8 [4]	Passed	42 et seq.

5 TEST RESULTS

5.1 Duty Cycle

5.1.1 Method of measurement

The radiated measurement setup was made according 5.6.1.

Acceptable measurement configurations

The measurement procedures described herein are based on radiated measurements.

Procedure 11.6 in [1] was used for the following test.

Preliminary tests were performed to find out the worst case data rate for each WLAN mode (modulation). The results below show the duty cycles for these data rates.

The Duty cycle factor D is calculated using the following formula:

$$D = \frac{t_{TX_On}}{t_{TX_Cycle}}$$

The Duty cycle correction factor is calculated using the following formula:

$$C = 10 \log\left(\frac{1}{D}\right)$$

5.1.2 Test results

Ambient temperature	21 °C
---------------------	-------

Relative humidity	40 %
-------------------	------

The following results were measured in a radiated setup. The plot shows an exemplary measurement result for the worst documented case. The other results are listed in the following table.

EK037 DutyCycle_ch1_11M_Pos3.wmf: Duty Cycle measurement 802.11b 11 Mbps

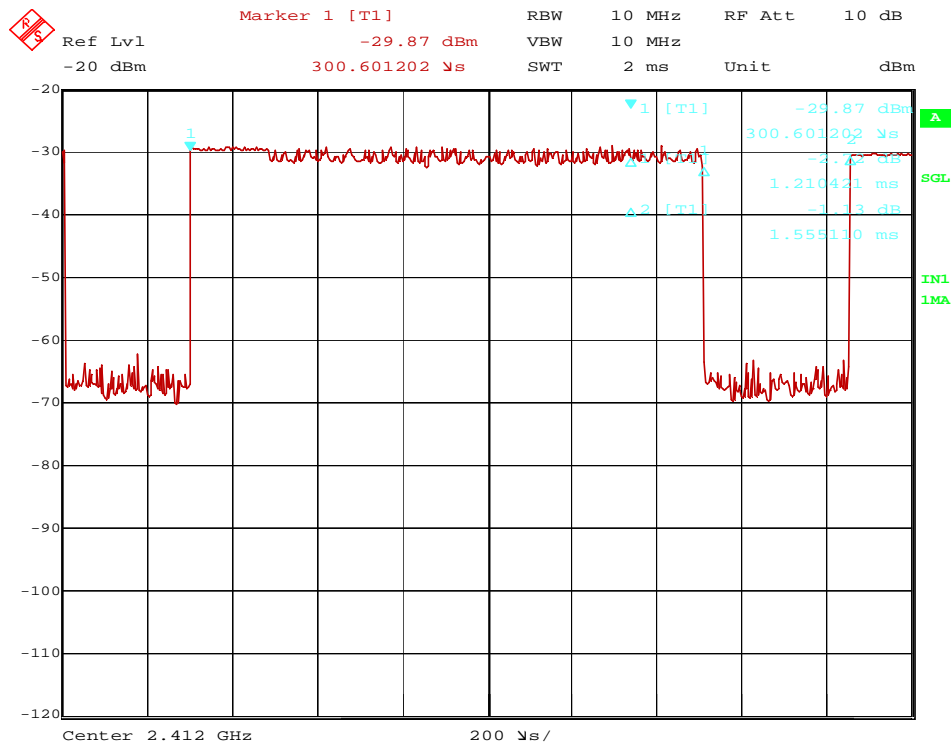

Data Rate [Mbps]	t _{TX_On} [ms]	t _{TX_Cycle} [ms]	Duty Cycle D [%]	Correction Factor C [dB]
11	1.210	1.555	77.8	1.1
9	1.271	1.475	86.2	0.6
13	0.902	1.078	83.4	0.8

TEST EQUIPMENT USED FOR THE TEST:

6, 8 -11, 13, 17, 18, 32, 33

5.2 Maximum peak output power

5.2.1 Method of measurement

The EUT was measured in a radiated setup within an anechoic chamber. The radiated measurement setup was made according 5.6.1.

Acceptable measurement configurations

Annex G in [1] is used for calculating radiated values to conducted values.

Procedure 11.9.1.2 in [1] was used for the following test.

The measurement was performed at the upper and lower end and the middle of the assigned frequency band.

The radiated logarithmic power levels are then calculated into conducted values by using the formula (G.8) in [1]:

$$P_R = P_{meas} - G_R + L_C + L_{atten} - G_{amp}$$

Where:

P_{meas}	is the measured power level, in dBW, dBm, ore psd
G_R	is the gain of the receive (measurement) antenna, in dBi
L_C	is the signal loss of the measurement cable, in dB
L_{atten}	is the value of the external attenuation (if used), in dB
G_{amp}	is the value of external amplification (if used), in dB

The free-space propagation loss is determined from Equation (G.9) in [1]:

$$L_p = 20 \log F + 20 \log d - 27.5$$

Where:

L_p	is the basic free space propagation path loss, in dB
F	is the center frequency of the radiated DUT signal, in MHz
d	is the measurement distance, in meters

The EIRP power can finally derived by formula (G.7) in [1]:

$$EIRP = P_R + L_p$$

Where:

$EIRP$	is the equivalent (or effective) isotropical radiated power (in same units as P_R)
P_R	is the adjusted received power level, in dBW, dBm, or psd
L_p	is the basic free-space path loss, in dB

5.2.2 Test results

Ambient temperature	21 °C	Relative humidity	40 %
---------------------	-------	-------------------	------

The following results were measured in a radiated setup. The plot shows an exemplary measurement result for the worst documented case. The other results are listed in the following table.

EK037 Power_ch6_11M_Pos3.wmf: Maximum peak output power (operation mode 2):

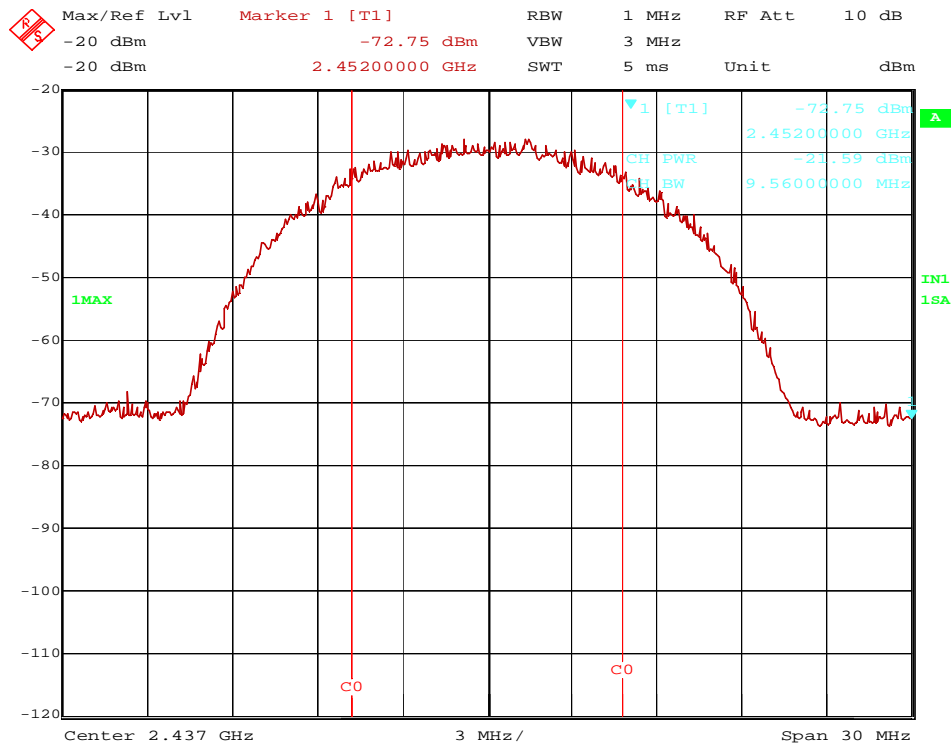

The highest antenna gain is 2.0 dBi. Therefore no reduction of the Peak power limit is necessary.

Operation Mode	Frequency [MHz]	Antenna gain combined [dBi]	Measured Power (radiated) [dBm]	Free Space Loss [dB]	Receiver Antenna Gain [dB]	Cable attenuation [dB]	EIRP Power [dBm]	Conducted Power [dBm]	Limit [dBm]
1	2412	2	-25.6	49.7	9.6	3.0	17.5	15.5	30
2	2437	2	-21.6	49.8	9.7	3.0	21.5	19.5	30
3	2462	2	-25.5	49.9	9.8	2.9	17.5	15.5	30
4	2412	2	-25.9	49.7	9.6	3.0	17.2	15.2	30
5	2437	2	-22.3	49.8	9.7	3.0	20.8	18.8	30
6	2462	2	-22.6	49.9	9.8	2.9	20.4	18.4	30
7	2412	2	-26.8	49.7	9.6	3.0	16.3	14.3	30
8	2437	2	-22.6	49.8	9.7	3.0	20.5	18.5	30
9	2462	2	-25.9	49.9	9.8	2.9	17.1	15.1	30
Measurement uncertainty					+2.2 dB / -3.6 dB				

EIRP Power = measured power (radiated) + Free Space Loss – Receiver Antenna Gain + Cable attenuation

Test: Passed

TEST EQUIPMENT USED FOR THE TEST:

6, 8 -11, 13, 17, 18, 32, 33

5.3 DTS Bandwidth

5.3.1 Method of measurement

The EUT was measured in a radiated setup within an anechoic chamber. The radiated measurement setup was made according 5.6.1.

The measurement procedure refers to part 11.8.1 of document [1].

- Set RBW = 100 kHz.
- Set the video bandwidth (VBW) $\geq 3 \times$ RBW.
- Detector = Peak.
- Trace mode = max hold.
- Sweep = auto couple.
- Allow the trace to stabilize.
- Measure the maximum width of the emission that is constrained by the frequencies associated with the two outermost amplitude points (upper and lower frequencies) that are attenuated by 6 dB relative to the maximum level measured in the fundamental emission.

5.3.2 Test result

Ambient temperature	21 °C	Relative humidity	40 %
---------------------	-------	-------------------	------

The following results were measured in a radiated setup. The plot shows an exemplary measurement result for the worst documented case. The other results are listed in the following table.

EK037_OBW6dB_ch6_11M_Pos3.wmf: DTS Bandwidth (operation mode 2):

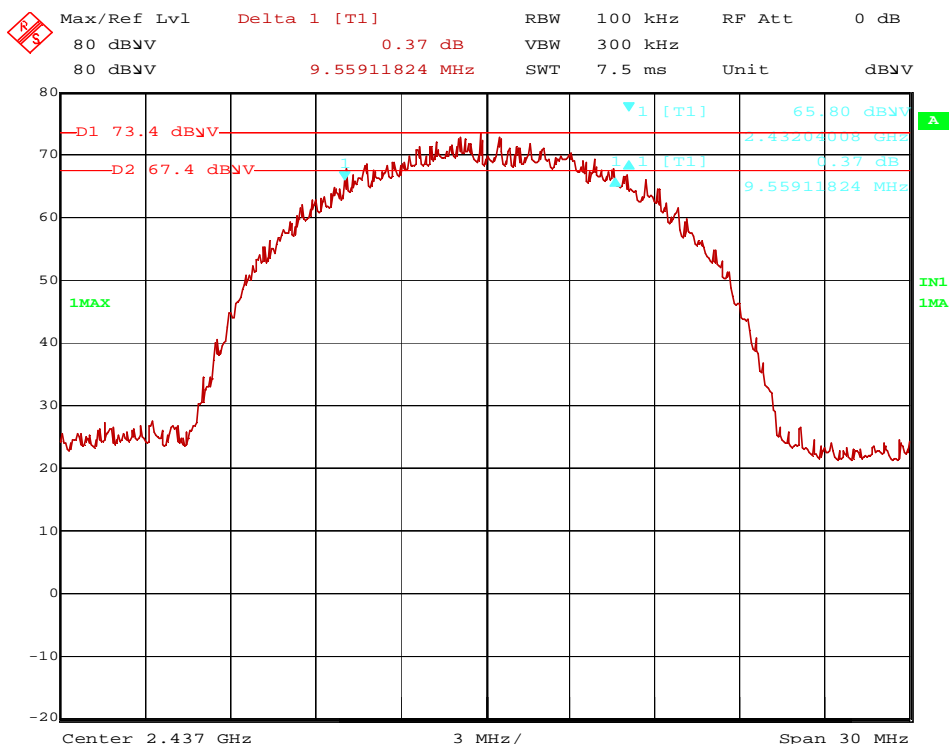

Operation Mode	Center Frequency [MHz]	Minimum 6-dB Bandwidth Limit [MHz]	6 dB Bandwidth [MHz]	Result
1	2412	0.5	10.040	Passed
2	2437	0.5	9.559	Passed
3	2462	0.5	10.040	Passed
4	2412	0.5	15.150	Passed
5	2437	0.5	15.150	Passed
6	2462	0.5	15.210	Passed
7	2412	0.5	15.271	Passed
8	2437	0.5	15.150	Passed
9	2462	0.5	15.210	Passed
Measurement uncertainty			+2.2 dB / -3.6 dB	

Test: Passed

TEST EQUIPMENT USED FOR THE TEST:

6, 8 -11, 13, 17, 18, 32, 33

5.4 Peak Power Spectral Density

5.4.1 Method of measurement

The EUT was measured in a radiated setup within an anechoic chamber. The radiated measurement setup was made according 5.6.1.

The measurement procedure refers to part 10.10.2 of document [1].

- Set analyser center frequency to DTS channel center frequency
- Set the span to 1.5 times the DTS bandwidth.
- Set the RBW to: $3 \text{ kHz} \leq \text{RBW} \leq 100 \text{ kHz}$.
- Set the VBW $\geq 3 \times \text{RBW}$.
- Detector = peak.
- Sweep time = auto couple.
- Trace mode = max hold.
- Allow trace to fully stabilize.
- Use the peak marker function to determine the maximum amplitude level within the RBW.
- If measured value exceeds limit, reduce RBW (not less than 3 kHz) and repeat.

The conversion from radiated to conducted values was performed using the formulas in 5.2.1.

5.4.2 Test result

Ambient temperature	21 °C	Relative humidity	40 %
---------------------	-------	-------------------	------

The following results were measured in a radiated setup. The plot shows an exemplary measurement result for the worst documented case. The other results are listed in the following table.

145863 PSD Pos1_ch11_Tisch.wmf: Power Spectral Density (operation mode 2):

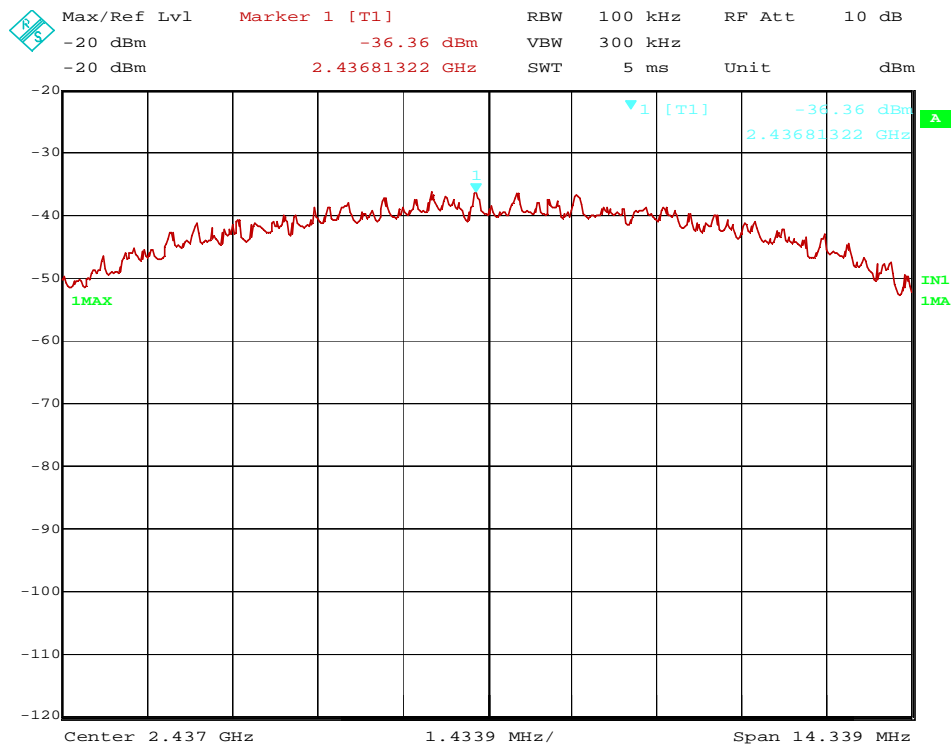

Operation Mode	Peak Frequency [MHz]	Measured Power (radiated) [dBm/100 kHz]	Free Space Loss [dB]	Receiver Antenna Gain [dB]	Cable attenuation [dB]	Power Spectral Density Level [dBm/100kHz]	Margin [dB]	Power Spectral Density Limit [dBm/3kHz]
1	2411.834	-38.7	49.7	9.6	3.0	4.4	3.6	8
2	2436.813	-36.4	49.8	9.7	3.0	6.7	1.3	8
3	2461.080	-37.2	49.9	9.8	2.9	5.8	2.2	8
4	2414.528	-44.5	49.7	9.6	3.0	-1.4	9.4	8
5	2439.528	-40.9	49.8	9.7	3.0	2.2	5.8	8
6	2460.788	-43.7	49.9	9.8	2.9	-0.7	8.7	8
7	2413.355	-45.0	49.7	9.6	3.0	-1.9	9.9	8
8	2438.343	-40.9	49.8	9.7	3.0	2.2	5.8	8
9	2460.788	-44.0	49.9	9.8	2.9	-1.0	9.0	8
Measurement uncertainty					+2.2 dB / -3.6 dB			

Power Spectral Density Level = Measured Power radiated +Free Space Loss-Receiver Antenna Gain+Cable attenuation

Test: Passed

TEST EQUIPMENT USED FOR THE TEST:

6, 8 -11, 13, 17, 18, 32, 33

5.5 Band-edge compliance

5.5.1 Method of measurement (band edges next to unrestricted bands (radiated))

The EUT was measured in a radiated setup within an anechoic chamber. The radiated measurement setup was made according 5.6.1.

The measurement procedure refers to part 11.11.2 and 11.11.3 of document [1].

Measurement Procedure Reference – Reference Level:

- RBW = 100 kHz.
- VBW \geq 300 kHz.
- Set the span to \geq 1.5 times the DTS Bandwidth.
- Detector = Peak.
- Sweep time = auto couple.
- Trace mode = max hold.
- Allow trace to fully stabilise.
- Use the peak marker function to determine the the maximum PSD level.

Measurement Procedure – Unwanted Emissions

- Set the center frequency and span to encompass the frequency range to be measured.
- RBW = 100 kHz.
- VBW \geq 300 kHz.
- Detector = Peak.
- Ensure that the number of measurement points \geq span/RBW.
- Sweep time = auto couple.
- Trace Mode = max hold.
- Allow the trace to stabilise.
- Use the peak marker function to determine the maximum amplitude level.

The measurement procedure at the band edges was simplified by performing the measurement in just one plot. Both, the in-band-emission and the unwanted emission were be encompassed by the span. After trace stabilization, the maximum peak was be determined by a peak detector and the value was marked by an appropriate limit line. The second limit line, which is 20 dB below the first, marks the limit for the emissions in the unrestricted band. A maximum-peak-detector marks the highest emission in the unrestricted band next to the band edge.

The measurements were performed at the lower end of the 2.4 GHz band.

5.5.2 Test result (band edges next to unrestricted bands (radiated))

Ambient temperature	21 °C	Relative humidity	40 %
---------------------	-------	-------------------	------

The following results were measured in a radiated setup.
The plot shows an exemplary measurement result for the worst documented case. The other results are listed in the following table.

EK037 BandEdgeUnrestr_ch1_9M_Pos3.wmf: conducted band-edge compliance (operation mode 1):

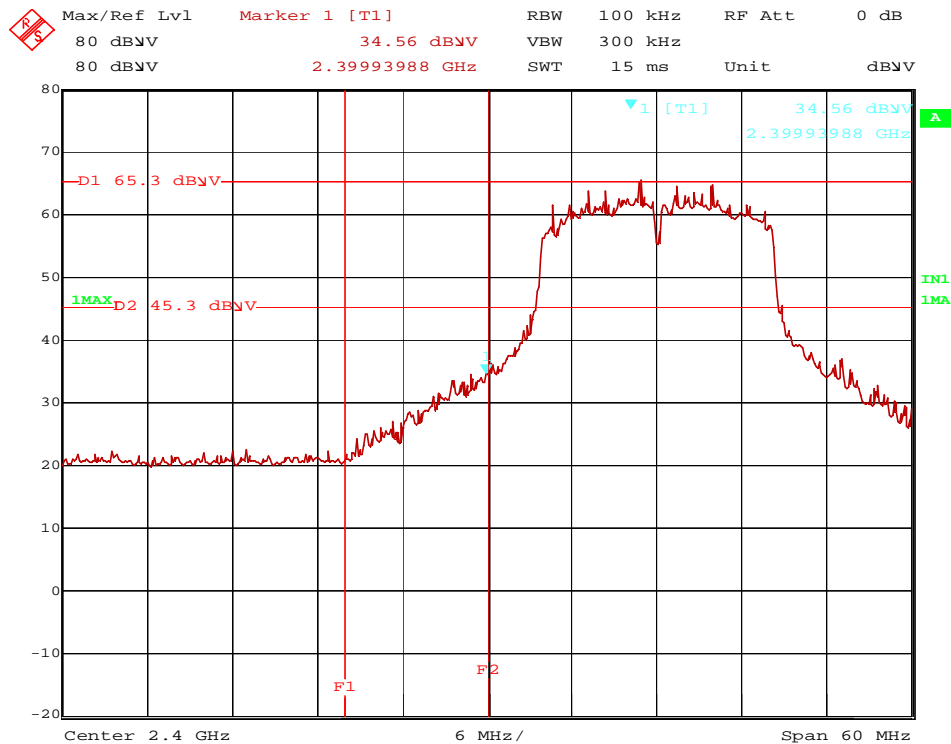

Operation Mode	WLAN channel	Band-Edge	Reference Level [dBμV]	Limit [dBμV]	Unwanted Emission Frequency MHz	Unwanted Emission Value [dBμV]	Margin dB
1	1	low	68.9	48.9	2396.934	25.0	23.9
4	1	low	65.3	45.3	2399.940	34.6	10.7
7	1	low	64.2	44.2	2399.580	33.0	11.2
Measurement uncertainty					+2.2 dB / -3.6 dB		

Test: Passed

TEST EQUIPMENT USED FOR THE TEST:
6, 8 -11, 13, 17, 18, 32, 33

5.5.3 Method of measurement (band edges next to restricted bands (radiated))

The EUT was measured in a radiated setup within an anechoic chamber. The radiated measurement setup was made according 5.6.1.

After trace stabilisation the marker shall be set on the signal peak. The frequency line shall be set on the edge of the assigned frequency band. Now set the second marker on the emission at the band-edge, or on the highest modulation product outside of the band, if this level is higher than that at the band-edge. The level of the measured field strength shall be compared to the general limits specified in § 15.205.

The measurement was performed at the lower and the upper end of the 2.4 GHz band.

5.5.4 Test result (band edges next to restricted bands (radiated))

Ambient temperature	22 °C	Relative humidity	59 %
---------------------	-------	-------------------	------

The plot shows an exemplary measurement result for the worst documented case. The other results are listed in the following table.

BandEdge 9M ch11 150°.wmf: conducted band-edge compliance (operation mode 6):

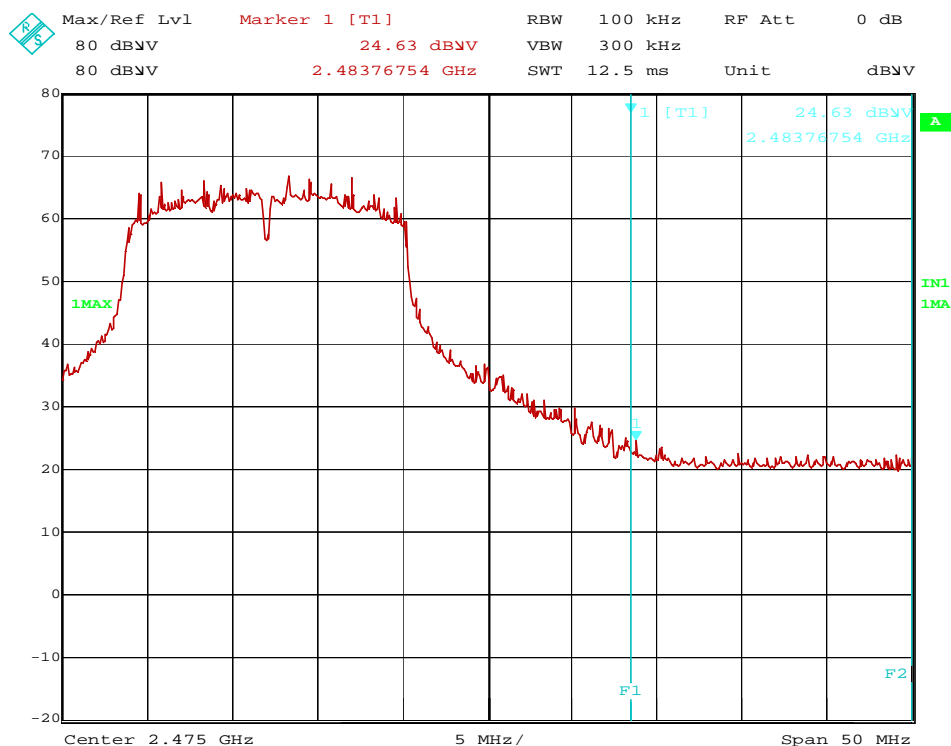

Transmitter operates at the upper end of the assigned frequency band (operation mode 6)

Result measured with the peak detector:

Frequency MHz	Meas. Result dB μ V/m	Limit dB μ V/m	Margin dB	Readings dB μ V	Antenna factor 1/m	Preamp dB	Cable loss dB	Height cm	Pol.	Pos.
2483.8	66.7	74.0	7.3	34.3	28.6	0	3.8	150	Hor.	3
Measurement uncertainty				+2.2 dB / -3.6 dB						

Result measured with the average detector:

Frequency MHz	Meas. Result dB μ V/m	Limit dB μ V/m	Margin dB	Readings dB μ V	Antenna factor 1/m	Preamp dB	Cable loss dB	Height cm	Pol.	Pos.
2483.8	51.4	54	2.6	18.4	28.6	0	3.8	150	Hor.	3
Measurement uncertainty				+2.2 dB / -3.6 dB						

Transmitter operates at the upper end of the assigned frequency band (operation mode 9)

Result measured with the peak detector:

Frequency MHz	Meas. Result dB μ V/m	Limit dB μ V/m	Margin dB	Readings dB μ V	Antenna factor 1/m	Preamp dB	Cable loss dB	Height cm	Pol.	Pos.
2483.8	66.67	74	7.33	34.32	28.55	0	3.8	150	Hor.	3
Measurement uncertainty				+2.2 dB / -3.6 dB						

Result measured with the average detector:

Frequency MHz	Meas. Result dB μ V/m	Limit dB μ V/m	Margin dB	Readings dB μ V	Antenna factor 1/m	Preamp dB	Cable loss dB	Height cm	Pol.	Pos.
2483.8	51.35	54	2.65	18.4	28.55	0	3.8	150	Hor.	3
Measurement uncertainty				+2.2 dB / -3.6 dB						

Test: Passed

TEST EQUIPMENT USED FOR THE TEST:
6, 8 -11, 13, 17, 18, 32, 33

5.6 Maximum unwanted emissions

5.6.1 Method of measurement (radiated emissions)

The radiated emission measurement is subdivided into five stages.

- A preliminary measurement carried out in a fully anechoic chamber with a fixed antenna height in the frequency range 9 kHz to 1 GHz.
- A final measurement carried out on an outdoor test site without reflecting ground plane and a fixed antenna height in the frequency range 9 kHz to 30 MHz.
- A final measurement carried out on an open area test site with reflecting ground plane and various antenna height in the frequency range 30 MHz to 1 GHz.
- A preliminary measurement carried out in a fully anechoic chamber with a variable antenna distance and height in the frequency range 1 GHz to 25 / 40 GHz.
- A final measurement carried out in a fully anechoic chamber with a fixed antenna height in the frequency range 1 GHz to 25 / 40 GHz.

Preliminary measurement (9 kHz to 30 MHz):

In the first stage a preliminary measurement will be performed in a shielded room with a measuring distance of 3 meters. Tabletop devices will set up on a non-conducting support with a size of 1 m by 1.5 m and a height of 80 cm. Floor-standing devices will be placed directly on the turntable/ground plane. The set up of the Equipment under test will be in accordance to [1].

The frequency range 9 kHz to 30 MHz will be monitored with a spectrum analyser while the system and its cables will be manipulated to find out the configuration with the maximum emission levels if applicable. The EMI Receiver will be set to MAX Hold mode. The EUT and the measuring antenna will be rotated around their vertical axis to found the maximum emissions.

The resolution bandwidth of the spectrum analyser will be set to the following values:

Frequency range	Resolution bandwidth
9 kHz to 150 kHz	200 Hz
150 kHz to 30 MHz	10 kHz

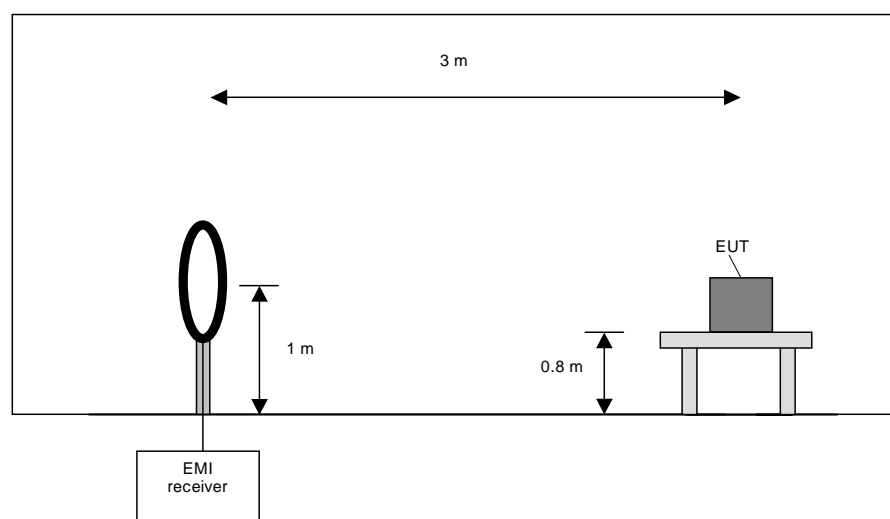

Preliminary measurement procedure:

Prescans were performed in the frequency range 9 kHz to 150 kHz and 150 kHz to 30 MHz.

The following procedure will be used:

- 1) Monitor the frequency range at horizontal polarisation and a EUT azimuth of 0 °.
- 2) Manipulate the system cables within the range to produce the maximum level of emission.
- 3) Rotate the EUT by 360 ° to maximize the detected signals.
- 4) Make a hardcopy of the spectrum.
- 5) Measure the frequencies of highest detected emission with a lower span and resolution bandwidth to increase the accuracy and note the frequency value.
- 6) Repeat steps 1) to 5) with the other orthogonal axes of the EUT (because of EUT is a module and might be used in a handheld equipment application).
- 7) Rotate the measuring antenna and repeat steps 1) to 5).

Final measurement (9 kHz to 30 MHz):

In the second stage a final measurement will be performed on an open area test site with no conducting ground plane in a measuring distances of 3 m, 10 m and 30 m. In the case where larger measuring distances are required the results will be extrapolated based on the values measured on the closer distances according to Section 15.31 (f) (2) [2]. The final measurement will be performed with a EMI Receiver set to Quasi Peak detector except for the frequency bands 9 kHz to 90 kHz and 110 kHz to 490 kHz where an average detector will be used according Section 15.209 (d) [2].

On the frequencies, which were detected during the preliminary measurements, the final measurement will be performed while rotating the EUT and the measuring antenna in the range of 0 ° to 360 ° around their vertical axis until the maximum value is found.

The resolution bandwidth of the EMI Receiver will be set to the following values:

Frequency range	Resolution bandwidth
9 kHz to 150 kHz	200 Hz
150 kHz to 30 MHz	9 kHz

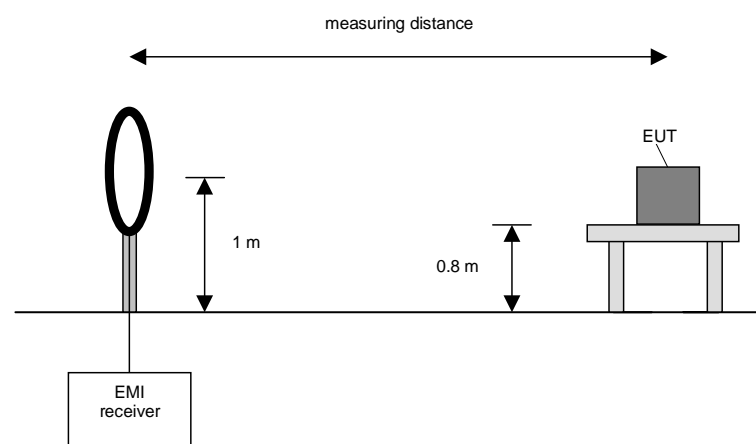

Final measurement procedure:

The following procedure will be used:

- 1) Monitor the frequency range with the measuring antenna at vertical orientation parallel to the EUT at an azimuth of 0 °.
- 2) Rotate the EUT by 360 ° to maximize the detected signals and note the azimuth and orientation.
- 3) Rotate the measuring antenna to find the maximum and note the value.
- 4) Rotate the measuring antenna and repeat steps 1) to 3) until the maximum value is found.
- 5) Repeat steps 1) to 4) with the other orthogonal axes of the EUT (if the EUT is a module and might be used in a handheld equipment application).

Preliminary measurement (30 MHz to 1 GHz)

In the first stage a preliminary measurement will be performed in a fully anechoic chamber with a measuring distance of 3 meter. Table top devices will set up on a non-conducting turn device on the height of 1.5m. Floor-standing devices will be placed directly on the turntable/ground plane. The set up of the Equipment under test will be in accordance to [1].

The frequency range 30 MHz to 1 GHz will be measured with an EMI Receiver set to MAX Hold mode and a resolution bandwidth of 100 kHz. The measurement will be performed in horizontal and vertical polarisation of the measuring antenna and while rotating the EUT in its vertical axis in the range of 0 ° to 360 °. This measurement is repeated after raising the EUT in 30° steps according 6.6.5.4 in [1].

The resolution bandwidth of the EMI Receiver will be set to the following values:

Frequency range	Resolution bandwidth
30 MHz to 230 MHz	100 kHz
230 MHz to 1 GHz	100 kHz

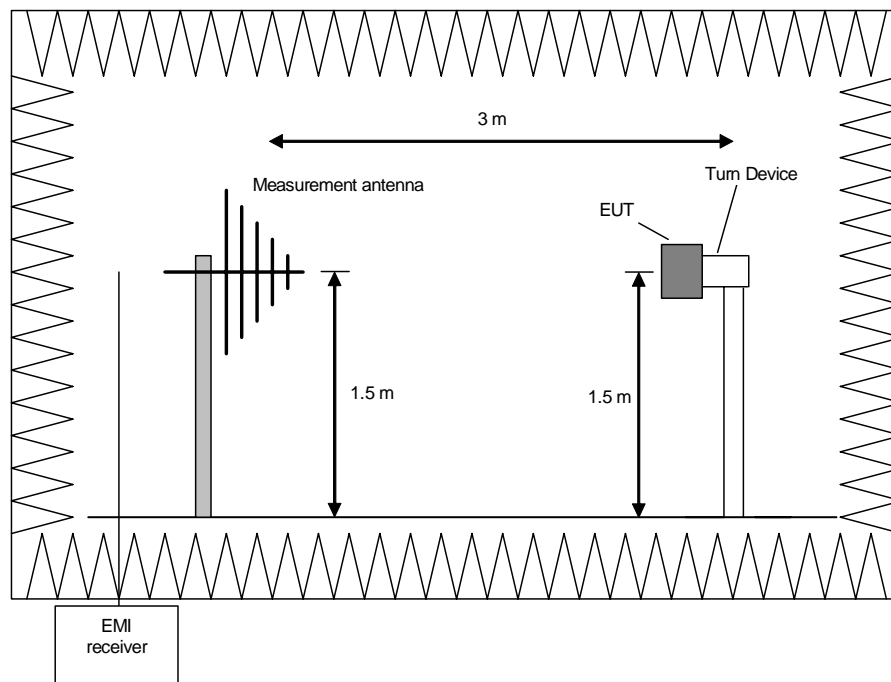

Procedure preliminary measurement:

Prescans were performed in the frequency range 30 MHz to 230 MHz and 230 MHz to 1 GHz.

The following procedure will be used:

1. Monitor the frequency range at horizontal polarisation and a EUT azimuth of 0 °.
2. Manipulate the system cables within the range to produce the maximum level of emission.
3. Rotate the EUT by 360 ° to maximize the detected signals.
4. Repeat 1) to 3) with the vertical polarisation of the measuring antenna.
5. Make a hardcopy of the spectrum.
6. Repeat 1) to 5) with the EUT raised by an angle of 30° (60°, 90°, 120° and 150°) according to 6.6.5.4 in [1].
7. Measure the frequency of the detected emissions with a lower span and resolution bandwidth to increase the accuracy and note the frequency value.

Final measurement (30 MHz to 1 GHz)

A final measurement on an open area test site will be performed on selected frequencies found in the preliminary measurement. During this test the EUT will be rotated in the range of 0 ° to 360 °, the measuring antenna will be set to horizontal and vertical polarisation and raised and lowered in the range from 1 m to 4 m to find the maximum level of emissions.

The resolution bandwidth of the EMI Receiver will be set to the following values:

Frequency range	Resolution bandwidth
30 MHz to 1 GHz	120 kHz

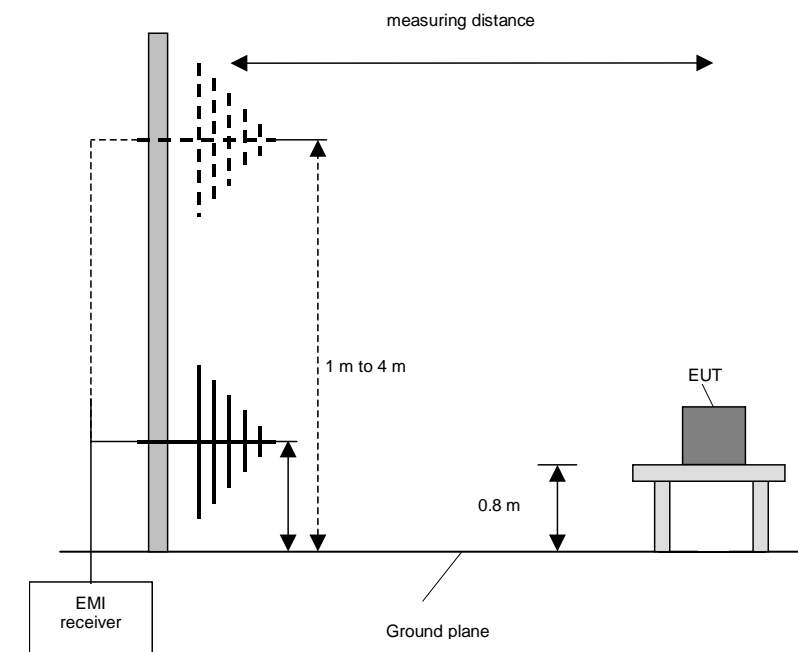

Procedure final measurement:

The following procedure will be used:

- 1) Measure on the selected frequencies at an antenna height of 1 m and a EUT azimuth of 23 °.
- 2) Move the antenna from 1 m to 4 m and note the maximum value at each frequency.
- 3) Rotate the EUT by 45 ° and repeat 2) until an azimuth of 337 ° is reached.
- 4) Repeat 1) to 3) for the other orthogonal antenna polarization.
- 5) Move the antenna and the turntable to the position where the maximum value is detected.
- 6) Measure while moving the antenna slowly +/- 1 m.
- 7) Set the antenna to the position where the maximum value is found.
- 8) Measure while moving the turntable +/- 45 °.
- 9) Set the turntable to the azimuth where the maximum value is found.
- 10) Measure with Final detector (QP and AV) and note the value.
- 11) Repeat 5) to 10) for each frequency.
- 12) Repeat 1) to 11) for each orthogonal axes of the EUT (because of EUT is a module and might be used in a handheld equipment application).

Preliminary and final measurement (1 GHz to 40 GHz)

This measurement will be performed in a fully anechoic chamber. Table top devices will set up on a non-conducting turn device on the height of 1.5m. The set-up of the Equipment under test will be in accordance to [1].

Preliminary measurement (1 GHz to 40 GHz)

The frequency range will be divided into different sub ranges depending of the frequency range of the used horn antenna. The spectrum analyser set to MAX Hold mode and a resolution bandwidth of 100 kHz. The measurement will be performed in horizontal and vertical polarisation of the measuring antenna and while rotating the EUT in its vertical axis in the range of 0 ° to 360 °. This measurement is repeated after raising the EUT in 30° steps according 6.6.5.4 in [1].

The resolution bandwidth of the EMI Receiver will be set to the following values:

Frequency range	Resolution bandwidth
1 GHz to 4 GHz	100 kHz
4 GHz to 12 GHz	100 kHz
12 GHz to 18 GHz	100 kHz
18 GHz to 25 / 26.5 GHz	100 kHz
26.5 GHz to 40 GHz	100 kHz

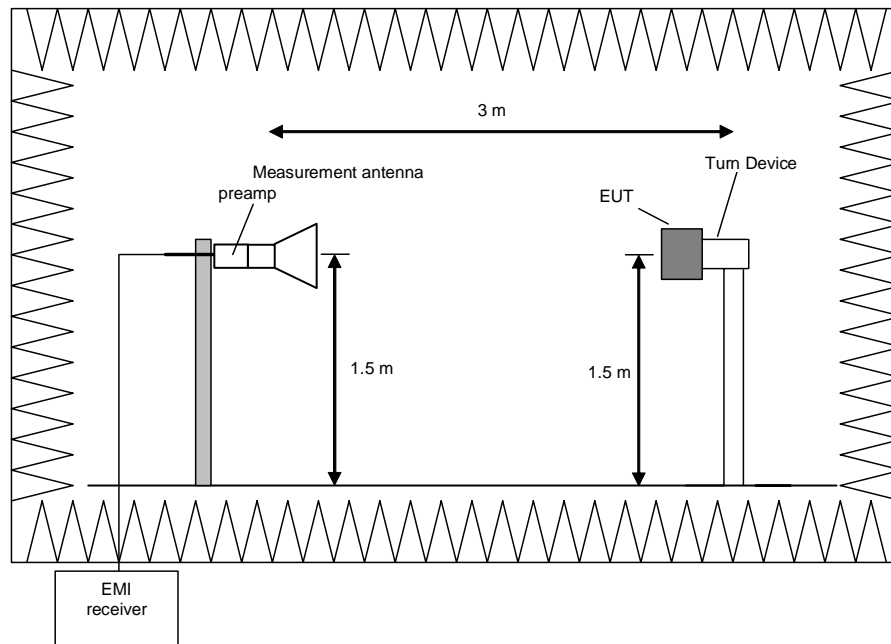

Procedure preliminary measurement:

Prescans were performed in the frequency range 1 to 40 GHz.

The following procedure will be used:

1. Monitor the frequency range at horizontal polarisation and a EUT azimuth of 0 °.
2. Rotate the EUT by 360° to maximize the detected signals.
3. Repeat 1) to 2) with the vertical polarisation of the measuring antenna.
4. Make a hardcopy of the spectrum.
5. Repeat 1) to 4) with the EUT raised by an angle of 30° (60°, 90°, 120° and 150°) according to 6.6.5.4 in [1].
6. Measure the frequency of the detected emissions with a lower span and resolution bandwidth to increase the accuracy and note the frequency value.
7. The measurement antenna polarisation, with the according EUT position (Turntable and Turn device) which produces the highest emission for each frequency will be used for the final measurement. The six closest values to the applicable limit will be used for the final measurement.

Final measurement (1 GHz to 40 GHz)

The frequency range will be divided into different sub ranges depending of the frequency range of the used horn antenna. The EMI Receiver set to peak and average mode and a resolution bandwidth of 1 MHz. The measurement will be performed by rotating the turntable through 0 to 360° in the worst-case EUT orientation which was obtained during the preliminary measurements.

The resolution bandwidth of the EMI Receiver will be set to the following values:

Frequency range	Resolution bandwidth
1 GHz to 4 GHz	1 MHz
4 GHz to 12 GHz	1 MHz
12 GHz to 18 GHz	1 MHz
18 GHz to 25 / 26.5 GHz	1 MHz
26.5 GHz to 40 GHz	1 MHz

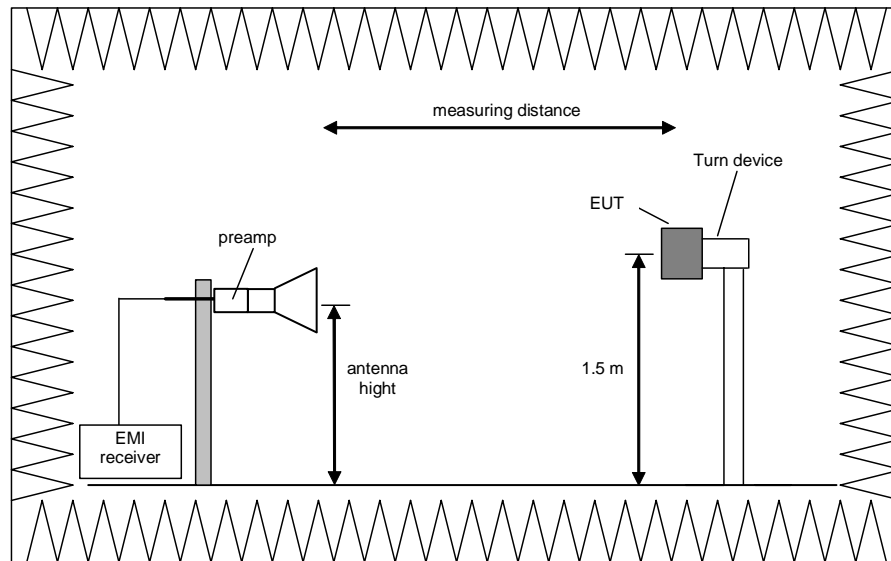

Procedure of measurement:

The measurements were performed in the frequency ranges 1 GHz to 4 GHz, 4 GHz to 12 GHz, 12 GHz to 18 GHz, 18 GHz to 26.5 GHz and 26.5 – 40 GHz.

The following procedure will be used:

- 1) Set the turntable and the turn device to obtain the worst-case emission for the first frequency identified in the preliminary measurements.
- 2) Set the measurement antenna polarisation to the orientation with the highest emission for the first frequency identified in the preliminary measurements.
- 3) Set the spectrum analyser to EMI mode with peak and average detector activated.
- 4) Rotate the turntable from 0° to 360° to find the EUT angle that produces the highest emissions.
- 5) Note the highest displayed peak and average values
- 6) Repeat the steps 1) to 5) for each frequency detected during the preliminary measurements.

5.6.2 Test results (radiated emissions) – antenna and cabinet emissions

5.6.2.1 Preliminary radiated emission measurement

Ambient temperature	21 °C	Relative humidity	40 %
---------------------	-------	-------------------	------

- Position of EUT:** The EUT was set-up on a non-conducting table of a height of 0.8 m and on a turn device on a height of 1.5 m. The distance between EUT and antenna was 3 m.
- Cable guide:** For detail information of test set-up and the cable guide refer to the pictures in Annex A.
- Test record:** All results are shown in the following.
- Supply voltage:** During all measurements the host of the EUT was powered with 3.3 V via an AC/DC Adapter.
- Remark:** The lowest internal frequency of the EUT is 40 MHz, therefore only emissions starting from 30 MHz were measured for this test report.
- Only the plots of the worst case emissions are submitted for every frequency range above 1 GHz in the preliminary results.
- The Emissions below 1 GHz were equal for all transmit frequencies, modulation schemes and data rates. Therefore only the results of an exemplary test case are submitted below.

EK037_SpurEm30M-1G_ch6_13M_Pos3.wmf: Spurious emissions from 30 MHz to 1 GHz:

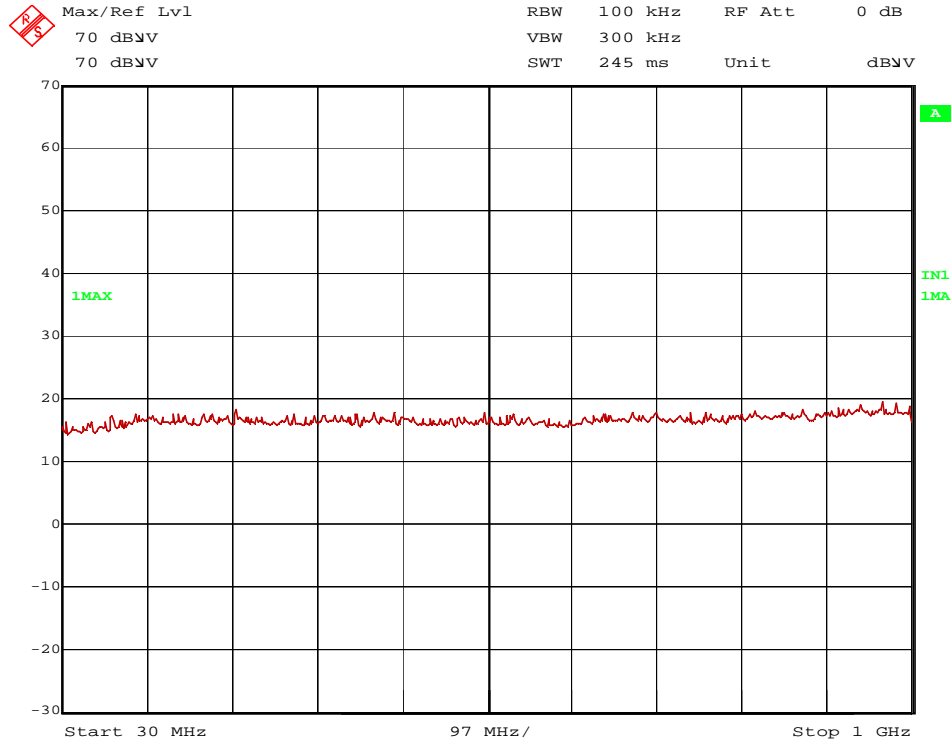

EK037_SpurEm12-18G_ch11_9M_Pos2_Ver.wmf: Spurious emissions from 12 to 18 GHz
Vertical antenna polarization (operation mode 6):

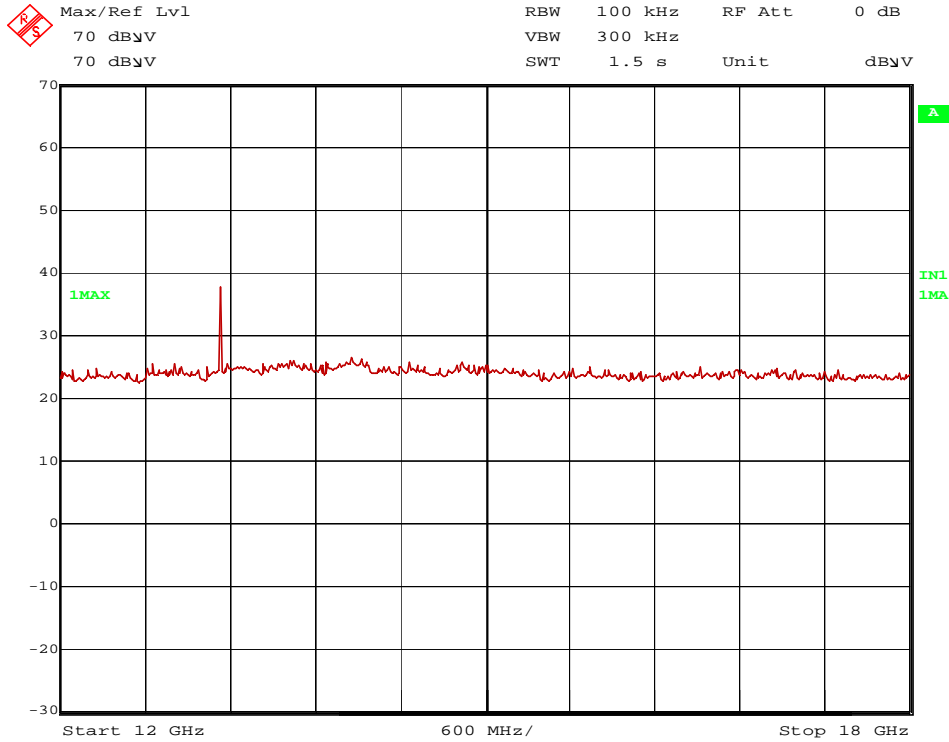

EK037_SpurEm18-25G_ch11_13M_Pos2_Hor.wmf: Spurious emissions from 18 – 25 GHz
Horizontal antenna polarization (operation mode 6):

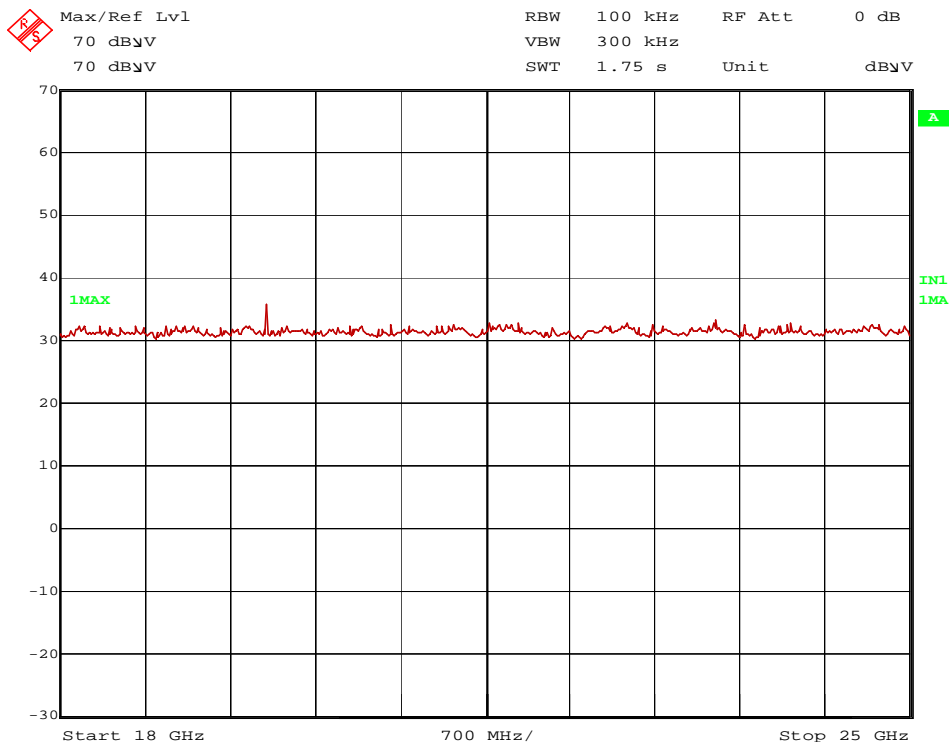

The following frequencies were found inside the restricted bands during the preliminary radiated emission test:

- 4103.4 MHz and 19696.4 MHz.

The following frequencies were found outside the restricted bands during the preliminary radiated emission test:

- 6565.5 MHz and 13130.4 MHz.

These frequencies have to be measured in a final measurement. The results are presented in the following.

TEST EQUIPMENT USED FOR THE TEST:
5, 6, 8 – 15, 17 – 24, 33

5.6.2.2 Final radiated emission measurement (9 kHz to 1 GHz)

No emissions were found during the preliminary measurement. Therefore no results for the final measurements are submitted.

5.6.2.3 Final radiated emission measurement (1 GHz to 25 GHz)

Ambient temperature	21 °C	Relative humidity	40 %
---------------------	-------	-------------------	------

Position of EUT: The EUT was set-up on a non-conducting table of a height of 0.8 m. The distance between EUT and antenna was 3 m.

Cable guide: For detail information of test set-up and the cable guide refer to the pictures in annex A of this test report.

Test record: All results are shown in the following.

Supply voltage: During all measurements the host of the EUT was powered with 3.3 V via an laboratory power supply.

Resolution bandwidth: For all measurements a resolution bandwidth of 1 MHz was used.

Additional information: For simplification all values were compared to the restricted band limits. All Emissions were measured in the EUT angle that had the highest spurious emissions. All average results are corrected by a correction factor of 0.6 dB as described in 5.1.2.

Transmitter operates at the lower end of the assigned frequency band (operation mode 1)

Result measured with the peak detector:

Frequency MHz	Meas. Result dB μ V/m	Limit dB μ V/m	Margin dB	Readings dB μ V	Antenna factor 1/m	Preamp dB	Cable loss dB	Height cm	Pol.
4019.7	52.8	74.0	21.2	41.6	32.5	26.1	4.8	150	Hor.
4824.0	48.6	74.0	25.4	36.3	32.6	25.6	5.3	150	Hor.
6432.0	53.0	74.0	21.0	37.7	34.3	25.2	6.3	150	Ver.
12864.3	51.2	74.0	22.8	41.1	33.6	26.0	2.5	150	Ver.
19296.4	44.8	74.0	29.0	43.4	37.1	38.2	2.5	150	Ver.
Measurement uncertainty				+2.2 dB / -3.6 dB					

Result measured with the average detector:

Frequency MHz	Meas. Result dB μ V/m	Limit dB μ V/m	Margin dB	Readings dB μ V	Antenna factor 1/m	Preamp dB	Cable loss dB	Height cm	Pol.
4019.7	44.5	54.0	9.5	32.2	32.5	26.1	4.8	150	Hor.
4824.0	36.4	54.0	17.6	23.0	32.6	25.6	5.3	150	Hor.
6432.0	44.6	54.0	9.4	28.2	34.3	25.2	6.3	150	Ver.
12864.3	47.9	54.0	6.1	36.7	33.6	26.0	2.5	150	Ver.
19296.4	37.4	54.0	16.6	35.4	37.1	38.2	2.5	150	Ver.
Measurement uncertainty				+2.2 dB / -3.6 dB					

Transmitter operates at the middle of the assigned frequency band (operation mode 2)

Result measured with the peak detector:

Frequency MHz	Meas. Result dB μ V/m	Limit dB μ V/m	Margin dB	Readings dB μ V	Antenna factor 1/m	Preamp dB	Cable loss dB	Height cm	Pol.
4061.8	53.0	74.0	21.0	42.0	32.3	26.1	4.8	150	Hor.
4874.0	50.2	74.0	23.8	37.9	32.7	25.6	5.2	150	Hor.
5682.0	48.5	74.0	25.5	34.0	33.8	25.2	5.9	150	Hor.
6498.9	52.5	74.0	21.5	37.2	34.2	25.2	6.3	150	Hor.
12998.0	54.1	74.0	19.9	43.8	33.6	26.5	3.2	150	Hor.
19496.0	50.5	74.0	23.5	42.4	37.1	37.5	8.6	150	Ver.
Measurement uncertainty				+2.2 dB / -3.6 dB					

Result measured with the average detector:

Frequency MHz	Meas. Result dB μ V/m	Limit dB μ V/m	Margin dB	Readings dB μ V	Antenna factor 1/m	Preamp dB	Cable loss dB	Height cm	Pol.
4061.8	43.1	54.0	10.9	31.0	32.3	26.1	4.8	150	Hor.
4874.0	38.3	54.0	15.7	24.8	32.7	25.6	5.2	150	Hor.
5682.0	37.6	54.0	16.4	22.0	33.8	25.2	5.9	150	Hor.
6498.9	43.8	54.0	10.2	27.4	34.2	25.2	6.3	150	Hor.
12998.0	45.6	54.0	8.4	34.2	33.6	26.5	3.2	150	Hor.
19496.0	41.0	54.0	13.0	31.7	37.1	37.5	8.6	150	Ver.
Measurement uncertainty				+2.2 dB / -3.6 dB					

Transmitter operates at the upper end of the assigned frequency band (operation mode 3)

Result measured with the peak detector:

Frequency MHz	Meas. Result dB μ V/m	Limit dB μ V/m	Margin dB	Readings dB μ V	Antenna factor 1/m	Preamp dB	Cable loss dB	Height cm	Pol.
4103.4	52.2	74.0	21.8	41.4	32.2	26.1	4.8	150	Hor.
4924.0	49.1	74.0	24.9	36.6	32.8	25.6	5.3	150	Hor.
5745.9	48.4	74.0	25.6	33.9	33.8	25.2	5.9	150	Hor.
6565.5	53.3	74.0	20.7	37.2	34.5	24.7	6.3	150	Hor.
13130.9	51.2	74.0	22.8	41.1	33.6	26.0	2.5	150	Ver.
19696.4	46.5	74.0	27.5	45.2	37.1	38.3	2.5	150	Hor.
Measurement uncertainty				+2.2 dB / -3.6 dB					

Result measured with the average detector:

Frequency MHz	Meas. Result dB μ V/m	Limit dB μ V/m	Margin dB	Readings dB μ V	Antenna factor 1/m	Preamp dB	Cable loss dB	Height cm	Pol.
4103.4	43.6	54.0	10.4	31.6	32.2	26.1	4.8	150	Hor.
4924.0	38.0	54.0	16.0	24.4	32.8	25.6	5.3	150	Hor.
5745.9	38.1	54.0	15.9	22.5	33.8	25.2	5.9	150	Hor.
6565.5	45.7	54.0	8.3	28.5	34.5	24.7	6.3	150	Hor.
13130.9	48.2	54.0	5.8	37.0	33.6	26.0	2.5	150	Ver.
19696.4	41.2	54.0	12.8	38.8	37.1	38.3	2.5	150	Hor.
Measurement uncertainty				+2.2 dB / -3.6 dB					

Transmitter operates at the lower end of the assigned frequency band (operation mode 4)

Result measured with the peak detector:

Frequency MHz	Meas. Result dB μ V/m	Limit dB μ V/m	Margin dB	Readings dB μ V	Antenna factor 1/m	Preamp dB	Cable loss dB	Height cm	Pol.
4019.7	48.5	74.0	25.5	37.3	32.5	26.1	4.8	150	Hor.
4824.0	46.6	74.0	27.4	34.3	32.6	25.6	5.3	150	Hor.
6432.0	52.1	74.0	21.9	36.7	34.3	25.2	6.3	150	Hor.
12864.3	51.0	74.0	23.1	40.9	33.6	26.0	2.5	150	Ver.
19296.4	42.9	74.0	31.1	41.5	37.1	38.2	2.5	150	Hor.
Measurement uncertainty				+2.2 dB / -3.6 dB					

Result measured with the average detector:

Frequency MHz	Meas. Result dB μ V/m	Limit dB μ V/m	Margin dB	Readings dB μ V	Antenna factor 1/m	Preamp dB	Cable loss dB	Height cm	Pol.
4019.7	39.4	54.0	14.6	27.2	32.5	26.1	4.8	150	Hor.
4824.0	34.6	54.0	19.4	21.3	32.6	25.6	5.3	150	Hor.
6432.0	43.8	54.0	10.2	27.3	34.3	25.2	6.3	150	Hor.
12864.3	48.3	54.0	5.7	37.1	33.6	26.0	2.5	150	Ver.
19296.4	33.4	54.0	20.6	30.9	37.1	38.2	2.5	150	Hor.
Measurement uncertainty				+2.2 dB / -3.6 dB					

Transmitter operates at the middle of the assigned frequency band (operation mode 5)

Result measured with the peak detector:

Frequency MHz	Meas. Result dB μ V/m	Limit dB μ V/m	Margin dB	Readings dB μ V	Antenna factor 1/m	Preamp dB	Cable loss dB	Height cm	Pol.
4061.8	49.8	74.0	24.3	38.7	32.3	26.1	4.8	150	Hor.
4874.0	48.0	74.0	26.0	35.7	32.7	25.6	5.2	150	Hor.
5682.0	51.1	74.0	22.9	36.6	33.8	25.2	5.9	150	Hor.
6498.9	52.4	74.0	21.6	37.1	34.2	25.2	6.3	150	Hor.
12998.0	53.4	74.0	20.6	43.1	33.6	26.5	3.2	150	Hor.
Measurement uncertainty				+2.2 dB / -3.6 dB					

Result measured with the average detector:

Frequency MHz	Meas. Result dB μ V/m	Limit dB μ V/m	Margin dB	Readings dB μ V	Antenna factor 1/m	Preamp dB	Cable loss dB	Height cm	Pol.
4061.8	39.2	54.0	14.8	27.1	32.3	26.1	4.8	150	Hor.
4874.0	35.5	54.0	18.5	22.1	32.7	25.6	5.2	150	Hor.
5682.0	38.6	54.0	15.4	23.0	33.8	25.2	5.9	150	Hor.
6498.9	44.0	54.0	10.0	27.6	34.2	25.2	6.3	150	Hor.
12998.0	46.5	54.0	7.5	35.1	33.6	26.5	3.2	150	Hor.
Measurement uncertainty				+2.2 dB / -3.6 dB					

Transmitter operates at the upper end of the assigned frequency band (operation mode 6)

Result measured with the peak detector:

Frequency MHz	Meas. Result dB μ V/m	Limit dB μ V/m	Margin dB	Readings dB μ V	Antenna factor 1/m	Preamp dB	Cable loss dB	Height cm	Pol.
4103.4	48.9	74.0	25.1	38.0	32.2	26.1	4.8	150	Hor.
6565.5	53.9	74.0	20.1	37.8	34.5	24.7	6.3	150	Hor.
13130.9	51.1	74.0	22.9	41.0	33.6	26.0	2.5	150	Ver.
19696.4	44.4	74.0	29.6	43.1	37.1	38.3	2.5	150	Hor.
Measurement uncertainty				+2.2 dB / -3.6 dB					

Result measured with the average detector:

Frequency MHz	Meas. Result dB μ V/m	Limit dB μ V/m	Margin dB	Readings dB μ V	Antenna factor 1/m	Preamp dB	Cable loss dB	Height cm	Pol.
4103.4	39.0	54.0	15.0	27.0	32.2	26.1	4.8	150	Hor.
6565.5	45.6	54.0	8.4	28.4	34.5	24.7	6.3	150	Hor.
13130.9	48.7	54.0	5.4	37.5	33.6	26.0	2.5	150	Ver.
19696.4	38.3	54.0	15.7	35.9	37.1	38.3	2.5	150	Hor.
Measurement uncertainty				+2.2 dB / -3.6 dB					

Transmitter operates at the lower end of the assigned frequency band (operation mode 7)

Result measured with the peak detector:

Frequency MHz	Meas. Result dB μ V/m	Limit dB μ V/m	Margin dB	Readings dB μ V	Antenna factor 1/m	Preamp dB	Cable loss dB	Height cm	Pol.
4019.7	48.0	74.0	26.0	36.8	32.5	26.1	4.8	150	Hor.
4824.0	49.1	74.0	24.9	36.8	32.6	25.6	5.3	150	Ver.
6432.0	52.2	74.0	21.8	36.8	34.3	25.2	6.3	150	Hor.
12864.3	51.2	74.0	22.8	41.1	33.6	26.0	2.5	150	Ver.
19296.4	43.4	74.0	30.6	42.0	37.1	38.2	2.5	150	Ver.
Measurement uncertainty				+2.2 dB / -3.6 dB					

Result measured with the average detector:

Frequency MHz	Meas. Result dB μ V/m	Limit dB μ V/m	Margin dB	Readings dB μ V	Antenna factor 1/m	Preamp dB	Cable loss dB	Height cm	Pol.
4019.7	39.0	54.0	15.0	26.7	32.5	26.1	4.8	150	Hor.
4824.0	34.1	54.0	19.9	20.8	32.6	25.6	5.3	150	Hor.
6432.0	43.7	54.0	10.3	27.3	34.3	25.2	6.3	150	Hor.
12864.3	48.2	54.0	5.8	37.0	33.6	26.0	2.5	150	Ver.
19296.4	35.8	54.0	18.2	33.3	37.1	38.2	2.5	150	Ver.
Measurement uncertainty				+2.2 dB / -3.6 dB					

Transmitter operates at the middle of the assigned frequency band (operation mode 8)

Result measured with the peak detector:

Frequency MHz	Meas. Result dB μ V/m	Limit dB μ V/m	Margin dB	Readings dB μ V	Antenna factor 1/m	Preamp dB	Cable loss dB	Height cm	Pol.
4061.8	48.7	74.0	25.3	37.7	32.3	26.1	4.8	150	Hor.
4874.0	47.1	74.0	26.9	34.8	32.7	25.6	5.2	150	Hor.
5682.0	50.7	74.0	23.3	36.2	33.8	25.2	5.9	150	Hor.
6498.9	52.3	74.0	21.8	37.0	34.2	25.2	6.3	150	Hor.
12998.0	54.2	74.0	19.8	43.9	33.6	26.5	3.2	150	Vert.
19496.0	50.5	74.0	23.5	42.4	37.1	37.5	8.6	150	Vert.
Measurement uncertainty				+2.2 dB / -3.6 dB					

Result measured with the average detector:

Frequency MHz	Meas. Result dB μ V/m	Limit dB μ V/m	Margin dB	Readings dB μ V	Antenna factor 1/m	Preamp dB	Cable loss dB	Height cm	Pol.
4061.8	38.4	54.0	15.6	26.3	32.3	26.1	4.8	150	Hor.
4874.0	35.1	54.0	18.9	21.7	32.7	25.6	5.2	150	Hor.
5682.0	37.9	54.0	16.1	22.3	33.8	25.2	5.9	150	Hor.
6498.9	43.8	54.0	10.2	27.4	34.2	25.2	6.3	150	Hor.
12998.0	45.5	54.0	8.5	34.1	33.6	26.5	3.2	150	Vert.
19496.0	41.0	54.0	13.0	31.7	37.1	37.5	8.6	150	Vert.
Measurement uncertainty				+2.2 dB / -3.6 dB					

Transmitter operates at the upper end of the assigned frequency band (operation mode 9)

Result measured with the peak detector:

Frequency MHz	Meas. Result dB μ V/m	Limit dB μ V/m	Margin dB	Readings dB μ V	Antenna factor 1/m	Preamp dB	Cable loss dB	Height cm	Pol.
4103.4	47.8	74.0	26.2	37.0	32.2	26.1	4.8	150	Hor.
6565.5	52.8	74.0	21.2	36.7	34.5	24.7	6.3	150	Hor.
13130.9	51.6	74.0	22.4	41.5	33.6	26.0	2.5	150	Ver.
19696.4	44.7	74.0	29.3	43.4	37.1	38.3	2.5	150	Hor.
Measurement uncertainty				+2.2 dB / -3.6 dB					

Result measured with the average detector:

Frequency MHz	Meas. Result dB μ V/m	Limit dB μ V/m	Margin dB	Readings dB μ V	Antenna factor 1/m	Preamp dB	Cable loss dB	Height cm	Pol.
4103.4	36.0	54.0	17.2	25.9	32.2	26.1	4.8	150	Hor.
6565.5	43.6	54.0	9.6	28.3	34.5	24.7	6.3	150	Hor.
13130.9	46.7	54.0	6.6	37.4	33.6	26.0	2.5	150	Ver.
19696.4	36.6	54.0	16.6	36.1	37.1	38.3	2.5	150	Hor.
Measurement uncertainty				+2.2 dB / -3.6 dB					

Test: Passed

TEST EQUIPMENT USED FOR THE TEST:
--

5. 6, 8 - 15,17-25, 29, 32, 33

5.7 Conducted emissions on power supply lines (150 kHz to 30 MHz)

5.7.1 Method of measurement

This test will be carried out in a shielded chamber. Tabletop devices will set up on a non-conducting support with a size of 1 m by 1.5 m and a height of 80 cm above the ground plane. Floor-standing devices will be placed directly on the ground plane. The setup of the Equipment under test will be in accordance to ANSI C63.4-2009 [6].

The frequency range 150 kHz to 30 MHz will be measured with an EMI Receiver set to MAX Hold mode with peak and average detector and a resolution bandwidth of 9 kHz. A scan will be carried out on the phase (or plus pole in case of DC powered devices) of the AC mains network. If levels detected 10 dB below the appropriate limit, this emission will be measured with the average and quasi-peak detector on all lines.

Frequency range	Resolution bandwidth
150 kHz to 30 MHz	9 kHz

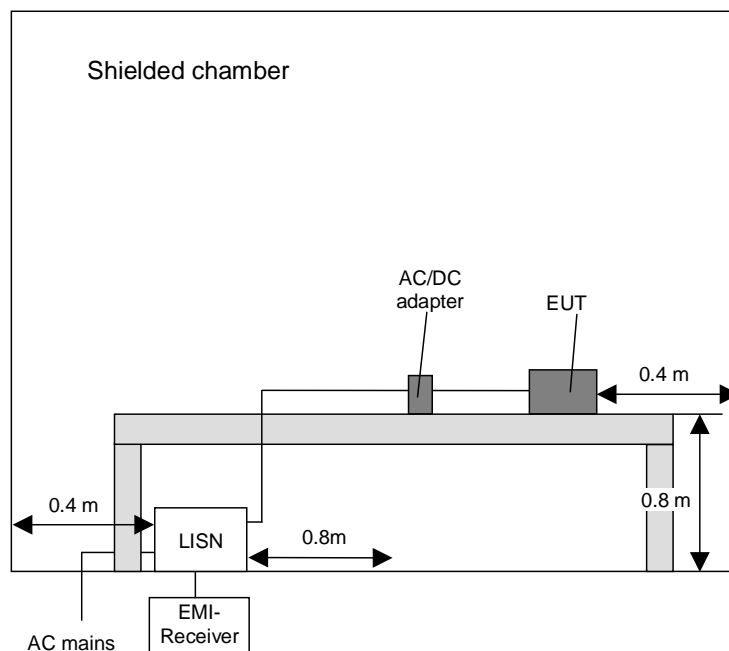

5.7.2 Test results (conducted emissions on power supply lines)

Ambient temperature	22 °C	Relative humidity	44 %
---------------------	-------	-------------------	------

Position of EUT: For the test the EUT was connected with a WLAN Router via wireless interface. The EUT was set to retransmit packets that were send from the WLAN router. The EUT was set-up on a non-conducting table of a height of 0.8 m.

Cable guide: For detail information of test set-up and the cable guide refer to the pictures in annex A of this test report.

Test record: All results are shown in the following.

Supply voltage: Measurement performed with US 120V/60Hz. For the test a laboratory power supply with a power of 3.3 V DC was used.

The curves in the diagram only represent for each frequency point the maximum measured value of all preliminary measurements. which were made for each power supply line. The top-measured curve represents the peak measurement and the bottom-measured curve the average measurement. The quasi-peak measured points are marked by an x and the average measured points by an +.

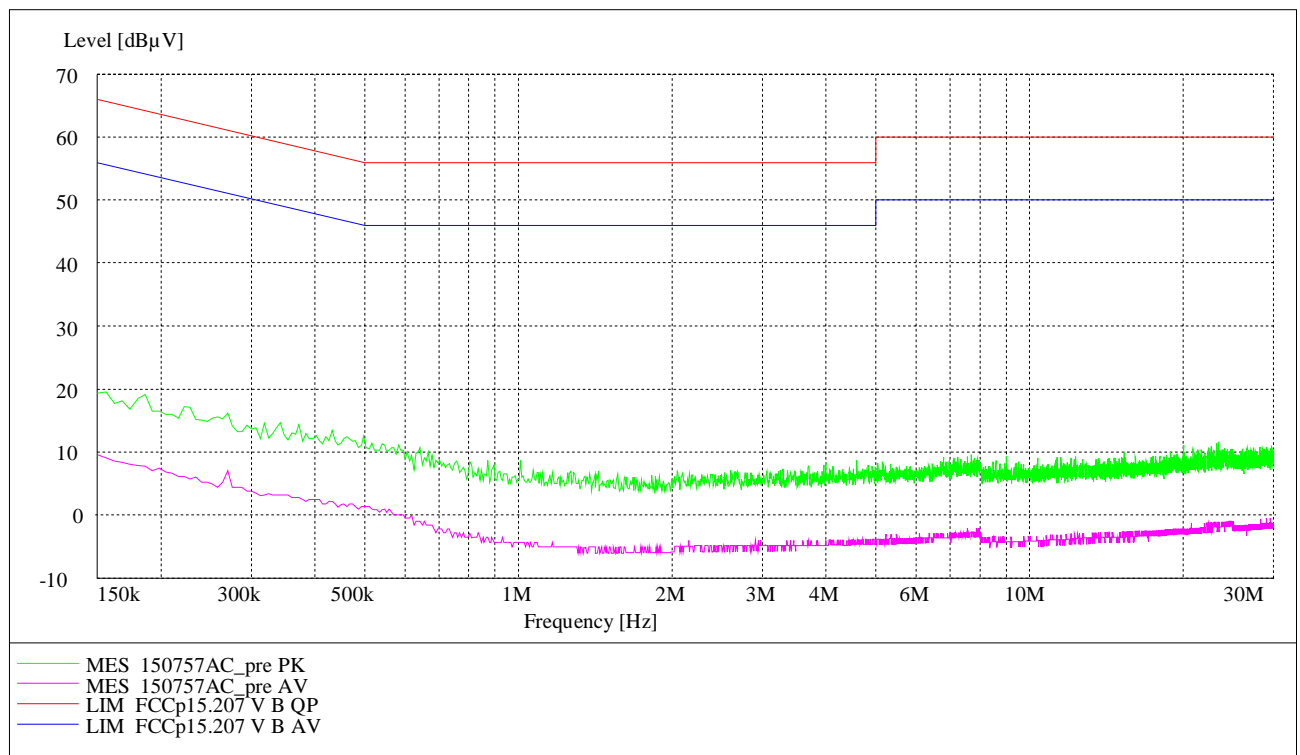

Data record name: 150757AC

Test: Passed

TEST EQUIPMENT USED FOR THE TEST:
1 – 5, 32

6 TEST EQUIPMENT AND ANCILLARIES USED FOR TESTS

No.	Test equipment	Type	Manufacturer	Serial No.	PM. No.	Cal. Date	Cal. Due
1	Shielded chamber M47	-	Albatross Projects	B83117-C6439-T262 -	480662	Weekly verification (system cal.)	
2	EMI Receiver	ESIB 26	Rohde & Schwarz	1088.7490	481182	03/21/2014	03/2016
3	LISN	NSLK8128	Schwarzbeck	8128155	480058	21/03/2014	03/2016
4	High pass filter	HR 0.13- 5ENN	FSY Microwave Inc.	DC 0109 SN 002	480340	Weekly verification (system cal.)	
5	EMI Software	ES-K1	Rohde & Schwarz	-	480111	-	-
6	Fully anechoic chamber M20	-	Albatross Projects	B83107-E2439-T232	480303	Weekly verification (system cal.)	
7	Spectrum analyser	FSU	Rohde & Schwarz	200125	480956	02/24/2014	03/2015
8	Measuring receiver	ESI 40	Rohde & Schwarz	100064	480355	02/26/2014	02/2016
9	Controller	MCU	Maturo	MCU/043/971107	480832	-	-
10	Turntable	DS420HE	Deisel	420/620/80	480315	-	-
11	Antenna support	AS615P	Deisel	615/310	480187	-	-
12	Antenna	CBL6112 B	Chase	2688	480328	04/14/2014	04/2017
13	Antenna	3115 A	EMCO	9609-4918	480183	11/2014	11/2017
14	Standard Gain Horn 11.9 GHz – 18 GHz	18240-20	Flann Microwave	483	480294	Six month verification (system cal.)	
15	Standard Gain Horn 17.9 GHz – 26.7 GHz	20240-20	Flann Microwave	411	480297	Six month verification (system cal.)	
16	Standard Gain Horn Antenne 26.4 – 40.1 GHz	22240-20	Flann Microwave	469	480229	Six month verification (system cal.)	
17	RF-cable No. 3	Sucoflex 106B	Huber&Suhner	0563/6B / Kabel 3	480670	Weekly verification (system cal.)	
18	RF-cable No. 40	Sucoflex 106B	Huber&Suhner	0708/6B / Kabel 40	481330	Weekly verification (system cal.)	
19	RF-cable No. 36	Sucoflex 106B	Huber&Suhner	500003/6B / Kabel 36-	481680	Weekly verification (system cal.)	
20	RF-cable 1 m	KPS-1533- 400-KPS	Insulated Wire	-	480300	Six month verification (system cal.)	
21	RF-cable 2 m	KPS-1533- 800-KPS	Insulated Wire	-	480302	Six month verification (system cal.)	
22	Preamplifier	JS3- 00101200- 23-5A	Miteq	681851	480337	Six month verification (system cal.)	
23	Preamplifier	JS3- 12001800- 16-5A	Miteq	571667	480343	Six month verification (system cal.)	
24	Preamplifier	JS3- 18002600- 20-5A	Miteq	658697	480342	Six month verification (system cal.)	
25	Loop antenna	HFH2-Z2	Rohde & Schwarz	832609/014	480059	02/2014	02/2016
26	Power Meter	NRVD	Rohde & Schwarz	833697/030	480589	07/2013	07/2015
27	Peak Power Sensor	NRV-Z32	Rohde & Schwarz	849745/016	480551	07/2013	07/2015
28	4 GHz High Pass Filter	WHKX4.0/18 G-8SS	Wainwright Instruments	1	480587	Weekly verification (system cal.)	

29	Single Control Unit	SCU	Maturo GmbH	SCU/006/971107	480831	Calibration not necessary	
30	High-pass Filter	H26G40G1	Microwave Circuits, Inc.	33471	480593	Six month verification (system cal.)	
31	Temperature Test Chamber	MK 240	Binder	05-79022	480462	02/18/2014	08/2015
32	Multimeter	Fluke 175	Fluke Deutschland GmbH	18660318	481515	10/2014	10/2016
33	Turn Device	TDF 1.5-10Kg	Maturo	-	482034	-	

