

Wall mounted DMX512 Master SR-2812Wi(US)



Feature

- 1 zone
- Touch sensitive
- Suitable for USA market
- Glass interface(White & Black)
- Save color and mode function
- RF WIFI

Parameter

Part No.	Operation Voltage	OUTPUT	DIMENSIONS ø/h (mm)
SR-2812Wi(US)	12VDC	WIFI	120x75x29.1

Product Size

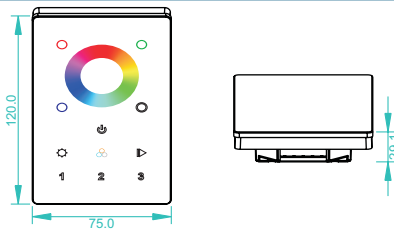

Installation

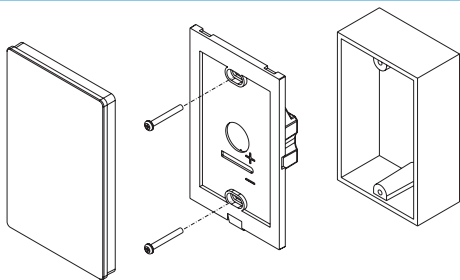





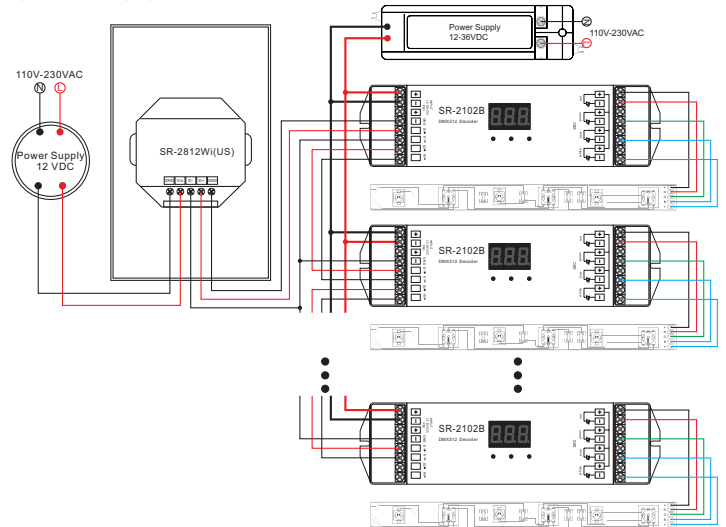







Wiring diagram

1)DMX SR-2812(US) with DMX decoder



Operation

-  Play & pause button. There is only 1 build-in mode. When you touch  button, it will run. Long press  speed up, long press  again speed down.
-  Brightness
-  Button can save the three color from mode or save color when you touch color wheel. When you press  this button, 1 build-in mode will run, if now you see a favorite mode, then you can press "S" button for 5 seconds until connected lighting flashes. Then it saved successfully. When you touch  color wheel, if you touch a favorite color on it, then you want to save it, then you press "S" button for 5 seconds until the connected lighting flashes. Then it saved successfully.
-  For Warm white, Natural white, Cool white changing. (Through the three RGB color mixing)
-  Touching wheels  Switch off and on, long press means default setting
-  Short press means switch on and off for each channel. 1st Long press means brightness+, 2nd Long press means brightness—.

At the corner of the panel there is a signal light, Blue means on, Red means off

Safety & Warnings

- 1) The product shall be installed and serviced by a qualified person.
- 2) IP20. Please avoid the sun and rain. When installed outdoors, please ensure it is mounted in a water proof enclosure.
- 3) Always be sure to mount this unit in an area with proper ventilation to avoid overheating.
- 4) Please check if the output voltage of any LED power supplies used comply with the working voltage of the product.
- 5) Never connect any cables while power is on and always assure correct connections to avoid short circuits before switching on.
- 6) Please ensure that the cable is secured tightly in the connector
- 7) For update information please consult your supplier.

Warranty Agreement

- 1) We provide lifelong technical assistance with this product:
 - 3-year warranty. We print date on every products, for example :1125 means year 2011, week 25. The warranty is for free repair or replacement and covers manufacturing faults only.
 - For faults beyond the 3-year warranty we reserve the right to charge for time and parts.
- 2) Limited Warranty
 - Any defects caused by wrong operation.
 - Any damages caused by unauthorized removal, maintenance, modifying, incorrect connection and replacement of chips.
 - Any damages due to transportation, vibration etc. after purchase.
 - Any damages caused by earthquake, fire, lightning, pollution and abnormal voltage.
 - Any damages caused by negligence, inappropriate storing at high temperatures and humidity or near harmful chemicals.
 - Product has been updated
- 3) Repair or replacement as provided under this warranty is the exclusive remedy to the customer.

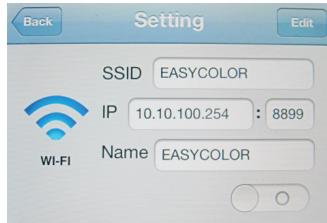

Wifi

IOS or android system connection to the SR-2812Wi(US)



a. Download app to phone. Open wifi connection setting interface, connect your phone to EASYCOLOR or Realcolor network.

b. Open EASYCOLOR installed on the phone, press  to the setting interface, and enter the following:
 SSID: EASYCOLOR
 IP: 10.10.100.254 | 8899
 Name: (the name you want or don't enter anything.)

c. Press button  to turn it on, and press button  to back to the main operation interface.

the app is 8 zone control, so you may set more zones for the WiFi control as below:

- DMX decoder's address 001 is controlled by Zone 1
- DMX decoder's address 005 is controlled by Zone 2
- DMX decoder's address 009 is controlled by Zone 3
- DMX decoder's address 013 is controlled by Zone 4
- DMX decoder's address 017 is controlled by Zone 5
- DMX decoder's address 021 is controlled by Zone 6
- DMX decoder's address 025 is controlled by Zone 7
- DMX decoder's address 029 is controlled by Zone 8

FCC Certification Requirements

Caution: Any changes or modifications in construction of this device which are not expressly approved by the party responsible for compliance could void the user's authority to operate the equipment.

This device complies with part 15 of the FCC Rules. Operation is subject to the following two conditions: (1) This device may not cause harmful interference, and (2) This device must accept any interference received, including interference that may cause undesired operation.

The manufacturer is not responsible for any radio or TV interference caused by unauthorized modifications to this equipment. Such modifications could void the user's authority to operate the equipment.

This equipment has been tested and found to comply with the limits for a Class B digital device, pursuant to Part 15 of the FCC Rules. These limits are designed to provide reasonable protection against harmful interference in a residential installation. This equipment generates, uses and can radiate radio frequency energy and, if not installed and used in accordance with the instructions, may cause harmful interference to radio communications. However, there is no guarantee that interference will not occur in a particular installation. If this equipment does cause harmful interference to radio or television reception, which can be determined by turning the equipment off and on, the user is encouraged to try to correct the interference by one or more of the following measures:

- Reorient or relocate the receiving antenna.
- Increase the separation between the equipment and receiver.
- Connect the equipment into an outlet on a circuit different from that to which the receiver is connected.

Consult the dealer or an experienced radio/TV technician for help.

The antenna(s) used for this transmitter must be installed to provide a separation distance of at least 20 cm from all persons.