

# FCC Test Report

## (WLAN UNII-2A / UNII-2C Band)

**Report No.:** RF170421E06A-1

**FCC ID:** 2ACTO-APX740

**Test Model:** APX 740

**Received Date:** Apr. 21, 2017

**Test Date:** May 18 to June 22, 2017

**Issued Date:** Oct. 13, 2017

**Applicant:** Sophos Ltd

**Address:** The Pentagon, Abingdon Science Park, Abingdon, OX14 3YP, United Kingdom

**Issued By:** Bureau Veritas Consumer Products Services (H.K.) Ltd., Taoyuan Branch  
Hsin Chu Laboratory

**Lab Address:** E-2, No.1, Li Hsin 1st Road, Hsinchu Science Park, Hsinchu City 300,  
Taiwan R.O.C.

**Test Location (1):** E-2, No.1, Li Hsin 1st Road, Hsinchu Science Park, Hsinchu City 300,  
Taiwan R.O.C.

**Test Location (2):** No. 49, Ln. 206, Wende Rd., Shangshan Tsuen, Chiung Lin Hsiang, Hsin  
Chu Hsien 307, Taiwan R.O.C.

**FCC Registration /  
Designation Number:** 723255 / TW2022



This report is for your exclusive use. Any copying or replication of this report to or for any other person or entity, or use of our name or trademark, is permitted only with our prior written permission. This report sets forth our findings solely with respect to the test samples identified herein. The results set forth in this report are not indicative or representative of the quality or characteristics of the lot from which a test sample was taken or any similar or identical product unless specifically and expressly noted. Our report includes all of the tests requested by you and the results thereof based upon the information that you provided to us. You have 60 days from date of issuance of this report to notify us of any material error or omission caused by our negligence, provided, however, that such notice shall be in writing and shall specifically address the issue you wish to raise. A failure to raise such issue within the prescribed time shall constitute your unqualified acceptance of the completeness of this report, the tests conducted and the correctness of the report contents. Unless specific mention, the uncertainty of measurement has been explicitly taken into account to declare the compliance or non-compliance to the specification. The report must not be used by the client to claim product certification, approval, or endorsement by TAF or any government agencies.

## Table of Contents

<b>Release Control Record</b> .....	<b>4</b>
<b>1 Certificate of Conformity</b> .....	<b>5</b>
<b>2 Summary of Test Results</b> .....	<b>6</b>
2.1 Measurement Uncertainty .....	6
2.2 Modification Record .....	6
<b>3 General Information</b> .....	<b>7</b>
3.1 General Description of EUT (DFS Band) .....	7
3.2 Description of Test Modes .....	10
3.2.1 Test Mode Applicability and Tested Channel Detail .....	12
3.3 Duty Cycle of Test Signal .....	16
3.4 Description of Support Units .....	17
3.4.1 Configuration of System under Test .....	18
3.5 General Description of Applied Standard .....	20
<b>4 Test Types and Results</b> .....	<b>21</b>
4.1 Radiated Emission and Bandedge Measurement .....	21
4.1.1 Limits of Radiated Emission and Bandedge Measurement .....	21
4.1.2 Test Instruments .....	22
4.1.3 Test Procedure .....	24
4.1.4 Deviation from Test Standard .....	24
4.1.5 Test Setup .....	25
4.1.6 EUT Operating Condition .....	26
4.1.7 Test Results (Mode 1) .....	27
4.1.8 Test Results (Mode 2) .....	72
4.1.9 Test Results (Mode 3) .....	96
4.1.10 Test Results (Mode 4) .....	140
4.2 Conducted Emission Measurement .....	164
4.2.1 Limits of Conducted Emission Measurement .....	164
4.2.2 Test Instruments .....	164
4.2.3 Test Procedure .....	165
4.2.4 Deviation from Test Standard .....	165
4.2.5 Test Setup .....	165
4.2.6 EUT Operating Condition .....	165
4.2.7 Test Results (Mode 1) .....	166
4.3 Transmit Power Measurement .....	168
4.3.1 Limits of Transmit Power Measurement .....	168
4.3.2 Test Setup .....	169
4.3.3 Test Instruments .....	169
4.3.4 Test Procedure .....	170
4.3.5 Deviation from Test Standard .....	170
4.3.6 EUT Operating Condition .....	170
4.3.7 Test Result (Mode 1) .....	171
4.3.8 Test Result (Mode 2) .....	195
4.3.9 Test Result (Mode 3) .....	211
4.3.10 Test Result (Mode 4) .....	231
4.4 Occupied Bandwidth Measurement .....	238
4.4.1 Test Setup .....	238
4.4.2 Test Instruments .....	238
4.4.3 Test Procedure .....	238
4.4.4 Test Results (Mode 1) .....	239
4.4.5 Test Results (Mode 2) .....	243
4.4.6 Test Results (Mode 3) .....	246
4.4.7 Test Results (Mode 4) .....	249
4.5 Peak Power Spectral Density Measurement .....	251

4.5.1	Limits of Peak Power Spectral Density Measurement .....	251
4.5.2	Test Setup.....	251
4.5.3	Test Instruments .....	251
4.5.4	Test Procedure .....	252
4.5.5	Deviation from Test Standard .....	252
4.5.6	EUT Operating Condition .....	252
4.5.7	Test Results (Mode 1).....	253
4.5.8	Test Results (Mode 2).....	263
4.5.9	Test Results (Mode 3).....	269
4.5.10	Test Results (Mode 4).....	279
4.6	Frequency Stability Measurement.....	284
4.6.1	Limits of Frequency Stability Measurement .....	284
4.6.2	Test Setup.....	284
4.6.3	Test Instruments .....	284
4.6.4	Test Procedure .....	284
4.6.5	Deviation from Test Standard .....	284
4.6.6	EUT Operating Condition .....	284
4.6.7	Test Results (Mode 1).....	285
4.7	6dB Bandwidth Measurement.....	286
4.7.1	Limits of 6dB Bandwidth Measurement.....	286
4.7.2	Test Setup.....	286
4.7.3	Test Instruments .....	286
4.7.4	Test Procedure .....	286
4.7.5	Deviation from Test Standard .....	286
4.7.6	EUT Operating Condition .....	286
4.7.7	Test Results (Mode 1).....	287
4.7.8	Test Results (Mode 2).....	290
4.7.9	Test Results (Mode 3).....	292
4.7.10	Test Results (Mode 4).....	295
<b>5</b>	<b>Pictures of Test Arrangements.....</b>	<b>297</b>
	<b>Appendix – Information on the Testing Laboratories .....</b>	<b>298</b>

### Release Control Record

Issue No.	Description	Date Issued
RF170421E06A-1	Original release.	Oct. 13, 2017

## 1 Certificate of Conformity

**Product:** Sophos Access Point

**Brand:** SOPHOS

**Test Model:** APX 740

**Sample Status:** ENGINEERING SAMPLE

**Applicant:** Sophos Ltd

**Test Date:** May 18 to June 22, 2017

**Standard:** 47 CFR FCC Part 15, Subpart E (Section 15.407)  
ANSI C63.10: 2013

The above equipment has been tested by **Bureau Veritas Consumer Products Services (H.K.) Ltd., Taoyuan Branch**, and found compliance with the requirement of the above standards. The test record, data evaluation & Equipment Under Test (EUT) configurations represented herein are true and accurate accounts of the measurements of the sample's EMC characteristics under the conditions specified in this report.

**Prepared by :** Wendy Wu , **Date:** Oct. 13, 2017  
Wendy Wu / Specialist

**Approved by :** May Chen , **Date:** Oct. 13, 2017  
May Chen / Manager

## 2 Summary of Test Results

47 CFR FCC Part 15, Subpart E (Section 15.407)			
FCC Clause	Test Item	Result	Remarks
15.407(b)(6)	AC Power Conducted Emissions	Pass	Meet the requirement of limit. Minimum passing margin is -6.64dB at 0.42841MHz.
15.407(b) (1/2/3/4(i/ii)/6)	Radiated Emissions & Band Edge Measurement*	Pass	Meet the requirement of limit. Minimum passing margin is -0.1dB at 5470.00MHz, 5356.80MHz, 5350.00MHz, 5725.00MHz, 5356.00MHz, 5466.80MHz, 5850.00MHz.
15.407(a)(1/2/3)	Max Average Transmit Power	Pass	Meet the requirement of limit.
---	Occupied Bandwidth Measurement	-	Reference only.
15.407(a)(1/2/3)	Peak Power Spectral Density	Pass	Meet the requirement of limit.
15.407(e)	6dB bandwidth	Pass	Meet the requirement of limit. (U-NII-3 Band only)
15.407(g)	Frequency Stability	Pass	Meet the requirement of limit.
15.203	Antenna Requirement	Pass	Antenna connector is i-pex(MHF) not a standard connector.

### 2.1 Measurement Uncertainty

Where relevant, the following measurement uncertainty levels have been estimated for tests performed on the EUT as specified in CISPR 16-4-2:

Measurement	Frequency	Expanded Uncertainty (k=2) (±)
Conducted Emissions at mains ports	150kHz ~ 30MHz	1.84 dB
Radiated Emissions up to 1 GHz	30MHz ~ 1GHz	5.32 dB
Radiated Emissions above 1 GHz	1GHz ~ 6GHz	5.14 dB
	6GHz ~ 18GHz	5.04 dB
	18GHz ~ 40GHz	5.25 dB

### 2.2 Modification Record

There were no modifications required for compliance.

### 3 General Information

#### 3.1 General Description of EUT (DFS Band)

Product	Sophos Access Point
Brand	SOPHOS
Test Model	APX 740
Status of EUT	ENGINEERING SAMPLE
Power Supply Rating	DC 55V from POE
Modulation Type	64QAM, 16QAM, QPSK, BPSK for OFDM 256QAM for OFDM in 11ac mode only
Modulation Technology	OFDM
Transfer Rate	802.11a: up to 54Mbps 802.11n: up to 600Mbps 802.11ac: up to 1733.3Mbps 802.11ac (80+80): up to 3466.7Mbps
Operating Frequency	5.26GHz ~ 5.32GHz, 5.50GHz ~ 5.72GHz 5.18GHz~5.24GHz, 5.745GHz~5.828GHz (for VHT80+80)
Number of Channel	802.11a, 802.11n (HT20), 802.11ac (VHT20): 16 802.11n (HT40), 802.11ac (VHT40): 8 802.11ac (VHT80): 4 802.11ac (VHT80+80): 14 sets
Output Power	<b>CDD Mode:</b> <b>5.26 ~ 5.32GHz:</b> <b>4TX:</b> 125.944mW (21.00dBm) <b>3TX:</b> 166.817mW (22.22dBm) <b>2TX:</b> 237.073mW (23.75dBm) <b>1TX:</b> 208.93mW (23.20dBm) <b>5.50 ~ 5.72GHz:</b> <b>4TX:</b> 135.557mW (21.32dBm) <b>3TX:</b> 173.506mW (22.39dBm) <b>2TX:</b> 238.009mW (23.77dBm) <b>1TX:</b> 181.97mW (22.60dBm) <b>Beamforming Mode:</b> <b>5.26 ~ 5.32GHz:</b> <b>4TX:</b> 67.901mW (18.32dBm) <b>3TX:</b> 83.941mW (19.24dBm) <b>2TX:</b> 130.293mW (21.15dBm) <b>5.50 ~ 5.72GHz:</b> <b>4TX:</b> 67.919mW (18.32dBm) <b>3TX:</b> 88.012mW (19.45dBm) <b>2TX:</b> 129.622mW (21.13dBm)
Antenna Type	Refer to Note
Antenna Connector	Refer to Note
Accessory Device	NA
Data Cable Supplied	NA

Note:

- This report is prepared for FCC class II permissive change. The difference compared with the Report No.: RF170421E06-1 as the following:
  - ◆ Add DFS band <5250~5350MHz & 5470~5725MHz> and multi-channel operation in an 80+80 mode.
- According to above condition, all test items need to be performed. And all data weres verified to meet the requirements.
- The EUT has three radio transceivers, radio 1 is WLAN technologies for single band (2.4GHz), radio 2 is WLAN technology for single band (5GHz), and radio 3 is Bluetooth low energy (BT-LE) technology only.
- Simultaneously transmission condition.

Condition	Technology	
1	WLAN 2.4GHz (Radio 1)	WLAN 5GHz (Radio 2)

**Note:** The emission of the simultaneous operation has been evaluated and no non-compliance was found.

- The EUT must be supplied with a POE (only for test not for sale) as following table:

Brand	Model No.	Spec.
PowerDsine	PD-9001GR/AC	Input: 100-240Vac, 50/60Hz, 0.67A Output: 55Vdc, 0.6A

- The antennas provided to the EUT, please refer to the following table:

Radio 1								
2.4GHz								
Antenna No.	Transmitter Circuit	Brand	Model No.	Antenna Net Gain (dBi)	Frequency Range (GHz)	Antenna Type	Connector Type	*Cable Length
1	Chain (0)	NA	NA	4.99	2.4~2.4835	PIFA	i-pex(MHF)	176
2	Chain (1)	NA	NA	4.47	2.4~2.4835	PIFA	i-pex(MHF)	140
3	Chain (2)	NA	NA	3.71	2.4~2.4835	PIFA	i-pex(MHF)	98
4	Chain (3)	NA	NA	4.83	2.4~2.4835	PIFA	i-pex(MHF)	70
Radio 2								
5GHz								
Antenna No.	Transmitter Circuit	Brand	Model No.	Antenna Net Gain (dBi)	Frequency Range (GHz)	Antenna Type	Connector Type	*Cable Length
1	Chain (0)	NA	NA	5.94	5.15~5.85	Dipole	i-pex(MHF)	79
2	Chain (1)	NA	NA	5.71	5.15~5.85	Dipole	i-pex(MHF)	117
3	Chain (2)	NA	NA	5.61	5.15~5.85	Dipole	i-pex(MHF)	157
4	Chain (3)	NA	NA	5.32	5.15~5.85	Dipole	i-pex(MHF)	189
Radio 3								
Bluetooth								
Antenna No.	Transmitter Circuit	Brand	Model No.	Antenna Net Gain (dBi)	Frequency Range (GHz)	Antenna Type	Connector Type	*Cable Length
1	Chain (0)	NA	NA	2.75	2.4~2.4835	PIFA	i-pex(MHF)	121

Note: For 1TX configuration mode, max gain was selected for the final test.



7. The EUT incorporates a MIMO function:

2.4GHz Band			
MODULATION MODE	DATA RATE (MCS)	TX & RX CONFIGURATION	
802.11b	1 ~ 11Mbps	4TX/3TX/2TX/1TX diversity	4RX
802.11g	6 ~ 54Mbps	4TX/3TX/2TX/1TX diversity	4RX
802.11n (HT20)	MCS 0~7	4TX/3TX/2TX/1TX diversity	4RX
	MCS 8~15	4TX/3TX/2TX	4RX
	MCS 16~23	4TX/3TX	4RX
	MCS 24~31	4TX	4RX
802.11n (HT40)	MCS 0~7	4TX/3TX/2TX/1TX diversity	4RX
	MCS 8~15	4TX/3TX/2TX	4RX
	MCS 16~23	4TX/3TX	4RX
	MCS 24~31	4TX	4RX
5GHz Band			
MODULATION MODE	DATA RATE (MCS)	TX & RX CONFIGURATION	
802.11a	6 ~ 54Mbps	4TX/3TX/2TX/1TX diversity	4RX
802.11n (HT20)	MCS 0~7	4TX/3TX/2TX/1TX diversity	4RX
	MCS 8~15	4TX/3TX/2TX	4RX
	MCS 16~23	4TX/3TX	4RX
	MCS 24~31	4TX	4RX
802.11n (HT40)	MCS 0~7	4TX/3TX/2TX/1TX diversity	4RX
	MCS 8~15	4TX/3TX/2TX	4RX
	MCS 16~23	4TX/3TX	4RX
	MCS 24~31	4TX	4RX
802.11ac (VHT20)	MCS 0~8, Nss=1	4TX/3TX/2TX/1TX diversity	4RX
	MCS 0~8, Nss=2	4TX/3TX/2TX	4RX
	MCS 0~9, Nss=3	4TX/3TX	4RX
	MCS 0~8, Nss=4	4TX	4RX
802.11ac (VHT40)	MCS 0~9, Nss=1	4TX/3TX/2TX/1TX diversity	4RX
	MCS 0~9, Nss=2	4TX/3TX/2TX	4RX
	MCS 0~9, Nss=3	4TX/3TX	4RX
	MCS 0~9, Nss=4	4TX	4RX
802.11ac (VHT80)	MCS 0~9, Nss=1	4TX/3TX/2TX/1TX diversity	4RX
	MCS 0~9, Nss=2	4TX/3TX/2TX	4RX
	MCS 0~9, Nss=3	4TX/3TX	4RX
	MCS 0~9, Nss=4	4TX	4RX
802.11ac (VHT80+VHT80)	MCS 0~9, Nss=2	4TX/2TX	4RX
	MCS 0~9, Nss=4	4TX	4RX

Note:

1. All of modulation mode support beamforming function except 802.11a/b/g modulation mode.
2. The EUT support Beamforming and CDD mode, therefore both mode were investigated and the worst case scenario was identified. The worst case data were presented in test report.
3. The modulation and bandwidth are similar for 802.11n mode for 20MHz (40MHz) and 802.11ac mode for 20MHz (40MHz), therefore investigated worst case to representative mode in test report. (Final test mode refer section 3.2.1)

8. The above EUT information is declared by manufacturer and for more detailed features description, please refer to the manufacturer's specifications or user's manual.

### 3.2 Description of Test Modes

#### FOR 5260 ~ 5320MHz

4 channels are provided for 802.11a, 802.11n (HT20), 802.11ac (VHT20):

Channel	Frequency	Channel	Frequency
52	5260 MHz	60	5300 MHz
56	5280 MHz	64	5320 MHz

2 channels are provided for 802.11n (HT40), 802.11ac (VHT40):

Channel	Frequency	Channel	Frequency
54	5270 MHz	62	5310 MHz

1 channel is provided for 802.11ac (VHT80):

Channel	Frequency
58	5290 MHz

#### FOR 5500 ~ 5720MHz

12 channels are provided for 802.11a, 802.11n (HT20), 802.11ac (VHT20):

Channel	Frequency	Channel	Frequency
100	5500 MHz	124	5620 MHz
104	5520 MHz	128	5640 MHz
108	5540 MHz	132	5660 MHz
112	5560 MHz	136	5680 MHz
116	5580 MHz	140	5700 MHz
120	5600 MHz	144	5720 MHz

6 channels are provided for 802.11n (HT40), 802.11ac (VHT40):

Channel	Frequency	Channel	Frequency
102	5510 MHz	126	5630 MHz
110	5550 MHz	134	5670 MHz
118	5590 MHz	142	5710 MHz

3 channels are provided for 802.11ac (VHT80):

Channel	Frequency	Channel	Frequency
106	5530MHz	122	5610 MHz
138	5690MHz		

**For simultaneous transmission in non-adjacent channels:**

14 channels are provided for 802.11ac (VHT80+80):

Channel	Frequency	Channel	Frequency
42+58	5210 MHz + 5290 MHz	58+155	5290 MHz + 5775 MHz
42+106	5210 MHz + 5530 MHz	106+122	5530 MHz + 5610 MHz
42+122	5210 MHz + 5610 MHz	106+138	5530 MHz + 5690 MHz
42+138	5210 MHz + 5690 MHz	106+155	5530 MHz + 5775 MHz
58+106	5290 MHz + 5530 MHz	122+138	5610 MHz + 5690 MHz
58+122	5290 MHz + 5610 MHz	122+155	5610 MHz + 5775 MHz
58+138	5290 MHz + 5690 MHz	138+155	5690 MHz + 5775 MHz

Note: The transmission is for noncontiguous transmission using two nonadjacent 80MHz channels.

### 3.2.1 Test Mode Applicability and Tested Channel Detail

EUT Configure Mode	Applicable To				Description
	RE≥1G	RE<1G	PLC	APCM	
1	√	√	√	√	4TX Mode
2	√	-	-	√	3TX Mode
3	√	-	-	√	2TX Mode
4	√	-	-	√	1TX Mode

Where **RE≥1G**: Radiated Emission above 1GHz      **RE<1G**: Radiated Emission below 1GHz  
**PLC**: Power Line Conducted Emission      **APCM**: Antenna Port Conducted Measurement

**NOTE:**

1. The EUT had been pre-tested on the positioned of each 2 axis. The worst case was found when positioned on **X-plane**.
2. “-” means no effect.

#### **Radiated Emission Test (Above 1GHz):**

- Pre-Scan has been conducted to determine the worst-case mode from all possible combinations between available modulations, data rates and antenna ports (if EUT with antenna diversity architecture).
- Following channel(s) was (were) selected for the final test as listed below.

CDD Mode						
Mode	FREQ. Band (MHz)	Available Channel	Tested Channel	Modulation Technology	Modulation Type	Data Rate (Mbps)
802.11a	5260-5320	52 to 64	52, 60, 64	OFDM	BPSK	6
802.11ac (VHT20)		52 to 64	52, 60, 64	OFDM	BPSK	6.5
802.11ac (VHT40)		54 to 62	54, 62	OFDM	BPSK	13.5
802.11ac (VHT80)		58	58	OFDM	BPSK	29.3
802.11a	5500-5720	100 to 144	100, 116, 140, 144	OFDM	BPSK	6
802.11ac (VHT20)		100 to 144	100, 116, 140, 144	OFDM	BPSK	6.5
802.11ac (VHT40)		102 to 142	102, 110, 134, 142	OFDM	BPSK	13.5
802.11ac (VHT80)		106 to 138	106, 122, 138	OFDM	BPSK	29.3
802.11ac (VHT80+80)	5180-5240, 5260-5320, 5500-5720, 5745-5825	42 to 155	42+58 42+106 42+122 42+138 58+106 58+122 58+138 58+155 106+122 106+138 106+155 122+138 122+155 138+155	OFDM	BPSK	58.5

### **Radiated Emission Test (Below 1GHz):**

- Pre-Scan has been conducted to determine the worst-case mode from all possible combinations between available modulations, data rates and antenna ports (if EUT with antenna diversity architecture).
- Following channel(s) was (were) selected for the final test as listed below.

CDD Mode						
Mode	FREQ. Band (MHz)	Available Channel	Tested Channel	Modulation Technology	Modulation Type	Data Rate (Mbps)
802.11ac (VHT40)	5260-5320 5500-5720	54 to 62 102 to 142	110	OFDM	BPSK	13.5

### **Power Line Conducted Emission Test:**

- Pre-Scan has been conducted to determine the worst-case mode from all possible combinations between available modulations, data rates and antenna ports (if EUT with antenna diversity architecture).
- Following channel(s) was (were) selected for the final test as listed below.

CDD Mode						
Mode	FREQ. Band (MHz)	Available Channel	Tested Channel	Modulation Technology	Modulation Type	Data Rate (Mbps)
802.11ac (VHT40)	5260-5320 5500-5720	54 to 62 102 to 142	110	OFDM	BPSK	13.5

### Antenna Port Conducted Measurement:

- This item includes all test value of each mode, but only includes spectrum plot of worst value of each mode.
- Pre-Scan has been conducted to determine the worst-case mode from all possible combinations between available modulations, data rates and antenna ports (if EUT with antenna diversity architecture).
- Following channel(s) was (were) selected for the final test as listed below.

CDD Mode						
Mode	FREQ. Band (MHz)	Available Channel	Tested Channel	Modulation Technology	Modulation Type	Data Rate (Mbps)
802.11a	5260-5320	52 to 64	52, 60, 64	OFDM	BPSK	6
802.11ac (VHT20)		52 to 64	52, 60, 64	OFDM	BPSK	6.5
802.11ac (VHT40)		54 to 62	54, 62	OFDM	BPSK	13.5
802.11ac (VHT80)		58	58	OFDM	BPSK	29.3
802.11a	5500-5720	100 to 144	100, 116, 140, 144	OFDM	BPSK	6
802.11ac (VHT20)		100 to 144	100, 116, 140, 144	OFDM	BPSK	6.5
802.11ac (VHT40)		102 to 142	102, 110, 134, 142	OFDM	BPSK	13.5
802.11ac (VHT80)		106 to 138	106, 122, 138	OFDM	BPSK	29.3
802.11ac (VHT80+80)	5180-5240, 5260-5320, 5500-5720, 5745-5825	42 to 155	42+58 42+106 42+122 42+138 58+106 58+122 58+138 58+155 106+122 106+138 106+155 122+138 122+155 138+155	OFDM	BPSK	58.5

Beamforming Mode (Output power only)						
Mode	FREQ. Band (MHz)	Available Channel	Tested Channel	Modulation Technology	Modulation Type	Data Rate (Mbps)
802.11ac (VHT20)	5260-5320	52 to 64	52, 60, 64	OFDM	BPSK	6.5
802.11ac (VHT40)		54 to 62	54, 62	OFDM	BPSK	13.5
802.11ac (VHT80)		58	58	OFDM	BPSK	29.3
802.11ac (VHT20)	5500-5720	100 to 144	100, 116, 140, 144	OFDM	BPSK	6.5
802.11ac (VHT40)		102 to 142	102, 110, 134, 142	OFDM	BPSK	13.5
802.11ac (VHT80)		106 to 138	106, 122, 138	OFDM	BPSK	29.3
802.11ac (VHT80+80)	5180-5240, 5260-5320, 5500-5720, 5745-5825	42 to 155	42+58 42+106 42+122 42+138 58+106 58+122 58+138 58+155 106+122 106+138 106+155 122+138 122+155 138+155	OFDM	BPSK	58.5

**Test Condition:**

Applicable To	Environmental Conditions	Input Power (system)	Tested By
RE $\geq$ 1G	25deg. C, 65%RH	120Vac, 60Hz	Rey Chen
RE<1G	25deg. C, 65%RH	120Vac, 60Hz	Andy Ho
PLC	25deg. C, 68%RH	120Vac, 60Hz	Andy Ho
APCM	21deg. C, 60%RH	120Vac, 60Hz	Anderson Chen

### 3.3 Duty Cycle of Test Signal

If duty cycle of test signal is  $\geq 98\%$ , duty factor is not required.

If duty cycle of test signal is  $< 98\%$ , duty factor shall be considered.

**802.11a:** Duty cycle =  $2.027 \text{ ms} / 2.089 \text{ ms} = 0.97$ , Duty factor =  $10 * \log(1/0.97) = 0.13$

**802.11ac (VHT20):** Duty cycle =  $4.97 \text{ ms} / 5.031 \text{ ms} = 0.988$

**802.11ac (VHT40):** Duty cycle =  $2.415 \text{ ms} / 2.479 \text{ ms} = 0.974$ , Duty factor =  $10 * \log(1/0.974) = 0.11$

**802.11ac (VHT80):** Duty cycle =  $1.135 \text{ ms} / 1.199 \text{ ms} = 0.947$ , Duty factor =  $10 * \log(1/0.947) = 0.24$

**802.11ac (VHT80+80):** Duty cycle =  $1.135 / 1.199 = 0.947$ , Duty factor =  $10 * \log(1/0.947) = 0.24$

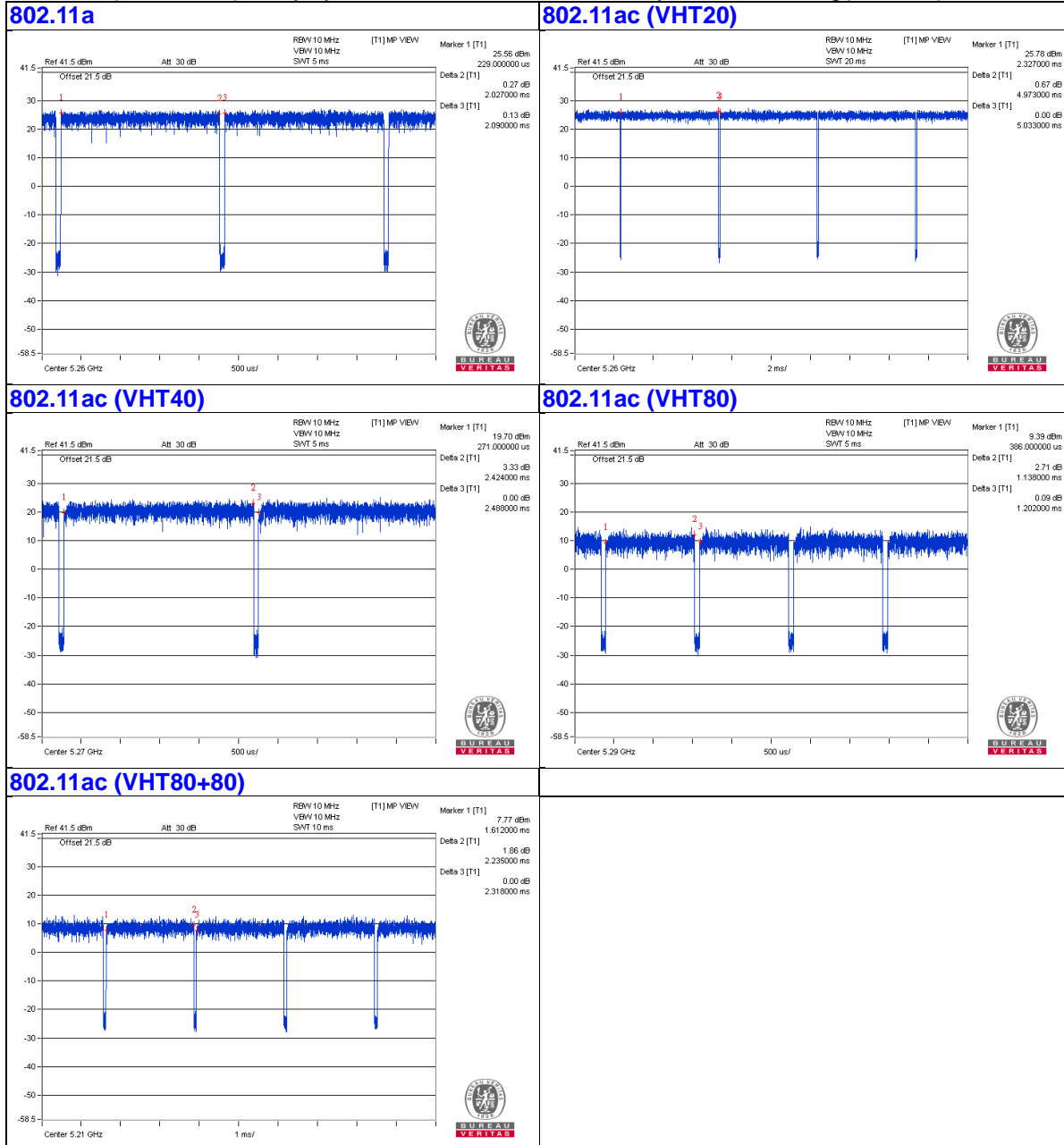



### 3.4 Description of Support Units

The EUT has been tested as an independent unit together with other necessary accessories or support units. The following support units or accessories were used to form a representative test configuration during the tests.

ID	Product	Brand	Model No.	Serial No.	FCC ID	Remarks
A.	Laptop	DELL	E5430	HYV4VY1	FCC DoC	Provided by Lab
B.	POE	PowerDsine	PD-9001GR/AC	NA	NA	Supplied by client
C.	Laptop	LENOVO	E440	PF071LWC	NA	Provided by Lab

Note:

1. All power cords of the above support units are non-shielded (1.8m).

ID	Descriptions	Qty.	Length (m)	Shielding (Yes/No)	Cores (Qty.)	Remarks
1.	RJ-45 Cable	1	10	No	0	Provided by Lab
2.	RJ-45 Cable	1	10	No	0	Provided by Lab
3.	RJ-45 Cable	1	3	No	0	Provided by Lab
4.	Console Cable	1	1.5	No	0	Provided by Lab

### 3.4.1 Configuration of System under Test

For Conducted Emission:

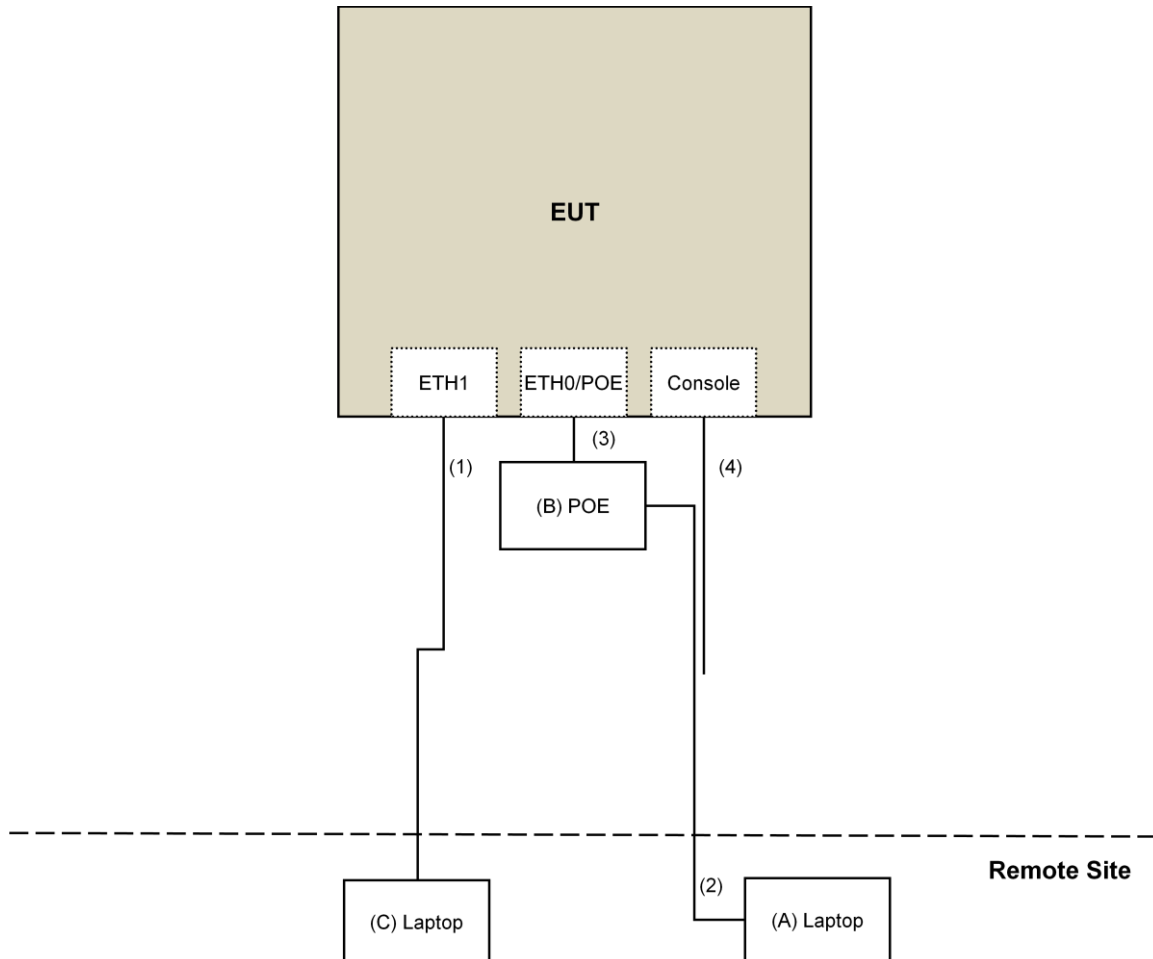

For other test:

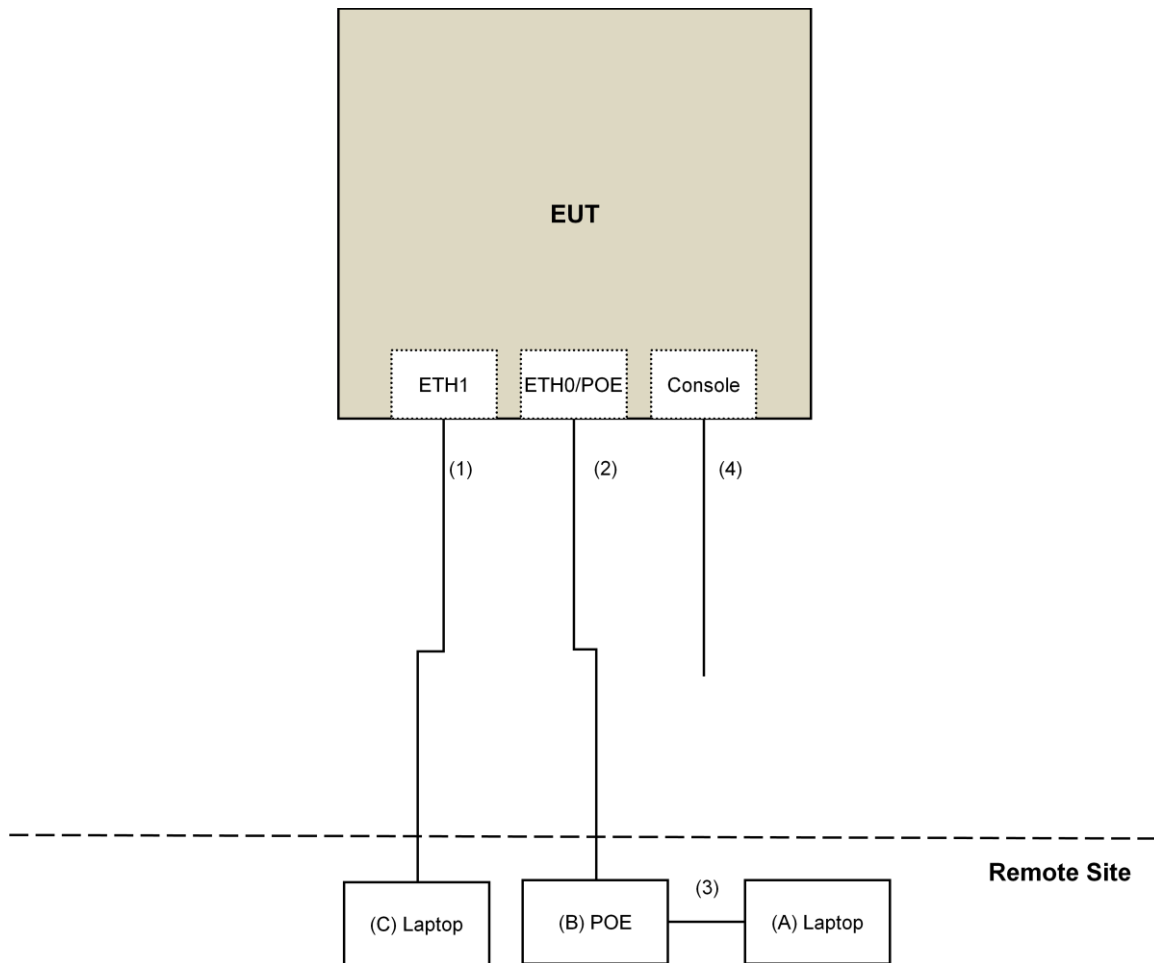

### 3.5 General Description of Applied Standard

The EUT is a RF Product. According to the specifications of the manufacturer, it must comply with the requirements of the following standards:

**FCC Part 15, Subpart E (15.407)**  
**KDB 789033 D02 General UNII Test Procedure New Rules v02r01**  
**KDB 662911 D01 Multiple Transmitter Output v02r01**  
**ANSI C63.10-2013**

All test items have been performed and recorded as per the above standards.

**NOTE:** The EUT has been verified to comply with the requirements of FCC Part 15, Subpart B, Class B (DoC). The test report has been issued separately.

## 4 Test Types and Results

### 4.1 Radiated Emission and Bandedge Measurement

#### 4.1.1 Limits of Radiated Emission and Bandedge Measurement

Radiated emissions which fall in the restricted bands must comply with the radiated emission limits specified as below table.

Frequencies (MHz)	Field Strength (microvolts/meter)	Measurement Distance (meters)
0.009 ~ 0.490	2400/F(kHz)	300
0.490 ~ 1.705	24000/F(kHz)	30
1.705 ~ 30.0	30	30
30 ~ 88	100	3
88 ~ 216	150	3
216 ~ 960	200	3
Above 960	500	3

#### NOTE:

1. The lower limit shall apply at the transition frequencies.
2. Emission level (dBuV/m) = 20 log Emission level (uV/m).
3. For frequencies above 1000MHz, the field strength limits are based on average detector, however, the peak field strength of any emission shall not exceed the maximum permitted average limits, specified above by more than 20dB under any condition of modulation.

Limits of unwanted emission out of the restricted bands

Applicable To		Limit	
789033 D02 General UNII Test Procedure New Rules v02r01		Field Strength at 3m	
		PK:74 (dBuV/m)	AV:54 (dBuV/m)
Frequency Band	Applicable To	EIRP Limit	Equivalent Field Strength at 3m
5150~5250 MHz	15.407(b)(1)	PK:-27 (dBm/MHz)	PK:68.2(dBuV/m)
5250~5350 MHz	15.407(b)(2)		
5470~5725 MHz	15.407(b)(3)		
5725~5850 MHz	<input checked="" type="checkbox"/> 15.407(b)(4)(i)	PK:-27 (dBm/MHz) <sup>*1</sup> PK:10 (dBm/MHz) <sup>*2</sup> PK:15.6 (dBm/MHz) <sup>*3</sup> PK:27 (dBm/MHz) <sup>*4</sup>	PK: 68.2(dBuV/m) <sup>*1</sup> PK:105.2 (dBuV/m) <sup>*2</sup> PK: 110.8(dBuV/m) <sup>*3</sup> PK:122.2 (dBuV/m) <sup>*4</sup>
	<input type="checkbox"/> 15.407(b)(4)(ii)	Emission limits in section 15.247(d)	
<sup>*1</sup> beyond 75 MHz or more above of the band edge.		<sup>*2</sup> below the band edge increasing linearly to 10 dBm/MHz at 25 MHz above.	
<sup>*3</sup> below the band edge increasing linearly to a level of 15.6 dBm/MHz at 5 MHz above.		<sup>*4</sup> from 5 MHz above or below the band edge increasing linearly to a level of 27 dBm/MHz at the band edge.	

#### Note:

The following formula is used to convert the equipment isotropic radiated power (eirp) to field strength:

$$E = \frac{1000000\sqrt{30P}}{3} \mu\text{V/m, where P is the eirp (Watts).}$$

## 4.1.2 Test Instruments

DESCRIPTION & MANUFACTURER	MODEL NO.	SERIAL NO.	CALIBRATED DATE	CALIBRATED UNTIL
Test Receiver Agilent	N9038A	MY50010156	Aug. 18, 2016	Aug. 17, 2017
Pre-Amplifier <sup>(*)</sup> EMCI	EMC001340	980142	Jan. 20, 2016	Jan. 19, 2018
Loop Antenna <sup>(*)</sup> Electro-Metrics	EM-6879	264	Dec. 16, 2016	Dec. 15, 2018
RF Cable	NA	LOOPCAB-001 LOOPCAB-002	Jan. 17, 2017	Jan. 16, 2018
Pre-Amplifier Mini-Circuits	ZFL-1000VH2B	AMP-ZFL-05	May 06, 2017	May 05, 2018
Trilog Broadband Antenna SCHWARZBECK	VULB 9168	9168-361	Dec. 29, 2016	Dec. 28, 2017
RF Cable	8D	966-3-1 966-3-2 966-3-3	Apr. 01, 2017	Mar. 31, 2018
Fixed attenuator Mini-Circuits	UNAT-5+	PAD-3m-3-01	Oct. 05, 2016	Oct. 04, 2017
Horn_Antenna SCHWARZBECK	BBHA9120-D	9120D-406	Dec. 28, 2016	Dec. 27, 2017
Pre-Amplifier EMCI	EMC12630SE	980384	Feb. 02, 2017	Feb. 01, 2018
RF Cable	EMC104-SM-SM-1200 EMC104-SM-SM-2000 EMC104-SM-SM-5000	160922 150317 150322	Feb. 02, 2017 Mar. 29, 2017 Mar. 29, 2017	Feb. 01, 2018 Mar. 28, 2018 Mar. 28, 2018
Spectrum Analyzer Keysight	N9030A	MY54490520	July 29, 2016	July 28, 2017
Pre-Amplifier EMCI	EMC184045SE	980386	Feb. 02, 2017	Feb. 01, 2018
Horn_Antenna SCHWARZBECK	BBHA 9170	BBHA9170608	Dec. 15, 2016	Dec. 14, 2017
RF Cable	SUCOFLEX 102	36432/2 36433/2	Jan. 15, 2017	Jan. 14, 2018
Software	ADT_Radiated_V8.7.08	NA	NA	NA
Antenna Tower & Turn Table Max-Full	MF-7802	MF780208406	NA	NA
Boresight Antenna Fixture	FBA-01	FBA-SIP01	NA	NA
Spectrum Analyzer R&S	FSv40	100964	June 28, 2016	June 27, 2017
Power meter Anritsu	ML2495A	1014008	May 11, 2017	May 10, 2018
Power sensor Anritsu	MA2411B	0917122	May 11, 2017	May 10, 2018
AC Power Source Extech Electronics	6205	1440452	NA	NA
Temperature & Humidity Chamber Giant Force	GTH-150-40-SP-AR	MAA0812-008	Jan. 11, 2017	Jan. 10, 2018
Digital Multimeter FLUKE	87III	73680266	Nov. 10, 2016	Nov. 09, 2017

**Note:**

1. The calibration interval of the above test instruments is 12 months and the calibrations are traceable to NML/ROC and NIST/USA.
2. \*The calibration interval of the above test instruments is 24 months and the calibrations are traceable to NML/ROC and NIST/USA.
3. The test was performed in 966 Chamber No. 3.
4. The CANADA Site Registration No. is 20331-1
6. Loop antenna was used for all emissions below 30 MHz.
- 7 Tested Date: June 08 to 22, 2017

#### 4.1.3 Test Procedure

##### **For Radiated emission below 30MHz**

- a. The EUT was placed on the top of a rotating table 0.8 meters above the ground at a 3 meter chamber room. The table was rotated 360 degrees to determine the position of the highest radiation.
- b. The EUT was set 3 meters away from the interference-receiving antenna, which was mounted on the top of a variable-height antenna tower.
- c. Both X and Y axes of the antenna are set to make the measurement.
- d. For each suspected emission, the EUT was arranged to its worst case and the rotatable table was turned from 0 degrees to 360 degrees to find the maximum reading.
- e. The test-receiver system was set to Quasi-Peak Detect Function and Specified Bandwidth with Maximum Hold Mode.

##### **NOTE:**

1. The resolution bandwidth and video bandwidth of test receiver/spectrum analyzer is 9kHz at frequency below 30MHz.

##### **For Radiated emission above 30MHz**

- a. The EUT was placed on the top of a rotating table 0.8 meters (for 30MHz ~ 1GHz) / 1.5 meters (for above 1GHz) above the ground at 3 meter chamber room for test. The table was rotated 360 degrees to determine the position of the highest radiation.
- b. The EUT was set 3 meters away from the interference-receiving antenna, which was mounted on the top of a variable-height antenna tower.
- c. The height of antenna is varied from one meter to four meters above the ground to determine the maximum value of the field strength. Both horizontal and vertical polarizations of the antenna are set to make the measurement.
- d. For each suspected emission, the EUT was arranged to its worst case and then the antenna was tuned to heights from 1 meter to 4 meters and the rotatable table was turned from 0 degrees to 360 degrees to find the maximum reading.
- e. The test-receiver system was set to quasi-peak detect function and specified bandwidth with maximum hold mode when the test frequency is below 1 GHz.
- f. The test-receiver system was set to peak and average detect function and specified bandwidth with maximum hold mode when the test frequency is above 1 GHz. If the peak reading value also meets average limit, measurement with the average detector is unnecessary.

##### **Note:**

1. The resolution bandwidth and video bandwidth of test receiver/spectrum analyzer is 120kHz for Quasi-peak detection (QP) at frequency below 1GHz.
2. The resolution bandwidth of test receiver/spectrum analyzer is 1 MHz and the video bandwidth is 3 MHz for Peak detection (PK) at frequency above 1GHz.
3. The resolution bandwidth of test receiver/spectrum analyzer is 1MHz and the video bandwidth is  $\geq 1/T$  (Duty cycle < 98%) or 10Hz (Duty cycle  $\geq 98\%$ ) for Average detection (AV) at frequency above 1GHz.
4. All modes of operation were investigated and the worst-case emissions are reported.

#### 4.1.4 Deviation from Test Standard

No deviation.



#### 4.1.5 Test Setup

##### For Radiated emission below 30MHz

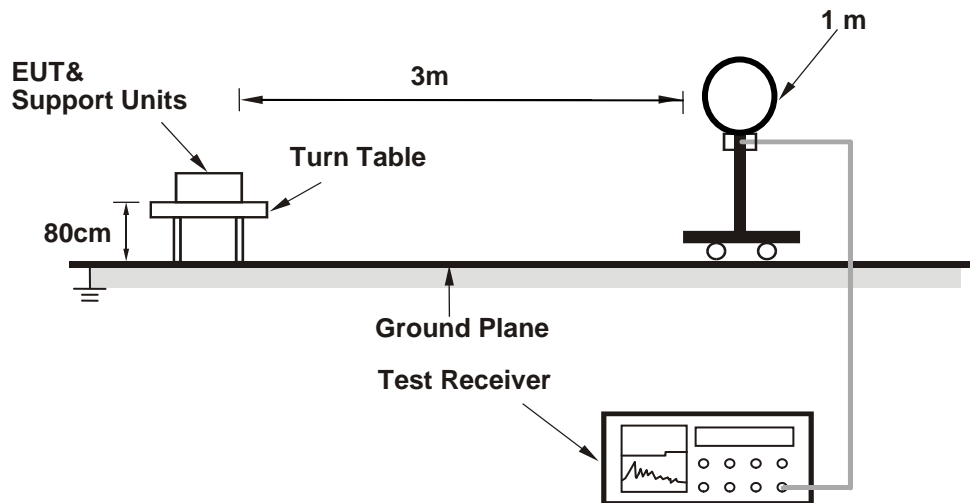

##### For Radiated emission 30MHz to 1GHz

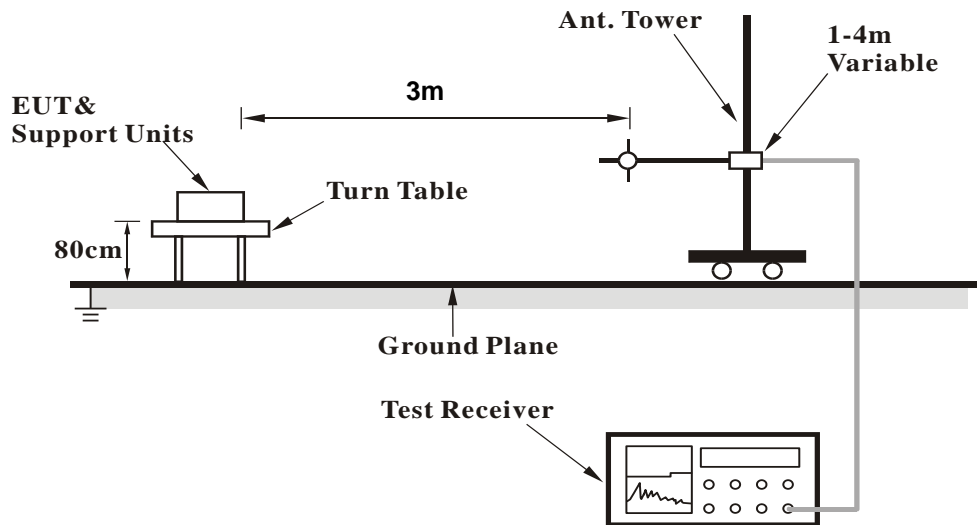

### For Radiated emission above 1GHz

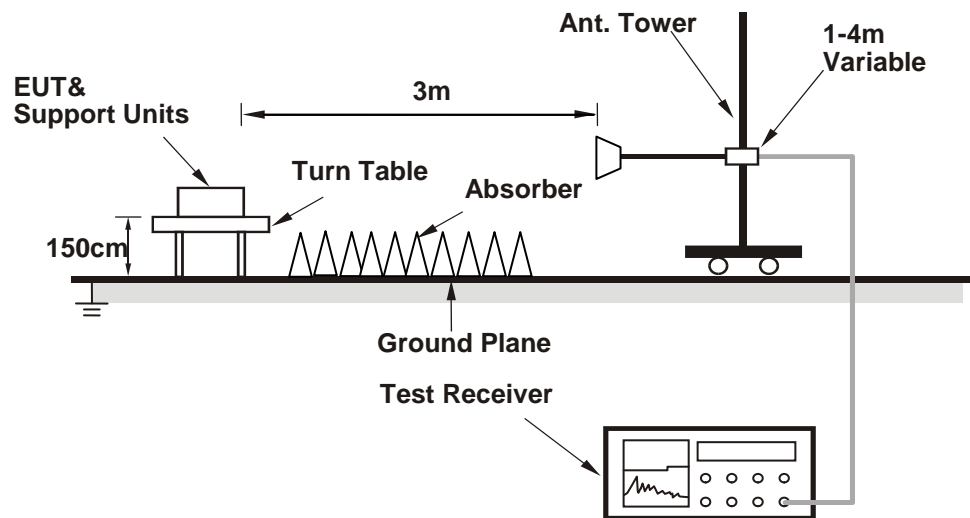

For the actual test configuration, please refer to the attached file (Test Setup Photo).

#### 4.1.6 EUT Operating Condition

- a. Connected the EUT with the Laptop which is placed on remote site.
- b. Controlling software (QDART-QCARCT [Ver3.0.197.0]) has been activated to set the EUT on specific status.

## 4.1.7 Test Results (Mode 1)

## Above 1GHz Data:

## 802.11a

<b>CHANNEL</b>	TX Channel 52	<b>DETECTOR FUNCTION</b>	Peak (PK)
<b>FREQUENCY RANGE</b>	1GHz ~ 40GHz		Average (AV)

**ANTENNA POLARITY & TEST DISTANCE: HORIZONTAL AT 3 M**

NO.	FREQ. (MHz)	EMISSION LEVEL (dBuV/m)	LIMIT (dBuV/m)	MARGIN (dB)	ANTENNA HEIGHT (m)	TABLE ANGLE (Degree)	RAW VALUE (dBuV)	CORRECTION FACTOR (dB/m)
1	5150.00	49.9 PK	74.0	-24.1	3.51 H	101	46.2	3.7
2	5150.00	39.6 AV	54.0	-14.4	3.51 H	101	35.9	3.7
3	*5260.00	111.9 PK			3.51 H	101	107.9	4.0
4	*5260.00	102.4 AV			3.51 H	101	98.4	4.0
5	5350.00	53.4 PK	74.0	-20.6	3.51 H	101	49.3	4.1
6	5350.00	42.1 AV	54.0	-11.9	3.51 H	101	38.0	4.1
7	#10520.00	49.5 PK	74.0	-24.5	1.69 H	80	36.3	13.2
8	#10520.00	37.4 AV	54.0	-16.6	1.69 H	80	24.2	13.2
9	15780.00	53.8 PK	74.0	-20.2	2.14 H	100	40.2	13.6
10	15780.00	40.6 AV	54.0	-13.4	2.14 H	100	27.0	13.6

**ANTENNA POLARITY & TEST DISTANCE: VERTICAL AT 3 M**

NO.	FREQ. (MHz)	EMISSION LEVEL (dBuV/m)	LIMIT (dBuV/m)	MARGIN (dB)	ANTENNA HEIGHT (m)	TABLE ANGLE (Degree)	RAW VALUE (dBuV)	CORRECTION FACTOR (dB/m)
1	5150.00	48.6 PK	74.0	-25.4	1.49 V	138	44.9	3.7
2	5150.00	37.8 AV	54.0	-16.2	1.49 V	138	34.1	3.7
3	*5260.00	97.2 PK			1.49 V	138	93.2	4.0
4	*5260.00	86.8 AV			1.49 V	138	82.8	4.0
5	5350.00	51.6 PK	74.0	-22.4	1.49 V	138	47.5	4.1
6	5350.00	40.2 AV	54.0	-13.8	1.49 V	138	36.1	4.1
7	#10520.00	49.3 PK	74.0	-24.7	2.18 V	143	36.1	13.2
8	#10520.00	36.6 AV	54.0	-17.4	2.18 V	143	23.4	13.2
9	15780.00	53.2 PK	74.0	-20.8	3.21 V	88	39.6	13.6
10	15780.00	39.9 AV	54.0	-14.1	3.21 V	88	26.3	13.6

**REMARKS:**

1. Emission Level(dBuV/m) = Raw Value(dBuV) + Correction Factor(dB/m)
2. Correction Factor(dB/m) = Antenna Factor(dB/m) + Cable Factor(dB) – Pre-Amplifier Factor(dB)
3. The other emission levels were very low against the limit.
4. Margin value = Emission Level – Limit value
5. " \* ": Fundamental frequency.
6. " # ": The radiated frequency is out of the restricted band.

<b>CHANNEL</b>	TX Channel 60	<b>DETECTOR FUNCTION</b>	Peak (PK)
<b>FREQUENCY RANGE</b>	1GHz ~ 40GHz		Average (AV)

**ANTENNA POLARITY & TEST DISTANCE: HORIZONTAL AT 3 M**

NO.	FREQ. (MHz)	EMISSION LEVEL (dBuV/m)	LIMIT (dBuV/m)	MARGIN (dB)	ANTENNA HEIGHT (m)	TABLE ANGLE (Degree)	RAW VALUE (dBuV)	CORRECTION FACTOR (dB/m)
1	5150.00	49.9 PK	74.0	-24.1	3.56 H	87	46.2	3.7
2	5150.00	39.7 AV	54.0	-14.3	3.56 H	87	36.0	3.7
3	*5300.00	111.4 PK			3.56 H	87	107.3	4.1
4	*5300.00	101.9 AV			3.56 H	87	97.8	4.1
5	5350.00	53.9 PK	74.0	-20.1	3.56 H	87	49.8	4.1
6	5350.00	42.4 AV	54.0	-11.6	3.56 H	87	38.3	4.1
7	10600.00	49.7 PK	74.0	-24.3	1.74 H	93	36.2	13.5
8	10600.00	37.7 AV	54.0	-16.3	1.74 H	93	24.2	13.5
9	15900.00	53.9 PK	74.0	-20.1	2.15 H	91	41.0	12.9
10	15900.00	40.8 AV	54.0	-13.2	2.15 H	91	27.9	12.9

**ANTENNA POLARITY & TEST DISTANCE: VERTICAL AT 3 M**

NO.	FREQ. (MHz)	EMISSION LEVEL (dBuV/m)	LIMIT (dBuV/m)	MARGIN (dB)	ANTENNA HEIGHT (m)	TABLE ANGLE (Degree)	RAW VALUE (dBuV)	CORRECTION FACTOR (dB/m)
1	5150.00	47.1 PK	74.0	-26.9	1.50 V	131	43.4	3.7
2	5150.00	37.6 AV	54.0	-16.4	1.50 V	131	33.9	3.7
3	*5300.00	97.1 PK			1.50 V	131	93.0	4.1
4	*5300.00	86.5 AV			1.50 V	131	82.4	4.1
5	5350.00	52.3 PK	74.0	-21.7	1.50 V	131	48.2	4.1
6	5350.00	41.2 AV	54.0	-12.8	1.50 V	131	37.1	4.1
7	10600.00	49.3 PK	74.0	-24.7	2.14 V	150	35.8	13.5
8	10600.00	36.7 AV	54.0	-17.3	2.14 V	150	23.2	13.5
9	15900.00	52.8 PK	74.0	-21.2	3.27 V	102	39.9	12.9
10	15900.00	39.5 AV	54.0	-14.5	3.27 V	102	26.6	12.9

**REMARKS:**

1. Emission Level(dBuV/m) = Raw Value(dBuV) + Correction Factor(dB/m)
2. Correction Factor(dB/m) = Antenna Factor(dB/m) + Cable Factor(dB) – Pre-Amplifier Factor(dB)
3. The other emission levels were very low against the limit.
4. Margin value = Emission Level – Limit value
5. " \* ": Fundamental frequency.

<b>CHANNEL</b>	TX Channel 64	<b>DETECTOR FUNCTION</b>	Peak (PK)
<b>FREQUENCY RANGE</b>	1GHz ~ 40GHz		Average (AV)

**ANTENNA POLARITY & TEST DISTANCE: HORIZONTAL AT 3 M**

NO.	FREQ. (MHz)	EMISSION LEVEL (dBuV/m)	LIMIT (dBuV/m)	MARGIN (dB)	ANTENNA HEIGHT (m)	TABLE ANGLE (Degree)	RAW VALUE (dBuV)	CORRECTION FACTOR (dB/m)
1	*5320.00	111.7 PK			3.56 H	85	107.6	4.1
2	*5320.00	102.3 AV			3.56 H	85	98.2	4.1
3	5350.00	53.5 PK	74.0	-20.5	3.56 H	85	49.4	4.1
4	5350.00	42.1 AV	54.0	-11.9	3.56 H	85	38.0	4.1
5	10640.00	49.5 PK	74.0	-24.5	1.74 H	100	36.0	13.5
6	10640.00	37.4 AV	54.0	-16.6	1.74 H	100	23.9	13.5
7	15960.00	53.6 PK	74.0	-20.4	2.11 H	82	40.7	12.9
8	15960.00	40.6 AV	54.0	-13.4	2.11 H	82	27.7	12.9

**ANTENNA POLARITY & TEST DISTANCE: VERTICAL AT 3 M**

NO.	FREQ. (MHz)	EMISSION LEVEL (dBuV/m)	LIMIT (dBuV/m)	MARGIN (dB)	ANTENNA HEIGHT (m)	TABLE ANGLE (Degree)	RAW VALUE (dBuV)	CORRECTION FACTOR (dB/m)
1	*5320.00	97.3 PK			1.52 V	141	93.2	4.1
2	*5320.00	86.7 AV			1.52 V	141	82.6	4.1
3	5350.00	52.1 PK	74.0	-21.9	1.52 V	14	48.0	4.1
4	5350.00	40.4 AV	54.0	-13.6	1.52 V	14	36.3	4.1
5	10640.00	49.5 PK	74.0	-24.5	2.16 V	162	36.0	13.5
6	10640.00	37.0 AV	54.0	-17.0	2.16 V	162	23.5	13.5
7	15960.00	52.7 PK	74.0	-21.3	3.27 V	90	39.8	12.9
8	15960.00	39.4 AV	54.0	-14.6	3.27 V	90	26.5	12.9

**REMARKS:**

1. Emission Level(dBuV/m) = Raw Value(dBuV) + Correction Factor(dB/m)
2. Correction Factor(dB/m) = Antenna Factor(dB/m) + Cable Factor(dB) – Pre-Amplifier Factor(dB)
3. The other emission levels were very low against the limit.
4. Margin value = Emission Level – Limit value
5. " \* ": Fundamental frequency.

<b>CHANNEL</b>	TX Channel 100	<b>DETECTOR FUNCTION</b>	Peak (PK)
<b>FREQUENCY RANGE</b>	1GHz ~ 40GHz		Average (AV)

**ANTENNA POLARITY & TEST DISTANCE: HORIZONTAL AT 3 M**

NO.	FREQ. (MHz)	EMISSION LEVEL (dBuV/m)	LIMIT (dBuV/m)	MARGIN (dB)	ANTENNA HEIGHT (m)	TABLE ANGLE (Degree)	RAW VALUE (dBuV)	CORRECTION FACTOR (dB/m)
1	#5470.00	53.7 PK	74.0	-20.3	3.53 H	100	49.5	4.2
2	#5470.00	42.2 AV	54.0	-11.8	3.53 H	100	38.0	4.2
3	*5500.00	111.9 PK			3.53 H	100	107.7	4.2
4	*5500.00	103.1 AV			3.53 H	100	98.9	4.2
5	11000.00	50.0 PK	74.0	-24.0	1.76 H	106	35.9	14.1
6	11000.00	37.8 AV	54.0	-16.2	1.76 H	106	23.7	14.1
7	#16500.00	53.4 PK	74.0	-20.6	2.09 H	90	38.9	14.5
8	#16500.00	40.6 AV	54.0	-13.4	2.09 H	90	26.1	14.5

**ANTENNA POLARITY & TEST DISTANCE: VERTICAL AT 3 M**

NO.	FREQ. (MHz)	EMISSION LEVEL (dBuV/m)	LIMIT (dBuV/m)	MARGIN (dB)	ANTENNA HEIGHT (m)	TABLE ANGLE (Degree)	RAW VALUE (dBuV)	CORRECTION FACTOR (dB/m)
1	#5470.00	51.3 PK	74.0	-22.7	1.56 V	152	47.1	4.2
2	#5470.00	40.2 AV	54.0	-13.8	1.56 V	152	36.0	4.2
3	*5500.00	97.6 PK			1.56 V	152	93.4	4.2
4	*5500.00	87.5 AV			1.56 V	152	83.3	4.2
5	11000.00	49.7 PK	74.0	-24.3	2.16 V	163	35.6	14.1
6	11000.00	37.4 AV	54.0	-16.6	2.16 V	163	23.3	14.1
7	#16500.00	52.6 PK	74.0	-21.4	3.24 V	74	38.1	14.5
8	#16500.00	39.4 AV	54.0	-14.6	3.24 V	74	24.9	14.5

**REMARKS:**

1. Emission Level(dBuV/m) = Raw Value(dBuV) + Correction Factor(dB/m)
2. Correction Factor(dB/m) = Antenna Factor(dB/m) + Cable Factor(dB) – Pre-Amplifier Factor(dB)
3. The other emission levels were very low against the limit.
4. Margin value = Emission Level – Limit value
5. " \* ": Fundamental frequency.
6. " # ": The radiated frequency is out of the restricted band.

<b>CHANNEL</b>	TX Channel 116	<b>DETECTOR FUNCTION</b>	Peak (PK)
<b>FREQUENCY RANGE</b>	1GHz ~ 40GHz		Average (AV)

**ANTENNA POLARITY & TEST DISTANCE: HORIZONTAL AT 3 M**

NO.	FREQ. (MHz)	EMISSION LEVEL (dBuV/m)	LIMIT (dBuV/m)	MARGIN (dB)	ANTENNA HEIGHT (m)	TABLE ANGLE (Degree)	RAW VALUE (dBuV)	CORRECTION FACTOR (dB/m)
1	#5470.00	50.4 PK	74.0	-23.6	3.51 H	87	46.2	4.2
2	#5470.00	40.0 AV	54.0	-14.0	3.51 H	87	35.8	4.2
3	*5580.00	111.6 PK			3.51 H	87	107.4	4.2
4	*5580.00	102.8 AV			3.51 H	87	98.6	4.2
5	#5725.00	54.4 PK	74.0	-19.6	3.51 H	87	50.0	4.4
6	#5725.00	42.9 AV	54.0	-11.1	3.51 H	87	38.5	4.4
7	11160.00	49.9 PK	74.0	-24.1	1.76 H	109	36.2	13.7
8	11160.00	37.4 AV	54.0	-16.6	1.76 H	109	23.7	13.7
9	#16740.00	53.3 PK	74.0	-20.7	2.12 H	85	37.6	15.7
10	#16740.00	40.6 AV	54.0	-13.4	2.12 H	85	24.9	15.7

**ANTENNA POLARITY & TEST DISTANCE: VERTICAL AT 3 M**

NO.	FREQ. (MHz)	EMISSION LEVEL (dBuV/m)	LIMIT (dBuV/m)	MARGIN (dB)	ANTENNA HEIGHT (m)	TABLE ANGLE (Degree)	RAW VALUE (dBuV)	CORRECTION FACTOR (dB/m)
1	#5470.00	48.1 PK	74.0	-25.9	1.50 V	137	43.9	4.2
2	#5470.00	38.6 AV	54.0	-15.4	1.50 V	137	34.4	4.2
3	*5580.00	97.5 PK			1.50 V	137	93.3	4.2
4	*5580.00	87.4 AV			1.50 V	137	83.2	4.2
5	#5725.00	52.2 PK	74.0	-21.8	1.50 V	137	47.8	4.4
6	#5725.00	40.6 AV	54.0	-13.4	1.50 V	137	36.2	4.4
7	11160.00	50.1 PK	74.0	-23.9	2.22 V	159	36.4	13.7
8	11160.00	37.6 AV	54.0	-16.4	2.22 V	159	23.9	13.7
9	#16740.00	52.2 PK	74.0	-21.8	3.18 V	77	36.5	15.7
10	#16740.00	39.2 AV	54.0	-14.8	3.18 V	77	23.5	15.7

**REMARKS:**

1. Emission Level(dBuV/m) = Raw Value(dBuV) + Correction Factor(dB/m)
2. Correction Factor(dB/m) = Antenna Factor(dB/m) + Cable Factor(dB) – Pre-Amplifier Factor(dB)
3. The other emission levels were very low against the limit.
4. Margin value = Emission Level – Limit value
5. " \* ": Fundamental frequency.
6. " # ": The radiated frequency is out of the restricted band.

<b>CHANNEL</b>	TX Channel 140	<b>DETECTOR FUNCTION</b>	Peak (PK)
<b>FREQUENCY RANGE</b>	1GHz ~ 40GHz		Average (AV)

**ANTENNA POLARITY & TEST DISTANCE: HORIZONTAL AT 3 M**

NO.	FREQ. (MHz)	EMISSION LEVEL (dBuV/m)	LIMIT (dBuV/m)	MARGIN (dB)	ANTENNA HEIGHT (m)	TABLE ANGLE (Degree)	RAW VALUE (dBuV)	CORRECTION FACTOR (dB/m)
1	*5700.00	111.5 PK			3.47 H	102	107.0	4.5
2	*5700.00	102.5 AV			3.47 H	102	98.0	4.5
3	#5725.00	54.6 PK	74.0	-19.4	3.47 H	102	50.2	4.4
4	#5725.00	43.4 AV	54.0	-10.6	3.47 H	102	39.0	4.4
5	11400.00	49.9 PK	74.0	-24.1	1.77 H	120	36.3	13.6
6	11400.00	37.3 AV	54.0	-16.7	1.77 H	120	23.7	13.6
7	#17100.00	53.1 PK	74.0	-20.9	2.10 H	98	35.7	17.4
8	#17100.00	40.6 AV	54.0	-13.4	2.10 H	98	23.2	17.4

**ANTENNA POLARITY & TEST DISTANCE: VERTICAL AT 3 M**

NO.	FREQ. (MHz)	EMISSION LEVEL (dBuV/m)	LIMIT (dBuV/m)	MARGIN (dB)	ANTENNA HEIGHT (m)	TABLE ANGLE (Degree)	RAW VALUE (dBuV)	CORRECTION FACTOR (dB/m)
1	*5700.00	97.2 PK			1.55 V	134	92.7	4.5
2	*5700.00	87.1 AV			1.55 V	134	82.6	4.5
3	#5725.00	52.4 PK	74.0	-21.6	1.55 V	134	48.0	4.4
4	#5725.00	41.2 AV	54.0	-12.8	1.55 V	134	36.8	4.4
5	11400.00	49.5 PK	74.0	-24.5	2.21 V	150	35.9	13.6
6	11400.00	37.2 AV	54.0	-16.8	2.21 V	150	23.6	13.6
7	#17100.00	51.7 PK	74.0	-22.3	3.21 V	78	34.3	17.4
8	#17100.00	38.8 AV	54.0	-15.2	3.21 V	78	21.4	17.4

**REMARKS:**

1. Emission Level(dBuV/m) = Raw Value(dBuV) + Correction Factor(dB/m)
2. Correction Factor(dB/m) = Antenna Factor(dB/m) + Cable Factor(dB) – Pre-Amplifier Factor(dB)
3. The other emission levels were very low against the limit.
4. Margin value = Emission Level – Limit value
5. " \* ": Fundamental frequency.
6. " # ": The radiated frequency is out of the restricted band.



<b>CHANNEL</b>	TX Channel 144	<b>DETECTOR FUNCTION</b>	Peak (PK)
<b>FREQUENCY RANGE</b>	1GHz ~ 40GHz		Average (AV)

**ANTENNA POLARITY & TEST DISTANCE: HORIZONTAL AT 3 M**

NO.	FREQ. (MHz)	EMISSION LEVEL (dBuV/m)	LIMIT (dBuV/m)	MARGIN (dB)	ANTENNA HEIGHT (m)	TABLE ANGLE (Degree)	RAW VALUE (dBuV)	CORRECTION FACTOR (dB/m)
1	#5470.00	50.0 PK	74.0	-24.0	3.52 H	112	45.8	4.2
2	#5470.00	39.5 AV	54.0	-14.5	3.52 H	112	35.3	4.2
3	*5720.00	112.1 PK			3.52 H	112	107.7	4.4
4	*5720.00	103.0 AV			3.52 H	112	98.6	4.4
5	#5850.00	54.4 PK	74.0	-19.6	3.52 H	112	49.9	4.5
6	#5850.00	43.1 AV	54.0	-10.9	3.52 H	112	38.6	4.5
7	11440.00	50.0 PK	74.0	-24.0	1.73 H	125	36.5	13.5
8	11440.00	37.1 AV	54.0	-16.9	1.73 H	125	23.6	13.5
9	#17160.00	53.5 PK	74.0	-20.5	2.10 H	109	36.2	17.3
10	#17160.00	40.9 AV	54.0	-13.1	2.10 H	109	23.6	17.3

**ANTENNA POLARITY & TEST DISTANCE: VERTICAL AT 3 M**

NO.	FREQ. (MHz)	EMISSION LEVEL (dBuV/m)	LIMIT (dBuV/m)	MARGIN (dB)	ANTENNA HEIGHT (m)	TABLE ANGLE (Degree)	RAW VALUE (dBuV)	CORRECTION FACTOR (dB/m)
1	#5470.00	49.1 PK	74.0	-24.9	1.50 V	120	44.9	4.2
2	#5470.00	37.2 AV	54.0	-16.8	1.50 V	120	33.0	4.2
3	*5720.00	97.8 PK			1.50 V	120	93.4	4.4
4	*5720.00	87.6 AV			1.50 V	120	83.2	4.4
5	#5850.00	52.2 PK	74.0	-21.8	1.50 V	120	47.7	4.5
6	#5850.00	41.8 AV	54.0	-12.2	1.50 V	120	37.3	4.5
7	11440.00	49.0 PK	74.0	-25.0	2.19 V	141	35.5	13.5
8	11440.00	36.9 AV	54.0	-17.1	2.19 V	141	23.4	13.5
9	#17160.00	51.6 PK	74.0	-22.4	3.16 V	76	34.3	17.3
10	#17160.00	38.6 AV	54.0	-15.4	3.16 V	76	21.3	17.3

**REMARKS:**

1. Emission Level(dBuV/m) = Raw Value(dBuV) + Correction Factor(dB/m)
2. Correction Factor(dB/m) = Antenna Factor(dB/m) + Cable Factor(dB) – Pre-Amplifier Factor(dB)
3. The other emission levels were very low against the limit.
4. Margin value = Emission Level – Limit value
5. " \* ": Fundamental frequency.
6. " # ": The radiated frequency is out of the restricted band.

**802.11ac (VHT20)**

<b>CHANNEL</b>	TX Channel 52	<b>DETECTOR FUNCTION</b>	Peak (PK)
<b>FREQUENCY RANGE</b>	1GHz ~ 40GHz		Average (AV)

**ANTENNA POLARITY & TEST DISTANCE: HORIZONTAL AT 3 M**

NO.	FREQ. (MHz)	EMISSION LEVEL (dBuV/m)	LIMIT (dBuV/m)	MARGIN (dB)	ANTENNA HEIGHT (m)	TABLE ANGLE (Degree)	RAW VALUE (dBuV)	CORRECTION FACTOR (dB/m)
1	5150.00	48.7 PK	74.0	-25.3	2.84 H	80	45.0	3.7
2	5150.00	39.0 AV	54.0	-15.0	2.84 H	80	35.3	3.7
3	*5260.00	114.5 PK			2.84 H	80	110.5	4.0
4	*5260.00	103.5 AV			2.84 H	80	99.5	4.0
5	#10520.00	50.1 PK	74.0	-23.9	1.70 H	133	36.9	13.2
6	#10520.00	37.0 AV	54.0	-17.0	1.70 H	133	23.8	13.2
7	15780.00	53.5 PK	74.0	-20.5	2.05 H	98	39.9	13.6
8	15780.00	40.6 AV	54.0	-13.4	2.05 H	98	27.0	13.6

**ANTENNA POLARITY & TEST DISTANCE: VERTICAL AT 3 M**

NO.	FREQ. (MHz)	EMISSION LEVEL (dBuV/m)	LIMIT (dBuV/m)	MARGIN (dB)	ANTENNA HEIGHT (m)	TABLE ANGLE (Degree)	RAW VALUE (dBuV)	CORRECTION FACTOR (dB/m)
1	5150.00	46.5 PK	74.0	-27.5	1.50 V	134	42.8	3.7
2	5150.00	37.8 AV	54.0	-16.2	1.50 V	134	34.1	3.7
3	*5260.00	99.2 PK			1.50 V	134	95.2	4.0
4	*5260.00	88.4 AV			1.50 V	134	84.4	4.0
5	#10520.00	48.8 PK	74.0	-25.2	2.19 V	153	35.6	13.2
6	#10520.00	37.0 AV	54.0	-17.0	2.19 V	153	23.8	13.2
7	15780.00	52.0 PK	74.0	-22.0	3.15 V	83	38.4	13.6
8	15780.00	38.9 AV	54.0	-15.1	3.15 V	83	25.3	13.6

**REMARKS:**

- Emission Level(dBuV/m) = Raw Value(dBuV) + Correction Factor(dB/m)
- Correction Factor(dB/m) = Antenna Factor(dB/m) + Cable Factor(dB) – Pre-Amplifier Factor(dB)
- The other emission levels were very low against the limit.
- Margin value = Emission Level – Limit value
- " \* ": Fundamental frequency.
- " # ": The radiated frequency is out of the restricted band.

<b>CHANNEL</b>	TX Channel 60	<b>DETECTOR FUNCTION</b>	Peak (PK)
<b>FREQUENCY RANGE</b>	1GHz ~ 40GHz		Average (AV)

**ANTENNA POLARITY & TEST DISTANCE: HORIZONTAL AT 3 M**

NO.	FREQ. (MHz)	EMISSION LEVEL (dBuV/m)	LIMIT (dBuV/m)	MARGIN (dB)	ANTENNA HEIGHT (m)	TABLE ANGLE (Degree)	RAW VALUE (dBuV)	CORRECTION FACTOR (dB/m)
1	5150.00	49.9 PK	74.0	-24.1	2.80 H	75	46.2	3.7
2	5150.00	38.7 AV	54.0	-15.3	2.80 H	75	35.0	3.7
3	*5300.00	114.0 PK			2.80 H	75	109.9	4.1
4	*5300.00	103.1 AV			2.80 H	75	99.0	4.1
5	5350.00	50.1 PK	74.0	-23.9	2.80 H	75	46.0	4.1
6	5350.00	38.6 AV	54.0	-15.4	2.80 H	75	34.5	4.1
7	10600.00	50.4 PK	74.0	-23.6	1.79 H	112	36.9	13.5
8	10600.00	37.5 AV	54.0	-16.5	1.79 H	112	24.0	13.5
9	15900.00	53.2 PK	74.0	-20.8	2.10 H	116	40.3	12.9
10	15900.00	40.8 AV	54.0	-13.2	2.10 H	116	27.9	12.9

**ANTENNA POLARITY & TEST DISTANCE: VERTICAL AT 3 M**

NO.	FREQ. (MHz)	EMISSION LEVEL (dBuV/m)	LIMIT (dBuV/m)	MARGIN (dB)	ANTENNA HEIGHT (m)	TABLE ANGLE (Degree)	RAW VALUE (dBuV)	CORRECTION FACTOR (dB/m)
1	5150.00	48.1 PK	74.0	-25.9	1.45 V	125	44.4	3.7
2	5150.00	36.4 AV	54.0	-17.6	1.45 V	125	32.7	3.7
3	*5300.00	99.6 PK			1.45 V	125	95.5	4.1
4	*5300.00	87.7 AV			1.45 V	125	83.6	4.1
5	5350.00	49.2 PK	74.0	-24.8	1.45 V	125	45.1	4.1
6	5350.00	36.6 AV	54.0	-17.4	1.45 V	125	32.5	4.1
7	10600.00	49.5 PK	74.0	-24.5	2.19 V	152	36.0	13.5
8	10600.00	37.4 AV	54.0	-16.6	2.19 V	152	23.9	13.5
9	15900.00	51.8 PK	74.0	-22.2	3.20 V	80	38.9	12.9
10	15900.00	38.6 AV	54.0	-15.4	3.20 V	80	25.7	12.9

**REMARKS:**

1. Emission Level(dBuV/m) = Raw Value(dBuV) + Correction Factor(dB/m)
2. Correction Factor(dB/m) = Antenna Factor(dB/m) + Cable Factor(dB) – Pre-Amplifier Factor(dB)
3. The other emission levels were very low against the limit.
4. Margin value = Emission Level – Limit value
5. " \* ": Fundamental frequency.

<b>CHANNEL</b>	TX Channel 64	<b>DETECTOR FUNCTION</b>	Peak (PK)
<b>FREQUENCY RANGE</b>	1GHz ~ 40GHz		Average (AV)

**ANTENNA POLARITY & TEST DISTANCE: HORIZONTAL AT 3 M**

NO.	FREQ. (MHz)	EMISSION LEVEL (dBuV/m)	LIMIT (dBuV/m)	MARGIN (dB)	ANTENNA HEIGHT (m)	TABLE ANGLE (Degree)	RAW VALUE (dBuV)	CORRECTION FACTOR (dB/m)
1	*5320.00	114.3 PK			2.82 H	87	110.2	4.1
2	*5320.00	103.2 AV			2.82 H	87	99.1	4.1
3	5350.00	50.1 PK	74.0	-23.9	2.82 H	87	46.0	4.1
4	5350.00	38.4 AV	54.0	-15.6	2.82 H	87	34.3	4.1
5	10640.00	49.5 PK	74.0	-24.5	1.68 H	130	36.0	13.5
6	10640.00	36.9 AV	54.0	-17.1	1.68 H	130	23.4	13.5
7	15960.00	53.5 PK	74.0	-20.5	2.15 H	95	40.6	12.9
8	15960.00	40.8 AV	54.0	-13.2	2.15 H	95	27.9	12.9

**ANTENNA POLARITY & TEST DISTANCE: VERTICAL AT 3 M**

NO.	FREQ. (MHz)	EMISSION LEVEL (dBuV/m)	LIMIT (dBuV/m)	MARGIN (dB)	ANTENNA HEIGHT (m)	TABLE ANGLE (Degree)	RAW VALUE (dBuV)	CORRECTION FACTOR (dB/m)
1	*5320.00	99.4 PK			1.50 V	133	95.3	4.1
2	*5320.00	88.1 AV			1.50 V	133	84.0	4.1
3	5350.00	49.2 PK	74.0	-24.8	1.50 V	133	45.1	4.1
4	5350.00	36.8 AV	54.0	-17.2	1.50 V	133	32.7	4.1
5	10640.00	48.7 PK	74.0	-25.3	2.16 V	143	35.2	13.5
6	10640.00	36.9 AV	54.0	-17.1	2.16 V	143	23.4	13.5
7	15960.00	52.4 PK	74.0	-21.6	3.19 V	67	39.5	12.9
8	15960.00	38.9 AV	54.0	-15.1	3.19 V	67	26.0	12.9

**REMARKS:**

1. Emission Level(dBuV/m) = Raw Value(dBuV) + Correction Factor(dB/m)
2. Correction Factor(dB/m) = Antenna Factor(dB/m) + Cable Factor(dB) – Pre-Amplifier Factor(dB)
3. The other emission levels were very low against the limit.
4. Margin value = Emission Level – Limit value
5. " \* ": Fundamental frequency.

<b>CHANNEL</b>	TX Channel 100	<b>DETECTOR FUNCTION</b>	Peak (PK)
<b>FREQUENCY RANGE</b>	1GHz ~ 40GHz		Average (AV)

**ANTENNA POLARITY & TEST DISTANCE: HORIZONTAL AT 3 M**

NO.	FREQ. (MHz)	EMISSION LEVEL (dBuV/m)	LIMIT (dBuV/m)	MARGIN (dB)	ANTENNA HEIGHT (m)	TABLE ANGLE (Degree)	RAW VALUE (dBuV)	CORRECTION FACTOR (dB/m)
1	#5470.00	56.8 PK	74.0	-17.2	1.03 H	281	52.6	4.2
2	#5470.00	44.5 AV	54.0	-9.5	1.03 H	281	40.3	4.2
3	*5500.00	114.6 PK			1.03 H	281	110.4	4.2
4	*5500.00	103.6 AV			1.03 H	281	99.4	4.2
5	11000.00	48.9 PK	74.0	-25.1	1.73 H	144	34.8	14.1
6	11000.00	36.5 AV	54.0	-17.5	1.73 H	144	22.4	14.1
7	#16500.00	53.1 PK	74.0	-20.9	2.17 H	99	38.6	14.5
8	#16500.00	40.5 AV	54.0	-13.5	2.17 H	99	26.0	14.5

**ANTENNA POLARITY & TEST DISTANCE: VERTICAL AT 3 M**

NO.	FREQ. (MHz)	EMISSION LEVEL (dBuV/m)	LIMIT (dBuV/m)	MARGIN (dB)	ANTENNA HEIGHT (m)	TABLE ANGLE (Degree)	RAW VALUE (dBuV)	CORRECTION FACTOR (dB/m)
1	#5470.00	55.6 PK	74.0	-18.4	1.44 V	140	51.4	4.2
2	#5470.00	42.1 AV	54.0	-11.9	1.44 V	140	37.9	4.2
3	*5500.00	99.3 PK			1.44 V	140	95.1	4.2
4	*5500.00	88.2 AV			1.44 V	140	84.0	4.2
5	11000.00	48.9 PK	74.0	-25.1	2.16 V	144	34.8	14.1
6	11000.00	37.2 AV	54.0	-16.8	2.16 V	144	23.1	14.1
7	#16500.00	52.1 PK	74.0	-21.9	3.22 V	75	37.6	14.5
8	#16500.00	38.6 AV	54.0	-15.4	3.22 V	75	24.1	14.5

**REMARKS:**

1. Emission Level(dBuV/m) = Raw Value(dBuV) + Correction Factor(dB/m)
2. Correction Factor(dB/m) = Antenna Factor(dB/m) + Cable Factor(dB) – Pre-Amplifier Factor(dB)
3. The other emission levels were very low against the limit.
4. Margin value = Emission Level – Limit value
5. " \* ": Fundamental frequency.
6. " # ": The radiated frequency is out of the restricted band.

<b>CHANNEL</b>	TX Channel 116	<b>DETECTOR FUNCTION</b>	Peak (PK)
<b>FREQUENCY RANGE</b>	1GHz ~ 40GHz		Average (AV)

**ANTENNA POLARITY & TEST DISTANCE: HORIZONTAL AT 3 M**

NO.	FREQ. (MHz)	EMISSION LEVEL (dBuV/m)	LIMIT (dBuV/m)	MARGIN (dB)	ANTENNA HEIGHT (m)	TABLE ANGLE (Degree)	RAW VALUE (dBuV)	CORRECTION FACTOR (dB/m)
1	#5470.00	50.6 PK	74.0	-23.4	1.09 H	278	46.4	4.2
2	#5470.00	38.6 AV	54.0	-15.4	1.09 H	278	34.4	4.2
3	*5580.00	115.0 PK			1.09 H	278	110.8	4.2
4	*5580.00	103.8 AV			1.09 H	278	99.6	4.2
5	#5725.00	49.8 PK	74.0	-24.2	1.09 H	278	45.4	4.4
6	#5725.00	39.4 AV	54.0	-14.6	1.09 H	278	35.0	4.4
7	11160.00	49.3 PK	74.0	-24.7	1.68 H	132	35.6	13.7
8	11160.00	36.7 AV	54.0	-17.3	1.68 H	132	23.0	13.7
9	#16740.00	52.7 PK	74.0	-21.3	2.19 H	87	37.0	15.7
10	#16740.00	40.3 AV	54.0	-13.7	2.19 H	87	24.6	15.7

**ANTENNA POLARITY & TEST DISTANCE: VERTICAL AT 3 M**

NO.	FREQ. (MHz)	EMISSION LEVEL (dBuV/m)	LIMIT (dBuV/m)	MARGIN (dB)	ANTENNA HEIGHT (m)	TABLE ANGLE (Degree)	RAW VALUE (dBuV)	CORRECTION FACTOR (dB/m)
1	#5470.00	48.4 PK	74.0	-25.6	1.44 V	150	44.2	4.2
2	#5470.00	37.2 AV	54.0	-16.8	1.44 V	150	33.0	4.2
3	*5580.00	99.7 PK			1.44 V	150	95.5	4.2
4	*5580.00	88.5 AV			1.44 V	150	84.3	4.2
5	#5725.00	47.6 PK	74.0	-26.4	1.44 V	150	43.2	4.4
6	#5725.00	38.1 AV	54.0	-15.9	1.44 V	150	33.7	4.4
7	11160.00	49.4 PK	74.0	-24.6	2.18 V	137	35.7	13.7
8	11160.00	37.5 AV	54.0	-16.5	2.18 V	137	23.8	13.7
9	#16740.00	52.0 PK	74.0	-22.0	3.21 V	73	36.3	15.7
10	#16740.00	38.4 AV	54.0	-15.6	3.21 V	73	22.7	15.7

**REMARKS:**

1. Emission Level(dBuV/m) = Raw Value(dBuV) + Correction Factor(dB/m)
2. Correction Factor(dB/m) = Antenna Factor(dB/m) + Cable Factor(dB) – Pre-Amplifier Factor(dB)
3. The other emission levels were very low against the limit.
4. Margin value = Emission Level – Limit value
5. " \* ": Fundamental frequency.
6. " # ": The radiated frequency is out of the restricted band.

<b>CHANNEL</b>	TX Channel 140	<b>DETECTOR FUNCTION</b>	Peak (PK)
<b>FREQUENCY RANGE</b>	1GHz ~ 40GHz		Average (AV)

**ANTENNA POLARITY & TEST DISTANCE: HORIZONTAL AT 3 M**

NO.	FREQ. (MHz)	EMISSION LEVEL (dBuV/m)	LIMIT (dBuV/m)	MARGIN (dB)	ANTENNA HEIGHT (m)	TABLE ANGLE (Degree)	RAW VALUE (dBuV)	CORRECTION FACTOR (dB/m)
1	*5700.00	114.6 PK			1.14 H	293	110.1	4.5
2	*5700.00	103.5 AV			1.14 H	293	99.0	4.5
3	#5725.00	49.1 PK	74.0	-24.9	1.14 H	293	44.7	4.4
4	#5725.00	39.0 AV	54.0	-15.0	1.14 H	293	34.6	4.4
5	11400.00	49.1 PK	74.0	-24.9	1.63 H	145	35.5	13.6
6	11400.00	36.3 AV	54.0	-17.7	1.63 H	145	22.7	13.6
7	#17100.00	52.4 PK	74.0	-21.6	2.17 H	90	35.0	17.4
8	#17100.00	40.0 AV	54.0	-14.0	2.17 H	90	22.6	17.4

**ANTENNA POLARITY & TEST DISTANCE: VERTICAL AT 3 M**

NO.	FREQ. (MHz)	EMISSION LEVEL (dBuV/m)	LIMIT (dBuV/m)	MARGIN (dB)	ANTENNA HEIGHT (m)	TABLE ANGLE (Degree)	RAW VALUE (dBuV)	CORRECTION FACTOR (dB/m)
1	*5700.00	100.2 PK			1.45 V	164	95.7	4.5
2	*5700.00	88.1 AV			1.45 V	164	83.6	4.5
3	#5725.00	48.6 PK	74.0	-25.4	1.45 V	164	44.2	4.4
4	#5725.00	37.4 AV	54.0	-16.6	1.45 V	164	33.0	4.4
5	11400.00	48.5 PK	74.0	-25.5	2.13 V	147	34.9	13.6
6	11400.00	36.8 AV	54.0	-17.2	2.13 V	147	23.2	13.6
7	#17100.00	51.6 PK	74.0	-22.4	3.16 V	84	34.2	17.4
8	#17100.00	38.3 AV	54.0	-15.7	3.16 V	84	20.9	17.4

**REMARKS:**

1. Emission Level(dBuV/m) = Raw Value(dBuV) + Correction Factor(dB/m)
2. Correction Factor(dB/m) = Antenna Factor(dB/m) + Cable Factor(dB) – Pre-Amplifier Factor(dB)
3. The other emission levels were very low against the limit.
4. Margin value = Emission Level – Limit value
5. " \* ": Fundamental frequency.
6. " # ": The radiated frequency is out of the restricted band.

<b>CHANNEL</b>	TX Channel 144	<b>DETECTOR FUNCTION</b>	Peak (PK)
<b>FREQUENCY RANGE</b>	1GHz ~ 40GHz		Average (AV)

**ANTENNA POLARITY & TEST DISTANCE: HORIZONTAL AT 3 M**

NO.	FREQ. (MHz)	EMISSION LEVEL (dBuV/m)	LIMIT (dBuV/m)	MARGIN (dB)	ANTENNA HEIGHT (m)	TABLE ANGLE (Degree)	RAW VALUE (dBuV)	CORRECTION FACTOR (dB/m)
1	#5470.00	49.3 PK	74.0	-24.7	1.18 H	282	45.1	4.2
2	#5470.00	36.8 AV	54.0	-17.2	1.18 H	282	32.6	4.2
3	*5720.00	114.7 PK			1.18 H	282	110.3	4.4
4	*5720.00	103.3 AV			1.18 H	282	98.9	4.4
5	#5850.00	50.9 PK	74.0	-23.1	1.18 H	282	46.4	4.5
6	#5850.00	39.1 AV	54.0	-14.9	1.18 H	282	34.6	4.5
7	11440.00	48.6 PK	74.0	-25.4	1.68 H	135	35.1	13.5
8	11440.00	35.8 AV	54.0	-18.2	1.68 H	135	22.3	13.5
9	#17160.00	52.8 PK	74.0	-21.2	2.21 H	87	35.5	17.3
10	#17160.00	40.3 AV	54.0	-13.7	2.21 H	87	23.0	17.3

**ANTENNA POLARITY & TEST DISTANCE: VERTICAL AT 3 M**

NO.	FREQ. (MHz)	EMISSION LEVEL (dBuV/m)	LIMIT (dBuV/m)	MARGIN (dB)	ANTENNA HEIGHT (m)	TABLE ANGLE (Degree)	RAW VALUE (dBuV)	CORRECTION FACTOR (dB/m)
1	#5470.00	48.7 PK	74.0	-25.3	1.44 V	152	44.5	4.2
2	#5470.00	34.3 AV	54.0	-19.7	1.44 V	152	30.1	4.2
3	*5720.00	100.4 PK			1.44 V	152	96.0	4.4
4	*5720.00	88.1 AV			1.44 V	152	83.7	4.4
5	#5850.00	48.6 PK	74.0	-25.4	1.44 V	152	44.1	4.5
6	#5850.00	37.2 AV	54.0	-16.8	1.44 V	152	32.7	4.5
7	11440.00	49.5 PK	74.0	-24.5	2.21 V	138	36.0	13.5
8	11440.00	37.6 AV	54.0	-16.4	2.21 V	138	24.1	13.5
9	#17160.00	52.0 PK	74.0	-22.0	3.19 V	76	34.7	17.3
10	#17160.00	38.3 AV	54.0	-15.7	3.19 V	76	21.0	17.3

**REMARKS:**

1. Emission Level(dBuV/m) = Raw Value(dBuV) + Correction Factor(dB/m)
2. Correction Factor(dB/m) = Antenna Factor(dB/m) + Cable Factor(dB) – Pre-Amplifier Factor(dB)
3. The other emission levels were very low against the limit.
4. Margin value = Emission Level – Limit value
5. " \* ": Fundamental frequency.
6. " # ": The radiated frequency is out of the restricted band.



**802.11ac (VHT40)**

<b>CHANNEL</b>	TX Channel 54	<b>DETECTOR FUNCTION</b>	Peak (PK)
<b>FREQUENCY RANGE</b>	1GHz ~ 40GHz		Average (AV)

**ANTENNA POLARITY & TEST DISTANCE: HORIZONTAL AT 3 M**

NO.	FREQ. (MHz)	EMISSION LEVEL (dBuV/m)	LIMIT (dBuV/m)	MARGIN (dB)	ANTENNA HEIGHT (m)	TABLE ANGLE (Degree)	RAW VALUE (dBuV)	CORRECTION FACTOR (dB/m)
1	5150.00	48.0 PK	74.0	-26.0	2.81 H	84	44.3	3.7
2	5150.00	38.5 AV	54.0	-15.5	2.81 H	84	34.8	3.7
3	*5270.00	116.7 PK			2.81 H	84	112.7	4.0
4	*5270.00	107.1 AV			2.81 H	84	103.1	4.0
5	5350.00	51.6 PK	74.0	-22.4	2.81 H	84	47.5	4.1
6	5350.00	40.8 AV	54.0	-13.2	2.81 H	84	36.7	4.1
7	#10540.00	48.5 PK	74.0	-25.5	1.73 H	134	35.2	13.3
8	#10540.00	35.9 AV	54.0	-18.1	1.73 H	134	22.6	13.3
9	15810.00	52.2 PK	74.0	-21.8	2.21 H	89	38.8	13.4
10	15810.00	39.9 AV	54.0	-14.1	2.21 H	89	26.5	13.4

**ANTENNA POLARITY & TEST DISTANCE: VERTICAL AT 3 M**

NO.	FREQ. (MHz)	EMISSION LEVEL (dBuV/m)	LIMIT (dBuV/m)	MARGIN (dB)	ANTENNA HEIGHT (m)	TABLE ANGLE (Degree)	RAW VALUE (dBuV)	CORRECTION FACTOR (dB/m)
1	5150.00	47.2 PK	74.0	-26.8	1.46 V	153	43.5	3.7
2	5150.00	36.4 AV	54.0	-17.6	1.46 V	153	32.7	3.7
3	*5270.00	103.3 PK			1.46 V	153	99.3	4.0
4	*5270.00	91.9 AV			1.46 V	153	87.9	4.0
5	5350.00	50.2 PK	74.0	-23.8	1.46 V	153	46.1	4.1
6	5350.00	38.6 AV	54.0	-15.4	1.46 V	153	34.5	4.1
7	#10540.00	49.2 PK	74.0	-24.8	2.24 V	153	35.9	13.3
8	#10540.00	37.5 AV	54.0	-16.5	2.24 V	153	24.2	13.3
9	15810.00	52.4 PK	74.0	-21.6	3.24 V	64	39.0	13.4
10	15810.00	38.4 AV	54.0	-15.6	3.24 V	64	25.0	13.4

**REMARKS:**

- Emission Level(dBuV/m) = Raw Value(dBuV) + Correction Factor(dB/m)
- Correction Factor(dB/m) = Antenna Factor(dB/m) + Cable Factor(dB) – Pre-Amplifier Factor(dB)
- The other emission levels were very low against the limit.
- Margin value = Emission Level – Limit value
- " \* ": Fundamental frequency.
- " # ": The radiated frequency is out of the restricted band.

<b>CHANNEL</b>	TX Channel 62	<b>DETECTOR FUNCTION</b>	Peak (PK)
<b>FREQUENCY RANGE</b>	1GHz ~ 40GHz		Average (AV)

**ANTENNA POLARITY & TEST DISTANCE: HORIZONTAL AT 3 M**

NO.	FREQ. (MHz)	EMISSION LEVEL (dBuV/m)	LIMIT (dBuV/m)	MARGIN (dB)	ANTENNA HEIGHT (m)	TABLE ANGLE (Degree)	RAW VALUE (dBuV)	CORRECTION FACTOR (dB/m)
1	*5310.00	110.7 PK			2.81 H	80	106.6	4.1
2	*5310.00	101.8 AV			2.81 H	80	97.7	4.1
3	5356.00	68.4 PK	74.0	-5.6	2.81 H	80	64.3	4.1
4	5356.00	53.6 AV	54.0	-0.4	2.81 H	80	49.5	4.1
5	10620.00	47.9 PK	74.0	-26.1	1.75 H	136	34.4	13.5
6	10620.00	35.4 AV	54.0	-18.6	1.75 H	136	21.9	13.5
7	15930.00	52.7 PK	74.0	-21.3	2.20 H	98	39.9	12.8
8	15930.00	40.3 AV	54.0	-13.7	2.20 H	98	27.5	12.8

**ANTENNA POLARITY & TEST DISTANCE: VERTICAL AT 3 M**

NO.	FREQ. (MHz)	EMISSION LEVEL (dBuV/m)	LIMIT (dBuV/m)	MARGIN (dB)	ANTENNA HEIGHT (m)	TABLE ANGLE (Degree)	RAW VALUE (dBuV)	CORRECTION FACTOR (dB/m)
1	*5310.00	98.5 PK			1.43 V	155	94.4	4.1
2	*5310.00	86.4 AV			1.43 V	155	82.3	4.1
3	5356.00	54.6 PK	74.0	-19.4	1.43 V	155	50.5	4.1
4	5356.00	40.5 AV	54.0	-13.5	1.43 V	155	36.4	4.1
5	10620.00	49.4 PK	74.0	-24.6	2.20 V	163	35.9	13.5
6	10620.00	37.7 AV	54.0	-16.3	2.20 V	163	24.2	13.5
7	15930.00	51.8 PK	74.0	-22.2	3.25 V	63	39.0	12.8
8	15930.00	38.1 AV	54.0	-15.9	3.25 V	63	25.3	12.8

**REMARKS:**

1. Emission Level(dBuV/m) = Raw Value(dBuV) + Correction Factor(dB/m)
2. Correction Factor(dB/m) = Antenna Factor(dB/m) + Cable Factor(dB) – Pre-Amplifier Factor(dB)
3. The other emission levels were very low against the limit.
4. Margin value = Emission Level – Limit value
5. " \* ": Fundamental frequency.

<b>CHANNEL</b>	TX Channel 102	<b>DETECTOR FUNCTION</b>	Peak (PK)
<b>FREQUENCY RANGE</b>	1GHz ~ 40GHz		Average (AV)

**ANTENNA POLARITY & TEST DISTANCE: HORIZONTAL AT 3 M**

NO.	FREQ. (MHz)	EMISSION LEVEL (dBuV/m)	LIMIT (dBuV/m)	MARGIN (dB)	ANTENNA HEIGHT (m)	TABLE ANGLE (Degree)	RAW VALUE (dBuV)	CORRECTION FACTOR (dB/m)
1	#5470.00	68.3 PK	74.0	-5.7	2.90 H	86	64.1	4.2
2	#5470.00	53.7 AV	54.0	-0.3	2.90 H	86	49.5	4.2
3	*5510.00	110.3 PK			2.90 H	86	106.1	4.2
4	*5510.00	101.3 AV			2.90 H	86	97.1	4.2
5	11020.00	48.1 PK	74.0	-25.9	1.79 H	144	34.1	14.0
6	11020.00	35.7 AV	54.0	-18.3	1.79 H	144	21.7	14.0
7	#16530.00	53.1 PK	74.0	-20.9	2.19 H	110	38.2	14.9
8	#16530.00	40.4 AV	54.0	-13.6	2.19 H	110	25.5	14.9

**ANTENNA POLARITY & TEST DISTANCE: VERTICAL AT 3 M**

NO.	FREQ. (MHz)	EMISSION LEVEL (dBuV/m)	LIMIT (dBuV/m)	MARGIN (dB)	ANTENNA HEIGHT (m)	TABLE ANGLE (Degree)	RAW VALUE (dBuV)	CORRECTION FACTOR (dB/m)
1	#5470.00	53.9 PK	74.0	-20.1	1.47 V	145	49.7	4.2
2	#5470.00	40.6 AV	54.0	-13.4	1.47 V	145	36.4	4.2
3	*5510.00	97.3 PK			1.47 V	145	93.1	4.2
4	*5510.00	86.1 AV			1.47 V	145	81.9	4.2
5	11020.00	49.2 PK	74.0	-24.8	2.17 V	161	35.2	14.0
6	11020.00	37.2 AV	54.0	-16.8	2.17 V	161	23.2	14.0
7	#16530.00	52.3 PK	74.0	-21.7	3.21 V	55	37.4	14.9
8	#16530.00	38.4 AV	54.0	-15.6	3.21 V	55	23.5	14.9

**REMARKS:**

1. Emission Level(dBuV/m) = Raw Value(dBuV) + Correction Factor(dB/m)
2. Correction Factor(dB/m) = Antenna Factor(dB/m) + Cable Factor(dB) – Pre-Amplifier Factor(dB)
3. The other emission levels were very low against the limit.
4. Margin value = Emission Level – Limit value
5. " \* ": Fundamental frequency.
6. " # ": The radiated frequency is out of the restricted band.

<b>CHANNEL</b>	TX Channel 110	<b>DETECTOR FUNCTION</b>	Peak (PK)
<b>FREQUENCY RANGE</b>	1GHz ~ 40GHz		Average (AV)

**ANTENNA POLARITY & TEST DISTANCE: HORIZONTAL AT 3 M**

NO.	FREQ. (MHz)	EMISSION LEVEL (dBuV/m)	LIMIT (dBuV/m)	MARGIN (dB)	ANTENNA HEIGHT (m)	TABLE ANGLE (Degree)	RAW VALUE (dBuV)	CORRECTION FACTOR (dB/m)
1	#5470.00	50.1 PK	74.0	-23.9	2.49 H	87	45.9	4.2
2	#5470.00	38.1 AV	54.0	-15.9	2.49 H	87	33.9	4.2
3	*5550.00	116.5 PK			2.55 H	83	112.3	4.2
4	*5550.00	106.7 AV			2.55 H	83	102.5	4.2
5	#5725.00	50.5 PK	74.0	-23.5	2.44 H	98	46.1	4.4
6	#5725.00	39.8 AV	54.0	-14.2	2.44 H	98	35.4	4.4
7	11100.00	48.7 PK	74.0	-25.3	1.78 H	144	34.9	13.8
8	11100.00	36.1 AV	54.0	-17.9	1.78 H	144	22.3	13.8
9	#16650.00	53.5 PK	74.0	-20.5	2.13 H	115	37.9	15.6
10	#16650.00	40.6 AV	54.0	-13.4	2.13 H	115	25.0	15.6

**ANTENNA POLARITY & TEST DISTANCE: VERTICAL AT 3 M**

NO.	FREQ. (MHz)	EMISSION LEVEL (dBuV/m)	LIMIT (dBuV/m)	MARGIN (dB)	ANTENNA HEIGHT (m)	TABLE ANGLE (Degree)	RAW VALUE (dBuV)	CORRECTION FACTOR (dB/m)
1	#5470.00	48.2 PK	74.0	-25.8	1.50 V	131	44.0	4.2
2	#5470.00	36.4 AV	54.0	-17.6	1.50 V	131	32.2	4.2
3	*5550.00	102.4 PK			1.50 V	131	98.2	4.2
4	*5550.00	91.5 AV			1.50 V	131	87.3	4.2
5	#5725.00	48.9 PK	74.0	-25.1	1.50 V	131	44.5	4.4
6	#5725.00	37.1 AV	54.0	-16.9	1.50 V	131	32.7	4.4
7	11100.00	49.2 PK	74.0	-24.8	2.14 V	152	35.4	13.8
8	11100.00	37.0 AV	54.0	-17.0	2.14 V	152	23.2	13.8
9	#16650.00	52.3 PK	74.0	-21.7	3.18 V	47	36.7	15.6
10	#16650.00	38.6 AV	54.0	-15.4	3.18 V	47	23.0	15.6

**REMARKS:**

1. Emission Level(dBuV/m) = Raw Value(dBuV) + Correction Factor(dB/m)
2. Correction Factor(dB/m) = Antenna Factor(dB/m) + Cable Factor(dB) – Pre-Amplifier Factor(dB)
3. The other emission levels were very low against the limit.
4. Margin value = Emission Level – Limit value
5. " \* ": Fundamental frequency.
6. " # ": The radiated frequency is out of the restricted band.

<b>CHANNEL</b>	TX Channel 134	<b>DETECTOR FUNCTION</b>	Peak (PK)
<b>FREQUENCY RANGE</b>	1GHz ~ 40GHz		Average (AV)

**ANTENNA POLARITY & TEST DISTANCE: HORIZONTAL AT 3 M**

NO.	FREQ. (MHz)	EMISSION LEVEL (dBuV/m)	LIMIT (dBuV/m)	MARGIN (dB)	ANTENNA HEIGHT (m)	TABLE ANGLE (Degree)	RAW VALUE (dBuV)	CORRECTION FACTOR (dB/m)
1	*5670.00	115.3 PK			2.52 H	96	111.0	4.3
2	*5670.00	105.9 AV			2.52 H	96	101.6	4.3
3	#5725.00	67.9 PK	74.0	-6.1	2.52 H	96	63.5	4.4
4	#5725.00	53.7 AV	54.0	-0.3	2.52 H	96	49.3	4.4
5	11340.00	48.8 PK	74.0	-25.2	1.83 H	132	35.2	13.6
6	11340.00	36.0 AV	54.0	-18.0	1.83 H	132	22.4	13.6
7	#17010.00	53.4 PK	74.0	-20.6	2.11 H	108	36.3	17.1
8	#17010.00	40.7 AV	54.0	-13.3	2.11 H	108	23.6	17.1

**ANTENNA POLARITY & TEST DISTANCE: VERTICAL AT 3 M**

NO.	FREQ. (MHz)	EMISSION LEVEL (dBuV/m)	LIMIT (dBuV/m)	MARGIN (dB)	ANTENNA HEIGHT (m)	TABLE ANGLE (Degree)	RAW VALUE (dBuV)	CORRECTION FACTOR (dB/m)
1	*5670.00	101.8 PK			1.52 V	122	97.5	4.3
2	*5670.00	90.7 AV			1.52 V	122	86.4	4.3
3	#5725.00	53.8 PK	74.0	-20.2	1.52 V	122	49.4	4.4
4	#5725.00	40.5 AV	54.0	-13.5	1.52 V	122	36.1	4.4
5	11340.00	49.4 PK	74.0	-24.6	2.19 V	145	35.8	13.6
6	11340.00	37.0 AV	54.0	-17.0	2.19 V	145	23.4	13.6
7	#17010.00	52.0 PK	74.0	-22.0	3.24 V	55	34.9	17.1
8	#17010.00	38.4 AV	54.0	-15.6	3.24 V	55	21.3	17.1

**REMARKS:**

1. Emission Level(dBuV/m) = Raw Value(dBuV) + Correction Factor(dB/m)
2. Correction Factor(dB/m) = Antenna Factor(dB/m) + Cable Factor(dB) – Pre-Amplifier Factor(dB)
3. The other emission levels were very low against the limit.
4. Margin value = Emission Level – Limit value
5. " \* ": Fundamental frequency.
6. " # ": The radiated frequency is out of the restricted band.

<b>CHANNEL</b>	TX Channel 142	<b>DETECTOR FUNCTION</b>	Peak (PK)
<b>FREQUENCY RANGE</b>	1GHz ~ 40GHz		Average (AV)

**ANTENNA POLARITY & TEST DISTANCE: HORIZONTAL AT 3 M**

NO.	FREQ. (MHz)	EMISSION LEVEL (dBuV/m)	LIMIT (dBuV/m)	MARGIN (dB)	ANTENNA HEIGHT (m)	TABLE ANGLE (Degree)	RAW VALUE (dBuV)	CORRECTION FACTOR (dB/m)
1	#5470.00	50.3 PK	74.0	-23.7	2.50 H	98	46.1	4.2
2	#5470.00	38.4 AV	54.0	-15.6	2.50 H	98	34.2	4.2
3	*5710.00	115.9 PK			2.50 H	98	111.4	4.5
4	*5710.00	106.3 AV			2.50 H	98	101.8	4.5
5	#5850.00	50.1 PK	74.0	-23.9	2.50 H	98	45.6	4.5
6	#5850.00	39.4 AV	54.0	-14.6	2.50 H	98	34.9	4.5
7	11420.00	48.4 PK	74.0	-25.6	1.84 H	119	34.8	13.6
8	11420.00	35.8 AV	54.0	-18.2	1.84 H	119	22.2	13.6
9	#17130.00	53.5 PK	74.0	-20.5	2.13 H	116	36.1	17.4
10	#17130.00	40.7 AV	54.0	-13.3	2.13 H	116	23.3	17.4

**ANTENNA POLARITY & TEST DISTANCE: VERTICAL AT 3 M**

NO.	FREQ. (MHz)	EMISSION LEVEL (dBuV/m)	LIMIT (dBuV/m)	MARGIN (dB)	ANTENNA HEIGHT (m)	TABLE ANGLE (Degree)	RAW VALUE (dBuV)	CORRECTION FACTOR (dB/m)
1	#5470.00	48.2 PK	74.0	-25.8	1.53 V	136	44.0	4.2
2	#5470.00	37.2 AV	54.0	-16.8	1.53 V	136	33.0	4.2
3	*5710.00	101.7 PK			1.53 V	136	97.2	4.5
4	*5710.00	91.1 AV			1.53 V	136	86.6	4.5
5	#5850.00	48.3 PK	74.0	-25.7	1.53 V	136	43.8	4.5
6	#5850.00	37.6 AV	54.0	-16.4	1.53 V	136	33.1	4.5
7	11420.00	49.4 PK	74.0	-24.6	2.25 V	138	35.8	13.6
8	11420.00	37.2 AV	54.0	-16.8	2.25 V	138	23.6	13.6
9	#17130.00	51.8 PK	74.0	-22.2	3.21 V	51	34.4	17.4
10	#17130.00	38.3 AV	54.0	-15.7	3.21 V	51	20.9	17.4

**REMARKS:**

1. Emission Level(dBuV/m) = Raw Value(dBuV) + Correction Factor(dB/m)
2. Correction Factor(dB/m) = Antenna Factor(dB/m) + Cable Factor(dB) – Pre-Amplifier Factor(dB)
3. The other emission levels were very low against the limit.
4. Margin value = Emission Level – Limit value
5. " \* ": Fundamental frequency.
6. " # ": The radiated frequency is out of the restricted band.

**802.11ac (VHT80)**

<b>CHANNEL</b>	TX Channel 58	<b>DETECTOR FUNCTION</b>	Peak (PK)
<b>FREQUENCY RANGE</b>	1GHz ~ 40GHz		Average (AV)

**ANTENNA POLARITY & TEST DISTANCE: HORIZONTAL AT 3 M**

NO.	FREQ. (MHz)	EMISSION LEVEL (dBuV/m)	LIMIT (dBuV/m)	MARGIN (dB)	ANTENNA HEIGHT (m)	TABLE ANGLE (Degree)	RAW VALUE (dBuV)	CORRECTION FACTOR (dB/m)
1	*5290.00	104.4 PK			2.75 H	78	100.3	4.1
2	*5290.00	95.0 AV			2.75 H	78	90.9	4.1
3	5356.00	63.4 PK	74.0	-10.6	2.75 H	78	59.3	4.1
4	5356.00	53.6 AV	54.0	-0.4	2.75 H	78	49.5	4.1
5	#10580.00	47.9 PK	74.0	-26.1	1.85 H	130	34.5	13.4
6	#10580.00	35.4 AV	54.0	-18.6	1.85 H	130	22.0	13.4
7	15870.00	53.3 PK	74.0	-20.7	2.09 H	127	40.3	13.0
8	15870.00	40.6 AV	54.0	-13.4	2.09 H	127	27.6	13.0

**ANTENNA POLARITY & TEST DISTANCE: VERTICAL AT 3 M**

NO.	FREQ. (MHz)	EMISSION LEVEL (dBuV/m)	LIMIT (dBuV/m)	MARGIN (dB)	ANTENNA HEIGHT (m)	TABLE ANGLE (Degree)	RAW VALUE (dBuV)	CORRECTION FACTOR (dB/m)
1	*5290.00	90.4 PK			1.47 V	144	86.3	4.1
2	*5290.00	80.2 AV			1.47 V	144	76.1	4.1
3	5356.00	52.1 PK	74.0	-21.9	1.47 V	144	48.0	4.1
4	5356.00	40.8 AV	54.0	-13.2	1.47 V	144	36.7	4.1
5	#10580.00	49.6 PK	74.0	-24.4	2.28 V	134	36.2	13.4
6	#10580.00	37.2 AV	54.0	-16.8	2.28 V	134	23.8	13.4
7	15870.00	51.7 PK	74.0	-22.3	3.27 V	44	38.7	13.0
8	15870.00	38.2 AV	54.0	-15.8	3.27 V	44	25.2	13.0

**REMARKS:**

- Emission Level(dBuV/m) = Raw Value(dBuV) + Correction Factor(dB/m)
- Correction Factor(dB/m) = Antenna Factor(dB/m) + Cable Factor(dB) – Pre-Amplifier Factor(dB)
- The other emission levels were very low against the limit.
- Margin value = Emission Level – Limit value
- " \* ": Fundamental frequency.
- " # ": The radiated frequency is out of the restricted band.

<b>CHANNEL</b>	TX Channel 106	<b>DETECTOR FUNCTION</b>	Peak (PK)
<b>FREQUENCY RANGE</b>	1GHz ~ 40GHz		Average (AV)

**ANTENNA POLARITY & TEST DISTANCE: HORIZONTAL AT 3 M**

NO.	FREQ. (MHz)	EMISSION LEVEL (dBuV/m)	LIMIT (dBuV/m)	MARGIN (dB)	ANTENNA HEIGHT (m)	TABLE ANGLE (Degree)	RAW VALUE (dBuV)	CORRECTION FACTOR (dB/m)
1	#5461.00	67.9 PK	74.0	-6.1	2.44 H	98	63.7	4.2
2	#5461.00	53.6 AV	54.0	-0.4	2.44 H	98	49.4	4.2
3	*5530.00	104.9 PK			2.44 H	98	100.7	4.2
4	*5530.00	96.4 AV			2.44 H	98	92.2	4.2
5	#5725.00	50.8 PK	74.0	-23.2	2.44 H	98	46.4	4.4
6	#5725.00	39.8 AV	54.0	-14.2	2.44 H	98	35.4	4.4
7	11060.00	47.9 PK	74.0	-26.1	1.81 H	139	34.0	13.9
8	11060.00	35.6 AV	54.0	-18.4	1.81 H	139	21.7	13.9
9	#16590.00	53.1 PK	74.0	-20.9	2.05 H	117	37.5	15.6
10	#16590.00	40.4 AV	54.0	-13.6	2.05 H	117	24.8	15.6

**ANTENNA POLARITY & TEST DISTANCE: VERTICAL AT 3 M**

NO.	FREQ. (MHz)	EMISSION LEVEL (dBuV/m)	LIMIT (dBuV/m)	MARGIN (dB)	ANTENNA HEIGHT (m)	TABLE ANGLE (Degree)	RAW VALUE (dBuV)	CORRECTION FACTOR (dB/m)
1	#5461.00	53.8 PK	74.0	-20.2	1.51 V	148	49.6	4.2
2	#5461.00	40.9 AV	54.0	-13.1	1.51 V	148	36.7	4.2
3	*5530.00	92.4 PK			1.51 V	148	88.2	4.2
4	*5530.00	81.3 AV			1.51 V	148	77.1	4.2
5	#5725.00	49.2 PK	74.0	-24.8	1.51 V	148	44.8	4.4
6	#5725.00	38.4 AV	54.0	-15.6	1.51 V	148	34.0	4.4
7	11060.00	49.7 PK	74.0	-24.3	2.29 V	134	35.8	13.9
8	11060.00	37.1 AV	54.0	-16.9	2.29 V	134	23.2	13.9
9	#16590.00	51.3 PK	74.0	-22.7	3.30 V	44	35.7	15.6
10	#16590.00	38.0 AV	54.0	-16.0	3.30 V	44	22.4	15.6

**REMARKS:**

1. Emission Level(dBuV/m) = Raw Value(dBuV) + Correction Factor(dB/m)
2. Correction Factor(dB/m) = Antenna Factor(dB/m) + Cable Factor(dB) – Pre-Amplifier Factor(dB)
3. The other emission levels were very low against the limit.
4. Margin value = Emission Level – Limit value
5. " \* ": Fundamental frequency.
6. " # ": The radiated frequency is out of the restricted band.



<b>CHANNEL</b>	TX Channel 122	<b>DETECTOR FUNCTION</b>	Peak (PK)
<b>FREQUENCY RANGE</b>	1GHz ~ 40GHz		Average (AV)

**ANTENNA POLARITY & TEST DISTANCE: HORIZONTAL AT 3 M**

NO.	FREQ. (MHz)	EMISSION LEVEL (dBuV/m)	LIMIT (dBuV/m)	MARGIN (dB)	ANTENNA HEIGHT (m)	TABLE ANGLE (Degree)	RAW VALUE (dBuV)	CORRECTION FACTOR (dB/m)
1	*5610.00	110.6 PK			2.49 H	84	106.2	4.4
2	*5610.00	102.4 AV			2.49 H	84	98.0	4.4
3	#5725.00	68.0 PK	74.0	-6.0	2.49 H	84	63.6	4.4
4	#5725.00	53.7 AV	54.0	-0.3	2.49 H	84	49.3	4.4
5	11220.00	47.8 PK	74.0	-26.2	1.85 H	129	34.1	13.7
6	11220.00	35.5 AV	54.0	-18.5	1.85 H	129	21.8	13.7
7	#16830.00	53.8 PK	74.0	-20.2	1.99 H	108	37.9	15.9
8	#16830.00	40.8 AV	54.0	-13.2	1.99 H	108	24.9	15.9

**ANTENNA POLARITY & TEST DISTANCE: VERTICAL AT 3 M**

NO.	FREQ. (MHz)	EMISSION LEVEL (dBuV/m)	LIMIT (dBuV/m)	MARGIN (dB)	ANTENNA HEIGHT (m)	TABLE ANGLE (Degree)	RAW VALUE (dBuV)	CORRECTION FACTOR (dB/m)
1	*5610.00	98.8 PK			1.54 V	161	94.4	4.4
2	*5610.00	87.6 AV			1.54 V	161	83.2	4.4
3	#5725.00	54.2 PK	74.0	-19.8	1.54 V	161	49.8	4.4
4	#5725.00	40.5 AV	54.0	-13.5	1.54 V	161	36.1	4.4
5	11220.00	49.2 PK	74.0	-24.8	2.27 V	149	35.5	13.7
6	11220.00	36.8 AV	54.0	-17.2	2.27 V	149	23.1	13.7
7	#16830.00	50.8 PK	74.0	-23.2	3.33 V	53	34.9	15.9
8	#16830.00	37.7 AV	54.0	-16.3	3.33 V	53	21.8	15.9

**REMARKS:**

1. Emission Level(dBuV/m) = Raw Value(dBuV) + Correction Factor(dB/m)
2. Correction Factor(dB/m) = Antenna Factor(dB/m) + Cable Factor(dB) – Pre-Amplifier Factor(dB)
3. The other emission levels were very low against the limit.
4. Margin value = Emission Level – Limit value
5. " \* ": Fundamental frequency.
6. " # ": The radiated frequency is out of the restricted band.

<b>CHANNEL</b>	TX Channel 138	<b>DETECTOR FUNCTION</b>	Peak (PK)
<b>FREQUENCY RANGE</b>	1GHz ~ 40GHz		Average (AV)

**ANTENNA POLARITY & TEST DISTANCE: HORIZONTAL AT 3 M**

NO.	FREQ. (MHz)	EMISSION LEVEL (dBuV/m)	LIMIT (dBuV/m)	MARGIN (dB)	ANTENNA HEIGHT (m)	TABLE ANGLE (Degree)	RAW VALUE (dBuV)	CORRECTION FACTOR (dB/m)
1	#5470.00	58.1 PK	74.0	-15.9	2.51 H	72	53.9	4.2
2	#5470.00	44.3 AV	54.0	-9.7	2.51 H	72	40.1	4.2
3	*5690.00	112.6 PK			2.51 H	72	108.1	4.5
4	*5690.00	104.3 AV			2.51 H	72	99.8	4.5
5	#5850.00	67.3 PK	74.0	-6.7	2.51 H	72	62.8	4.5
6	#5850.00	50.6 AV	54.0	-3.4	2.51 H	72	46.1	4.5
7	11380.00	47.2 PK	74.0	-26.8	1.84 H	140	33.6	13.6
8	11380.00	35.1 AV	54.0	-18.9	1.84 H	140	21.5	13.6
9	#17070.00	54.1 PK	74.0	-19.9	1.96 H	102	36.8	17.3
10	#17070.00	41.0 AV	54.0	-13.0	1.96 H	102	23.7	17.3

**ANTENNA POLARITY & TEST DISTANCE: VERTICAL AT 3 M**

NO.	FREQ. (MHz)	EMISSION LEVEL (dBuV/m)	LIMIT (dBuV/m)	MARGIN (dB)	ANTENNA HEIGHT (m)	TABLE ANGLE (Degree)	RAW VALUE (dBuV)	CORRECTION FACTOR (dB/m)
1	#5470.00	56.5 PK	74.0	-17.5	1.60 V	147	52.3	4.2
2	#5470.00	42.1 AV	54.0	-11.9	1.60 V	147	37.9	4.2
3	*5690.00	100.4 PK			1.60 V	147	95.9	4.5
4	*5690.00	88.9 AV			1.60 V	147	84.4	4.5
5	#5850.00	66.2 PK	74.0	-7.8	1.60 V	147	61.7	4.5
6	#5850.00	48.4 AV	54.0	-5.6	1.60 V	147	43.9	4.5
7	11380.00	49.0 PK	74.0	-25.0	2.25 V	140	35.4	13.6
8	11380.00	36.8 AV	54.0	-17.2	2.25 V	140	23.2	13.6
9	#17070.00	51.0 PK	74.0	-23.0	3.28 V	62	33.7	17.3
10	#17070.00	38.1 AV	54.0	-15.9	3.28 V	62	20.8	17.3

**REMARKS:**

1. Emission Level(dBuV/m) = Raw Value(dBuV) + Correction Factor(dB/m)
2. Correction Factor(dB/m) = Antenna Factor(dB/m) + Cable Factor(dB) – Pre-Amplifier Factor(dB)
3. The other emission levels were very low against the limit.
4. Margin value = Emission Level – Limit value
5. " \* ": Fundamental frequency.
6. " # ": The radiated frequency is out of the restricted band.

**802.11ac (VHT80+80)**

<b>CHANNEL</b>	TX Channel 42+58	<b>DETECTOR FUNCTION</b>	Peak (PK)
<b>FREQUENCY RANGE</b>	1GHz ~ 40GHz		Average (AV)

**ANTENNA POLARITY & TEST DISTANCE: HORIZONTAL AT 3 M**

NO.	FREQ. (MHz)	EMISSION LEVEL (dBuV/m)	LIMIT (dBuV/m)	MARGIN (dB)	ANTENNA HEIGHT (m)	TABLE ANGLE (Degree)	RAW VALUE (dBuV)	CORRECTION FACTOR (dB/m)
1	5144.00	60.0 PK	74.0	-14.0	2.38 H	104	56.4	3.6
2	5144.00	50.2 AV	54.0	-3.8	2.38 H	104	46.6	3.6
3	*5210.00	100.7 PK			2.38 H	104	97.0	3.7
4	*5210.00	91.7 AV			2.38 H	104	88.0	3.7
5	*5290.00	102.8 PK			2.78 H	195	98.7	4.1
6	*5290.00	93.3 AV			2.78 H	195	89.2	4.1
7	5354.00	65.1 PK	74.0	-8.9	2.78 H	195	61.0	4.1
8	5354.00	53.5 AV	54.0	-0.5	2.78 H	195	49.4	4.1
9	#10420.00	49.7 PK	74.0	-24.3	1.69 H	96	36.6	13.1
10	#10420.00	37.6 AV	54.0	-16.4	1.69 H	96	24.5	13.1
11	#10580.00	49.4 PK	74.0	-24.6	1.65 H	96	36.0	13.4
12	#10580.00	37.1 AV	54.0	-16.9	1.65 H	96	23.7	13.4
13	15630.00	53.6 PK	74.0	-20.4	2.13 H	85	40.0	13.6
14	15630.00	40.3 AV	54.0	-13.7	2.13 H	85	26.7	13.6
15	15870.00	54.1 PK	74.0	-19.9	2.14 H	92	41.1	13.0
16	15870.00	41.0 AV	54.0	-13.0	2.14 H	92	28.0	13.0

**ANTENNA POLARITY & TEST DISTANCE: VERTICAL AT 3 M**

NO.	FREQ. (MHz)	EMISSION LEVEL (dBuV/m)	LIMIT (dBuV/m)	MARGIN (dB)	ANTENNA HEIGHT (m)	TABLE ANGLE (Degree)	RAW VALUE (dBuV)	CORRECTION FACTOR (dB/m)
1	5144.00	57.6 PK	74.0	-16.4	1.44 V	122	54.0	3.6
2	5144.00	48.1 AV	54.0	-5.9	1.44 V	122	44.5	3.6
3	*5210.00	90.5 PK			1.44 V	122	86.8	3.7
4	*5210.00	79.2 AV			1.44 V	122	75.5	3.7
5	*5290.00	89.6 PK			1.56 V	125	85.5	4.1
6	*5290.00	80.2 AV			1.56 V	125	76.1	4.1
7	5354.00	51.0 PK	74.0	-23.0	1.56 V	125	46.9	4.1
8	5354.00	40.3 AV	54.0	-13.7	1.56 V	125	36.2	4.1
9	#10420.00	49.5 PK	74.0	-24.5	2.15 V	156	36.4	13.1
10	#10420.00	36.7 AV	54.0	-17.3	2.15 V	156	23.6	13.1
11	#10580.00	49.8 PK	74.0	-24.2	2.15 V	128	36.4	13.4
12	#10580.00	36.9 AV	54.0	-17.1	2.15 V	128	23.5	13.4
13	15630.00	53.4 PK	74.0	-20.6	3.25 V	102	39.8	13.6
14	15630.00	40.3 AV	54.0	-13.7	3.25 V	102	26.7	13.6
15	15870.00	52.6 PK	74.0	-21.4	3.20 V	84	39.6	13.0
16	15870.00	39.4 AV	54.0	-14.6	3.20 V	84	26.4	13.0

**REMARKS:**

1. Emission Level(dBuV/m) = Raw Value(dBuV) + Correction Factor(dB/m)
2. Correction Factor(dB/m) = Antenna Factor(dB/m) + Cable Factor(dB) – Pre-Amplifier Factor(dB)
3. The other emission levels were very low against the limit.
4. Margin value = Emission Level – Limit value
5. " \* ": Fundamental frequency.
6. " # ": The radiated frequency is out of the restricted band.

<b>CHANNEL</b>	TX Channel 42+106	<b>DETECTOR FUNCTION</b>	Peak (PK)
<b>FREQUENCY RANGE</b>	1GHz ~ 40GHz		Average (AV)

**ANTENNA POLARITY & TEST DISTANCE: HORIZONTAL AT 3 M**

NO.	FREQ. (MHz)	EMISSION LEVEL (dBuV/m)	LIMIT (dBuV/m)	MARGIN (dB)	ANTENNA HEIGHT (m)	TABLE ANGLE (Degree)	RAW VALUE (dBuV)	CORRECTION FACTOR (dB/m)
1	5145.60	60.5 PK	74.0	-13.5	3.44 H	110	56.9	3.6
2	5145.60	49.3 AV	54.0	-4.7	3.44 H	110	45.7	3.6
3	*5210.00	100.7 PK			3.44 H	110	97.0	3.7
4	*5210.00	91.9 AV			3.44 H	110	88.2	3.7
5	#5470.00	68.4 PK	74.0	-5.6	2.48 H	86	64.2	4.2
<b>6</b>	<b>#5470.00</b>	<b>53.9 AV</b>	<b>54.0</b>	<b>-0.1</b>	<b>2.48 H</b>	<b>86</b>	<b>49.7</b>	<b>4.2</b>
7	*5530.00	102.5 PK			2.48 H	86	98.3	4.2
8	*5530.00	93.2 AV			2.48 H	86	89.0	4.2
9	#5725.00	52.3 PK	74.0	-21.7	2.48 H	86	47.9	4.4
10	#5725.00	38.4 AV	54.0	-15.6	2.48 H	86	34.0	4.4
11	#10420.00	49.8 PK	74.0	-24.2	1.65 H	82	36.7	13.1
12	#10420.00	37.7 AV	54.0	-16.3	1.65 H	82	24.6	13.1
13	11060.00	50.1 PK	74.0	-23.9	1.68 H	71	36.2	13.9
14	11060.00	37.8 AV	54.0	-16.2	1.68 H	71	23.9	13.9
15	15630.00	53.2 PK	74.0	-20.8	2.13 H	95	39.6	13.6
16	15630.00	40.2 AV	54.0	-13.8	2.13 H	95	26.6	13.6
17	#16590.00	54.4 PK	74.0	-19.6	2.10 H	98	38.8	15.6
18	#16590.00	41.1 AV	54.0	-12.9	2.10 H	98	25.5	15.6

**ANTENNA POLARITY & TEST DISTANCE: VERTICAL AT 3 M**

NO.	FREQ. (MHz)	EMISSION LEVEL (dBuV/m)	LIMIT (dBuV/m)	MARGIN (dB)	ANTENNA HEIGHT (m)	TABLE ANGLE (Degree)	RAW VALUE (dBuV)	CORRECTION FACTOR (dB/m)
1	5145.60	57.6 PK	74.0	-16.4	1.48 V	119	54.0	3.6
2	5145.60	46.5 AV	54.0	-7.5	1.48 V	119	42.9	3.6
3	*5210.00	91.4 PK			1.48 V	119	87.7	3.7
4	*5210.00	80.3 AV			1.48 V	119	76.6	3.7
5	#5470.00	56.8 PK	74.0	-17.2	1.53 V	149	52.6	4.2
6	#5470.00	41.5 AV	54.0	-12.5	1.53 V	149	37.3	4.2
7	*5530.00	92.7 PK			1.53 V	149	88.5	4.2
8	*5530.00	80.4 AV			1.53 V	149	76.2	4.2
9	#5725.00	49.8 PK	74.0	-24.2	1.53 V	149	45.4	4.4
10	#5725.00	36.2 AV	54.0	-17.8	1.53 V	149	31.8	4.4
11	#10420.00	49.3 PK	74.0	-24.7	2.14 V	158	36.2	13.1
12	#10420.00	36.7 AV	54.0	-17.3	2.14 V	158	23.6	13.1
13	11060.00	49.8 PK	74.0	-24.2	2.18 V	151	35.9	13.9
14	11060.00	37.1 AV	54.0	-16.9	2.18 V	151	23.2	13.9
15	15630.00	52.9 PK	74.0	-21.1	3.25 V	107	39.3	13.6
16	15630.00	39.4 AV	54.0	-14.6	3.25 V	107	25.8	13.6
17	#16590.00	53.0 PK	74.0	-21.0	3.17 V	87	37.4	15.6
18	#16590.00	39.8 AV	54.0	-14.2	3.17 V	87	24.2	15.6

**REMARKS:**

1. Emission Level(dBuV/m) = Raw Value(dBuV) + Correction Factor(dB/m)
2. Correction Factor(dB/m) = Antenna Factor(dB/m) + Cable Factor(dB) – Pre-Amplifier Factor(dB)
3. The other emission levels were very low against the limit.
4. Margin value = Emission Level – Limit value
5. " \* ": Fundamental frequency.
6. " # ": The radiated frequency is out of the restricted band.

<b>CHANNEL</b>	TX Channel 42+122	<b>DETECTOR FUNCTION</b>	Peak (PK)
<b>FREQUENCY RANGE</b>	1GHz ~ 40GHz		Average (AV)

**ANTENNA POLARITY & TEST DISTANCE: HORIZONTAL AT 3 M**

NO.	FREQ. (MHz)	EMISSION LEVEL (dBuV/m)	LIMIT (dBuV/m)	MARGIN (dB)	ANTENNA HEIGHT (m)	TABLE ANGLE (Degree)	RAW VALUE (dBuV)	CORRECTION FACTOR (dB/m)
1	5144.00	65.1 PK	74.0	-8.9	2.53 H	292	61.5	3.6
2	5144.00	53.6 AV	54.0	-0.4	2.53 H	292	50.0	3.6
3	*5210.00	100.3 PK			2.53 H	292	96.6	3.7
4	*5210.00	91.7 AV			2.53 H	292	88.0	3.7
5	5350.00	50.0 PK	74.0	-24.0	2.53 H	292	45.9	4.1
6	5350.00	38.4 AV	54.0	-15.6	2.53 H	292	34.3	4.1
7	*5610.00	102.1 PK			2.42 H	91	97.7	4.4
8	*5610.00	93.1 AV			2.42 H	91	88.7	4.4
9	#5725.00	56.2 PK	74.0	-17.8	2.42 H	91	51.8	4.4
10	#5725.00	40.3 AV	54.0	-13.7	2.42 H	91	35.9	4.4
11	#10420.00	49.7 PK	74.0	-24.3	1.67 H	95	36.6	13.1
12	#10420.00	37.8 AV	54.0	-16.2	1.67 H	95	24.7	13.1
13	11220.00	49.7 PK	74.0	-24.3	1.69 H	81	36.0	13.7
14	11220.00	37.8 AV	54.0	-16.2	1.69 H	81	24.1	13.7
15	15630.00	53.9 PK	74.0	-20.1	2.15 H	92	40.3	13.6
16	15630.00	40.5 AV	54.0	-13.5	2.15 H	92	26.9	13.6
17	#16830.00	53.7 PK	74.0	-20.3	2.08 H	101	37.8	15.9
18	#16830.00	40.3 AV	54.0	-13.7	2.08 H	101	24.4	15.9

**ANTENNA POLARITY & TEST DISTANCE: VERTICAL AT 3 M**

NO.	FREQ. (MHz)	EMISSION LEVEL (dBuV/m)	LIMIT (dBuV/m)	MARGIN (dB)	ANTENNA HEIGHT (m)	TABLE ANGLE (Degree)	RAW VALUE (dBuV)	CORRECTION FACTOR (dB/m)
1	5144.00	52.3 PK	74.0	-21.7	1.51 V	137	48.7	3.6
2	5144.00	41.1 AV	54.0	-12.9	1.51 V	137	37.5	3.6
3	*5210.00	91.7 PK			1.51 V	137	88.0	3.7
4	*5210.00	80.6 AV			1.51 V	137	76.9	3.7
5	5350.00	47.6 PK	74.0	-26.4	1.51 V	137	43.5	4.1
6	5350.00	36.2 AV	54.0	-17.8	1.51 V	137	32.1	4.1
7	*5610.00	93.3 PK			1.43 V	143	88.9	4.4
8	*5610.00	81.0 AV			1.43 V	143	76.6	4.4
9	#5725.00	49.4 PK	74.0	-24.6	1.43 V	143	45.0	4.4
10	#5725.00	37.3 AV	54.0	-16.7	1.43 V	143	32.9	4.4
11	#10420.00	49.8 PK	74.0	-24.2	2.14 V	136	36.7	13.1
12	#10420.00	36.9 AV	54.0	-17.1	2.14 V	136	23.8	13.1
13	11220.00	49.4 PK	74.0	-24.6	2.19 V	152	35.7	13.7
14	11220.00	36.7 AV	54.0	-17.3	2.19 V	152	23.0	13.7
15	15630.00	52.8 PK	74.0	-21.2	3.27 V	108	39.2	13.6
16	15630.00	39.7 AV	54.0	-14.3	3.27 V	108	26.1	13.6
17	#16830.00	52.7 PK	74.0	-21.3	3.25 V	87	36.8	15.9
18	#16830.00	39.6 AV	54.0	-14.4	3.25 V	87	23.7	15.9

**REMARKS:**

1. Emission Level(dBuV/m) = Raw Value(dBuV) + Correction Factor(dB/m)
2. Correction Factor(dB/m) = Antenna Factor(dB/m) + Cable Factor(dB) – Pre-Amplifier Factor(dB)
3. The other emission levels were very low against the limit.
4. Margin value = Emission Level – Limit value
5. " \* ": Fundamental frequency.
6. " # ": The radiated frequency is out of the restricted band.

<b>CHANNEL</b>	TX Channel 42+138	<b>DETECTOR FUNCTION</b>	Peak (PK)
<b>FREQUENCY RANGE</b>	1GHz ~ 40GHz		Average (AV)

**ANTENNA POLARITY & TEST DISTANCE: HORIZONTAL AT 3 M**

NO.	FREQ. (MHz)	EMISSION LEVEL (dBuV/m)	LIMIT (dBuV/m)	MARGIN (dB)	ANTENNA HEIGHT (m)	TABLE ANGLE (Degree)	RAW VALUE (dBuV)	CORRECTION FACTOR (dB/m)
1	5144.00	65.3 PK	74.0	-8.7	2.53 H	292	61.7	3.6
2	5144.00	53.6 AV	54.0	-0.4	2.53 H	292	50.0	3.6
3	*5210.00	100.2 PK			2.53 H	292	96.5	3.7
4	*5210.00	91.8 AV			2.53 H	292	88.1	3.7
5	5350.00	50.7 PK	74.0	-23.3	2.53 H	292	46.6	4.1
6	5350.00	38.6 AV	54.0	-15.4	2.53 H	292	34.5	4.1
7	#5470.00	50.4 PK	74.0	-23.6	2.45 H	90	46.2	4.2
8	#5470.00	38.1 AV	54.0	-15.9	2.45 H	90	33.9	4.2
9	*5690.00	102.3 PK			2.45 H	90	97.8	4.5
10	*5690.00	93.2 AV			2.45 H	90	88.7	4.5
11	#5850.00	49.0 PK	74.0	-25.0	2.45 H	90	44.5	4.5
12	#5850.00	37.3 AV	54.0	-16.7	2.45 H	90	32.8	4.5
13	#10420.00	49.7 PK	74.0	-24.3	1.67 H	66	36.6	13.1
14	#10420.00	37.4 AV	54.0	-16.6	1.67 H	66	24.3	13.1
15	11380.00	50.0 PK	74.0	-24.0	1.71 H	75	36.4	13.6
16	11380.00	37.7 AV	54.0	-16.3	1.71 H	75	24.1	13.6
17	15630.00	54.1 PK	74.0	-19.9	2.16 H	90	40.5	13.6
18	15630.00	40.8 AV	54.0	-13.2	2.16 H	90	27.2	13.6
19	#17070.00	54.4 PK	74.0	-19.6	2.12 H	97	37.1	17.3
20	#17070.00	41.1 AV	54.0	-12.9	2.12 H	97	23.8	17.3

**ANTENNA POLARITY & TEST DISTANCE: VERTICAL AT 3 M**

NO.	FREQ. (MHz)	EMISSION LEVEL (dBuV/m)	LIMIT (dBuV/m)	MARGIN (dB)	ANTENNA HEIGHT (m)	TABLE ANGLE (Degree)	RAW VALUE (dBuV)	CORRECTION FACTOR (dB/m)
1	5144.00	53.8 PK	74.0	-20.2	1.53 V	139	50.2	3.6
2	5144.00	41.5 AV	54.0	-12.5	1.53 V	139	37.9	3.6
3	*5210.00	90.9 PK			1.53 V	139	87.2	3.7
4	*5210.00	79.7 AV			1.53 V	139	76.0	3.7
5	5350.00	48.4 PK	74.0	-25.6	1.53 V	139	44.3	4.1
6	5350.00	35.6 AV	54.0	-18.4	1.53 V	139	31.5	4.1
7	#5470.00	48.3 PK	74.0	-25.7	1.50 V	136	44.1	4.2
8	#5470.00	36.4 AV	54.0	-17.6	1.50 V	136	32.2	4.2
9	*5690.00	91.5 PK			1.50 V	136	87.0	4.5
10	*5690.00	80.4 AV			1.50 V	136	75.9	4.5
11	#5850.00	46.7 PK	74.0	-27.3	1.50 V	136	42.2	4.5
12	#5850.00	35.7 AV	54.0	-18.3	1.50 V	136	31.2	4.5
13	#10420.00	49.2 PK	74.0	-24.8	2.14 V	148	36.1	13.1
14	#10420.00	36.8 AV	54.0	-17.2	2.14 V	148	23.7	13.1
15	11380.00	49.4 PK	74.0	-24.6	2.13 V	155	35.8	13.6
16	11380.00	36.4 AV	54.0	-17.6	2.13 V	155	22.8	13.6
17	15630.00	53.1 PK	74.0	-20.9	3.19 V	86	39.5	13.6
18	15630.00	39.8 AV	54.0	-14.2	3.19 V	86	26.2	13.6
19	#17070.00	53.3 PK	74.0	-20.7	3.17 V	86	36.0	17.3
20	#17070.00	40.1 AV	54.0	-13.9	3.17 V	86	22.8	17.3



**REMARKS:**

1. Emission Level(dBuV/m) = Raw Value(dBuV) + Correction Factor(dB/m)
2. Correction Factor(dB/m) = Antenna Factor(dB/m) + Cable Factor(dB) – Pre-Amplifier Factor(dB)
3. The other emission levels were very low against the limit.
4. Margin value = Emission Level – Limit value
5. " \* ": Fundamental frequency.
6. " # ": The radiated frequency is out of the restricted band.

<b>CHANNEL</b>	TX Channel 58+106	<b>DETECTOR FUNCTION</b>	Peak (PK)
<b>FREQUENCY RANGE</b>	1GHz ~ 40GHz		Average (AV)

**ANTENNA POLARITY & TEST DISTANCE: HORIZONTAL AT 3 M**

NO.	FREQ. (MHz)	EMISSION LEVEL (dBuV/m)	LIMIT (dBuV/m)	MARGIN (dB)	ANTENNA HEIGHT (m)	TABLE ANGLE (Degree)	RAW VALUE (dBuV)	CORRECTION FACTOR (dB/m)
1	5150.00	47.7 PK	74.0	-26.3	2.67 H	324	44.0	3.7
2	5150.00	37.3 AV	54.0	-16.7	2.67 H	324	33.6	3.7
3	*5290.00	101.9 PK			2.67 H	324	97.8	4.1
4	*5290.00	91.7 AV			2.67 H	324	87.6	4.1
5	5450.00	61.6 PK	74.0	-12.4	2.67 H	324	57.4	4.2
6	5450.00	49.0 AV	54.0	-5.0	2.67 H	324	44.8	4.2
7	#5470.00	68.0 PK	74.0	-6.0	2.38 H	85	63.8	4.2
<b>8</b>	<b>#5470.00</b>	<b>53.9 AV</b>	<b>54.0</b>	<b>-0.1</b>	<b>2.38 H</b>	<b>85</b>	<b>49.7</b>	<b>4.2</b>
9	*5530.00	102.5 PK			2.38 H	85	98.3	4.2
10	*5530.00	93.4 AV			2.38 H	85	89.2	4.2
11	#5725.00	50.3 PK	74.0	-23.7	2.38 H	85	45.9	4.4
12	#5725.00	38.5 AV	54.0	-15.5	2.38 H	85	34.1	4.4
13	#10580.00	50.0 PK	74.0	-24.0	1.70 H	71	36.6	13.4
14	#10580.00	37.8 AV	54.0	-16.2	1.70 H	71	24.4	13.4
15	11060.00	50.0 PK	74.0	-24.0	1.65 H	76	36.1	13.9
16	11060.00	37.9 AV	54.0	-16.1	1.65 H	76	24.0	13.9
17	15870.00	54.0 PK	74.0	-20.0	2.15 H	99	41.0	13.0
18	15870.00	40.7 AV	54.0	-13.3	2.15 H	99	27.7	13.0
19	#16590.00	53.2 PK	74.0	-20.8	2.12 H	90	37.6	15.6
20	#16590.00	40.2 AV	54.0	-13.8	2.12 H	90	24.6	15.6

**ANTENNA POLARITY & TEST DISTANCE: VERTICAL AT 3 M**

NO.	FREQ. (MHz)	EMISSION LEVEL (dBuV/m)	LIMIT (dBuV/m)	MARGIN (dB)	ANTENNA HEIGHT (m)	TABLE ANGLE (Degree)	RAW VALUE (dBuV)	CORRECTION FACTOR (dB/m)
1	5150.00	46.8 PK	74.0	-27.2	1.52 V	144	43.1	3.7
2	5150.00	36.1 AV	54.0	-17.9	1.52 V	144	32.4	3.7
3	*5290.00	90.8 PK			1.52 V	144	86.7	4.1
4	*5290.00	79.6 AV			1.52 V	144	75.5	4.1
5	5450.00	60.1 PK	74.0	-13.9	1.52 V	144	55.9	4.2
6	5450.00	48.4 AV	54.0	-5.6	1.52 V	144	44.2	4.2
7	#5470.00	53.1 PK	74.0	-20.9	1.47 V	130	48.9	4.2
8	#5470.00	40.8 AV	54.0	-13.2	1.47 V	130	36.6	4.2
9	*5530.00	91.7 PK			1.47 V	130	87.5	4.2
10	*5530.00	80.6 AV			1.47 V	130	76.4	4.2
11	#5725.00	48.5 PK	74.0	-25.5	1.47 V	130	44.1	4.4
12	#5725.00	36.4 AV	54.0	-17.6	1.47 V	130	32.0	4.4
13	#10580.00	49.1 PK	74.0	-24.9	2.21 V	147	35.7	13.4
14	#10580.00	36.7 AV	54.0	-17.3	2.21 V	147	23.3	13.4
15	11060.00	49.3 PK	74.0	-24.7	2.21 V	149	35.4	13.9
16	11060.00	36.5 AV	54.0	-17.5	2.21 V	149	22.6	13.9
17	15870.00	53.2 PK	74.0	-20.8	3.22 V	86	40.2	13.0
18	15870.00	40.0 AV	54.0	-14.0	3.22 V	86	27.0	13.0
19	#16590.00	53.2 PK	74.0	-20.8	3.24 V	85	37.6	15.6
20	#16590.00	40.1 AV	54.0	-13.9	3.24 V	85	24.5	15.6

**REMARKS:**

1. Emission Level(dBuV/m) = Raw Value(dBuV) + Correction Factor(dB/m)
2. Correction Factor(dB/m) = Antenna Factor(dB/m) + Cable Factor(dB) – Pre-Amplifier Factor(dB)
3. The other emission levels were very low against the limit.
4. Margin value = Emission Level – Limit value
5. " \* ": Fundamental frequency.
6. " # ": The radiated frequency is out of the restricted band.

<b>CHANNEL</b>	TX Channel 58+122	<b>DETECTOR FUNCTION</b>	Peak (PK)
<b>FREQUENCY RANGE</b>	1GHz ~ 40GHz		Average (AV)

**ANTENNA POLARITY & TEST DISTANCE: HORIZONTAL AT 3 M**

NO.	FREQ. (MHz)	EMISSION LEVEL (dBuV/m)	LIMIT (dBuV/m)	MARGIN (dB)	ANTENNA HEIGHT (m)	TABLE ANGLE (Degree)	RAW VALUE (dBuV)	CORRECTION FACTOR (dB/m)
1	5150.00	50.0 PK	74.0	-24.0	3.23 H	310	46.3	3.7
2	5150.00	40.7 AV	54.0	-13.3	3.23 H	310	37.0	3.7
3	*5290.00	104.1 PK			3.23 H	310	100.0	4.1
4	*5290.00	94.6 AV			3.23 H	310	90.5	4.1
5	5356.80	66.5 PK	74.0	-7.5	3.23 H	310	62.4	4.1
<b>6</b>	<b>5356.80</b>	<b>53.9 AV</b>	<b>54.0</b>	<b>-0.1</b>	<b>3.23 H</b>	<b>310</b>	<b>49.8</b>	<b>4.1</b>
7	*5610.00	105.0 PK			2.65 H	88	100.6	4.4
8	*5610.00	95.2 AV			2.65 H	88	90.8	4.4
9	#5923.40	56.6 PK	74.0	-17.4	2.65 H	88	51.9	4.7
10	#5923.40	41.4 AV	54.0	-12.6	2.65 H	88	36.7	4.7
11	#10580.00	49.6 PK	74.0	-24.4	1.71 H	69	36.2	13.4
12	#10580.00	37.4 AV	54.0	-16.6	1.71 H	69	24.0	13.4
13	11220.00	49.4 PK	74.0	-24.6	1.74 H	69	35.7	13.7
14	11220.00	37.3 AV	54.0	-16.7	1.74 H	69	23.6	13.7
15	15870.00	54.1 PK	74.0	-19.9	2.13 H	101	41.1	13.0
16	15870.00	40.7 AV	54.0	-13.3	2.13 H	101	27.7	13.0
17	#16830.00	54.3 PK	74.0	-19.7	2.09 H	113	38.4	15.9
18	#16830.00	40.9 AV	54.0	-13.1	2.09 H	113	25.0	15.9

**ANTENNA POLARITY & TEST DISTANCE: VERTICAL AT 3 M**

NO.	FREQ. (MHz)	EMISSION LEVEL (dBuV/m)	LIMIT (dBuV/m)	MARGIN (dB)	ANTENNA HEIGHT (m)	TABLE ANGLE (Degree)	RAW VALUE (dBuV)	CORRECTION FACTOR (dB/m)
1	5150.00	47.6 PK	74.0	-26.4	1.50 V	149	43.9	3.7
2	5150.00	38.4 AV	54.0	-15.6	1.50 V	149	34.7	3.7
3	*5290.00	92.3 PK			1.50 V	149	88.2	4.1
4	*5290.00	81.1 AV			1.50 V	149	77.0	4.1
5	5356.80	64.6 PK	74.0	-9.4	1.50 V	149	60.5	4.1
6	5356.80	41.8 AV	54.0	-12.2	1.50 V	149	37.7	4.1
7	*5610.00	93.0 PK			1.48 V	135	88.6	4.4
8	*5610.00	81.8 AV			1.48 V	135	77.4	4.4
9	#5923.40	50.7 PK	74.0	-23.3	1.48 V	135	46.0	4.7
10	#5923.40	39.4 AV	54.0	-14.6	1.48 V	135	34.7	4.7
11	#10580.00	49.7 PK	74.0	-24.3	2.22 V	139	36.3	13.4
12	#10580.00	36.9 AV	54.0	-17.1	2.22 V	139	23.5	13.4
13	11220.00	49.5 PK	74.0	-24.5	2.17 V	140	35.8	13.7
14	11220.00	36.5 AV	54.0	-17.5	2.17 V	140	22.8	13.7
15	15870.00	53.2 PK	74.0	-20.8	3.24 V	74	40.2	13.0
16	15870.00	40.0 AV	54.0	-14.0	3.24 V	74	27.0	13.0
17	#16830.00	53.5 PK	74.0	-20.5	3.16 V	98	37.6	15.9
18	#16830.00	40.1 AV	54.0	-13.9	3.16 V	98	24.2	15.9

**REMARKS:**

1. Emission Level(dBuV/m) = Raw Value(dBuV) + Correction Factor(dB/m)
2. Correction Factor(dB/m) = Antenna Factor(dB/m) + Cable Factor(dB) – Pre-Amplifier Factor(dB)
3. The other emission levels were very low against the limit.
4. Margin value = Emission Level – Limit value
5. " \* ": Fundamental frequency.
6. " # ": The radiated frequency is out of the restricted band.

<b>CHANNEL</b>	TX Channel 58+138	<b>DETECTOR FUNCTION</b>	Peak (PK)
<b>FREQUENCY RANGE</b>	1GHz ~ 40GHz		Average (AV)

**ANTENNA POLARITY & TEST DISTANCE: HORIZONTAL AT 3 M**

NO.	FREQ. (MHz)	EMISSION LEVEL (dBuV/m)	LIMIT (dBuV/m)	MARGIN (dB)	ANTENNA HEIGHT (m)	TABLE ANGLE (Degree)	RAW VALUE (dBuV)	CORRECTION FACTOR (dB/m)
1	5150.00	50.0 PK	74.0	-24.0	3.23 H	310	46.3	3.7
2	5150.00	40.7 AV	54.0	-13.3	3.23 H	310	37.0	3.7
3	*5290.00	104.1 PK			3.23 H	310	100.0	4.1
4	*5290.00	94.6 AV			3.23 H	310	90.5	4.1
5	5356.80	66.5 PK	74.0	-7.5	3.23 H	310	62.4	4.1
<b>6</b>	<b>5356.80</b>	<b>53.9 AV</b>	<b>54.0</b>	<b>-0.1</b>	<b>3.23 H</b>	<b>310</b>	<b>49.8</b>	<b>4.1</b>
7	#5470.00	50.5 PK	74.0	-23.5	2.66 H	92	46.3	4.2
8	#5470.00	38.5 AV	54.0	-15.5	2.66 H	92	34.3	4.2
9	*5690.00	104.2 PK			2.66 H	92	99.7	4.5
10	*5690.00	94.7 AV			2.66 H	92	90.2	4.5
11	#5850.00	49.0 PK	74.0	-25.0	2.66 H	92	44.5	4.5
12	#5850.00	37.3 AV	54.0	-16.7	2.66 H	92	32.8	4.5
13	#10580.00	49.6 PK	74.0	-24.4	1.67 H	89	36.2	13.4
14	#10580.00	37.5 AV	54.0	-16.5	1.67 H	89	24.1	13.4
15	11380.00	49.6 PK	74.0	-24.4	1.64 H	89	36.0	13.6
16	11380.00	37.4 AV	54.0	-16.6	1.64 H	89	23.8	13.6
17	15870.00	53.6 PK	74.0	-20.4	2.16 H	114	40.6	13.0
18	15870.00	40.2 AV	54.0	-13.8	2.16 H	114	27.2	13.0
19	#17070.00	53.6 PK	74.0	-20.4	2.17 H	86	36.3	17.3
20	#17070.00	40.3 AV	54.0	-13.7	2.17 H	86	23.0	17.3

**ANTENNA POLARITY & TEST DISTANCE: VERTICAL AT 3 M**

NO.	FREQ. (MHz)	EMISSION LEVEL (dBuV/m)	LIMIT (dBuV/m)	MARGIN (dB)	ANTENNA HEIGHT (m)	TABLE ANGLE (Degree)	RAW VALUE (dBuV)	CORRECTION FACTOR (dB/m)
1	5150.00	50.6 PK	74.0	-23.4	1.48 V	136	46.9	3.7
2	5150.00	39.4 AV	54.0	-14.6	1.48 V	136	35.7	3.7
3	*5290.00	92.4 PK			1.48 V	136	88.3	4.1
4	*5290.00	81.1 AV			1.48 V	136	77.0	4.1
5	5356.80	53.0 PK	74.0	-21.0	1.48 V	136	48.9	4.1
6	5356.80	41.7 AV	54.0	-12.3	1.48 V	136	37.6	4.1
7	#5470.00	48.2 PK	74.0	-25.8	1.49 V	144	44.0	4.2
8	#5470.00	36.4 AV	54.0	-17.6	1.49 V	144	32.2	4.2
9	*5690.00	94.7 PK			1.49 V	144	90.2	4.5
10	*5690.00	82.5 AV			1.49 V	144	78.0	4.5
11	#5850.00	47.4 PK	74.0	-26.6	1.49 V	144	42.9	4.5
12	#5850.00	35.8 AV	54.0	-18.2	1.49 V	144	31.3	4.5
13	#10580.00	50.0 PK	74.0	-24.0	2.23 V	149	36.6	13.4
14	#10580.00	37.0 AV	54.0	-17.0	2.23 V	149	23.6	13.4
15	11380.00	49.6 PK	74.0	-24.4	2.22 V	149	36.0	13.6
16	11380.00	37.1 AV	54.0	-16.9	2.22 V	149	23.5	13.6
17	15870.00	53.5 PK	74.0	-20.5	3.23 V	101	40.5	13.0
18	15870.00	40.3 AV	54.0	-13.7	3.23 V	101	27.3	13.0
19	#17070.00	53.6 PK	74.0	-20.4	3.15 V	73	36.3	17.3
20	#17070.00	40.2 AV	54.0	-13.8	3.15 V	73	22.9	17.3

**REMARKS:**

1. Emission Level(dBuV/m) = Raw Value(dBuV) + Correction Factor(dB/m)
2. Correction Factor(dB/m) = Antenna Factor(dB/m) + Cable Factor(dB) – Pre-Amplifier Factor(dB)
3. The other emission levels were very low against the limit.
4. Margin value = Emission Level – Limit value
5. " \* ": Fundamental frequency.
6. " # ": The radiated frequency is out of the restricted band.

<b>CHANNEL</b>	TX Channel 58+155	<b>DETECTOR FUNCTION</b>	Peak (PK)
<b>FREQUENCY RANGE</b>	1GHz ~ 40GHz		Average (AV)

**ANTENNA POLARITY & TEST DISTANCE: HORIZONTAL AT 3 M**

NO.	FREQ. (MHz)	EMISSION LEVEL (dBuV/m)	LIMIT (dBuV/m)	MARGIN (dB)	ANTENNA HEIGHT (m)	TABLE ANGLE (Degree)	RAW VALUE (dBuV)	CORRECTION FACTOR (dB/m)
1	5150.00	50.0 PK	74.0	-24.0	3.23 H	310	46.3	3.7
2	5150.00	40.7 AV	54.0	-13.3	3.23 H	310	37.0	3.7
3	*5290.00	104.1 PK			3.23 H	310	100.0	4.1
4	*5290.00	94.6 AV			3.23 H	310	90.5	4.1
5	5350.00	66.5 PK	74.0	-7.5	3.23 H	310	62.4	4.1
<b>6</b>	<b>5350.00</b>	<b>53.9 AV</b>	<b>54.0</b>	<b>-0.1</b>	<b>3.23 H</b>	<b>310</b>	<b>49.8</b>	<b>4.1</b>
7	*5775.00	104.3 PK			2.83 H	93	99.9	4.4
8	*5775.00	95.2 AV			2.83 H	93	90.8	4.4
9	#10580.00	49.5 PK	74.0	-24.5	1.74 H	76	36.1	13.4
10	#10580.00	37.2 AV	54.0	-16.8	1.74 H	76	23.8	13.4
11	11550.00	49.7 PK	74.0	-24.3	1.66 H	81	36.2	13.5
12	11550.00	37.5 AV	54.0	-16.5	1.66 H	81	24.0	13.5
13	15870.00	53.8 PK	74.0	-20.2	2.09 H	110	40.8	13.0
14	15870.00	40.8 AV	54.0	-13.2	2.09 H	110	27.8	13.0
15	#17325.00	53.3 PK	74.0	-20.7	2.10 H	86	35.5	17.8
16	#17325.00	40.4 AV	54.0	-13.6	2.10 H	86	22.6	17.8

**ANTENNA POLARITY & TEST DISTANCE: VERTICAL AT 3 M**

NO.	FREQ. (MHz)	EMISSION LEVEL (dBuV/m)	LIMIT (dBuV/m)	MARGIN (dB)	ANTENNA HEIGHT (m)	TABLE ANGLE (Degree)	RAW VALUE (dBuV)	CORRECTION FACTOR (dB/m)
1	5150.00	50.5 PK	74.0	-23.5	1.53 V	137	46.8	3.7
2	5150.00	38.4 AV	54.0	-15.6	1.53 V	137	34.7	3.7
3	*5290.00	93.4 PK			1.53 V	137	89.3	4.1
4	*5290.00	81.2 AV			1.53 V	137	77.1	4.1
5	5350.00	53.2 PK	74.0	-20.8	1.53 V	137	49.1	4.1
6	5350.00	41.1 AV	54.0	-12.9	1.53 V	137	37.0	4.1
7	*5775.00	92.0 PK			2.37 V	146	87.6	4.4
8	*5775.00	82.7 AV			2.37 V	146	78.3	4.4
9	#10580.00	49.8 PK	74.0	-24.2	2.17 V	131	36.4	13.4
10	#10580.00	37.0 AV	54.0	-17.0	2.17 V	131	23.6	13.4
11	11550.00	49.1 PK	74.0	-24.9	2.19 V	128	35.6	13.5
12	11550.00	36.5 AV	54.0	-17.5	2.19 V	128	23.0	13.5
13	15870.00	53.1 PK	74.0	-20.9	3.26 V	82	40.1	13.0
14	15870.00	39.9 AV	54.0	-14.1	3.26 V	82	26.9	13.0
15	#17325.00	52.9 PK	74.0	-21.1	3.25 V	75	35.1	17.8
16	#17325.00	39.9 AV	54.0	-14.1	3.25 V	75	22.1	17.8

**REMARKS:**

1. Emission Level(dBuV/m) = Raw Value(dBuV) + Correction Factor(dB/m)
2. Correction Factor(dB/m) = Antenna Factor(dB/m) + Cable Factor(dB) – Pre-Amplifier Factor(dB)
3. The other emission levels were very low against the limit.
4. Margin value = Emission Level – Limit value
5. " \* ": Fundamental frequency.
6. " # ": The radiated frequency is out of the restricted band.



<b>CHANNEL</b>	TX Channel 106+122	<b>DETECTOR FUNCTION</b>	Peak (PK)
<b>FREQUENCY RANGE</b>	1GHz ~ 40GHz		Average (AV)

**ANTENNA POLARITY & TEST DISTANCE: HORIZONTAL AT 3 M**

NO.	FREQ. (MHz)	EMISSION LEVEL (dBuV/m)	LIMIT (dBuV/m)	MARGIN (dB)	ANTENNA HEIGHT (m)	TABLE ANGLE (Degree)	RAW VALUE (dBuV)	CORRECTION FACTOR (dB/m)
1	#5470.00	68.4 PK	74.0	-5.6	2.69 H	100	64.2	4.2
2	#5470.00	53.9 AV	54.0	-0.1	2.69 H	100	49.7	4.2
3	*5530.00	103.7 PK			2.69 H	100	99.5	4.2
4	*5530.00	94.0 AV			2.69 H	100	89.8	4.2
5	*5610.00	102.9 PK			2.75 H	90	98.5	4.4
6	*5610.00	93.1 AV			2.75 H	90	88.7	4.4
7	#5725.00	51.8 PK	74.0	-22.2	2.69 H	100	47.4	4.4
8	#5725.00	40.0 AV	54.0	-14.0	2.69 H	100	35.6	4.4
9	11060.00	49.8 PK	74.0	-24.2	1.64 H	81	35.9	13.9
10	11060.00	37.7 AV	54.0	-16.3	1.64 H	81	23.8	13.9
11	11220.00	49.6 PK	74.0	-24.4	1.63 H	69	35.9	13.7
12	11220.00	37.6 AV	54.0	-16.4	1.63 H	69	23.9	13.7
13	#16590.00	53.3 PK	74.0	-20.7	2.14 H	112	37.7	15.6
14	#16590.00	40.3 AV	54.0	-13.7	2.14 H	112	24.7	15.6
15	#16830.00	53.8 PK	74.0	-20.2	2.12 H	87	37.9	15.9
16	#16830.00	40.5 AV	54.0	-13.5	2.12 H	87	24.6	15.9

**ANTENNA POLARITY & TEST DISTANCE: VERTICAL AT 3 M**

NO.	FREQ. (MHz)	EMISSION LEVEL (dBuV/m)	LIMIT (dBuV/m)	MARGIN (dB)	ANTENNA HEIGHT (m)	TABLE ANGLE (Degree)	RAW VALUE (dBuV)	CORRECTION FACTOR (dB/m)
1	#5470.00	62.8 PK	74.0	-11.2	1.48 V	142	58.6	4.2
2	#5470.00	51.7 AV	54.0	-2.3	1.48 V	142	47.5	4.2
3	*5530.00	91.0 PK			1.48 V	142	86.8	4.2
4	*5530.00	80.8 AV			1.48 V	142	76.6	4.2
5	*5610.00	91.3 PK			1.55 V	148	86.9	4.4
6	*5610.00	80.2 AV			1.55 V	148	75.8	4.4
7	#5725.00	49.6 PK	74.0	-24.4	1.48 V	142	45.2	4.4
8	#5725.00	38.4 AV	54.0	-15.6	1.48 V	142	34.0	4.4
9	11060.00	49.6 PK	74.0	-24.4	2.14 V	157	35.7	13.9
10	11060.00	36.7 AV	54.0	-17.3	2.14 V	157	22.8	13.9
11	11220.00	49.6 PK	74.0	-24.4	2.23 V	159	35.9	13.7
12	11220.00	36.7 AV	54.0	-17.3	2.23 V	159	23.0	13.7
13	#16590.00	53.4 PK	74.0	-20.6	3.25 V	82	37.8	15.6
14	#16590.00	39.9 AV	54.0	-14.1	3.25 V	82	24.3	15.6
15	#16830.00	52.9 PK	74.0	-21.1	3.24 V	96	37.0	15.9
16	#16830.00	39.7 AV	54.0	-14.3	3.24 V	96	23.8	15.9

**REMARKS:**

1. Emission Level(dBuV/m) = Raw Value(dBuV) + Correction Factor(dB/m)
2. Correction Factor(dB/m) = Antenna Factor(dB/m) + Cable Factor(dB) – Pre-Amplifier Factor(dB)
3. The other emission levels were very low against the limit.
4. Margin value = Emission Level – Limit value
5. " \* ": Fundamental frequency.
6. " # ": The radiated frequency is out of the restricted band.

<b>CHANNEL</b>	TX Channel 106+138	<b>DETECTOR FUNCTION</b>	Peak (PK)
<b>FREQUENCY RANGE</b>	1GHz ~ 40GHz		Average (AV)

**ANTENNA POLARITY & TEST DISTANCE: HORIZONTAL AT 3 M**

NO.	FREQ. (MHz)	EMISSION LEVEL (dBuV/m)	LIMIT (dBuV/m)	MARGIN (dB)	ANTENNA HEIGHT (m)	TABLE ANGLE (Degree)	RAW VALUE (dBuV)	CORRECTION FACTOR (dB/m)
1	#5470.00	67.5 PK	74.0	-6.5	2.60 H	122	63.3	4.2
2	#5470.00	53.5 AV	54.0	-0.5	2.60 H	122	49.3	4.2
3	*5530.00	102.6 PK			2.60 H	122	98.4	4.2
4	*5530.00	93.7 AV			2.60 H	122	89.5	4.2
5	*5690.00	102.4 PK			2.63 H	120	97.9	4.5
6	*5690.00	92.6 AV			2.63 H	120	88.1	4.5
7	#5850.00	50.6 PK	74.0	-23.4	2.63 H	120	46.1	4.5
8	#5850.00	40.6 AV	54.0	-13.4	2.63 H	120	36.1	4.5
9	11060.00	49.5 PK	74.0	-24.5	1.65 H	87	35.6	13.9
10	11060.00	37.1 AV	54.0	-16.9	1.65 H	87	23.2	13.9
11	11380.00	49.8 PK	74.0	-24.2	1.68 H	80	36.2	13.6
12	11380.00	37.6 AV	54.0	-16.4	1.68 H	80	24.0	13.6
13	#16590.00	53.6 PK	74.0	-20.4	2.15 H	86	38.0	15.6
14	#16590.00	40.3 AV	54.0	-13.7	2.15 H	86	24.7	15.6
15	#17070.00	54.2 PK	74.0	-19.8	2.14 H	107	36.9	17.3
16	#17070.00	40.8 AV	54.0	-13.2	2.14 H	107	23.5	17.3

**ANTENNA POLARITY & TEST DISTANCE: VERTICAL AT 3 M**

NO.	FREQ. (MHz)	EMISSION LEVEL (dBuV/m)	LIMIT (dBuV/m)	MARGIN (dB)	ANTENNA HEIGHT (m)	TABLE ANGLE (Degree)	RAW VALUE (dBuV)	CORRECTION FACTOR (dB/m)
1	#5470.00	62.8 PK	74.0	-11.2	1.48 V	142	58.6	4.2
2	#5470.00	51.7 AV	54.0	-2.3	1.48 V	142	47.5	4.2
3	*5530.00	91.0 PK			1.48 V	142	86.8	4.2
4	*5530.00	80.8 AV			1.48 V	142	76.6	4.2
5	*5690.00	91.6 PK			1.55 V	163	87.1	4.5
6	*5690.00	80.4 AV			1.55 V	163	75.9	4.5
7	#5850.00	50.1 PK	74.0	-23.9	1.55 V	163	45.6	4.5
8	#5850.00	38.4 AV	54.0	-15.6	1.55 V	163	33.9	4.5
9	11060.00	49.4 PK	74.0	-24.6	2.17 V	145	35.5	13.9
10	11060.00	37.0 AV	54.0	-17.0	2.17 V	145	23.1	13.9
11	11380.00	48.9 PK	74.0	-25.1	2.21 V	128	35.3	13.6
12	11380.00	36.2 AV	54.0	-17.8	2.21 V	128	22.6	13.6
13	#16590.00	52.5 PK	74.0	-21.5	3.16 V	99	36.9	15.6
14	#16590.00	39.4 AV	54.0	-14.6	3.16 V	99	23.8	15.6
15	#17070.00	53.0 PK	74.0	-21.0	3.16 V	79	35.7	17.3
16	#17070.00	39.5 AV	54.0	-14.5	3.16 V	79	22.2	17.3

**REMARKS:**

1. Emission Level(dBuV/m) = Raw Value(dBuV) + Correction Factor(dB/m)
2. Correction Factor(dB/m) = Antenna Factor(dB/m) + Cable Factor(dB) – Pre-Amplifier Factor(dB)
3. The other emission levels were very low against the limit.
4. Margin value = Emission Level – Limit value
5. " \* ": Fundamental frequency.
6. " # ": The radiated frequency is out of the restricted band.

<b>CHANNEL</b>	TX Channel 106+155	<b>DETECTOR FUNCTION</b>	Peak (PK)
<b>FREQUENCY RANGE</b>	1GHz ~ 40GHz		Average (AV)

**ANTENNA POLARITY & TEST DISTANCE: HORIZONTAL AT 3 M**

NO.	FREQ. (MHz)	EMISSION LEVEL (dBuV/m)	LIMIT (dBuV/m)	MARGIN (dB)	ANTENNA HEIGHT (m)	TABLE ANGLE (Degree)	RAW VALUE (dBuV)	CORRECTION FACTOR (dB/m)
1	#5470.00	67.8 PK	74.0	-6.2	2.60 H	122	63.6	4.2
2	#5470.00	53.6 AV	54.0	-0.4	2.60 H	122	49.4	4.2
3	*5530.00	102.5 PK			2.60 H	122	98.3	4.2
4	*5530.00	93.2 AV			2.60 H	122	89.0	4.2
5	*5775.00	102.1 PK			2.75 H	90	97.7	4.4
6	*5775.00	92.5 AV			2.75 H	90	88.1	4.4
7	#5850.00	62.2 PK	74.0	-11.8	2.60 H	122	57.7	4.5
8	#5850.00	49.2 AV	54.0	-4.8	2.60 H	122	44.7	4.5
9	11060.00	49.4 PK	74.0	-24.6	1.73 H	82	35.5	13.9
10	11060.00	37.4 AV	54.0	-16.6	1.73 H	82	23.5	13.9
11	11550.00	49.5 PK	74.0	-24.5	1.74 H	72	36.0	13.5
12	11550.00	37.1 AV	54.0	-16.9	1.74 H	72	23.6	13.5
13	#16590.00	54.2 PK	74.0	-19.8	2.19 H	107	38.6	15.6
14	#16590.00	40.8 AV	54.0	-13.2	2.19 H	107	25.2	15.6
15	#17325.00	54.0 PK	74.0	-20.0	2.15 H	99	36.2	17.8
16	#17325.00	40.7 AV	54.0	-13.3	2.15 H	99	22.9	17.8

**ANTENNA POLARITY & TEST DISTANCE: VERTICAL AT 3 M**

NO.	FREQ. (MHz)	EMISSION LEVEL (dBuV/m)	LIMIT (dBuV/m)	MARGIN (dB)	ANTENNA HEIGHT (m)	TABLE ANGLE (Degree)	RAW VALUE (dBuV)	CORRECTION FACTOR (dB/m)
1	#5470.00	62.8 PK	74.0	-11.2	1.48 V	142	58.6	4.2
2	#5470.00	51.7 AV	54.0	-2.3	1.48 V	142	47.5	4.2
3	*5530.00	91.0 PK			1.48 V	142	86.8	4.2
4	*5530.00	80.8 AV			1.48 V	142	76.6	4.2
5	*5775.00	84.7 PK			2.33 V	300	80.3	4.4
6	*5775.00	76.0 AV			2.33 V	300	71.6	4.4
7	#5850.00	59.4 PK	74.0	-14.6	1.48 V	142	54.9	4.5
8	#5850.00	48.4 AV	54.0	-5.6	1.48 V	142	43.9	4.5
9	11060.00	48.7 PK	74.0	-25.3	2.18 V	132	34.8	13.9
10	11060.00	36.2 AV	54.0	-17.8	2.18 V	132	22.3	13.9
11	11550.00	49.9 PK	74.0	-24.1	2.24 V	127	36.4	13.5
12	11550.00	37.0 AV	54.0	-17.0	2.24 V	127	23.5	13.5
13	#16590.00	52.9 PK	74.0	-21.1	3.22 V	87	37.3	15.6
14	#16590.00	39.7 AV	54.0	-14.3	3.22 V	87	24.1	15.6
15	#17325.00	52.9 PK	74.0	-21.1	3.18 V	79	35.1	17.8
16	#17325.00	39.8 AV	54.0	-14.2	3.18 V	79	22.0	17.8

**REMARKS:**

1. Emission Level(dBuV/m) = Raw Value(dBuV) + Correction Factor(dB/m)
2. Correction Factor(dB/m) = Antenna Factor(dB/m) + Cable Factor(dB) – Pre-Amplifier Factor(dB)
3. The other emission levels were very low against the limit.
4. Margin value = Emission Level – Limit value
5. " \* ": Fundamental frequency.
6. " # ": The radiated frequency is out of the restricted band.

<b>CHANNEL</b>	TX Channel 122+138	<b>DETECTOR FUNCTION</b>	Peak (PK)
<b>FREQUENCY RANGE</b>	1GHz ~ 40GHz		Average (AV)

**ANTENNA POLARITY & TEST DISTANCE: HORIZONTAL AT 3 M**

NO.	FREQ. (MHz)	EMISSION LEVEL (dBuV/m)	LIMIT (dBuV/m)	MARGIN (dB)	ANTENNA HEIGHT (m)	TABLE ANGLE (Degree)	RAW VALUE (dBuV)	CORRECTION FACTOR (dB/m)
1	#5470.00	65.3 PK	74.0	-8.7	2.66 H	100	61.1	4.2
2	#5470.00	53.7 AV	54.0	-0.3	2.66 H	100	49.5	4.2
3	*5610.00	110.5 PK			2.66 H	100	106.1	4.4
4	*5610.00	101.2 AV			2.66 H	100	96.8	4.4
5	*5690.00	108.6 PK			2.53 H	111	104.1	4.5
6	*5690.00	98.3 AV			2.53 H	111	93.8	4.5
7	#5850.00	59.3 PK	74.0	-14.7	2.53 H	111	54.8	4.5
8	#5850.00	47.2 AV	54.0	-6.8	2.53 H	111	42.7	4.5
9	11220.00	49.9 PK	74.0	-24.1	1.68 H	67	36.2	13.7
10	11220.00	37.5 AV	54.0	-16.5	1.68 H	67	23.8	13.7
11	11380.00	49.5 PK	74.0	-24.5	1.70 H	68	35.9	13.6
12	11380.00	37.7 AV	54.0	-16.3	1.70 H	68	24.1	13.6
13	#16830.00	53.6 PK	74.0	-20.4	2.16 H	107	37.7	15.9
14	#16830.00	40.2 AV	54.0	-13.8	2.16 H	107	24.3	15.9
15	#17070.00	53.9 PK	74.0	-20.1	2.18 H	109	36.6	17.3
16	#17070.00	40.7 AV	54.0	-13.3	2.18 H	109	23.4	17.3

**ANTENNA POLARITY & TEST DISTANCE: VERTICAL AT 3 M**

NO.	FREQ. (MHz)	EMISSION LEVEL (dBuV/m)	LIMIT (dBuV/m)	MARGIN (dB)	ANTENNA HEIGHT (m)	TABLE ANGLE (Degree)	RAW VALUE (dBuV)	CORRECTION FACTOR (dB/m)
1	#5470.00	53.0 PK	74.0	-21.0	1.53 V	125	48.8	4.2
2	#5470.00	41.6 AV	54.0	-12.4	1.53 V	125	37.4	4.2
3	*5610.00	101.5 PK			1.53 V	125	97.1	4.4
4	*5610.00	89.4 AV			1.53 V	125	85.0	4.4
5	*5690.00	95.3 PK			1.62 V	157	90.8	4.5
6	*5690.00	83.9 AV			1.62 V	157	79.4	4.5
7	#5850.00	56.2 PK	74.0	-17.8	1.62 V	157	51.7	4.5
8	#5850.00	45.4 AV	54.0	-8.6	1.62 V	157	40.9	4.5
9	11220.00	49.6 PK	74.0	-24.4	2.17 V	152	35.9	13.7
10	11220.00	37.1 AV	54.0	-16.9	2.17 V	152	23.4	13.7
11	11380.00	49.6 PK	74.0	-24.4	2.20 V	156	36.0	13.6
12	11380.00	36.7 AV	54.0	-17.3	2.20 V	156	23.1	13.6
13	#16830.00	52.9 PK	74.0	-21.1	3.22 V	83	37.0	15.9
14	#16830.00	39.6 AV	54.0	-14.4	3.22 V	83	23.7	15.9
15	#17070.00	52.9 PK	74.0	-21.1	3.20 V	79	35.6	17.3
16	#17070.00	39.8 AV	54.0	-14.2	3.20 V	79	22.5	17.3

**REMARKS:**

1. Emission Level(dBuV/m) = Raw Value(dBuV) + Correction Factor(dB/m)
2. Correction Factor(dB/m) = Antenna Factor(dB/m) + Cable Factor(dB) – Pre-Amplifier Factor(dB)
3. The other emission levels were very low against the limit.
4. Margin value = Emission Level – Limit value
5. " \* ": Fundamental frequency.
6. " # ": The radiated frequency is out of the restricted band.

<b>CHANNEL</b>	TX Channel 122+155	<b>DETECTOR FUNCTION</b>	Peak (PK)
<b>FREQUENCY RANGE</b>	1GHz ~ 40GHz		Average (AV)

**ANTENNA POLARITY & TEST DISTANCE: HORIZONTAL AT 3 M**

NO.	FREQ. (MHz)	EMISSION LEVEL (dBuV/m)	LIMIT (dBuV/m)	MARGIN (dB)	ANTENNA HEIGHT (m)	TABLE ANGLE (Degree)	RAW VALUE (dBuV)	CORRECTION FACTOR (dB/m)
1	#5470.00	71.8 PK	74.0	-2.2	2.66 H	100	67.6	4.2
2	#5470.00	53.9 AV	54.0	-0.1	2.66 H	100	49.7	4.2
3	*5610.00	109.1 PK			2.66 H	100	104.7	4.4
4	*5610.00	100.1 AV			2.66 H	100	95.7	4.4
5	*5775.00	108.4 PK			2.81 H	92	104.0	4.4
6	*5775.00	99.3 AV			2.81 H	92	94.9	4.4
7	11220.00	48.8 PK	74.0	-25.2	1.73 H	79	35.1	13.7
8	11220.00	37.0 AV	54.0	-17.0	1.73 H	79	23.3	13.7
9	11550.00	49.2 PK	74.0	-24.8	1.69 H	78	35.7	13.5
10	11550.00	37.1 AV	54.0	-16.9	1.69 H	78	23.6	13.5
11	#16830.00	53.9 PK	74.0	-20.1	2.19 H	95	38.0	15.9
12	#16830.00	40.9 AV	54.0	-13.1	2.19 H	95	25.0	15.9
13	#17325.00	54.3 PK	74.0	-19.7	2.13 H	91	36.5	17.8
14	#17325.00	41.0 AV	54.0	-13.0	2.13 H	91	23.2	17.8

**ANTENNA POLARITY & TEST DISTANCE: VERTICAL AT 3 M**

NO.	FREQ. (MHz)	EMISSION LEVEL (dBuV/m)	LIMIT (dBuV/m)	MARGIN (dB)	ANTENNA HEIGHT (m)	TABLE ANGLE (Degree)	RAW VALUE (dBuV)	CORRECTION FACTOR (dB/m)
1	#5470.00	53.0 PK	74.0	-21.0	1.53 V	125	48.8	4.2
2	#5470.00	41.6 AV	54.0	-12.4	1.53 V	125	37.4	4.2
3	*5610.00	102.5 PK			1.53 V	125	98.1	4.4
4	*5610.00	90.6 AV			1.53 V	125	86.2	4.4
5	*5775.00	91.4 PK			2.32 V	300	87.0	4.4
6	*5775.00	82.6 AV			2.32 V	300	78.2	4.4
7	11220.00	49.8 PK	74.0	-24.2	2.18 V	151	36.1	13.7
8	11220.00	37.0 AV	54.0	-17.0	2.18 V	151	23.3	13.7
9	11550.00	48.7 PK	74.0	-25.3	2.22 V	159	35.2	13.5
10	11550.00	36.2 AV	54.0	-17.8	2.22 V	159	22.7	13.5
11	#16830.00	53.0 PK	74.0	-21.0	3.22 V	77	37.1	15.9
12	#16830.00	39.5 AV	54.0	-14.5	3.22 V	77	23.6	15.9
13	#17325.00	53.5 PK	74.0	-20.5	3.22 V	102	35.7	17.8
14	#17325.00	40.1 AV	54.0	-13.9	3.22 V	102	22.3	17.8

**REMARKS:**

1. Emission Level(dBuV/m) = Raw Value(dBuV) + Correction Factor(dB/m)
2. Correction Factor(dB/m) = Antenna Factor(dB/m) + Cable Factor(dB) – Pre-Amplifier Factor(dB)
3. The other emission levels were very low against the limit.
4. Margin value = Emission Level – Limit value
5. " \* ": Fundamental frequency.
6. " # ": The radiated frequency is out of the restricted band.

<b>CHANNEL</b>	TX Channel 138+155	<b>DETECTOR FUNCTION</b>	Peak (PK)
<b>FREQUENCY RANGE</b>	1GHz ~ 40GHz		Average (AV)

**ANTENNA POLARITY & TEST DISTANCE: HORIZONTAL AT 3 M**

NO.	FREQ. (MHz)	EMISSION LEVEL (dBuV/m)	LIMIT (dBuV/m)	MARGIN (dB)	ANTENNA HEIGHT (m)	TABLE ANGLE (Degree)	RAW VALUE (dBuV)	CORRECTION FACTOR (dB/m)
1	#5470.00	55.2 PK	74.0	-18.8	2.69 H	96	51.0	4.2
2	#5470.00	41.9 AV	54.0	-12.1	2.69 H	96	37.7	4.2
3	*5690.00	112.1 PK			2.69 H	96	107.6	4.5
4	*5690.00	103.1 AV			2.69 H	96	98.6	4.5
5	*5775.00	110.8 PK			2.80 H	91	106.4	4.4
6	*5775.00	101.5 AV			2.80 H	91	97.1	4.4
7	11380.00	49.2 PK	74.0	-24.8	1.65 H	91	35.6	13.6
8	11380.00	37.0 AV	54.0	-17.0	1.65 H	91	23.4	13.6
9	11550.00	50.0 PK	74.0	-24.0	1.75 H	73	36.5	13.5
10	11550.00	37.8 AV	54.0	-16.2	1.75 H	73	24.3	13.5
11	#17070.00	53.4 PK	74.0	-20.6	2.10 H	105	36.1	17.3
12	#17070.00	40.4 AV	54.0	-13.6	2.10 H	105	23.1	17.3
13	#17325.00	53.3 PK	74.0	-20.7	2.19 H	84	35.5	17.8
14	#17325.00	40.2 AV	54.0	-13.8	2.19 H	84	22.4	17.8

**ANTENNA POLARITY & TEST DISTANCE: VERTICAL AT 3 M**

NO.	FREQ. (MHz)	EMISSION LEVEL (dBuV/m)	LIMIT (dBuV/m)	MARGIN (dB)	ANTENNA HEIGHT (m)	TABLE ANGLE (Degree)	RAW VALUE (dBuV)	CORRECTION FACTOR (dB/m)
1	#5470.00	54.3 PK	74.0	-19.7	1.66 V	139	50.1	4.2
2	#5470.00	38.6 AV	54.0	-15.4	1.66 V	139	34.4	4.2
3	*5690.00	100.1 PK			1.66 V	139	95.6	4.5
4	*5690.00	88.7 AV			1.66 V	139	84.2	4.5
5	*5775.00	97.8 PK			2.33 V	306	93.4	4.4
6	*5775.00	88.5 AV			2.33 V	306	84.1	4.4
7	11380.00	49.6 PK	74.0	-24.4	2.21 V	141	36.0	13.6
8	11380.00	37.0 AV	54.0	-17.0	2.21 V	141	23.4	13.6
9	11550.00	49.8 PK	74.0	-24.2	2.14 V	142	36.3	13.5
10	11550.00	37.0 AV	54.0	-17.0	2.14 V	142	23.5	13.5
11	#17070.00	52.6 PK	74.0	-21.4	3.26 V	79	35.3	17.3
12	#17070.00	39.5 AV	54.0	-14.5	3.26 V	79	22.2	17.3
13	#17325.00	53.6 PK	74.0	-20.4	3.16 V	75	35.8	17.8
14	#17325.00	40.4 AV	54.0	-13.6	3.16 V	75	22.6	17.8

**REMARKS:**

1. Emission Level(dBuV/m) = Raw Value(dBuV) + Correction Factor(dB/m)
2. Correction Factor(dB/m) = Antenna Factor(dB/m) + Cable Factor(dB) – Pre-Amplifier Factor(dB)
3. The other emission levels were very low against the limit.
4. Margin value = Emission Level – Limit value
5. " \* ": Fundamental frequency.
6. " # ": The radiated frequency is out of the restricted band.

**Below 1GHz Data:**

**802.11ac (VHT40)**

<b>CHANNEL</b>	TX Channel 110	<b>DETECTOR FUNCTION</b>	Quasi-Peak (QP)
<b>FREQUENCY RANGE</b>	9kHz ~ 1GHz		

**ANTENNA POLARITY & TEST DISTANCE: HORIZONTAL AT 3 M**

NO.	FREQ. (MHz)	EMISSION LEVEL (dBuV/m)	LIMIT (dBuV/m)	MARGIN (dB)	ANTENNA HEIGHT (m)	TABLE ANGLE (Degree)	RAW VALUE (dBuV)	CORRECTION FACTOR (dB/m)
1	85.31	35.4 QP	40.0	-4.6	1.60 H	184	49.5	-14.1
2	220.71	39.2 QP	46.0	-6.8	1.43 H	179	50.3	-11.1
3	291.18	38.1 QP	46.0	-7.9	1.10 H	263	45.7	-7.6
4	445.70	35.1 QP	46.0	-10.9	1.76 H	129	38.5	-3.4
5	500.96	36.2 QP	46.0	-9.8	1.46 H	186	38.8	-2.6
6	667.45	30.0 QP	46.0	-16.0	1.05 H	119	29.5	0.5

**ANTENNA POLARITY & TEST DISTANCE: VERTICAL AT 3 M**

NO.	FREQ. (MHz)	EMISSION LEVEL (dBuV/m)	LIMIT (dBuV/m)	MARGIN (dB)	ANTENNA HEIGHT (m)	TABLE ANGLE (Degree)	RAW VALUE (dBuV)	CORRECTION FACTOR (dB/m)
1	37.20	33.3 QP	40.0	-6.7	1.66 V	297	42.5	-9.2
2	66.24	34.2 QP	40.0	-5.8	2.00 V	266	44.4	-10.2
3	116.15	35.5 QP	43.5	-8.0	1.70 V	286	46.1	-10.6
4	235.46	34.3 QP	46.0	-11.7	1.90 V	289	44.2	-9.9
5	530.01	33.7 QP	46.0	-12.3	1.30 V	336	35.7	-2.0
6	871.22	33.6 QP	46.0	-12.4	1.20 V	88	30.2	3.4

**REMARKS:**

1. Emission Level(dBuV/m) = Raw Value(dBuV) + Correction Factor(dB/m)
2. Correction Factor(dB/m) = Antenna Factor(dB/m) + Cable Factor(dB) – Pre-Amplifier Factor(dB)
3. The other emission levels were very low against the limit.
4. Margin value = Emission Level – Limit value

## 4.1.8 Test Results (Mode 2)

## Above 1GHz Data:

## 802.11a

<b>CHANNEL</b>	TX Channel 52	<b>DETECTOR FUNCTION</b>	Peak (PK)
<b>FREQUENCY RANGE</b>	1GHz ~ 40GHz		Average (AV)

**ANTENNA POLARITY & TEST DISTANCE: HORIZONTAL AT 3 M**

NO.	FREQ. (MHz)	EMISSION LEVEL (dBuV/m)	LIMIT (dBuV/m)	MARGIN (dB)	ANTENNA HEIGHT (m)	TABLE ANGLE (Degree)	RAW VALUE (dBuV)	CORRECTION FACTOR (dB/m)
1	5150.00	50.3 PK	74.0	-23.7	3.39 H	98	46.6	3.7
2	5150.00	39.2 AV	54.0	-14.8	3.39 H	98	35.5	3.7
3	*5260.00	115.3 PK			3.39 H	98	111.3	4.0
4	*5260.00	104.7 AV			3.39 H	98	100.7	4.0
5	5350.00	50.7 PK	74.0	-23.3	3.39 H	98	46.6	4.1
6	5350.00	39.2 AV	54.0	-14.8	3.39 H	98	35.1	4.1
7	#10520.00	47.7 PK	74.0	-26.3	1.75 H	302	34.5	13.2
8	#10520.00	34.6 AV	54.0	-19.4	1.75 H	302	21.4	13.2
9	15780.00	46.0 PK	74.0	-28.0	1.64 H	214	32.4	13.6
10	15780.00	34.4 AV	54.0	-19.6	1.64 H	214	20.8	13.6

**ANTENNA POLARITY & TEST DISTANCE: VERTICAL AT 3 M**

NO.	FREQ. (MHz)	EMISSION LEVEL (dBuV/m)	LIMIT (dBuV/m)	MARGIN (dB)	ANTENNA HEIGHT (m)	TABLE ANGLE (Degree)	RAW VALUE (dBuV)	CORRECTION FACTOR (dB/m)
1	5150.00	47.8 PK	74.0	-26.2	2.21 V	307	44.1	3.7
2	5150.00	35.7 AV	54.0	-18.3	2.21 V	307	32.0	3.7
3	*5260.00	98.7 PK			2.21 V	307	94.7	4.0
4	*5260.00	89.6 AV			2.21 V	307	85.6	4.0
5	5350.00	48.3 PK	74.0	-25.7	2.21 V	307	44.2	4.1
6	5350.00	36.4 AV	54.0	-17.6	2.21 V	307	32.3	4.1
7	#10520.00	46.7 PK	74.0	-27.3	1.64 V	317	33.5	13.2
8	#10520.00	33.3 AV	54.0	-20.7	1.64 V	317	20.1	13.2
9	15780.00	42.6 PK	74.0	-31.4	1.36 V	214	29.0	13.6
10	15780.00	32.3 AV	54.0	-21.7	1.36 V	214	18.7	13.6

**REMARKS:**

- Emission Level(dBuV/m) = Raw Value(dBuV) + Correction Factor(dB/m)
- Correction Factor(dB/m) = Antenna Factor(dB/m) + Cable Factor(dB) – Pre-Amplifier Factor(dB)
- The other emission levels were very low against the limit.
- Margin value = Emission Level – Limit value
- " \* ": Fundamental frequency.
- " # ": The radiated frequency is out of the restricted band.



<b>CHANNEL</b>	TX Channel 60	<b>DETECTOR FUNCTION</b>	Peak (PK)
<b>FREQUENCY RANGE</b>	1GHz ~ 40GHz		Average (AV)

**ANTENNA POLARITY & TEST DISTANCE: HORIZONTAL AT 3 M**

NO.	FREQ. (MHz)	EMISSION LEVEL (dBuV/m)	LIMIT (dBuV/m)	MARGIN (dB)	ANTENNA HEIGHT (m)	TABLE ANGLE (Degree)	RAW VALUE (dBuV)	CORRECTION FACTOR (dB/m)
1	5150.00	50.1 PK	74.0	-23.9	3.14 H	104	46.4	3.7
2	5150.00	39.5 AV	54.0	-14.5	3.14 H	104	35.8	3.7
3	*5300.00	114.8 PK			3.14 H	104	110.7	4.1
4	*5300.00	104.7 AV			3.14 H	104	100.6	4.1
5	5350.00	51.2 PK	74.0	-22.8	3.14 H	104	47.1	4.1
6	5350.00	40.8 AV	54.0	-13.2	3.14 H	104	36.7	4.1
7	10600.00	48.3 PK	74.0	-25.7	1.78 H	293	34.8	13.5
8	10600.00	34.9 AV	54.0	-19.1	1.78 H	293	21.4	13.5
9	15900.00	46.0 PK	74.0	-28.0	1.68 H	213	33.1	12.9
10	15900.00	34.3 AV	54.0	-19.7	1.68 H	213	21.4	12.9

**ANTENNA POLARITY & TEST DISTANCE: VERTICAL AT 3 M**

NO.	FREQ. (MHz)	EMISSION LEVEL (dBuV/m)	LIMIT (dBuV/m)	MARGIN (dB)	ANTENNA HEIGHT (m)	TABLE ANGLE (Degree)	RAW VALUE (dBuV)	CORRECTION FACTOR (dB/m)
1	5150.00	46.8 PK	74.0	-27.2	2.23 V	301	43.1	3.7
2	5150.00	36.4 AV	54.0	-17.6	2.23 V	301	32.7	3.7
3	*5300.00	99.4 PK			2.23 V	301	95.3	4.1
4	*5300.00	90.3 AV			2.23 V	301	86.2	4.1
5	5350.00	48.0 PK	74.0	-26.0	2.23 V	301	43.9	4.1
6	5350.00	37.5 AV	54.0	-16.5	2.23 V	301	33.4	4.1
7	10600.00	46.4 PK	74.0	-27.6	1.64 V	318	32.9	13.5
8	10600.00	32.9 AV	54.0	-21.1	1.64 V	318	19.4	13.5
9	15900.00	42.7 PK	74.0	-31.3	1.32 V	225	29.8	12.9
10	15900.00	32.7 AV	54.0	-21.3	1.32 V	225	19.8	12.9

**REMARKS:**

1. Emission Level(dBuV/m) = Raw Value(dBuV) + Correction Factor(dB/m)
2. Correction Factor(dB/m) = Antenna Factor(dB/m) + Cable Factor(dB) – Pre-Amplifier Factor(dB)
3. The other emission levels were very low against the limit.
4. Margin value = Emission Level – Limit value
5. " \* ": Fundamental frequency.

<b>CHANNEL</b>	TX Channel 64	<b>DETECTOR FUNCTION</b>	Peak (PK)
<b>FREQUENCY RANGE</b>	1GHz ~ 40GHz		Average (AV)

**ANTENNA POLARITY & TEST DISTANCE: HORIZONTAL AT 3 M**

NO.	FREQ. (MHz)	EMISSION LEVEL (dBuV/m)	LIMIT (dBuV/m)	MARGIN (dB)	ANTENNA HEIGHT (m)	TABLE ANGLE (Degree)	RAW VALUE (dBuV)	CORRECTION FACTOR (dB/m)
1	*5320.00	114.7 PK			3.33 H	86	110.6	4.1
2	*5320.00	104.5 AV			3.33 H	86	100.4	4.1
3	5350.00	54.8 PK	74.0	-19.2	3.33 H	86	50.7	4.1
4	5350.00	43.7 AV	54.0	-10.3	3.33 H	86	39.6	4.1
5	10640.00	47.9 PK	74.0	-26.1	1.73 H	292	34.4	13.5
6	10640.00	34.9 AV	54.0	-19.1	1.73 H	292	21.4	13.5
7	15960.00	45.6 PK	74.0	-28.4	1.66 H	212	32.7	12.9
8	15960.00	34.2 AV	54.0	-19.8	1.66 H	212	21.3	12.9

**ANTENNA POLARITY & TEST DISTANCE: VERTICAL AT 3 M**

NO.	FREQ. (MHz)	EMISSION LEVEL (dBuV/m)	LIMIT (dBuV/m)	MARGIN (dB)	ANTENNA HEIGHT (m)	TABLE ANGLE (Degree)	RAW VALUE (dBuV)	CORRECTION FACTOR (dB/m)
1	*5320.00	99.3 PK			2.26 V	306	95.2	4.1
2	*5320.00	90.2 AV			2.26 V	306	86.1	4.1
3	5350.00	51.7 PK	74.0	-22.3	2.26 V	306	47.6	4.1
4	5350.00	40.5 AV	54.0	-13.5	2.26 V	306	36.4	4.1
5	10640.00	47.1 PK	74.0	-26.9	1.58 V	311	33.6	13.5
6	10640.00	33.7 AV	54.0	-20.3	1.58 V	311	20.2	13.5
7	15960.00	43.2 PK	74.0	-30.8	1.37 V	221	30.3	12.9
8	15960.00	32.7 AV	54.0	-21.3	1.37 V	221	19.8	12.9

**REMARKS:**

1. Emission Level(dBuV/m) = Raw Value(dBuV) + Correction Factor(dB/m)
2. Correction Factor(dB/m) = Antenna Factor(dB/m) + Cable Factor(dB) – Pre-Amplifier Factor(dB)
3. The other emission levels were very low against the limit.
4. Margin value = Emission Level – Limit value
5. " \* ": Fundamental frequency.

<b>CHANNEL</b>	TX Channel 100	<b>DETECTOR FUNCTION</b>	Peak (PK)
<b>FREQUENCY RANGE</b>	1GHz ~ 40GHz		Average (AV)

**ANTENNA POLARITY & TEST DISTANCE: HORIZONTAL AT 3 M**

NO.	FREQ. (MHz)	EMISSION LEVEL (dBuV/m)	LIMIT (dBuV/m)	MARGIN (dB)	ANTENNA HEIGHT (m)	TABLE ANGLE (Degree)	RAW VALUE (dBuV)	CORRECTION FACTOR (dB/m)
1	#5470.00	58.8 PK	74.0	-15.2	2.57 H	96	54.6	4.2
2	#5470.00	45.1 AV	54.0	-8.9	2.57 H	96	40.9	4.2
3	*5500.00	115.6 PK			2.57 H	96	111.4	4.2
4	*5500.00	105.8 AV			2.57 H	96	101.6	4.2
5	11000.00	47.4 PK	74.0	-26.6	1.78 H	294	33.3	14.1
6	11000.00	34.5 AV	54.0	-19.5	1.78 H	294	20.4	14.1
7	#16500.00	46.7 PK	74.0	-27.3	1.70 H	225	32.2	14.5
8	#16500.00	34.9 AV	54.0	-19.1	1.70 H	225	20.4	14.5

**ANTENNA POLARITY & TEST DISTANCE: VERTICAL AT 3 M**

NO.	FREQ. (MHz)	EMISSION LEVEL (dBuV/m)	LIMIT (dBuV/m)	MARGIN (dB)	ANTENNA HEIGHT (m)	TABLE ANGLE (Degree)	RAW VALUE (dBuV)	CORRECTION FACTOR (dB/m)
1	#5470.00	55.7 PK	74.0	-18.3	2.32 V	314	51.5	4.2
2	#5470.00	41.8 AV	54.0	-12.2	2.32 V	314	37.6	4.2
3	*5500.00	101.5 PK			2.32 V	314	97.3	4.2
4	*5500.00	91.4 AV			2.32 V	314	87.2	4.2
5	11000.00	47.2 PK	74.0	-26.8	1.60 V	318	33.1	14.1
6	11000.00	33.7 AV	54.0	-20.3	1.60 V	318	19.6	14.1
7	#16500.00	42.4 PK	74.0	-31.6	1.42 V	216	27.9	14.5
8	#16500.00	31.9 AV	54.0	-22.1	1.42 V	216	17.4	14.5

**REMARKS:**

1. Emission Level(dBuV/m) = Raw Value(dBuV) + Correction Factor(dB/m)
2. Correction Factor(dB/m) = Antenna Factor(dB/m) + Cable Factor(dB) – Pre-Amplifier Factor(dB)
3. The other emission levels were very low against the limit.
4. Margin value = Emission Level – Limit value
5. " \* ": Fundamental frequency.
6. " # ": The radiated frequency is out of the restricted band.

<b>CHANNEL</b>	TX Channel 116	<b>DETECTOR FUNCTION</b>	Peak (PK)
<b>FREQUENCY RANGE</b>	1GHz ~ 40GHz		Average (AV)

**ANTENNA POLARITY & TEST DISTANCE: HORIZONTAL AT 3 M**

NO.	FREQ. (MHz)	EMISSION LEVEL (dBuV/m)	LIMIT (dBuV/m)	MARGIN (dB)	ANTENNA HEIGHT (m)	TABLE ANGLE (Degree)	RAW VALUE (dBuV)	CORRECTION FACTOR (dB/m)
1	#5470.00	50.1 PK	74.0	-23.9	2.54 H	99	45.9	4.2
2	#5470.00	38.3 AV	54.0	-15.7	2.54 H	99	34.1	4.2
3	*5580.00	117.3 PK			2.54 H	99	113.1	4.2
4	*5580.00	106.9 AV			2.54 H	99	102.7	4.2
5	#5725.00	50.8 PK	74.0	-23.2	2.54 H	99	46.4	4.4
6	#5725.00	40.3 AV	54.0	-13.7	2.54 H	99	35.9	4.4
7	11160.00	47.9 PK	74.0	-26.1	1.76 H	318	34.2	13.7
8	11160.00	34.8 AV	54.0	-19.2	1.76 H	318	21.1	13.7
9	#16740.00	45.4 PK	74.0	-28.6	1.65 H	228	29.7	15.7
10	#16740.00	34.0 AV	54.0	-20.0	1.65 H	228	18.3	15.7

**ANTENNA POLARITY & TEST DISTANCE: VERTICAL AT 3 M**

NO.	FREQ. (MHz)	EMISSION LEVEL (dBuV/m)	LIMIT (dBuV/m)	MARGIN (dB)	ANTENNA HEIGHT (m)	TABLE ANGLE (Degree)	RAW VALUE (dBuV)	CORRECTION FACTOR (dB/m)
1	#5470.00	46.8 PK	74.0	-27.2	2.30 V	304	42.6	4.2
2	#5470.00	35.1 AV	54.0	-18.9	2.30 V	304	30.9	4.2
3	*5580.00	102.9 PK			2.30 V	304	98.7	4.2
4	*5580.00	92.6 AV			2.30 V	304	88.4	4.2
5	#5725.00	47.5 PK	74.0	-26.5	2.30 V	304	43.1	4.4
6	#5725.00	37.0 AV	54.0	-17.0	2.30 V	304	32.6	4.4
7	11160.00	46.4 PK	74.0	-27.6	1.59 V	305	32.7	13.7
8	11160.00	32.9 AV	54.0	-21.1	1.59 V	305	19.2	13.7
9	#16740.00	42.0 PK	74.0	-32.0	1.39 V	201	26.3	15.7
10	#16740.00	31.9 AV	54.0	-22.1	1.39 V	201	16.2	15.7

**REMARKS:**

1. Emission Level(dBuV/m) = Raw Value(dBuV) + Correction Factor(dB/m)
2. Correction Factor(dB/m) = Antenna Factor(dB/m) + Cable Factor(dB) – Pre-Amplifier Factor(dB)
3. The other emission levels were very low against the limit.
4. Margin value = Emission Level – Limit value
5. " \* ": Fundamental frequency.
6. " # ": The radiated frequency is out of the restricted band.

<b>CHANNEL</b>	TX Channel 140	<b>DETECTOR FUNCTION</b>	Peak (PK)
<b>FREQUENCY RANGE</b>	1GHz ~ 40GHz		Average (AV)

**ANTENNA POLARITY & TEST DISTANCE: HORIZONTAL AT 3 M**

NO.	FREQ. (MHz)	EMISSION LEVEL (dBuV/m)	LIMIT (dBuV/m)	MARGIN (dB)	ANTENNA HEIGHT (m)	TABLE ANGLE (Degree)	RAW VALUE (dBuV)	CORRECTION FACTOR (dB/m)
1	*5700.00	117.2 PK			2.56 H	95	112.7	4.5
2	*5700.00	106.8 AV			2.56 H	95	102.3	4.5
3	#5725.00	58.7 PK	74.0	-15.3	2.56 H	95	54.3	4.4
4	#5725.00	45.7 AV	54.0	-8.3	2.56 H	95	41.3	4.4
5	11400.00	47.4 PK	74.0	-26.6	1.78 H	298	33.8	13.6
6	11400.00	34.3 AV	54.0	-19.7	1.78 H	298	20.7	13.6
7	#17100.00	46.2 PK	74.0	-27.8	1.61 H	204	28.8	17.4
8	#17100.00	34.8 AV	54.0	-19.2	1.61 H	204	17.4	17.4

**ANTENNA POLARITY & TEST DISTANCE: VERTICAL AT 3 M**

NO.	FREQ. (MHz)	EMISSION LEVEL (dBuV/m)	LIMIT (dBuV/m)	MARGIN (dB)	ANTENNA HEIGHT (m)	TABLE ANGLE (Degree)	RAW VALUE (dBuV)	CORRECTION FACTOR (dB/m)
1	*5700.00	102.7 PK			2.32 V	319	98.2	4.5
2	*5700.00	92.4 AV			2.32 V	319	87.9	4.5
3	#5725.00	55.4 PK	74.0	-18.6	2.32 V	319	51.0	4.4
4	#5725.00	42.3 AV	54.0	-11.7	2.32 V	319	37.9	4.4
5	11400.00	46.3 PK	74.0	-27.7	1.63 V	306	32.7	13.6
6	11400.00	33.2 AV	54.0	-20.8	1.63 V	306	19.6	13.6
7	#17100.00	43.0 PK	74.0	-31.0	1.32 V	216	25.6	17.4
8	#17100.00	32.5 AV	54.0	-21.5	1.32 V	216	15.1	17.4

**REMARKS:**

1. Emission Level(dBuV/m) = Raw Value(dBuV) + Correction Factor(dB/m)
2. Correction Factor(dB/m) = Antenna Factor(dB/m) + Cable Factor(dB) – Pre-Amplifier Factor(dB)
3. The other emission levels were very low against the limit.
4. Margin value = Emission Level – Limit value
5. " \* ": Fundamental frequency.
6. " # ": The radiated frequency is out of the restricted band.

<b>CHANNEL</b>	TX Channel 144	<b>DETECTOR FUNCTION</b>	Peak (PK)
<b>FREQUENCY RANGE</b>	1GHz ~ 40GHz		Average (AV)

**ANTENNA POLARITY & TEST DISTANCE: HORIZONTAL AT 3 M**

NO.	FREQ. (MHz)	EMISSION LEVEL (dBuV/m)	LIMIT (dBuV/m)	MARGIN (dB)	ANTENNA HEIGHT (m)	TABLE ANGLE (Degree)	RAW VALUE (dBuV)	CORRECTION FACTOR (dB/m)
1	#5470.00	49.3 PK	74.0	-24.7	2.60 H	94	45.1	4.2
2	#5470.00	37.1 AV	54.0	-16.9	2.60 H	94	32.9	4.2
3	*5720.00	116.6 PK			2.60 H	94	112.2	4.4
4	*5720.00	106.2 AV			2.60 H	94	101.8	4.4
5	#5850.00	50.8 PK	74.0	-23.2	2.60 H	94	46.3	4.5
6	#5850.00	38.7 AV	54.0	-15.3	2.60 H	94	34.2	4.5
7	11440.00	48.4 PK	74.0	-25.6	1.77 H	295	34.9	13.5
8	11440.00	35.1 AV	54.0	-18.9	1.77 H	295	21.6	13.5
9	#17160.00	45.5 PK	74.0	-28.5	1.67 H	213	28.2	17.3
10	#17160.00	34.1 AV	54.0	-19.9	1.67 H	213	16.8	17.3

**ANTENNA POLARITY & TEST DISTANCE: VERTICAL AT 3 M**

NO.	FREQ. (MHz)	EMISSION LEVEL (dBuV/m)	LIMIT (dBuV/m)	MARGIN (dB)	ANTENNA HEIGHT (m)	TABLE ANGLE (Degree)	RAW VALUE (dBuV)	CORRECTION FACTOR (dB/m)
1	#5470.00	46.1 PK	74.0	-27.9	2.26 V	322	41.9	4.2
2	#5470.00	33.8 AV	54.0	-20.2	2.26 V	322	29.6	4.2
3	*5720.00	102.3 PK			2.26 V	322	97.9	4.4
4	*5720.00	91.9 AV			2.26 V	322	87.5	4.4
5	#5850.00	47.5 PK	74.0	-26.5	2.26 V	322	43.0	4.5
6	#5850.00	35.6 AV	54.0	-18.4	2.26 V	322	31.1	4.5
7	11440.00	46.0 PK	74.0	-28.0	1.63 V	303	32.5	13.5
8	11440.00	33.2 AV	54.0	-20.8	1.63 V	303	19.7	13.5
9	#17160.00	43.7 PK	74.0	-30.3	1.26 V	214	26.4	17.3
10	#17160.00	32.9 AV	54.0	-21.1	1.26 V	214	15.6	17.3

**REMARKS:**

1. Emission Level(dBuV/m) = Raw Value(dBuV) + Correction Factor(dB/m)
2. Correction Factor(dB/m) = Antenna Factor(dB/m) + Cable Factor(dB) – Pre-Amplifier Factor(dB)
3. The other emission levels were very low against the limit.
4. Margin value = Emission Level – Limit value
5. " \* ": Fundamental frequency.
6. " # ": The radiated frequency is out of the restricted band.

802.11ac (VHT20)

<b>CHANNEL</b>	TX Channel 52	<b>DETECTOR FUNCTION</b>	Peak (PK)
<b>FREQUENCY RANGE</b>	1GHz ~ 40GHz		Average (AV)

**ANTENNA POLARITY & TEST DISTANCE: HORIZONTAL AT 3 M**

NO.	FREQ. (MHz)	EMISSION LEVEL (dBuV/m)	LIMIT (dBuV/m)	MARGIN (dB)	ANTENNA HEIGHT (m)	TABLE ANGLE (Degree)	RAW VALUE (dBuV)	CORRECTION FACTOR (dB/m)
1	5150.00	48.6 PK	74.0	-25.4	2.30 H	104	44.9	3.7
2	5150.00	38.3 AV	54.0	-15.7	2.30 H	104	34.6	3.7
3	*5260.00	115.1 PK			2.30 H	104	111.1	4.0
4	*5260.00	104.9 AV			2.30 H	104	100.9	4.0
5	5350.00	50.4 PK	74.0	-23.6	2.30 H	104	46.3	4.1
6	5350.00	38.5 AV	54.0	-15.5	2.30 H	104	34.4	4.1
7	#10520.00	47.8 PK	74.0	-26.2	1.73 H	286	34.6	13.2
8	#10520.00	34.6 AV	54.0	-19.4	1.73 H	286	21.4	13.2
9	15780.00	45.6 PK	74.0	-28.4	1.62 H	202	32.0	13.6
10	15780.00	34.2 AV	54.0	-19.8	1.62 H	202	20.6	13.6

**ANTENNA POLARITY & TEST DISTANCE: VERTICAL AT 3 M**

NO.	FREQ. (MHz)	EMISSION LEVEL (dBuV/m)	LIMIT (dBuV/m)	MARGIN (dB)	ANTENNA HEIGHT (m)	TABLE ANGLE (Degree)	RAW VALUE (dBuV)	CORRECTION FACTOR (dB/m)
1	5150.00	45.5 PK	74.0	-28.5	2.24 V	326	41.8	3.7
2	5150.00	35.0 AV	54.0	-19.0	2.24 V	326	31.3	3.7
3	*5260.00	101.0 PK			2.24 V	326	97.0	4.0
4	*5260.00	90.6 AV			2.24 V	326	86.6	4.0
5	5350.00	47.3 PK	74.0	-26.7	2.24 V	326	43.2	4.1
6	5350.00	35.3 AV	54.0	-18.7	2.24 V	326	31.2	4.1
7	#10520.00	46.3 PK	74.0	-27.7	1.64 V	293	33.1	13.2
8	#10520.00	33.0 AV	54.0	-21.0	1.64 V	293	19.8	13.2
9	15780.00	43.1 PK	74.0	-30.9	1.34 V	209	29.5	13.6
10	15780.00	32.5 AV	54.0	-21.5	1.34 V	209	18.9	13.6

**REMARKS:**

1. Emission Level(dBuV/m) = Raw Value(dBuV) + Correction Factor(dB/m)
2. Correction Factor(dB/m) = Antenna Factor(dB/m) + Cable Factor(dB) – Pre-Amplifier Factor(dB)
3. The other emission levels were very low against the limit.
4. Margin value = Emission Level – Limit value
5. " \* ": Fundamental frequency.
6. " # ": The radiated frequency is out of the restricted band.

<b>CHANNEL</b>	TX Channel 60	<b>DETECTOR FUNCTION</b>	Peak (PK)
<b>FREQUENCY RANGE</b>	1GHz ~ 40GHz		Average (AV)

**ANTENNA POLARITY & TEST DISTANCE: HORIZONTAL AT 3 M**

NO.	FREQ. (MHz)	EMISSION LEVEL (dBuV/m)	LIMIT (dBuV/m)	MARGIN (dB)	ANTENNA HEIGHT (m)	TABLE ANGLE (Degree)	RAW VALUE (dBuV)	CORRECTION FACTOR (dB/m)
1	5150.00	48.0 PK	74.0	-26.0	3.05 H	105	44.3	3.7
2	5150.00	38.2 AV	54.0	-15.8	3.05 H	105	34.5	3.7
3	*5300.00	114.9 PK			3.05 H	105	110.8	4.1
4	*5300.00	104.2 AV			3.05 H	105	100.1	4.1
5	5350.00	50.1 PK	74.0	-23.9	3.05 H	105	46.0	4.1
6	5350.00	38.7 AV	54.0	-15.3	3.05 H	105	34.6	4.1
7	10600.00	47.3 PK	74.0	-26.7	1.79 H	289	33.8	13.5
8	10600.00	34.1 AV	54.0	-19.9	1.79 H	289	20.6	13.5
9	15900.00	46.4 PK	74.0	-27.6	1.67 H	208	33.5	12.9
10	15900.00	34.7 AV	54.0	-19.3	1.67 H	208	21.8	12.9

**ANTENNA POLARITY & TEST DISTANCE: VERTICAL AT 3 M**

NO.	FREQ. (MHz)	EMISSION LEVEL (dBuV/m)	LIMIT (dBuV/m)	MARGIN (dB)	ANTENNA HEIGHT (m)	TABLE ANGLE (Degree)	RAW VALUE (dBuV)	CORRECTION FACTOR (dB/m)
1	5150.00	44.9 PK	74.0	-29.1	2.30 V	324	41.2	3.7
2	5150.00	35.0 AV	54.0	-19.0	2.30 V	324	31.3	3.7
3	*5300.00	100.4 PK			2.30 V	324	96.3	4.1
4	*5300.00	90.1 AV			2.30 V	324	86.0	4.1
5	5350.00	46.9 PK	74.0	-27.1	2.30 V	324	42.8	4.1
6	5350.00	35.4 AV	54.0	-18.6	2.30 V	324	31.3	4.1
7	10600.00	46.3 PK	74.0	-27.7	1.66 V	322	32.8	13.5
8	10600.00	32.9 AV	54.0	-21.1	1.66 V	322	19.4	13.5
9	15900.00	43.3 PK	74.0	-30.7	1.30 V	212	30.4	12.9
10	15900.00	32.5 AV	54.0	-21.5	1.30 V	212	19.6	12.9

**REMARKS:**

1. Emission Level(dBuV/m) = Raw Value(dBuV) + Correction Factor(dB/m)
2. Correction Factor(dB/m) = Antenna Factor(dB/m) + Cable Factor(dB) – Pre-Amplifier Factor(dB)
3. The other emission levels were very low against the limit.
4. Margin value = Emission Level – Limit value
5. " \* ": Fundamental frequency.



<b>CHANNEL</b>	TX Channel 64	<b>DETECTOR FUNCTION</b>	Peak (PK)
<b>FREQUENCY RANGE</b>	1GHz ~ 40GHz		Average (AV)

**ANTENNA POLARITY & TEST DISTANCE: HORIZONTAL AT 3 M**

NO.	FREQ. (MHz)	EMISSION LEVEL (dBuV/m)	LIMIT (dBuV/m)	MARGIN (dB)	ANTENNA HEIGHT (m)	TABLE ANGLE (Degree)	RAW VALUE (dBuV)	CORRECTION FACTOR (dB/m)
1	*5320.00	115.5 PK			3.05 H	105	111.4	4.1
2	*5320.00	104.6 AV			3.05 H	105	100.5	4.1
3	5350.00	56.6 PK	74.0	-17.4	3.05 H	105	52.5	4.1
4	5350.00	44.0 AV	54.0	-10.0	3.05 H	105	39.9	4.1
5	10640.00	47.8 PK	74.0	-26.2	1.79 H	293	34.3	13.5
6	10640.00	34.9 AV	54.0	-19.1	1.79 H	293	21.4	13.5
7	15960.00	45.6 PK	74.0	-28.4	1.59 H	212	32.7	12.9
8	15960.00	34.2 AV	54.0	-19.8	1.59 H	212	21.3	12.9

**ANTENNA POLARITY & TEST DISTANCE: VERTICAL AT 3 M**

NO.	FREQ. (MHz)	EMISSION LEVEL (dBuV/m)	LIMIT (dBuV/m)	MARGIN (dB)	ANTENNA HEIGHT (m)	TABLE ANGLE (Degree)	RAW VALUE (dBuV)	CORRECTION FACTOR (dB/m)
1	*5320.00	101.1 PK			2.27 V	335	97.0	4.1
2	*5320.00	90.3 AV			2.27 V	335	86.2	4.1
3	5350.00	53.2 PK	74.0	-20.8	2.27 V	335	49.1	4.1
4	5350.00	40.7 AV	54.0	-13.3	2.27 V	335	36.6	4.1
5	10640.00	46.7 PK	74.0	-27.3	1.59 V	294	33.2	13.5
6	10640.00	33.4 AV	54.0	-20.6	1.59 V	294	19.9	13.5
7	15960.00	42.5 PK	74.0	-31.5	1.34 V	203	29.6	12.9
8	15960.00	32.1 AV	54.0	-21.9	1.34 V	203	19.2	12.9

**REMARKS:**

1. Emission Level(dBuV/m) = Raw Value(dBuV) + Correction Factor(dB/m)
2. Correction Factor(dB/m) = Antenna Factor(dB/m) + Cable Factor(dB) – Pre-Amplifier Factor(dB)
3. The other emission levels were very low against the limit.
4. Margin value = Emission Level – Limit value
5. " \* ": Fundamental frequency.

<b>CHANNEL</b>	TX Channel 100	<b>DETECTOR FUNCTION</b>	Peak (PK)
<b>FREQUENCY RANGE</b>	1GHz ~ 40GHz		Average (AV)

**ANTENNA POLARITY & TEST DISTANCE: HORIZONTAL AT 3 M**

NO.	FREQ. (MHz)	EMISSION LEVEL (dBuV/m)	LIMIT (dBuV/m)	MARGIN (dB)	ANTENNA HEIGHT (m)	TABLE ANGLE (Degree)	RAW VALUE (dBuV)	CORRECTION FACTOR (dB/m)
1	#5470.00	57.2 PK	74.0	-16.8	2.30 H	98	53.0	4.2
2	#5470.00	44.7 AV	54.0	-9.3	2.30 H	98	40.5	4.2
3	*5500.00	116.7 PK			2.30 H	98	112.5	4.2
4	*5500.00	105.5 AV			2.30 H	98	101.3	4.2
5	11000.00	47.2 PK	74.0	-26.8	1.74 H	316	33.1	14.1
6	11000.00	34.3 AV	54.0	-19.7	1.74 H	316	20.2	14.1
7	#16500.00	46.5 PK	74.0	-27.5	1.70 H	219	32.0	14.5
8	#16500.00	34.6 AV	54.0	-19.4	1.70 H	219	20.1	14.5

**ANTENNA POLARITY & TEST DISTANCE: VERTICAL AT 3 M**

NO.	FREQ. (MHz)	EMISSION LEVEL (dBuV/m)	LIMIT (dBuV/m)	MARGIN (dB)	ANTENNA HEIGHT (m)	TABLE ANGLE (Degree)	RAW VALUE (dBuV)	CORRECTION FACTOR (dB/m)
1	#5470.00	54.0 PK	74.0	-20.0	2.28 V	328	49.8	4.2
2	#5470.00	41.5 AV	54.0	-12.5	2.28 V	328	37.3	4.2
3	*5500.00	101.4 PK			2.28 V	328	97.2	4.2
4	*5500.00	91.3 AV			2.28 V	328	87.1	4.2
5	11000.00	46.0 PK	74.0	-28.0	1.58 V	299	31.9	14.1
6	11000.00	33.2 AV	54.0	-20.8	1.58 V	299	19.1	14.1
7	#16500.00	42.8 PK	74.0	-31.2	1.33 V	221	28.3	14.5
8	#16500.00	32.5 AV	54.0	-21.5	1.33 V	221	18.0	14.5

**REMARKS:**

1. Emission Level(dBuV/m) = Raw Value(dBuV) + Correction Factor(dB/m)
2. Correction Factor(dB/m) = Antenna Factor(dB/m) + Cable Factor(dB) – Pre-Amplifier Factor(dB)
3. The other emission levels were very low against the limit.
4. Margin value = Emission Level – Limit value
5. " \* ": Fundamental frequency.
6. " # ": The radiated frequency is out of the restricted band.

<b>CHANNEL</b>	TX Channel 116	<b>DETECTOR FUNCTION</b>	Peak (PK)
<b>FREQUENCY RANGE</b>	1GHz ~ 40GHz		Average (AV)

**ANTENNA POLARITY & TEST DISTANCE: HORIZONTAL AT 3 M**

NO.	FREQ. (MHz)	EMISSION LEVEL (dBuV/m)	LIMIT (dBuV/m)	MARGIN (dB)	ANTENNA HEIGHT (m)	TABLE ANGLE (Degree)	RAW VALUE (dBuV)	CORRECTION FACTOR (dB/m)
1	#5470.00	50.1 PK	74.0	-23.9	2.30 H	98	45.9	4.2
2	#5470.00	38.1 AV	54.0	-15.9	2.30 H	98	33.9	4.2
3	*5580.00	116.9 PK			2.30 H	98	112.7	4.2
4	*5580.00	106.3 AV			2.30 H	98	102.1	4.2
5	#5725.00	49.8 PK	74.0	-24.2	2.30 H	98	45.4	4.4
6	#5725.00	39.3 AV	54.0	-14.7	2.30 H	98	34.9	4.4
7	11160.00	47.5 PK	74.0	-26.5	1.69 H	286	33.8	13.7
8	11160.00	34.2 AV	54.0	-19.8	1.69 H	286	20.5	13.7
9	#16740.00	45.8 PK	74.0	-28.2	1.58 H	228	30.1	15.7
10	#16740.00	34.0 AV	54.0	-20.0	1.58 H	228	18.3	15.7

**ANTENNA POLARITY & TEST DISTANCE: VERTICAL AT 3 M**

NO.	FREQ. (MHz)	EMISSION LEVEL (dBuV/m)	LIMIT (dBuV/m)	MARGIN (dB)	ANTENNA HEIGHT (m)	TABLE ANGLE (Degree)	RAW VALUE (dBuV)	CORRECTION FACTOR (dB/m)
1	#5470.00	46.9 PK	74.0	-27.1	2.25 V	329	42.7	4.2
2	#5470.00	34.8 AV	54.0	-19.2	2.25 V	329	30.6	4.2
3	*5580.00	102.3 PK			2.25 V	329	98.1	4.2
4	*5580.00	92.1 AV			2.25 V	329	87.9	4.2
5	#5725.00	46.6 PK	74.0	-27.4	2.25 V	329	42.2	4.4
6	#5725.00	36.0 AV	54.0	-18.0	2.25 V	329	31.6	4.4
7	11160.00	46.3 PK	74.0	-27.7	1.65 V	294	32.6	13.7
8	11160.00	33.0 AV	54.0	-21.0	1.65 V	294	19.3	13.7
9	#16740.00	43.0 PK	74.0	-31.0	1.33 V	202	27.3	15.7
10	#16740.00	32.7 AV	54.0	-21.3	1.33 V	202	17.0	15.7

**REMARKS:**

1. Emission Level(dBuV/m) = Raw Value(dBuV) + Correction Factor(dB/m)
2. Correction Factor(dB/m) = Antenna Factor(dB/m) + Cable Factor(dB) – Pre-Amplifier Factor(dB)
3. The other emission levels were very low against the limit.
4. Margin value = Emission Level – Limit value
5. " \* ": Fundamental frequency.
6. " # ": The radiated frequency is out of the restricted band.

<b>CHANNEL</b>	TX Channel 140	<b>DETECTOR FUNCTION</b>	Peak (PK)
<b>FREQUENCY RANGE</b>	1GHz ~ 40GHz		Average (AV)

**ANTENNA POLARITY & TEST DISTANCE: HORIZONTAL AT 3 M**

NO.	FREQ. (MHz)	EMISSION LEVEL (dBuV/m)	LIMIT (dBuV/m)	MARGIN (dB)	ANTENNA HEIGHT (m)	TABLE ANGLE (Degree)	RAW VALUE (dBuV)	CORRECTION FACTOR (dB/m)
1	*5700.00	116.8 PK			2.70 H	94	112.3	4.5
2	*5700.00	105.7 AV			2.70 H	94	101.2	4.5
3	#5725.00	68.1 PK	74.0	-5.9	2.70 H	94	63.7	4.4
4	<b>#5725.00</b>	<b>53.9 AV</b>	<b>54.0</b>	<b>-0.1</b>	<b>2.70 H</b>	<b>94</b>	<b>49.5</b>	<b>4.4</b>
5	11400.00	47.8 PK	74.0	-26.2	1.73 H	301	34.2	13.6
6	11400.00	34.8 AV	54.0	-19.2	1.73 H	301	21.2	13.6
7	#17100.00	45.6 PK	74.0	-28.4	1.69 H	228	28.2	17.4
8	#17100.00	34.0 AV	54.0	-20.0	1.69 H	228	16.6	17.4

**ANTENNA POLARITY & TEST DISTANCE: VERTICAL AT 3 M**

NO.	FREQ. (MHz)	EMISSION LEVEL (dBuV/m)	LIMIT (dBuV/m)	MARGIN (dB)	ANTENNA HEIGHT (m)	TABLE ANGLE (Degree)	RAW VALUE (dBuV)	CORRECTION FACTOR (dB/m)
1	*5700.00	102.1 PK			2.25 V	325	97.6	4.5
2	*5700.00	91.4 AV			2.25 V	325	86.9	4.5
3	#5725.00	54.8 PK	74.0	-19.2	2.25 V	325	50.4	4.4
4	#5725.00	42.5 AV	54.0	-11.5	2.25 V	325	38.1	4.4
5	11400.00	46.6 PK	74.0	-27.4	1.62 V	304	33.0	13.6
6	11400.00	33.4 AV	54.0	-20.6	1.62 V	304	19.8	13.6
7	#17100.00	43.4 PK	74.0	-30.6	1.33 V	202	26.0	17.4
8	#17100.00	32.9 AV	54.0	-21.1	1.33 V	202	15.5	17.4

**REMARKS:**

1. Emission Level(dBuV/m) = Raw Value(dBuV) + Correction Factor(dB/m)
2. Correction Factor(dB/m) = Antenna Factor(dB/m) + Cable Factor(dB) – Pre-Amplifier Factor(dB)
3. The other emission levels were very low against the limit.
4. Margin value = Emission Level – Limit value
5. " \* ": Fundamental frequency.
6. " # ": The radiated frequency is out of the restricted band.

<b>CHANNEL</b>	TX Channel 144	<b>DETECTOR FUNCTION</b>	Peak (PK)
<b>FREQUENCY RANGE</b>	1GHz ~ 40GHz		Average (AV)

**ANTENNA POLARITY & TEST DISTANCE: HORIZONTAL AT 3 M**

NO.	FREQ. (MHz)	EMISSION LEVEL (dBuV/m)	LIMIT (dBuV/m)	MARGIN (dB)	ANTENNA HEIGHT (m)	TABLE ANGLE (Degree)	RAW VALUE (dBuV)	CORRECTION FACTOR (dB/m)
1	#5470.00	49.3 PK	74.0	-24.7	2.70 H	94	45.1	4.2
2	#5470.00	36.8 AV	54.0	-17.2	2.70 H	94	32.6	4.2
3	*5720.00	117.4 PK			2.70 H	94	113.0	4.4
4	*5720.00	106.0 AV			2.70 H	94	101.6	4.4
5	#5850.00	50.3 PK	74.0	-23.7	2.70 H	94	45.8	4.5
6	#5850.00	38.8 AV	54.0	-15.2	2.70 H	94	34.3	4.5
7	11440.00	48.0 PK	74.0	-26.0	1.70 H	293	34.5	13.5
8	11440.00	35.0 AV	54.0	-19.0	1.70 H	293	21.5	13.5
9	#17160.00	45.7 PK	74.0	-28.3	1.64 H	212	28.4	17.3
10	#17160.00	34.2 AV	54.0	-19.8	1.64 H	212	16.9	17.3

**ANTENNA POLARITY & TEST DISTANCE: VERTICAL AT 3 M**

NO.	FREQ. (MHz)	EMISSION LEVEL (dBuV/m)	LIMIT (dBuV/m)	MARGIN (dB)	ANTENNA HEIGHT (m)	TABLE ANGLE (Degree)	RAW VALUE (dBuV)	CORRECTION FACTOR (dB/m)
1	#5470.00	46.1 PK	74.0	-27.9	2.23 V	327	41.9	4.2
2	#5470.00	33.4 AV	54.0	-20.6	2.23 V	327	29.2	4.2
3	*5720.00	101.8 PK			2.23 V	327	97.4	4.4
4	*5720.00	91.6 AV			2.23 V	327	87.2	4.4
5	#5850.00	47.2 PK	74.0	-26.8	2.23 V	327	42.7	4.5
6	#5850.00	35.5 AV	54.0	-18.5	2.23 V	327	31.0	4.5
7	11440.00	46.8 PK	74.0	-27.2	1.64 V	291	33.3	13.5
8	11440.00	33.5 AV	54.0	-20.5	1.64 V	291	20.0	13.5
9	#17160.00	42.4 PK	74.0	-31.6	1.37 V	227	25.1	17.3
10	#17160.00	32.2 AV	54.0	-21.8	1.37 V	227	14.9	17.3

**REMARKS:**

1. Emission Level(dBuV/m) = Raw Value(dBuV) + Correction Factor(dB/m)
2. Correction Factor(dB/m) = Antenna Factor(dB/m) + Cable Factor(dB) – Pre-Amplifier Factor(dB)
3. The other emission levels were very low against the limit.
4. Margin value = Emission Level – Limit value
5. " \* ": Fundamental frequency.
6. " # ": The radiated frequency is out of the restricted band.

**802.11ac (VHT40)**

<b>CHANNEL</b>	TX Channel 54	<b>DETECTOR FUNCTION</b>	Peak (PK)
<b>FREQUENCY RANGE</b>	1GHz ~ 40GHz		Average (AV)

**ANTENNA POLARITY & TEST DISTANCE: HORIZONTAL AT 3 M**

NO.	FREQ. (MHz)	EMISSION LEVEL (dBuV/m)	LIMIT (dBuV/m)	MARGIN (dB)	ANTENNA HEIGHT (m)	TABLE ANGLE (Degree)	RAW VALUE (dBuV)	CORRECTION FACTOR (dB/m)
1	5150.00	48.6 PK	74.0	-25.4	2.73 H	102	44.9	3.7
2	5150.00	38.9 AV	54.0	-15.1	2.73 H	102	35.2	3.7
3	*5270.00	114.2 PK			2.73 H	102	110.2	4.0
4	*5270.00	104.8 AV			2.73 H	102	100.8	4.0
5	5350.00	51.1 PK	74.0	-22.9	2.73 H	102	47.0	4.1
6	5350.00	40.4 AV	54.0	-13.6	2.73 H	102	36.3	4.1
7	#10540.00	47.4 PK	74.0	-26.6	1.75 H	303	34.1	13.3
8	#10540.00	34.2 AV	54.0	-19.8	1.75 H	303	20.9	13.3
9	15810.00	46.6 PK	74.0	-27.4	1.69 H	206	33.2	13.4
10	15810.00	34.7 AV	54.0	-19.3	1.69 H	206	21.3	13.4

**ANTENNA POLARITY & TEST DISTANCE: VERTICAL AT 3 M**

NO.	FREQ. (MHz)	EMISSION LEVEL (dBuV/m)	LIMIT (dBuV/m)	MARGIN (dB)	ANTENNA HEIGHT (m)	TABLE ANGLE (Degree)	RAW VALUE (dBuV)	CORRECTION FACTOR (dB/m)
1	5150.00	45.5 PK	74.0	-28.5	2.19 V	331	41.8	3.7
2	5150.00	35.5 AV	54.0	-18.5	2.19 V	331	31.8	3.7
3	*5270.00	100.8 PK			2.19 V	331	96.8	4.0
4	*5270.00	90.5 AV			2.19 V	331	86.5	4.0
5	5350.00	47.7 PK	74.0	-26.3	2.19 V	331	43.6	4.1
6	5350.00	37.2 AV	54.0	-16.8	2.19 V	331	33.1	4.1
7	#10540.00	46.9 PK	74.0	-27.1	1.64 V	296	33.6	13.3
8	#10540.00	33.5 AV	54.0	-20.5	1.64 V	296	20.2	13.3
9	15810.00	42.9 PK	74.0	-31.1	1.36 V	210	29.5	13.4
10	15810.00	32.3 AV	54.0	-21.7	1.36 V	210	18.9	13.4

**REMARKS:**

1. Emission Level(dBuV/m) = Raw Value(dBuV) + Correction Factor(dB/m)
2. Correction Factor(dB/m) = Antenna Factor(dB/m) + Cable Factor(dB) – Pre-Amplifier Factor(dB)
3. The other emission levels were very low against the limit.
4. Margin value = Emission Level – Limit value
5. " \* ": Fundamental frequency.
6. " # ": The radiated frequency is out of the restricted band.

<b>CHANNEL</b>	TX Channel 62	<b>DETECTOR FUNCTION</b>	Peak (PK)
<b>FREQUENCY RANGE</b>	1GHz ~ 40GHz		Average (AV)

**ANTENNA POLARITY & TEST DISTANCE: HORIZONTAL AT 3 M**

NO.	FREQ. (MHz)	EMISSION LEVEL (dBuV/m)	LIMIT (dBuV/m)	MARGIN (dB)	ANTENNA HEIGHT (m)	TABLE ANGLE (Degree)	RAW VALUE (dBuV)	CORRECTION FACTOR (dB/m)
1	*5310.00	110.4 PK			2.73 H	102	106.3	4.1
2	*5310.00	101.5 AV			2.73 H	102	97.4	4.1
3	5350.00	68.4 PK	74.0	-5.6	2.73 H	102	64.3	4.1
4	5350.00	53.6 AV	54.0	-0.4	2.73 H	102	49.5	4.1
5	10620.00	47.9 PK	74.0	-26.1	1.70 H	288	34.4	13.5
6	10620.00	34.6 AV	54.0	-19.4	1.70 H	288	21.1	13.5
7	15930.00	45.3 PK	74.0	-28.7	1.67 H	230	32.5	12.8
8	15930.00	33.9 AV	54.0	-20.1	1.67 H	230	21.1	12.8

**ANTENNA POLARITY & TEST DISTANCE: VERTICAL AT 3 M**

NO.	FREQ. (MHz)	EMISSION LEVEL (dBuV/m)	LIMIT (dBuV/m)	MARGIN (dB)	ANTENNA HEIGHT (m)	TABLE ANGLE (Degree)	RAW VALUE (dBuV)	CORRECTION FACTOR (dB/m)
1	*5310.00	97.3 PK			2.15 V	327	93.2	4.1
2	*5310.00	87.3 AV			2.15 V	327	83.2	4.1
3	5350.00	55.1 PK	74.0	-18.9	2.15 V	327	51.0	4.1
4	5350.00	42.2 AV	54.0	-11.8	2.15 V	327	38.1	4.1
5	10620.00	46.4 PK	74.0	-27.6	1.67 V	296	32.9	13.5
6	10620.00	33.4 AV	54.0	-20.6	1.67 V	296	19.9	13.5
7	15930.00	43.2 PK	74.0	-30.8	1.35 V	214	30.4	12.8
8	15930.00	32.6 AV	54.0	-21.4	1.35 V	214	19.8	12.8

**REMARKS:**

1. Emission Level(dBuV/m) = Raw Value(dBuV) + Correction Factor(dB/m)
2. Correction Factor(dB/m) = Antenna Factor(dB/m) + Cable Factor(dB) – Pre-Amplifier Factor(dB)
3. The other emission levels were very low against the limit.
4. Margin value = Emission Level – Limit value
5. " \* ": Fundamental frequency.

<b>CHANNEL</b>	TX Channel 102	<b>DETECTOR FUNCTION</b>	Peak (PK)
<b>FREQUENCY RANGE</b>	1GHz ~ 40GHz		Average (AV)

**ANTENNA POLARITY & TEST DISTANCE: HORIZONTAL AT 3 M**

NO.	FREQ. (MHz)	EMISSION LEVEL (dBuV/m)	LIMIT (dBuV/m)	MARGIN (dB)	ANTENNA HEIGHT (m)	TABLE ANGLE (Degree)	RAW VALUE (dBuV)	CORRECTION FACTOR (dB/m)
1	#5466.80	67.0 PK	74.0	-7.0	2.27 H	100	62.8	4.2
2	#5466.80	53.9 AV	54.0	-0.1	2.27 H	100	49.7	4.2
3	*5510.00	110.8 PK			2.27 H	100	106.6	4.2
4	*5510.00	101.0 AV			2.27 H	100	96.8	4.2
5	11020.00	48.3 PK	74.0	-25.7	1.78 H	302	34.3	14.0
6	11020.00	35.0 AV	54.0	-19.0	1.78 H	302	21.0	14.0
7	#16530.00	45.9 PK	74.0	-28.1	1.58 H	225	31.0	14.9
8	#16530.00	34.5 AV	54.0	-19.5	1.58 H	225	19.6	14.9

**ANTENNA POLARITY & TEST DISTANCE: VERTICAL AT 3 M**

NO.	FREQ. (MHz)	EMISSION LEVEL (dBuV/m)	LIMIT (dBuV/m)	MARGIN (dB)	ANTENNA HEIGHT (m)	TABLE ANGLE (Degree)	RAW VALUE (dBuV)	CORRECTION FACTOR (dB/m)
1	#5466.80	52.2 PK	74.0	-21.8	2.20 V	321	48.0	4.2
2	#5466.80	41.8 AV	54.0	-12.2	2.20 V	321	37.6	4.2
3	*5510.00	97.2 PK			2.20 V	321	93.0	4.2
4	*5510.00	86.8 AV			2.20 V	321	82.6	4.2
5	11020.00	46.8 PK	74.0	-27.2	1.66 V	311	32.8	14.0
6	11020.00	33.5 AV	54.0	-20.5	1.66 V	311	19.5	14.0
7	#16530.00	42.9 PK	74.0	-31.1	1.27 V	220	28.0	14.9
8	#16530.00	32.4 AV	54.0	-21.6	1.27 V	220	17.5	14.9

**REMARKS:**

1. Emission Level(dBuV/m) = Raw Value(dBuV) + Correction Factor(dB/m)
2. Correction Factor(dB/m) = Antenna Factor(dB/m) + Cable Factor(dB) – Pre-Amplifier Factor(dB)
3. The other emission levels were very low against the limit.
4. Margin value = Emission Level – Limit value
5. " \* ": Fundamental frequency.
6. " # ": The radiated frequency is out of the restricted band.



<b>CHANNEL</b>	TX Channel 110	<b>DETECTOR FUNCTION</b>	Peak (PK)
<b>FREQUENCY RANGE</b>	1GHz ~ 40GHz		Average (AV)

**ANTENNA POLARITY & TEST DISTANCE: HORIZONTAL AT 3 M**

NO.	FREQ. (MHz)	EMISSION LEVEL (dBuV/m)	LIMIT (dBuV/m)	MARGIN (dB)	ANTENNA HEIGHT (m)	TABLE ANGLE (Degree)	RAW VALUE (dBuV)	CORRECTION FACTOR (dB/m)
1	#5470.00	58.4 PK	74.0	-15.6	2.73 H	100	54.2	4.2
2	#5470.00	45.1 AV	54.0	-8.9	2.73 H	100	40.9	4.2
3	*5550.00	115.4 PK			2.73 H	100	111.2	4.2
4	*5550.00	106.3 AV			2.73 H	100	102.1	4.2
5	#5725.00	49.5 PK	74.0	-24.5	2.73 H	100	45.1	4.4
6	#5725.00	39.0 AV	54.0	-15.0	2.73 H	100	34.6	4.4
7	11100.00	47.7 PK	74.0	-26.3	1.74 H	300	33.9	13.8
8	11100.00	34.6 AV	54.0	-19.4	1.74 H	300	20.8	13.8
9	#16650.00	45.5 PK	74.0	-28.5	1.67 H	203	29.9	15.6
10	#16650.00	34.0 AV	54.0	-20.0	1.67 H	203	18.4	15.6

**ANTENNA POLARITY & TEST DISTANCE: VERTICAL AT 3 M**

NO.	FREQ. (MHz)	EMISSION LEVEL (dBuV/m)	LIMIT (dBuV/m)	MARGIN (dB)	ANTENNA HEIGHT (m)	TABLE ANGLE (Degree)	RAW VALUE (dBuV)	CORRECTION FACTOR (dB/m)
1	#5470.00	55.1 PK	74.0	-18.9	2.18 V	319	50.9	4.2
2	#5470.00	42.0 AV	54.0	-12.0	2.18 V	319	37.8	4.2
3	*5550.00	101.2 PK			2.18 V	319	97.0	4.2
4	*5550.00	92.0 AV			2.18 V	319	87.8	4.2
5	#5725.00	46.2 PK	74.0	-27.8	2.18 V	319	41.8	4.4
6	#5725.00	35.8 AV	54.0	-18.2	2.18 V	319	31.4	4.4
7	11100.00	46.2 PK	74.0	-27.8	1.68 V	295	32.4	13.8
8	11100.00	33.0 AV	54.0	-21.0	1.68 V	295	19.2	13.8
9	#16650.00	42.5 PK	74.0	-31.5	1.32 V	208	26.9	15.6
10	#16650.00	32.3 AV	54.0	-21.7	1.32 V	208	16.7	15.6

**REMARKS:**

1. Emission Level(dBuV/m) = Raw Value(dBuV) + Correction Factor(dB/m)
2. Correction Factor(dB/m) = Antenna Factor(dB/m) + Cable Factor(dB) – Pre-Amplifier Factor(dB)
3. The other emission levels were very low against the limit.
4. Margin value = Emission Level – Limit value
5. " \* ": Fundamental frequency.
6. " # ": The radiated frequency is out of the restricted band.

<b>CHANNEL</b>	TX Channel 134	<b>DETECTOR FUNCTION</b>	Peak (PK)
<b>FREQUENCY RANGE</b>	1GHz ~ 40GHz		Average (AV)

**ANTENNA POLARITY & TEST DISTANCE: HORIZONTAL AT 3 M**

NO.	FREQ. (MHz)	EMISSION LEVEL (dBuV/m)	LIMIT (dBuV/m)	MARGIN (dB)	ANTENNA HEIGHT (m)	TABLE ANGLE (Degree)	RAW VALUE (dBuV)	CORRECTION FACTOR (dB/m)
1	*5670.00	115.4 PK			2.58 H	95	111.1	4.3
2	*5670.00	105.8 AV			2.58 H	95	101.5	4.3
3	#5725.00	68.2 PK	74.0	-5.8	2.58 H	95	63.8	4.4
<b>4</b>	<b>#5725.00</b>	<b>53.9 AV</b>	<b>54.0</b>	<b>-0.1</b>	<b>2.58 H</b>	<b>95</b>	<b>49.5</b>	<b>4.4</b>
5	11340.00	48.4 PK	74.0	-25.6	1.77 H	304	34.8	13.6
6	11340.00	35.1 AV	54.0	-18.9	1.77 H	304	21.5	13.6
7	#17010.00	45.3 PK	74.0	-28.7	1.64 H	210	28.2	17.1
8	#17010.00	33.9 AV	54.0	-20.1	1.64 H	210	16.8	17.1

**ANTENNA POLARITY & TEST DISTANCE: VERTICAL AT 3 M**

NO.	FREQ. (MHz)	EMISSION LEVEL (dBuV/m)	LIMIT (dBuV/m)	MARGIN (dB)	ANTENNA HEIGHT (m)	TABLE ANGLE (Degree)	RAW VALUE (dBuV)	CORRECTION FACTOR (dB/m)
1	*5670.00	101.2 PK			2.14 V	322	96.9	4.3
2	*5670.00	91.6 AV			2.14 V	322	87.3	4.3
3	#5725.00	54.8 PK	74.0	-19.2	2.14 V	322	50.4	4.4
4	#5725.00	42.5 AV	54.0	-11.5	2.14 V	322	38.1	4.4
5	11340.00	46.2 PK	74.0	-27.8	1.59 V	319	32.6	13.6
6	11340.00	33.1 AV	54.0	-20.9	1.59 V	319	19.5	13.6
7	#17010.00	42.7 PK	74.0	-31.3	1.31 V	216	25.6	17.1
8	#17010.00	32.3 AV	54.0	-21.7	1.31 V	216	15.2	17.1

**REMARKS:**

1. Emission Level(dBuV/m) = Raw Value(dBuV) + Correction Factor(dB/m)
2. Correction Factor(dB/m) = Antenna Factor(dB/m) + Cable Factor(dB) – Pre-Amplifier Factor(dB)
3. The other emission levels were very low against the limit.
4. Margin value = Emission Level – Limit value
5. " \* ": Fundamental frequency.
6. " # ": The radiated frequency is out of the restricted band.

<b>CHANNEL</b>	TX Channel 142	<b>DETECTOR FUNCTION</b>	Peak (PK)
<b>FREQUENCY RANGE</b>	1GHz ~ 40GHz		Average (AV)

**ANTENNA POLARITY & TEST DISTANCE: HORIZONTAL AT 3 M**

NO.	FREQ. (MHz)	EMISSION LEVEL (dBuV/m)	LIMIT (dBuV/m)	MARGIN (dB)	ANTENNA HEIGHT (m)	TABLE ANGLE (Degree)	RAW VALUE (dBuV)	CORRECTION FACTOR (dB/m)
1	#5470.00	49.0 PK	74.0	-25.0	2.45 H	93	44.8	4.2
2	#5470.00	37.2 AV	54.0	-16.8	2.45 H	93	33.0	4.2
3	*5710.00	115.8 PK			2.45 H	93	111.3	4.5
4	*5710.00	107.2 AV			2.45 H	93	102.7	4.5
5	#5850.00	49.5 PK	74.0	-24.5	2.45 H	93	45.0	4.5
6	#5850.00	38.6 AV	54.0	-15.4	2.45 H	93	34.1	4.5
7	11420.00	47.4 PK	74.0	-26.6	1.79 H	308	33.8	13.6
8	11420.00	34.6 AV	54.0	-19.4	1.79 H	308	21.0	13.6
9	#17130.00	46.0 PK	74.0	-28.0	1.65 H	215	28.6	17.4
10	#17130.00	34.2 AV	54.0	-19.8	1.65 H	215	16.8	17.4

**ANTENNA POLARITY & TEST DISTANCE: VERTICAL AT 3 M**

NO.	FREQ. (MHz)	EMISSION LEVEL (dBuV/m)	LIMIT (dBuV/m)	MARGIN (dB)	ANTENNA HEIGHT (m)	TABLE ANGLE (Degree)	RAW VALUE (dBuV)	CORRECTION FACTOR (dB/m)
1	#5470.00	45.7 PK	74.0	-28.3	2.11 V	321	41.5	4.2
2	#5470.00	33.9 AV	54.0	-20.1	2.11 V	321	29.7	4.2
3	*5710.00	102.6 PK			2.11 V	321	98.1	4.5
4	*5710.00	93.6 AV			2.11 V	321	89.1	4.5
5	#5850.00	46.2 PK	74.0	-27.8	2.11 V	321	41.7	4.5
6	#5850.00	35.4 AV	54.0	-18.6	2.11 V	321	30.9	4.5
7	11420.00	46.4 PK	74.0	-27.6	1.68 V	314	32.8	13.6
8	11420.00	33.3 AV	54.0	-20.7	1.68 V	314	19.7	13.6
9	#17130.00	43.6 PK	74.0	-30.4	1.35 V	203	26.2	17.4
10	#17130.00	32.8 AV	54.0	-21.2	1.35 V	203	15.4	17.4

**REMARKS:**

1. Emission Level(dBuV/m) = Raw Value(dBuV) + Correction Factor(dB/m)
2. Correction Factor(dB/m) = Antenna Factor(dB/m) + Cable Factor(dB) – Pre-Amplifier Factor(dB)
3. The other emission levels were very low against the limit.
4. Margin value = Emission Level – Limit value
5. " \* ": Fundamental frequency.
6. " # ": The radiated frequency is out of the restricted band.

**802.11ac (VHT80)**

<b>CHANNEL</b>	TX Channel 58	<b>DETECTOR FUNCTION</b>	Peak (PK)
<b>FREQUENCY RANGE</b>	1GHz ~ 40GHz		Average (AV)

**ANTENNA POLARITY & TEST DISTANCE: HORIZONTAL AT 3 M**

NO.	FREQ. (MHz)	EMISSION LEVEL (dBuV/m)	LIMIT (dBuV/m)	MARGIN (dB)	ANTENNA HEIGHT (m)	TABLE ANGLE (Degree)	RAW VALUE (dBuV)	CORRECTION FACTOR (dB/m)
1	5150.00	50.2 PK	74.0	-23.8	3.06 H	78	46.5	3.7
2	5150.00	39.3 AV	54.0	-14.7	3.06 H	78	35.6	3.7
3	*5290.00	104.0 PK			3.06 H	78	99.9	4.1
4	*5290.00	95.0 AV			3.06 H	78	90.9	4.1
5	5356.00	65.0 PK	74.0	-9.0	3.06 H	78	60.9	4.1
<b>6</b>	<b>5356.00</b>	<b>53.9 AV</b>	<b>54.0</b>	<b>-0.1</b>	<b>3.06 H</b>	<b>78</b>	<b>49.8</b>	<b>4.1</b>
7	#10580.00	47.8 PK	74.0	-26.2	1.75 H	291	34.4	13.4
8	#10580.00	34.9 AV	54.0	-19.1	1.75 H	291	21.5	13.4
9	15870.00	45.7 PK	74.0	-28.3	1.61 H	206	32.7	13.0
10	15870.00	34.0 AV	54.0	-20.0	1.61 H	206	21.0	13.0

**ANTENNA POLARITY & TEST DISTANCE: VERTICAL AT 3 M**

NO.	FREQ. (MHz)	EMISSION LEVEL (dBuV/m)	LIMIT (dBuV/m)	MARGIN (dB)	ANTENNA HEIGHT (m)	TABLE ANGLE (Degree)	RAW VALUE (dBuV)	CORRECTION FACTOR (dB/m)
1	5150.00	47.0 PK	74.0	-27.0	2.06 V	310	43.3	3.7
2	5150.00	36.1 AV	54.0	-17.9	2.06 V	310	32.4	3.7
3	*5290.00	90.8 PK			2.06 V	310	86.7	4.1
4	*5290.00	80.7 AV			2.06 V	310	76.6	4.1
5	5356.00	51.7 PK	74.0	-22.3	2.06 V	310	47.6	4.1
6	5356.00	42.5 AV	54.0	-11.5	2.06 V	310	38.4	4.1
7	#10580.00	46.0 PK	74.0	-28.0	1.59 V	297	32.6	13.4
8	#10580.00	33.1 AV	54.0	-20.9	1.59 V	297	19.7	13.4
9	15870.00	42.5 PK	74.0	-31.5	1.34 V	215	29.5	13.0
10	15870.00	32.0 AV	54.0	-22.0	1.34 V	215	19.0	13.0

**REMARKS:**

- Emission Level(dBuV/m) = Raw Value(dBuV) + Correction Factor(dB/m)
- Correction Factor(dB/m) = Antenna Factor(dB/m) + Cable Factor(dB) – Pre-Amplifier Factor(dB)
- The other emission levels were very low against the limit.
- Margin value = Emission Level – Limit value
- " \* ": Fundamental frequency.
- " # ": The radiated frequency is out of the restricted band.

<b>CHANNEL</b>	TX Channel 106	<b>DETECTOR FUNCTION</b>	Peak (PK)
<b>FREQUENCY RANGE</b>	1GHz ~ 40GHz		Average (AV)

**ANTENNA POLARITY & TEST DISTANCE: HORIZONTAL AT 3 M**

NO.	FREQ. (MHz)	EMISSION LEVEL (dBuV/m)	LIMIT (dBuV/m)	MARGIN (dB)	ANTENNA HEIGHT (m)	TABLE ANGLE (Degree)	RAW VALUE (dBuV)	CORRECTION FACTOR (dB/m)
1	#5461.00	67.9 PK	74.0	-6.1	2.28 H	97	63.7	4.2
2	#5461.00	53.8 AV	54.0	-0.2	2.28 H	97	49.6	4.2
3	*5530.00	105.2 PK			2.28 H	97	101.0	4.2
4	*5530.00	95.6 AV			2.28 H	97	91.4	4.2
5	#5725.00	51.4 PK	74.0	-22.6	2.28 H	97	47.0	4.4
6	#5725.00	40.2 AV	54.0	-13.8	2.28 H	97	35.8	4.4
7	11060.00	48.4 PK	74.0	-25.6	1.78 H	291	34.5	13.9
8	11060.00	35.0 AV	54.0	-19.0	1.78 H	291	21.1	13.9
9	#16590.00	45.8 PK	74.0	-28.2	1.61 H	216	30.2	15.6
10	#16590.00	34.0 AV	54.0	-20.0	1.61 H	216	18.4	15.6

**ANTENNA POLARITY & TEST DISTANCE: VERTICAL AT 3 M**

NO.	FREQ. (MHz)	EMISSION LEVEL (dBuV/m)	LIMIT (dBuV/m)	MARGIN (dB)	ANTENNA HEIGHT (m)	TABLE ANGLE (Degree)	RAW VALUE (dBuV)	CORRECTION FACTOR (dB/m)
1	#5461.00	54.4 PK	74.0	-19.6	2.01 V	312	50.2	4.2
2	#5461.00	42.2 AV	54.0	-11.8	2.01 V	312	38.0	4.2
3	*5530.00	91.9 PK			2.01 V	312	87.7	4.2
4	*5530.00	81.3 AV			2.01 V	312	77.1	4.2
5	#5725.00	48.1 PK	74.0	-25.9	2.01 V	312	43.7	4.4
6	#5725.00	36.8 AV	54.0	-17.2	2.01 V	312	32.4	4.4
7	11060.00	46.6 PK	74.0	-27.4	1.61 V	313	32.7	13.9
8	11060.00	33.3 AV	54.0	-20.7	1.61 V	313	19.4	13.9
9	#16590.00	43.2 PK	74.0	-30.8	1.27 V	218	27.6	15.6
10	#16590.00	32.8 AV	54.0	-21.2	1.27 V	218	17.2	15.6

**REMARKS:**

1. Emission Level(dBuV/m) = Raw Value(dBuV) + Correction Factor(dB/m)
2. Correction Factor(dB/m) = Antenna Factor(dB/m) + Cable Factor(dB) – Pre-Amplifier Factor(dB)
3. The other emission levels were very low against the limit.
4. Margin value = Emission Level – Limit value
5. " \* ": Fundamental frequency.
6. " # ": The radiated frequency is out of the restricted band.

<b>CHANNEL</b>	TX Channel 122	<b>DETECTOR FUNCTION</b>	Peak (PK)
<b>FREQUENCY RANGE</b>	1GHz ~ 40GHz		Average (AV)

**ANTENNA POLARITY & TEST DISTANCE: HORIZONTAL AT 3 M**

NO.	FREQ. (MHz)	EMISSION LEVEL (dBuV/m)	LIMIT (dBuV/m)	MARGIN (dB)	ANTENNA HEIGHT (m)	TABLE ANGLE (Degree)	RAW VALUE (dBuV)	CORRECTION FACTOR (dB/m)
1	*5610.00	111.7 PK			2.28 H	97	107.3	4.4
2	*5610.00	103.1 AV			2.28 H	97	98.7	4.4
3	#5725.00	67.8 PK	74.0	-6.2	2.28 H	96	63.4	4.4
4	<b>#5725.00</b>	<b>53.9 AV</b>	<b>54.0</b>	<b>-0.1</b>	<b>2.28 H</b>	<b>96</b>	<b>49.5</b>	<b>4.4</b>
5	11220.00	48.0 PK	74.0	-26.0	1.79 H	294	34.3	13.7
6	11220.00	34.9 AV	54.0	-19.1	1.79 H	294	21.2	13.7
7	#16830.00	46.2 PK	74.0	-27.8	1.60 H	212	30.3	15.9
8	#16830.00	34.7 AV	54.0	-19.3	1.60 H	212	18.8	15.9

**ANTENNA POLARITY & TEST DISTANCE: VERTICAL AT 3 M**

NO.	FREQ. (MHz)	EMISSION LEVEL (dBuV/m)	LIMIT (dBuV/m)	MARGIN (dB)	ANTENNA HEIGHT (m)	TABLE ANGLE (Degree)	RAW VALUE (dBuV)	CORRECTION FACTOR (dB/m)
1	*5610.00	99.2 PK			2.04 V	328	94.8	4.4
2	*5610.00	88.8 AV			2.04 V	328	84.4	4.4
3	#5725.00	54.6 PK	74.0	-19.4	2.04 V	328	50.2	4.4
4	#5725.00	42.5 AV	54.0	-11.5	2.04 V	328	38.1	4.4
5	11220.00	46.5 PK	74.0	-27.5	1.59 V	303	32.8	13.7
6	11220.00	33.2 AV	54.0	-20.8	1.59 V	303	19.5	13.7
7	#16830.00	43.5 PK	74.0	-30.5	1.33 V	230	27.6	15.9
8	#16830.00	32.7 AV	54.0	-21.3	1.33 V	230	16.8	15.9

**REMARKS:**

1. Emission Level(dBuV/m) = Raw Value(dBuV) + Correction Factor(dB/m)
2. Correction Factor(dB/m) = Antenna Factor(dB/m) + Cable Factor(dB) – Pre-Amplifier Factor(dB)
3. The other emission levels were very low against the limit.
4. Margin value = Emission Level – Limit value
5. " \* ": Fundamental frequency.
6. " # ": The radiated frequency is out of the restricted band.

<b>CHANNEL</b>	TX Channel 138	<b>DETECTOR FUNCTION</b>	Peak (PK)
<b>FREQUENCY RANGE</b>	1GHz ~ 40GHz		Average (AV)

**ANTENNA POLARITY & TEST DISTANCE: HORIZONTAL AT 3 M**

NO.	FREQ. (MHz)	EMISSION LEVEL (dBuV/m)	LIMIT (dBuV/m)	MARGIN (dB)	ANTENNA HEIGHT (m)	TABLE ANGLE (Degree)	RAW VALUE (dBuV)	CORRECTION FACTOR (dB/m)
1	5460.00	57.3 PK	74.0	-16.7	2.20 H	93	53.1	4.2
2	5460.00	45.3 AV	54.0	-8.7	2.20 H	93	41.1	4.2
3	*5690.00	114.2 PK			2.20 H	93	109.7	4.5
4	*5690.00	105.0 AV			2.20 H	93	100.5	4.5
5	#5850.00	66.1 PK	74.0	-7.9	2.20 H	93	61.6	4.5
6	#5850.00	50.4 AV	54.0	-3.6	2.20 H	93	45.9	4.5
7	11380.00	47.6 PK	74.0	-26.4	1.75 H	296	34.0	13.6
8	11380.00	34.7 AV	54.0	-19.3	1.75 H	296	21.1	13.6
9	#17070.00	46.0 PK	74.0	-28.0	1.60 H	218	28.7	17.3
10	#17070.00	34.4 AV	54.0	-19.6	1.60 H	218	17.1	17.3

**ANTENNA POLARITY & TEST DISTANCE: VERTICAL AT 3 M**

NO.	FREQ. (MHz)	EMISSION LEVEL (dBuV/m)	LIMIT (dBuV/m)	MARGIN (dB)	ANTENNA HEIGHT (m)	TABLE ANGLE (Degree)	RAW VALUE (dBuV)	CORRECTION FACTOR (dB/m)
1	5460.00	54.1 PK	74.0	-19.9	2.00 V	303	49.9	4.2
2	5460.00	41.9 AV	54.0	-12.1	2.00 V	303	37.7	4.2
3	*5690.00	101.3 PK			2.00 V	303	96.8	4.5
4	*5690.00	90.7 AV			2.00 V	303	86.2	4.5
5	#5850.00	63.0 PK	74.0	-11.0	2.00 V	303	58.5	4.5
6	#5850.00	47.1 AV	54.0	-6.9	2.00 V	303	42.6	4.5
7	11380.00	46.3 PK	74.0	-27.7	1.62 V	315	32.7	13.6
8	11380.00	33.2 AV	54.0	-20.8	1.62 V	315	19.6	13.6
9	#17070.00	43.0 PK	74.0	-31.0	1.31 V	211	25.7	17.3
10	#17070.00	32.5 AV	54.0	-21.5	1.31 V	211	15.2	17.3

**REMARKS:**

1. Emission Level(dBuV/m) = Raw Value(dBuV) + Correction Factor(dB/m)
2. Correction Factor(dB/m) = Antenna Factor(dB/m) + Cable Factor(dB) – Pre-Amplifier Factor(dB)
3. The other emission levels were very low against the limit.
4. Margin value = Emission Level – Limit value
5. " \* ": Fundamental frequency.
6. " # ": The radiated frequency is out of the restricted band.

## 4.1.9 Test Results (Mode 3)

## Above 1GHz Data:

## 802.11a

<b>CHANNEL</b>	TX Channel 52	<b>DETECTOR FUNCTION</b>	Peak (PK)
<b>FREQUENCY RANGE</b>	1GHz ~ 40GHz		Average (AV)

**ANTENNA POLARITY & TEST DISTANCE: HORIZONTAL AT 3 M**

NO.	FREQ. (MHz)	EMISSION LEVEL (dBuV/m)	LIMIT (dBuV/m)	MARGIN (dB)	ANTENNA HEIGHT (m)	TABLE ANGLE (Degree)	RAW VALUE (dBuV)	CORRECTION FACTOR (dB/m)
1	5150.00	46.2 PK	74.0	-27.8	2.75 H	96	42.5	3.7
2	5150.00	35.3 AV	54.0	-18.7	2.75 H	96	31.6	3.7
3	*5260.00	116.1 PK			2.75 H	96	112.1	4.0
4	*5260.00	104.3 AV			2.75 H	96	100.3	4.0
5	5350.00	50.9 PK	74.0	-23.1	2.75 H	96	46.8	4.1
6	5350.00	38.7 AV	54.0	-15.3	2.75 H	96	34.6	4.1
7	#10520.00	46.0 PK	74.0	-28.0	1.65 H	234	32.8	13.2
8	#10520.00	33.1 AV	54.0	-20.9	1.65 H	234	19.9	13.2
9	15780.00	45.3 PK	74.0	-28.7	1.79 H	209	31.7	13.6
10	15780.00	32.7 AV	54.0	-21.3	1.79 H	209	19.1	13.6

**ANTENNA POLARITY & TEST DISTANCE: VERTICAL AT 3 M**

NO.	FREQ. (MHz)	EMISSION LEVEL (dBuV/m)	LIMIT (dBuV/m)	MARGIN (dB)	ANTENNA HEIGHT (m)	TABLE ANGLE (Degree)	RAW VALUE (dBuV)	CORRECTION FACTOR (dB/m)
1	5150.00	45.5 PK	74.0	-28.5	3.04 V	338	41.8	3.7
2	5150.00	34.1 AV	54.0	-19.9	3.04 V	338	30.4	3.7
3	*5260.00	101.9 PK			3.04 V	338	97.9	4.0
4	*5260.00	91.4 AV			3.04 V	338	87.4	4.0
5	5350.00	48.7 PK	74.0	-25.3	3.04 V	338	44.6	4.1
6	5350.00	34.6 AV	54.0	-19.4	3.04 V	338	30.5	4.1
7	#10520.00	45.5 PK	74.0	-28.5	1.86 V	226	32.3	13.2
8	#10520.00	32.7 AV	54.0	-21.3	1.86 V	226	19.5	13.2
9	15780.00	44.9 PK	74.0	-29.1	1.69 V	249	31.3	13.6
10	15780.00	32.4 AV	54.0	-21.6	1.69 V	249	18.8	13.6

**REMARKS:**

- Emission Level(dBuV/m) = Raw Value(dBuV) + Correction Factor(dB/m)
- Correction Factor(dB/m) = Antenna Factor(dB/m) + Cable Factor(dB) – Pre-Amplifier Factor(dB)
- The other emission levels were very low against the limit.
- Margin value = Emission Level – Limit value
- " \* ": Fundamental frequency.
- " # ": The radiated frequency is out of the restricted band.



<b>CHANNEL</b>	TX Channel 60	<b>DETECTOR FUNCTION</b>	Peak (PK)
<b>FREQUENCY RANGE</b>	1GHz ~ 40GHz		Average (AV)

**ANTENNA POLARITY & TEST DISTANCE: HORIZONTAL AT 3 M**

NO.	FREQ. (MHz)	EMISSION LEVEL (dBuV/m)	LIMIT (dBuV/m)	MARGIN (dB)	ANTENNA HEIGHT (m)	TABLE ANGLE (Degree)	RAW VALUE (dBuV)	CORRECTION FACTOR (dB/m)
1	5150.00	45.8 PK	74.0	-28.2	2.68 H	103	42.1	3.7
2	5150.00	34.8 AV	54.0	-19.2	2.68 H	103	31.1	3.7
3	*5300.00	115.6 PK			2.68 H	103	111.5	4.1
4	*5300.00	103.6 AV			2.68 H	103	99.5	4.1
5	5350.00	58.8 PK	74.0	-15.2	2.68 H	103	54.7	4.1
6	5350.00	44.7 AV	54.0	-9.3	2.68 H	103	40.6	4.1
7	10600.00	45.6 PK	74.0	-28.4	1.61 H	247	32.1	13.5
8	10600.00	32.9 AV	54.0	-21.1	1.61 H	247	19.4	13.5
9	15900.00	45.2 PK	74.0	-28.8	1.84 H	198	32.3	12.9
10	15900.00	32.5 AV	54.0	-21.5	1.84 H	198	19.6	12.9

**ANTENNA POLARITY & TEST DISTANCE: VERTICAL AT 3 M**

NO.	FREQ. (MHz)	EMISSION LEVEL (dBuV/m)	LIMIT (dBuV/m)	MARGIN (dB)	ANTENNA HEIGHT (m)	TABLE ANGLE (Degree)	RAW VALUE (dBuV)	CORRECTION FACTOR (dB/m)
1	5150.00	42.7 PK	74.0	-31.3	3.09 V	337	39.0	3.7
2	5150.00	31.6 AV	54.0	-22.4	3.09 V	337	27.9	3.7
3	*5300.00	102.2 PK			3.09 V	337	98.1	4.1
4	*5300.00	90.8 AV			3.09 V	337	86.7	4.1
5	5350.00	55.7 PK	74.0	-18.3	3.09 V	337	51.6	4.1
6	5350.00	41.5 AV	54.0	-12.5	3.09 V	337	37.4	4.1
7	10600.00	45.5 PK	74.0	-28.5	1.90 V	230	32.0	13.5
8	10600.00	32.7 AV	54.0	-21.3	1.90 V	230	19.2	13.5
9	15900.00	44.9 PK	74.0	-29.1	1.65 V	236	32.0	12.9
10	15900.00	32.3 AV	54.0	-21.7	1.65 V	236	19.4	12.9

**REMARKS:**

1. Emission Level(dBuV/m) = Raw Value(dBuV) + Correction Factor(dB/m)
2. Correction Factor(dB/m) = Antenna Factor(dB/m) + Cable Factor(dB) – Pre-Amplifier Factor(dB)
3. The other emission levels were very low against the limit.
4. Margin value = Emission Level – Limit value
5. " \* ": Fundamental frequency.

<b>CHANNEL</b>	TX Channel 64	<b>DETECTOR FUNCTION</b>	Peak (PK)
<b>FREQUENCY RANGE</b>	1GHz ~ 40GHz		Average (AV)

**ANTENNA POLARITY & TEST DISTANCE: HORIZONTAL AT 3 M**

NO.	FREQ. (MHz)	EMISSION LEVEL (dBuV/m)	LIMIT (dBuV/m)	MARGIN (dB)	ANTENNA HEIGHT (m)	TABLE ANGLE (Degree)	RAW VALUE (dBuV)	CORRECTION FACTOR (dB/m)
1	*5320.00	115.1 PK			2.73 H	100	111.0	4.1
2	*5320.00	103.4 AV			2.73 H	100	99.3	4.1
3	5350.00	65.4 PK	74.0	-8.6	2.73 H	100	61.3	4.1
4	5350.00	51.8 AV	54.0	-2.2	2.73 H	100	47.7	4.1
5	10640.00	45.7 PK	74.0	-28.3	1.61 H	262	32.2	13.5
6	10640.00	33.2 AV	54.0	-20.8	1.61 H	262	19.7	13.5
7	15960.00	45.5 PK	74.0	-28.5	1.87 H	210	32.6	12.9
8	15960.00	32.8 AV	54.0	-21.2	1.87 H	210	19.9	12.9

**ANTENNA POLARITY & TEST DISTANCE: VERTICAL AT 3 M**

NO.	FREQ. (MHz)	EMISSION LEVEL (dBuV/m)	LIMIT (dBuV/m)	MARGIN (dB)	ANTENNA HEIGHT (m)	TABLE ANGLE (Degree)	RAW VALUE (dBuV)	CORRECTION FACTOR (dB/m)
1	*5320.00	101.7 PK			3.14 V	323	97.6	4.1
2	*5320.00	90.7 AV			3.14 V	323	86.6	4.1
3	5350.00	54.4 PK	74.0	-19.6	3.14 V	323	50.3	4.1
4	5350.00	40.7 AV	54.0	-13.3	3.14 V	323	36.6	4.1
5	10640.00	45.3 PK	74.0	-28.7	1.88 V	243	31.8	13.5
6	10640.00	32.3 AV	54.0	-21.7	1.88 V	243	18.8	13.5
7	15960.00	45.3 PK	74.0	-28.7	1.60 V	229	32.4	12.9
8	15960.00	32.5 AV	54.0	-21.5	1.60 V	229	19.6	12.9

**REMARKS:**

1. Emission Level(dBuV/m) = Raw Value(dBuV) + Correction Factor(dB/m)
2. Correction Factor(dB/m) = Antenna Factor(dB/m) + Cable Factor(dB) – Pre-Amplifier Factor(dB)
3. The other emission levels were very low against the limit.
4. Margin value = Emission Level – Limit value
5. " \* ": Fundamental frequency.

<b>CHANNEL</b>	TX Channel 100	<b>DETECTOR FUNCTION</b>	Peak (PK)
<b>FREQUENCY RANGE</b>	1GHz ~ 40GHz		Average (AV)

**ANTENNA POLARITY & TEST DISTANCE: HORIZONTAL AT 3 M**

NO.	FREQ. (MHz)	EMISSION LEVEL (dBuV/m)	LIMIT (dBuV/m)	MARGIN (dB)	ANTENNA HEIGHT (m)	TABLE ANGLE (Degree)	RAW VALUE (dBuV)	CORRECTION FACTOR (dB/m)
1	#5470.00	70.7 PK	74.0	-3.3	2.71 H	100	66.5	4.2
2	#5470.00	53.1 AV	54.0	-0.9	2.71 H	100	48.9	4.2
3	*5500.00	115.9 PK			2.71 H	100	111.7	4.2
4	*5500.00	104.8 AV			2.71 H	100	100.6	4.2
5	11000.00	46.1 PK	74.0	-27.9	1.56 H	269	32.0	14.1
6	11000.00	33.6 AV	54.0	-20.4	1.56 H	269	19.5	14.1
7	#16500.00	45.9 PK	74.0	-28.1	1.90 H	196	31.4	14.5
8	#16500.00	33.0 AV	54.0	-21.0	1.90 H	196	18.5	14.5

**ANTENNA POLARITY & TEST DISTANCE: VERTICAL AT 3 M**

NO.	FREQ. (MHz)	EMISSION LEVEL (dBuV/m)	LIMIT (dBuV/m)	MARGIN (dB)	ANTENNA HEIGHT (m)	TABLE ANGLE (Degree)	RAW VALUE (dBuV)	CORRECTION FACTOR (dB/m)
1	#5470.00	59.3 PK	74.0	-14.7	3.12 V	337	55.1	4.2
2	#5470.00	41.5 AV	54.0	-12.5	3.12 V	337	37.3	4.2
3	*5500.00	102.6 PK			3.12 V	337	98.4	4.2
4	*5500.00	92.4 AV			3.12 V	337	88.2	4.2
5	11000.00	45.5 PK	74.0	-28.5	1.85 V	259	31.4	14.1
6	11000.00	32.3 AV	54.0	-21.7	1.85 V	259	18.2	14.1
7	#16500.00	45.3 PK	74.0	-28.7	1.64 V	240	30.8	14.5
8	#16500.00	32.6 AV	54.0	-21.4	1.64 V	240	18.1	14.5

**REMARKS:**

1. Emission Level(dBuV/m) = Raw Value(dBuV) + Correction Factor(dB/m)
2. Correction Factor(dB/m) = Antenna Factor(dB/m) + Cable Factor(dB) – Pre-Amplifier Factor(dB)
3. The other emission levels were very low against the limit.
4. Margin value = Emission Level – Limit value
5. " \* ": Fundamental frequency.
6. " # ": The radiated frequency is out of the restricted band.

<b>CHANNEL</b>	TX Channel 116	<b>DETECTOR FUNCTION</b>	Peak (PK)
<b>FREQUENCY RANGE</b>	1GHz ~ 40GHz		Average (AV)

**ANTENNA POLARITY & TEST DISTANCE: HORIZONTAL AT 3 M**

NO.	FREQ. (MHz)	EMISSION LEVEL (dBuV/m)	LIMIT (dBuV/m)	MARGIN (dB)	ANTENNA HEIGHT (m)	TABLE ANGLE (Degree)	RAW VALUE (dBuV)	CORRECTION FACTOR (dB/m)
1	#5470.00	48.9 PK	74.0	-25.1	2.61 H	98	44.7	4.2
2	#5470.00	37.0 AV	54.0	-17.0	2.61 H	98	32.8	4.2
3	*5580.00	115.7 PK			2.61 H	98	111.5	4.2
4	*5580.00	103.8 AV			2.61 H	98	99.6	4.2
5	#5725.00	46.6 PK	74.0	-27.4	2.61 H	98	42.2	4.4
6	#5725.00	34.9 AV	54.0	-19.1	2.61 H	98	30.5	4.4
7	11160.00	46.0 PK	74.0	-28.0	1.56 H	260	32.3	13.7
8	11160.00	33.6 AV	54.0	-20.4	1.56 H	260	19.9	13.7
9	#16740.00	45.2 PK	74.0	-28.8	1.82 H	224	29.5	15.7
10	#16740.00	32.5 AV	54.0	-21.5	1.82 H	224	16.8	15.7

**ANTENNA POLARITY & TEST DISTANCE: VERTICAL AT 3 M**

NO.	FREQ. (MHz)	EMISSION LEVEL (dBuV/m)	LIMIT (dBuV/m)	MARGIN (dB)	ANTENNA HEIGHT (m)	TABLE ANGLE (Degree)	RAW VALUE (dBuV)	CORRECTION FACTOR (dB/m)
1	#5470.00	47.7 PK	74.0	-26.3	3.15 V	337	43.5	4.2
2	#5470.00	34.2 AV	54.0	-19.8	3.15 V	337	30.0	4.2
3	*5580.00	102.1 PK			3.15 V	337	97.9	4.2
4	*5580.00	91.4 AV			3.15 V	337	87.2	4.2
5	#5725.00	45.3 PK	74.0	-28.7	3.15 V	337	40.9	4.4
6	#5725.00	33.1 AV	54.0	-20.9	3.15 V	337	28.7	4.4
7	11160.00	45.0 PK	74.0	-29.0	1.87 V	251	31.3	13.7
8	11160.00	32.0 AV	54.0	-22.0	1.87 V	251	18.3	13.7
9	#16740.00	45.3 PK	74.0	-28.7	1.64 V	217	29.6	15.7
10	#16740.00	32.7 AV	54.0	-21.3	1.64 V	217	17.0	15.7

**REMARKS:**

1. Emission Level(dBuV/m) = Raw Value(dBuV) + Correction Factor(dB/m)
2. Correction Factor(dB/m) = Antenna Factor(dB/m) + Cable Factor(dB) – Pre-Amplifier Factor(dB)
3. The other emission levels were very low against the limit.
4. Margin value = Emission Level – Limit value
5. " \* ": Fundamental frequency.
6. " # ": The radiated frequency is out of the restricted band.

<b>CHANNEL</b>	TX Channel 140	<b>DETECTOR FUNCTION</b>	Peak (PK)
<b>FREQUENCY RANGE</b>	1GHz ~ 40GHz		Average (AV)

**ANTENNA POLARITY & TEST DISTANCE: HORIZONTAL AT 3 M**

NO.	FREQ. (MHz)	EMISSION LEVEL (dBuV/m)	LIMIT (dBuV/m)	MARGIN (dB)	ANTENNA HEIGHT (m)	TABLE ANGLE (Degree)	RAW VALUE (dBuV)	CORRECTION FACTOR (dB/m)
1	*5700.00	114.5 PK			2.61 H	95	110.0	4.5
2	*5700.00	102.1 AV			2.61 H	95	97.6	4.5
3	#5725.00	68.0 PK	74.0	-6.0	2.61 H	95	63.6	4.4
4	#5725.00	53.6 AV	54.0	-0.4	2.61 H	95	49.2	4.4
5	11400.00	45.8 PK	74.0	-28.2	1.61 H	276	32.2	13.6
6	11400.00	33.2 AV	54.0	-20.8	1.61 H	276	19.6	13.6
7	#17100.00	45.7 PK	74.0	-28.3	1.93 H	197	28.3	17.4
8	#17100.00	32.9 AV	54.0	-21.1	1.93 H	197	15.5	17.4

**ANTENNA POLARITY & TEST DISTANCE: VERTICAL AT 3 M**

NO.	FREQ. (MHz)	EMISSION LEVEL (dBuV/m)	LIMIT (dBuV/m)	MARGIN (dB)	ANTENNA HEIGHT (m)	TABLE ANGLE (Degree)	RAW VALUE (dBuV)	CORRECTION FACTOR (dB/m)
1	*5700.00	101.1 PK			3.18 V	335	96.6	4.5
2	*5700.00	90.4 AV			3.18 V	335	85.9	4.5
3	#5725.00	57.0 PK	74.0	-17.0	3.18 V	335	52.6	4.4
4	#5725.00	42.1 AV	54.0	-11.9	3.18 V	335	37.7	4.4
5	11400.00	44.6 PK	74.0	-29.4	1.90 V	249	31.0	13.6
6	11400.00	31.9 AV	54.0	-22.1	1.90 V	249	18.3	13.6
7	#17100.00	45.0 PK	74.0	-29.0	1.66 V	222	27.6	17.4
8	#17100.00	32.5 AV	54.0	-21.5	1.66 V	222	15.1	17.4

**REMARKS:**

1. Emission Level(dBuV/m) = Raw Value(dBuV) + Correction Factor(dB/m)
2. Correction Factor(dB/m) = Antenna Factor(dB/m) + Cable Factor(dB) – Pre-Amplifier Factor(dB)
3. The other emission levels were very low against the limit.
4. Margin value = Emission Level – Limit value
5. " \* ": Fundamental frequency.
6. " # ": The radiated frequency is out of the restricted band.

<b>CHANNEL</b>	TX Channel 144	<b>DETECTOR FUNCTION</b>	Peak (PK)
<b>FREQUENCY RANGE</b>	1GHz ~ 40GHz		Average (AV)

**ANTENNA POLARITY & TEST DISTANCE: HORIZONTAL AT 3 M**

NO.	FREQ. (MHz)	EMISSION LEVEL (dBuV/m)	LIMIT (dBuV/m)	MARGIN (dB)	ANTENNA HEIGHT (m)	TABLE ANGLE (Degree)	RAW VALUE (dBuV)	CORRECTION FACTOR (dB/m)
1	#5470.00	48.4 PK	74.0	-25.6	2.60 H	95	44.2	4.2
2	#5470.00	36.7 AV	54.0	-17.3	2.60 H	95	32.5	4.2
3	*5720.00	115.2 PK			2.60 H	95	110.8	4.4
4	*5720.00	103.5 AV			2.60 H	95	99.1	4.4
5	#5850.00	48.1 PK	74.0	-25.9	2.60 H	95	43.6	4.5
6	#5850.00	36.3 AV	54.0	-17.7	2.60 H	95	31.8	4.5
7	11440.00	45.9 PK	74.0	-28.1	1.63 H	270	32.4	13.5
8	11440.00	33.2 AV	54.0	-20.8	1.63 H	270	19.7	13.5
9	#17160.00	45.0 PK	74.0	-29.0	1.83 H	215	27.7	17.3
10	#17160.00	32.3 AV	54.0	-21.7	1.83 H	215	15.0	17.3

**ANTENNA POLARITY & TEST DISTANCE: VERTICAL AT 3 M**

NO.	FREQ. (MHz)	EMISSION LEVEL (dBuV/m)	LIMIT (dBuV/m)	MARGIN (dB)	ANTENNA HEIGHT (m)	TABLE ANGLE (Degree)	RAW VALUE (dBuV)	CORRECTION FACTOR (dB/m)
1	#5470.00	45.3 PK	74.0	-28.7	3.23 V	329	41.1	4.2
2	#5470.00	33.6 AV	54.0	-20.4	3.23 V	329	29.4	4.2
3	*5720.00	101.6 PK			3.23 V	329	97.2	4.4
4	*5720.00	90.6 AV			3.23 V	329	86.2	4.4
5	#5850.00	45.1 PK	74.0	-28.9	3.23 V	329	40.6	4.5
6	#5850.00	33.1 AV	54.0	-20.9	3.23 V	329	28.6	4.5
7	11440.00	45.0 PK	74.0	-29.0	1.86 V	236	31.5	13.5
8	11440.00	32.2 AV	54.0	-21.8	1.86 V	236	18.7	13.5
9	#17160.00	45.5 PK	74.0	-28.5	1.58 V	218	28.2	17.3
10	#17160.00	32.6 AV	54.0	-21.4	1.58 V	218	15.3	17.3

**REMARKS:**

1. Emission Level(dBuV/m) = Raw Value(dBuV) + Correction Factor(dB/m)
2. Correction Factor(dB/m) = Antenna Factor(dB/m) + Cable Factor(dB) – Pre-Amplifier Factor(dB)
3. The other emission levels were very low against the limit.
4. Margin value = Emission Level – Limit value
5. " \* ": Fundamental frequency.
6. " # ": The radiated frequency is out of the restricted band.

**802.11ac (VHT20)**

<b>CHANNEL</b>	TX Channel 52	<b>DETECTOR FUNCTION</b>	Peak (PK)
<b>FREQUENCY RANGE</b>	1GHz ~ 40GHz		Average (AV)

**ANTENNA POLARITY & TEST DISTANCE: HORIZONTAL AT 3 M**

NO.	FREQ. (MHz)	EMISSION LEVEL (dBuV/m)	LIMIT (dBuV/m)	MARGIN (dB)	ANTENNA HEIGHT (m)	TABLE ANGLE (Degree)	RAW VALUE (dBuV)	CORRECTION FACTOR (dB/m)
1	5150.00	43.6 PK	74.0	-30.4	2.45 H	103	39.9	3.7
2	5150.00	32.8 AV	54.0	-21.2	2.45 H	103	29.1	3.7
3	*5260.00	114.5 PK			2.45 H	103	110.5	4.0
4	*5260.00	104.4 AV			2.45 H	103	100.4	4.0
5	5350.00	47.2 PK	74.0	-26.8	2.45 H	103	43.1	4.1
6	5350.00	36.1 AV	54.0	-17.9	2.45 H	103	32.0	4.1
7	#10520.00	45.9 PK	74.0	-28.1	1.55 H	251	32.7	13.2
8	#10520.00	33.2 AV	54.0	-20.8	1.55 H	251	20.0	13.2
9	15780.00	45.8 PK	74.0	-28.2	1.84 H	217	32.2	13.6
10	15780.00	33.3 AV	54.0	-20.7	1.84 H	217	19.7	13.6

**ANTENNA POLARITY & TEST DISTANCE: VERTICAL AT 3 M**

NO.	FREQ. (MHz)	EMISSION LEVEL (dBuV/m)	LIMIT (dBuV/m)	MARGIN (dB)	ANTENNA HEIGHT (m)	TABLE ANGLE (Degree)	RAW VALUE (dBuV)	CORRECTION FACTOR (dB/m)
1	5150.00	42.2 PK	74.0	-31.8	3.25 V	342	38.5	3.7
2	5150.00	31.6 AV	54.0	-22.4	3.25 V	342	27.9	3.7
3	*5260.00	101.2 PK			3.25 V	342	97.2	4.0
4	*5260.00	92.0 AV			3.25 V	342	88.0	4.0
5	5350.00	45.1 PK	74.0	-28.9	3.25 V	342	41.0	4.1
6	5350.00	34.0 AV	54.0	-20.0	3.25 V	342	29.9	4.1
7	#10520.00	45.7 PK	74.0	-28.3	1.85 V	239	32.5	13.2
8	#10520.00	32.4 AV	54.0	-21.6	1.85 V	239	19.2	13.2
9	15780.00	45.2 PK	74.0	-28.8	1.60 V	229	31.6	13.6
10	15780.00	32.2 AV	54.0	-21.8	1.60 V	229	18.6	13.6

**REMARKS:**

- Emission Level(dBuV/m) = Raw Value(dBuV) + Correction Factor(dB/m)
- Correction Factor(dB/m) = Antenna Factor(dB/m) + Cable Factor(dB) – Pre-Amplifier Factor(dB)
- The other emission levels were very low against the limit.
- Margin value = Emission Level – Limit value
- " \* ": Fundamental frequency.
- " # ": The radiated frequency is out of the restricted band.

<b>CHANNEL</b>	TX Channel 60	<b>DETECTOR FUNCTION</b>	Peak (PK)
<b>FREQUENCY RANGE</b>	1GHz ~ 40GHz		Average (AV)

**ANTENNA POLARITY & TEST DISTANCE: HORIZONTAL AT 3 M**

NO.	FREQ. (MHz)	EMISSION LEVEL (dBuV/m)	LIMIT (dBuV/m)	MARGIN (dB)	ANTENNA HEIGHT (m)	TABLE ANGLE (Degree)	RAW VALUE (dBuV)	CORRECTION FACTOR (dB/m)
1	5150.00	46.5 PK	74.0	-27.5	2.54 H	103	42.8	3.7
2	5150.00	35.0 AV	54.0	-19.0	2.54 H	103	31.3	3.7
3	*5300.00	113.8 PK			2.54 H	103	109.7	4.1
4	*5300.00	103.9 AV			2.54 H	103	99.8	4.1
5	5350.00	63.6 PK	74.0	-10.4	2.54 H	103	59.5	4.1
6	5350.00	48.4 AV	54.0	-5.6	2.54 H	103	44.3	4.1
7	10600.00	45.7 PK	74.0	-28.3	1.64 H	252	32.2	13.5
8	10600.00	33.4 AV	54.0	-20.6	1.64 H	252	19.9	13.5
9	15900.00	46.0 PK	74.0	-28.0	1.89 H	218	33.1	12.9
10	15900.00	33.3 AV	54.0	-20.7	1.89 H	218	20.4	12.9

**ANTENNA POLARITY & TEST DISTANCE: VERTICAL AT 3 M**

NO.	FREQ. (MHz)	EMISSION LEVEL (dBuV/m)	LIMIT (dBuV/m)	MARGIN (dB)	ANTENNA HEIGHT (m)	TABLE ANGLE (Degree)	RAW VALUE (dBuV)	CORRECTION FACTOR (dB/m)
1	5150.00	45.0 PK	74.0	-29.0	3.21 V	337	41.3	3.7
2	5150.00	33.6 AV	54.0	-20.4	3.21 V	337	29.9	3.7
3	*5300.00	100.2 PK			3.21 V	337	96.1	4.1
4	*5300.00	91.5 AV			3.21 V	337	87.4	4.1
5	5350.00	61.5 PK	74.0	-12.5	3.21 V	337	57.4	4.1
6	5350.00	46.3 AV	54.0	-7.7	3.21 V	337	42.2	4.1
7	10600.00	44.6 PK	74.0	-29.4	1.82 V	249	31.1	13.5
8	10600.00	31.9 AV	54.0	-22.1	1.82 V	249	18.4	13.5
9	15900.00	45.1 PK	74.0	-28.9	1.66 V	227	32.2	12.9
10	15900.00	32.2 AV	54.0	-21.8	1.66 V	227	19.3	12.9

**REMARKS:**

1. Emission Level(dBuV/m) = Raw Value(dBuV) + Correction Factor(dB/m)
2. Correction Factor(dB/m) = Antenna Factor(dB/m) + Cable Factor(dB) – Pre-Amplifier Factor(dB)
3. The other emission levels were very low against the limit.
4. Margin value = Emission Level – Limit value
5. " \* ": Fundamental frequency.



<b>CHANNEL</b>	TX Channel 64	<b>DETECTOR FUNCTION</b>	Peak (PK)
<b>FREQUENCY RANGE</b>	1GHz ~ 40GHz		Average (AV)

**ANTENNA POLARITY & TEST DISTANCE: HORIZONTAL AT 3 M**

NO.	FREQ. (MHz)	EMISSION LEVEL (dBuV/m)	LIMIT (dBuV/m)	MARGIN (dB)	ANTENNA HEIGHT (m)	TABLE ANGLE (Degree)	RAW VALUE (dBuV)	CORRECTION FACTOR (dB/m)
1	*5320.00	116.5 PK			2.56 H	102	112.4	4.1
2	*5320.00	105.3 AV			2.56 H	102	101.2	4.1
3	5350.00	67.6 PK	74.0	-6.4	2.56 H	102	63.5	4.1
4	<b>5350.00</b>	<b>53.9 AV</b>	<b>54.0</b>	<b>-0.1</b>	<b>2.56 H</b>	<b>102</b>	<b>49.8</b>	<b>4.1</b>
5	10640.00	45.4 PK	74.0	-28.6	1.62 H	274	31.9	13.5
6	10640.00	33.1 AV	54.0	-20.9	1.62 H	274	19.6	13.5
7	15960.00	45.0 PK	74.0	-29.0	1.88 H	206	32.1	12.9
8	15960.00	32.4 AV	54.0	-21.6	1.88 H	206	19.5	12.9

**ANTENNA POLARITY & TEST DISTANCE: VERTICAL AT 3 M**

NO.	FREQ. (MHz)	EMISSION LEVEL (dBuV/m)	LIMIT (dBuV/m)	MARGIN (dB)	ANTENNA HEIGHT (m)	TABLE ANGLE (Degree)	RAW VALUE (dBuV)	CORRECTION FACTOR (dB/m)
1	*5320.00	104.3 PK			3.27 V	346	100.2	4.1
2	*5320.00	93.9 AV			3.27 V	346	89.8	4.1
3	5350.00	55.7 PK	74.0	-18.3	3.27 V	346	51.6	4.1
4	5350.00	42.0 AV	54.0	-12.0	3.27 V	346	37.9	4.1
5	10640.00	45.7 PK	74.0	-28.3	1.84 V	246	32.2	13.5
6	10640.00	32.4 AV	54.0	-21.6	1.84 V	246	18.9	13.5
7	15960.00	45.2 PK	74.0	-28.8	1.55 V	237	32.3	12.9
8	15960.00	32.5 AV	54.0	-21.5	1.55 V	237	19.6	12.9

**REMARKS:**

1. Emission Level(dBuV/m) = Raw Value(dBuV) + Correction Factor(dB/m)
2. Correction Factor(dB/m) = Antenna Factor(dB/m) + Cable Factor(dB) – Pre-Amplifier Factor(dB)
3. The other emission levels were very low against the limit.
4. Margin value = Emission Level – Limit value
5. " \* ": Fundamental frequency.

<b>CHANNEL</b>	TX Channel 100	<b>DETECTOR FUNCTION</b>	Peak (PK)
<b>FREQUENCY RANGE</b>	1GHz ~ 40GHz		Average (AV)

**ANTENNA POLARITY & TEST DISTANCE: HORIZONTAL AT 3 M**

NO.	FREQ. (MHz)	EMISSION LEVEL (dBuV/m)	LIMIT (dBuV/m)	MARGIN (dB)	ANTENNA HEIGHT (m)	TABLE ANGLE (Degree)	RAW VALUE (dBuV)	CORRECTION FACTOR (dB/m)
1	#5470.00	68.3 PK	74.0	-5.7	2.52 H	101	64.1	4.2
2	#5470.00	53.6 AV	54.0	-0.4	2.52 H	101	49.4	4.2
3	*5500.00	115.0 PK			2.53 H	101	110.8	4.2
4	*5500.00	104.2 AV			2.53 H	101	100.0	4.2
5	11000.00	45.3 PK	74.0	-28.7	1.61 H	248	31.2	14.1
6	11000.00	33.0 AV	54.0	-21.0	1.61 H	248	18.9	14.1
7	#16500.00	45.2 PK	74.0	-28.8	1.90 H	216	30.7	14.5
8	#16500.00	32.6 AV	54.0	-21.4	1.90 H	216	18.1	14.5

**ANTENNA POLARITY & TEST DISTANCE: VERTICAL AT 3 M**

NO.	FREQ. (MHz)	EMISSION LEVEL (dBuV/m)	LIMIT (dBuV/m)	MARGIN (dB)	ANTENNA HEIGHT (m)	TABLE ANGLE (Degree)	RAW VALUE (dBuV)	CORRECTION FACTOR (dB/m)
1	#5470.00	58.3 PK	74.0	-15.7	3.31 V	354	54.1	4.2
2	#5470.00	44.5 AV	54.0	-9.5	3.31 V	354	40.3	4.2
3	*5500.00	103.7 PK			3.31 V	354	99.5	4.2
4	*5500.00	92.8 AV			3.31 V	354	88.6	4.2
5	11000.00	45.8 PK	74.0	-28.2	1.86 V	246	31.7	14.1
6	11000.00	32.7 AV	54.0	-21.3	1.86 V	246	18.6	14.1
7	#16500.00	45.6 PK	74.0	-28.4	1.63 V	214	31.1	14.5
8	#16500.00	32.6 AV	54.0	-21.4	1.63 V	214	18.1	14.5

**REMARKS:**

1. Emission Level(dBuV/m) = Raw Value(dBuV) + Correction Factor(dB/m)
2. Correction Factor(dB/m) = Antenna Factor(dB/m) + Cable Factor(dB) – Pre-Amplifier Factor(dB)
3. The other emission levels were very low against the limit.
4. Margin value = Emission Level – Limit value
5. " \* ": Fundamental frequency.
6. " # ": The radiated frequency is out of the restricted band.

<b>CHANNEL</b>	TX Channel 116	<b>DETECTOR FUNCTION</b>	Peak (PK)
<b>FREQUENCY RANGE</b>	1GHz ~ 40GHz		Average (AV)

**ANTENNA POLARITY & TEST DISTANCE: HORIZONTAL AT 3 M**

NO.	FREQ. (MHz)	EMISSION LEVEL (dBuV/m)	LIMIT (dBuV/m)	MARGIN (dB)	ANTENNA HEIGHT (m)	TABLE ANGLE (Degree)	RAW VALUE (dBuV)	CORRECTION FACTOR (dB/m)
1	#5470.00	48.6 PK	74.0	-25.4	2.53 H	100	44.4	4.2
2	#5470.00	36.1 AV	54.0	-17.9	2.53 H	100	31.9	4.2
3	*5580.00	115.1 PK			2.53 H	100	110.9	4.2
4	*5580.00	104.1 AV			2.53 H	100	99.9	4.2
5	#5725.00	48.2 PK	74.0	-25.8	2.53 H	100	43.8	4.4
6	#5725.00	35.8 AV	54.0	-18.2	2.53 H	100	31.4	4.4
7	11160.00	45.9 PK	74.0	-28.1	1.58 H	258	32.2	13.7
8	11160.00	33.3 AV	54.0	-20.7	1.58 H	258	19.6	13.7
9	#16740.00	45.5 PK	74.0	-28.5	1.92 H	214	29.8	15.7
10	#16740.00	33.1 AV	54.0	-20.9	1.92 H	214	17.4	15.7

**ANTENNA POLARITY & TEST DISTANCE: VERTICAL AT 3 M**

NO.	FREQ. (MHz)	EMISSION LEVEL (dBuV/m)	LIMIT (dBuV/m)	MARGIN (dB)	ANTENNA HEIGHT (m)	TABLE ANGLE (Degree)	RAW VALUE (dBuV)	CORRECTION FACTOR (dB/m)
1	#5470.00	35.4 PK	74.0	-38.6	3.31 V	342	31.2	4.2
2	#5470.00	33.0 AV	54.0	-21.0	3.31 V	342	28.8	4.2
3	*5580.00	102.8 PK			3.31 V	342	98.6	4.2
4	*5580.00	91.8 AV			3.31 V	342	87.6	4.2
5	#5725.00	34.9 PK	74.0	-39.1	3.31 V	342	30.5	4.4
6	#5725.00	33.4 AV	54.0	-20.6	3.31 V	342	29.0	4.4
7	11160.00	45.2 PK	74.0	-28.8	1.82 V	242	31.5	13.7
8	11160.00	32.0 AV	54.0	-22.0	1.82 V	242	18.3	13.7
9	#16740.00	45.0 PK	74.0	-29.0	1.61 V	242	29.3	15.7
10	#16740.00	32.2 AV	54.0	-21.8	1.61 V	242	16.5	15.7

**REMARKS:**

1. Emission Level(dBuV/m) = Raw Value(dBuV) + Correction Factor(dB/m)
2. Correction Factor(dB/m) = Antenna Factor(dB/m) + Cable Factor(dB) – Pre-Amplifier Factor(dB)
3. The other emission levels were very low against the limit.
4. Margin value = Emission Level – Limit value
5. " \* ": Fundamental frequency.
6. " # ": The radiated frequency is out of the restricted band.

<b>CHANNEL</b>	TX Channel 140	<b>DETECTOR FUNCTION</b>	Peak (PK)
<b>FREQUENCY RANGE</b>	1GHz ~ 40GHz		Average (AV)

**ANTENNA POLARITY & TEST DISTANCE: HORIZONTAL AT 3 M**

NO.	FREQ. (MHz)	EMISSION LEVEL (dBuV/m)	LIMIT (dBuV/m)	MARGIN (dB)	ANTENNA HEIGHT (m)	TABLE ANGLE (Degree)	RAW VALUE (dBuV)	CORRECTION FACTOR (dB/m)
1	*5700.00	112.0 PK			2.52 H	94	107.5	4.5
2	*5700.00	100.7 AV			2.52 H	94	96.2	4.5
3	#5725.00	67.9 PK	74.0	-6.1	2.52 H	94	63.5	4.4
4	#5725.00	53.6 AV	54.0	-0.4	2.52 H	94	49.2	4.4
5	11400.00	45.4 PK	74.0	-28.6	1.59 H	276	31.8	13.6
6	11400.00	32.9 AV	54.0	-21.1	1.59 H	276	19.3	13.6
7	#17100.00	45.6 PK	74.0	-28.4	1.91 H	208	28.2	17.4
8	#17100.00	32.9 AV	54.0	-21.1	1.91 H	208	15.5	17.4

**ANTENNA POLARITY & TEST DISTANCE: VERTICAL AT 3 M**

NO.	FREQ. (MHz)	EMISSION LEVEL (dBuV/m)	LIMIT (dBuV/m)	MARGIN (dB)	ANTENNA HEIGHT (m)	TABLE ANGLE (Degree)	RAW VALUE (dBuV)	CORRECTION FACTOR (dB/m)
1	*5700.00	98.6 PK			3.29 V	328	94.1	4.5
2	*5700.00	88.3 AV			3.29 V	328	83.8	4.5
3	#5725.00	57.9 PK	74.0	-16.1	3.29 V	328	53.5	4.4
4	#5725.00	43.6 AV	54.0	-10.4	3.29 V	328	39.2	4.4
5	11400.00	45.2 PK	74.0	-28.8	1.88 V	241	31.6	13.6
6	11400.00	32.3 AV	54.0	-21.7	1.88 V	241	18.7	13.6
7	#17100.00	45.7 PK	74.0	-28.3	1.62 V	235	28.3	17.4
8	#17100.00	32.8 AV	54.0	-21.2	1.62 V	235	15.4	17.4

**REMARKS:**

1. Emission Level(dBuV/m) = Raw Value(dBuV) + Correction Factor(dB/m)
2. Correction Factor(dB/m) = Antenna Factor(dB/m) + Cable Factor(dB) – Pre-Amplifier Factor(dB)
3. The other emission levels were very low against the limit.
4. Margin value = Emission Level – Limit value
5. " \* ": Fundamental frequency.
6. " # ": The radiated frequency is out of the restricted band.

<b>CHANNEL</b>	TX Channel 144	<b>DETECTOR FUNCTION</b>	Peak (PK)
<b>FREQUENCY RANGE</b>	1GHz ~ 40GHz		Average (AV)

**ANTENNA POLARITY & TEST DISTANCE: HORIZONTAL AT 3 M**

NO.	FREQ. (MHz)	EMISSION LEVEL (dBuV/m)	LIMIT (dBuV/m)	MARGIN (dB)	ANTENNA HEIGHT (m)	TABLE ANGLE (Degree)	RAW VALUE (dBuV)	CORRECTION FACTOR (dB/m)
1	#5470.00	47.9 PK	74.0	-26.1	2.49 H	96	43.7	4.2
2	#5470.00	34.9 AV	54.0	-19.1	2.49 H	96	30.7	4.2
3	*5720.00	114.3 PK			2.49 H	96	109.9	4.4
4	*5720.00	103.4 AV			2.49 H	96	99.0	4.4
5	#5850.00	48.0 PK	74.0	-26.0	2.49 H	96	43.5	4.5
6	#5850.00	36.6 AV	54.0	-17.4	2.49 H	96	32.1	4.5
7	11440.00	45.2 PK	74.0	-28.8	1.67 H	265	31.7	13.5
8	11440.00	32.7 AV	54.0	-21.3	1.67 H	265	19.2	13.5
9	#17160.00	45.8 PK	74.0	-28.2	1.84 H	215	28.5	17.3
10	#17160.00	33.0 AV	54.0	-21.0	1.84 H	215	15.7	17.3

**ANTENNA POLARITY & TEST DISTANCE: VERTICAL AT 3 M**

NO.	FREQ. (MHz)	EMISSION LEVEL (dBuV/m)	LIMIT (dBuV/m)	MARGIN (dB)	ANTENNA HEIGHT (m)	TABLE ANGLE (Degree)	RAW VALUE (dBuV)	CORRECTION FACTOR (dB/m)
1	#5470.00	44.7 PK	74.0	-29.3	3.32 V	313	40.5	4.2
2	#5470.00	31.7 AV	54.0	-22.3	3.32 V	313	27.5	4.2
3	*5720.00	100.9 PK			3.32 V	313	96.5	4.4
4	*5720.00	90.6 AV			3.32 V	313	86.2	4.4
5	#5850.00	45.1 PK	74.0	-28.9	3.32 V	313	40.6	4.5
6	#5850.00	33.5 AV	54.0	-20.5	3.32 V	313	29.0	4.5
7	11440.00	45.1 PK	74.0	-28.9	1.94 V	234	31.6	13.5
8	11440.00	32.0 AV	54.0	-22.0	1.94 V	234	18.5	13.5
9	#17160.00	45.1 PK	74.0	-28.9	1.65 V	237	27.8	17.3
10	#17160.00	32.3 AV	54.0	-21.7	1.65 V	237	15.0	17.3

**REMARKS:**

1. Emission Level(dBuV/m) = Raw Value(dBuV) + Correction Factor(dB/m)
2. Correction Factor(dB/m) = Antenna Factor(dB/m) + Cable Factor(dB) – Pre-Amplifier Factor(dB)
3. The other emission levels were very low against the limit.
4. Margin value = Emission Level – Limit value
5. " \* ": Fundamental frequency.
6. " # ": The radiated frequency is out of the restricted band.

**802.11ac (VHT40)**

<b>CHANNEL</b>	TX Channel 54	<b>DETECTOR FUNCTION</b>	Peak (PK)
<b>FREQUENCY RANGE</b>	1GHz ~ 40GHz		Average (AV)

**ANTENNA POLARITY & TEST DISTANCE: HORIZONTAL AT 3 M**

NO.	FREQ. (MHz)	EMISSION LEVEL (dBuV/m)	LIMIT (dBuV/m)	MARGIN (dB)	ANTENNA HEIGHT (m)	TABLE ANGLE (Degree)	RAW VALUE (dBuV)	CORRECTION FACTOR (dB/m)
1	5150.00	56.5 PK	74.0	-17.5	2.77 H	100	52.8	3.7
2	5150.00	42.6 AV	54.0	-11.4	2.77 H	100	38.9	3.7
3	*5270.00	114.3 PK			2.77 H	100	110.3	4.0
4	*5270.00	103.4 AV			2.77 H	100	99.4	4.0
5	5350.00	60.1 PK	74.0	-13.9	2.77 H	100	56.0	4.1
6	5350.00	46.7 AV	54.0	-7.3	2.77 H	100	42.6	4.1
7	#10540.00	45.5 PK	74.0	-28.5	1.66 H	257	32.2	13.3
8	#10540.00	33.0 AV	54.0	-21.0	1.66 H	257	19.7	13.3
9	15810.00	46.0 PK	74.0	-28.0	1.91 H	195	32.6	13.4
10	15810.00	33.2 AV	54.0	-20.8	1.91 H	195	19.8	13.4

**ANTENNA POLARITY & TEST DISTANCE: VERTICAL AT 3 M**

NO.	FREQ. (MHz)	EMISSION LEVEL (dBuV/m)	LIMIT (dBuV/m)	MARGIN (dB)	ANTENNA HEIGHT (m)	TABLE ANGLE (Degree)	RAW VALUE (dBuV)	CORRECTION FACTOR (dB/m)
1	5150.00	53.3 PK	74.0	-20.7	3.33 V	314	49.6	3.7
2	5150.00	39.2 AV	54.0	-14.8	3.33 V	314	35.5	3.7
3	*5270.00	101.9 PK			3.33 V	314	97.9	4.0
4	*5270.00	90.8 AV			3.33 V	314	86.8	4.0
5	5350.00	57.0 PK	74.0	-17.0	3.33 V	314	52.9	4.1
6	5350.00	43.6 AV	54.0	-10.4	3.33 V	314	39.5	4.1
7	#10540.00	45.7 PK	74.0	-28.3	1.93 V	255	32.4	13.3
8	#10540.00	32.4 AV	54.0	-21.6	1.93 V	255	19.1	13.3
9	15810.00	45.1 PK	74.0	-28.9	1.56 V	228	31.7	13.4
10	15810.00	32.1 AV	54.0	-21.9	1.56 V	228	18.7	13.4

**REMARKS:**

1. Emission Level(dBuV/m) = Raw Value(dBuV) + Correction Factor(dB/m)
2. Correction Factor(dB/m) = Antenna Factor(dB/m) + Cable Factor(dB) – Pre-Amplifier Factor(dB)
3. The other emission levels were very low against the limit.
4. Margin value = Emission Level – Limit value
5. " \* ": Fundamental frequency.
6. " # ": The radiated frequency is out of the restricted band.

<b>CHANNEL</b>	TX Channel 62	<b>DETECTOR FUNCTION</b>	Peak (PK)
<b>FREQUENCY RANGE</b>	1GHz ~ 40GHz		Average (AV)

**ANTENNA POLARITY & TEST DISTANCE: HORIZONTAL AT 3 M**

NO.	FREQ. (MHz)	EMISSION LEVEL (dBuV/m)	LIMIT (dBuV/m)	MARGIN (dB)	ANTENNA HEIGHT (m)	TABLE ANGLE (Degree)	RAW VALUE (dBuV)	CORRECTION FACTOR (dB/m)
1	*5310.00	108.6 PK			2.72 H	102	104.5	4.1
2	*5310.00	97.2 AV			2.72 H	102	93.1	4.1
3	5350.00	69.1 PK	74.0	-4.9	2.72 H	102	65.0	4.1
4	<b>5350.00</b>	<b>53.9 AV</b>	<b>54.0</b>	<b>-0.1</b>	<b>2.72 H</b>	<b>102</b>	<b>49.8</b>	<b>4.1</b>
5	10620.00	46.3 PK	74.0	-27.7	1.65 H	250	32.8	13.5
6	10620.00	33.7 AV	54.0	-20.3	1.65 H	250	20.2	13.5
7	15930.00	45.2 PK	74.0	-28.8	1.86 H	198	32.4	12.8
8	15930.00	32.6 AV	54.0	-21.4	1.86 H	198	19.8	12.8

**ANTENNA POLARITY & TEST DISTANCE: VERTICAL AT 3 M**

NO.	FREQ. (MHz)	EMISSION LEVEL (dBuV/m)	LIMIT (dBuV/m)	MARGIN (dB)	ANTENNA HEIGHT (m)	TABLE ANGLE (Degree)	RAW VALUE (dBuV)	CORRECTION FACTOR (dB/m)
1	*5310.00	95.0 PK			3.38 V	315	90.9	4.1
2	*5310.00	84.8 AV			3.38 V	315	80.7	4.1
3	5350.00	57.7 PK	74.0	-16.3	3.38 V	315	53.6	4.1
4	5350.00	42.5 AV	54.0	-11.5	3.38 V	315	38.4	4.1
5	10620.00	45.1 PK	74.0	-28.9	1.87 V	247	31.6	13.5
6	10620.00	32.0 AV	54.0	-22.0	1.87 V	247	18.5	13.5
7	15930.00	45.1 PK	74.0	-28.9	1.62 V	241	32.3	12.8
8	15930.00	32.3 AV	54.0	-21.7	1.62 V	241	19.5	12.8

**REMARKS:**

1. Emission Level(dBuV/m) = Raw Value(dBuV) + Correction Factor(dB/m)
2. Correction Factor(dB/m) = Antenna Factor(dB/m) + Cable Factor(dB) – Pre-Amplifier Factor(dB)
3. The other emission levels were very low against the limit.
4. Margin value = Emission Level – Limit value
5. " \* ": Fundamental frequency.

<b>CHANNEL</b>	TX Channel 102	<b>DETECTOR FUNCTION</b>	Peak (PK)
<b>FREQUENCY RANGE</b>	1GHz ~ 40GHz		Average (AV)

**ANTENNA POLARITY & TEST DISTANCE: HORIZONTAL AT 3 M**

NO.	FREQ. (MHz)	EMISSION LEVEL (dBuV/m)	LIMIT (dBuV/m)	MARGIN (dB)	ANTENNA HEIGHT (m)	TABLE ANGLE (Degree)	RAW VALUE (dBuV)	CORRECTION FACTOR (dB/m)
1	#5470.00	69.4 PK	74.0	-4.6	2.56 H	101	65.2	4.2
2	#5470.00	53.9 AV	54.0	-0.1	2.56 H	101	49.7	4.2
3	*5510.00	108.1 PK			2.56 H	101	103.9	4.2
4	*5510.00	96.6 AV			2.56 H	101	92.4	4.2
5	11020.00	46.0 PK	74.0	-28.0	1.66 H	252	32.0	14.0
6	11020.00	33.3 AV	54.0	-20.7	1.66 H	252	19.3	14.0
7	#16530.00	45.7 PK	74.0	-28.3	1.81 H	196	30.8	14.9
8	#16530.00	32.8 AV	54.0	-21.2	1.81 H	196	17.9	14.9

**ANTENNA POLARITY & TEST DISTANCE: VERTICAL AT 3 M**

NO.	FREQ. (MHz)	EMISSION LEVEL (dBuV/m)	LIMIT (dBuV/m)	MARGIN (dB)	ANTENNA HEIGHT (m)	TABLE ANGLE (Degree)	RAW VALUE (dBuV)	CORRECTION FACTOR (dB/m)
1	#5470.00	58.0 PK	74.0	-16.0	3.30 V	314	53.8	4.2
2	#5470.00	42.3 AV	54.0	-11.7	3.30 V	314	38.1	4.2
3	*5510.00	94.5 PK			3.30 V	314	90.3	4.2
4	*5510.00	83.9 AV			3.30 V	314	79.7	4.2
5	11020.00	45.5 PK	74.0	-28.5	1.88 V	227	31.5	14.0
6	11020.00	32.3 AV	54.0	-21.7	1.88 V	227	18.3	14.0
7	#16530.00	45.7 PK	74.0	-28.3	1.62 V	215	30.8	14.9
8	#16530.00	32.9 AV	54.0	-21.1	1.62 V	215	18.0	14.9

**REMARKS:**

1. Emission Level(dBuV/m) = Raw Value(dBuV) + Correction Factor(dB/m)
2. Correction Factor(dB/m) = Antenna Factor(dB/m) + Cable Factor(dB) – Pre-Amplifier Factor(dB)
3. The other emission levels were very low against the limit.
4. Margin value = Emission Level – Limit value
5. " \* ": Fundamental frequency.
6. " # ": The radiated frequency is out of the restricted band.



<b>CHANNEL</b>	TX Channel 110	<b>DETECTOR FUNCTION</b>	Peak (PK)
<b>FREQUENCY RANGE</b>	1GHz ~ 40GHz		Average (AV)

**ANTENNA POLARITY & TEST DISTANCE: HORIZONTAL AT 3 M**

NO.	FREQ. (MHz)	EMISSION LEVEL (dBuV/m)	LIMIT (dBuV/m)	MARGIN (dB)	ANTENNA HEIGHT (m)	TABLE ANGLE (Degree)	RAW VALUE (dBuV)	CORRECTION FACTOR (dB/m)
1	#5470.00	67.2 PK	74.0	-6.8	2.53 H	98	63.0	4.2
2	#5470.00	53.1 AV	54.0	-0.9	2.53 H	98	48.9	4.2
3	*5550.00	115.8 PK			2.53 H	98	111.6	4.2
4	*5550.00	104.6 AV			2.53 H	98	100.4	4.2
5	#5725.00	49.5 PK	74.0	-24.5	2.53 H	98	45.1	4.4
6	#5725.00	36.6 AV	54.0	-17.4	2.53 H	98	32.2	4.4
7	11100.00	45.4 PK	74.0	-28.6	1.58 H	247	31.6	13.8
8	11100.00	33.2 AV	54.0	-20.8	1.58 H	247	19.4	13.8
9	#16650.00	45.0 PK	74.0	-29.0	1.92 H	200	29.4	15.6
10	#16650.00	32.5 AV	54.0	-21.5	1.92 H	200	16.9	15.6

**ANTENNA POLARITY & TEST DISTANCE: VERTICAL AT 3 M**

NO.	FREQ. (MHz)	EMISSION LEVEL (dBuV/m)	LIMIT (dBuV/m)	MARGIN (dB)	ANTENNA HEIGHT (m)	TABLE ANGLE (Degree)	RAW VALUE (dBuV)	CORRECTION FACTOR (dB/m)
1	#5470.00	55.6 PK	74.0	-18.4	3.32 V	307	51.4	4.2
2	#5470.00	41.7 AV	54.0	-12.3	3.32 V	307	37.5	4.2
3	*5550.00	102.3 PK			3.32 V	307	98.1	4.2
4	*5550.00	91.8 AV			3.32 V	307	87.6	4.2
5	#5725.00	46.4 PK	74.0	-27.6	3.32 V	307	42.0	4.4
6	#5725.00	33.5 AV	54.0	-20.5	3.32 V	307	29.1	4.4
7	11100.00	45.5 PK	74.0	-28.5	1.84 V	242	31.7	13.8
8	11100.00	32.2 AV	54.0	-21.8	1.84 V	242	18.4	13.8
9	#16650.00	45.5 PK	74.0	-28.5	1.61 V	241	29.9	15.6
10	#16650.00	32.7 AV	54.0	-21.3	1.61 V	241	17.1	15.6

**REMARKS:**

1. Emission Level(dBuV/m) = Raw Value(dBuV) + Correction Factor(dB/m)
2. Correction Factor(dB/m) = Antenna Factor(dB/m) + Cable Factor(dB) – Pre-Amplifier Factor(dB)
3. The other emission levels were very low against the limit.
4. Margin value = Emission Level – Limit value
5. " \* ": Fundamental frequency.
6. " # ": The radiated frequency is out of the restricted band.

<b>CHANNEL</b>	TX Channel 134	<b>DETECTOR FUNCTION</b>	Peak (PK)
<b>FREQUENCY RANGE</b>	1GHz ~ 40GHz		Average (AV)

**ANTENNA POLARITY & TEST DISTANCE: HORIZONTAL AT 3 M**

NO.	FREQ. (MHz)	EMISSION LEVEL (dBuV/m)	LIMIT (dBuV/m)	MARGIN (dB)	ANTENNA HEIGHT (m)	TABLE ANGLE (Degree)	RAW VALUE (dBuV)	CORRECTION FACTOR (dB/m)
1	*5670.00	112.3 PK			2.62 H	93	108.0	4.3
2	*5670.00	101.2 AV			2.62 H	93	96.9	4.3
3	#5725.00	68.3 PK	74.0	-5.7	2.62 H	93	63.9	4.4
4	#5725.00	53.7 AV	54.0	-0.3	2.62 H	93	49.3	4.4
5	11340.00	45.8 PK	74.0	-28.2	1.66 H	257	32.2	13.6
6	11340.00	33.4 AV	54.0	-20.6	1.66 H	257	19.8	13.6
7	#17010.00	45.2 PK	74.0	-28.8	1.85 H	196	28.1	17.1
8	#17010.00	32.4 AV	54.0	-21.6	1.85 H	196	15.3	17.1

**ANTENNA POLARITY & TEST DISTANCE: VERTICAL AT 3 M**

NO.	FREQ. (MHz)	EMISSION LEVEL (dBuV/m)	LIMIT (dBuV/m)	MARGIN (dB)	ANTENNA HEIGHT (m)	TABLE ANGLE (Degree)	RAW VALUE (dBuV)	CORRECTION FACTOR (dB/m)
1	*5670.00	98.9 PK			3.27 V	303	94.6	4.3
2	*5670.00	88.6 AV			3.27 V	303	84.3	4.3
3	#5725.00	56.9 PK	74.0	-17.1	3.27 V	303	52.5	4.4
4	#5725.00	42.3 AV	54.0	-11.7	3.27 V	303	37.9	4.4
5	11340.00	45.5 PK	74.0	-28.5	1.90 V	255	31.9	13.6
6	11340.00	32.2 AV	54.0	-21.8	1.90 V	255	18.6	13.6
7	#17010.00	45.5 PK	74.0	-28.5	1.65 V	230	28.4	17.1
8	#17010.00	32.6 AV	54.0	-21.4	1.65 V	230	15.5	17.1

**REMARKS:**

1. Emission Level(dBuV/m) = Raw Value(dBuV) + Correction Factor(dB/m)
2. Correction Factor(dB/m) = Antenna Factor(dB/m) + Cable Factor(dB) – Pre-Amplifier Factor(dB)
3. The other emission levels were very low against the limit.
4. Margin value = Emission Level – Limit value
5. " \* ": Fundamental frequency.
6. " # ": The radiated frequency is out of the restricted band.

<b>CHANNEL</b>	TX Channel 142	<b>DETECTOR FUNCTION</b>	Peak (PK)
<b>FREQUENCY RANGE</b>	1GHz ~ 40GHz		Average (AV)

**ANTENNA POLARITY & TEST DISTANCE: HORIZONTAL AT 3 M**

NO.	FREQ. (MHz)	EMISSION LEVEL (dBuV/m)	LIMIT (dBuV/m)	MARGIN (dB)	ANTENNA HEIGHT (m)	TABLE ANGLE (Degree)	RAW VALUE (dBuV)	CORRECTION FACTOR (dB/m)
1	#5470.00	49.3 PK	74.0	-24.7	2.58 H	94	45.1	4.2
2	#5470.00	35.9 AV	54.0	-18.1	2.58 H	94	31.7	4.2
3	*5710.00	116.2 PK			2.58 H	94	111.7	4.5
4	*5710.00	104.8 AV			2.58 H	94	100.3	4.5
5	#5850.00	53.3 PK	74.0	-20.7	2.58 H	94	48.8	4.5
6	#5850.00	42.1 AV	54.0	-11.9	2.58 H	94	37.6	4.5
7	11420.00	46.0 PK	74.0	-28.0	1.64 H	268	32.4	13.6
8	11420.00	33.4 AV	54.0	-20.6	1.64 H	268	19.8	13.6
9	#17130.00	45.5 PK	74.0	-28.5	1.90 H	214	28.1	17.4
10	#17130.00	32.9 AV	54.0	-21.1	1.90 H	214	15.5	17.4

**ANTENNA POLARITY & TEST DISTANCE: VERTICAL AT 3 M**

NO.	FREQ. (MHz)	EMISSION LEVEL (dBuV/m)	LIMIT (dBuV/m)	MARGIN (dB)	ANTENNA HEIGHT (m)	TABLE ANGLE (Degree)	RAW VALUE (dBuV)	CORRECTION FACTOR (dB/m)
1	#5470.00	48.1 PK	74.0	-25.9	3.31 V	307	43.9	4.2
2	#5470.00	34.8 AV	54.0	-19.2	3.31 V	307	30.6	4.2
3	*5710.00	101.8 PK			3.31 V	307	97.3	4.5
4	*5710.00	91.2 AV			3.31 V	307	86.7	4.5
5	#5850.00	50.2 PK	74.0	-23.8	3.31 V	307	45.7	4.5
6	#5850.00	39.0 AV	54.0	-15.0	3.31 V	307	34.5	4.5
7	11420.00	45.4 PK	74.0	-28.6	1.88 V	242	31.8	13.6
8	11420.00	32.7 AV	54.0	-21.3	1.88 V	242	19.1	13.6
9	#17130.00	45.0 PK	74.0	-29.0	1.58 V	236	27.6	17.4
10	#17130.00	32.2 AV	54.0	-21.8	1.58 V	236	14.8	17.4

**REMARKS:**

1. Emission Level(dBuV/m) = Raw Value(dBuV) + Correction Factor(dB/m)
2. Correction Factor(dB/m) = Antenna Factor(dB/m) + Cable Factor(dB) – Pre-Amplifier Factor(dB)
3. The other emission levels were very low against the limit.
4. Margin value = Emission Level – Limit value
5. " \* ": Fundamental frequency.
6. " # ": The radiated frequency is out of the restricted band.

802.11ac (VHT80)

<b>CHANNEL</b>	TX Channel 58	<b>DETECTOR FUNCTION</b>	Peak (PK)
<b>FREQUENCY RANGE</b>	1GHz ~ 40GHz		Average (AV)

**ANTENNA POLARITY & TEST DISTANCE: HORIZONTAL AT 3 M**

NO.	FREQ. (MHz)	EMISSION LEVEL (dBuV/m)	LIMIT (dBuV/m)	MARGIN (dB)	ANTENNA HEIGHT (m)	TABLE ANGLE (Degree)	RAW VALUE (dBuV)	CORRECTION FACTOR (dB/m)
1	5150.00	50.6 PK	74.0	-23.4	2.78 H	103	46.9	3.7
2	5150.00	39.4 AV	54.0	-14.6	2.78 H	103	35.7	3.7
3	*5290.00	104.1 PK			2.78 H	103	100.0	4.1
4	*5290.00	93.7 AV			2.78 H	103	89.6	4.1
5	5350.00	68.0 PK	74.0	-6.0	2.78 H	103	63.9	4.1
6	5350.00	53.8 AV	54.0	-0.2	2.78 H	103	49.7	4.1
7	#10580.00	46.0 PK	74.0	-28.0	1.57 H	250	32.6	13.4
8	#10580.00	33.3 AV	54.0	-20.7	1.57 H	250	19.9	13.4
9	15870.00	46.0 PK	74.0	-28.0	1.92 H	224	33.0	13.0
10	15870.00	33.2 AV	54.0	-20.8	1.92 H	224	20.2	13.0

**ANTENNA POLARITY & TEST DISTANCE: VERTICAL AT 3 M**

NO.	FREQ. (MHz)	EMISSION LEVEL (dBuV/m)	LIMIT (dBuV/m)	MARGIN (dB)	ANTENNA HEIGHT (m)	TABLE ANGLE (Degree)	RAW VALUE (dBuV)	CORRECTION FACTOR (dB/m)
1	5150.00	47.5 PK	74.0	-26.5	3.32 V	294	43.8	3.7
2	5150.00	37.3 AV	54.0	-16.7	3.32 V	294	33.6	3.7
3	*5290.00	91.2 PK			3.32 V	294	87.1	4.1
4	*5290.00	81.1 AV			3.32 V	294	77.0	4.1
5	5350.00	57.9 PK	74.0	-16.1	3.32 V	294	53.8	4.1
6	5350.00	43.0 AV	54.0	-11.0	3.32 V	294	38.9	4.1
7	#10580.00	45.3 PK	74.0	-28.7	1.86 V	249	31.9	13.4
8	#10580.00	32.0 AV	54.0	-22.0	1.86 V	249	18.6	13.4
9	15870.00	45.9 PK	74.0	-28.1	1.56 V	232	32.9	13.0
10	15870.00	32.9 AV	54.0	-21.1	1.56 V	232	19.9	13.0

**REMARKS:**

1. Emission Level(dBuV/m) = Raw Value(dBuV) + Correction Factor(dB/m)
2. Correction Factor(dB/m) = Antenna Factor(dB/m) + Cable Factor(dB) – Pre-Amplifier Factor(dB)
3. The other emission levels were very low against the limit.
4. Margin value = Emission Level – Limit value
5. " \* ": Fundamental frequency.
6. " # ": The radiated frequency is out of the restricted band.

<b>CHANNEL</b>	TX Channel 106	<b>DETECTOR FUNCTION</b>	Peak (PK)
<b>FREQUENCY RANGE</b>	1GHz ~ 40GHz		Average (AV)

**ANTENNA POLARITY & TEST DISTANCE: HORIZONTAL AT 3 M**

NO.	FREQ. (MHz)	EMISSION LEVEL (dBuV/m)	LIMIT (dBuV/m)	MARGIN (dB)	ANTENNA HEIGHT (m)	TABLE ANGLE (Degree)	RAW VALUE (dBuV)	CORRECTION FACTOR (dB/m)
1	#5470.00	68.0 PK	74.0	-6.0	2.69 H	99	63.8	4.2
2	#5470.00	53.6 AV	54.0	-0.4	2.69 H	99	49.4	4.2
3	*5530.00	102.4 PK			2.69 H	99	98.2	4.2
4	*5530.00	92.3 AV			2.69 H	99	88.1	4.2
5	#5725.00	50.2 PK	74.0	-23.8	2.69 H	99	45.8	4.4
6	#5725.00	39.1 AV	54.0	-14.9	2.69 H	99	34.7	4.4
7	11060.00	46.3 PK	74.0	-27.7	1.59 H	271	32.4	13.9
8	11060.00	33.5 AV	54.0	-20.5	1.59 H	271	19.6	13.9
9	#16590.00	45.8 PK	74.0	-28.2	1.86 H	222	30.2	15.6
10	#16590.00	32.8 AV	54.0	-21.2	1.86 H	222	17.2	15.6

**ANTENNA POLARITY & TEST DISTANCE: VERTICAL AT 3 M**

NO.	FREQ. (MHz)	EMISSION LEVEL (dBuV/m)	LIMIT (dBuV/m)	MARGIN (dB)	ANTENNA HEIGHT (m)	TABLE ANGLE (Degree)	RAW VALUE (dBuV)	CORRECTION FACTOR (dB/m)
1	#5470.00	57.4 PK	74.0	-16.6	3.31 V	306	53.2	4.2
2	#5470.00	42.6 AV	54.0	-11.4	3.31 V	306	38.4	4.2
3	*5530.00	90.3 PK			3.31 V	306	86.1	4.2
4	*5530.00	80.1 AV			3.31 V	306	75.9	4.2
5	#5725.00	46.9 PK	74.0	-27.1	3.31 V	306	42.5	4.4
6	#5725.00	35.9 AV	54.0	-18.1	3.31 V	306	31.5	4.4
7	11060.00	45.4 PK	74.0	-28.6	1.93 V	241	31.5	13.9
8	11060.00	32.7 AV	54.0	-21.3	1.93 V	241	18.8	13.9
9	#16590.00	45.8 PK	74.0	-28.2	1.56 V	217	30.2	15.6
10	#16590.00	32.7 AV	54.0	-21.3	1.56 V	217	17.1	15.6

**REMARKS:**

1. Emission Level(dBuV/m) = Raw Value(dBuV) + Correction Factor(dB/m)
2. Correction Factor(dB/m) = Antenna Factor(dB/m) + Cable Factor(dB) – Pre-Amplifier Factor(dB)
3. The other emission levels were very low against the limit.
4. Margin value = Emission Level – Limit value
5. " \* ": Fundamental frequency.
6. " # ": The radiated frequency is out of the restricted band.

<b>CHANNEL</b>	TX Channel 122	<b>DETECTOR FUNCTION</b>	Peak (PK)
<b>FREQUENCY RANGE</b>	1GHz ~ 40GHz		Average (AV)

**ANTENNA POLARITY & TEST DISTANCE: HORIZONTAL AT 3 M**

NO.	FREQ. (MHz)	EMISSION LEVEL (dBuV/m)	LIMIT (dBuV/m)	MARGIN (dB)	ANTENNA HEIGHT (m)	TABLE ANGLE (Degree)	RAW VALUE (dBuV)	CORRECTION FACTOR (dB/m)
1	*5610.00	109.9 PK			2.60 H	95	105.5	4.4
2	*5610.00	100.6 AV			2.60 H	95	96.2	4.4
3	#5725.00	68.1 PK	74.0	-5.9	2.60 H	95	63.7	4.4
<b>4</b>	<b>#5725.00</b>	<b>53.9 AV</b>	<b>54.0</b>	<b>-0.1</b>	<b>2.60 H</b>	<b>95</b>	<b>49.5</b>	<b>4.4</b>
5	11220.00	46.3 PK	74.0	-27.7	1.61 H	248	32.6	13.7
6	11220.00	33.6 AV	54.0	-20.4	1.61 H	248	19.9	13.7
7	#16830.00	45.9 PK	74.0	-28.1	1.92 H	206	30.0	15.9
8	#16830.00	33.2 AV	54.0	-20.8	1.92 H	206	17.3	15.9

**ANTENNA POLARITY & TEST DISTANCE: VERTICAL AT 3 M**

NO.	FREQ. (MHz)	EMISSION LEVEL (dBuV/m)	LIMIT (dBuV/m)	MARGIN (dB)	ANTENNA HEIGHT (m)	TABLE ANGLE (Degree)	RAW VALUE (dBuV)	CORRECTION FACTOR (dB/m)
1	*5610.00	99.5 PK			3.36 V	304	95.1	4.4
2	*5610.00	89.4 AV			3.36 V	304	85.0	4.4
3	#5725.00	57.9 PK	74.0	-16.1	3.36 V	304	53.5	4.4
4	#5725.00	43.7 AV	54.0	-10.3	3.36 V	304	39.3	4.4
5	11220.00	45.6 PK	74.0	-28.4	1.83 V	254	31.9	13.7
6	11220.00	32.5 AV	54.0	-21.5	1.83 V	254	18.8	13.7
7	#16830.00	46.0 PK	74.0	-28.0	1.63 V	218	30.1	15.9
8	#16830.00	32.9 AV	54.0	-21.1	1.63 V	218	17.0	15.9

**REMARKS:**

1. Emission Level(dBuV/m) = Raw Value(dBuV) + Correction Factor(dB/m)
2. Correction Factor(dB/m) = Antenna Factor(dB/m) + Cable Factor(dB) – Pre-Amplifier Factor(dB)
3. The other emission levels were very low against the limit.
4. Margin value = Emission Level – Limit value
5. " \* ": Fundamental frequency.
6. " # ": The radiated frequency is out of the restricted band.

<b>CHANNEL</b>	TX Channel 138	<b>DETECTOR FUNCTION</b>	Peak (PK)
<b>FREQUENCY RANGE</b>	1GHz ~ 40GHz		Average (AV)

**ANTENNA POLARITY & TEST DISTANCE: HORIZONTAL AT 3 M**

NO.	FREQ. (MHz)	EMISSION LEVEL (dBuV/m)	LIMIT (dBuV/m)	MARGIN (dB)	ANTENNA HEIGHT (m)	TABLE ANGLE (Degree)	RAW VALUE (dBuV)	CORRECTION FACTOR (dB/m)
1	#5470.00	65.9 PK	74.0	-8.1	2.56 H	94	61.7	4.2
2	#5470.00	50.3 AV	54.0	-3.7	2.56 H	94	46.1	4.2
3	*5690.00	112.7 PK			2.56 H	94	108.2	4.5
4	*5690.00	103.6 AV			2.56 H	94	99.1	4.5
5	#5850.00	66.9 PK	74.0	-7.1	2.56 H	94	62.4	4.5
6	#5850.00	52.9 AV	54.0	-1.1	2.56 H	94	48.4	4.5
7	11380.00	45.7 PK	74.0	-28.3	1.61 H	263	32.1	13.6
8	11380.00	33.3 AV	54.0	-20.7	1.61 H	263	19.7	13.6
9	#17070.00	44.9 PK	74.0	-29.1	1.87 H	221	27.6	17.3
10	#17070.00	32.5 AV	54.0	-21.5	1.87 H	221	15.2	17.3

**ANTENNA POLARITY & TEST DISTANCE: VERTICAL AT 3 M**

NO.	FREQ. (MHz)	EMISSION LEVEL (dBuV/m)	LIMIT (dBuV/m)	MARGIN (dB)	ANTENNA HEIGHT (m)	TABLE ANGLE (Degree)	RAW VALUE (dBuV)	CORRECTION FACTOR (dB/m)
1	#5470.00	56.1 PK	74.0	-17.9	3.41 V	296	51.9	4.2
2	#5470.00	39.5 AV	54.0	-14.5	3.41 V	296	35.3	4.2
3	*5690.00	101.1 PK			3.41 V	296	96.6	4.5
4	*5690.00	90.9 AV			3.41 V	296	86.4	4.5
5	#5850.00	56.3 PK	74.0	-17.7	3.41 V	296	51.8	4.5
6	#5850.00	42.7 AV	54.0	-11.3	3.41 V	296	38.2	4.5
7	11380.00	45.4 PK	74.0	-28.6	1.87 V	243	31.8	13.6
8	11380.00	32.5 AV	54.0	-21.5	1.87 V	243	18.9	13.6
9	#17070.00	45.7 PK	74.0	-28.3	1.54 V	215	28.4	17.3
10	#17070.00	32.8 AV	54.0	-21.2	1.54 V	215	15.5	17.3

**REMARKS:**

1. Emission Level(dBuV/m) = Raw Value(dBuV) + Correction Factor(dB/m)
2. Correction Factor(dB/m) = Antenna Factor(dB/m) + Cable Factor(dB) – Pre-Amplifier Factor(dB)
3. The other emission levels were very low against the limit.
4. Margin value = Emission Level – Limit value
5. " \* ": Fundamental frequency.
6. " # ": The radiated frequency is out of the restricted band.

**802.11ac (VHT80+80)**

<b>CHANNEL</b>	TX Channel 42+58	<b>DETECTOR FUNCTION</b>	Peak (PK)
<b>FREQUENCY RANGE</b>	1GHz ~ 40GHz		Average (AV)

**ANTENNA POLARITY & TEST DISTANCE: HORIZONTAL AT 3 M**

NO.	FREQ. (MHz)	EMISSION LEVEL (dBuV/m)	LIMIT (dBuV/m)	MARGIN (dB)	ANTENNA HEIGHT (m)	TABLE ANGLE (Degree)	RAW VALUE (dBuV)	CORRECTION FACTOR (dB/m)
1	5150.00	63.6 PK	74.0	-10.4	2.71 H	112	59.9	3.7
2	5150.00	52.8 AV	54.0	-1.2	2.71 H	112	49.1	3.7
3	*5210.00	99.6 PK			2.71 H	112	95.9	3.7
4	*5210.00	89.5 AV			2.71 H	112	85.8	3.7
5	*5290.00	98.7 PK			3.04 H	87	94.6	4.1
6	*5290.00	88.9 AV			3.04 H	87	84.8	4.1
7	5350.00	65.9 PK	74.0	-8.1	3.04 H	87	61.8	4.1
<b>8</b>	<b>5350.00</b>	<b>53.9 AV</b>	<b>54.0</b>	<b>-0.1</b>	<b>3.04 H</b>	<b>87</b>	<b>49.8</b>	<b>4.1</b>
9	#10420.00	46.4 PK	74.0	-27.6	1.64 H	233	33.3	13.1
10	#10420.00	34.1 AV	54.0	-19.9	1.64 H	233	21.0	13.1
11	#10580.00	46.8 PK	74.0	-27.2	1.63 H	245	33.4	13.4
12	#10580.00	34.4 AV	54.0	-19.6	1.63 H	245	21.0	13.4
13	15630.00	46.5 PK	74.0	-27.5	1.79 H	231	32.9	13.6
14	15630.00	33.7 AV	54.0	-20.3	1.79 H	231	20.1	13.6
15	15870.00	46.6 PK	74.0	-27.4	1.82 H	213	33.6	13.0
16	15870.00	33.5 AV	54.0	-20.5	1.82 H	213	20.5	13.0

**ANTENNA POLARITY & TEST DISTANCE: VERTICAL AT 3 M**

NO.	FREQ. (MHz)	EMISSION LEVEL (dBuV/m)	LIMIT (dBuV/m)	MARGIN (dB)	ANTENNA HEIGHT (m)	TABLE ANGLE (Degree)	RAW VALUE (dBuV)	CORRECTION FACTOR (dB/m)
1	5150.00	53.3 PK	74.0	-20.7	2.52 V	148	49.6	3.7
2	5150.00	42.6 AV	54.0	-11.4	2.52 V	148	38.9	3.7
3	*5210.00	85.0 PK			2.52 V	148	81.3	3.7
4	*5210.00	74.8 AV			2.52 V	148	71.1	3.7
5	*5290.00	84.3 PK			2.43 V	121	80.2	4.1
6	*5290.00	74.1 AV			2.43 V	121	70.0	4.1
7	5350.00	55.7 PK	74.0	-18.3	2.43 V	121	51.6	4.1
8	5350.00	43.4 AV	54.0	-10.6	2.43 V	121	39.3	4.1
9	#10420.00	45.7 PK	74.0	-28.3	1.88 V	237	32.6	13.1
10	#10420.00	32.8 AV	54.0	-21.2	1.88 V	237	19.7	13.1
11	#10580.00	45.5 PK	74.0	-28.5	1.81 V	220	32.1	13.4
12	#10580.00	32.4 AV	54.0	-21.6	1.81 V	220	19.0	13.4
13	15630.00	45.5 PK	74.0	-28.5	1.70 V	257	31.9	13.6
14	15630.00	32.9 AV	54.0	-21.1	1.70 V	257	19.3	13.6
15	15870.00	44.3 PK	74.0	-29.7	1.66 V	264	31.3	13.0
16	15870.00	32.1 AV	54.0	-21.9	1.66 V	264	19.1	13.0

**REMARKS:**

- Emission Level(dBuV/m) = Raw Value(dBuV) + Correction Factor(dB/m)
- Correction Factor(dB/m) = Antenna Factor(dB/m) + Cable Factor(dB) – Pre-Amplifier Factor(dB)
- The other emission levels were very low against the limit.
- Margin value = Emission Level – Limit value
- " \* ": Fundamental frequency.
- " # ": The radiated frequency is out of the restricted band.



<b>CHANNEL</b>	TX Channel 42+106	<b>DETECTOR FUNCTION</b>	Peak (PK)
<b>FREQUENCY RANGE</b>	1GHz ~ 40GHz		Average (AV)

**ANTENNA POLARITY & TEST DISTANCE: HORIZONTAL AT 3 M**

NO.	FREQ. (MHz)	EMISSION LEVEL (dBuV/m)	LIMIT (dBuV/m)	MARGIN (dB)	ANTENNA HEIGHT (m)	TABLE ANGLE (Degree)	RAW VALUE (dBuV)	CORRECTION FACTOR (dB/m)
1	5150.00	63.5 PK	74.0	-10.5	3.95 H	111	59.8	3.7
2	5150.00	53.1 AV	54.0	-0.9	3.95 H	111	49.4	3.7
3	*5210.00	99.6 PK			3.95 H	111	95.9	3.7
4	*5210.00	89.8 AV			3.95 H	111	86.1	3.7
5	5350.00	63.8 PK	74.0	-10.2	3.95 H	111	59.7	4.1
6	5350.00	49.2 AV	54.0	-4.8	3.95 H	111	45.1	4.1
7	#5470.00	68.0 PK	74.0	-6.0	3.98 H	92	63.8	4.2
8	#5470.00	53.6 AV	54.0	-0.4	3.98 H	92	49.4	4.2
9	*5530.00	100.5 PK			3.98 H	92	96.3	4.2
10	*5530.00	90.3 AV			3.98 H	92	86.1	4.2
11	#5725.00	49.8 PK	74.0	-24.2	3.98 H	92	45.4	4.4
12	#5725.00	37.3 AV	54.0	-16.7	3.98 H	92	32.9	4.4
13	#10420.00	46.3 PK	74.0	-27.7	1.64 H	247	33.2	13.1
14	#10420.00	34.4 AV	54.0	-19.6	1.64 H	247	21.3	13.1
15	11060.00	46.6 PK	74.0	-27.4	1.65 H	241	32.7	13.9
16	11060.00	34.8 AV	54.0	-19.2	1.65 H	241	20.9	13.9
17	15630.00	46.6 PK	74.0	-27.4	1.80 H	221	33.0	13.6
18	15630.00	33.5 AV	54.0	-20.5	1.80 H	221	19.9	13.6
19	#16590.00	46.4 PK	74.0	-27.6	1.80 H	217	30.8	15.6
20	#16590.00	33.3 AV	54.0	-20.7	1.80 H	217	17.7	15.6

**ANTENNA POLARITY & TEST DISTANCE: VERTICAL AT 3 M**

NO.	FREQ. (MHz)	EMISSION LEVEL (dBuV/m)	LIMIT (dBuV/m)	MARGIN (dB)	ANTENNA HEIGHT (m)	TABLE ANGLE (Degree)	RAW VALUE (dBuV)	CORRECTION FACTOR (dB/m)
1	5150.00	53.3 PK	74.0	-20.7	2.52 V	148	49.6	3.7
2	5150.00	42.6 AV	54.0	-11.4	2.52 V	148	38.9	3.7
3	*5210.00	85.0 PK			2.52 V	148	81.3	3.7
4	*5210.00	74.8 AV			2.52 V	148	71.1	3.7
5	5350.00	54.2 PK	74.0	-19.8	2.52 V	148	50.1	4.1
6	5350.00	39.6 AV	54.0	-14.4	2.52 V	148	35.5	4.1
7	#5470.00	55.0 PK	74.0	-19.0	2.59 V	171	50.8	4.2
8	#5470.00	40.4 AV	54.0	-13.6	2.59 V	171	36.2	4.2
9	*5530.00	86.0 PK			2.59 V	171	81.8	4.2
10	*5530.00	75.7 AV			2.59 V	171	71.5	4.2
11	#5725.00	46.7 PK	74.0	-27.3	2.59 V	171	42.3	4.4
12	#5725.00	34.2 AV	54.0	-19.8	2.59 V	171	29.8	4.4
13	#10420.00	45.9 PK	74.0	-28.1	1.83 V	226	32.8	13.1
14	#10420.00	33.0 AV	54.0	-21.0	1.83 V	226	19.9	13.1
15	11060.00	45.2 PK	74.0	-28.8	1.85 V	241	31.3	13.9
16	11060.00	32.3 AV	54.0	-21.7	1.85 V	241	18.4	13.9
17	15630.00	44.8 PK	74.0	-29.2	1.75 V	264	31.2	13.6
18	15630.00	32.4 AV	54.0	-21.6	1.75 V	264	18.8	13.6
19	#16590.00	44.3 PK	74.0	-29.7	1.73 V	234	28.7	15.6
20	#16590.00	32.0 AV	54.0	-22.0	1.73 V	234	16.4	15.6

**REMARKS:**

1. Emission Level(dBuV/m) = Raw Value(dBuV) + Correction Factor(dB/m)
2. Correction Factor(dB/m) = Antenna Factor(dB/m) + Cable Factor(dB) – Pre-Amplifier Factor(dB)
3. The other emission levels were very low against the limit.
4. Margin value = Emission Level – Limit value
5. " \* ": Fundamental frequency.
6. " # ": The radiated frequency is out of the restricted band.

<b>CHANNEL</b>	TX Channel 42+122	<b>DETECTOR FUNCTION</b>	Peak (PK)
<b>FREQUENCY RANGE</b>	1GHz ~ 40GHz		Average (AV)

**ANTENNA POLARITY & TEST DISTANCE: HORIZONTAL AT 3 M**

NO.	FREQ. (MHz)	EMISSION LEVEL (dBuV/m)	LIMIT (dBuV/m)	MARGIN (dB)	ANTENNA HEIGHT (m)	TABLE ANGLE (Degree)	RAW VALUE (dBuV)	CORRECTION FACTOR (dB/m)
1	5150.00	66.2 PK	74.0	-7.8	3.00 H	106	62.5	3.7
2	5150.00	53.6 AV	54.0	-0.4	3.00 H	106	49.9	3.7
3	*5210.00	100.0 PK			3.00 H	106	96.3	3.7
4	*5210.00	89.9 AV			3.00 H	106	86.2	3.7
5	5350.00	50.2 PK	74.0	-23.8	3.00 H	106	46.1	4.1
6	5350.00	38.5 AV	54.0	-15.5	3.00 H	106	34.4	4.1
7	*5610.00	101.7 PK			2.62 H	88	97.3	4.4
8	*5610.00	91.7 AV			2.62 H	88	87.3	4.4
9	#5725.00	50.9 PK	74.0	-23.1	2.62 H	88	46.5	4.4
10	#5725.00	39.4 AV	54.0	-14.6	2.62 H	88	35.0	4.4
11	#10420.00	46.6 PK	74.0	-27.4	1.65 H	240	33.5	13.1
12	#10420.00	34.5 AV	54.0	-19.5	1.65 H	240	21.4	13.1
13	11220.00	47.0 PK	74.0	-27.0	1.59 H	228	33.3	13.7
14	11220.00	34.8 AV	54.0	-19.2	1.59 H	228	21.1	13.7
15	15630.00	46.4 PK	74.0	-27.6	1.81 H	226	32.8	13.6
16	15630.00	33.5 AV	54.0	-20.5	1.81 H	226	19.9	13.6
17	#16830.00	46.0 PK	74.0	-28.0	1.84 H	229	30.1	15.9
18	#16830.00	33.2 AV	54.0	-20.8	1.84 H	229	17.3	15.9

**ANTENNA POLARITY & TEST DISTANCE: VERTICAL AT 3 M**

NO.	FREQ. (MHz)	EMISSION LEVEL (dBuV/m)	LIMIT (dBuV/m)	MARGIN (dB)	ANTENNA HEIGHT (m)	TABLE ANGLE (Degree)	RAW VALUE (dBuV)	CORRECTION FACTOR (dB/m)
1	5150.00	53.3 PK	74.0	-20.7	2.52 V	148	49.6	3.7
2	5150.00	42.6 AV	54.0	-11.4	2.52 V	148	38.9	3.7
3	*5210.00	85.0 PK			2.52 V	148	81.3	3.7
4	*5210.00	74.8 AV			2.52 V	148	71.1	3.7
5	5350.00	47.0 PK	74.0	-27.0	2.52 V	148	42.9	4.1
6	5350.00	35.2 AV	54.0	-18.8	2.52 V	148	31.1	4.1
7	*5610.00	87.1 PK			2.43 V	181	82.7	4.4
8	*5610.00	77.4 AV			2.43 V	181	73.0	4.4
9	#5725.00	47.6 PK	74.0	-26.4	2.43 V	181	43.2	4.4
10	#5725.00	36.1 AV	54.0	-17.9	2.43 V	181	31.7	4.4
11	#10420.00	45.9 PK	74.0	-28.1	1.82 V	230	32.8	13.1
12	#10420.00	32.8 AV	54.0	-21.2	1.82 V	230	19.7	13.1
13	11220.00	45.7 PK	74.0	-28.3	1.91 V	230	32.0	13.7
14	11220.00	32.9 AV	54.0	-21.1	1.91 V	230	19.2	13.7
15	15630.00	44.7 PK	74.0	-29.3	1.63 V	248	31.1	13.6
16	15630.00	32.0 AV	54.0	-22.0	1.63 V	248	18.4	13.6
17	#16830.00	44.7 PK	74.0	-29.3	1.71 V	262	28.8	15.9
18	#16830.00	32.1 AV	54.0	-21.9	1.71 V	262	16.2	15.9

**REMARKS:**

1. Emission Level(dBuV/m) = Raw Value(dBuV) + Correction Factor(dB/m)
2. Correction Factor(dB/m) = Antenna Factor(dB/m) + Cable Factor(dB) – Pre-Amplifier Factor(dB)
3. The other emission levels were very low against the limit.
4. Margin value = Emission Level – Limit value
5. " \* ": Fundamental frequency.
6. " # ": The radiated frequency is out of the restricted band.

<b>CHANNEL</b>	TX Channel 42+138	<b>DETECTOR FUNCTION</b>	Peak (PK)
<b>FREQUENCY RANGE</b>	1GHz ~ 40GHz		Average (AV)

**ANTENNA POLARITY & TEST DISTANCE: HORIZONTAL AT 3 M**

NO.	FREQ. (MHz)	EMISSION LEVEL (dBuV/m)	LIMIT (dBuV/m)	MARGIN (dB)	ANTENNA HEIGHT (m)	TABLE ANGLE (Degree)	RAW VALUE (dBuV)	CORRECTION FACTOR (dB/m)
1	5150.00	65.2 PK	74.0	-8.8	3.33 H	114	61.5	3.7
2	5150.00	53.7 AV	54.0	-0.3	3.33 H	114	50.0	3.7
3	*5210.00	99.5 PK			3.33 H	114	95.8	3.7
4	*5210.00	89.5 AV			3.33 H	114	85.8	3.7
5	5350.00	49.5 PK	74.0	-24.5	3.33 H	114	45.4	4.1
6	5350.00	38.1 AV	54.0	-15.9	3.33 H	114	34.0	4.1
7	#5470.00	50.3 PK	74.0	-23.7	2.91 H	87	46.1	4.2
8	#5470.00	36.7 AV	54.0	-17.3	2.91 H	87	32.5	4.2
9	*5690.00	100.8 PK			2.91 H	87	96.3	4.5
10	*5690.00	90.6 AV			2.91 H	87	86.1	4.5
11	#5850.00	49.5 PK	74.0	-24.5	2.91 H	87	45.0	4.5
12	#5850.00	36.6 AV	54.0	-17.4	2.91 H	87	32.1	4.5
13	#10420.00	46.7 PK	74.0	-27.3	1.54 H	222	33.6	13.1
14	#10420.00	34.4 AV	54.0	-19.6	1.54 H	222	21.3	13.1
15	11380.00	46.3 PK	74.0	-27.7	1.57 H	228	32.7	13.6
16	11380.00	33.9 AV	54.0	-20.1	1.57 H	228	20.3	13.6
17	15630.00	46.1 PK	74.0	-27.9	1.80 H	220	32.5	13.6
18	15630.00	33.4 AV	54.0	-20.6	1.80 H	220	19.8	13.6
19	#17070.00	45.8 PK	74.0	-28.2	1.79 H	241	28.5	17.3
20	#17070.00	33.0 AV	54.0	-21.0	1.79 H	241	15.7	17.3

**ANTENNA POLARITY & TEST DISTANCE: VERTICAL AT 3 M**

NO.	FREQ. (MHz)	EMISSION LEVEL (dBuV/m)	LIMIT (dBuV/m)	MARGIN (dB)	ANTENNA HEIGHT (m)	TABLE ANGLE (Degree)	RAW VALUE (dBuV)	CORRECTION FACTOR (dB/m)
1	5150.00	53.3 PK	74.0	-20.7	2.52 V	148	49.6	3.7
2	5150.00	42.6 AV	54.0	-11.4	2.52 V	148	38.9	3.7
3	*5210.00	85.0 PK			2.52 V	148	81.3	3.7
4	*5210.00	74.8 AV			2.52 V	148	71.1	3.7
5	5350.00	47.0 PK	74.0	-27.0	2.52 V	148	42.9	4.1
6	5350.00	35.2 AV	54.0	-18.8	2.52 V	148	31.1	4.1
7	#5470.00	47.1 PK	74.0	-26.9	2.49 V	133	42.9	4.2
8	#5470.00	33.5 AV	54.0	-20.5	2.49 V	133	29.3	4.2
9	*5690.00	86.4 PK			2.49 V	133	81.9	4.5
10	*5690.00	76.0 AV			2.49 V	133	71.5	4.5
11	#5850.00	46.2 PK	74.0	-27.8	2.49 V	133	41.7	4.5
12	#5850.00	33.2 AV	54.0	-20.8	2.49 V	133	28.7	4.5
13	#10420.00	46.1 PK	74.0	-27.9	1.89 V	235	33.0	13.1
14	#10420.00	33.1 AV	54.0	-20.9	1.89 V	235	20.0	13.1
15	11380.00	45.9 PK	74.0	-28.1	1.91 V	240	32.3	13.6
16	11380.00	33.0 AV	54.0	-21.0	1.91 V	240	19.4	13.6
17	15630.00	44.5 PK	74.0	-29.5	1.64 V	241	30.9	13.6
18	15630.00	32.2 AV	54.0	-21.8	1.64 V	241	18.6	13.6
19	#17070.00	44.4 PK	74.0	-29.6	1.63 V	258	27.1	17.3
20	#17070.00	32.0 AV	54.0	-22.0	1.63 V	258	14.7	17.3

**REMARKS:**

1. Emission Level(dBuV/m) = Raw Value(dBuV) + Correction Factor(dB/m)
2. Correction Factor(dB/m) = Antenna Factor(dB/m) + Cable Factor(dB) – Pre-Amplifier Factor(dB)
3. The other emission levels were very low against the limit.
4. Margin value = Emission Level – Limit value
5. " \* ": Fundamental frequency.
6. " # ": The radiated frequency is out of the restricted band.

<b>CHANNEL</b>	TX Channel 58+106	<b>DETECTOR FUNCTION</b>	Peak (PK)
<b>FREQUENCY RANGE</b>	1GHz ~ 40GHz		Average (AV)

**ANTENNA POLARITY & TEST DISTANCE: HORIZONTAL AT 3 M**

NO.	FREQ. (MHz)	EMISSION LEVEL (dBuV/m)	LIMIT (dBuV/m)	MARGIN (dB)	ANTENNA HEIGHT (m)	TABLE ANGLE (Degree)	RAW VALUE (dBuV)	CORRECTION FACTOR (dB/m)
1	5150.00	50.1 PK	74.0	-23.9	2.97 H	107	46.4	3.7
2	5150.00	38.9 AV	54.0	-15.1	2.97 H	107	35.2	3.7
3	*5290.00	97.6 PK			2.97 H	107	93.5	4.1
4	*5290.00	88.0 AV			2.97 H	107	83.9	4.1
5	5350.00	65.8 PK	74.0	-8.2	2.97 H	107	61.7	4.1
6	5350.00	53.6 AV	54.0	-0.4	2.97 H	107	49.5	4.1
7	#5470.00	65.0 PK	74.0	-9.0	2.79 H	89	60.8	4.2
8	#5470.00	50.7 AV	54.0	-3.3	2.79 H	89	46.5	4.2
9	*5530.00	98.9 PK			2.79 H	89	94.7	4.2
10	*5530.00	88.5 AV			2.79 H	89	84.3	4.2
11	#5725.00	49.2 PK	74.0	-24.8	2.79 H	89	44.8	4.4
12	#5725.00	36.7 AV	54.0	-17.3	2.79 H	89	32.3	4.4
13	#10580.00	46.4 PK	74.0	-27.6	1.58 H	248	33.0	13.4
14	#10580.00	34.5 AV	54.0	-19.5	1.58 H	248	21.1	13.4
15	11060.00	47.0 PK	74.0	-27.0	1.53 H	238	33.1	13.9
16	11060.00	34.9 AV	54.0	-19.1	1.53 H	238	21.0	13.9
17	15870.00	46.2 PK	74.0	-27.8	1.79 H	238	33.2	13.0
18	15870.00	33.3 AV	54.0	-20.7	1.79 H	238	20.3	13.0
19	#16590.00	45.9 PK	74.0	-28.1	1.88 H	222	30.3	15.6
20	#16590.00	33.2 AV	54.0	-20.8	1.88 H	222	17.6	15.6

**ANTENNA POLARITY & TEST DISTANCE: VERTICAL AT 3 M**

NO.	FREQ. (MHz)	EMISSION LEVEL (dBuV/m)	LIMIT (dBuV/m)	MARGIN (dB)	ANTENNA HEIGHT (m)	TABLE ANGLE (Degree)	RAW VALUE (dBuV)	CORRECTION FACTOR (dB/m)
1	5150.00	47.9 PK	74.0	-26.1	2.59 V	171	44.2	3.7
2	5150.00	35.6 AV	54.0	-18.4	2.59 V	171	31.9	3.7
3	*5290.00	83.3 PK			2.59 V	171	79.2	4.1
4	*5290.00	73.7 AV			2.59 V	171	69.6	4.1
5	5350.00	52.0 PK	74.0	-22.0	2.59 V	171	47.9	4.1
6	5350.00	40.1 AV	54.0	-13.9	2.59 V	171	36.0	4.1
7	#5470.00	54.8 PK	74.0	-19.2	2.28 V	165	50.6	4.2
8	#5470.00	40.5 AV	54.0	-13.5	2.28 V	165	36.3	4.2
9	*5530.00	84.2 PK			2.28 V	165	80.0	4.2
10	*5530.00	73.6 AV			2.28 V	165	69.4	4.2
11	#5725.00	45.8 PK	74.0	-28.2	2.28 V	165	41.4	4.4
12	#5725.00	33.5 AV	54.0	-20.5	2.28 V	165	29.1	4.4
13	#10580.00	45.7 PK	74.0	-28.3	1.83 V	241	32.3	13.4
14	#10580.00	32.7 AV	54.0	-21.3	1.83 V	241	19.3	13.4
15	11060.00	45.8 PK	74.0	-28.2	1.84 V	224	31.9	13.9
16	11060.00	32.8 AV	54.0	-21.2	1.84 V	224	18.9	13.9
17	15870.00	44.5 PK	74.0	-29.5	1.74 V	242	31.5	13.0
18	15870.00	32.1 AV	54.0	-21.9	1.74 V	242	19.1	13.0
19	#16590.00	44.7 PK	74.0	-29.3	1.66 V	249	29.1	15.6
20	#16590.00	31.9 AV	54.0	-22.1	1.66 V	249	16.3	15.6

**REMARKS:**

1. Emission Level(dBuV/m) = Raw Value(dBuV) + Correction Factor(dB/m)
2. Correction Factor(dB/m) = Antenna Factor(dB/m) + Cable Factor(dB) – Pre-Amplifier Factor(dB)
3. The other emission levels were very low against the limit.
4. Margin value = Emission Level – Limit value
5. " \* ": Fundamental frequency.
6. " # ": The radiated frequency is out of the restricted band.



<b>CHANNEL</b>	TX Channel 58+122	<b>DETECTOR FUNCTION</b>	Peak (PK)
<b>FREQUENCY RANGE</b>	1GHz ~ 40GHz		Average (AV)

**ANTENNA POLARITY & TEST DISTANCE: HORIZONTAL AT 3 M**

NO.	FREQ. (MHz)	EMISSION LEVEL (dBuV/m)	LIMIT (dBuV/m)	MARGIN (dB)	ANTENNA HEIGHT (m)	TABLE ANGLE (Degree)	RAW VALUE (dBuV)	CORRECTION FACTOR (dB/m)
1	*5290.00	98.7 PK			3.00 H	116	94.6	4.1
2	*5290.00	88.7 AV			3.00 H	116	84.6	4.1
3	5350.00	66.2 PK	74.0	-7.8	3.00 H	116	62.1	4.1
4	5350.00	53.6 AV	54.0	-0.4	3.00 H	116	49.5	4.1
5	*5610.00	100.2 PK			2.95 H	87	95.8	4.4
6	*5610.00	89.9 AV			2.95 H	87	85.5	4.4
7	#5725.00	49.1 PK	74.0	-24.9	2.95 H	87	44.7	4.4
8	#5725.00	38.4 AV	54.0	-15.6	2.95 H	87	34.0	4.4
9	#10580.00	46.5 PK	74.0	-27.5	1.61 H	220	33.1	13.4
10	#10580.00	34.7 AV	54.0	-19.3	1.61 H	220	21.3	13.4
11	11220.00	46.5 PK	74.0	-27.5	1.56 H	220	32.8	13.7
12	11220.00	34.5 AV	54.0	-19.5	1.56 H	220	20.8	13.7
13	15870.00	46.6 PK	74.0	-27.4	1.79 H	216	33.6	13.0
14	15870.00	33.5 AV	54.0	-20.5	1.79 H	216	20.5	13.0
15	#16830.00	46.2 PK	74.0	-27.8	1.88 H	218	30.3	15.9
16	#16830.00	33.2 AV	54.0	-20.8	1.88 H	218	17.3	15.9

**ANTENNA POLARITY & TEST DISTANCE: VERTICAL AT 3 M**

NO.	FREQ. (MHz)	EMISSION LEVEL (dBuV/m)	LIMIT (dBuV/m)	MARGIN (dB)	ANTENNA HEIGHT (m)	TABLE ANGLE (Degree)	RAW VALUE (dBuV)	CORRECTION FACTOR (dB/m)
1	*5290.00	83.3 PK			2.59 V	171	79.2	4.1
2	*5290.00	73.7 AV			2.59 V	171	69.6	4.1
3	5350.00	52.0 PK	74.0	-22.0	2.59 V	171	47.9	4.1
4	5350.00	40.1 AV	54.0	-13.9	2.59 V	171	36.0	4.1
5	*5610.00	84.8 PK			2.25 V	138	80.4	4.4
6	*5610.00	75.7 AV			2.25 V	138	71.3	4.4
7	#5725.00	46.0 PK	74.0	-28.0	2.25 V	138	41.6	4.4
8	#5725.00	35.3 AV	54.0	-18.7	2.25 V	138	30.9	4.4
9	#10580.00	45.9 PK	74.0	-28.1	1.80 V	217	32.5	13.4
10	#10580.00	33.0 AV	54.0	-21.0	1.80 V	217	19.6	13.4
11	11220.00	45.1 PK	74.0	-28.9	1.87 V	227	31.4	13.7
12	11220.00	32.5 AV	54.0	-21.5	1.87 V	227	18.8	13.7
13	15870.00	44.7 PK	74.0	-29.3	1.72 V	253	31.7	13.0
14	15870.00	32.2 AV	54.0	-21.8	1.72 V	253	19.2	13.0
15	#16830.00	45.2 PK	74.0	-28.8	1.72 V	264	29.3	15.9
16	#16830.00	32.7 AV	54.0	-21.3	1.72 V	264	16.8	15.9

**REMARKS:**

1. Emission Level(dBuV/m) = Raw Value(dBuV) + Correction Factor(dB/m)
2. Correction Factor(dB/m) = Antenna Factor(dB/m) + Cable Factor(dB) – Pre-Amplifier Factor(dB)
3. The other emission levels were very low against the limit.
4. Margin value = Emission Level – Limit value
5. " \* ": Fundamental frequency.
6. " # ": The radiated frequency is out of the restricted band.

<b>CHANNEL</b>	TX Channel 58+138	<b>DETECTOR FUNCTION</b>	Peak (PK)
<b>FREQUENCY RANGE</b>	1GHz ~ 40GHz		Average (AV)

**ANTENNA POLARITY & TEST DISTANCE: HORIZONTAL AT 3 M**

NO.	FREQ. (MHz)	EMISSION LEVEL (dBuV/m)	LIMIT (dBuV/m)	MARGIN (dB)	ANTENNA HEIGHT (m)	TABLE ANGLE (Degree)	RAW VALUE (dBuV)	CORRECTION FACTOR (dB/m)
1	5150.00	52.6 PK	74.0	-21.4	2.83 H	133	48.9	3.7
2	5150.00	39.3 AV	54.0	-14.7	2.83 H	133	35.6	3.7
3	*5290.00	98.9 PK			2.83 H	133	94.8	4.1
4	*5290.00	88.8 AV			2.83 H	133	84.7	4.1
5	5350.00	64.8 PK	74.0	-9.2	2.83 H	133	60.7	4.1
6	5350.00	52.8 AV	54.0	-1.2	2.83 H	133	48.7	4.1
7	#5470.00	67.8 PK	74.0	-6.2	2.71 H	103	63.6	4.2
<b>8</b>	<b>#5470.00</b>	<b>53.9 AV</b>	<b>54.0</b>	<b>-0.1</b>	<b>2.71 H</b>	<b>103</b>	<b>49.7</b>	<b>4.2</b>
9	*5690.00	96.3 PK			2.71 H	103	91.8	4.5
10	*5690.00	87.1 AV			2.71 H	103	82.6	4.5
11	#5850.00	50.0 PK	74.0	-24.0	2.71 H	103	45.5	4.5
12	#5850.00	36.6 AV	54.0	-17.4	2.71 H	103	32.1	4.5
13	#10580.00	46.9 PK	74.0	-27.1	1.58 H	237	33.5	13.4
14	#10580.00	34.9 AV	54.0	-19.1	1.58 H	237	21.5	13.4
15	11380.00	46.1 PK	74.0	-27.9	1.61 H	233	32.5	13.6
16	11380.00	34.3 AV	54.0	-19.7	1.61 H	233	20.7	13.6
17	15870.00	46.3 PK	74.0	-27.7	1.82 H	236	33.3	13.0
18	15870.00	33.4 AV	54.0	-20.6	1.82 H	236	20.4	13.0
19	#17070.00	46.9 PK	74.0	-27.1	1.79 H	230	29.6	17.3
20	#17070.00	33.8 AV	54.0	-20.2	1.79 H	230	16.5	17.3

**ANTENNA POLARITY & TEST DISTANCE: VERTICAL AT 3 M**

NO.	FREQ. (MHz)	EMISSION LEVEL (dBuV/m)	LIMIT (dBuV/m)	MARGIN (dB)	ANTENNA HEIGHT (m)	TABLE ANGLE (Degree)	RAW VALUE (dBuV)	CORRECTION FACTOR (dB/m)
1	5150.00	47.9 PK	74.0	-26.1	2.59 V	171	44.2	3.7
2	5150.00	35.6 AV	54.0	-18.4	2.59 V	171	31.9	3.7
3	*5290.00	83.3 PK			2.59 V	171	79.2	4.1
4	*5290.00	73.7 AV			2.59 V	171	69.6	4.1
5	5350.00	52.0 PK	74.0	-22.0	2.59 V	171	47.9	4.1
6	5350.00	40.1 AV	54.0	-13.9	2.59 V	171	36.0	4.1
7	#5470.00	57.7 PK	74.0	-16.3	2.43 V	149	53.5	4.2
8	#5470.00	43.8 AV	54.0	-10.2	2.43 V	149	39.6	4.2
9	*5690.00	82.9 PK			2.43 V	149	78.4	4.5
10	*5690.00	72.5 AV			2.43 V	149	68.0	4.5
11	#5850.00	46.9 PK	74.0	-27.1	2.43 V	149	42.4	4.5
12	#5850.00	33.5 AV	54.0	-20.5	2.43 V	149	29.0	4.5
13	#10580.00	45.8 PK	74.0	-28.2	1.89 V	233	32.4	13.4
14	#10580.00	33.1 AV	54.0	-20.9	1.89 V	233	19.7	13.4
15	11380.00	45.3 PK	74.0	-28.7	1.83 V	238	31.7	13.6
16	11380.00	32.5 AV	54.0	-21.5	1.83 V	238	18.9	13.6
17	15870.00	44.5 PK	74.0	-29.5	1.67 V	253	31.5	13.0
18	15870.00	32.0 AV	54.0	-22.0	1.67 V	253	19.0	13.0
19	#17070.00	44.4 PK	74.0	-29.6	1.70 V	258	27.1	17.3
20	#17070.00	32.0 AV	54.0	-22.0	1.70 V	258	14.7	17.3

**REMARKS:**

1. Emission Level(dBuV/m) = Raw Value(dBuV) + Correction Factor(dB/m)
2. Correction Factor(dB/m) = Antenna Factor(dB/m) + Cable Factor(dB) – Pre-Amplifier Factor(dB)
3. The other emission levels were very low against the limit.
4. Margin value = Emission Level – Limit value
5. " \* ": Fundamental frequency.
6. " # ": The radiated frequency is out of the restricted band.

<b>CHANNEL</b>	TX Channel 58+155	<b>DETECTOR FUNCTION</b>	Peak (PK)
<b>FREQUENCY RANGE</b>	1GHz ~ 40GHz		Average (AV)

**ANTENNA POLARITY & TEST DISTANCE: HORIZONTAL AT 3 M**

NO.	FREQ. (MHz)	EMISSION LEVEL (dBuV/m)	LIMIT (dBuV/m)	MARGIN (dB)	ANTENNA HEIGHT (m)	TABLE ANGLE (Degree)	RAW VALUE (dBuV)	CORRECTION FACTOR (dB/m)
1	5150.00	52.7 PK	74.0	-21.3	3.03 H	110	49.0	3.7
2	5150.00	39.7 AV	54.0	-14.3	3.03 H	110	36.0	3.7
3	*5290.00	99.0 PK			3.03 H	110	94.9	4.1
4	*5290.00	89.1 AV			3.03 H	110	85.0	4.1
5	5350.00	65.9 PK	74.0	-8.1	3.03 H	110	61.8	4.1
6	5350.00	53.8 AV	54.0	-0.2	3.03 H	110	49.7	4.1
7	#5574.05	58.2 PK	68.2	-10.0	2.82 H	141	54.0	4.2
8	*5775.00	96.5 PK			2.82 H	141	92.1	4.4
9	*5775.00	86.4 AV			2.82 H	141	82.0	4.4
10	#5958.46	58.1 PK	68.2	-10.1	2.82 H	141	53.4	4.7
11	#10580.00	46.4 PK	74.0	-27.6	1.62 H	223	33.0	13.4
12	#10580.00	34.1 AV	54.0	-19.9	1.62 H	223	20.7	13.4
13	11550.00	46.6 PK	74.0	-27.4	1.62 H	219	33.1	13.5
14	11550.00	34.3 AV	54.0	-19.7	1.62 H	219	20.8	13.5
15	15870.00	45.7 PK	74.0	-28.3	1.79 H	217	32.7	13.0
16	15870.00	32.9 AV	54.0	-21.1	1.79 H	217	19.9	13.0
17	#17325.00	46.0 PK	74.0	-28.0	1.89 H	237	28.2	17.8
18	#17325.00	33.5 AV	54.0	-20.5	1.89 H	237	15.7	17.8

**ANTENNA POLARITY & TEST DISTANCE: VERTICAL AT 3 M**

NO.	FREQ. (MHz)	EMISSION LEVEL (dBuV/m)	LIMIT (dBuV/m)	MARGIN (dB)	ANTENNA HEIGHT (m)	TABLE ANGLE (Degree)	RAW VALUE (dBuV)	CORRECTION FACTOR (dB/m)
1	5150.00	47.9 PK	74.0	-26.1	2.59 V	171	44.2	3.7
2	5150.00	35.6 AV	54.0	-18.4	2.59 V	171	31.9	3.7
3	*5290.00	83.3 PK			2.59 V	171	79.2	4.1
4	*5290.00	73.7 AV			2.59 V	171	69.6	4.1
5	5350.00	52.0 PK	74.0	-22.0	2.59 V	171	47.9	4.1
6	5350.00	40.1 AV	54.0	-13.9	2.59 V	171	36.0	4.1
7	#5566.79	56.9 PK	68.2	-11.3	2.45 V	151	52.7	4.2
8	*5775.00	86.6 PK			2.45 V	151	82.2	4.4
9	*5775.00	76.2 AV			2.45 V	151	71.8	4.4
10	#5978.38	58.3 PK	68.2	-9.9	2.45 V	151	53.6	4.7
11	#10580.00	46.5 PK	74.0	-27.5	1.79 V	243	33.1	13.4
12	#10580.00	33.9 AV	54.0	-20.1	1.79 V	243	20.5	13.4
13	11550.00	45.6 PK	74.0	-28.4	1.83 V	227	32.1	13.5
14	11550.00	33.0 AV	54.0	-21.0	1.83 V	227	19.5	13.5
15	15870.00	44.4 PK	74.0	-29.6	1.73 V	248	31.4	13.0
16	15870.00	32.1 AV	54.0	-21.9	1.73 V	248	19.1	13.0
17	#17325.00	44.6 PK	74.0	-29.4	1.73 V	259	26.8	17.8
18	#17325.00	32.0 AV	54.0	-22.0	1.73 V	259	14.2	17.8

**REMARKS:**

1. Emission Level(dBuV/m) = Raw Value(dBuV) + Correction Factor(dB/m)
2. Correction Factor(dB/m) = Antenna Factor(dB/m) + Cable Factor(dB) – Pre-Amplifier Factor(dB)
3. The other emission levels were very low against the limit.
4. Margin value = Emission Level – Limit value
5. " \* ": Fundamental frequency.
6. " # ": The radiated frequency is out of the restricted band.

<b>CHANNEL</b>	TX Channel 106+122	<b>DETECTOR FUNCTION</b>	Peak (PK)
<b>FREQUENCY RANGE</b>	1GHz ~ 40GHz		Average (AV)

**ANTENNA POLARITY & TEST DISTANCE: HORIZONTAL AT 3 M**

NO.	FREQ. (MHz)	EMISSION LEVEL (dBuV/m)	LIMIT (dBuV/m)	MARGIN (dB)	ANTENNA HEIGHT (m)	TABLE ANGLE (Degree)	RAW VALUE (dBuV)	CORRECTION FACTOR (dB/m)
1	#5470.00	68.0 PK	74.0	-6.0	2.88 H	101	63.8	4.2
2	#5470.00	53.9 AV	54.0	-0.1	2.88 H	101	49.7	4.2
3	*5530.00	98.8 PK			2.88 H	101	94.6	4.2
4	*5530.00	89.4 AV			2.88 H	101	85.2	4.2
5	*5610.00	99.4 PK			2.82 H	87	95.0	4.4
6	*5610.00	89.2 AV			2.82 H	87	84.8	4.4
7	#5725.00	50.7 PK	74.0	-23.3	2.88 H	101	46.3	4.4
8	#5725.00	39.4 AV	54.0	-14.6	2.88 H	101	35.0	4.4
9	11060.00	46.6 PK	74.0	-27.4	1.63 H	231	32.7	13.9
10	11060.00	34.6 AV	54.0	-19.4	1.63 H	231	20.7	13.9
11	11220.00	46.8 PK	74.0	-27.2	1.54 H	235	33.1	13.7
12	11220.00	34.6 AV	54.0	-19.4	1.54 H	235	20.9	13.7
13	#16590.00	45.7 PK	74.0	-28.3	1.80 H	229	30.1	15.6
14	#16590.00	33.1 AV	54.0	-20.9	1.80 H	229	17.5	15.6
15	#16830.00	46.0 PK	74.0	-28.0	1.87 H	213	30.1	15.9
16	#16830.00	33.2 AV	54.0	-20.8	1.87 H	213	17.3	15.9

**ANTENNA POLARITY & TEST DISTANCE: VERTICAL AT 3 M**

NO.	FREQ. (MHz)	EMISSION LEVEL (dBuV/m)	LIMIT (dBuV/m)	MARGIN (dB)	ANTENNA HEIGHT (m)	TABLE ANGLE (Degree)	RAW VALUE (dBuV)	CORRECTION FACTOR (dB/m)
1	#5470.00	49.2 PK	74.0	-24.8	2.53 V	136	45.0	4.2
2	#5470.00	37.5 AV	54.0	-16.5	2.53 V	136	33.3	4.2
3	*5530.00	85.6 PK			2.53 V	136	81.4	4.2
4	*5530.00	75.2 AV			2.53 V	136	71.0	4.2
5	*5610.00	83.8 PK			2.20 V	152	79.4	4.4
6	*5610.00	74.4 AV			2.20 V	152	70.0	4.4
7	#5725.00	47.3 PK	74.0	-26.7	2.53 V	136	42.9	4.4
8	#5725.00	36.2 AV	54.0	-17.8	2.53 V	136	31.8	4.4
9	11060.00	45.7 PK	74.0	-28.3	1.80 V	229	31.8	13.9
10	11060.00	33.1 AV	54.0	-20.9	1.80 V	229	19.2	13.9
11	11220.00	46.1 PK	74.0	-27.9	1.82 V	228	32.4	13.7
12	11220.00	33.0 AV	54.0	-21.0	1.82 V	228	19.3	13.7
13	#16590.00	45.4 PK	74.0	-28.6	1.70 V	263	29.8	15.6
14	#16590.00	32.6 AV	54.0	-21.4	1.70 V	263	17.0	15.6
15	#16830.00	45.0 PK	74.0	-29.0	1.69 V	248	29.1	15.9
16	#16830.00	32.7 AV	54.0	-21.3	1.69 V	248	16.8	15.9

**REMARKS:**

1. Emission Level(dBuV/m) = Raw Value(dBuV) + Correction Factor(dB/m)
2. Correction Factor(dB/m) = Antenna Factor(dB/m) + Cable Factor(dB) – Pre-Amplifier Factor(dB)
3. The other emission levels were very low against the limit.
4. Margin value = Emission Level – Limit value
5. " \* ": Fundamental frequency.
6. " # ": The radiated frequency is out of the restricted band.

<b>CHANNEL</b>	TX Channel 106+138	<b>DETECTOR FUNCTION</b>	Peak (PK)
<b>FREQUENCY RANGE</b>	1GHz ~ 40GHz		Average (AV)

**ANTENNA POLARITY & TEST DISTANCE: HORIZONTAL AT 3 M**

NO.	FREQ. (MHz)	EMISSION LEVEL (dBuV/m)	LIMIT (dBuV/m)	MARGIN (dB)	ANTENNA HEIGHT (m)	TABLE ANGLE (Degree)	RAW VALUE (dBuV)	CORRECTION FACTOR (dB/m)
1	#5470.00	67.9 PK	74.0	-6.1	2.85 H	102	63.7	4.2
2	#5470.00	53.7 AV	54.0	-0.3	2.85 H	102	49.5	4.2
3	*5530.00	98.9 PK			2.85 H	102	94.7	4.2
4	*5530.00	89.4 AV			2.85 H	102	85.2	4.2
5	*5690.00	98.2 PK			2.72 H	108	93.7	4.5
6	*5690.00	88.2 AV			2.72 H	108	83.7	4.5
7	#5850.00	49.4 PK	74.0	-24.6	2.72 H	108	44.9	4.5
8	#5850.00	37.6 AV	54.0	-16.4	2.72 H	108	33.1	4.5
9	11060.00	45.8 PK	74.0	-28.2	1.55 H	245	31.9	13.9
10	11060.00	33.9 AV	54.0	-20.1	1.55 H	245	20.0	13.9
11	11380.00	46.0 PK	74.0	-28.0	1.64 H	221	32.4	13.6
12	11380.00	34.1 AV	54.0	-19.9	1.64 H	221	20.5	13.6
13	#16590.00	46.3 PK	74.0	-27.7	1.80 H	225	30.7	15.6
14	#16590.00	33.5 AV	54.0	-20.5	1.80 H	225	17.9	15.6
15	#17070.00	46.2 PK	74.0	-27.8	1.84 H	228	28.9	17.3
16	#17070.00	33.5 AV	54.0	-20.5	1.84 H	228	16.2	17.3

**ANTENNA POLARITY & TEST DISTANCE: VERTICAL AT 3 M**

NO.	FREQ. (MHz)	EMISSION LEVEL (dBuV/m)	LIMIT (dBuV/m)	MARGIN (dB)	ANTENNA HEIGHT (m)	TABLE ANGLE (Degree)	RAW VALUE (dBuV)	CORRECTION FACTOR (dB/m)
1	#5470.00	49.2 PK	74.0	-24.8	2.53 V	136	45.0	4.2
2	#5470.00	37.5 AV	54.0	-16.5	2.53 V	136	33.3	4.2
3	*5530.00	85.6 PK			2.53 V	136	81.4	4.2
4	*5530.00	75.2 AV			2.53 V	136	71.0	4.2
5	*5690.00	83.1 PK			2.32 V	165	78.6	4.5
6	*5690.00	72.8 AV			2.32 V	165	68.3	4.5
7	#5850.00	46.1 PK	74.0	-27.9	2.32 V	165	41.6	4.5
8	#5850.00	34.2 AV	54.0	-19.8	2.32 V	165	29.7	4.5
9	11060.00	45.6 PK	74.0	-28.4	1.85 V	218	31.7	13.9
10	11060.00	32.7 AV	54.0	-21.3	1.85 V	218	18.8	13.9
11	11380.00	45.0 PK	74.0	-29.0	1.81 V	221	31.4	13.6
12	11380.00	32.5 AV	54.0	-21.5	1.81 V	221	18.9	13.6
13	#16590.00	44.9 PK	74.0	-29.1	1.66 V	235	29.3	15.6
14	#16590.00	32.4 AV	54.0	-21.6	1.66 V	235	16.8	15.6
15	#17070.00	45.1 PK	74.0	-28.9	1.66 V	236	27.8	17.3
16	#17070.00	32.5 AV	54.0	-21.5	1.66 V	236	15.2	17.3

**REMARKS:**

1. Emission Level(dBuV/m) = Raw Value(dBuV) + Correction Factor(dB/m)
2. Correction Factor(dB/m) = Antenna Factor(dB/m) + Cable Factor(dB) – Pre-Amplifier Factor(dB)
3. The other emission levels were very low against the limit.
4. Margin value = Emission Level – Limit value
5. " \* ": Fundamental frequency.
6. " # ": The radiated frequency is out of the restricted band.

<b>CHANNEL</b>	TX Channel 106+155	<b>DETECTOR FUNCTION</b>	Peak (PK)
<b>FREQUENCY RANGE</b>	1GHz ~ 40GHz		Average (AV)

**ANTENNA POLARITY & TEST DISTANCE: HORIZONTAL AT 3 M**

NO.	FREQ. (MHz)	EMISSION LEVEL (dBuV/m)	LIMIT (dBuV/m)	MARGIN (dB)	ANTENNA HEIGHT (m)	TABLE ANGLE (Degree)	RAW VALUE (dBuV)	CORRECTION FACTOR (dB/m)
1	#5470.00	67.8 PK	74.0	-6.2	3.01 H	98	63.6	4.2
2	#5470.00	53.7 AV	54.0	-0.3	3.01 H	98	49.5	4.2
3	*5530.00	99.1 PK			3.01 H	98	94.9	4.2
4	*5530.00	89.3 AV			3.01 H	98	85.1	4.2
5	*5775.00	97.1 PK			2.83 H	107	92.7	4.4
6	*5775.00	87.2 AV			2.83 H	107	82.8	4.4
7	#5850.00	60.9 PK	74.0	-13.1	3.01 H	98	56.4	4.5
8	#5850.00	48.9 AV	54.0	-5.1	3.01 H	98	44.4	4.5
9	#6003.15	49.9 PK	68.2	-18.3	2.83 H	107	45.1	4.8
10	11060.00	45.8 PK	74.0	-28.2	1.54 H	234	31.9	13.9
11	11060.00	33.9 AV	54.0	-20.1	1.54 H	234	20.0	13.9
12	11550.00	46.8 PK	74.0	-27.2	1.57 H	217	33.3	13.5
13	11550.00	34.5 AV	54.0	-19.5	1.57 H	217	21.0	13.5
14	#16590.00	46.4 PK	74.0	-27.6	1.81 H	228	30.8	15.6
15	#16590.00	33.3 AV	54.0	-20.7	1.81 H	228	17.7	15.6
16	#17325.00	46.2 PK	74.0	-27.8	1.79 H	238	28.4	17.8
17	#17325.00	33.3 AV	54.0	-20.7	1.79 H	238	15.5	17.8

**ANTENNA POLARITY & TEST DISTANCE: VERTICAL AT 3 M**

NO.	FREQ. (MHz)	EMISSION LEVEL (dBuV/m)	LIMIT (dBuV/m)	MARGIN (dB)	ANTENNA HEIGHT (m)	TABLE ANGLE (Degree)	RAW VALUE (dBuV)	CORRECTION FACTOR (dB/m)
1	#5470.00	49.2 PK	74.0	-24.8	2.53 V	136	45.0	4.2
2	#5470.00	37.5 AV	54.0	-16.5	2.53 V	136	33.3	4.2
3	*5530.00	85.6 PK			2.53 V	136	81.4	4.2
4	*5530.00	75.2 AV			2.53 V	136	71.0	4.2
5	*5775.00	83.2 PK			2.30 V	150	78.8	4.4
6	*5775.00	74.2 AV			2.30 V	150	69.8	4.4
7	#5850.00	48.5 PK	74.0	-25.5	2.53 V	136	44.0	4.5
8	#5850.00	37.4 AV	54.0	-16.6	2.53 V	136	32.9	4.5
9	#5983.60	57.5 PK	68.2	-10.7	2.30 V	150	52.8	4.7
10	11060.00	45.5 PK	74.0	-28.5	1.78 V	242	31.6	13.9
11	11060.00	33.2 AV	54.0	-20.8	1.78 V	242	19.3	13.9
12	11550.00	46.4 PK	74.0	-27.6	1.79 V	257	32.9	13.5
13	11550.00	33.7 AV	54.0	-20.3	1.79 V	257	20.2	13.5
14	#16590.00	44.8 PK	74.0	-29.2	1.71 V	261	29.2	15.6
15	#16590.00	32.6 AV	54.0	-21.4	1.71 V	261	17.0	15.6
16	#17325.00	44.0 PK	74.0	-30.0	1.75 V	256	26.2	17.8
17	#17325.00	31.8 AV	54.0	-22.2	1.75 V	256	14.0	17.8

**REMARKS:**

1. Emission Level(dBuV/m) = Raw Value(dBuV) + Correction Factor(dB/m)
2. Correction Factor(dB/m) = Antenna Factor(dB/m) + Cable Factor(dB) – Pre-Amplifier Factor(dB)
3. The other emission levels were very low against the limit.
4. Margin value = Emission Level – Limit value
5. " \* ": Fundamental frequency.
6. " # ": The radiated frequency is out of the restricted band.



<b>CHANNEL</b>	TX Channel 122+138	<b>DETECTOR FUNCTION</b>	Peak (PK)
<b>FREQUENCY RANGE</b>	1GHz ~ 40GHz		Average (AV)

**ANTENNA POLARITY & TEST DISTANCE: HORIZONTAL AT 3 M**

NO.	FREQ. (MHz)	EMISSION LEVEL (dBuV/m)	LIMIT (dBuV/m)	MARGIN (dB)	ANTENNA HEIGHT (m)	TABLE ANGLE (Degree)	RAW VALUE (dBuV)	CORRECTION FACTOR (dB/m)
1	#5470.00	64.8 PK	74.0	-9.2	2.86 H	89	60.6	4.2
2	#5470.00	53.8 AV	54.0	-0.2	2.86 H	89	49.6	4.2
3	*5610.00	109.1 PK			2.67 H	94	104.7	4.4
4	*5610.00	99.1 AV			2.67 H	94	94.7	4.4
5	*5690.00	106.8 PK			2.86 H	89	102.3	4.5
6	*5690.00	96.8 AV			2.86 H	89	92.3	4.5
7	#5850.00	57.5 PK	74.0	-16.5	2.86 H	89	53.0	4.5
8	#5850.00	45.1 AV	54.0	-8.9	2.86 H	89	40.6	4.5
9	11220.00	46.4 PK	74.0	-27.6	1.61 H	217	32.7	13.7
10	11220.00	34.4 AV	54.0	-19.6	1.61 H	217	20.7	13.7
11	11380.00	46.0 PK	74.0	-28.0	1.56 H	248	32.4	13.6
12	11380.00	34.1 AV	54.0	-19.9	1.56 H	248	20.5	13.6
13	#16830.00	46.0 PK	74.0	-28.0	1.78 H	229	30.1	15.9
14	#16830.00	33.1 AV	54.0	-20.9	1.78 H	229	17.2	15.9
15	#17070.00	46.3 PK	74.0	-27.7	1.88 H	241	29.0	17.3
16	#17070.00	33.7 AV	54.0	-20.3	1.88 H	241	16.4	17.3

**ANTENNA POLARITY & TEST DISTANCE: VERTICAL AT 3 M**

NO.	FREQ. (MHz)	EMISSION LEVEL (dBuV/m)	LIMIT (dBuV/m)	MARGIN (dB)	ANTENNA HEIGHT (m)	TABLE ANGLE (Degree)	RAW VALUE (dBuV)	CORRECTION FACTOR (dB/m)
1	#5470.00	48.6 PK	74.0	-25.4	2.50 V	133	44.4	4.2
2	#5470.00	36.5 AV	54.0	-17.5	2.50 V	133	32.3	4.2
3	*5610.00	92.9 PK			2.50 V	133	88.5	4.4
4	*5610.00	84.9 AV			2.50 V	133	80.5	4.4
5	*5690.00	91.2 PK			2.32 V	148	86.7	4.5
6	*5690.00	81.6 AV			2.32 V	148	77.1	4.5
7	#5850.00	44.1 PK	74.0	-29.9	2.32 V	148	39.6	4.5
8	#5850.00	31.9 AV	54.0	-22.1	2.32 V	148	27.4	4.5
9	11220.00	45.1 PK	74.0	-28.9	1.88 V	242	31.4	13.7
10	11220.00	32.5 AV	54.0	-21.5	1.88 V	242	18.8	13.7
11	11380.00	45.3 PK	74.0	-28.7	1.92 V	223	31.7	13.6
12	11380.00	32.7 AV	54.0	-21.3	1.92 V	223	19.1	13.6
13	#16830.00	44.9 PK	74.0	-29.1	1.70 V	249	29.0	15.9
14	#16830.00	32.6 AV	54.0	-21.4	1.70 V	249	16.7	15.9
15	#17070.00	44.8 PK	74.0	-29.2	1.73 V	248	27.5	17.3
16	#17070.00	32.1 AV	54.0	-21.9	1.73 V	248	14.8	17.3

**REMARKS:**

1. Emission Level(dBuV/m) = Raw Value(dBuV) + Correction Factor(dB/m)
2. Correction Factor(dB/m) = Antenna Factor(dB/m) + Cable Factor(dB) – Pre-Amplifier Factor(dB)
3. The other emission levels were very low against the limit.
4. Margin value = Emission Level – Limit value
5. " \* ": Fundamental frequency.
6. " # ": The radiated frequency is out of the restricted band.

<b>CHANNEL</b>	TX Channel 122+155	<b>DETECTOR FUNCTION</b>	Peak (PK)
<b>FREQUENCY RANGE</b>	1GHz ~ 40GHz		Average (AV)

**ANTENNA POLARITY & TEST DISTANCE: HORIZONTAL AT 3 M**

NO.	FREQ. (MHz)	EMISSION LEVEL (dBuV/m)	LIMIT (dBuV/m)	MARGIN (dB)	ANTENNA HEIGHT (m)	TABLE ANGLE (Degree)	RAW VALUE (dBuV)	CORRECTION FACTOR (dB/m)
1	#5470.00	65.1 PK	74.0	-8.9	2.88 H	101	60.9	4.2
2	#5470.00	53.7 AV	54.0	-0.3	2.88 H	101	49.5	4.2
3	*5610.00	108.9 PK			2.88 H	101	104.5	4.4
4	*5610.00	98.8 AV			2.88 H	101	94.4	4.4
5	*5775.00	103.4 PK			2.89 H	90	99.0	4.4
6	*5775.00	93.5 AV			2.89 H	90	89.1	4.4
7	#5933.24	60.0 PK	68.2	-8.2	2.89 H	90	55.3	4.7
8	11220.00	46.7 PK	74.0	-27.3	1.56 H	240	33.0	13.7
9	11220.00	34.6 AV	54.0	-19.4	1.56 H	240	20.9	13.7
10	11550.00	47.2 PK	74.0	-26.8	1.58 H	221	33.7	13.5
11	11550.00	34.9 AV	54.0	-19.1	1.58 H	221	21.4	13.5
12	#16830.00	45.8 PK	74.0	-28.2	1.82 H	229	29.9	15.9
13	#16830.00	33.0 AV	54.0	-21.0	1.82 H	229	17.1	15.9
14	#17325.00	45.6 PK	74.0	-28.4	1.84 H	243	27.8	17.8
15	#17325.00	33.1 AV	54.0	-20.9	1.84 H	243	15.3	17.8

**ANTENNA POLARITY & TEST DISTANCE: VERTICAL AT 3 M**

NO.	FREQ. (MHz)	EMISSION LEVEL (dBuV/m)	LIMIT (dBuV/m)	MARGIN (dB)	ANTENNA HEIGHT (m)	TABLE ANGLE (Degree)	RAW VALUE (dBuV)	CORRECTION FACTOR (dB/m)
1	#5470.00	48.6 PK	74.0	-25.4	2.50 V	133	44.4	4.2
2	#5470.00	36.5 AV	54.0	-17.5	2.50 V	133	32.3	4.2
3	*5610.00	92.9 PK			2.50 V	133	88.5	4.4
4	*5610.00	84.9 AV			2.50 V	133	80.5	4.4
5	*5775.00	93.2 PK			2.52 V	152	88.8	4.4
6	*5775.00	83.0 AV			2.52 V	152	78.6	4.4
7	#5927.67	57.2 PK	68.2	-11.0	2.52 V	152	52.5	4.7
8	11220.00	46.3 PK	74.0	-27.7	1.80 V	233	32.6	13.7
9	11220.00	33.7 AV	54.0	-20.3	1.80 V	233	20.0	13.7
10	11550.00	46.0 PK	74.0	-28.0	1.80 V	244	32.5	13.5
11	11550.00	33.7 AV	54.0	-20.3	1.80 V	244	20.2	13.5
12	#16830.00	45.0 PK	74.0	-29.0	1.77 V	268	29.1	15.9
13	#16830.00	32.4 AV	54.0	-21.6	1.77 V	268	16.5	15.9
14	#17325.00	44.5 PK	74.0	-29.5	1.73 V	270	26.7	17.8
15	#17325.00	31.9 AV	54.0	-22.1	1.73 V	270	14.1	17.8

**REMARKS:**

1. Emission Level(dBuV/m) = Raw Value(dBuV) + Correction Factor(dB/m)
2. Correction Factor(dB/m) = Antenna Factor(dB/m) + Cable Factor(dB) – Pre-Amplifier Factor(dB)
3. The other emission levels were very low against the limit.
4. Margin value = Emission Level – Limit value
5. " \* ": Fundamental frequency.
6. " # ": The radiated frequency is out of the restricted band.

<b>CHANNEL</b>	TX Channel 138+155	<b>DETECTOR FUNCTION</b>	Peak (PK)
<b>FREQUENCY RANGE</b>	1GHz ~ 40GHz		Average (AV)

**ANTENNA POLARITY & TEST DISTANCE: HORIZONTAL AT 3 M**

NO.	FREQ. (MHz)	EMISSION LEVEL (dBuV/m)	LIMIT (dBuV/m)	MARGIN (dB)	ANTENNA HEIGHT (m)	TABLE ANGLE (Degree)	RAW VALUE (dBuV)	CORRECTION FACTOR (dB/m)
1	#5470.00	56.4 PK	74.0	-17.6	3.35 H	99	52.2	4.2
2	#5470.00	44.6 AV	54.0	-9.4	3.35 H	99	40.4	4.2
3	*5690.00	110.6 PK			3.35 H	99	106.1	4.5
4	*5690.00	100.2 AV			3.35 H	99	95.7	4.5
5	*5775.00	107.2 PK			2.53 H	88	102.8	4.4
6	*5775.00	96.3 AV			2.53 H	88	91.9	4.4
7	#5924.29	63.0 PK	68.7	-5.7	2.53 H	88	58.3	4.7
8	11380.00	47.1 PK	74.0	-26.9	1.55 H	221	33.5	13.6
9	11380.00	34.8 AV	54.0	-19.2	1.55 H	221	21.2	13.6
10	11550.00	46.3 PK	74.0	-27.7	1.55 H	234	32.8	13.5
11	11550.00	34.0 AV	54.0	-20.0	1.55 H	234	20.5	13.5
12	#17070.00	45.8 PK	74.0	-28.2	1.83 H	239	28.5	17.3
13	#17070.00	32.9 AV	54.0	-21.1	1.83 H	239	15.6	17.3
14	#17325.00	46.6 PK	74.0	-27.4	1.83 H	239	28.8	17.8
15	#17325.00	33.7 AV	54.0	-20.3	1.83 H	239	15.9	17.8

**ANTENNA POLARITY & TEST DISTANCE: VERTICAL AT 3 M**

NO.	FREQ. (MHz)	EMISSION LEVEL (dBuV/m)	LIMIT (dBuV/m)	MARGIN (dB)	ANTENNA HEIGHT (m)	TABLE ANGLE (Degree)	RAW VALUE (dBuV)	CORRECTION FACTOR (dB/m)
1	#5470.00	48.6 PK	74.0	-25.4	2.64 V	145	44.4	4.2
2	#5470.00	35.8 AV	54.0	-18.2	2.64 V	145	31.6	4.2
3	*5690.00	97.3 PK			2.64 V	145	92.8	4.5
4	*5690.00	87.4 AV			2.64 V	145	82.9	4.5
5	*5775.00	94.4 PK			2.38 V	152	90.0	4.4
6	*5775.00	84.4 AV			2.38 V	152	80.0	4.4
7	#5920.95	54.1 PK	71.2	-17.1	2.38 V	152	49.4	4.7
8	11380.00	45.6 PK	74.0	-28.4	1.89 V	248	32.0	13.6
9	11380.00	33.2 AV	54.0	-20.8	1.89 V	248	19.6	13.6
10	11550.00	45.6 PK	74.0	-28.4	1.88 V	247	32.1	13.5
11	11550.00	33.4 AV	54.0	-20.6	1.88 V	247	19.9	13.5
12	#17070.00	44.7 PK	74.0	-29.3	1.66 V	262	27.4	17.3
13	#17070.00	32.1 AV	54.0	-21.9	1.66 V	262	14.8	17.3
14	#17325.00	44.6 PK	74.0	-29.4	1.74 V	248	26.8	17.8
15	#17325.00	32.4 AV	54.0	-21.6	1.74 V	248	14.6	17.8

**REMARKS:**

1. Emission Level(dBuV/m) = Raw Value(dBuV) + Correction Factor(dB/m)
2. Correction Factor(dB/m) = Antenna Factor(dB/m) + Cable Factor(dB) – Pre-Amplifier Factor(dB)
3. The other emission levels were very low against the limit.
4. Margin value = Emission Level – Limit value
5. " \* ": Fundamental frequency.
6. " # ": The radiated frequency is out of the restricted band.

## 4.1.10 Test Results (Mode 4)

## Above 1GHz Data:

## 802.11a

<b>CHANNEL</b>	TX Channel 52	<b>DETECTOR FUNCTION</b>	Peak (PK)
<b>FREQUENCY RANGE</b>	1GHz ~ 40GHz		Average (AV)

**ANTENNA POLARITY & TEST DISTANCE: HORIZONTAL AT 3 M**

NO.	FREQ. (MHz)	EMISSION LEVEL (dBuV/m)	LIMIT (dBuV/m)	MARGIN (dB)	ANTENNA HEIGHT (m)	TABLE ANGLE (Degree)	RAW VALUE (dBuV)	CORRECTION FACTOR (dB/m)
1	5150.00	47.8 PK	74.0	-26.2	3.01 H	104	44.1	3.7
2	5150.00	36.7 AV	54.0	-17.3	3.01 H	104	33.0	3.7
3	*5260.00	114.8 PK			3.01 H	104	110.8	4.0
4	*5260.00	104.5 AV			3.01 H	104	100.5	4.0
5	5350.00	49.2 PK	74.0	-24.8	3.01 H	104	45.1	4.1
6	5350.00	38.2 AV	54.0	-15.8	3.01 H	104	34.1	4.1
7	#10520.00	45.4 PK	74.0	-28.6	1.77 H	211	32.2	13.2
8	#10520.00	33.6 AV	54.0	-20.4	1.77 H	211	20.4	13.2
9	15780.00	46.2 PK	74.0	-27.8	1.42 H	197	32.6	13.6
10	15780.00	33.6 AV	54.0	-20.4	1.42 H	197	20.0	13.6

**ANTENNA POLARITY & TEST DISTANCE: VERTICAL AT 3 M**

NO.	FREQ. (MHz)	EMISSION LEVEL (dBuV/m)	LIMIT (dBuV/m)	MARGIN (dB)	ANTENNA HEIGHT (m)	TABLE ANGLE (Degree)	RAW VALUE (dBuV)	CORRECTION FACTOR (dB/m)
1	5150.00	47.4 PK	74.0	-26.6	2.59 V	348	43.7	3.7
2	5150.00	36.1 AV	54.0	-17.9	2.59 V	348	32.4	3.7
3	*5260.00	105.4 PK			2.59 V	348	101.4	4.0
4	*5260.00	95.3 AV			2.59 V	348	91.3	4.0
5	5350.00	48.4 PK	74.0	-25.6	2.59 V	348	44.3	4.1
6	5350.00	36.3 AV	54.0	-17.7	2.59 V	348	32.2	4.1
7	#10520.00	46.2 PK	74.0	-27.8	1.00 V	127	33.0	13.2
8	#10520.00	33.5 AV	54.0	-20.5	1.00 V	127	20.3	13.2
9	15780.00	46.9 PK	74.0	-27.1	1.00 V	161	33.3	13.6
10	15780.00	34.4 AV	54.0	-19.6	1.00 V	161	20.8	13.6

**REMARKS:**

1. Emission Level(dBuV/m) = Raw Value(dBuV) + Correction Factor(dB/m)
2. Correction Factor(dB/m) = Antenna Factor(dB/m) + Cable Factor(dB) – Pre-Amplifier Factor(dB)
3. The other emission levels were very low against the limit.
4. Margin value = Emission Level – Limit value
5. " \* ": Fundamental frequency.
6. " # ": The radiated frequency is out of the restricted band.

<b>CHANNEL</b>	TX Channel 60	<b>DETECTOR FUNCTION</b>	Peak (PK)
<b>FREQUENCY RANGE</b>	1GHz ~ 40GHz		Average (AV)

**ANTENNA POLARITY & TEST DISTANCE: HORIZONTAL AT 3 M**

NO.	FREQ. (MHz)	EMISSION LEVEL (dBuV/m)	LIMIT (dBuV/m)	MARGIN (dB)	ANTENNA HEIGHT (m)	TABLE ANGLE (Degree)	RAW VALUE (dBuV)	CORRECTION FACTOR (dB/m)
1	5150.00	48.2 PK	74.0	-25.8	3.41 H	119	44.5	3.7
2	5150.00	37.6 AV	54.0	-16.4	3.41 H	119	33.9	3.7
3	*5300.00	115.6 PK			3.41 H	119	111.5	4.1
4	*5300.00	105.0 AV			3.41 H	119	100.9	4.1
5	5350.00	62.6 PK	74.0	-11.4	3.41 H	119	58.5	4.1
6	5350.00	49.1 AV	54.0	-4.9	3.41 H	119	45.0	4.1
7	10600.00	45.8 PK	74.0	-28.2	1.78 H	211	32.3	13.5
8	10600.00	34.0 AV	54.0	-20.0	1.78 H	211	20.5	13.5
9	15900.00	46.5 PK	74.0	-27.5	1.39 H	187	33.6	12.9
10	15900.00	33.9 AV	54.0	-20.1	1.39 H	187	21.0	12.9

**ANTENNA POLARITY & TEST DISTANCE: VERTICAL AT 3 M**

NO.	FREQ. (MHz)	EMISSION LEVEL (dBuV/m)	LIMIT (dBuV/m)	MARGIN (dB)	ANTENNA HEIGHT (m)	TABLE ANGLE (Degree)	RAW VALUE (dBuV)	CORRECTION FACTOR (dB/m)
1	5150.00	43.9 PK	74.0	-30.1	2.63 V	347	40.2	3.7
2	5150.00	34.4 AV	54.0	-19.6	2.63 V	347	30.7	3.7
3	*5300.00	106.2 PK			2.63 V	347	102.1	4.1
4	*5300.00	95.8 AV			2.63 V	347	91.7	4.1
5	5350.00	55.9 PK	74.0	-18.1	2.63 V	347	51.8	4.1
6	5350.00	43.7 AV	54.0	-10.3	2.63 V	347	39.6	4.1
7	10600.00	46.5 PK	74.0	-27.5	1.00 V	125	33.0	13.5
8	10600.00	33.6 AV	54.0	-20.4	1.00 V	125	20.1	13.5
9	15900.00	46.7 PK	74.0	-27.3	1.00 V	174	33.8	12.9
10	15900.00	34.0 AV	54.0	-20.0	1.00 V	174	21.1	12.9

**REMARKS:**

1. Emission Level(dBuV/m) = Raw Value(dBuV) + Correction Factor(dB/m)
2. Correction Factor(dB/m) = Antenna Factor(dB/m) + Cable Factor(dB) – Pre-Amplifier Factor(dB)
3. The other emission levels were very low against the limit.
4. Margin value = Emission Level – Limit value
5. " \* ": Fundamental frequency.

<b>CHANNEL</b>	TX Channel 64	<b>DETECTOR FUNCTION</b>	Peak (PK)
<b>FREQUENCY RANGE</b>	1GHz ~ 40GHz		Average (AV)

**ANTENNA POLARITY & TEST DISTANCE: HORIZONTAL AT 3 M**

NO.	FREQ. (MHz)	EMISSION LEVEL (dBuV/m)	LIMIT (dBuV/m)	MARGIN (dB)	ANTENNA HEIGHT (m)	TABLE ANGLE (Degree)	RAW VALUE (dBuV)	CORRECTION FACTOR (dB/m)
1	*5320.00	111.7 PK			3.42 H	115	107.6	4.1
2	*5320.00	101.4 AV			3.42 H	115	97.3	4.1
3	5350.00	67.9 PK	74.0	-6.1	3.42 H	115	63.8	4.1
4	5350.00	53.8 AV	54.0	-0.2	3.42 H	115	49.7	4.1
5	10640.00	45.0 PK	74.0	-29.0	1.74 H	202	31.5	13.5
6	10640.00	33.3 AV	54.0	-20.7	1.74 H	202	19.8	13.5
7	15960.00	46.3 PK	74.0	-27.7	1.44 H	199	33.4	12.9
8	15960.00	33.5 AV	54.0	-20.5	1.44 H	199	20.6	12.9

**ANTENNA POLARITY & TEST DISTANCE: VERTICAL AT 3 M**

NO.	FREQ. (MHz)	EMISSION LEVEL (dBuV/m)	LIMIT (dBuV/m)	MARGIN (dB)	ANTENNA HEIGHT (m)	TABLE ANGLE (Degree)	RAW VALUE (dBuV)	CORRECTION FACTOR (dB/m)
1	*5320.00	102.3 PK			2.60 V	359	98.2	4.1
2	*5320.00	92.2 AV			2.60 V	359	88.1	4.1
3	5350.00	60.5 PK	74.0	-13.5	2.60 V	359	56.4	4.1
4	5350.00	47.3 AV	54.0	-6.7	2.60 V	359	43.2	4.1
5	10640.00	46.1 PK	74.0	-27.9	1.00 V	124	32.6	13.5
6	10640.00	33.2 AV	54.0	-20.8	1.00 V	124	19.7	13.5
7	15960.00	47.2 PK	74.0	-26.8	1.00 V	161	34.3	12.9
8	15960.00	34.2 AV	54.0	-19.8	1.00 V	161	21.3	12.9

**REMARKS:**

1. Emission Level(dBuV/m) = Raw Value(dBuV) + Correction Factor(dB/m)
2. Correction Factor(dB/m) = Antenna Factor(dB/m) + Cable Factor(dB) – Pre-Amplifier Factor(dB)
3. The other emission levels were very low against the limit.
4. Margin value = Emission Level – Limit value
5. " \* ": Fundamental frequency.

<b>CHANNEL</b>	TX Channel 100	<b>DETECTOR FUNCTION</b>	Peak (PK)
<b>FREQUENCY RANGE</b>	1GHz ~ 40GHz		Average (AV)

**ANTENNA POLARITY & TEST DISTANCE: HORIZONTAL AT 3 M**

NO.	FREQ. (MHz)	EMISSION LEVEL (dBuV/m)	LIMIT (dBuV/m)	MARGIN (dB)	ANTENNA HEIGHT (m)	TABLE ANGLE (Degree)	RAW VALUE (dBuV)	CORRECTION FACTOR (dB/m)
1	#5470.00	68.0 PK	74.0	-6.0	3.35 H	98	63.8	4.2
2	#5470.00	53.8 AV	54.0	-0.2	3.35 H	98	49.6	4.2
3	*5500.00	111.5 PK			3.35 H	98	107.3	4.2
4	*5500.00	100.6 AV			3.35 H	98	96.4	4.2
5	11000.00	45.4 PK	74.0	-28.6	1.77 H	226	31.3	14.1
6	11000.00	33.8 AV	54.0	-20.2	1.77 H	226	19.7	14.1
7	#16500.00	46.1 PK	74.0	-27.9	1.47 H	195	31.6	14.5
8	#16500.00	33.7 AV	54.0	-20.3	1.47 H	195	19.2	14.5

**ANTENNA POLARITY & TEST DISTANCE: VERTICAL AT 3 M**

NO.	FREQ. (MHz)	EMISSION LEVEL (dBuV/m)	LIMIT (dBuV/m)	MARGIN (dB)	ANTENNA HEIGHT (m)	TABLE ANGLE (Degree)	RAW VALUE (dBuV)	CORRECTION FACTOR (dB/m)
1	#5470.00	57.9 PK	74.0	-16.1	2.62 V	337	53.7	4.2
2	#5470.00	47.4 AV	54.0	-6.6	2.62 V	337	43.2	4.2
3	*5500.00	102.1 PK			2.62 V	337	97.9	4.2
4	*5500.00	91.4 AV			2.62 V	337	87.2	4.2
5	11000.00	45.8 PK	74.0	-28.2	1.00 V	124	31.7	14.1
6	11000.00	33.1 AV	54.0	-20.9	1.00 V	124	19.0	14.1
7	#16500.00	47.0 PK	74.0	-27.0	1.00 V	169	32.5	14.5
8	#16500.00	34.2 AV	54.0	-19.8	1.00 V	169	19.7	14.5

**REMARKS:**

1. Emission Level(dBuV/m) = Raw Value(dBuV) + Correction Factor(dB/m)
2. Correction Factor(dB/m) = Antenna Factor(dB/m) + Cable Factor(dB) – Pre-Amplifier Factor(dB)
3. The other emission levels were very low against the limit.
4. Margin value = Emission Level – Limit value
5. " \* ": Fundamental frequency.
6. " # ": The radiated frequency is out of the restricted band.

<b>CHANNEL</b>	TX Channel 116	<b>DETECTOR FUNCTION</b>	Peak (PK)
<b>FREQUENCY RANGE</b>	1GHz ~ 40GHz		Average (AV)

**ANTENNA POLARITY & TEST DISTANCE: HORIZONTAL AT 3 M**

NO.	FREQ. (MHz)	EMISSION LEVEL (dBuV/m)	LIMIT (dBuV/m)	MARGIN (dB)	ANTENNA HEIGHT (m)	TABLE ANGLE (Degree)	RAW VALUE (dBuV)	CORRECTION FACTOR (dB/m)
1	#5470.00	49.5 PK	74.0	-24.5	3.30 H	100	45.3	4.2
2	#5470.00	37.7 AV	54.0	-16.3	3.30 H	100	33.5	4.2
3	*5580.00	114.9 PK			3.30 H	100	110.7	4.2
4	*5580.00	105.0 AV			3.30 H	100	100.8	4.2
5	#5725.00	49.9 PK	74.0	-24.1	3.30 H	100	45.5	4.4
6	#5725.00	37.9 AV	54.0	-16.1	3.30 H	100	33.5	4.4
7	11160.00	45.5 PK	74.0	-28.5	1.76 H	205	31.8	13.7
8	11160.00	33.6 AV	54.0	-20.4	1.76 H	205	19.9	13.7
9	#16740.00	46.4 PK	74.0	-27.6	1.39 H	205	30.7	15.7
10	#16740.00	33.9 AV	54.0	-20.1	1.39 H	205	18.2	15.7

**ANTENNA POLARITY & TEST DISTANCE: VERTICAL AT 3 M**

NO.	FREQ. (MHz)	EMISSION LEVEL (dBuV/m)	LIMIT (dBuV/m)	MARGIN (dB)	ANTENNA HEIGHT (m)	TABLE ANGLE (Degree)	RAW VALUE (dBuV)	CORRECTION FACTOR (dB/m)
1	#5470.00	46.7 PK	74.0	-27.3	2.62 V	327	42.5	4.2
2	#5470.00	34.6 AV	54.0	-19.4	2.62 V	327	30.4	4.2
3	*5580.00	105.5 PK			2.62 V	327	101.3	4.2
4	*5580.00	95.8 AV			2.62 V	327	91.6	4.2
5	#5725.00	46.8 PK	74.0	-27.2	2.62 V	327	42.4	4.4
6	#5725.00	34.8 AV	54.0	-19.2	2.62 V	327	30.4	4.4
7	11160.00	46.5 PK	74.0	-27.5	1.00 V	135	32.8	13.7
8	11160.00	33.3 AV	54.0	-20.7	1.00 V	135	19.6	13.7
9	#16740.00	46.5 PK	74.0	-27.5	1.00 V	181	30.8	15.7
10	#16740.00	34.0 AV	54.0	-20.0	1.00 V	181	18.3	15.7

**REMARKS:**

1. Emission Level(dBuV/m) = Raw Value(dBuV) + Correction Factor(dB/m)
2. Correction Factor(dB/m) = Antenna Factor(dB/m) + Cable Factor(dB) – Pre-Amplifier Factor(dB)
3. The other emission levels were very low against the limit.
4. Margin value = Emission Level – Limit value
5. " \* ": Fundamental frequency.
6. " # ": The radiated frequency is out of the restricted band.



<b>CHANNEL</b>	TX Channel 140	<b>DETECTOR FUNCTION</b>	Peak (PK)
<b>FREQUENCY RANGE</b>	1GHz ~ 40GHz		Average (AV)

**ANTENNA POLARITY & TEST DISTANCE: HORIZONTAL AT 3 M**

NO.	FREQ. (MHz)	EMISSION LEVEL (dBuV/m)	LIMIT (dBuV/m)	MARGIN (dB)	ANTENNA HEIGHT (m)	TABLE ANGLE (Degree)	RAW VALUE (dBuV)	CORRECTION FACTOR (dB/m)
1	*5700.00	110.2 PK			3.32 H	103	105.7	4.5
2	*5700.00	99.7 AV			3.32 H	103	95.2	4.5
3	#5725.00	68.0 PK	74.0	-6.0	3.32 H	103	63.6	4.4
4	#5725.00	53.7 AV	54.0	-0.3	3.32 H	103	49.3	4.4
5	11400.00	45.3 PK	74.0	-28.7	1.83 H	201	31.7	13.6
6	11400.00	33.6 AV	54.0	-20.4	1.83 H	201	20.0	13.6
7	#17100.00	46.3 PK	74.0	-27.7	1.37 H	192	28.9	17.4
8	#17100.00	34.0 AV	54.0	-20.0	1.37 H	192	16.6	17.4

**ANTENNA POLARITY & TEST DISTANCE: VERTICAL AT 3 M**

NO.	FREQ. (MHz)	EMISSION LEVEL (dBuV/m)	LIMIT (dBuV/m)	MARGIN (dB)	ANTENNA HEIGHT (m)	TABLE ANGLE (Degree)	RAW VALUE (dBuV)	CORRECTION FACTOR (dB/m)
1	*5700.00	100.8 PK			2.61 V	339	96.3	4.5
2	*5700.00	90.5 AV			2.61 V	339	86.0	4.5
3	#5725.00	57.9 PK	74.0	-16.1	2.61 V	339	53.5	4.4
4	#5725.00	47.3 AV	54.0	-6.7	2.61 V	339	42.9	4.4
5	11400.00	47.0 PK	74.0	-27.0	1.00 V	112	33.4	13.6
6	11400.00	34.0 AV	54.0	-20.0	1.00 V	112	20.4	13.6
7	#17100.00	47.4 PK	74.0	-26.6	1.00 V	184	30.0	17.4
8	#17100.00	34.5 AV	54.0	-19.5	1.00 V	184	17.1	17.4

**REMARKS:**

1. Emission Level(dBuV/m) = Raw Value(dBuV) + Correction Factor(dB/m)
2. Correction Factor(dB/m) = Antenna Factor(dB/m) + Cable Factor(dB) – Pre-Amplifier Factor(dB)
3. The other emission levels were very low against the limit.
4. Margin value = Emission Level – Limit value
5. " \* ": Fundamental frequency.
6. " # ": The radiated frequency is out of the restricted band.

<b>CHANNEL</b>	TX Channel 144	<b>DETECTOR FUNCTION</b>	Peak (PK)
<b>FREQUENCY RANGE</b>	1GHz ~ 40GHz		Average (AV)

**ANTENNA POLARITY & TEST DISTANCE: HORIZONTAL AT 3 M**

NO.	FREQ. (MHz)	EMISSION LEVEL (dBuV/m)	LIMIT (dBuV/m)	MARGIN (dB)	ANTENNA HEIGHT (m)	TABLE ANGLE (Degree)	RAW VALUE (dBuV)	CORRECTION FACTOR (dB/m)
1	#5470.00	48.5 PK	74.0	-25.5	3.08 H	93	44.3	4.2
2	#5470.00	36.2 AV	54.0	-17.8	3.08 H	93	32.0	4.2
3	*5720.00	116.5 PK			3.08 H	93	112.1	4.4
4	*5720.00	105.7 AV			3.08 H	93	101.3	4.4
5	#5850.00	48.7 PK	74.0	-25.3	3.08 H	93	44.2	4.5
6	#5850.00	36.9 AV	54.0	-17.1	3.08 H	93	32.4	4.5
7	11440.00	45.5 PK	74.0	-28.5	1.71 H	216	32.0	13.5
8	11440.00	33.6 AV	54.0	-20.4	1.71 H	216	20.1	13.5
9	#17160.00	46.6 PK	74.0	-27.4	1.45 H	192	29.3	17.3
10	#17160.00	33.7 AV	54.0	-20.3	1.45 H	192	16.4	17.3

**ANTENNA POLARITY & TEST DISTANCE: VERTICAL AT 3 M**

NO.	FREQ. (MHz)	EMISSION LEVEL (dBuV/m)	LIMIT (dBuV/m)	MARGIN (dB)	ANTENNA HEIGHT (m)	TABLE ANGLE (Degree)	RAW VALUE (dBuV)	CORRECTION FACTOR (dB/m)
1	#5470.00	45.5 PK	74.0	-28.5	2.65 V	341	41.3	4.2
2	#5470.00	33.1 AV	54.0	-20.9	2.65 V	341	28.9	4.2
3	*5720.00	107.1 PK			2.65 V	341	102.7	4.4
4	*5720.00	96.5 AV			2.65 V	341	92.1	4.4
5	#5850.00	45.6 PK	74.0	-28.4	2.65 V	341	41.1	4.5
6	#5850.00	33.8 AV	54.0	-20.2	2.65 V	341	29.3	4.5
7	11440.00	46.0 PK	74.0	-28.0	1.00 V	119	32.5	13.5
8	11440.00	33.2 AV	54.0	-20.8	1.00 V	119	19.7	13.5
9	#17160.00	46.3 PK	74.0	-27.7	1.00 V	189	29.0	17.3
10	#17160.00	33.7 AV	54.0	-20.3	1.00 V	189	16.4	17.3

**REMARKS:**

1. Emission Level(dBuV/m) = Raw Value(dBuV) + Correction Factor(dB/m)
2. Correction Factor(dB/m) = Antenna Factor(dB/m) + Cable Factor(dB) – Pre-Amplifier Factor(dB)
3. The other emission levels were very low against the limit.
4. Margin value = Emission Level – Limit value
5. " \* ": Fundamental frequency.
6. " # ": The radiated frequency is out of the restricted band.

**802.11ac (VHT20)**

<b>CHANNEL</b>	TX Channel 52	<b>DETECTOR FUNCTION</b>	Peak (PK)
<b>FREQUENCY RANGE</b>	1GHz ~ 40GHz		Average (AV)

**ANTENNA POLARITY & TEST DISTANCE: HORIZONTAL AT 3 M**

NO.	FREQ. (MHz)	EMISSION LEVEL (dBuV/m)	LIMIT (dBuV/m)	MARGIN (dB)	ANTENNA HEIGHT (m)	TABLE ANGLE (Degree)	RAW VALUE (dBuV)	CORRECTION FACTOR (dB/m)
1	5150.00	48.7 PK	74.0	-25.3	2.64 H	107	45.0	3.7
2	5150.00	36.0 AV	54.0	-18.0	2.64 H	107	32.3	3.7
3	*5260.00	116.1 PK			2.64 H	107	112.1	4.0
4	*5260.00	105.3 AV			2.64 H	107	101.3	4.0
5	5350.00	49.7 PK	74.0	-24.3	2.64 H	107	45.6	4.1
6	5350.00	37.2 AV	54.0	-16.8	2.64 H	107	33.1	4.1
7	#10520.00	45.5 PK	74.0	-28.5	1.80 H	224	32.3	13.2
8	#10520.00	33.7 AV	54.0	-20.3	1.80 H	224	20.5	13.2
9	15780.00	45.5 PK	74.0	-28.5	1.46 H	205	31.9	13.6
10	15780.00	33.2 AV	54.0	-20.8	1.46 H	205	19.6	13.6

**ANTENNA POLARITY & TEST DISTANCE: VERTICAL AT 3 M**

NO.	FREQ. (MHz)	EMISSION LEVEL (dBuV/m)	LIMIT (dBuV/m)	MARGIN (dB)	ANTENNA HEIGHT (m)	TABLE ANGLE (Degree)	RAW VALUE (dBuV)	CORRECTION FACTOR (dB/m)
1	5150.00	45.3 PK	74.0	-28.7	2.62 V	355	41.6	3.7
2	5150.00	32.9 AV	54.0	-21.1	2.62 V	355	29.2	3.7
3	*5260.00	106.7 PK			2.62 V	355	102.7	4.0
4	*5260.00	96.1 AV			2.62 V	355	92.1	4.0
5	5350.00	46.3 PK	74.0	-27.7	2.62 V	355	42.2	4.1
6	5350.00	34.1 AV	54.0	-19.9	2.62 V	355	30.0	4.1
7	#10520.00	47.1 PK	74.0	-26.9	1.00 V	115	33.9	13.2
8	#10520.00	34.0 AV	54.0	-20.0	1.00 V	115	20.8	13.2
9	15780.00	47.0 PK	74.0	-27.0	1.00 V	169	33.4	13.6
10	15780.00	34.1 AV	54.0	-19.9	1.00 V	169	20.5	13.6

**REMARKS:**

1. Emission Level(dBuV/m) = Raw Value(dBuV) + Correction Factor(dB/m)
2. Correction Factor(dB/m) = Antenna Factor(dB/m) + Cable Factor(dB) – Pre-Amplifier Factor(dB)
3. The other emission levels were very low against the limit.
4. Margin value = Emission Level – Limit value
5. " \* ": Fundamental frequency.
6. " # ": The radiated frequency is out of the restricted band.

<b>CHANNEL</b>	TX Channel 60	<b>DETECTOR FUNCTION</b>	Peak (PK)
<b>FREQUENCY RANGE</b>	1GHz ~ 40GHz		Average (AV)

**ANTENNA POLARITY & TEST DISTANCE: HORIZONTAL AT 3 M**

NO.	FREQ. (MHz)	EMISSION LEVEL (dBuV/m)	LIMIT (dBuV/m)	MARGIN (dB)	ANTENNA HEIGHT (m)	TABLE ANGLE (Degree)	RAW VALUE (dBuV)	CORRECTION FACTOR (dB/m)
1	5150.00	48.3 PK	74.0	-25.7	2.71 H	105	44.6	3.7
2	5150.00	35.9 AV	54.0	-18.1	2.71 H	105	32.2	3.7
3	*5300.00	115.4 PK			2.71 H	105	111.3	4.1
4	*5300.00	104.2 AV			2.71 H	105	100.1	4.1
5	5350.00	63.7 PK	74.0	-10.3	2.71 H	105	59.6	4.1
6	5350.00	50.5 AV	54.0	-3.5	2.71 H	105	46.4	4.1
7	10600.00	45.9 PK	74.0	-28.1	1.80 H	201	32.4	13.5
8	10600.00	33.9 AV	54.0	-20.1	1.80 H	201	20.4	13.5
9	15900.00	45.9 PK	74.0	-28.1	1.37 H	188	33.0	12.9
10	15900.00	33.1 AV	54.0	-20.9	1.37 H	188	20.2	12.9

**ANTENNA POLARITY & TEST DISTANCE: VERTICAL AT 3 M**

NO.	FREQ. (MHz)	EMISSION LEVEL (dBuV/m)	LIMIT (dBuV/m)	MARGIN (dB)	ANTENNA HEIGHT (m)	TABLE ANGLE (Degree)	RAW VALUE (dBuV)	CORRECTION FACTOR (dB/m)
1	5150.00	45.2 PK	74.0	-28.8	2.66 V	354	41.5	3.7
2	5150.00	32.7 AV	54.0	-21.3	2.66 V	354	29.0	3.7
3	*5300.00	106.0 PK			2.66 V	354	101.9	4.1
4	*5300.00	95.0 AV			2.66 V	354	90.9	4.1
5	5350.00	53.6 PK	74.0	-20.4	2.66 V	354	49.5	4.1
6	5350.00	44.1 AV	54.0	-9.9	2.66 V	354	40.0	4.1
7	10600.00	46.6 PK	74.0	-27.4	1.00 V	117	33.1	13.5
8	10600.00	33.5 AV	54.0	-20.5	1.00 V	117	20.0	13.5
9	15900.00	46.0 PK	74.0	-28.0	1.00 V	166	33.1	12.9
10	15900.00	33.5 AV	54.0	-20.5	1.00 V	166	20.6	12.9

**REMARKS:**

1. Emission Level(dBuV/m) = Raw Value(dBuV) + Correction Factor(dB/m)
2. Correction Factor(dB/m) = Antenna Factor(dB/m) + Cable Factor(dB) – Pre-Amplifier Factor(dB)
3. The other emission levels were very low against the limit.
4. Margin value = Emission Level – Limit value
5. " \* ": Fundamental frequency.

<b>CHANNEL</b>	TX Channel 64	<b>DETECTOR FUNCTION</b>	Peak (PK)
<b>FREQUENCY RANGE</b>	1GHz ~ 40GHz		Average (AV)

**ANTENNA POLARITY & TEST DISTANCE: HORIZONTAL AT 3 M**

NO.	FREQ. (MHz)	EMISSION LEVEL (dBuV/m)	LIMIT (dBuV/m)	MARGIN (dB)	ANTENNA HEIGHT (m)	TABLE ANGLE (Degree)	RAW VALUE (dBuV)	CORRECTION FACTOR (dB/m)
1	*5320.00	111.7 PK			2.75 H	108	107.6	4.1
2	*5320.00	100.4 AV			2.75 H	108	96.3	4.1
3	5350.00	68.2 PK	74.0	-5.8	2.75 H	108	64.1	4.1
4	5350.00	53.8 AV	54.0	-0.2	2.75 H	108	49.7	4.1
5	10640.00	45.7 PK	74.0	-28.3	1.81 H	200	32.2	13.5
6	10640.00	33.8 AV	54.0	-20.2	1.81 H	200	20.3	13.5
7	15960.00	45.8 PK	74.0	-28.2	1.46 H	198	32.9	12.9
8	15960.00	33.1 AV	54.0	-20.9	1.46 H	198	20.2	12.9

**ANTENNA POLARITY & TEST DISTANCE: VERTICAL AT 3 M**

NO.	FREQ. (MHz)	EMISSION LEVEL (dBuV/m)	LIMIT (dBuV/m)	MARGIN (dB)	ANTENNA HEIGHT (m)	TABLE ANGLE (Degree)	RAW VALUE (dBuV)	CORRECTION FACTOR (dB/m)
1	*5320.00	102.3 PK			2.64 V	358	98.2	4.1
2	*5320.00	91.2 AV			2.64 V	358	87.1	4.1
3	5350.00	58.0 PK	74.0	-16.0	2.64 V	358	53.9	4.1
4	5350.00	47.4 AV	54.0	-6.6	2.64 V	358	43.3	4.1
5	10640.00	46.8 PK	74.0	-27.2	1.00 V	129	33.3	13.5
6	10640.00	33.6 AV	54.0	-20.4	1.00 V	129	20.1	13.5
7	15960.00	46.8 PK	74.0	-27.2	1.00 V	173	33.9	12.9
8	15960.00	33.9 AV	54.0	-20.1	1.00 V	173	21.0	12.9

**REMARKS:**

1. Emission Level(dBuV/m) = Raw Value(dBuV) + Correction Factor(dB/m)
2. Correction Factor(dB/m) = Antenna Factor(dB/m) + Cable Factor(dB) – Pre-Amplifier Factor(dB)
3. The other emission levels were very low against the limit.
4. Margin value = Emission Level – Limit value
5. " \* ": Fundamental frequency.

<b>CHANNEL</b>	TX Channel 100	<b>DETECTOR FUNCTION</b>	Peak (PK)
<b>FREQUENCY RANGE</b>	1GHz ~ 40GHz		Average (AV)

**ANTENNA POLARITY & TEST DISTANCE: HORIZONTAL AT 3 M**

NO.	FREQ. (MHz)	EMISSION LEVEL (dBuV/m)	LIMIT (dBuV/m)	MARGIN (dB)	ANTENNA HEIGHT (m)	TABLE ANGLE (Degree)	RAW VALUE (dBuV)	CORRECTION FACTOR (dB/m)
1	#5470.00	68.1 PK	74.0	-5.9	2.63 H	100	63.9	4.2
2	#5470.00	53.9 AV	54.0	-0.1	2.63 H	100	49.7	4.2
3	*5500.00	110.0 PK			2.63 H	100	105.8	4.2
4	*5500.00	99.6 AV			2.63 H	100	95.4	4.2
5	11000.00	45.2 PK	74.0	-28.8	1.73 H	225	31.1	14.1
6	11000.00	33.4 AV	54.0	-20.6	1.73 H	225	19.3	14.1
7	#16500.00	46.2 PK	74.0	-27.8	1.46 H	187	31.7	14.5
8	#16500.00	33.4 AV	54.0	-20.6	1.46 H	187	18.9	14.5

**ANTENNA POLARITY & TEST DISTANCE: VERTICAL AT 3 M**

NO.	FREQ. (MHz)	EMISSION LEVEL (dBuV/m)	LIMIT (dBuV/m)	MARGIN (dB)	ANTENNA HEIGHT (m)	TABLE ANGLE (Degree)	RAW VALUE (dBuV)	CORRECTION FACTOR (dB/m)
1	#5470.00	58.0 PK	74.0	-16.0	2.64 V	360	53.8	4.2
2	#5470.00	47.0 AV	54.0	-7.0	2.64 V	360	42.8	4.2
3	*5500.00	100.6 PK			2.64 V	360	96.4	4.2
4	*5500.00	93.0 AV			2.64 V	360	88.8	4.2
5	11000.00	46.6 PK	74.0	-27.4	1.00 V	131	32.5	14.1
6	11000.00	33.5 AV	54.0	-20.5	1.00 V	131	19.4	14.1
7	#16500.00	46.9 PK	74.0	-27.1	1.00 V	165	32.4	14.5
8	#16500.00	34.2 AV	54.0	-19.8	1.00 V	165	19.7	14.5

**REMARKS:**

1. Emission Level(dBuV/m) = Raw Value(dBuV) + Correction Factor(dB/m)
2. Correction Factor(dB/m) = Antenna Factor(dB/m) + Cable Factor(dB) – Pre-Amplifier Factor(dB)
3. The other emission levels were very low against the limit.
4. Margin value = Emission Level – Limit value
5. " \* ": Fundamental frequency.
6. " # ": The radiated frequency is out of the restricted band.

<b>CHANNEL</b>	TX Channel 116	<b>DETECTOR FUNCTION</b>	Peak (PK)
<b>FREQUENCY RANGE</b>	1GHz ~ 40GHz		Average (AV)

**ANTENNA POLARITY & TEST DISTANCE: HORIZONTAL AT 3 M**

NO.	FREQ. (MHz)	EMISSION LEVEL (dBuV/m)	LIMIT (dBuV/m)	MARGIN (dB)	ANTENNA HEIGHT (m)	TABLE ANGLE (Degree)	RAW VALUE (dBuV)	CORRECTION FACTOR (dB/m)
1	#5470.00	48.5 PK	74.0	-25.5	2.65 H	107	44.3	4.2
2	#5470.00	36.6 AV	54.0	-17.4	2.65 H	107	32.4	4.2
3	*5580.00	116.3 PK			2.65 H	107	112.1	4.2
4	*5580.00	105.3 AV			2.65 H	107	101.1	4.2
5	#5725.00	48.5 PK	74.0	-25.5	2.65 H	107	44.1	4.4
6	#5725.00	36.5 AV	54.0	-17.5	2.65 H	107	32.1	4.4
7	11160.00	45.7 PK	74.0	-28.3	1.76 H	213	32.0	13.7
8	11160.00	34.0 AV	54.0	-20.0	1.76 H	213	20.3	13.7
9	#16740.00	46.0 PK	74.0	-28.0	1.36 H	204	30.3	15.7
10	#16740.00	33.6 AV	54.0	-20.4	1.36 H	204	17.9	15.7

**ANTENNA POLARITY & TEST DISTANCE: VERTICAL AT 3 M**

NO.	FREQ. (MHz)	EMISSION LEVEL (dBuV/m)	LIMIT (dBuV/m)	MARGIN (dB)	ANTENNA HEIGHT (m)	TABLE ANGLE (Degree)	RAW VALUE (dBuV)	CORRECTION FACTOR (dB/m)
1	#5470.00	45.4 PK	74.0	-28.6	2.61 V	360	41.2	4.2
2	#5470.00	33.5 AV	54.0	-20.5	2.61 V	360	29.3	4.2
3	*5580.00	106.9 PK			2.61 V	360	102.7	4.2
4	*5580.00	98.9 AV			2.61 V	360	94.7	4.2
5	#5725.00	44.4 PK	74.0	-29.6	2.61 V	360	40.0	4.4
6	#5725.00	33.3 AV	54.0	-20.7	2.61 V	360	28.9	4.4
7	11160.00	46.2 PK	74.0	-27.8	1.00 V	123	32.5	13.7
8	11160.00	33.4 AV	54.0	-20.6	1.00 V	123	19.7	13.7
9	#16740.00	46.8 PK	74.0	-27.2	1.00 V	190	31.1	15.7
10	#16740.00	34.2 AV	54.0	-19.8	1.00 V	190	18.5	15.7

**REMARKS:**

1. Emission Level(dBuV/m) = Raw Value(dBuV) + Correction Factor(dB/m)
2. Correction Factor(dB/m) = Antenna Factor(dB/m) + Cable Factor(dB) – Pre-Amplifier Factor(dB)
3. The other emission levels were very low against the limit.
4. Margin value = Emission Level – Limit value
5. " \* ": Fundamental frequency.
6. " # ": The radiated frequency is out of the restricted band.

<b>CHANNEL</b>	TX Channel 140	<b>DETECTOR FUNCTION</b>	Peak (PK)
<b>FREQUENCY RANGE</b>	1GHz ~ 40GHz		Average (AV)

**ANTENNA POLARITY & TEST DISTANCE: HORIZONTAL AT 3 M**

NO.	FREQ. (MHz)	EMISSION LEVEL (dBuV/m)	LIMIT (dBuV/m)	MARGIN (dB)	ANTENNA HEIGHT (m)	TABLE ANGLE (Degree)	RAW VALUE (dBuV)	CORRECTION FACTOR (dB/m)
1	*5700.00	109.3 PK			2.69 H	111	104.8	4.5
2	*5700.00	98.3 AV			2.69 H	111	93.8	4.5
3	#5725.00	67.9 PK	74.0	-6.1	2.69 H	111	63.5	4.4
4	#5725.00	53.7 AV	54.0	-0.3	2.69 H	111	49.3	4.4
5	11400.00	45.8 PK	74.0	-28.2	1.82 H	225	32.2	13.6
6	11400.00	33.7 AV	54.0	-20.3	1.82 H	225	20.1	13.6
7	#17100.00	46.7 PK	74.0	-27.3	1.45 H	193	29.3	17.4
8	#17100.00	33.8 AV	54.0	-20.2	1.45 H	193	16.4	17.4

**ANTENNA POLARITY & TEST DISTANCE: VERTICAL AT 3 M**

NO.	FREQ. (MHz)	EMISSION LEVEL (dBuV/m)	LIMIT (dBuV/m)	MARGIN (dB)	ANTENNA HEIGHT (m)	TABLE ANGLE (Degree)	RAW VALUE (dBuV)	CORRECTION FACTOR (dB/m)
1	*5700.00	99.9 PK			2.62 V	360	95.4	4.5
2	*5700.00	89.1 AV			2.62 V	360	84.6	4.5
3	#5725.00	57.8 PK	74.0	-16.2	2.62 V	360	53.4	4.4
4	#5725.00	46.8 AV	54.0	-7.2	2.62 V	360	42.4	4.4
5	11400.00	46.5 PK	74.0	-27.5	1.00 V	134	32.9	13.6
6	11400.00	33.3 AV	54.0	-20.7	1.00 V	134	19.7	13.6
7	#17100.00	46.2 PK	74.0	-27.8	1.00 V	176	28.8	17.4
8	#17100.00	33.6 AV	54.0	-20.4	1.00 V	176	16.2	17.4

**REMARKS:**

1. Emission Level(dBuV/m) = Raw Value(dBuV) + Correction Factor(dB/m)
2. Correction Factor(dB/m) = Antenna Factor(dB/m) + Cable Factor(dB) – Pre-Amplifier Factor(dB)
3. The other emission levels were very low against the limit.
4. Margin value = Emission Level – Limit value
5. " \* ": Fundamental frequency.
6. " # ": The radiated frequency is out of the restricted band.



<b>CHANNEL</b>	TX Channel 144	<b>DETECTOR FUNCTION</b>	Peak (PK)
<b>FREQUENCY RANGE</b>	1GHz ~ 40GHz		Average (AV)

**ANTENNA POLARITY & TEST DISTANCE: HORIZONTAL AT 3 M**

NO.	FREQ. (MHz)	EMISSION LEVEL (dBuV/m)	LIMIT (dBuV/m)	MARGIN (dB)	ANTENNA HEIGHT (m)	TABLE ANGLE (Degree)	RAW VALUE (dBuV)	CORRECTION FACTOR (dB/m)
1	#5470.00	48.6 PK	74.0	-25.4	2.65 H	115	44.4	4.2
2	#5470.00	36.9 AV	54.0	-17.1	2.65 H	115	32.7	4.2
3	*5720.00	117.2 PK			2.65 H	115	112.8	4.4
4	*5720.00	106.0 AV			2.65 H	115	101.6	4.4
5	#5850.00	48.3 PK	74.0	-25.7	2.65 H	115	43.8	4.5
6	#5850.00	36.3 AV	54.0	-17.7	2.65 H	115	31.8	4.5
7	11440.00	45.3 PK	74.0	-28.7	1.73 H	197	31.8	13.5
8	11440.00	33.5 AV	54.0	-20.5	1.73 H	197	20.0	13.5
9	#17160.00	46.8 PK	74.0	-27.2	1.45 H	193	29.5	17.3
10	#17160.00	34.0 AV	54.0	-20.0	1.45 H	193	16.7	17.3

**ANTENNA POLARITY & TEST DISTANCE: VERTICAL AT 3 M**

NO.	FREQ. (MHz)	EMISSION LEVEL (dBuV/m)	LIMIT (dBuV/m)	MARGIN (dB)	ANTENNA HEIGHT (m)	TABLE ANGLE (Degree)	RAW VALUE (dBuV)	CORRECTION FACTOR (dB/m)
1	#5470.00	46.5 PK	74.0	-27.5	2.61 V	360	42.3	4.2
2	#5470.00	33.8 AV	54.0	-20.2	2.61 V	360	29.6	4.2
3	*5720.00	107.8 PK			2.61 V	360	103.4	4.4
4	*5720.00	96.8 AV			2.61 V	360	92.4	4.4
5	#5850.00	46.2 PK	74.0	-27.8	2.61 V	360	41.7	4.5
6	#5850.00	33.1 AV	54.0	-20.9	2.61 V	360	28.6	4.5
7	11440.00	46.2 PK	74.0	-27.8	1.00 V	123	32.7	13.5
8	11440.00	33.2 AV	54.0	-20.8	1.00 V	123	19.7	13.5
9	#17160.00	46.7 PK	74.0	-27.3	1.00 V	188	29.4	17.3
10	#17160.00	33.9 AV	54.0	-20.1	1.00 V	188	16.6	17.3

**REMARKS:**

1. Emission Level(dBuV/m) = Raw Value(dBuV) + Correction Factor(dB/m)
2. Correction Factor(dB/m) = Antenna Factor(dB/m) + Cable Factor(dB) – Pre-Amplifier Factor(dB)
3. The other emission levels were very low against the limit.
4. Margin value = Emission Level – Limit value
5. " \* ": Fundamental frequency.
6. " # ": The radiated frequency is out of the restricted band.

802.11ac (VHT40)

<b>CHANNEL</b>	TX Channel 54	<b>DETECTOR FUNCTION</b>	Peak (PK)
<b>FREQUENCY RANGE</b>	1GHz ~ 40GHz		Average (AV)

**ANTENNA POLARITY & TEST DISTANCE: HORIZONTAL AT 3 M**

NO.	FREQ. (MHz)	EMISSION LEVEL (dBuV/m)	LIMIT (dBuV/m)	MARGIN (dB)	ANTENNA HEIGHT (m)	TABLE ANGLE (Degree)	RAW VALUE (dBuV)	CORRECTION FACTOR (dB/m)
1	5150.00	53.9 PK	74.0	-20.1	2.93 H	107	50.2	3.7
2	5150.00	41.4 AV	54.0	-12.6	2.93 H	107	37.7	3.7
3	*5270.00	110.9 PK			2.93 H	107	106.9	4.0
4	*5270.00	99.2 AV			2.93 H	107	95.2	4.0
5	5350.00	62.2 PK	74.0	-11.8	2.93 H	107	58.1	4.1
6	5350.00	49.6 AV	54.0	-4.4	2.93 H	107	45.5	4.1
7	#10540.00	45.5 PK	74.0	-28.5	1.75 H	199	32.2	13.3
8	#10540.00	33.8 AV	54.0	-20.2	1.75 H	199	20.5	13.3
9	15810.00	46.4 PK	74.0	-27.6	1.45 H	202	33.0	13.4
10	15810.00	33.7 AV	54.0	-20.3	1.45 H	202	20.3	13.4

**ANTENNA POLARITY & TEST DISTANCE: VERTICAL AT 3 M**

NO.	FREQ. (MHz)	EMISSION LEVEL (dBuV/m)	LIMIT (dBuV/m)	MARGIN (dB)	ANTENNA HEIGHT (m)	TABLE ANGLE (Degree)	RAW VALUE (dBuV)	CORRECTION FACTOR (dB/m)
1	5150.00	50.8 PK	74.0	-23.2	2.57 V	359	47.1	3.7
2	5150.00	38.3 AV	54.0	-15.7	2.57 V	359	34.6	3.7
3	*5270.00	101.5 PK			2.57 V	359	97.5	4.0
4	*5270.00	90.0 AV			2.57 V	359	86.0	4.0
5	5350.00	52.1 PK	74.0	-21.9	2.57 V	359	48.0	4.1
6	5350.00	45.0 AV	54.0	-9.0	2.57 V	359	40.9	4.1
7	#10540.00	46.2 PK	74.0	-27.8	1.00 V	129	32.9	13.3
8	#10540.00	33.2 AV	54.0	-20.8	1.00 V	129	19.9	13.3
9	15810.00	47.3 PK	74.0	-26.7	1.00 V	182	33.9	13.4
10	15810.00	34.3 AV	54.0	-19.7	1.00 V	182	20.9	13.4

**REMARKS:**

1. Emission Level(dBuV/m) = Raw Value(dBuV) + Correction Factor(dB/m)
2. Correction Factor(dB/m) = Antenna Factor(dB/m) + Cable Factor(dB) – Pre-Amplifier Factor(dB)
3. The other emission levels were very low against the limit.
4. Margin value = Emission Level – Limit value
5. " \* ": Fundamental frequency.
6. " # ": The radiated frequency is out of the restricted band.

<b>CHANNEL</b>	TX Channel 62	<b>DETECTOR FUNCTION</b>	Peak (PK)
<b>FREQUENCY RANGE</b>	1GHz ~ 40GHz		Average (AV)

**ANTENNA POLARITY & TEST DISTANCE: HORIZONTAL AT 3 M**

NO.	FREQ. (MHz)	EMISSION LEVEL (dBuV/m)	LIMIT (dBuV/m)	MARGIN (dB)	ANTENNA HEIGHT (m)	TABLE ANGLE (Degree)	RAW VALUE (dBuV)	CORRECTION FACTOR (dB/m)
1	*5310.00	103.0 PK			2.90 H	105	98.9	4.1
2	*5310.00	92.3 AV			2.90 H	105	88.2	4.1
3	5350.00	68.8 PK	74.0	-5.2	2.90 H	105	64.7	4.1
4	5350.00	53.7 AV	54.0	-0.3	2.90 H	105	49.6	4.1
5	10620.00	45.7 PK	74.0	-28.3	1.83 H	211	32.2	13.5
6	10620.00	33.6 AV	54.0	-20.4	1.83 H	211	20.1	13.5
7	15930.00	46.7 PK	74.0	-27.3	1.43 H	205	33.9	12.8
8	15930.00	34.1 AV	54.0	-19.9	1.43 H	205	21.3	12.8

**ANTENNA POLARITY & TEST DISTANCE: VERTICAL AT 3 M**

NO.	FREQ. (MHz)	EMISSION LEVEL (dBuV/m)	LIMIT (dBuV/m)	MARGIN (dB)	ANTENNA HEIGHT (m)	TABLE ANGLE (Degree)	RAW VALUE (dBuV)	CORRECTION FACTOR (dB/m)
1	*5310.00	93.6 PK			2.54 V	358	89.5	4.1
2	*5310.00	83.1 AV			2.54 V	358	79.0	4.1
3	5350.00	59.0 PK	74.0	-15.0	2.54 V	358	54.9	4.1
4	5350.00	44.1 AV	54.0	-9.9	2.54 V	358	40.0	4.1
5	10620.00	46.3 PK	74.0	-27.7	1.00 V	138	32.8	13.5
6	10620.00	33.3 AV	54.0	-20.7	1.00 V	138	19.8	13.5
7	15930.00	46.9 PK	74.0	-27.1	1.00 V	174	34.1	12.8
8	15930.00	34.1 AV	54.0	-19.9	1.00 V	174	21.3	12.8

**REMARKS:**

1. Emission Level(dBuV/m) = Raw Value(dBuV) + Correction Factor(dB/m)
2. Correction Factor(dB/m) = Antenna Factor(dB/m) + Cable Factor(dB) – Pre-Amplifier Factor(dB)
3. The other emission levels were very low against the limit.
4. Margin value = Emission Level – Limit value
5. " \* ": Fundamental frequency.

<b>CHANNEL</b>	TX Channel 102	<b>DETECTOR FUNCTION</b>	Peak (PK)
<b>FREQUENCY RANGE</b>	1GHz ~ 40GHz		Average (AV)

**ANTENNA POLARITY & TEST DISTANCE: HORIZONTAL AT 3 M**

NO.	FREQ. (MHz)	EMISSION LEVEL (dBuV/m)	LIMIT (dBuV/m)	MARGIN (dB)	ANTENNA HEIGHT (m)	TABLE ANGLE (Degree)	RAW VALUE (dBuV)	CORRECTION FACTOR (dB/m)
1	#5470.00	68.0 PK	74.0	-6.0	2.88 H	107	63.8	4.2
2	#5470.00	53.8 AV	54.0	-0.2	2.88 H	107	49.6	4.2
3	*5510.00	105.1 PK			2.88 H	107	100.9	4.2
4	*5510.00	93.1 AV			2.88 H	107	88.9	4.2
5	11020.00	45.6 PK	74.0	-28.4	1.76 H	201	31.6	14.0
6	11020.00	33.9 AV	54.0	-20.1	1.76 H	201	19.9	14.0
7	#16530.00	46.0 PK	74.0	-28.0	1.40 H	199	31.1	14.9
8	#16530.00	33.6 AV	54.0	-20.4	1.40 H	199	18.7	14.9

**ANTENNA POLARITY & TEST DISTANCE: VERTICAL AT 3 M**

NO.	FREQ. (MHz)	EMISSION LEVEL (dBuV/m)	LIMIT (dBuV/m)	MARGIN (dB)	ANTENNA HEIGHT (m)	TABLE ANGLE (Degree)	RAW VALUE (dBuV)	CORRECTION FACTOR (dB/m)
1	#5470.00	57.9 PK	74.0	-16.1	2.60 V	360	53.7	4.2
2	#5470.00	47.2 AV	54.0	-6.8	2.60 V	360	43.0	4.2
3	*5510.00	95.7 PK			2.60 V	360	91.5	4.2
4	*5510.00	83.9 AV			2.60 V	360	79.7	4.2
5	11020.00	46.5 PK	74.0	-27.5	1.00 V	112	32.5	14.0
6	11020.00	33.4 AV	54.0	-20.6	1.00 V	112	19.4	14.0
7	#16530.00	46.8 PK	74.0	-27.2	1.00 V	184	31.9	14.9
8	#16530.00	34.1 AV	54.0	-19.9	1.00 V	184	19.2	14.9

**REMARKS:**

1. Emission Level(dBuV/m) = Raw Value(dBuV) + Correction Factor(dB/m)
2. Correction Factor(dB/m) = Antenna Factor(dB/m) + Cable Factor(dB) – Pre-Amplifier Factor(dB)
3. The other emission levels were very low against the limit.
4. Margin value = Emission Level – Limit value
5. " \* ": Fundamental frequency.
6. " # ": The radiated frequency is out of the restricted band.

<b>CHANNEL</b>	TX Channel 110	<b>DETECTOR FUNCTION</b>	Peak (PK)
<b>FREQUENCY RANGE</b>	1GHz ~ 40GHz		Average (AV)

**ANTENNA POLARITY & TEST DISTANCE: HORIZONTAL AT 3 M**

NO.	FREQ. (MHz)	EMISSION LEVEL (dBuV/m)	LIMIT (dBuV/m)	MARGIN (dB)	ANTENNA HEIGHT (m)	TABLE ANGLE (Degree)	RAW VALUE (dBuV)	CORRECTION FACTOR (dB/m)
1	#5470.00	62.3 PK	74.0	-11.7	2.91 H	104	58.1	4.2
2	#5470.00	49.6 AV	54.0	-4.4	2.91 H	104	45.4	4.2
3	*5550.00	111.9 PK			2.91 H	104	107.7	4.2
4	*5550.00	100.9 AV			2.91 H	104	96.7	4.2
5	#5725.00	48.9 PK	74.0	-25.1	2.91 H	104	44.5	4.4
6	#5725.00	38.2 AV	54.0	-15.8	2.91 H	104	33.8	4.4
7	11100.00	45.3 PK	74.0	-28.7	1.72 H	221	31.5	13.8
8	11100.00	33.7 AV	54.0	-20.3	1.72 H	221	19.9	13.8
9	#16650.00	45.8 PK	74.0	-28.2	1.38 H	195	30.2	15.6
10	#16650.00	33.5 AV	54.0	-20.5	1.38 H	195	17.9	15.6

**ANTENNA POLARITY & TEST DISTANCE: VERTICAL AT 3 M**

NO.	FREQ. (MHz)	EMISSION LEVEL (dBuV/m)	LIMIT (dBuV/m)	MARGIN (dB)	ANTENNA HEIGHT (m)	TABLE ANGLE (Degree)	RAW VALUE (dBuV)	CORRECTION FACTOR (dB/m)
1	#5470.00	55.9 PK	74.0	-18.1	2.56 V	360	51.7	4.2
2	#5470.00	43.0 AV	54.0	-11.0	2.56 V	360	38.8	4.2
3	*5550.00	102.5 PK			2.56 V	360	98.3	4.2
4	*5550.00	91.7 AV			2.56 V	360	87.5	4.2
5	#5725.00	45.8 PK	74.0	-28.2	2.56 V	360	41.4	4.4
6	#5725.00	35.0 AV	54.0	-19.0	2.56 V	360	30.6	4.4
7	11100.00	46.7 PK	74.0	-27.3	1.00 V	135	32.9	13.8
8	11100.00	34.1 AV	54.0	-19.9	1.00 V	135	20.3	13.8
9	#16650.00	46.8 PK	74.0	-27.2	1.00 V	171	31.2	15.6
10	#16650.00	33.9 AV	54.0	-20.1	1.00 V	171	18.3	15.6

**REMARKS:**

1. Emission Level(dBuV/m) = Raw Value(dBuV) + Correction Factor(dB/m)
2. Correction Factor(dB/m) = Antenna Factor(dB/m) + Cable Factor(dB) – Pre-Amplifier Factor(dB)
3. The other emission levels were very low against the limit.
4. Margin value = Emission Level – Limit value
5. " \* ": Fundamental frequency.
6. " # ": The radiated frequency is out of the restricted band.

<b>CHANNEL</b>	TX Channel 134	<b>DETECTOR FUNCTION</b>	Peak (PK)
<b>FREQUENCY RANGE</b>	1GHz ~ 40GHz		Average (AV)

**ANTENNA POLARITY & TEST DISTANCE: HORIZONTAL AT 3 M**

NO.	FREQ. (MHz)	EMISSION LEVEL (dBuV/m)	LIMIT (dBuV/m)	MARGIN (dB)	ANTENNA HEIGHT (m)	TABLE ANGLE (Degree)	RAW VALUE (dBuV)	CORRECTION FACTOR (dB/m)
1	*5670.00	106.5 PK			2.94 H	106	102.2	4.3
2	*5670.00	96.0 AV			2.94 H	106	91.7	4.3
3	#5725.00	67.8 PK	74.0	-6.2	2.94 H	106	63.4	4.4
4	#5725.00	53.7 AV	54.0	-0.3	2.94 H	106	49.3	4.4
5	11340.00	45.1 PK	74.0	-28.9	1.72 H	211	31.5	13.6
6	11340.00	33.4 AV	54.0	-20.6	1.72 H	211	19.8	13.6
7	#17010.00	46.8 PK	74.0	-27.2	1.41 H	194	29.7	17.1
8	#17010.00	34.0 AV	54.0	-20.0	1.41 H	194	16.9	17.1

**ANTENNA POLARITY & TEST DISTANCE: VERTICAL AT 3 M**

NO.	FREQ. (MHz)	EMISSION LEVEL (dBuV/m)	LIMIT (dBuV/m)	MARGIN (dB)	ANTENNA HEIGHT (m)	TABLE ANGLE (Degree)	RAW VALUE (dBuV)	CORRECTION FACTOR (dB/m)
1	*5670.00	97.1 PK			2.57 V	359	92.8	4.3
2	*5670.00	86.8 AV			2.57 V	359	82.5	4.3
3	#5725.00	57.7 PK	74.0	-16.3	2.57 V	359	53.3	4.4
4	#5725.00	46.8 AV	54.0	-7.2	2.57 V	359	42.4	4.4
5	11340.00	46.2 PK	74.0	-27.8	1.00 V	141	32.6	13.6
6	11340.00	33.2 AV	54.0	-20.8	1.00 V	141	19.6	13.6
7	#17010.00	47.0 PK	74.0	-27.0	1.00 V	167	29.9	17.1
8	#17010.00	34.0 AV	54.0	-20.0	1.00 V	167	16.9	17.1

**REMARKS:**

1. Emission Level(dBuV/m) = Raw Value(dBuV) + Correction Factor(dB/m)
2. Correction Factor(dB/m) = Antenna Factor(dB/m) + Cable Factor(dB) – Pre-Amplifier Factor(dB)
3. The other emission levels were very low against the limit.
4. Margin value = Emission Level – Limit value
5. " \* ": Fundamental frequency.
6. " # ": The radiated frequency is out of the restricted band.

<b>CHANNEL</b>	TX Channel 142	<b>DETECTOR FUNCTION</b>	Peak (PK)
<b>FREQUENCY RANGE</b>	1GHz ~ 40GHz		Average (AV)

**ANTENNA POLARITY & TEST DISTANCE: HORIZONTAL AT 3 M**

NO.	FREQ. (MHz)	EMISSION LEVEL (dBuV/m)	LIMIT (dBuV/m)	MARGIN (dB)	ANTENNA HEIGHT (m)	TABLE ANGLE (Degree)	RAW VALUE (dBuV)	CORRECTION FACTOR (dB/m)
1	#5470.00	48.0 PK	74.0	-26.0	2.84 H	103	43.8	4.2
2	#5470.00	37.4 AV	54.0	-16.6	2.84 H	103	33.2	4.2
3	*5710.00	111.4 PK			2.84 H	103	106.9	4.5
4	*5710.00	102.5 AV			2.84 H	103	98.0	4.5
5	#5850.00	54.3 PK	74.0	-19.7	2.84 H	103	49.8	4.5
6	#5850.00	41.2 AV	54.0	-12.8	2.84 H	103	36.7	4.5
7	11420.00	45.0 PK	74.0	-29.0	1.82 H	197	31.4	13.6
8	11420.00	33.5 AV	54.0	-20.5	1.82 H	197	19.9	13.6
9	#17130.00	45.9 PK	74.0	-28.1	1.37 H	210	28.5	17.4
10	#17130.00	33.5 AV	54.0	-20.5	1.37 H	210	16.1	17.4

**ANTENNA POLARITY & TEST DISTANCE: VERTICAL AT 3 M**

NO.	FREQ. (MHz)	EMISSION LEVEL (dBuV/m)	LIMIT (dBuV/m)	MARGIN (dB)	ANTENNA HEIGHT (m)	TABLE ANGLE (Degree)	RAW VALUE (dBuV)	CORRECTION FACTOR (dB/m)
1	#5470.00	44.9 PK	74.0	-29.1	2.52 V	351	40.7	4.2
2	#5470.00	34.3 AV	54.0	-19.7	2.52 V	351	30.1	4.2
3	*5710.00	102.0 PK			2.52 V	351	97.5	4.5
4	*5710.00	93.3 AV			2.52 V	351	88.8	4.5
5	#5850.00	44.2 PK	74.0	-29.8	2.52 V	351	39.7	4.5
6	#5850.00	35.8 AV	54.0	-18.2	2.52 V	351	31.3	4.5
7	11420.00	46.8 PK	74.0	-27.2	1.00 V	119	33.2	13.6
8	11420.00	34.1 AV	54.0	-19.9	1.00 V	119	20.5	13.6
9	#17130.00	46.8 PK	74.0	-27.2	1.00 V	180	29.4	17.4
10	#17130.00	34.3 AV	54.0	-19.7	1.00 V	180	16.9	17.4

**REMARKS:**

1. Emission Level(dBuV/m) = Raw Value(dBuV) + Correction Factor(dB/m)
2. Correction Factor(dB/m) = Antenna Factor(dB/m) + Cable Factor(dB) – Pre-Amplifier Factor(dB)
3. The other emission levels were very low against the limit.
4. Margin value = Emission Level – Limit value
5. " \* ": Fundamental frequency.
6. " # ": The radiated frequency is out of the restricted band.

**802.11ac (VHT80)**

<b>CHANNEL</b>	TX Channel 58	<b>DETECTOR FUNCTION</b>	Peak (PK)
<b>FREQUENCY RANGE</b>	1GHz ~ 40GHz		Average (AV)

**ANTENNA POLARITY & TEST DISTANCE: HORIZONTAL AT 3 M**

NO.	FREQ. (MHz)	EMISSION LEVEL (dBuV/m)	LIMIT (dBuV/m)	MARGIN (dB)	ANTENNA HEIGHT (m)	TABLE ANGLE (Degree)	RAW VALUE (dBuV)	CORRECTION FACTOR (dB/m)
1	5150.00	52.6 PK	74.0	-21.4	2.88 H	105	48.9	3.7
2	5150.00	41.3 AV	54.0	-12.7	2.88 H	105	37.6	3.7
3	*5290.00	102.3 PK			2.88 H	105	98.2	4.1
4	*5290.00	92.3 AV			2.88 H	105	88.2	4.1
5	5350.00	68.0 PK	74.0	-6.0	2.88 H	105	63.9	4.1
<b>6</b>	<b>5350.00</b>	<b>53.9 AV</b>	<b>54.0</b>	<b>-0.1</b>	<b>2.88 H</b>	<b>105</b>	<b>49.8</b>	<b>4.1</b>
7	#10580.00	45.2 PK	74.0	-28.8	1.80 H	203	31.8	13.4
8	#10580.00	33.6 AV	54.0	-20.4	1.80 H	203	20.2	13.4
9	15870.00	46.4 PK	74.0	-27.6	1.40 H	195	33.4	13.0
10	15870.00	33.6 AV	54.0	-20.4	1.40 H	195	20.6	13.0

**ANTENNA POLARITY & TEST DISTANCE: VERTICAL AT 3 M**

NO.	FREQ. (MHz)	EMISSION LEVEL (dBuV/m)	LIMIT (dBuV/m)	MARGIN (dB)	ANTENNA HEIGHT (m)	TABLE ANGLE (Degree)	RAW VALUE (dBuV)	CORRECTION FACTOR (dB/m)
1	5150.00	49.0 PK	74.0	-25.0	2.56 V	353	45.3	3.7
2	5150.00	38.0 AV	54.0	-16.0	2.56 V	353	34.3	3.7
3	*5290.00	92.9 PK			2.56 V	353	88.8	4.1
4	*5290.00	83.1 AV			2.56 V	353	79.0	4.1
5	5350.00	57.9 PK	74.0	-16.1	2.56 V	353	53.8	4.1
6	5350.00	47.0 AV	54.0	-7.0	2.56 V	353	42.9	4.1
7	#10580.00	46.4 PK	74.0	-27.6	1.00 V	125	33.0	13.4
8	#10580.00	33.5 AV	54.0	-20.5	1.00 V	125	20.1	13.4
9	15870.00	46.4 PK	74.0	-27.6	1.00 V	160	33.4	13.0
10	15870.00	33.7 AV	54.0	-20.3	1.00 V	160	20.7	13.0

**REMARKS:**

- Emission Level(dBuV/m) = Raw Value(dBuV) + Correction Factor(dB/m)
- Correction Factor(dB/m) = Antenna Factor(dB/m) + Cable Factor(dB) – Pre-Amplifier Factor(dB)
- The other emission levels were very low against the limit.
- Margin value = Emission Level – Limit value
- " \* ": Fundamental frequency.
- " # ": The radiated frequency is out of the restricted band.



<b>CHANNEL</b>	TX Channel 106	<b>DETECTOR FUNCTION</b>	Peak (PK)
<b>FREQUENCY RANGE</b>	1GHz ~ 40GHz		Average (AV)

**ANTENNA POLARITY & TEST DISTANCE: HORIZONTAL AT 3 M**

NO.	FREQ. (MHz)	EMISSION LEVEL (dBuV/m)	LIMIT (dBuV/m)	MARGIN (dB)	ANTENNA HEIGHT (m)	TABLE ANGLE (Degree)	RAW VALUE (dBuV)	CORRECTION FACTOR (dB/m)
1	#5470.00	68.1 PK	74.0	-5.9	2.61 H	98	63.9	4.2
2	#5470.00	53.6 AV	54.0	-0.4	2.61 H	98	49.4	4.2
3	*5530.00	101.8 PK			2.61 H	98	97.6	4.2
4	*5530.00	92.3 AV			2.61 H	98	88.1	4.2
5	#5725.00	52.3 PK	74.0	-21.7	2.61 H	98	47.9	4.4
6	#5725.00	41.1 AV	54.0	-12.9	2.61 H	98	36.7	4.4
7	11060.00	45.5 PK	74.0	-28.5	1.75 H	220	31.6	13.9
8	11060.00	33.7 AV	54.0	-20.3	1.75 H	220	19.8	13.9
9	#16590.00	46.0 PK	74.0	-28.0	1.37 H	211	30.4	15.6
10	#16590.00	33.7 AV	54.0	-20.3	1.37 H	211	18.1	15.6

**ANTENNA POLARITY & TEST DISTANCE: VERTICAL AT 3 M**

NO.	FREQ. (MHz)	EMISSION LEVEL (dBuV/m)	LIMIT (dBuV/m)	MARGIN (dB)	ANTENNA HEIGHT (m)	TABLE ANGLE (Degree)	RAW VALUE (dBuV)	CORRECTION FACTOR (dB/m)
1	#5470.00	58.0 PK	74.0	-16.0	2.62 V	342	53.8	4.2
2	#5470.00	46.7 AV	54.0	-7.3	2.62 V	342	42.5	4.2
3	*5530.00	92.4 PK			2.62 V	342	88.2	4.2
4	*5530.00	83.1 AV			2.62 V	342	78.9	4.2
5	#5725.00	49.2 PK	74.0	-24.8	2.62 V	342	44.8	4.4
6	#5725.00	37.8 AV	54.0	-16.2	2.62 V	342	33.4	4.4
7	11060.00	46.8 PK	74.0	-27.2	1.00 V	134	32.9	13.9
8	11060.00	34.0 AV	54.0	-20.0	1.00 V	134	20.1	13.9
9	#16590.00	47.4 PK	74.0	-26.6	1.00 V	182	31.8	15.6
10	#16590.00	34.4 AV	54.0	-19.6	1.00 V	182	18.8	15.6

**REMARKS:**

1. Emission Level(dBuV/m) = Raw Value(dBuV) + Correction Factor(dB/m)
2. Correction Factor(dB/m) = Antenna Factor(dB/m) + Cable Factor(dB) – Pre-Amplifier Factor(dB)
3. The other emission levels were very low against the limit.
4. Margin value = Emission Level – Limit value
5. " \* ": Fundamental frequency.
6. " # ": The radiated frequency is out of the restricted band.

<b>CHANNEL</b>	TX Channel 122	<b>DETECTOR FUNCTION</b>	Peak (PK)
<b>FREQUENCY RANGE</b>	1GHz ~ 40GHz		Average (AV)

**ANTENNA POLARITY & TEST DISTANCE: HORIZONTAL AT 3 M**

NO.	FREQ. (MHz)	EMISSION LEVEL (dBuV/m)	LIMIT (dBuV/m)	MARGIN (dB)	ANTENNA HEIGHT (m)	TABLE ANGLE (Degree)	RAW VALUE (dBuV)	CORRECTION FACTOR (dB/m)
1	*5610.00	106.6 PK			2.66 H	96	102.2	4.4
2	*5610.00	96.7 AV			2.66 H	96	92.3	4.4
3	#5725.00	68.2 PK	74.0	-5.8	2.66 H	96	63.8	4.4
4	<b>#5725.00</b>	<b>53.9 AV</b>	<b>54.0</b>	<b>-0.1</b>	<b>2.66 H</b>	<b>96</b>	<b>49.5</b>	<b>4.4</b>
5	11220.00	45.3 PK	74.0	-28.7	1.79 H	206	31.6	13.7
6	11220.00	33.7 AV	54.0	-20.3	1.79 H	206	20.0	13.7
7	#16830.00	45.7 PK	74.0	-28.3	1.39 H	185	29.8	15.9
8	#16830.00	33.4 AV	54.0	-20.6	1.39 H	185	17.5	15.9

**ANTENNA POLARITY & TEST DISTANCE: VERTICAL AT 3 M**

NO.	FREQ. (MHz)	EMISSION LEVEL (dBuV/m)	LIMIT (dBuV/m)	MARGIN (dB)	ANTENNA HEIGHT (m)	TABLE ANGLE (Degree)	RAW VALUE (dBuV)	CORRECTION FACTOR (dB/m)
1	*5610.00	97.2 PK			2.66 V	328	92.8	4.4
2	*5610.00	87.5 AV			2.66 V	328	83.1	4.4
3	#5725.00	67.1 PK	74.0	-6.9	2.66 V	328	62.7	4.4
4	#5725.00	47.0 AV	54.0	-7.0	2.66 V	328	42.6	4.4
5	11220.00	46.0 PK	74.0	-28.0	1.00 V	119	32.3	13.7
6	11220.00	33.2 AV	54.0	-20.8	1.00 V	119	19.5	13.7
7	#16830.00	46.6 PK	74.0	-27.4	1.00 V	190	30.7	15.9
8	#16830.00	33.8 AV	54.0	-20.2	1.00 V	190	17.9	15.9

**REMARKS:**

1. Emission Level(dBuV/m) = Raw Value(dBuV) + Correction Factor(dB/m)
2. Correction Factor(dB/m) = Antenna Factor(dB/m) + Cable Factor(dB) – Pre-Amplifier Factor(dB)
3. The other emission levels were very low against the limit.
4. Margin value = Emission Level – Limit value
5. " \* ": Fundamental frequency.
6. " # ": The radiated frequency is out of the restricted band.

<b>CHANNEL</b>	TX Channel 138	<b>DETECTOR FUNCTION</b>	Peak (PK)
<b>FREQUENCY RANGE</b>	1GHz ~ 40GHz		Average (AV)

**ANTENNA POLARITY & TEST DISTANCE: HORIZONTAL AT 3 M**

NO.	FREQ. (MHz)	EMISSION LEVEL (dBuV/m)	LIMIT (dBuV/m)	MARGIN (dB)	ANTENNA HEIGHT (m)	TABLE ANGLE (Degree)	RAW VALUE (dBuV)	CORRECTION FACTOR (dB/m)
1	#5470.00	67.5 PK	74.0	-6.5	2.66 H	95	63.3	4.2
2	#5470.00	50.0 AV	54.0	-4.0	2.66 H	95	45.8	4.2
3	*5690.00	109.9 PK			2.66 H	95	105.4	4.5
4	*5690.00	100.1 AV			2.66 H	95	95.6	4.5
5	#5850.00	68.0 PK	74.0	-6.0	2.66 H	95	63.5	4.5
<b>6</b>	<b>#5850.00</b>	<b>53.9 AV</b>	<b>54.0</b>	<b>-0.1</b>	<b>2.66 H</b>	<b>95</b>	<b>49.4</b>	<b>4.5</b>
7	11380.00	45.4 PK	74.0	-28.6	1.80 H	226	31.8	13.6
8	11380.00	33.4 AV	54.0	-20.6	1.80 H	226	19.8	13.6
9	#17070.00	46.5 PK	74.0	-27.5	1.46 H	199	29.2	17.3
10	#17070.00	33.9 AV	54.0	-20.1	1.46 H	199	16.6	17.3

**ANTENNA POLARITY & TEST DISTANCE: VERTICAL AT 3 M**

NO.	FREQ. (MHz)	EMISSION LEVEL (dBuV/m)	LIMIT (dBuV/m)	MARGIN (dB)	ANTENNA HEIGHT (m)	TABLE ANGLE (Degree)	RAW VALUE (dBuV)	CORRECTION FACTOR (dB/m)
1	#5470.00	57.4 PK	74.0	-16.6	2.67 V	332	53.2	4.2
2	#5470.00	43.6 AV	54.0	-10.4	2.67 V	332	39.4	4.2
3	*5690.00	100.5 PK			2.67 V	332	96.0	4.5
4	*5690.00	90.9 AV			2.67 V	332	86.4	4.5
5	#5850.00	57.9 PK	74.0	-16.1	2.67 V	332	53.4	4.5
6	#5850.00	47.0 AV	54.0	-7.0	2.67 V	332	42.5	4.5
7	11380.00	46.1 PK	74.0	-27.9	1.00 V	139	32.5	13.6
8	11380.00	33.4 AV	54.0	-20.6	1.00 V	139	19.8	13.6
9	#17070.00	46.5 PK	74.0	-27.5	1.00 V	163	29.2	17.3
10	#17070.00	33.6 AV	54.0	-20.4	1.00 V	163	16.3	17.3

**REMARKS:**

1. Emission Level(dBuV/m) = Raw Value(dBuV) + Correction Factor(dB/m)
2. Correction Factor(dB/m) = Antenna Factor(dB/m) + Cable Factor(dB) – Pre-Amplifier Factor(dB)
3. The other emission levels were very low against the limit.
4. Margin value = Emission Level – Limit value
5. " \* ": Fundamental frequency.
6. " # ": The radiated frequency is out of the restricted band.

## 4.2 Conducted Emission Measurement

### 4.2.1 Limits of Conducted Emission Measurement

Frequency (MHz)	Conducted Limit (dBuV)	
	Quasi-peak	Average
0.15 - 0.5	66 - 56	56 - 46
0.50 - 5.0	56	46
5.0 - 30.0	60	50

Note: 1. The lower limit shall apply at the transition frequencies.

2. The limit decreases in line with the logarithm of the frequency in the range of 0.15 to 0.50MHz.

### 4.2.2 Test Instruments

DESCRIPTION & MANUFACTURER	MODEL NO.	SERIAL NO.	CALIBRATED DATE	CALIBRATED UNTIL
Test Receiver R&S	ESCS 30	847124/029	Oct. 24, 2016	Oct. 23, 2017
Line-Impedance Stabilization Network (for EUT) R&S	ESH3-Z5	848773/004	Oct. 26, 2016	Oct. 25, 2017
Line-Impedance Stabilization Network (for Peripheral) R&S	ENV216	100072	June 13, 2016	June 12, 2017
50 ohms Terminator	N/A	EMC-02	Sep. 29, 2016	Sep. 28, 2017
RF Cable	5D-FB	COCCAB-001	Sep. 30, 2016	Sep. 29, 2017
10 dB PAD Mini-Circuits	HAT-10+	CONATT-004	June 20, 2016	June 19, 2017
Software BVADT	BVADT_Cond_ V7.3.7.4	NA	NA	NA

**Note:**

1. The calibration interval of the above test instruments are 12 months and the calibrations are traceable to NML/ROC and NIST/USA.
2. The test was performed in Shielded Room No. 1.
3. Tested Date: May 18, 2017

#### 4.2.3 Test Procedure

- The EUT was placed 0.4 meters from the conducting wall of the shielded room with EUT being connected to the power mains through a line impedance stabilization network (LISN). Other support units were connected to the power mains through another LISN. The two LISNs provide 50 ohm/ 50uH of coupling impedance for the measuring instrument.
- Both lines of the power mains connected to the EUT were checked for maximum conducted interference.
- The frequency range from 150kHz to 30MHz was searched. Emission levels under (Limit - 20dB) was not recorded.

**NOTE:** All modes of operation were investigated and the worst-case emissions are reported.

#### 4.2.4 Deviation from Test Standard

No deviation.

#### 4.2.5 Test Setup

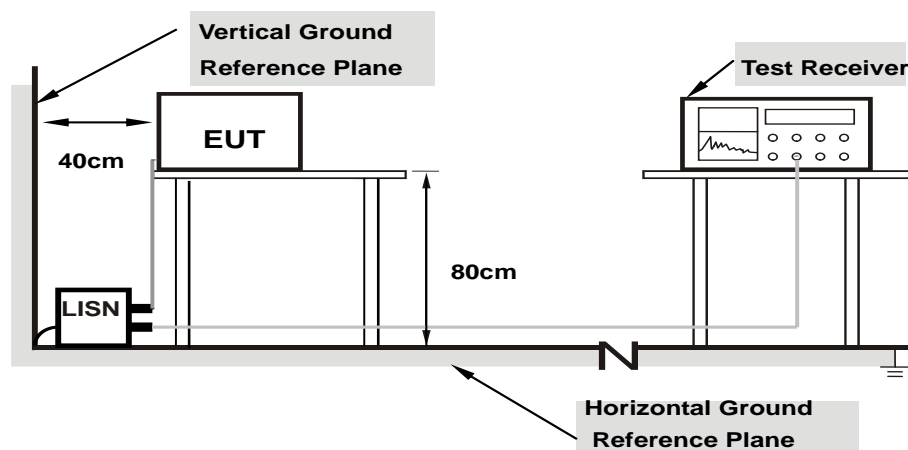

**Note: 1.Support units were connected to second LISN.**

For the actual test configuration, please refer to the attached file (Test Setup Photo).

#### 4.2.6 EUT Operating Condition

Same as 4.1.6.

#### 4.2.7 Test Results (Mode 1)

Phase	Line (L)	Detector Function	Quasi-Peak (QP) / Average (AV)
-------	----------	-------------------	--------------------------------

No	Freq. [MHz]	Corr.	Reading Value		Emission Level		Limit		Margin	
		Factor (dB)	[dB (uV)]		[dB (uV)]		[dB (uV)]		(dB)	
			Q.P.	AV.	Q.P.	AV.	Q.P.	AV.	Q.P.	AV.
1	0.15781	10.19	26.91	7.66	37.10	17.85	65.58	55.58	-28.48	-37.73
2	0.17094	10.19	35.78	24.23	45.97	34.42	64.91	54.91	-18.94	-20.49
3	0.24388	10.20	25.58	16.01	35.78	26.21	61.96	51.96	-26.18	-25.75
4	0.42444	10.22	36.05	29.56	46.27	39.78	57.36	47.36	-11.09	-7.58
5	0.79844	10.25	17.95	5.23	28.20	15.48	56.00	46.00	-27.80	-30.52
6	17.92381	11.24	28.30	24.43	39.54	35.67	60.00	50.00	-20.46	-14.33

#### REMARKS:

1. Q.P. and AV. are abbreviations of quasi-peak and average individually.
2. The emission levels of other frequencies were very low against the limit.
3. Margin value = Emission level - Limit value
4. Correction factor = Insertion loss + Cable loss
5. Emission Level = Correction Factor + Reading Value.

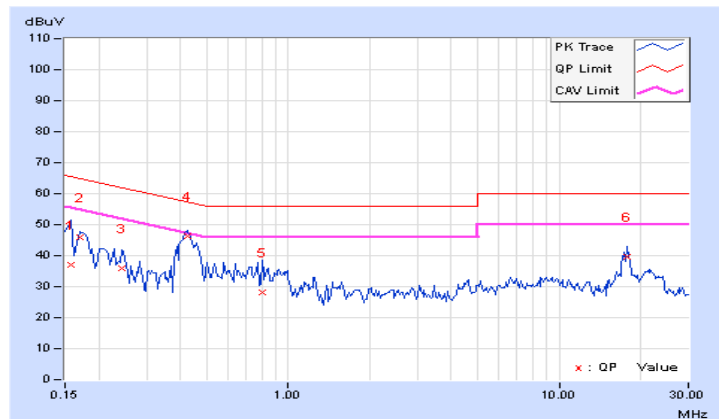

Phase	Neutral (N)	Detector Function	Quasi-Peak (QP) / Average (AV)
-------	-------------	-------------------	--------------------------------

No	Freq. [MHz]	Corr. Factor	Reading Value [dB (uV)]		Emission Level [dB (uV)]		Limit [dB (uV)]		Margin (dB)	
		(dB)	Q.P.	AV.	Q.P.	AV.	Q.P.	AV.	Q.P.	AV.
	1	0.15000	10.18	36.33	19.06	46.51	29.24	66.00	56.00	-19.49
2	0.17303	10.17	35.67	25.78	45.84	35.95	64.81	54.81	-18.97	-18.86
3	<b>0.42841</b>	<b>10.21</b>	<b>37.04</b>	<b>30.43</b>	<b>47.25</b>	<b>40.64</b>	<b>57.28</b>	<b>47.28</b>	<b>-10.03</b>	<b>-6.64</b>
4	0.59531	10.22	23.93	14.85	34.15	25.07	56.00	46.00	-21.85	-20.93
5	1.22266	10.24	22.90	15.80	33.14	26.04	56.00	46.00	-22.86	-19.96
6	17.45628	10.99	28.63	26.14	39.62	37.13	60.00	50.00	-20.38	-12.87

#### REMARKS:

1. Q.P. and AV. are abbreviations of quasi-peak and average individually.
2. The emission levels of other frequencies were very low against the limit.
3. Margin value = Emission level - Limit value
4. Correction factor = Insertion loss + Cable loss
5. Emission Level = Correction Factor + Reading Value.

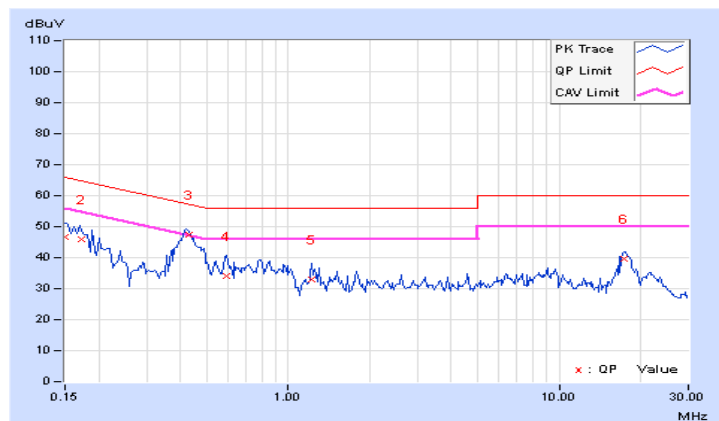

### 4.3 Transmit Power Measurement

#### 4.3.1 Limits of Transmit Power Measurement

Operation Band	EUT Category		Limit
U-NII-1		Outdoor Access Point	1 Watt (30 dBm) (Max. e.i.r.p $\leq$ 125mW(21 dBm) at any elevation angle above 30 degrees as measured from the horizon)
		Fixed point-to-point Access Point	1 Watt (30 dBm)
	√	Indoor Access Point	1 Watt (30 dBm)
		Mobile and Portable client device	250mW (24 dBm)
U-NII-2A		√	250mW (24 dBm) or 11 dBm+10 log B*
U-NII-2C		√	250mW (24 dBm) or 11 dBm+10 log B*
U-NII-3		√	1 Watt (30 dBm)

\*B is the 26 dB emission bandwidth in megahertz

Per KDB 662911 Method of conducted output power measurement on IEEE 802.11 devices,

Array Gain = 0 dB (i.e., no array gain) for  $N_{ANT} \leq 4$ ;

Array Gain = 0 dB (i.e., no array gain) for channel widths  $\geq 40$  MHz for any  $N_{ANT}$ ;

Array Gain =  $5 \log(N_{ANT}/N_{SS})$  dB or 3 dB, whichever is less for 20-MHz channel widths with  $N_{ANT} \geq 5$ .

For power measurements on all other devices: Array Gain =  $10 \log(N_{ANT}/N_{SS})$  dB.



#### 4.3.2 Test Setup

##### FOR POWER OUTPUT MEASUREMENT

For channel straddling 5725MHz:

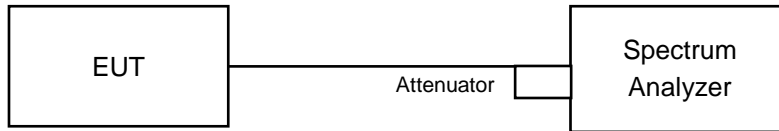

For other channels:

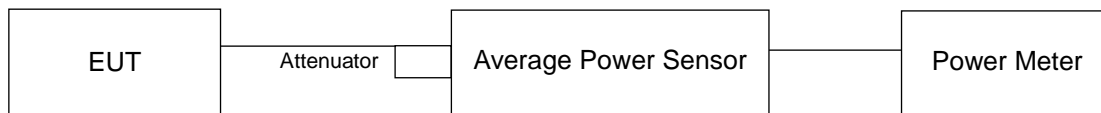

##### FOR 26dB OCCUPIED BANDWIDTH

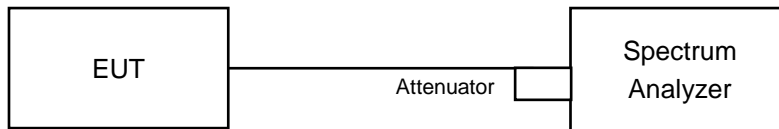

#### 4.3.3 Test Instruments

Refer to section 4.1.2 to get information of above instrument.

#### 4.3.4 Test Procedure

##### For Average Power Measurement

##### For channel straddling 5725MHz:

##### 802.11ac (VHT20)

###### Method SA-1

1. Set span to encompass the entire emission bandwidth (EBW) of the signal.
2. Set RBW =1MHz.
3. Set the VBW  $\geq 3 \times$  RBW.
4. Number of points in sweep  $\geq 2$  Span / RBW.
5. Sweep time = auto.
6. Set trigger to free run (duty cycle  $\geq 98$  percent)
7. Detector = RMS.
8. Trace average at least 100 traces in power averaging mode
9. Compute power by integrating the spectrum across the 26 dB EBW of the signal.

##### Other Modulation mode

###### Method SA-2

1. Set span to encompass the emission bandwidth (EBW) of the signal.
2. Set RBW =1MHz.
3. Set the VBW  $\geq 3 \times$  RBW.
4. Number of points in sweep  $\geq 2$  Span / RBW.
5. Sweep time = auto.
6. Detector = RMS.
7. Trace average at least 100 traces in power averaging mode
8. Compute power by integrating the spectrum across the 26 dB EBW of the signal.
9. Duty factor need added to measured value (duty cycle  $< 98$  percent).

##### For other channels:

Method PM is used to perform output power measurement, trigger and gating function of wide band power meter is enabled to measure max output power of TX on burst. Duty factor is not added to measured value.

##### FOR 26dB OCCUPIED BANDWIDTH

1. Set RBW = approximately 1% of the emission bandwidth.
2. Set the VBW  $>$  RBW.
3. Detector = Peak.
4. Trace mode = max hold.
5. Measure the maximum width of the emission that is 26 dB down from the peak of the emission. Compare this with the RBW setting of the analyzer. Readjust RBW and repeat measurement as needed until the RBW/EBW ratio is approximately 1%.

#### 4.3.5 Deviation from Test Standard

No deviation.

#### 4.3.6 EUT Operating Condition

The software provided by client to enable the EUT under transmission condition continuously at lowest, middle and highest channel frequencies individually.

#### 4.3.7 Test Result (Mode 1)

#### CDD Mode

#### 802.11a

#### Power Output:

Chan.	Chan. Freq. (MHz)	Maximum Conducted Power (dBm)				Total Power (mW)	Total Power (dBm)	Limit (dBm)	Pass / Fail
		Chain 0	Chain 1	Chain 2	Chain 3				
52	5260	12.48	12.37	11.67	11.32	63.2	18.01	23.95	Pass
60	5300	12.68	12.23	11.62	12.24	66.516	18.23	23.97	Pass
64	5320	12.61	12.36	11.70	12.47	67.909	18.32	23.95	Pass
100	5500	12.65	12.09	11.16	12.22	64.323	18.08	23.98	Pass
116	5580	12.66	12.04	11.03	12.68	65.658	18.17	23.96	Pass
140	5700	12.72	12.02	11.09	12.58	65.595	18.17	24.00	Pass
*144 (UNII-2C Band)	5720	8.77	7.94	6.88	8.92	27.251	14.35	22.69	Pass
*144 (UNII-3 Band)	5720	2.71	1.99	0.85	3.08	6.903	8.39	30.00	Pass

Note: \* Test was performed in accordance with Measurement follow FCC KDB 789033 UNII test procedure Method SA-2 and use spectrum analyzer test.

The Total Power for the straddle channel:

Chan.	Chan. Freq. (MHz)	Average Power (mW)	Average Power (dBm)
144	5720	34.154	15.33

Note: The total power was calculated through formula and record the value for reference only.

**26dB BANDWIDTH:**

Channel	Frequency (MHz)	26dBc Bandwidth (MHz)			
		Chain 0	Chain 1	Chain 2	Chain 3
52	5260	20.23	19.97	20.29	19.75
60	5300	20.04	20.12	19.85	19.98
64	5320	20.56	20.17	20.10	19.75
100	5500	20.30	20.08	19.89	20.07
116	5580	20.37	19.78	20.03	20.21
140	5700	20.68	20.08	20.22	20.16
144 (UNII-2C Band)	5720	15.19	15.10	14.84	14.77

**Note: For U\_NII-2A, U\_NII-2C Band output power limitation is determined based on 26dBc bandwidth.**

Power Limit = 11dBm + 10logB < U_NII-2A, U_NII-2C >			
Channel Number	Freq.(MHz)	Min. B(MHz)	Determined Conducted Limit (dBm)
52	5260	19.75	23.95 < 24
60	5300	19.85	23.97 < 24
64	5320	19.75	23.95 < 24
100	5500	19.89	23.98 < 24
116	5580	19.78	23.96 < 24
140	5700	20.08	24.02 > 24
144 (UNII-2C Band)	5720	14.77	22.69 < 24

**802.11ac (VHT20)**
**POWER OUTPUT:**

Chan.	Chan. Freq. (MHz)	Maximum Conducted Power (dBm)				Total Power (mW)	Total Power (dBm)	Limit (dBm)	Pass / Fail
		Chain 0	Chain 1	Chain 2	Chain 3				
52	5260	12.56	12.41	11.64	12.52	67.901	18.32	24.00	Pass
60	5300	12.96	12.60	11.20	12.22	67.822	18.31	24.00	Pass
64	5320	12.82	12.49	11.35	12.26	67.358	18.28	24.00	Pass
100	5500	13.12	12.22	11.23	12.36	67.677	18.30	24.00	Pass
116	5580	13.05	12.01	11.06	12.75	67.669	18.30	24.00	Pass
140	5700	12.81	11.84	11.11	13.09	67.657	18.30	24.00	Pass
*144 (UNII-2C Band)	5720	9.28	8.11	7.28	8.97	28.178	14.50	22.85	Pass
*144 (UNII-3 Band)	5720	3.83	2.62	1.93	3.58	8.083	9.08	30.00	Pass

Note: \* Test was performed in accordance with Measurement follow FCC KDB 789033 UNII test procedure Method SA-1 and use spectrum analyzer test.

The Total Power for the straddle channel:

Chan.	Chan. Freq. (MHz)	Average Power (mW)	Average Power (dBm)
144	5720	36.261	15.59

Note: The total power was calculated through formula and record the value for reference only.

**26dB BANDWIDTH:**

Channel	Frequency (MHz)	26dBc Bandwidth (MHz)			
		Chain 0	Chain 1	Chain 2	Chain 3
52	5260	21.02	21.08	20.87	20.97
60	5300	21.55	21.07	20.81	20.95
64	5320	21.05	21.17	20.88	20.64
100	5500	21.29	21.00	20.91	20.96
116	5580	21.27	20.95	20.49	21.28
140	5700	21.17	20.69	20.59	20.97
144 (UNII-2C Band)	5720	15.54	15.38	15.71	15.33

**Note: For U\_NII-2A, U\_NII-2C Band output power limitation is determined based on 26dBc bandwidth.**

Power Limit = 11dBm + 10logB < U_NII-2A, U_NII-2C >			
Channel Number	Freq.(MHz)	Min. B(MHz)	Determined Conducted Limit (dBm)
52	5260	20.87	24.19 > 24
60	5300	20.81	24.18 > 24
64	5320	20.64	24.14 > 24
100	5500	20.91	24.2 > 24
116	5580	20.49	24.11 > 24
140	5700	20.59	24.13 > 24
144 (UNII-2C Band)	5720	15.33	22.85 < 24

**802.11ac (VHT40)**
**POWER OUTPUT:**

Chan.	Chan. Freq. (MHz)	Maximum Conducted Power (dBm)				Total Power (mW)	Total Power (dBm)	Limit (dBm)	Pass / Fail
		Chain 0	Chain 1	Chain 2	Chain 3				
54	5270	15.12	15.10	14.57	15.11	125.944	21.00	24.00	Pass
62	5310	12.62	12.60	12.21	12.70	71.733	18.56	24.00	Pass
102	5510	12.32	12.10	11.87	12.20	65.257	18.15	24.00	Pass
110	5550	16.09	15.16	14.69	15.14	135.557	21.32	24.00	Pass
134	5670	15.06	14.22	13.87	14.20	109.168	20.38	24.00	Pass
*142 (UNII-2C Band)	5710	12.94	11.54	11.28	12.28	65.964	18.19	24.00	Pass
*142 (UNII-3 Band)	5710	1.70	0.38	-0.01	1.43	5.0891	7.07	30.00	Pass

Note: \* Test was performed in accordance with Measurement follow FCC KDB 789033 UNII test procedure Method SA-2 and use spectrum analyzer test.

The Total Power for the straddle channel:

Chan.	Chan. Freq. (MHz)	Average Power (mW)	Average Power (dBm)
142	5710	71.0531	18.52

Note: The total power was calculated through formula and record the value for reference only.

**26dB BANDWIDTH:**

Channel	Frequency (MHz)	26dBc Bandwidth (MHz)			
		Chain 0	Chain 1	Chain 2	Chain 3
54	5270	41.11	41.09	41.04	41.05
62	5310	41.03	41.08	40.86	40.69
102	5510	40.93	40.96	40.96	40.92
110	5550	41.25	41.11	41.11	40.90
134	5670	41.47	40.93	40.72	40.79
142 (UNII-2C Band)	5710	35.57	35.47	35.32	35.41

**Note: For U\_NII-2A, U\_NII-2C Band output power limitation is determined based on 26dBc bandwidth.**

Power Limit = 11dBm + 10logB < U_NII-2A, U_NII-2C >			
Channel Number	Freq.(MHz)	Min. B(MHz)	Determined Conducted Limit (dBm)
54	5270	41.04	27.13 > 24
62	5310	40.69	27.09 > 24
102	5510	40.92	27.11 > 24
110	5550	40.90	27.11 > 24
134	5670	40.72	27.09 > 24
142 (UNII-2C Band)	5710	35.32	26.48 > 24



**802.11ac (VHT80)**
**POWER OUTPUT:**

Chan.	Chan. Freq. (MHz)	Maximum Conducted Power (dBm)				Total Power (mW)	Total Power (dBm)	Limit (dBm)	Pass / Fail
		Chain 0	Chain 1	Chain 2	Chain 3				
58	5290	10.90	9.87	9.65	10.15	41.585	16.19	24.00	Pass
106	5530	9.89	8.78	8.65	9.12	32.795	15.16	24.00	Pass
122	5610	14.62	13.69	13.77	14.70	105.696	20.24	24.00	Pass
*138 (UNII-2C Band)	5690	15.38	13.76	13.72	14.58	116.757	20.67	24.00	Pass
*138 (UNII-3 Band)	5690	1.24	0.02	0.10	1.03	4.886	6.89	30.00	Pass

Note: \* Test was performed in accordance with Measurement follow FCC KDB 789033 UNII test procedure Method SA-2 and use spectrum analyzer test.

The Total Power for the straddle channel:

Chan.	Chan. Freq. (MHz)	Average Power (mW)	Average Power (dBm)
138	5690	121.643	20.85

Note: The total power was calculated through formula and record the value for reference only.

**26dB BANDWIDTH:**

Channel	Frequency (MHz)	26dBc Bandwidth (MHz)			
		Chain 0	Chain 1	Chain 2	Chain 3
58	5290	84.75	83.48	83.69	83.93
106	5530	84.17	83.23	84.16	82.54
122	5610	84.88	83.64	84.24	83.54
138 (UNII-2C Band)	5690	96.03	76.86	76.33	78.31

**Note: For U\_NII-2A, U\_NII-2C Band output power limitation is determined based on 26dBc bandwidth.**

Power Limit = 11dBm + 10logB < U_NII-2A, U_NII-2C >			
Channel Number	Freq.(MHz)	Min. B(MHz)	Determined Conducted Limit (dBm)
58	5290	83.48	30.21 > 24
106	5530	82.54	30.16 > 24
122	5610	83.54	30.21 > 24
138 (UNII-2C Band)	5690	76.33	29.82 > 24

**802.11ac (VHT80+80)**
**POWER OUTPUT:**

Chan.	Chan. Freq. (MHz)	Maximum Conducted Power (dBm)				Total Power (mW)	Total Power (dBm)	Limit (dBm)	Pass / Fail
		Chain 0	Chain 1	Chain 2	Chain 3				
42+58	5210	9.26	9.96	-	-	18.341	12.63	30.00	Pass
	5290	-	-	9.91	10.84	21.929	13.41	24.00	Pass
42+106	5210	9.26	9.96	-	-	18.341	12.63	30.00	Pass
	5530	-	-	9.59	10.81	21.149	13.25	24.00	Pass
42+122	5210	9.26	9.96	-	-	18.341	12.63	30.00	Pass
	5610	-	-	9.76	10.56	20.838	13.19	24.00	Pass
42+ 138* (UNII-2C)+ 138* (UNII-3)	5210	9.26	9.96	-	-	18.341	12.63	30.00	Pass
	5690	-	-	6.46	7.39	10.277	10.12	24.00	Pass
	5690	-	-	-8.01	-6.22	0.4116	-3.86	30.00	Pass
58+106	5290	9.87	10.45	-	-	20.797	13.18	24.00	Pass
	5530	-	-	9.52	10.92	21.313	13.29	24.00	Pass
58+122	5290	11.43	11.77	-	-	28.931	14.61	24.00	Pass
	5610	-	-	10.93	11.79	27.489	14.39	24.00	Pass
58+ 138* (UNII-2C)+ 138* (UNII-3)	5290	11.43	11.77	-	-	28.931	14.61	24.00	Pass
	5690	-	-	8.00	8.93	14.651	11.66	24.00	Pass
	5690	-	-	-6.03	-5.09	0.58	-2.37	30.00	Pass
58+155	5290	11.43	11.77	-	-	28.931	14.61	24.00	Pass
	5775	-	-	10.94	11.87	27.799	14.44	30.00	Pass
106+122	5530	9.98	10.02	-	-	38.921	15.90	24.00	Pass
	5610	-	-	9.33	10.15				
106+ 138*(UNII-2C)+ 138*(UNII-3)	5530	9.98	10.02	-	-	29.173	14.65	24.00	Pass
	5690	-	-	5.95	6.91				
	5690	-	-	-7.33	-6.80				
106+155	5530	9.98	10.02	-	-	20	13.01	24.00	Pass
	5775	-	-	9.38	10.10	18.903	12.77	30.00	Pass
122+ 138*(UNII-2C)+ 138*(UNII-3)	5610	17.91	17.98	-	-	186.325	22.70	24.00	Pass
	5690	-	-	14.24	15.18				
	5690	-	-	0.49	0.39				
122+155	5610	18.94	19.03	-	-	158.326	22.00	24.00	Pass
	5775	-	-	18.31	19.35	153.863	21.87	30.00	Pass

Chan.	Chan. Freq. (MHz)	Maximum Conducted Power (dBm)				Total Power (mW)	Total Power (dBm)	Limit (dBm)	Pass / Fail
138* (UNII-2C)+ 138* (UNII-3)+ 155	5690	15.50	15.86	-	-	76.778	18.85	24.00	Pass
	5690	1.62	2.30	-	-	157.13	21.96	30.00	Pass
	5775	-	-	18.31	19.35				Pass

Note: \* Test was performed in accordance with Measurement follow FCC KDB 789033 UNII test procedure Method SA-2 and use spectrum analyzer test.

The Total Power for the straddle channel:

Chan.	Chan. Freq. (MHz)	Average Power (mW)	Average Power (dBm)
42+138 (UNII-2C) +138 (UNII-3)	5690	10.6886	10.29
58+138 (UNII-2C) +138 (UNII-3)	5690	15.231	11.83
106+138 (UNII-2C) +138 (UNII-3)	5690	9.5819	9.81
122+138 (UNII-2C) +138 (UNII-3)	5690	64.0121	18.06
138 (UNII-2C) +138 (UNII-3)+155	5690	80.0452	19.03

Note: The total power was calculated through formula and record the value for reference only.

**26dB BANDWIDTH:**

Channel	Frequency (MHz)	26dBc Bandwidth (MHz)			
		Chain 0	Chain 1	Chain 2	Chain 3
42+58	5210	84.42	83.75	-	-
	5290	-	-	131.00	84.20
42+106	5210	84.42	83.75	-	-
	5530	-	-	85.06	85.07
42+122	5210	84.42	83.75	-	-
	5610	-	-	84.23	84.80
42+ 138 (UNII-2C)+ 138 (UNII-3)	5210	84.42	83.75	-	-
	5690	-	-	77.66	78.21
	5690	-	-	28.87	37.05
58+106	5290	84.61	84.65	-	-
	5530	-	-	85.06	85.07
58+122	5290	84.61	84.65	-	-
	5610	-	-	84.23	84.80
58+138 (UNII-2C)+ 138 (UNII-3)	5290	84.61	84.65	-	-
	5690	-	-	77.66	78.21
	5690	-	-	28.87	37.05
58+155	5290	84.61	84.65	-	-
	5775	-	-	168.89	148.98
106+122	5530	84.25	84.19	-	-
	5610	-	-	84.23	84.80
106+138 (UNII-2C)+ 138 (UNII-3)	5530	84.25	84.19	-	-
	5690	-	-	77.66	78.21
	5690	-	-	28.87	37.05
106+155	5530	84.25	84.19	-	-
	5775	-	-	168.89	148.98
122+138 (UNII-2C)+ 138 (UNII-3)	5610	97.60	96.62	-	-
	5690	-	-	77.66	78.21
	5690	-	-	28.87	37.05
122+155	5610	97.60	96.62	-	-
	5775	-	-	168.89	148.98
138 (UNII-2C)+ 138 (UNII-3) +155	5690	77.70	77.40	-	-
	5690	33.65	26.44	-	-
	5775	-	-	168.89	148.98

**Note: For U\_NII-2A, U\_NII-2C Band output power limitation is determined based on 26dBc bandwidth.**

Power Limit = 11dBm + 10logB < U_NII-2A, U_NII-2C >			
Channel Number	Freq.(MHz)	Min. B(MHz)	Determined Conducted Limit (dBm)
42+58	5210	-	-
	5290	84.61	30.27 > 24
42+106	5210	-	-
	5530	84.19	30.25 > 24
42+122	5210	-	-
	5610	96.62	30.85 > 24
42+ 138 (UNII-2C)	5210	-	-
	5690	77.40	29.88 > 24
58+106	5290	84.61	30.27 > 24
	5530	84.19	30.25 > 24
58+122	5290	84.61	30.27 > 24
	5610	96.62	30.85 > 24
58+138 (UNII-2C)+ 138 (UNII-3)	5290	84.61	30.27 > 24
	5690	77.40	29.88 > 24
	5690	-	-
58+155	5290	84.61	30.27 > 24
	5775	-	-
106+122	5530	84.19	30.25 > 24
	5610	96.62	30.85 > 24
106+138 (UNII-2C)+ 138 (UNII-3)	5530	84.19	30.25 > 24
	5690	77.40	29.88 > 24
	5690	-	- 24
106+155	5530	84.19	30.25 > 24
	5775	-	-
122+138 (UNII-2C)+ 138 (UNII-3)	5610	96.62	30.85 > 24
	5690	77.40	29.88 > 24
	5690	-	-
122+155	5610	96.62	30.85 > 24
	5775	-	-
138 (UNII-2C)+ 138 (UNII-3) +155	5690	77.40	29.88 > 24
	5690	-	-
	5775	-	-

**Spectrum Plot of Worst Value**

**802.11a / Chain 3 - CH144 (UNII-2C Band)**

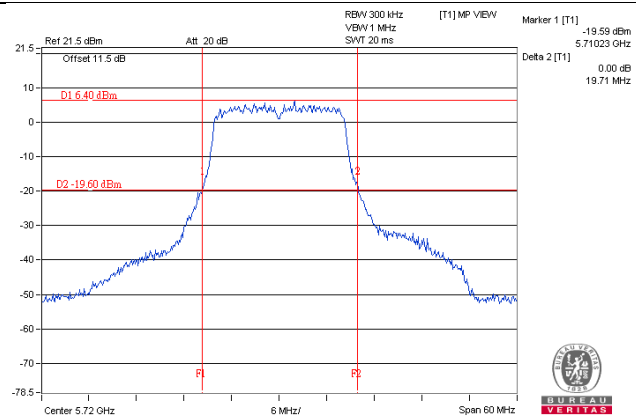

**802.11ac (VHT20) / Chain 3 - CH144 (UNII-2C Band)**

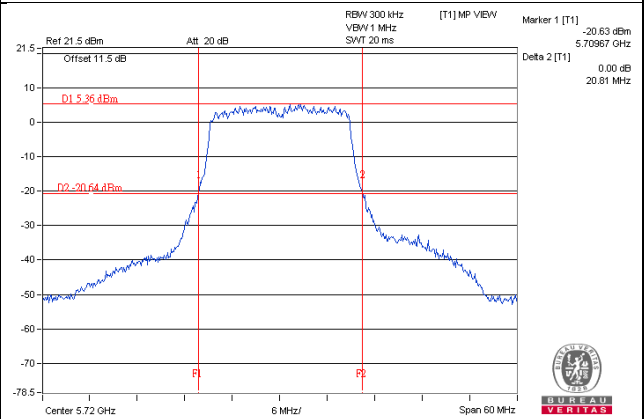

**802.11ac (VHT40) / Chain 2 - CH142 (UNII-2C Band)**

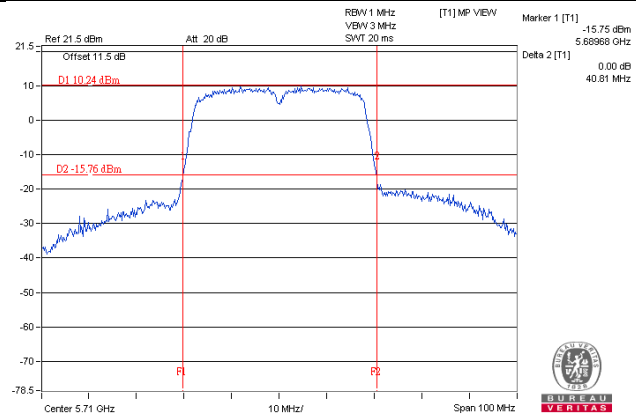

**802.11ac (VHT80) / Chain 2 - CH138 (UNII-2C Band)**

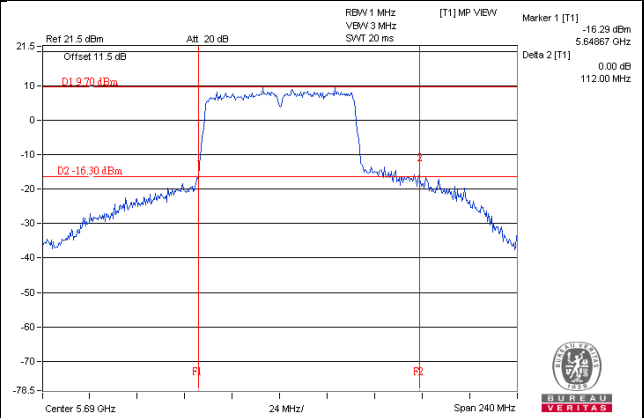

**802.11ac (VHT80+80) / Chain 1 - CH138 (UNII-2C Band)**

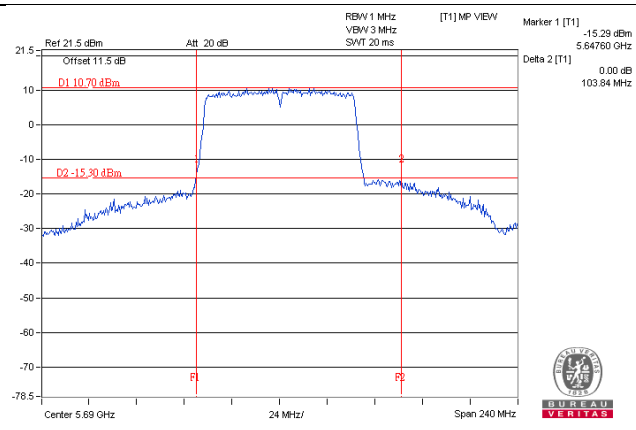

**NOTE:**

- For CH144 (UNII-2C Band) = 5725MHz - Marker 1
- For CH142 (UNII-2C Band) = 5725MHz - Marker 1
- For CH138 (UNII-2C Band) = 5725MHz - Marker 1

## Beamforming Mode

### 802.11ac (VHT20)

#### POWER OUTPUT:

Chan.	Chan. Freq. (MHz)	Maximum Conducted Power (dBm)				Total Power (mW)	Total Power (dBm)	Limit (dBm)	Pass / Fail
		Chain 0	Chain 1	Chain 2	Chain 3				
52	5260	12.56	12.41	11.64	12.52	67.901	18.32	18.33	Pass
60	5300	12.96	12.60	11.20	12.22	67.822	18.31	18.33	Pass
64	5320	12.82	12.49	11.35	12.26	67.358	18.28	18.33	Pass
100	5500	13.12	12.22	11.23	12.36	67.677	18.30	18.33	Pass
116	5580	13.05	12.01	11.06	12.75	67.669	18.30	18.33	Pass
140	5700	12.81	11.84	11.11	13.09	67.657	18.30	18.33	Pass
*144 (UNII-2C Band)	5720	9.28	8.11	7.28	8.97	28.178	14.50	17.18	Pass
*144 (UNII-3 Band)	5720	3.83	2.62	1.93	3.58	8.083	9.08	24.33	Pass

Note: 1. \* Test was performed in accordance with Measurement follow FCC KDB 789033 UNII test procedure Method SA-1 and use spectrum analyzer test.

2. For UNII-2A & UNII-2C: Directional gain =  $10 \log[(10^{G1/20} + 10^{G2/20} + 10^{G3/20} + 10^{G4/20})^2 / 4] = 11.67\text{dBi} > 6\text{dBi}$ , so the power limit shall be reduced to "Determined Conducted Limit" -(11.67-6).

3. For UNII-3: Directional gain =  $10 \log[(10^{G1/20} + 10^{G2/20} + 10^{G3/20} + 10^{G4/20})^2 / 4] = 11.67\text{dBi} > 6\text{dBi}$ , so the power limit shall be reduced to  $30 - (11.67 - 6) = 24.33\text{dBm}$ .

The Total Power for the straddle channel:

Chan.	Chan. Freq. (MHz)	Average Power (mW)	Average Power (dBm)
144	5720	36.261	15.59

Note: The total power was calculated through formula and record the value for reference only.



**26dB BANDWIDTH:**

Channel	Frequency (MHz)	26dBc Bandwidth (MHz)			
		Chain 0	Chain 1	Chain 2	Chain 3
52	5260	21.02	21.08	20.87	20.97
60	5300	21.55	21.07	20.81	20.95
64	5320	21.05	21.17	20.88	20.64
100	5500	21.29	21.00	20.91	20.96
116	5580	21.27	20.95	20.49	21.28
140	5700	21.17	20.69	20.59	20.97
144 (UNII-2C Band)	5720	15.54	15.38	15.71	15.33

**Note: For U\_NII-2A, U\_NII-2C Band output power limitation is determined based on 26dBc bandwidth.**

Power Limit = 11dBm + 10logB < U_NII-2A, U_NII-2C >			
Channel Number	Freq.(MHz)	Min. B(MHz)	Determined Conducted Limit (dBm)
52	5260	20.87	24.19 > 24
60	5300	20.81	24.18 > 24
64	5320	20.64	24.14 > 24
100	5500	20.91	24.2 > 24
116	5580	20.49	24.11 > 24
140	5700	20.59	24.13 > 24
144 (UNII-2C Band)	5720	15.33	22.85 < 24

## 802.11ac (VHT40)

### POWER OUTPUT:

Chan.	Chan. Freq. (MHz)	Maximum Conducted Power (dBm)				Total Power (mW)	Total Power (dBm)	Limit (dBm)	Pass / Fail
		Chain 0	Chain 1	Chain 2	Chain 3				
54	5270	12.42	11.68	11.58	13.05	66.753	18.24	18.33	Pass
62	5310	12.43	11.54	11.24	12.94	64.738	18.11	18.33	Pass
102	5510	12.32	12.10	11.87	12.20	65.257	18.15	18.33	Pass
110	5550	13.27	11.82	10.53	13.05	67.919	18.32	18.33	Pass
134	5670	13.04	11.31	9.81	13.21	64.171	18.07	18.33	Pass
*142 (UNII-2C Band)	5710	9.49	7.79	6.08	10.07	29.89	14.76	18.33	Pass
*142 (UNII-3 Band)	5710	-1.40	-3.18	-4.82	-0.87	2.4154	3.83	24.33	Pass

Note: 1. \* Test was performed in accordance with Measurement follow FCC KDB 789033 UNII test procedure Method SA-2 and use spectrum analyzer test.

2. For UNII-2A & UNII-2C: Directional gain =  $10 \log[(10^{G1/20} + 10^{G2/20} + 10^{G3/20} + 10^{G4/20})^2 / 4] = 11.67\text{dBi} > 6\text{dBi}$ , so the power limit shall be reduced to "Determined Conducted Limit" -(11.67-6).

3. For UNII-3: Directional gain =  $10 \log[(10^{G1/20} + 10^{G2/20} + 10^{G3/20} + 10^{G4/20})^2 / 4] = 11.67\text{dBi} > 6\text{dBi}$ , so the power limit shall be reduced to  $30-(11.67-6) = 24.33\text{dBm}$ .

The Total Power for the straddle channel:

Chan.	Chan. Freq. (MHz)	Average Power (mW)	Average Power (dBm)
142	5710	32.3054	15.09

Note: The total power was calculated through formula and record the value for reference only.

**26dB BANDWIDTH:**

Channel	Frequency (MHz)	26dBc Bandwidth (MHz)			
		Chain 0	Chain 1	Chain 2	Chain 3
54	5270	41.11	41.09	41.04	41.05
62	5310	41.03	41.08	40.86	40.69
102	5510	40.93	40.96	40.96	40.92
110	5550	41.25	41.11	41.11	40.90
134	5670	41.47	40.93	40.72	40.79
142 (UNII-2C Band)	5710	35.57	35.47	35.32	35.41

**Note: For U\_NII-2A, U\_NII-2C Band output power limitation is determined based on 26dBc bandwidth.**

Power Limit = 11dBm + 10logB < U_NII-2A, U_NII-2C >			
Channel Number	Freq.(MHz)	Min. B(MHz)	Determined Conducted Limit (dBm)
54	5270	41.04	27.13 > 24
62	5310	40.69	27.09 > 24
102	5510	40.92	27.11 > 24
110	5550	40.90	27.11 > 24
134	5670	40.72	27.09 > 24
142 (UNII-2C Band)	5710	35.32	26.48 > 24

## 802.11ac (VHT80)

### POWER OUTPUT:

Chan.	Chan. Freq. (MHz)	Maximum Conducted Power (dBm)				Total Power (mW)	Total Power (dBm)	Limit (dBm)	Pass / Fail
		Chain 0	Chain 1	Chain 2	Chain 3				
58	5290	10.90	9.87	9.65	10.15	41.585	16.19	18.33	Pass
106	5530	9.89	8.78	8.65	9.12	32.795	15.16	18.33	Pass
122	5610	13.10	11.32	10.22	12.84	63.72	18.04	18.33	Pass
*138 (UNII-2C Band)	5690	9.32	7.71	6.40	9.74	29.825	14.75	18.33	Pass
*138 (UNII-3 Band)	5690	-4.01	-5.49	-6.45	-3.65	1.4129	1.50	24.33	Pass

Note: 1. \* Test was performed in accordance with Measurement follow FCC KDB 789033 UNII test procedure Method SA-2 and use spectrum analyzer test.

2. For UNII-2A & UNII-2C: Directional gain =  $10 \log[(10^{G1/20} + 10^{G2/20} + 10^{G3/20} + 10^{G4/20})^2 / 4] = 11.67\text{dBi} > 6\text{dBi}$ , so the power limit shall be reduced to "Determined Conducted Limit" -(11.67-6).

3. For UNII-3: Directional gain =  $10 \log[(10^{G1/20} + 10^{G2/20} + 10^{G3/20} + 10^{G4/20})^2 / 4] = 11.67\text{dBi} > 6\text{dBi}$ , so the power limit shall be reduced to  $30 - (11.67 - 6) = 24.33\text{dBm}$ .

The Total Power for the straddle channel:

Chan.	Chan. Freq. (MHz)	Average Power (mW)	Average Power (dBm)
138	5690	31.2379	14.95

Note: The total power was calculated through formula and record the value for reference only.

**26dB BANDWIDTH:**

Channel	Frequency (MHz)	26dBc Bandwidth (MHz)			
		Chain 0	Chain 1	Chain 2	Chain 3
58	5290	84.75	83.48	83.69	83.93
106	5530	84.17	83.23	84.16	82.54
122	5610	84.88	83.64	84.24	83.54
138 (UNII-2C Band)	5690	96.03	76.86	76.33	78.31

**Note: For U\_NII-2A, U\_NII-2C Band output power limitation is determined based on 26dBc bandwidth**

Power Limit = 11dBm + 10logB < U_NII-2A, U_NII-2C >			
Channel Number	Freq.(MHz)	Min. B(MHz)	Determined Conducted Limit (dBm)
58	5290	83.48	30.21 > 24
106	5530	82.54	30.16 > 24
122	5610	83.54	30.21 > 24
138 (UNII-2C Band)	5690	76.33	29.82 > 24

**802.11ac (VHT80+80)**
**POWER OUTPUT:**

Chan.	Chan. Freq. (MHz)	Maximum Conducted Power (dBm)				Total Power (mW)	Total Power (dBm)	Limit (dBm)	Pass / Fail
		Chain 0	Chain 1	Chain 2	Chain 3				
42+58	5210	9.26	9.96	-	-	18.341	12.63	27.16	Pass
	5290	-	-	9.91	10.84	21.929	13.41	21.52	Pass
42+106	5210	9.26	9.96	-	-	18.341	12.63	27.16	Pass
	5530	-	-	9.59	10.81	21.149	13.25	21.52	Pass
42+122	5210	9.26	9.96	-	-	18.341	12.63	27.16	Pass
	5610	-	-	9.76	10.56	20.838	13.19	21.52	Pass
42+ 138* (UNII-2C)+ 138* (UNII-3)	5210	9.26	9.96	-	-	18.341	12.63	27.16	Pass
	5690	-	-	6.46	7.39	10.277	10.12	21.52	Pass
	5690	-	-	-8.01	-6.22	0.4116	-3.86	27.52	Pass
58+106	5290	9.87	10.45	-	-	20.797	13.18	21.16	Pass
	5530	-	-	9.52	10.92	21.313	13.29	21.52	Pass
58+122	5290	11.43	11.77	-	-	28.931	14.61	21.16	Pass
	5610	-	-	10.93	11.79	27.489	14.39	21.52	Pass
58+ 138* (UNII-2C)+ 138* (UNII-3)	5290	11.43	11.77	-	-	28.931	14.61	21.16	Pass
	5690	-	-	8.00	8.93	14.651	11.66	21.52	Pass
	5690	-	-	-6.03	-5.09	0.58	-2.37	27.52	Pass
58+155	5290	11.43	11.77	-	-	28.931	14.61	21.16	Pass
	5775	-	-	10.94	11.87	27.799	14.44	27.52	Pass
106+122	5530	9.98	10.02	-	-	38.921	15.90	18.33	Pass
	5610	-	-	9.33	10.15				
106+ 138*(UNII-2C)+ 138*(UNII-3)	5530	9.98	10.02	-	-	29.173	14.65	29.173	Pass
	5690	-	-	5.95	6.91				
	5690	-	-	-7.33	-6.80				
106+155	5530	9.98	10.02	-	-	20	13.01	21.16	Pass
	5775	-	-	9.38	10.10	18.903	12.77	27.52	Pass
122+ 138*(UNII-2C)+ 138*(UNII-3)	5610	12.49	12.56	-	-	51.828	17.15	18.33	Pass
	5690	-	-	8.37	9.35				
	5690	-	-	-5.12	-3.77				
122+155	5610	17.88	17.97	-	-	124.037	20.94	21.16	Pass
	5775	-	-	17.43	18.21	121.557	20.85	27.52	Pass

Chan.	Chan. Freq. (MHz)	Maximum Conducted Power (dBm)				Total Power (mW)	Total Power (dBm)	Limit (dBm)	Pass / Fail
138* (UNII-2C)+ 138* (UNII-3)+ 155	5690	14.51	14.73	-	-	60.119	17.79	21.16	Pass
	5690	1.08	1.24	-	-	124.266	20.94	24.33	Pass
	5775	-	-	17.43	18.21				Pass

Note: 1. \* Test was performed in accordance with Measurement follow FCC KDB 789033 UNII test procedure Method SA-2 and use spectrum analyzer test.

2. **For UNII-1 & UNII-3:** For Chain 0 & Chain 1: Directional gain =  $10 \log[(10^{G1/20} + 10^{G2/20})^2 / 2]$  = 8.84dBi > 6dBi , so the power limit shall be reduced to 30-(8.84-6) = 27.16dBm.

3. **For UNII-2A & UNII-2C:** For Chain 0 & Chain 1: Directional gain =  $10 \log[(10^{G1/20} + 10^{G2/20})^2 / 2]$  = 8.84dBi > 6dBi , so the power limit shall be reduced to 24-(8.84-6) = 21.16dBm.

4. **For UNII-1 & UNII-3:** For Chain 2 & Chain 3: Directional gain =  $10 \log[(10^{G1/20} + 10^{G2/20} + 10^{G3/20} + 10^{G4/20})^2 / 4]$  = 8.84dBi > 6dBi , so the power limit shall be reduced to 30-(8.48-6) = 27.52dBm.

5. **For UNII-2A & UNII-2C:** For Chain 2 & Chain 3: Directional gain =  $10 \log[(10^{G1/20} + 10^{G2/20} + 10^{G3/20} + 10^{G4/20})^2 / 4]$  = 8.84dBi > 6dBi , so the power limit shall be reduced to 24-(8.48-6) = 21.52dBm.

6. **For UNII-1 & UNII-3:** For Chain 0 & Chain 1 & Chain 2 & Chain 3: Directional gain =  $10 \log[(10^{G1/20} + 10^{G2/20} + 10^{G3/20} + 10^{G4/20})^2 / 4]$  = 11.67dBi > 6dBi , so the power limit shall be reduced to 30-(11.67-6) = 24.33dBm.

7. **For UNII-2A & UNII-2C:** For Chain 0 & Chain 1 & Chain 2 & Chain 3: Directional gain =  $10 \log[(10^{G1/20} + 10^{G2/20} + 10^{G3/20} + 10^{G4/20})^2 / 4]$  = 11.67dBi > 6dBi , so the power limit shall be reduced to 24-(11.67-6) = 18.33dBm.

The Total Power for the straddle channel:

Chan.	Chan. Freq. (MHz)	Average Power (mW)	Average Power (dBm)
42+138 (UNII-2C) +138 (UNII-3)	5690	10.6886	10.29
58+138 (UNII-2C) +138 (UNII-3)	5690	15.231	11.83
106+138 (UNII-2C) +138 (UNII-3)	5690	9.5819	9.81
122+138 (UNII-2C) +138 (UNII-3)	5690	16.8103	12.26
138 (UNII-2C) +138 (UNII-3)+155	5690	62.8277	17.98

Note: The total power was calculated through formula and record the value for reference only.

**26dB BANDWIDTH:**

Channel	Frequency (MHz)	26dBc Bandwidth (MHz)			
		Chain 0	Chain 1	Chain 2	Chain 3
42+58	5210	84.42	83.75	-	-
	5290	-	-	131.00	84.20
42+106	5210	84.42	83.75	-	-
	5530	-	-	85.06	85.07
42+122	5210	84.42	83.75	-	-
	5610	-	-	84.23	84.80
42+ 138 (UNII-2C)+ 138 (UNII-3)	5210	84.42	83.75	-	-
	5690	-	-	77.66	78.21
	5690	-	-	28.87	37.05
58+106	5290	84.61	84.65	-	-
	5530	-	-	85.06	85.07
58+122	5290	84.61	84.65	-	-
	5610	-	-	84.23	84.80
58+138 (UNII-2C)+ 138 (UNII-3)	5290	84.61	84.65	-	-
	5690	-	-	77.66	78.21
	5690	-	-	28.87	37.05
58+155	5290	84.61	84.65	-	-
	5775	-	-	168.89	148.98
106+122	5530	84.25	84.19	-	-
	5610	-	-	84.23	84.80
106+138 (UNII-2C)+ 138 (UNII-3)	5530	84.25	84.19	-	-
	5690	-	-	77.66	78.21
	5690	-	-	28.87	37.05
106+155	5530	84.25	84.19	-	-
	5775	-	-	168.89	148.98
122+138 (UNII-2C)+ 138 (UNII-3)	5610	97.60	96.62	-	-
	5690	-	-	77.66	78.21
	5690	-	-	28.87	37.05
122+155	5610	97.60	96.62	-	-
	5775	-	-	168.89	148.98
138 (UNII-2C)+ 138 (UNII-3) +155	5690	77.70	77.40	-	-
	5690	33.65	26.44	-	-
	5775	-	-	168.89	148.98

**Note: For U\_NII-2A, U\_NII-2C Band output power limitation is determined based on 26dBc bandwidth.**



Power Limit = 11dBm + 10logB < U_NII-2A, U_NII-2C >			
Channel Number	Freq.(MHz)	Min. B(MHz)	Determined Conducted Limit (dBm)
42+58	5210	-	-
	5290	84.61	30.27 > 24
42+106	5210	-	-
	5530	84.19	30.25 > 24
42+122	5210	-	-
	5610	96.62	30.85 > 24
42+ 138 (UNII-2C)	5210	-	-
	5690	77.40	29.88 > 24
58+106	5290	84.61	30.27 > 24
	5530	84.19	30.25 > 24
58+122	5290	84.61	30.27 > 24
	5610	96.62	30.85 > 24
58+138 (UNII-2C)+ 138 (UNII-3)	5290	84.61	30.27 > 24
	5690	77.40	29.88 > 24
	5690	-	-
58+155	5290	84.61	30.27 > 24
	5775	-	-
106+122	5530	84.19	30.25 > 24
	5610	96.62	30.85 > 24
106+138 (UNII-2C)+ 138 (UNII-3)	5530	84.19	30.25 > 24
	5690	77.40	29.88 > 24
	5690	-	- 24
106+155	5530	84.19	30.25 > 24
	5775	-	-
122+138 (UNII-2C)+ 138 (UNII-3)	5610	96.62	30.85 > 24
	5690	77.40	29.88 > 24
	5690	-	-
122+155	5610	96.62	30.85 > 24
	5775	-	-
138 (UNII-2C)+ 138 (UNII-3) +155	5690	77.40	29.88 > 24
	5690	-	-
	5775	-	-

Spectrum Plot of Worst Value

802.11ac (VHT20) / Chain 3 - CH144 (UNII-2C Band) 802.11ac (VHT40) / Chain 2 - CH142 (UNII-2C Band)

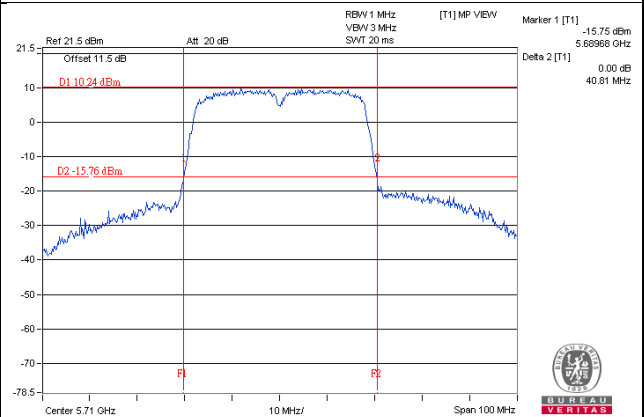
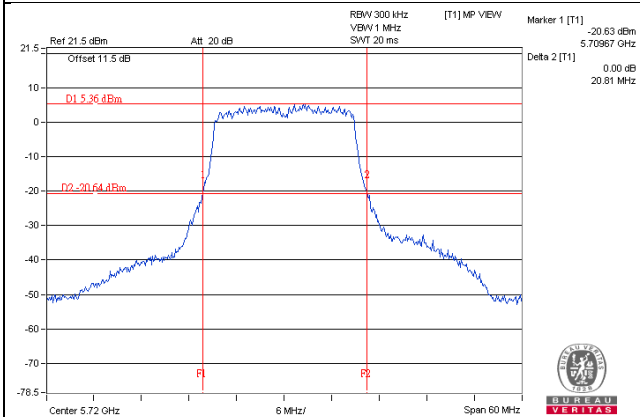

802.11ac (VHT80) / Chain 2 - CH138 (UNII-2C Band)

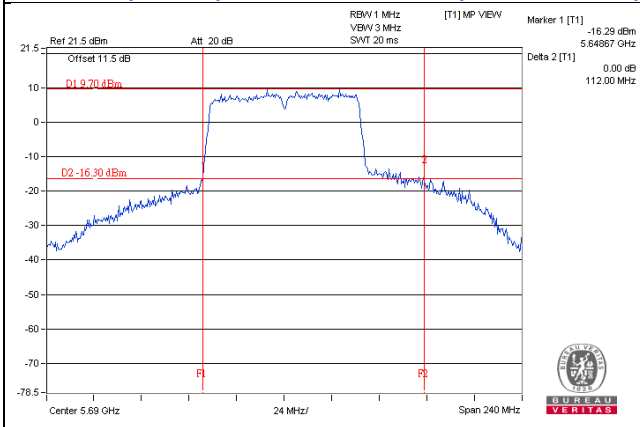

802.11ac (VHT80+80) / Chain 1 - CH138 (UNII-2C Band)

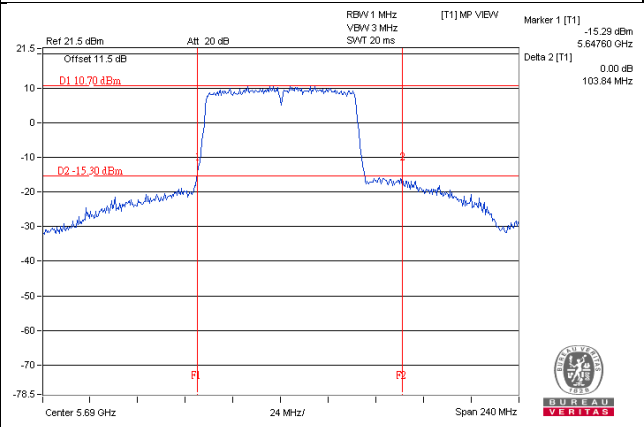

**NOTE:**

- For CH144 (UNII-2C Band) = 5725MHz - Marker 1
- For CH142 (UNII-2C Band) = 5725MHz - Marker 1
- For CH138 (UNII-2C Band) = 5725MHz - Marker 1

#### 4.3.8 Test Result (Mode 2)

##### CDD Mode

##### 802.11a

##### Power Output:

Chan.	Chan. Freq. (MHz)	Maximum Conducted Power (dBm)			Total Power (mW)	Total Power (dBm)	Limit (dBm)	Pass / Fail
		Chain 0	Chain 1	Chain 2				
52	5260	14.57	14.45	13.74	80.162	19.04	24.00	Pass
60	5300	15.06	14.56	14.04	85.99	19.34	24.00	Pass
64	5320	15.02	14.35	14.15	84.998	19.29	24.00	Pass
100	5500	15.38	14.63	13.36	85.231	19.31	24.00	Pass
116	5580	15.40	14.52	13.39	84.815	19.28	24.00	Pass
140	5700	15.43	14.38	13.31	83.759	19.23	23.95	Pass
*144 (UNII-2C Band)	5720	11.33	10.63	9.61	35.351	15.48	22.76	Pass
*144 (UNII-3 Band)	5720	5.27	4.39	3.82	8.788	9.44	30.00	Pass

Note: \* Test was performed in accordance with Measurement follow FCC KDB 789033 UNII test procedure Method SA-2 and use spectrum analyzer test.

The Total Power for the straddle channel:

Chan.	Chan. Freq. (MHz)	Average Power (mW)	Average Power (dBm)
144	5720	44.139	16.45

Note: The total power was calculated through formula and record the value for reference only.

**26dB BANDWIDTH:**

Channel	Frequency (MHz)	26dBc Bandwidth (MHz)		
		Chain 0	Chain 1	Chain 2
52	5260	20.84	20.61	20.25
60	5300	20.73	20.30	20.28
64	5320	20.34	20.23	20.80
100	5500	20.80	20.10	20.04
116	5580	20.83	20.27	20.31
140	5700	21.32	19.76	20.11
144 (UNII-2C Band)	5720	15.50	15.01	15.57

**Note: For U\_NII-2A, U\_NII-2C Band output power limitation is determined based on 26dBc bandwidth**

Power Limit = 11dBm + 10logB < U_NII-2A, U_NII-2C >			
Channel Number	Freq.(MHz)	Min. B(MHz)	Determined Conducted Limit (dBm)
52	5260	20.25	24.06 > 24
60	5300	20.28	24.07 > 24
64	5320	20.23	24.05 > 24
100	5500	20.04	24.01 > 24
116	5580	20.27	24.06 > 24
140	5700	19.76	23.95 < 24
144 (UNII-2C Band)	5720	15.01	22.76 < 24

**802.11ac (VHT20)**
**POWER OUTPUT:**

Chan.	Chan. Freq. (MHz)	Maximum Conducted Power (dBm)			Total Power (mW)	Total Power (dBm)	Limit (dBm)	Pass / Fail
		Chain 0	Chain 1	Chain 2				
52	5260	14.68	14.60	13.95	83.047	19.19	24.00	Pass
60	5300	14.71	14.66	14.00	83.941	19.24	24.00	Pass
64	5320	14.66	14.56	14.06	83.286	19.21	24.00	Pass
100	5500	15.48	14.55	13.76	87.596	19.42	24.00	Pass
116	5580	15.42	14.45	13.78	86.573	19.37	24.00	Pass
140	5700	15.55	14.58	13.75	88.314	19.46	24.00	Pass
*144 (UNII-2C Band)	5720	11.90	10.68	10.10	37.416	15.73	22.86	Pass
*144 (UNII-3 Band)	5720	6.36	5.08	4.76	10.538	10.23	30.00	Pass

Note: \* Test was performed in accordance with Measurement follow FCC KDB 789033 UNII test procedure Method SA-1 and use spectrum analyzer test.

The Total Power for the straddle channel:

Chan.	Chan. Freq. (MHz)	Average Power (mW)	Average Power (dBm)
144	5720	47.954	16.81

Note: The total power was calculated through formula and record the value for reference only.

**26dB BANDWIDTH:**

Channel	Frequency (MHz)	26dBc Bandwidth (MHz)		
		Chain 0	Chain 1	Chain 2
52	5260	21.03	21.13	21.05
60	5300	21.68	21.10	20.98
64	5320	21.68	20.79	20.96
100	5500	21.33	21.08	21.11
116	5580	21.58	21.48	21.21
140	5700	22.21	20.94	21.41
144 (UNII-2C Band)	5720	15.91	15.35	15.50

**Note: For FCC output power limitation is determined based on 26dB bandwidth.**

Power Limit = 11dBm + 10logB < U_NII-2A, U_NII-2C >			
Channel Number	Freq.(MHz)	Min. B(MHz)	Determined Conducted Limit (dBm)
52	5260	21.03	24.22 > 24
60	5300	20.98	24.21 > 24
64	5320	20.79	24.17 > 24
100	5500	21.08	24.23 > 24
116	5580	21.21	24.26 > 24
140	5700	20.94	24.2 > 24
144 (UNII-2C Band)	5720	15.35	22.86 < 24

**802.11ac (VHT40)**
**POWER OUTPUT:**

Chan.	Chan. Freq. (MHz)	Maximum Conducted Power (dBm)			Total Power (mW)	Total Power (dBm)	Limit (dBm)	Pass / Fail
		Chain 0	Chain 1	Chain 2				
54	5270	17.80	17.56	16.95	166.817	22.22	24.00	Pass
62	5310	14.92	13.95	13.28	77.158	18.87	24.00	Pass
102	5510	13.92	12.89	12.39	61.452	17.89	24.00	Pass
110	5550	18.37	17.62	16.72	173.506	22.39	24.00	Pass
134	5670	16.87	16.12	15.22	122.833	20.89	24.00	Pass
*142 (UNII-2C Band)	5710	15.08	13.75	13.46	80.169	19.04	24.00	Pass
*142 (UNII-3 Band)	5710	4.35	2.90	2.51	6.625	8.21	30.00	Pass

Note: \* Test was performed in accordance with Measurement follow FCC KDB 789033 UNII test procedure Method SA-2 and use spectrum analyzer test.

The Total Power for the straddle channel:

Chan.	Chan. Freq. (MHz)	Average Power (mW)	Average Power (dBm)
142	5710	86.794	19.38

Note: The total power was calculated through formula and record the value for reference only.

**26dB BANDWIDTH:**

Channel	Frequency (MHz)	26dBc Bandwidth (MHz)		
		Chain 0	Chain 1	Chain 2
54	5270	41.49	41.42	41.16
62	5310	41.23	40.80	40.89
102	5510	40.90	41.09	40.91
110	5550	41.50	41.15	41.05
134	5670	54.64	41.12	40.84
142 (UNII-2C Band)	5710	41.05	35.83	35.54

**Note: For U\_NII-2A, U\_NII-2C Band output power limitation is determined based on 26dBc bandwidth**

Power Limit = 11dBm + 10logB < U_NII-2A, U_NII-2C >			
Channel Number	Freq.(MHz)	Min. B(MHz)	Determined Conducted Limit (dBm)
54	5270	41.16	27.14 > 24
62	5310	40.80	27.1 > 24
102	5510	40.90	27.11 > 24
110	5550	41.05	27.13 > 24
134	5670	40.84	27.11 > 24
142 (UNII-2C Band)	5710	35.54	26.5 > 24



**802.11ac (VHT80)**
**POWER OUTPUT:**

Chan.	Chan. Freq. (MHz)	Maximum Conducted Power (dBm)			Total Power (mW)	Total Power (dBm)	Limit (dBm)	Pass / Fail
		Chain 0	Chain 1	Chain 2				
58	5290	9.69	8.19	7.35	21.336	13.29	24.00	Pass
106	5530	10.55	9.08	8.25	26.124	14.17	24.00	Pass
122	5610	16.51	15.58	14.75	110.766	20.44	24.00	Pass
*138 (UNII-2C Band)	5690	15.12	15.38	14.42	100.017	20.00	24.00	Pass
*138 (UNII-3 Band)	5690	2.03	1.63	1.13	4.593	6.62	30.00	Pass

Note: \* Test was performed in accordance with Measurement follow FCC KDB 789033 UNII test procedure Method SA-2 and use spectrum analyzer test.

The Total Power for the straddle channel:

Chan.	Chan. Freq. (MHz)	Average Power (mW)	Average Power (dBm)
138	5690	104.61	20.2

Note: The total power was calculated through formula and record the value for reference only.

**26dB BANDWIDTH:**

Channel	Frequency (MHz)	26dBc Bandwidth (MHz)		
		Chain 0	Chain 1	Chain 2
58	5290	84.20	83.10	83.67
106	5530	83.64	83.45	83.54
122	5610	98.58	84.28	83.37
138 (UNII-2C Band)	5690	86.71	90.80	78.64

**Note: For U\_NII-2A, U\_NII-2C Band output power limitation is determined based on 26dBc bandwidth**

Power Limit = 11dBm + 10logB < U_NII-2A, U_NII-2C >			
Channel Number	Freq.(MHz)	Min. B(MHz)	Determined Conducted Limit (dBm)
58	5290	83.10	30.19 > 24
106	5530	83.45	30.21 > 24
122	5610	83.37	30.21 > 24
138 (UNII-2C Band)	5690	78.64	29.95 > 24

**Spectrum Plot of Worst Value**

**802.11a / Chain 1 - CH144 (UNII-2C Band)**

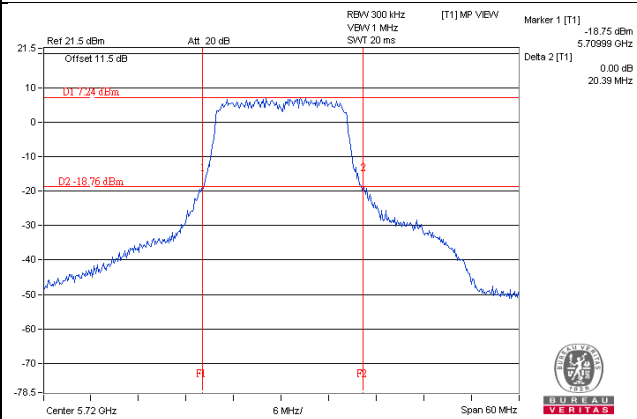

**802.11ac (VHT20) / Chain 1 - CH144 (UNII-2C Band)**

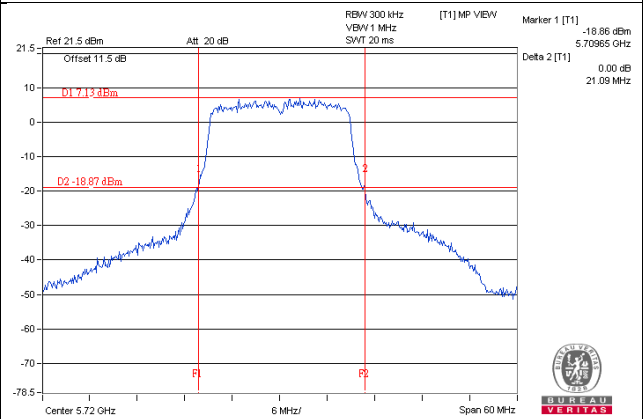

**802.11ac (VHT40) / Chain 2 - CH142 (UNII-2C Band)**

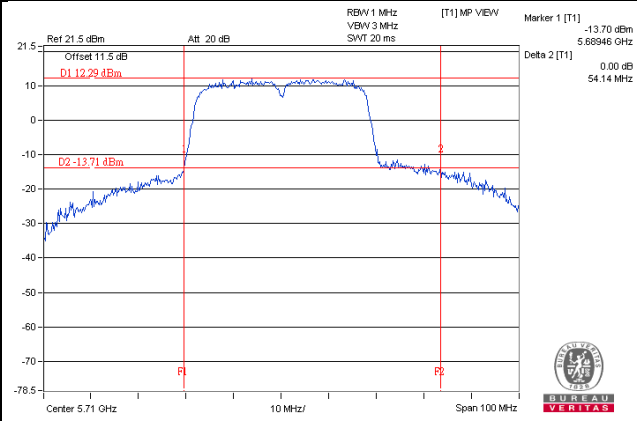

**802.11ac (VHT80) / Chain 2 - CH138 (UNII-2C Band)**

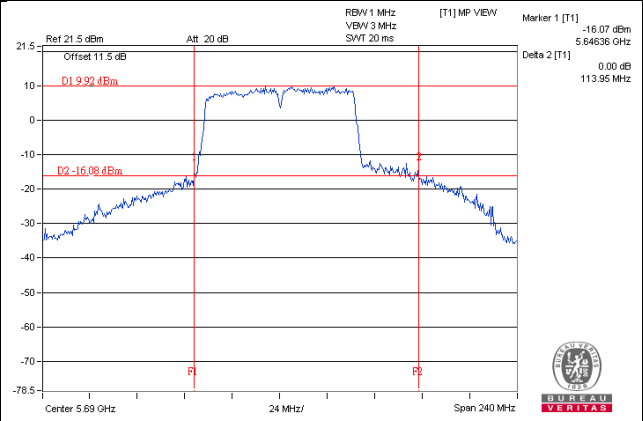

**NOTE:**

- For CH144 (UNII-2C Band) = 5725MHz - Marker 1
- For CH142 (UNII-2C Band) = 5725MHz - Marker 1
- For CH138 (UNII-2C Band) = 5725MHz - Marker 1

## Beamforming Mode

### 802.11ac (VHT20)

#### POWER OUTPUT:

Chan.	Chan. Freq. (MHz)	Maximum Conducted Power (dBm)			Total Power (mW)	Total Power (dBm)	Limit (dBm)	Pass / Fail
		Chain 0	Chain 1	Chain 2				
52	5260	14.68	14.60	13.95	83.047	19.19	19.47	Pass
60	5300	14.71	14.66	14.00	83.941	19.24	19.47	Pass
64	5320	14.66	14.56	14.06	83.286	19.21	19.47	Pass
100	5500	15.48	14.55	13.76	87.596	19.42	19.47	Pass
116	5580	15.42	14.45	13.78	86.573	19.37	19.47	Pass
140	5700	15.55	14.58	13.75	88.314	19.46	19.47	Pass
*144 (UNII-2C Band)	5720	11.90	10.68	10.10	37.416	15.73	18.33	Pass
*144 (UNII-3 Band)	5720	6.36	5.08	4.76	10.538	10.23	25.47	Pass

Note: 1. \* Test was performed in accordance with Measurement follow FCC KDB 789033 UNII test procedure Method SA-1 and use spectrum analyzer test.

2. For UNII-2A & UNII-2C: Directional gain =  $10 \log[(10^{G1/20} + 10^{G2/20} + 10^{G3/20})^2 / 3] = 10.53\text{dBi} > 6\text{dBi}$ , so the power limit shall be reduced to "Determined Conducted Limit"-(10.53-6).

3. For UNII-3: Directional gain =  $10 \log[(10^{G1/20} + 10^{G2/20} + 10^{G3/20})^2 / 3] = 10.53\text{dBi} > 6\text{dBi}$ , so the power limit shall be reduced to  $30-(10.53-6) = 25.47\text{dBm}$ .

The Total Power for the straddle channel:

Chan.	Chan. Freq. (MHz)	Average Power (mW)	Average Power (dBm)
144	5720	47.954	16.81

Note: The total power was calculated through formula and record the value for reference only.

**26dB BANDWIDTH:**

Channel	Frequency (MHz)	26dBc Bandwidth (MHz)		
		Chain 0	Chain 1	Chain 2
52	5260	21.03	21.13	21.05
60	5300	21.68	21.10	20.98
64	5320	21.68	20.79	20.96
100	5500	21.33	21.08	21.11
116	5580	21.58	21.48	21.21
140	5700	22.21	20.94	21.41
144 (UNII-2C Band)	5720	15.91	15.35	15.50

**Note: For FCC output power limitation is determined based on 26dB bandwidth.**

Power Limit = 11dBm + 10logB < U_NII-2A, U_NII-2C >			
Channel Number	Freq.(MHz)	Min. B(MHz)	Determined Conducted Limit (dBm)
52	5260	21.03	24.22 > 24
60	5300	20.98	24.21 > 24
64	5320	20.79	24.17 > 24
100	5500	21.08	24.23 > 24
116	5580	21.21	24.26 > 24
140	5700	20.94	24.2 > 24
144 (UNII-2C Band)	5720	15.35	22.86 < 24

## 802.11ac (VHT40)

### POWER OUTPUT:

Chan.	Chan. Freq. (MHz)	Maximum Conducted Power (dBm)			Total Power (mW)	Total Power (dBm)	Limit (dBm)	Pass / Fail
		Chain 0	Chain 1	Chain 2				
54	5270	14.81	14.51	13.88	82.952	19.19	19.47	Pass
62	5310	14.98	14.46	13.76	83.17	19.20	19.47	Pass
102	5510	15.55	14.42	13.48	85.845	19.34	19.47	Pass
110	5550	15.59	14.46	13.65	87.323	19.41	19.47	Pass
134	5670	15.61	14.44	13.77	88.012	19.45	19.47	Pass
*142 (UNII-2C Band)	5710	12.37	11.25	10.55	43.05	16.34	19.47	Pass
*142 (UNII-3 Band)	5710	1.57	0.25	-0.51	3.4733	5.41	25.47	Pass

Note: 1. \* Test was performed in accordance with Measurement follow FCC KDB 789033 UNII test procedure Method SA-2 and use spectrum analyzer test.

2. For UNII-2A & UNII-2C: Directional gain =  $10 \log[(10^{G1/20} + 10^{G2/20} + 10^{G3/20})^2 / 3] = 10.53\text{dBi} > 6\text{dBi}$ , so the power limit shall be reduced to "Determined Conducted Limit" -(10.53-6).

3. For UNII-3: Directional gain =  $10 \log[(10^{G1/20} + 10^{G2/20} + 10^{G3/20})^2 / 3] = 10.53\text{dBi} > 6\text{dBi}$ , so the power limit shall be reduced to  $30-(10.53-6) = 25.47\text{dBm}$ .

The Total Power for the straddle channel:

Chan.	Chan. Freq. (MHz)	Average Power (mW)	Average Power (dBm)
142	5710	46.5233	16.68

Note: The total power was calculated through formula and record the value for reference only.

**26dB BANDWIDTH:**

Channel	Frequency (MHz)	26dBc Bandwidth (MHz)		
		Chain 0	Chain 1	Chain 2
54	5270	41.49	41.42	41.16
62	5310	41.23	40.80	40.89
102	5510	40.90	41.09	40.91
110	5550	41.50	41.15	41.05
134	5670	54.64	41.12	40.84
142 (UNII-2C Band)	5710	41.05	35.83	35.54

**Note: For U\_NII-2A, U\_NII-2C Band output power limitation is determined based on 26dBc bandwidth**

Power Limit = 11dBm + 10logB < U_NII-2A, U_NII-2C >			
Channel Number	Freq.(MHz)	Min. B(MHz)	Determined Conducted Limit (dBm)
54	5270	41.16	27.14 > 24
62	5310	40.80	27.1 > 24
102	5510	40.90	27.11 > 24
110	5550	41.05	27.13 > 24
134	5670	40.84	27.11 > 24
142 (UNII-2C Band)	5710	35.54	26.5 > 24

**802.11ac (VHT80)**
**POWER OUTPUT:**

Chan.	Chan. Freq. (MHz)	Maximum Conducted Power (dBm)			Total Power (mW)	Total Power (dBm)	Limit (dBm)	Pass / Fail
		Chain 0	Chain 1	Chain 2				
58	5290	9.69	8.19	7.35	21.336	13.29	19.47	Pass
106	5530	10.55	9.08	8.25	26.124	14.17	19.47	Pass
122	5610	15.53	14.37	13.36	84.757	19.28	19.47	Pass
*138 (UNII-2C Band)	5690	11.73	10.83	9.84	38.698	15.88	19.47	Pass
*138 (UNII-3 Band)	5690	-1.94	-2.68	-2.84	1.7948	2.54	25.47	Pass

Note: 1. \* Test was performed in accordance with Measurement follow FCC KDB 789033 UNII test procedure Method SA-2 and use spectrum analyzer test.

2. For UNII-2A & UNII-2C: Directional gain =  $10 \log[(10^{G1/20} + 10^{G2/20} + 10^{G3/20})^2 / 3] = 10.53\text{dBi} > 6\text{dBi}$  , so the power limit shall be reduced to "Determined Conducted Limit" -(10.53-6).

3. For UNII-3: Directional gain =  $10 \log[(10^{G1/20} + 10^{G2/20} + 10^{G3/20})^2 / 3] = 10.53\text{dBi} > 6\text{dBi}$  , so the power limit shall be reduced to  $30-(10.53-6) = 25.47\text{dBm}$ .

The Total Power for the straddle channel:

Chan.	Chan. Freq. (MHz)	Average Power (mW)	Average Power (dBm)
138	5690	40.4928	16.07

Note: The total power was calculated through formula and record the value for reference only.



**26dB BANDWIDTH:**

Channel	Frequency (MHz)	26dBc Bandwidth (MHz)		
		Chain 0	Chain 1	Chain 2
58	5290	84.20	83.10	83.67
106	5530	83.64	83.45	83.54
122	5610	98.58	84.28	83.37
138 (UNII-2C Band)	5690	86.71	90.80	78.64

**Note: For U\_NII-2A, U\_NII-2C Band output power limitation is determined based on 26dBc bandwidth**

Power Limit = 11dBm + 10logB < U_NII-2A, U_NII-2C >			
Channel Number	Freq.(MHz)	Min. B(MHz)	Determined Conducted Limit (dBm)
58	5290	83.10	30.19 > 24
106	5530	83.45	30.21 > 24
122	5610	83.37	30.21 > 24
138 (UNII-2C Band)	5690	78.64	29.95 > 24

Spectrum Plot of Worst Value

802.11ac (VHT20) / Chain 1 - CH144 (UNII-2C Band) 802.11ac (VHT40) / Chain 2 - CH142 (UNII-2C Band)

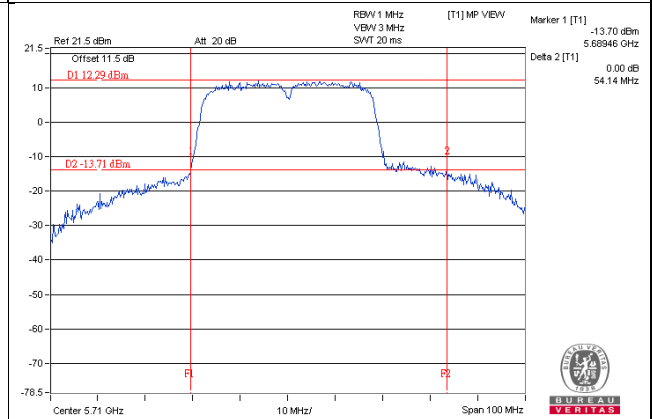
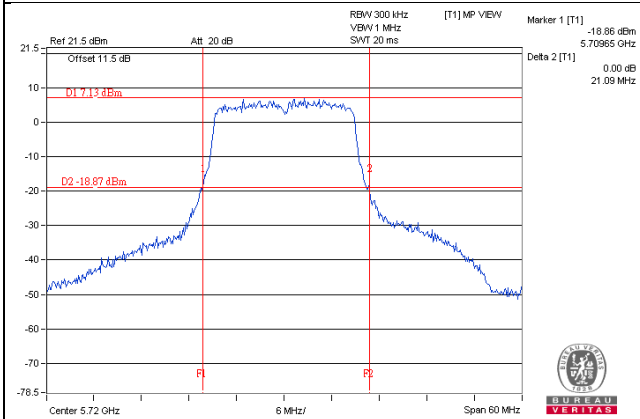

802.11ac (VHT80) / Chain 2 - CH138 (UNII-2C Band)

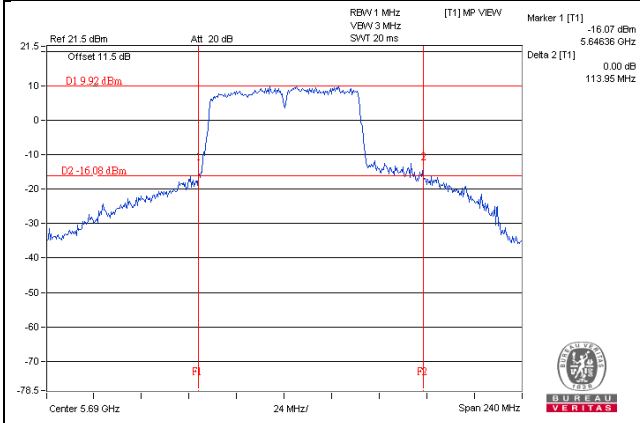

**NOTE:**

- For CH144 (UNII-2C Band) = 5725MHz - Marker 1
- For CH142 (UNII-2C Band) = 5725MHz - Marker 1
- For CH138 (UNII-2C Band) = 5725MHz - Marker 1

#### 4.3.9 Test Result (Mode 3)

#### CDD Mode

#### 802.11a

#### Power Output:

Chan.	Chan. Freq. (MHz)	Maximum Conducted Power (dBm)		Total Power (mW)	Total Power (dBm)	Limit (dBm)	Pass / Fail
		Chain 0	Chain 1				
52	5260	18.07	17.89	125.639	20.99	24.00	Pass
60	5300	18.20	17.77	125.91	21.00	24.00	Pass
64	5320	18.23	17.75	126.093	21.01	24.00	Pass
100	5500	18.35	17.66	126.736	21.03	24.00	Pass
116	5580	18.61	17.52	129.105	21.11	24.00	Pass
140	5700	17.08	15.98	90.678	19.58	24.00	Pass
*144 (UNII-2C Band)	5720	14.90	13.42	54.526	17.37	23.40	Pass
*144 (UNII-3 Band)	5720	9.00	7.33	13.766	11.39	30.00	Pass

Note: \* Test was performed in accordance with Measurement follow FCC KDB 789033 UNII test procedure Method SA-2 and use spectrum analyzer test.

The Total Power for the straddle channel:

Chan.	Chan. Freq. (MHz)	Average Power (mW)	Average Power (dBm)
144	5720	68.292	18.34

Note: The total power was calculated through formula and record the value for reference only.

**26dB BANDWIDTH:**

Channel	Frequency (MHz)	26dBc Bandwidth (MHz)	
		Chain 0	Chain 1
52	5260	21.01	21.10
60	5300	21.38	20.74
64	5320	21.57	21.09
100	5500	21.20	21.53
116	5580	21.86	21.23
140	5700	22.27	21.80
144 (UNII-2C Band)	5720	18.65	17.41

**Note: For U\_NII-2A, U\_NII-2C Band output power limitation is determined based on 26dBc bandwidth**

Power Limit = 11dBm + 10logB < U_NII-2A, U_NII-2C >			
Channel Number	Freq.(MHz)	Min. B(MHz)	Determined Conducted Limit (dBm)
52	5260	21.01	24.22 > 24
60	5300	20.74	24.16 > 24
64	5320	21.09	24.24 > 24
100	5500	21.20	24.26 > 24
116	5580	21.23	24.26 > 24
140	5700	21.80	24.38 > 24
144 (UNII-2C Band)	5720	17.41	23.4 < 24

## 802.11ac (VHT20)

### POWER OUTPUT:

Chan.	Chan. Freq. (MHz)	Maximum Conducted Power (dBm)		Total Power (mW)	Total Power (dBm)	Limit (dBm)	Pass / Fail
		Chain 0	Chain 1				
52	5260	18.32	17.95	130.293	21.15	24.00	Pass
60	5300	18.31	17.74	127.193	21.04	24.00	Pass
64	5320	18.32	17.86	129.014	21.11	24.00	Pass
100	5500	18.15	17.25	118.401	20.73	24.00	Pass
116	5580	18.56	17.16	123.779	20.93	24.00	Pass
140	5700	15.78	14.52	66.158	18.21	24.00	Pass
*144 (UNII-2C Band)	5720	14.54	13.43	50.474	17.03	23.46	Pass
*144 (UNII-3 Band)	5720	9.17	7.89	14.412	11.59	30.00	Pass

Note: \* Test was performed in accordance with Measurement follow FCC KDB 789033 UNII test procedure Method SA-1 and use spectrum analyzer test.

The Total Power for the straddle channel:

Chan.	Chan. Freq. (MHz)	Average Power (mW)	Average Power (dBm)
144	5720	64.886	18.12

Note: The total power was calculated through formula and record the value for reference only.

**26dB BANDWIDTH:**

Channel	Frequency (MHz)	26dBc Bandwidth (MHz)	
		Chain 0	Chain 1
52	5260	22.53	22.91
60	5300	22.12	22.00
64	5320	21.90	22.10
100	5500	22.01	22.06
116	5580	22.68	22.43
140	5700	21.56	20.76
144 (UNII-2C Band)	5720	17.65	17.68

**Note: For FCC output power limitation is determined based on 26dB bandwidth.**

Power Limit = 11dBm + 10logB < U_NII-2A, U_NII-2C >			
Channel Number	Freq.(MHz)	Min. B(MHz)	Determined Conducted Limit (dBm)
52	5260	22.53	24.52 > 24
60	5300	22.00	24.42 > 24
64	5320	21.90	24.4 > 24
100	5500	22.01	24.42 > 24
116	5580	22.43	24.5 > 24
140	5700	20.76	24.17 > 24
144 (UNII-2C Band)	5720	17.65	23.46 < 24

**802.11ac (VHT40)**
**POWER OUTPUT:**

Chan.	Chan. Freq. (MHz)	Maximum Conducted Power (dBm)		Total Power (mW)	Total Power (dBm)	Limit (dBm)	Pass / Fail
		Chain 0	Chain 1				
54	5270	20.91	20.56	237.073	23.75	24.00	Pass
62	5310	14.56	14.34	55.74	17.46	24.00	Pass
102	5510	13.95	13.07	45.108	16.54	24.00	Pass
110	5550	21.31	20.12	238.009	23.77	24.00	Pass
134	5670	17.74	16.61	105.243	20.22	24.00	Pass
*142 (UNII-2C Band)	5710	16.13	16.13	84.206	19.25	24.00	Pass
*142 (UNII-3 Band)	5710	5.49	5.17	7.009	8.46	30.00	Pass

Note: \* Test was performed in accordance with Measurement follow FCC KDB 789033 UNII test procedure Method SA-2 and use spectrum analyzer test.

The Total Power for the straddle channel:

Chan.	Chan. Freq. (MHz)	Average Power (mW)	Average Power (dBm)
142	5710	91.215	19.6

Note: The total power was calculated through formula and record the value for reference only.

**26dB BANDWIDTH:**

Channel	Frequency (MHz)	26dBc Bandwidth (MHz)	
		Chain 0	Chain 1
54	5270	54.71	73.39
62	5310	41.02	40.61
102	5510	41.07	41.12
110	5550	60.06	63.54
134	5670	47.57	50.98
142 (UNII-2C Band)	5710	46.15	43.08

**Note: For U\_NII-2A, U\_NII-2C Band output power limitation is determined based on 26dBc bandwidth**

Power Limit = 11dBm + 10logB < U_NII-2A, U_NII-2C >			
Channel Number	Freq.(MHz)	Min. B(MHz)	Determined Conducted Limit (dBm)
54	5270	54.71	28.38 > 24
62	5310	40.61	27.08 > 24
102	5510	41.07	27.13 > 24
110	5550	60.06	28.78 > 24
134	5670	47.57	27.77 > 24
142 (UNII-2C Band)	5710	43.08	27.34 > 24



**802.11ac (VHT80)**
**POWER OUTPUT:**

Chan.	Chan. Freq. (MHz)	Maximum Conducted Power (dBm)		Total Power (mW)	Total Power (dBm)	Limit (dBm)	Pass / Fail
		Chain 0	Chain 1				
58	5290	12.92	12.59	37.743	15.77	24.00	Pass
106	5530	10.91	9.78	21.837	13.39	24.00	Pass
122	5610	18.35	17.13	120.033	20.79	24.00	Pass
*138 (UNII-2C Band)	5690	17.28	15.23	91.68	19.62	24.00	Pass
*138 (UNII-3 Band)	5690	4.92	2.65	5.224	7.18	30.00	Pass

Note: \* Test was performed in accordance with Measurement follow FCC KDB 789033 UNII test procedure Method SA-2 and use spectrum analyzer test.

The Total Power for the straddle channel:

Chan.	Chan. Freq. (MHz)	Average Power (mW)	Average Power (dBm)
138	5690	96.904	19.86

Note: The total power was calculated through formula and record the value for reference only.

**26dB BANDWIDTH:**

Channel	Frequency (MHz)	26dBc Bandwidth (MHz)	
		Chain 0	Chain 1
58	5290	85.09	83.49
106	5530	84.43	83.91
122	5610	119.16	110.37
138 (UNII-2C Band)	5690	113.49	91.33

**Note: For U\_NII-2A, U\_NII-2C Band output power limitation is determined based on 26dBc bandwidth**

Power Limit = 11dBm + 10logB < U_NII-2A, U_NII-2C >			
Channel Number	Freq.(MHz)	Min. B(MHz)	Determined Conducted Limit (dBm)
58	5290	83.49	30.21 > 24
106	5530	83.91	30.23 > 24
122	5610	110.37	31.42 > 24
138 (UNII-2C Band)	5690	91.33	30.6 > 24

**802.11ac (VHT80+80)**
**POWER OUTPUT:**

Chan.	Chan. Freq. (MHz)	Maximum Conducted Power (dBm)				Total Power (mW)	Total Power (dBm)	Limit (dBm)	Pass / Fail
		Chain 0	Chain 1	Chain 2	Chain 3				
42+58	5210	13.62	-	-	-	23.014	13.62	30.00	Pass
	5290			13.04	-	20.137	13.04	24.00	Pass
42+106	5210	13.62	-	-	-	23.014	13.62	30.00	Pass
	5530	-	-	13.11	-	20.464	13.11	24.00	Pass
42+122	5210	13.62	-	-	13.62	23.014	13.62	30.00	Pass
	5610	-	-	13.05	-	20.184	13.05	24.00	Pass
42+ 138* (UNII-2C)+ 138* (UNII-3)	5210	13.62	-	-	-	23.014	13.62	30.00	Pass
	5690	-	-	10.35	-	11.242	10.51	24.00	Pass
	5690	-	-	-3.86	-	0.4264	-3.70	30.00	Pass
58+106	5290	13.37	-	-	13.37	21.727	13.37	24.00	Pass
	5530	-	-	13.11	-	20.464	13.11	24.00	Pass
58+122	5290	13.37	-	-	-	21.727	13.37	24.00	Pass
	5610	-	-	13.05	-	20.184	13.05	24.00	Pass
58+ 138* (UNII-2C)+ 138* (UNII-3)	5290	13.37	-	-	-	21.727	13.37	24.00	Pass
	5690	-	-	10.35	-	11.242	10.51	24.00	Pass
	5690	-	-	-3.86	-	0.4264	-3.70	30.00	Pass
58+155	5290	13.37	-	-	-	21.727	13.37	24.00	Pass
	5775	-	-	13.28	-	21.281	13.28	30.00	Pass
106+122	5530	13.52	-	-	-	42.675	16.30	24.00	Pass
	5610	-	-	13.05	-				
106+ 138*(UNII-2C)+ 138*(UNII-3)	5530	13.52	-	-	-	33.733	15.28	24.00	Pass
	5690	-	-	10.35	-				
	5690	-	-	-3.86	-				
106+155	5530	13.52	-	-	-	22.491	13.52	24.00	Pass
	5775	-	-	13.28	-	21.281	13.28	30.00	Pass
122+ 138*(UNII-2C)+ 138*(UNII-3)	5610	20.54	-	-	-	158.722	22.01	24.00	Pass
	5690	-	-	16.42	-				
	5690	-	-	2.57	-				
122+155	5610	20.54	-	-	-	113.24	20.54	24.00	Pass
	5775	-	-	19.42	-	87.498	19.42	30.00	Pass

Chan.	Chan. Freq. (MHz)	Maximum Conducted Power (dBm)				Total Power (mW)	Total Power (dBm)	Limit (dBm)	Pass / Fail
138* (UNII-2C)+ 138* (UNII-3)+ 155	5690	18.50	-	-	-	73.424	18.66	24.00	Pass
	5690	5.58	-	-	-	156.505	21.95	30.00	Pass
	5775	-	-	21.84	-				Pass

Note: \* Test was performed in accordance with Measurement follow FCC KDB 789033 UNII test procedure Method SA-2 and use spectrum analyzer test.

The Total Power for the straddle channel:

Chan.	Chan. Freq. (MHz)	Average Power (mW)	Average Power (dBm)
42+138 (UNII-2C) +138 (UNII-3)	5690	11.6684	10.67
58+138 (UNII-2C) +138 (UNII-3)	5690	11.6684	10.67
106+138 (UNII-2C) +138 (UNII-3)	5690	11.6679	10.67
122+138 (UNII-2C) +138 (UNII-3)	5690	47.3557	16.75
138 (UNII-2C) +138 (UNII-3)+155	5690	77.1723	18.87

Note: The total power was calculated through formula and record the value for reference only.

**26dB BANDWIDTH:**

Channel	Frequency (MHz)	26dBc Bandwidth (MHz)			
		Chain 0	Chain 1	Chain 2	Chain 3
42+58	5210	85.05	-	-	-
	5290	-	-	84.56	-
42+106	5210	85.05	-	-	-
	5530	-	-	84.57	-
42+122	5210	85.05	-	-	-
	5610	-	-	85.18	-
42+ 138 (UNII-2C)+ 138 (UNII-3)	5210	85.05	-	-	-
	5690	-	-	96.01	-
	5690	-	-	53.90	-
58+106	5290	84.54	-	-	-
	5530	-	-	84.57	-
58+122	5290	84.54	-	-	-
	5610	-	-	85.18	-
58+138 (UNII-2C)+ 138 (UNII-3)	5290	84.54	-	-	-
	5690	-	-	96.01	-
	5690	-	-	53.90	-
58+155	5290	84.54	-	-	-
	5775	-	-	171.58	-
106+122	5530	84.52	-	-	-
	5610	-	-	85.18	-
106+138 (UNII-2C)+ 138 (UNII-3)	5530	84.52	-	-	-
	5690	-	-	96.01	-
	5690	-	-	53.90	-
106+155	5530	84.52	-	-	-
	5775	-	-	171.58	-
122+138 (UNII-2C)+ 138 (UNII-3)	5610	143.89	-	-	-
	5690	-	-	96.01	-
	5690	-	-	53.90	-
122+155	5610	143.89	-	-	-
	5775	-	-	171.58	-
138 (UNII-2C)+ 138 (UNII-3) +155	5690	102.50	-	-	-
	5690	60.77	-	-	-
	5775	-	-	171.58	-

**Note: For U\_NII-2A, U\_NII-2C Band output power limitation is determined based on 26dBc bandwidth**

Power Limit = 11dBm + 10logB < U_NII-2A, U_NII-2C >			
Channel Number	Freq.(MHz)	Min. B(MHz)	Determined Conducted Limit (dBm)
42+58	5210	-	-
	5290	84.56	30.27 > 24
42+106	5210	-	-
	5530	84.57	30.27 > 24
42+122	5210	-	-
	5610	85.18	30.3 > 24
42+ 138 (UNII-2C)	5210	-	-
	5690	96.01	30.82 > 24
58+106	5290	84.56	30.27 > 24
	5530	84.57	30.27 > 24
58+122	5290	84.56	30.27 > 24
	5610	85.18	30.3 > 24
58+138 (UNII-2C)+ 138 (UNII-3)	5290	84.56	30.27 > 24
	5690	96.01	30.82 > 24
	5690	-	-
58+155	5290	84.56	30.27 > 24
	5775	-	-
106+122	5530	84.57	30.27 > 24
	5610	85.18	30.3 > 24
106+138 (UNII-2C)+ 138 (UNII-3)	5530	84.57	30.27 > 24
	5690	96.01	30.82 > 24
	5690	-	- 24
106+155	5530	84.57	30.27 > 24
	5775	-	-
122+138 (UNII-2C)+ 138 (UNII-3)	5610	85.18	30.3 > 24
	5690	96.01	30.82 > 24
	5690	-	-
122+155	5610	85.18	30.3 > 24
	5775	-	-
138 (UNII-2C)+ 138 (UNII-3) +155	5690	96.01	30.82 > 24
	5690	-	-
	5775	-	-

**Spectrum Plot of Worst Value**

**802.11a / Chain 1 - CH144 (UNII-2C Band)**

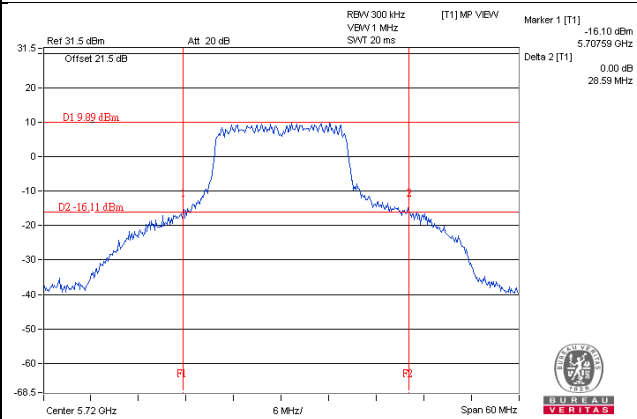

**802.11ac (VHT20) / Chain 0 - CH144 (UNII-2C Band)**

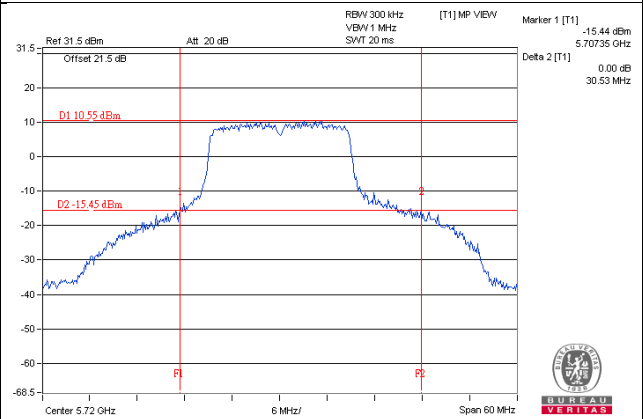

**802.11ac (VHT40) / Chain 1 - CH62**

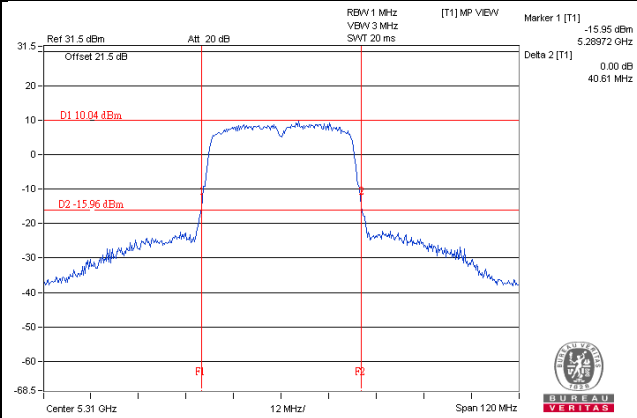

**802.11ac (VHT80) / Chain 1 - CH58**

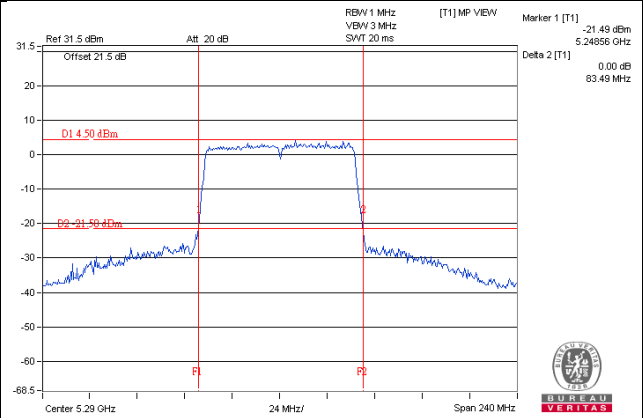

**802.11ac (VHT80+80) / Chain 2 - CH58**

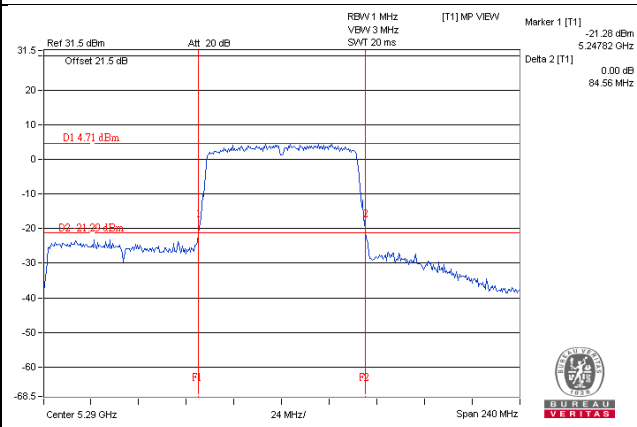

**NOTE:**

For CH144 (UNII-2C Band) = 5725MHz - Marker 1  
 For CH142 (UNII-2C Band) = 5725MHz - Marker 1

## Beamforming Mode

### 802.11ac (VHT20)

#### POWER OUTPUT:

Chan.	Chan. Freq. (MHz)	Maximum Conducted Power (dBm)		Total Power (mW)	Total Power (dBm)	Limit (dBm)	Pass / Fail
		Chain 0	Chain 1				
52	5260	18.32	17.95	130.293	21.15	21.16	Pass
60	5300	18.31	17.74	127.193	21.04	21.16	Pass
64	5320	18.32	17.86	129.014	21.11	21.16	Pass
100	5500	18.15	17.25	118.401	20.73	21.16	Pass
116	5580	18.56	17.16	123.779	20.93	21.16	Pass
140	5700	15.78	14.52	66.158	18.21	21.16	Pass
*144 (UNII-2C Band)	5720	14.54	13.43	50.474	17.03	20.62	Pass
*144 (UNII-3 Band)	5720	9.17	7.89	14.412	11.59	27.16	Pass

Note: 1. \* Test was performed in accordance with Measurement follow FCC KDB 789033 UNII test procedure Method SA-1 and use spectrum analyzer test.

2. For UNII-2A & UNII-2C: Directional gain =  $10 \log[(10^{G1/20} + 10^{G2/20})^2 / 2] = 8.84\text{dBi} > 6\text{dBi}$ , so the power limit shall be reduced to "Determined Conducted Limit" -(8.84-6).

3. For UNII-3: Directional gain =  $10 \log[(10^{G1/20} + 10^{G2/20})^2 / 2] = 8.84\text{dBi} > 6\text{dBi}$ , so the power limit shall be reduced to  $30-(8.84-6) = 27.16\text{dBm}$ .

The Total Power for the straddle channel:

Chan.	Chan. Freq. (MHz)	Average Power (mW)	Average Power (dBm)
144	5720	64.886	18.12

Note: The total power was calculated through formula and record the value for reference only.



**26dB BANDWIDTH:**

Channel	Frequency (MHz)	26dBc Bandwidth (MHz)	
		Chain 0	Chain 1
52	5260	22.53	22.91
60	5300	22.12	22.00
64	5320	21.90	22.10
100	5500	22.01	22.06
116	5580	22.68	22.43
140	5700	21.56	20.76
144 (UNII-2C Band)	5720	17.65	17.68

**Note: For FCC output power limitation is determined based on 26dB bandwidth.**

Power Limit = 11dBm + 10logB < U_NII-2A, U_NII-2C >			
Channel Number	Freq.(MHz)	Min. B(MHz)	Determined Conducted Limit (dBm)
52	5260	22.53	24.52 > 24
60	5300	22.00	24.42 > 24
64	5320	21.90	24.4 > 24
100	5500	22.01	24.42 > 24
116	5580	22.43	24.5 > 24
140	5700	20.76	24.17 > 24
144 (UNII-2C Band)	5720	17.65	23.46 < 24

## 802.11ac (VHT40)

### POWER OUTPUT:

Chan.	Chan. Freq. (MHz)	Maximum Conducted Power (dBm)		Total Power (mW)	Total Power (dBm)	Limit (dBm)	Pass / Fail
		Chain 0	Chain 1				
54	5270	18.06	17.86	125.067	20.97	21.16	Pass
62	5310	14.56	14.34	55.74	17.46	21.16	Pass
102	5510	13.95	13.07	45.108	16.54	21.16	Pass
110	5550	18.57	17.61	129.622	21.13	21.16	Pass
134	5670	17.74	16.61	105.243	20.22	21.16	Pass
*142 (UNII-2C Band)	5710	15.20	13.99	59.71	17.76	21.16	Pass
*142 (UNII-3 Band)	5710	4.27	2.94	4.764	6.78	27.16	Pass

Note: 1. \* Test was performed in accordance with Measurement follow FCC KDB 789033 UNII test procedure Method SA-2 and use spectrum analyzer test.

2. For UNII-2A & UNII-2C: D Directional gain =  $10 \log[(10^{G1/20} + 10^{G2/20})^2 / 2] = 8.84\text{dBi} > 6\text{dBi}$ , so the power limit shall be reduced to "Determined Conducted Limit" -(8.84-6).

3. For UNII-3: Directional gain =  $10 \log[(10^{G1/20} + 10^{G2/20})^2 / 2] = 8.84\text{dBi} > 6\text{dBi}$ , so the power limit shall be reduced to  $30-(8.84-6) = 27.16\text{dBm}$ .

The Total Power for the straddle channel:

Chan.	Chan. Freq. (MHz)	Average Power (mW)	Average Power (dBm)
142	5710	64.474	18.09

Note: The total power was calculated through formula and record the value for reference only.

**26dB BANDWIDTH:**

Channel	Frequency (MHz)	26dBc Bandwidth (MHz)	
		Chain 0	Chain 1
54	5270	54.71	73.39
62	5310	41.02	40.61
102	5510	41.07	41.12
110	5550	60.06	63.54
134	5670	47.57	50.98
142 (UNII-2C Band)	5710	46.15	43.08

**Note: For U\_NII-2A, U\_NII-2C Band output power limitation is determined based on 26dBc bandwidth**

Power Limit = 11dBm + 10logB < U_NII-2A, U_NII-2C >			
Channel Number	Freq.(MHz)	Min. B(MHz)	Determined Conducted Limit (dBm)
54	5270	54.71	28.38 > 24
62	5310	40.61	27.08 > 24
102	5510	41.07	27.13 > 24
110	5550	60.06	28.78 > 24
134	5670	47.57	27.77 > 24
142 (UNII-2C Band)	5710	43.08	27.34 > 24

**802.11ac (VHT80)**
**POWER OUTPUT:**

Chan.	Chan. Freq. (MHz)	Maximum Conducted Power (dBm)		Total Power (mW)	Total Power (dBm)	Limit (dBm)	Pass / Fail
		Chain 0	Chain 1				
58	5290	12.92	12.59	37.743	15.77	21.16	Pass
106	5530	10.91	9.78	21.837	13.39	21.16	Pass
122	5610	18.35	17.13	120.033	20.79	21.16	Pass
*138 (UNII-2C Band)	5690	14.90	14.19	60.359	17.81	21.16	Pass
*138 (UNII-3 Band)	5690	2.24	1.25	3.178	5.02	27.16	Pass

Note: 1. \* Test was performed in accordance with Measurement follow FCC KDB 789033 UNII test procedure Method SA-2 and use spectrum analyzer test.

2. For UNII-2A & UNII-2C: D Directional gain =  $10 \log[(10^{G1/20} + 10^{G2/20})^2 / 2] = 8.84\text{dBi} > 6\text{dBi}$ , so the power limit shall be reduced to "Determined Conducted Limit" -(8.84-6).

3. For UNII-3: Directional gain =  $10 \log[(10^{G1/20} + 10^{G2/20})^2 / 2] = 8.84\text{dBi} > 6\text{dBi}$ , so the power limit shall be reduced to  $30-(8.84-6) = 27.16\text{dBm}$ .

The Total Power for the straddle channel:

Chan.	Chan. Freq. (MHz)	Average Power (mW)	Average Power (dBm)
138	5690	63.537	18.03

Note: The total power was calculated through formula and record the value for reference only.

**26dB BANDWIDTH:**

Channel	Frequency (MHz)	26dBc Bandwidth (MHz)	
		Chain 0	Chain 1
58	5290	85.09	83.49
106	5530	84.43	83.91
122	5610	119.16	110.37
138 (UNII-2C Band)	5690	113.49	91.33

**Note: For U\_NII-2A, U\_NII-2C Band output power limitation is determined based on 26dBc bandwidth**

Power Limit = 11dBm + 10logB < U_NII-2A, U_NII-2C >			
Channel Number	Freq.(MHz)	Min. B(MHz)	Determined Conducted Limit (dBm)
58	5290	83.49	30.21 > 24
106	5530	83.91	30.23 > 24
122	5610	110.37	31.42 > 24
138 (UNII-2C Band)	5690	91.33	30.6 > 24

Spectrum Plot of Worst Value

802.11ac (VHT20) / Chain 0 - CH144 (UNII-2C Band)

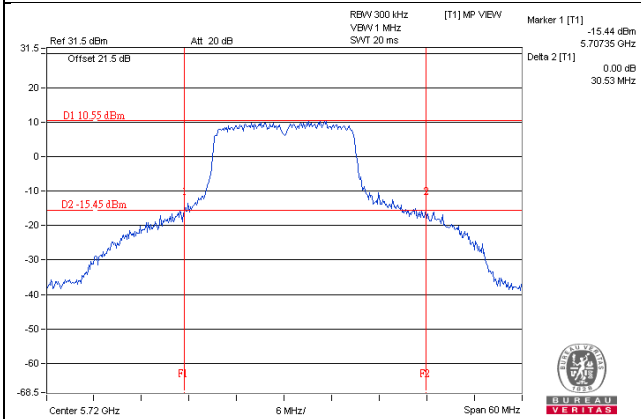

802.11ac (VHT40) / Chain 1 - CH62

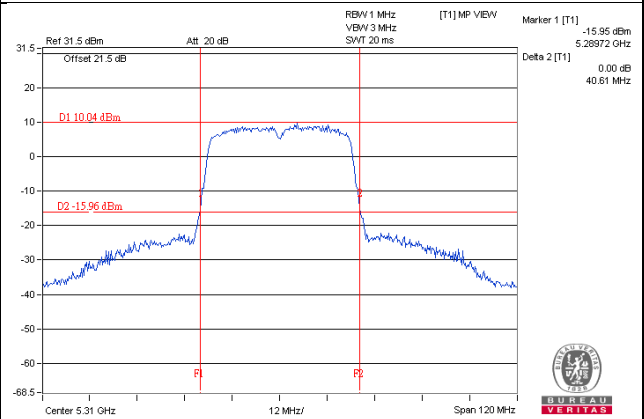

802.11ac (VHT80) / Chain 1 - CH58

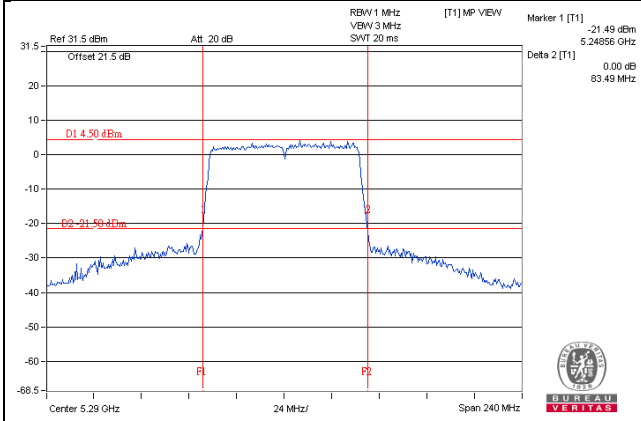

**NOTE:**

- For CH144 (UNII-2C Band) = 5725MHz - Marker 1
- For CH142 (UNII-2C Band) = 5725MHz - Marker 1
- For CH138 (UNII-2C Band) = 5725MHz - Marker 1

#### 4.3.10 Test Result (Mode 4)

##### 802.11a

##### Power Output:

Channel	Channel Frequency (MHz)	Maximum Conducted Power (mW)	Maximum Conducted Power (dBm)	Power Limit (dBm)	Pass/Fail
52	5260	187.932	22.74	24.00	Pass
60	5300	208.93	23.20	24.00	Pass
64	5320	125.026	20.97	24.00	Pass
100	5500	112.46	20.51	24.00	Pass
116	5580	181.97	22.60	24.00	Pass
140	5700	57.28	17.58	24.00	Pass
*144 (UNII-2C Band)	5720	56.272	17.50	24.00	Pass
*144 (UNII-3 Band)	5720	13.655	11.35	30.00	Pass

Note: 1. \* Test was performed in accordance with Measurement follow FCC KDB 789033 UNII test procedure Method SA-2 and use spectrum analyzer test.

The Total Power for the straddle channel:

Chan.	Chan. Freq. (MHz)	Average Power (mW)	Average Power (dBm)
144	5720	69.927	18.45

Note: The total power was calculated through formula and record the value for reference only.

**26dB BANDWIDTH:**

Channel	Frequency (MHz)	26dBc Bandwidth (MHz)
52	5260	36.52
60	5300	39.02
64	5320	25.99
100	5500	24.37
116	5580	38.66
140	5700	23.49
144 (UNII-2C Band)	5720	22.81

**Note: For U-NII-2A, U-NII-2C Band output power limitation is determined based on 26dBc bandwidth**

Power Limit = 11dBm + 10logB < U-NII-2A, U-NII-2C >			
Channel Number	Freq.(MHz)	Min. B(MHz)	Determined Conducted Limit (dBm)
52	5260	36.52	26.62 > 24
60	5300	39.02	26.91 > 24
64	5320	25.99	25.14 > 24
100	5500	24.37	24.86 > 24
116	5580	38.66	26.87 > 24
140	5700	23.49	24.7 > 24
144 (UNII-2C Band)	5720	22.81	24.58 > 24



## 802.11ac (VHT20)

### Power Output:

Channel	Channel Frequency (MHz)	Maximum Conducted Power (mW)	Maximum Conducted Power (dBm)	Power Limit (dBm)	Pass/Fail
52	5260	179.473	22.54	24.00	Pass
60	5300	198.153	22.97	24.00	Pass
64	5320	104.472	20.19	24.00	Pass
100	5500	89.95	19.54	24.00	Pass
116	5580	123.31	20.91	24.00	Pass
140	5700	42.756	16.31	24.00	Pass
*144 (UNII-2C Band)	5720	55.59	17.45	24.00	Pass
*144 (UNII-3 Band)	5720	15.776	11.98	30.00	Pass

Note: 1. \* Test was performed in accordance with Measurement follow FCC KDB 789033 UNII test procedure Method SA-1 and use spectrum analyzer test.

The Total Power for the straddle channel:

Chan.	Chan. Freq. (MHz)	Average Power (mW)	Average Power (dBm)
144	5720	71.366	18.53

Note: The total power was calculated through formula and record the value for reference only.

**26dB BANDWIDTH:**

Channel	Frequency (MHz)	26dBc Bandwidth (MHz)
52	5260	40.60
60	5300	38.55
64	5320	24.65
100	5500	23.34
116	5580	31.36
140	5700	21.53
144 (UNII-2C Band)	5720	24.39

**Note: For U-NII-2A, U-NII-2C Band output power limitation is determined based on 26dBc bandwidth**

Power Limit = 11dBm + 10logB < U-NII-2A, U-NII-2C >			
Channel Number	Freq.(MHz)	Min. B(MHz)	Determined Conducted Limit (dBm)
52	5260	40.60	27.08 > 24
60	5300	38.55	26.86 > 24
64	5320	24.65	24.91 > 24
100	5500	23.34	24.68 > 24
116	5580	31.36	25.96 > 24
140	5700	21.53	24.33 > 24
144 (UNII-2C Band)	5720	24.39	24.87 > 24

### 802.11ac (VHT40)

Channel	Channel Frequency (MHz)	Maximum Conducted Power (mW)	Maximum Conducted Power (dBm)	Power Limit (dBm)	Pass/Fail
54	5270	178.649	22.52	24.00	Pass
62	5310	32.659	15.14	24.00	Pass
102	5510	39.628	15.98	24.00	Pass
110	5550	175.388	22.44	24.00	Pass
134	5670	73.282	18.65	24.00	Pass
*142 (UNII-2C Band)	5710	65.21	18.14	24.00	Pass
*142 (UNII-3 Band)	5710	5.144	7.11	30.00	Pass

Note: 1. \* Test was performed in accordance with Measurement follow FCC KDB 789033 UNII test procedure Method SA-2 and use spectrum analyzer test.

The Total Power for the straddle channel:

Chan.	Chan. Freq. (MHz)	Average Power (mW)	Average Power (dBm)
142	5710	70.354	18.47

Note: The total power was calculated through formula and record the value for reference only.

### 26dB BANDWIDTH:

Channel	Frequency (MHz)	26dBc Bandwidth (MHz)
54	5270	80.03
62	5310	41.26
102	5510	41.10
110	5550	81.43
134	5670	50.47
142 (UNII-2C Band)	5710	46.67

**Note: For U-NII-2A, U-NII-2C Band output power limitation is determined based on 26dBc bandwidth**

Power Limit = 11dBm + 10logB < U-NII-2A, U-NII-2C >			
Channel Number	Freq.(MHz)	Min. B(MHz)	Determined Conducted Limit (dBm)
54	5270	80.03	30.03 > 24
62	5310	41.26	27.15 > 24
102	5510	41.10	27.13 > 24
110	5550	81.43	30.1 > 24
134	5670	50.47	28.03 > 24
142 (UNII-2C Band)	5710	46.67	27.69 > 24

### 802.11ac (VHT80)

Channel	Channel Frequency (MHz)	Maximum Conducted Power (mW)	Maximum Conducted Power (dBm)	Power Limit (dBm)	Pass/Fail
58	5290	33.574	15.26	24.00	Pass
106	5530	31.915	15.04	24.00	Pass
122	5610	77.625	18.90	24.00	Pass
*138 (UNII-2C Band)	5690	56.985	17.56	24.00	Pass
*138 (UNII-3 Band)	5690	2.708	4.33	30.00	Pass

Note: 1. \* Test was performed in accordance with Measurement follow FCC KDB 789033 UNII test procedure Method SA-2 and use spectrum analyzer test.

The Total Power for the straddle channel:

Chan.	Chan. Freq. (MHz)	Average Power (mW)	Average Power (dBm)
138	5690	59.693	17.76

Note: The total power was calculated through formula and record the value for reference only.

### 26dB BANDWIDTH:

Channel	Frequency (MHz)	26dBc Bandwidth (MHz)
58	5290	83.88
106	5530	85.88
122	5610	107.88
138 (UNII-2C Band)	5690	96.65

**Note: For U-NII-2A, U-NII-2C Band output power limitation is determined based on 26dBc bandwidth**

Power Limit = 11dBm + 10logB < U-NII-2A, U-NII-2C >			
Channel Number	Freq.(MHz)	Min. B(MHz)	Determined Conducted Limit (dBm)
58	5290	83.88	30.23 > 24
106	5530	85.88	30.33 > 24
122	5610	107.88	31.32 > 24
138 (UNII-2C Band)	5690	96.65	30.85 > 24

**Spectrum Plot of Worst Value**

**802.11a / CH144 (UNII-2C Band)**

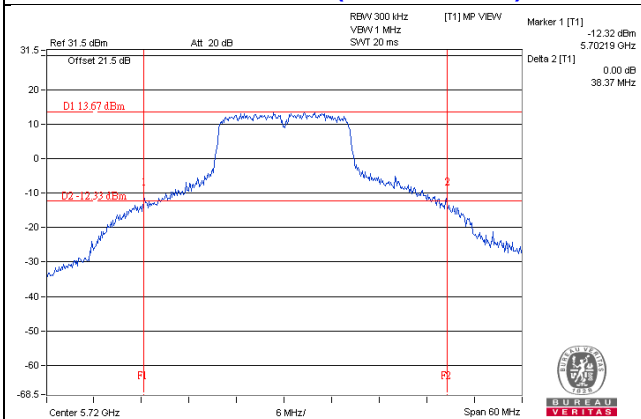

**802.11ac (VHT20) / CH140 (UNII-2C Band)**

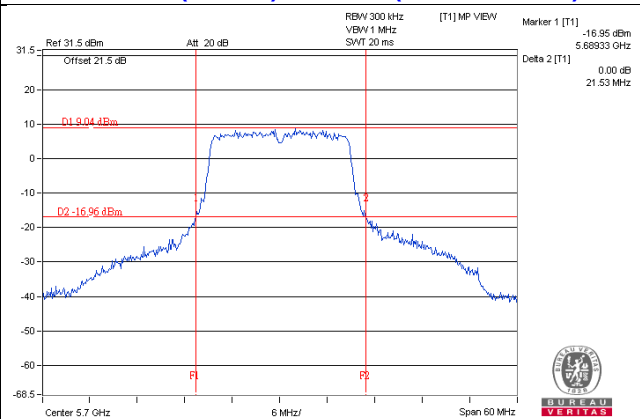

**802.11ac (VHT40) / CH102**

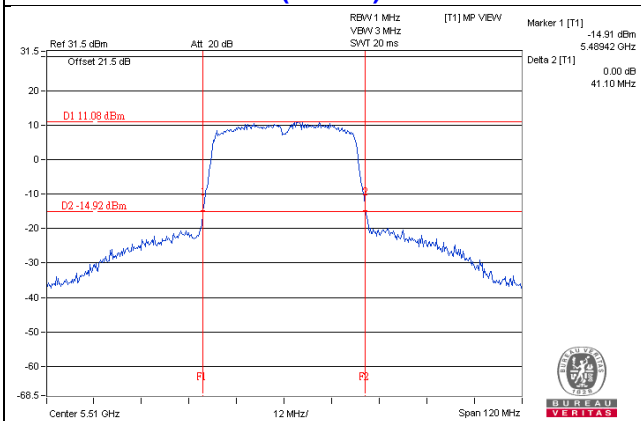

**802.11ac (VHT80) / CH58**

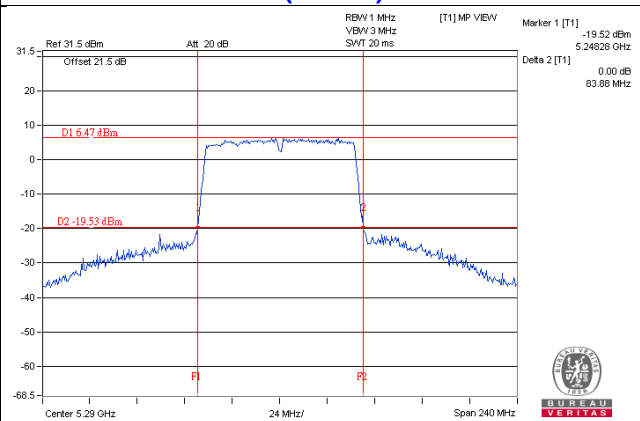

**NOTE:**

- For CH144 (UNII-2C Band) = 5725MHz - Marker 1
- For CH142 (UNII-2C Band) = 5725MHz - Marker 1
- For CH138 (UNII-2C Band) = 5725MHz - Marker 1

## 4.4 Occupied Bandwidth Measurement

### 4.4.1 Test Setup

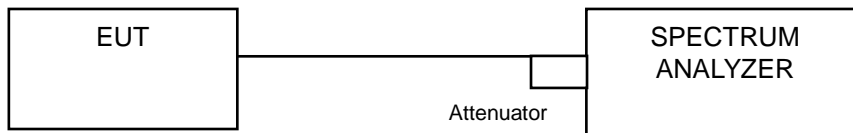

### 4.4.2 Test Instruments

Refer to section 4.1.2 to get information of above instrument.

### 4.4.3 Test Procedure

The transmitter output was connected to the spectrum analyzer through an attenuator. The bandwidth of the fundamental frequency was measured by spectrum analyzer with resolution bandwidth in the range of 1% to 5% of the anticipated emission bandwidth, and a video bandwidth at least 3x the resolution bandwidth and set the detector to SAMPLE. The width of a frequency band such that, below the lower and above the upper frequency limits, the mean powers emitted are each equal to a specified percentage 0.5 %of the total mean power of a given emission.

#### 4.4.4 Test Results (Mode 1)

##### 802.11a

Channel	Channel Frequency (MHz)	Occupied Bandwidth (MHz)			
		Chain 0	Chain 1	Chain 2	Chain 3
52	5260	16.56	16.56	16.56	16.56
60	5300	16.56	16.56	16.44	16.44
64	5320	16.68	16.56	16.56	16.56
100	5500	16.56	16.56	16.56	16.56
116	5580	16.68	16.44	16.56	16.56
140	5700	16.44	16.44	16.68	16.56
144 (UNII-2C Band)	5720	13.40	13.28	13.40	13.28
144 (UNII-3 Band)	5720	3.28	3.28	3.28	3.28

##### 802.11ac (VHT20)

Channel	Channel Frequency (MHz)	Occupied Bandwidth (MHz)			
		Chain 0	Chain 1	Chain 2	Chain 3
52	5260	17.76	17.64	17.64	17.64
60	5300	17.64	17.64	17.64	17.64
64	5320	17.64	17.64	17.64	17.76
100	5500	17.64	17.76	17.76	17.76
116	5580	17.64	17.64	17.76	17.76
140	5700	17.64	17.76	17.64	17.64
144 (UNII-2C Band)	5720	14.00	13.88	13.88	13.88
144 (UNII-3 Band)	5720	3.76	3.76	3.88	3.76

##### 802.11ac (VHT40)

Channel	Channel Frequency (MHz)	Occupied Bandwidth (MHz)			
		Chain 0	Chain 1	Chain 2	Chain 3
54	5270	36.24	36.24	36.24	36.24
62	5310	36.24	36.24	36.24	36.24
102	5510	36.24	36.24	36.24	36.24
110	5550	36.24	36.48	36.24	36.24
134	5670	36.24	36.24	36.24	36.24
142 (UNII-2C Band)	5710	33.20	33.20	33.20	33.20
142 (UNII-3 Band)	5710	3.20	3.00	3.00	3.20

**802.11ac (VHT80)**

Channel	Channel Frequency (MHz)	Occupied Bandwidth (MHz)			
		Chain 0	Chain 1	Chain 2	Chain 3
58	5290	75.84	76.32	75.84	76.32
106	5530	75.36	75.36	75.84	75.36
122	5610	76.32	76.32	76.32	75.84
138 (UNII-2C Band)	5690	72.92	72.92	73.40	73.40
138 (UNII-3 Band)	5690	2.92	2.92	2.92	2.92



**802.11ac (VHT80+80)**

Channel	Frequency (MHz)	Occupied Bandwidth (MHz)			
		Chain 0	Chain 1	Chain 2	Chain 3
42+58	5210	75.84	75.84	-	-
	5290	-	-	76.32	76.32
42+106	5210	75.84	75.84	-	-
	5530	-	-	75.84	75.84
42+122	5210	75.84	75.84	-	-
	5610	-	-	76.32	75.84
42+ 138 (UNII-2C)+ 138 (UNII-3)	5210	75.84	75.84	-	-
	5690	-	-	73.40	73.40
	5690	-	-	2.92	2.92
58+106	5290	75.84	76.32	-	-
	5530	-	-	75.84	75.84
58+122	5290	75.84	76.32	-	-
	5610	-	-	76.32	75.84
58+138 (UNII-2C)+ 138 (UNII-3)	5290	75.84	76.32	-	-
	5690	-	-	73.40	73.40
	5690	-	-	2.92	2.92
58+155	5290	75.84	76.32	-	-
	5775	-	-	76.80	76.80
106+122	5530	75.84	75.36	-	-
	5610	-	-	76.32	75.84
106+138 (UNII-2C)+ 138 (UNII-3)	5530	75.84	75.36	-	-
	5690	-	-	73.40	73.40
	5690	-	-	2.92	2.92
106+155	5530	75.84	75.36	-	-
	5775	-	-	76.80	76.80
122+138 (UNII-2C)+ 138 (UNII-3)	5610	76.32	76.32	-	-
	5690	-	-	73.40	73.40
	5690	-	-	2.92	2.92
122+155	5610	76.32	76.32	-	-
	5775	-	-	76.80	76.80
138 (UNII-2C)+ 138 (UNII-3) +155	5690	72.92	72.92	-	-
	5690	2.92	2.92	-	-
	5775	-	-	76.80	76.80

Spectrum Plot of Worst Value

802.11a\_Chain 0 / CH64

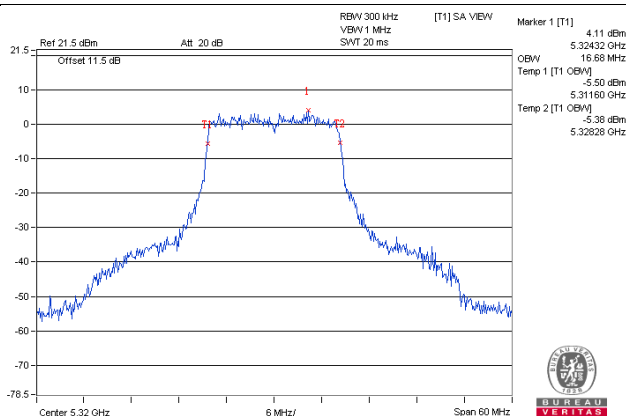

802.11ac (VHT20)\_Chain 0 / CH52

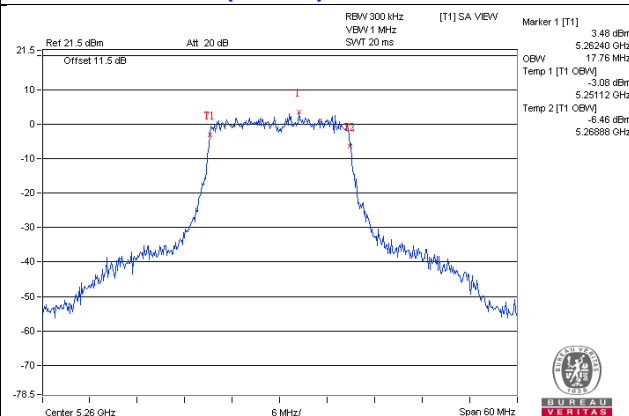

802.11ac (VHT40)\_Chain 1 / CH110

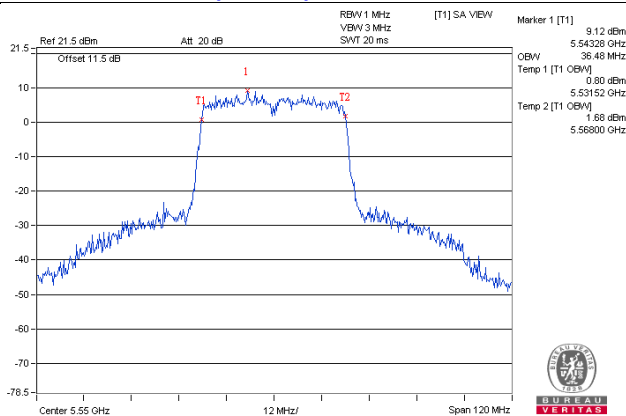

802.11ac (VHT80)\_Chain 1 / CH58

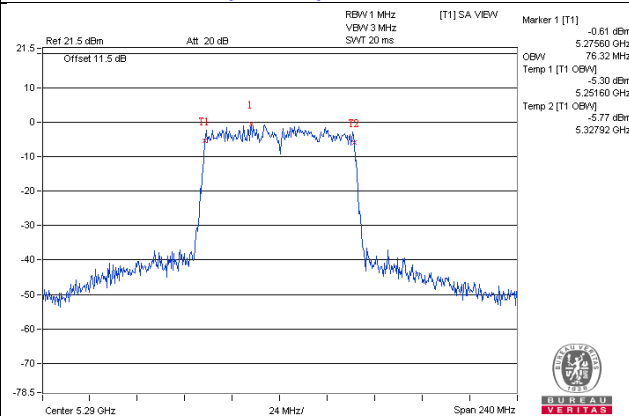

802.11ac (VHT80+80)\_Chain 0 / CH138 (UNII-3)

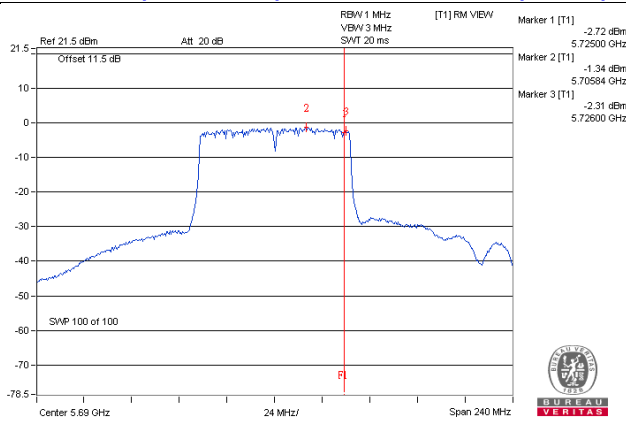

## 4.4.5 Test Results (Mode 2)

## 802.11a

Channel	Channel Frequency (MHz)	Occupied Bandwidth (MHz)		
		CHAIN 0	CHAIN 1	CHAIN 2
52	5260	16.56	16.68	16.56
60	5300	16.44	16.44	16.56
64	5320	16.56	16.44	16.44
100	5500	16.44	16.56	16.56
116	5580	16.68	16.68	16.68
140	5700	16.68	16.44	16.56
144 (UNII-2C Band)	5720	13.28	13.28	13.28
144 (UNII-3 Band)	5720	3.28	3.28	3.28

## 802.11ac (VHT20)

Channel	Channel Frequency (MHz)	Occupied Bandwidth (MHz)		
		CHAIN 0	CHAIN 1	CHAIN 2
52	5260	17.64	17.64	17.76
60	5300	17.76	17.76	17.64
64	5320	17.76	17.64	17.88
100	5500	17.76	17.76	17.64
116	5580	17.88	17.88	17.76
140	5700	17.76	17.76	17.64
144 (UNII-2C Band)	5720	13.88	13.88	14.00
144 (UNII-3 Band)	5720	3.88	3.76	3.88

## 802.11ac (VHT40)

Channel	Channel Frequency (MHz)	Occupied Bandwidth (MHz)		
		CHAIN 0	CHAIN 1	CHAIN 2
54	5270	36.24	36.24	36.24
62	5310	36.24	36.24	36.48
102	5510	36.24	36.24	36.24
110	5550	36.48	36.24	36.24
134	5670	36.24	36.48	36.48
142 (UNII-2C Band)	5710	33.20	33.20	33.20
142 (UNII-3 Band)	5710	3.60	3.20	3.20

**802.11ac (VHT80)**

Channel	Channel Frequency (MHz)	Occupied Bandwidth (MHz)		
		CHAIN 0	CHAIN 1	CHAIN 2
58	5290	76.32	76.32	75.84
106	5530	76.32	75.84	76.32
122	5610	76.32	76.32	76.32
138 (UNII-2C Band)	5690	72.92	72.92	72.92
138 (UNII-3 Band)	5690	3.88	3.40	2.92

### Spectrum Plot of Worst Value

**802.11a\_Chain0 / CH116**

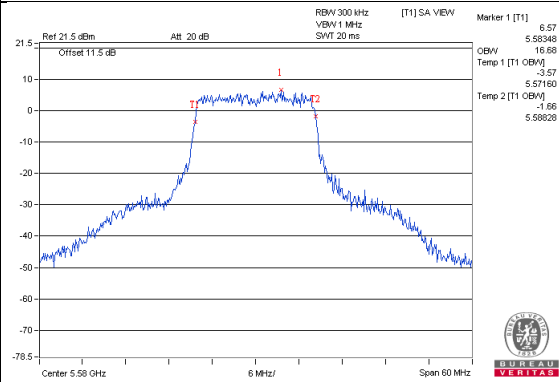

**802.11ac (VHT20)\_Chain0 / CH116**

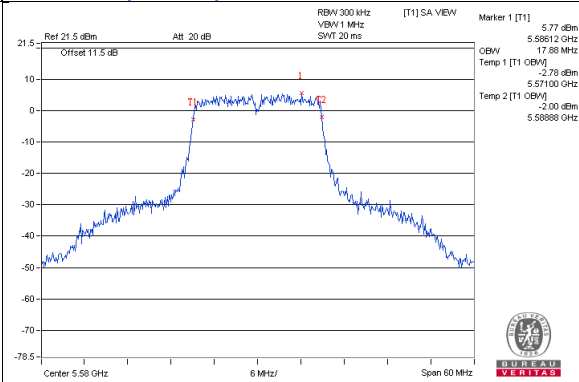

**802.11ac (VHT40)\_Chain0 / CH110**

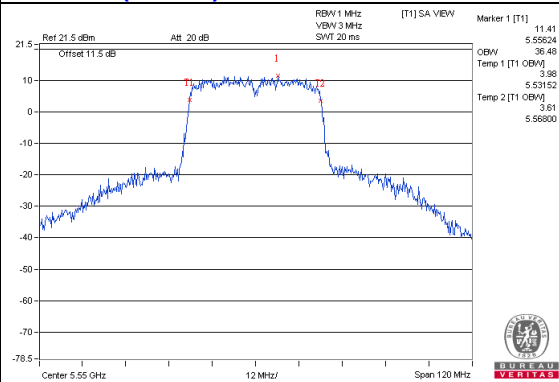

**802.11ac (VHT80)\_Chain0 / CH58**

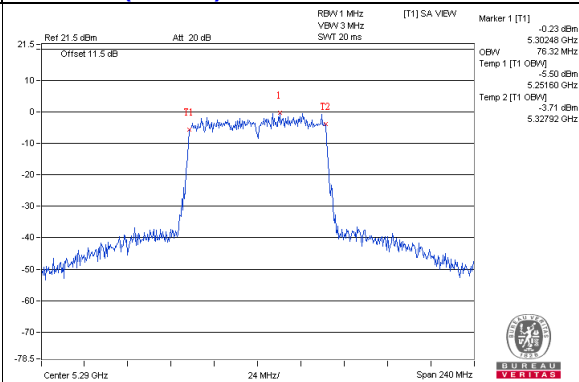

## 4.4.6 Test Results (Mode 3)

## 802.11a

Channel	Channel Frequency (MHz)	Occupied Bandwidth (MHz)	
		CHAIN 0	CHAIN 1
52	5260	16.68	16.68
60	5300	16.56	16.56
64	5320	16.68	16.68
100	5500	16.56	16.68
116	5580	16.68	16.68
140	5700	16.80	16.68
144 (UNII-2C Band)	5720	13.40	13.52
144 (UNII-3 Band)	5720	3.64	3.52

## 802.11ac (VHT20)

Channel	Channel Frequency (MHz)	Occupied Bandwidth (MHz)	
		CHAIN 0	CHAIN 1
52	5260	17.76	17.88
60	5300	17.76	17.88
64	5320	17.76	17.88
100	5500	17.76	17.76
116	5580	17.88	17.88
140	5700	17.76	17.76
144 (UNII-2C Band)	5720	14.00	14.00
144 (UNII-3 Band)	5720	4.00	3.88

## 802.11ac (VHT40)

Channel	Channel Frequency (MHz)	Occupied Bandwidth (MHz)	
		CHAIN 0	CHAIN 1
54	5270	36.96	36.96
62	5310	36.24	36.24
102	5510	36.24	36.24
110	5550	36.72	36.72
134	5670	36.48	36.24
142 (UNII-2C Band)	5710	33.40	33.40
142 (UNII-3 Band)	5710	5.20	4.60

**802.11ac (VHT80)**

Channel	Channel Frequency (MHz)	Occupied Bandwidth (MHz)	
		CHAIN 0	CHAIN 1
58	5290	76.32	75.84
106	5530	75.84	75.84
122	5610	76.80	76.32
138 (UNII-2C Band)	5690	73.88	73.40
138 (UNII-3 Band)	5690	22.60	4.84

**802.11ac (VHT80+80)**

Channel	Frequency (MHz)	Occupied Bandwidth (MHz)	
		Chain 0	Chain 2
42+58	5210	76.32	-
	5290	-	76.32
42+106	5210	76.32	-
	5530	-	75.84
42+122	5210	76.32	-
	5610	-	76.32
42+ 138 (UNII-2C)+ 138 (UNII-3)	5210	76.32	-
	5690	-	73.40
	5690	-	3.88
58+106	5290	75.84	-
	5530	-	75.84
58+122	5290	75.84	-
	5610	-	76.32
58+138 (UNII-2C)+ 138 (UNII-3)	5290	75.84	-
	5690	-	73.40
	5690	-	3.88
58+155	5290	75.84	-
	5775	-	76.80
106+122	5530	76.32	-
	5610	-	76.32
106+138 (UNII-2C)+ 138 (UNII-3)	5530	76.32	-
	5690	-	73.40
	5690	-	3.88
106+155	5530	76.32	-
	5775	-	76.80
122+138 (UNII-2C)+ 138 (UNII-3)	5610	76.80	-
	5690	-	73.40
	5690	-	3.88
122+155	5610	76.80	-
	5775	-	76.80
138 (UNII-2C)+ 138 (UNII-3) +155	5690	73.40	-
	5690	16.36	-
	5775	-	76.80

Spectrum Plot of Worst Value

802.11a\_Chain 0 / CH140

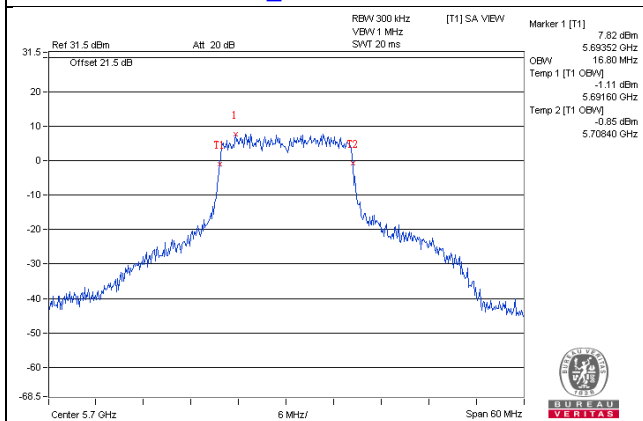

802.11ac (VHT20)\_Chain 1 / CH52

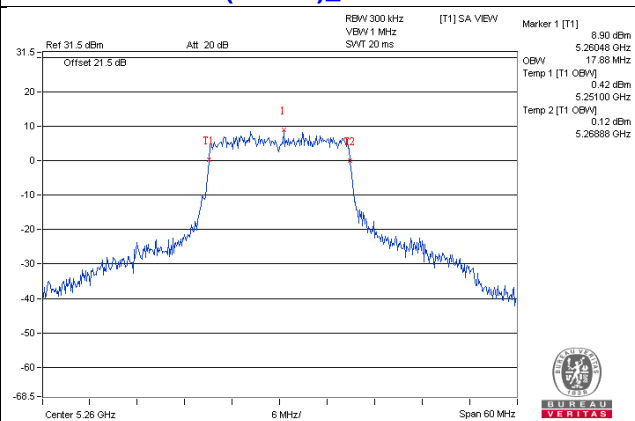

802.11ac (VHT40)\_Chain 0 / CH54

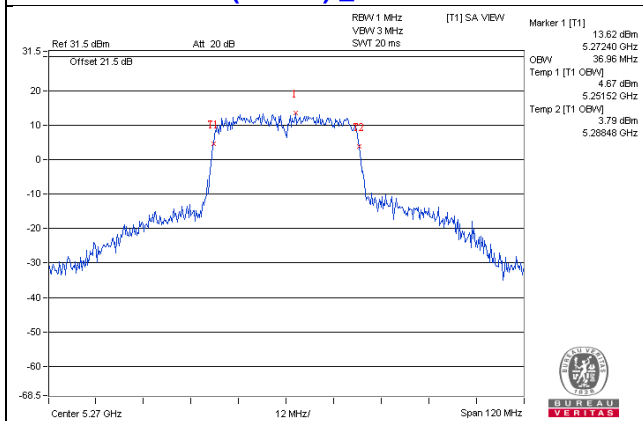

802.11ac (VHT80)\_Chain 0 / CH122

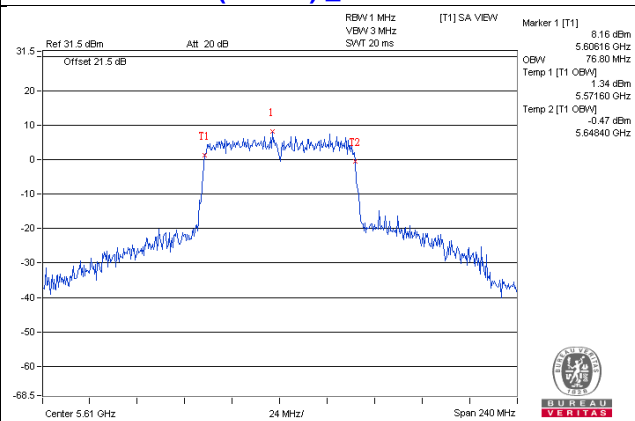

802.11ac (VHT80+80)\_Chain 2 / CH155

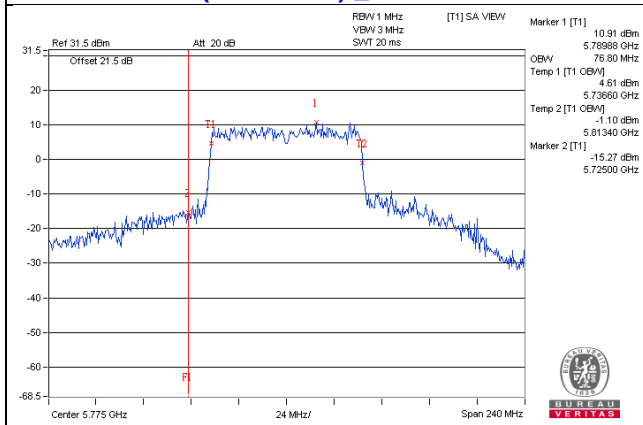



#### 4.4.7 Test Results (Mode 4)

##### 802.11a

Channel	Channel Frequency (MHz)	Occupied Bandwidth (MHz)
52	5260	18.48
60	5300	19.80
64	5320	16.80
100	5500	16.80
116	5580	19.68
140	5700	16.80
144 (UNII-2C Band)	5720	13.76
144 (UNII-3 Band)	5720	5.20

##### 802.11ac (VHT20)

Channel	Channel Frequency (MHz)	Occupied Bandwidth (MHz)
52	5260	19.92
60	5300	19.68
64	5320	17.88
100	5500	17.76
116	5580	18.12
140	5700	17.76
144 (UNII-2C Band)	5720	14.48
144 (UNII-3 Band)	5720	5.44

##### 802.11ac (VHT40)

Channel	Channel Frequency (MHz)	Occupied Bandwidth (MHz)
54	5270	38.40
62	5310	36.48
102	5510	36.48
110	5550	37.68
134	5670	36.48
142 (UNII-2C Band)	5710	33.40
142 (UNII-3 Band)	5710	4.20

##### 802.11ac (VHT80)

Channel	Channel Frequency (MHz)	Occupied Bandwidth (MHz)
58	5290	75.84
106	5530	75.84
122	5610	76.32
138 (UNII-2C Band)	5690	73.40
138 (UNII-3 Band)	5690	5.32

### Spectrum Plot of Worst Value

#### 802.11a / CH60

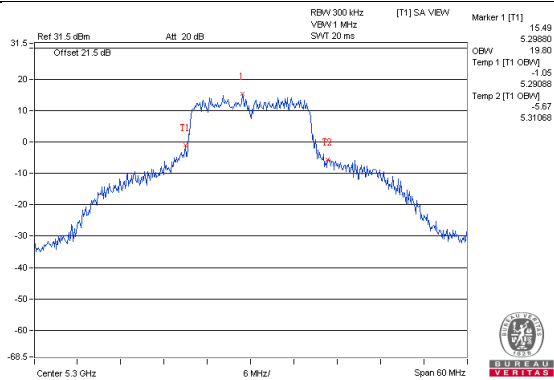

#### 802.11ac(VHT20) / CH52

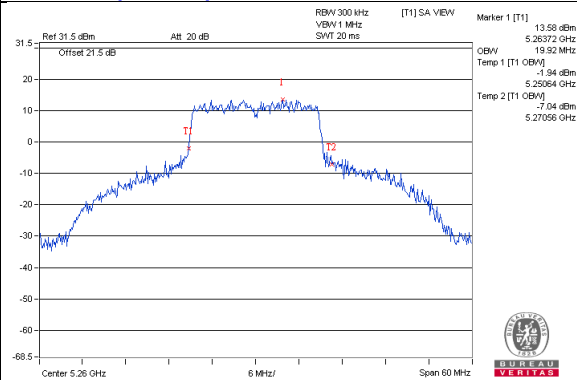

#### 802.11ac(VHT40) / CH54

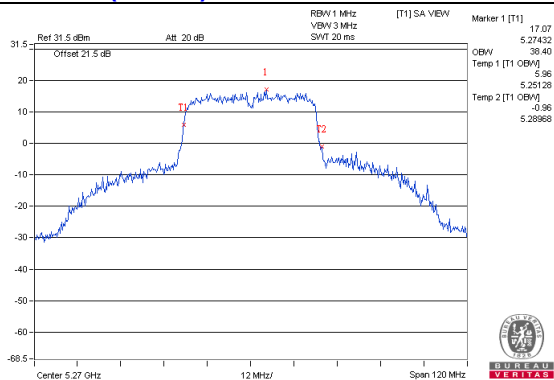

#### 802.11ac (VHT80) / CH122

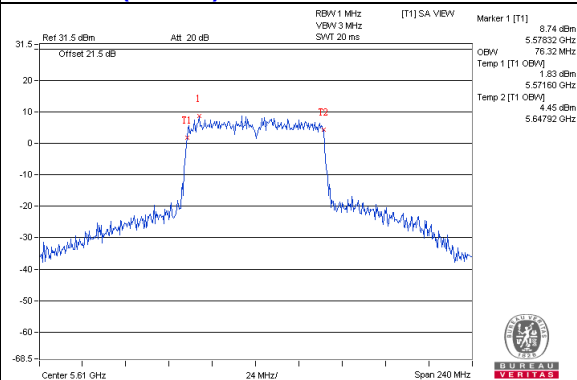

## 4.5 Peak Power Spectral Density Measurement

### 4.5.1 Limits of Peak Power Spectral Density Measurement

Operation Band	EUT Category		Limit
U-NII-1		Outdoor Access Point	17dBm/ MHz
		Fixed point-to-point Access Point	
	√	Indoor Access Point	
		Mobile and Portable client device	11dBm/ MHz
U-NII-2A		√	11dBm/ MHz
U-NII-2C		√	11dBm/ MHz
U-NII-3		√	30dBm/ 500kHz

### 4.5.2 Test Setup



### 4.5.3 Test Instruments

Refer to section 4.1.2 to get information of above instrument.

#### 4.5.4 Test Procedure

##### For U\_NII-2A, U\_NII-2C band:

##### **802.11a, 802.11ac (VHT40), 802.11ac (VHT80)**

Using method SA-2

1. Set span to encompass the entire emission bandwidth (EBW) of the signal.
2. Set RBW = 1 MHz, Set VBW  $\geq$  3 MHz, Detector = RMS
3. Sweep time = auto, trigger set to "free run".
4. Trace average at least 100 traces in power averaging mode.
5. Record the max value and add 10 log (1/duty cycle)

##### **802.11ac (VHT20)**

Using method SA-1

1. Set span to encompass the entire emission bandwidth (EBW) of the signal.
2. Set RBW = 1 MHz, Set VBW  $\geq$  3 MHz, Detector = RMS
3. Sweep time = auto, trigger set to "free run".
4. Trace average at least 100 traces in power averaging mode.
5. Record the max value

##### For U\_NII-3:

##### **802.11a, 802.11ac (VHT40), 802.11ac (VHT80)**

1. Set span to encompass the entire emission bandwidth (EBW) of the signal.
2. Set RBW = 300 kHz, Set VBW  $\geq$  1 MHz, Detector = RMS
3. Use the peak marker function to determine the maximum power level in any 300 kHz band segment within the fundamental EBW.
4. Scale the observed power level to an equivalent value in 500 kHz by adjusting (reducing) the measured power by a bandwidth correction factor (BWCF) where  $BWCF = 10\log(500\text{ kHz}/300\text{ kHz})$
5. Sweep time = auto, trigger set to "free run".
6. Trace average at least 100 traces in power averaging mode.
7. Record the max value and add 10 log (1/duty cycle)

##### **802.11ac (VHT20)**

1. Set span to encompass the entire emission bandwidth (EBW) of the signal.
2. Set RBW = 300 kHz, Set VBW  $\geq$  1 MHz, Detector = RMS
3. Use the peak marker function to determine the maximum power level in any 300 kHz band segment within the fundamental EBW.
4. Scale the observed power level to an equivalent value in 500 kHz by adjusting (reducing) the measured power by a bandwidth correction factor (BWCF) where  $BWCF = 10\log(500\text{ kHz}/300\text{ kHz})$
5. Sweep time = auto, trigger set to "free run".
6. Trace average at least 100 traces in power averaging mode.
7. Record the max value

#### 4.5.5 Deviation from Test Standard

No deviation.

#### 4.5.6 EUT Operating Condition

Same as Item 4.3.6.

## 4.5.7 Test Results (Mode 1)

 802.11a  
 For U\_NII-2A, U\_NII-2C

Chan.	Chan. Freq. (MHz)	PSD W/O Duty Factor (dBm/MHz)				Duty Factor (dB)	Total PSD With Duty Factor (dBm/MHz)	MAX. Limit (dBm/MHz)	Pass / Fail
		Chain 0	Chain 1	Chain 2	Chain 3				
52	5260	-0.75	-1.54	-1.97	-2.33	0.13	4.55	5.33	Pass
60	5300	-0.63	-2.08	-1.92	-1.04	0.13	4.78	5.33	Pass
64	5320	-0.88	-1.12	-1.86	-1.00	0.13	4.95	5.33	Pass
100	5500	-0.77	-1.69	-1.70	-1.22	0.13	4.83	5.33	Pass
116	5580	-1.12	-1.47	-1.78	-1.70	0.13	4.64	5.33	Pass
140	5700	-1.10	-2.18	-2.79	-1.31	0.13	4.36	5.33	Pass
144 (UNII-2C Band)	5720	-1.15	-1.64	-3.08	-0.60	0.13	4.63	5.33	Pass

- Note:** 1. Method a) of power density measurement of KDB 662911 is using for calculating total power density. Total power density is summing entire spectra across corresponding frequency bins on the various outputs by computer.
2. Directional gain =  $10 \log[(10^{G1/20} + 10^{G2/20} + 10^{G3/20} + 10^{G4/20})^2 / 4] = 11.67\text{dBi} > 6\text{dBi}$ , so the power density limit shall be reduced to  $11 - (11.67 - 6) = 5.33\text{dBm}$ .
3. Refer to section 3.3 for duty cycle spectrum plot.

## For U\_NII-3

TX chain	Chan.	Chan. Freq. (MHz)	PSD W/O Duty Factor		10 log (N=4) dB	Duty Factor (dB)	Total PSD With Duty Factor (dBm/500kHz)	Limit (dBm/500kHz)	Pass /Fail
			(dBm/300kHz)	(dBm/500kHz)					
0	144 (UNII-3 Band)	5720	-8.89	-6.67	6.02	0.13	-0.52	24.33	Pass
1	144 (UNII-3 Band)	5720	-9.66	-7.44	6.02	0.13	-1.29	24.33	Pass
2	144 (UNII-3 Band)	5720	-11.09	-8.87	6.02	0.13	-2.72	24.33	Pass
3	144 (UNII-3 Band)	5720	-9.29	-7.07	6.02	0.13	-0.92	24.33	Pass

- Note:** 1. Directional gain =  $10 \log[(10^{G1/20} + 10^{G2/20} + 10^{G3/20} + 10^{G4/20})^2 / 4] = 11.67\text{dBi} > 6\text{dBi}$ , so the power density limit shall be reduced to  $30 - (11.67 - 6) = 24.33\text{dBm}$ .
2. Refer to section 3.3 for duty cycle spectrum plot.

**802.11ac (VHT20)**  
**For U\_NII-2A, U\_NII-2C**

Chan.	Chan. Freq. (MHz)	PSD (dBm/MHz)				Total Power Density (dBm/MHz)	MAX. Limit (dBm/MHz)	Pass / Fail
		Chain 0	Chain 1	Chain 2	Chain 3			
52	5260	-1.30	-1.33	-1.99	-1.23	4.57	5.33	Pass
60	5300	-0.72	-1.37	-2.33	-1.20	4.65	5.33	Pass
64	5320	-0.73	-1.23	-2.01	-0.93	4.82	5.33	Pass
100	5500	-1.04	-1.65	-2.30	-1.16	4.51	5.33	Pass
116	5580	-1.07	-2.16	-2.99	-0.93	4.31	5.33	Pass
140	5700	-0.79	-2.14	-2.87	-0.78	4.47	5.33	Pass
144 (UNII-2C Band)	5720	-0.94	-2.09	-2.92	-1.28	4.28	5.33	Pass

- Note:** 1. Method a) of power density measurement of KDB 662911 is using for calculating total power density. Total power density is summing entire spectra across corresponding frequency bins on the various outputs by computer.  
2. Directional gain =  $10 \log[(10^{G1/20} + 10^{G2/20} + 10^{G3/20} + 10^{G4/20})^2 / 4] = 11.67\text{dBi} > 6\text{dBi}$ , so the power density limit shall be reduced to  $11 - (11.67 - 6) = 5.33\text{dBm}$ .

**For U\_NII-3**

TX chain	Chan.	Chan. Freq. (MHz)	PSD		10 log (N=4) dB	Total PSD (dBm/500kHz)	Limit (dBm/500kHz)	Pass /Fail
			(dBm/300kHz)	(dBm/500kHz)				
0	144 (UNII-3 Band)	5720	-8.78	-6.56	6.02	-0.54	24.33	Pass
1	144 (UNII-3 Band)	5720	-10.07	-7.85	6.02	-1.83	24.33	Pass
2	144 (UNII-3 Band)	5720	-10.83	-8.61	6.02	-2.59	24.33	Pass
3	144 (UNII-3 Band)	5720	-9.38	-7.16	6.02	-1.14	24.33	Pass

- Note:** 1. Directional gain =  $10 \log[(10^{G1/20} + 10^{G2/20} + 10^{G3/20} + 10^{G4/20})^2 / 4] = 11.67\text{dBi} > 6\text{dBi}$ , so the power density limit shall be reduced to  $30 - (11.67 - 6) = 24.33\text{dBm}$ .

**802.11ac (VHT40)**  
**For U\_NII-2A, U\_NII-2C**

Chan.	Chan. Freq. (MHz)	PSD W/O Duty Factor (dBm/MHz)				Duty Factor (dB)	Total PSD With Duty Factor (dBm/MHz)	MAX. Limit (dBm/MHz)	Pass / Fail
		Chain 0	Chain 1	Chain 2	Chain 3				
54	5270	-1.67	-1.69	-2.38	-1.75	0.11	4.27	5.33	Pass
62	5310	-4.31	-4.24	-4.42	-4.07	0.11	1.88	5.33	Pass
102	5510	-4.14	-4.34	-4.35	-4.20	0.11	1.88	5.33	Pass
110	5550	-0.34	-1.22	-1.63	-2.37	0.11	4.81	5.33	Pass
134	5670	-1.60	-2.30	-4.08	-1.93	0.11	3.75	5.33	Pass
142 (UNII-2C Band)	5710	-0.21	-1.75	-2.05	-0.89	0.11	4.97	5.33	Pass

- Note:**
- Method a) of power density measurement of KDB 662911 is using for calculating total power density. Total power density is summing entire spectra across corresponding frequency bins on the various outputs by computer.
  - Directional gain =  $10 \log[(10^{G1/20} + 10^{G2/20} + 10^{G3/20} + 10^{G4/20})^2 / 4] = 11.67\text{dBi} > 6\text{dBi}$  , so the power density limit shall be reduced to  $11-(11.67-6) = 5.33\text{dBm}$ .
  - Refer to section 3.3 for duty cycle spectrum plot.

**For U\_NII-3**

TX chain	Chan.	Chan. Freq. (MHz)	PSD W/O Duty Factor		10 log (N=4) dB	Duty Factor (dB)	Total PSD With Duty Factor (dBm/500kHz)	Limit (dBm/500kHz)	Pass /Fail
			(dBm/300kHz)	(dBm/500kHz)					
0	142 (UNII-3 Band)	5720	-9.61	-7.39	6.02	0.11	-1.26	24.33	Pass
1	142 (UNII-3 Band)	5720	-10.82	-8.60	6.02	0.11	-2.47	24.33	Pass
2	142 (UNII-3 Band)	5720	-10.84	-8.62	6.02	0.11	-2.49	24.33	Pass
3	142 (UNII-3 Band)	5720	-10.25	-8.03	6.02	0.11	-1.90	24.33	Pass

- Note:**
- Directional gain =  $10 \log[(10^{G1/20} + 10^{G2/20} + 10^{G3/20} + 10^{G4/20})^2 / 4] = 11.67\text{dBi} > 6\text{dBi}$  , so the power density limit shall be reduced to  $30-(11.67-6) = 24.33\text{dBm}$ .
  - Refer to section 3.3 for duty cycle spectrum plot.

**802.11ac (VHT80)**
**For U\_NII-2A, U\_NII-2C**

Chan.	Chan. Freq. (MHz)	PSD W/O Duty Factor (dBm/MHz)				Duty Factor (dB)	Total PSD With Duty Factor (dBm/MHz)	MAX. Limit (dBm/MHz)	Pass / Fail
		Chain 0	Chain 1	Chain 2	Chain 3				
58	5290	-9.31	-11.21	-11.23	-10.49	0.24	-4.23	5.33	Pass
106	5530	-10.14	-11.97	-11.35	-10.37	0.24	-4.64	5.33	Pass
122	5610	-5.92	-7.02	-6.27	-6.13	0.24	-0.06	5.33	Pass
138 (UNII-2C Band)	5690	-1.52	-2.98	-3.30	-2.32	0.24	3.78	5.33	Pass

- Note:** 1. Method a) of power density measurement of KDB 662911 is using for calculating total power density. Total power density is summing entire spectra across corresponding frequency bins on the various outputs by computer.
2. Directional gain =  $10 \log[(10^{G1/20} + 10^{G2/20} + 10^{G3/20} + 10^{G4/20})^2 / 4] = 11.67\text{dBi} > 6\text{dBi}$ , so the power density limit shall be reduced to  $11-(11.67-6) = 5.33\text{dBm}$ .
3. Refer to section 3.3 for duty cycle spectrum plot.

**For U\_NII-3**

TX chain	Chan.	Chan. Freq. (MHz)	PSD W/O Duty Factor		10 log (N=4) dB	Duty Factor (dB)	Total PSD With Duty Factor (dBm/500kHz)	Limit (dBm/500kHz)	Pass /Fail
			(dBm/300kHz)	(dBm/500kHz)					
0	138 (UNII-3 Band)	5690	-10.73	-8.51	6.02	0.24	-2.25	24.33	Pass
1	138 (UNII-3 Band)	5690	-12.23	-10.01	6.02	0.24	-3.75	24.33	Pass
2	138 (UNII-3 Band)	5690	-11.69	-9.47	6.02	0.24	-3.21	24.33	Pass
2	138 (UNII-3 Band)	5690	-11.55	-9.33	6.02	0.24	-3.07	24.33	Pass

- Note:** 1. Directional gain =  $10 \log[(10^{G1/20} + 10^{G2/20} + 10^{G3/20} + 10^{G4/20})^2 / 4] = 11.67\text{dBi} > 6\text{dBi}$ , so the power density limit shall be reduced to  $30-(11.67-6) = 24.33\text{dBm}$ .
2. Refer to section 3.3 for duty cycle spectrum plot.



**802.11ac (VHT80+80)**
**For U\_NII-1, U\_NII-2A, U\_NII-2C**

Chan.	Chan. Freq. (MHz)	PSD W/O Duty Factor (dBm/MHz)				Duty Factor (dB)	Total PSD With Duty Factor (dBm/MHz)	MAX. Limit (dBm/MHz)	Pass / Fail
		Chain 0	Chain 1	Chain 2	Chain 3				
42+58	5210	-11.06	-10.01	-	-	0.16	-7.33	14.16	Pass
	5290	-	-	-10.35	-9.56	0.16	-6.77	8.52	Pass
42+106	5210	-11.06	-10.01	-	-	0.16	-7.33	14.16	Pass
	5530	-	-	-10.51	-9.32	0.16	-6.71	8.52	Pass
42+122	5210	-11.06	-10.01	-	-	0.16	-7.33	14.16	Pass
	5610	-	-	-8.98	-8.16	0.16	-5.38	8.52	Pass
42+ 138 (UNII-2C)+ 138 (UNII-3)	5210	-11.06	-10.01	-	-	0.16	-7.33	14.16	Pass
	5690	-	-	-2.74	-1.78	0.16	0.93	8.52	Pass
	5690	Test results refer to U_NII-3 data							
58+106	5290	-8.98	-8.25	-	-	0.16	-5.43	8.16	Pass
	5530	-	-	-10.51	-9.32	0.16	-6.71	8.52	Pass
58+122	5290	-8.98	-8.25	-	-	0.16	-5.43	8.16	Pass
	5610	-	-	-8.98	-8.16	0.16	-5.38	8.52	Pass
58+ 138 (UNII-2C)+ 138 (UNII-3)	5290	-8.98	-8.25	-	-	0.16	-5.43	8.16	Pass
	5690	-	-	-2.74	-1.78	0.16	0.93	8.52	Pass
	5690	Test results refer to U_NII-3 data							
58+155	5290	-8.98	-8.25	-	-	0.16	-5.43	8.16	Pass
	5775	Test results refer to U_NII-3 data							
106+122	5530	-10.01	-10.86	-	-	0.16	-4.25	5.33	Pass
	5610	-	-	-10.62	-10.27				
106 +138(UNII-2C) +138(UNII-3)	5530	-10.01	-10.86	-	-	0.16	-4.29	5.33	Pass
	5690	-	-	-10.87	-10.22				
	5690	Test results refer to U_NII-3 data							
106+155	5530	-10.01	-10.86	-	-	0.16	-7.25	8.16	Pass
	5775	Test results refer to U_NII-3 data							
122 +138(UNII-2C) +138(UNII-3)	5610	-1.02	-0.93	-	-	0.16	4.62	5.33	Pass
	5690	-	-	-2.74	-1.78	0.16			Pass
	5690	Test results refer to U_NII-3 data							
122+155	5610	-1.02	-0.93	-	-	0.16	2.19	8.16	Pass
	5775	Test results refer to U_NII-3 data							
138 (UNII-2C) +138(UNII-3) +155	5690	-1.76	-1.05	-	-	0.16	1.78	8.16	Pass
	5690	Test results refer to U_NII-3 data							
	5775	Test results refer to U_NII-3 data							

- Note:** 1. Method a) of power density measurement of KDB 662911 is using for calculating total power density. Total power density is summing entire spectra across corresponding frequency bins on the various outputs by computer.
2. **For U\_NII-1:** Directional gain =  $10 \log[(10^{G1/20} + 10^{G2/20})^2 / 2] = 8.84\text{dBi} > 6\text{dBi}$  , so the power density limit shall be reduced to  $17-(8.84-6) = 14.16\text{dBm}$ .
3. **For U\_NII-2A & U\_NII-2C:** Directional gain =  $10 \log[(10^{G1/20} + 10^{G2/20})^2 / 2] = 8.84\text{dBi} > 6\text{dBi}$  , so the power density limit shall be reduced to  $11-(8.84-6) = 8.16\text{dBm}$ .
4. **For U\_NII-2C (chain 0+chain 1+chain 2+chain 3):** Directional gain =  $10 \log[(10^{G1/20} + 10^{G2/20} + 10^{G3/20} + 10^{G4/20})^2 / 4] = 11.67\text{dBi} > 6\text{dBi}$  , so the power density limit shall be reduced to  $11-(11.67-6) = 5.33\text{dBm}$ .
5. Refer to section 3.3 for duty cycle spectrum plot.

**For U\_NII-3**

Chan.	TX chain	Chan. Freq. (MHz)	PSD W/O Duty Factor		10 log (N=4) dB	Duty Factor (dB)	Total PSD With Duty Factor (dBm/500kHz)	Limit (dBm/500kHz)	Pass /Fail
			(dBm/300kHz)	(dBm/500kHz)					
138 (UNII-2C) +138 (UNII-3) +155	0	5690	Test results refer to U_NII-2C data						
		5690	-11.17	-8.95	6.02	0.16	-2.77	24.33	Pass
	1	5690	Test results refer to U_NII-2C data						
		5690	-11.13	-8.91	6.02	0.16	-2.73	24.33	Pass
	2	5775	-10.28	-8.06	6.02	0.16	-1.88	24.33	Pass
3	5775	-9.10	-6.88	6.02	0.16	-0.70	24.33	Pass	
Chan.	TX chain	Chan. Freq. (MHz)	PSD W/O Duty Factor		10 log (N=2) dB	Duty Factor (dB)	Total PSD With Duty Factor (dBm/500kHz)	Limit (dBm/500kHz)	Pass /Fail
			(dBm/300kHz)	(dBm/500kHz)					
42+ 138 (UNII-2C) +138 (UNII-3)	0	5210	Test results refer to U_NII-1 data						
		5210	Test results refer to U_NII-1 data						
	2	5690	Test results refer to U_NII-2C data						
		5690	-12.34	-10.12	3.01	0.16	-6.95	27.52	Pass
	3	5690	Test results refer to U_NII-2C data						
5690		-11.93	-9.71	3.01	0.16	-6.54	27.52	Pass	
Chan.	TX chain	Chan. Freq. (MHz)	PSD W/O Duty Factor		10 log (N=2) dB	Duty Factor (dB)	Total PSD With Duty Factor (dBm/500kHz)	Limit (dBm/500kHz)	Pass /Fail
			(dBm/300kHz)	(dBm/500kHz)					
58+ 138 (UNII-2C) +138 (UNII-3)	0	5290	Test results refer to U_NII-2A data						
		5290	Test results refer to U_NII-2A data						
	2	5690	Test results refer to U_NII-2C data						
		5690	-12.34	-10.12	3.01	0.16	-6.95	27.52	Pass
	3	5690	Test results refer to U_NII-2C data						
5690		-11.93	-9.71	3.01	0.16	-6.54	27.52	Pass	
Chan.	TX chain	Chan. Freq. (MHz)	PSD W/O Duty Factor		10 log (N=2) dB	Duty Factor (dB)	Total PSD With Duty Factor (dBm/500kHz)	Limit (dBm/500kHz)	Pass /Fail
			(dBm/300kHz)	(dBm/500kHz)					
58+ 155	0	5290	Test results refer to U_NII-2A data						
		5290	Test results refer to U_NII-2A data						
	2	5775	-10.28	-8.06	3.01	0.16	-4.89	27.52	Pass
	3	5775	-9.10	-6.88	3.01	0.16	-3.71	27.52	Pass

Chan.	TX chain	Chan. Freq. (MHz)	PSD W/O Duty Factor		10 log (N=2) dB	Duty Factor (dB)	Total PSD With Duty Factor (dBm/500kHz)	Limit (dBm/500kHz)	Pass /Fail
			(dBm/300kHz)	(dBm/500kHz)					
106+ 155	0	5530	Test results refer to U_NII-2C data						
	1	5530	Test results refer to U_NII-2C data						
	2	5775	-10.28	-8.06	3.01	0.16	-4.89	27.52	Pass
	3	5775	-9.10	-6.88	3.01	0.16	-3.71	27.52	Pass
122+ 155	0	5610	Test results refer to U_NII-2C data						
	1	5610	Test results refer to U_NII-2C data						
	2	5775	-10.28	-8.06	3.01	0.16	-4.89	27.52	Pass
	3	5775	-9.10	-6.88	3.01	0.16	-3.71	27.52	Pass
106 +138 (UNII-2C) +138 (UNII-3)	0	5530	Test results refer to U_NII-2C data						
	1	5530	Test results refer to U_NII-2C data						
	2	5690	Test results refer to U_NII-2C data						
		5690	-12.34	-10.12	3.01	0.16	-6.95	27.52	Pass
	3	5690	Test results refer to U_NII-2C data						
		5690	-11.93	-9.71	3.01	0.16	-6.54	27.52	Pass
122 +138 (UNII-2C) +138 (UNII-3)	0	5610	Test results refer to U_NII-2C data						
	1	5610	Test results refer to U_NII-2C data						
	2	5690	Test results refer to U_NII-2C data						
		5690	-12.34	-10.12	3.01	0.16	-6.95	27.52	Pass
	3	5690	Test results refer to U_NII-2C data						
		5690	-11.93	-9.71	3.01	0.16	-6.54	27.52	Pass

- Note:** 1. Directional gain =  $10 \log[(10^{G3/20} + 10^{G4/20})^2 / 2] = 8.48\text{dBi} > 6\text{dBi}$ , so the power density limit shall be reduced to  $30-(8.48-6) = 27.52\text{dBm}$ .
2. Directional gain =  $10 \log[(10^{G1/20} + 10^{G2/20} + 10^{G3/20} + 10^{G4/20})^2 / 4] = 11.67\text{dBi} > 6\text{dBi}$ , so the power density limit shall be reduced to  $30-(11.67-6) = 24.33\text{dBm}$ .
2. Refer to section 3.3 for duty cycle spectrum plot.

For U\_NII-1, U\_NII-2A, U\_NII-2C

Spectrum Plot of Worst Value

802.11a / Chain 3 – CH144 (UNII-2C Band)

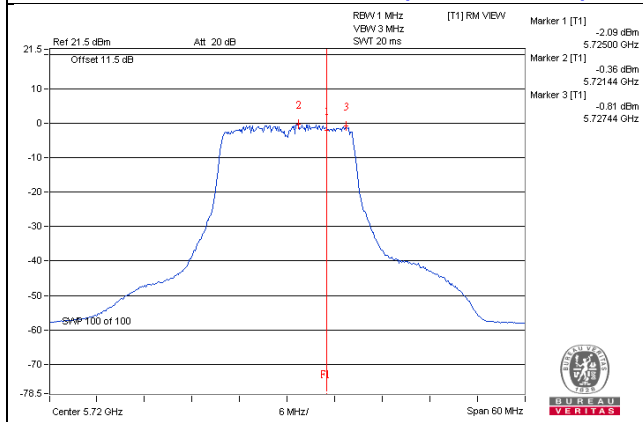

802.11ac (VHT20) / Chain 0 – CH60

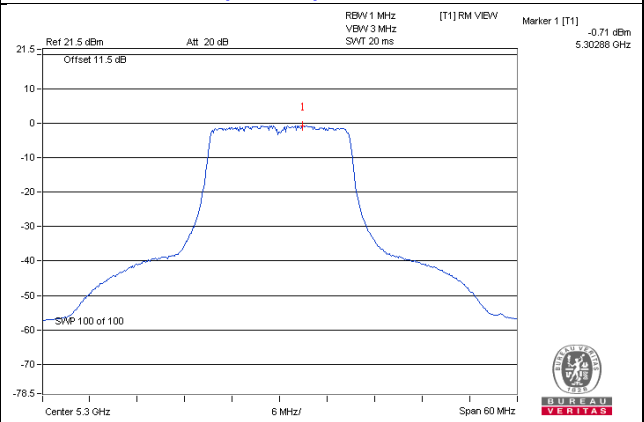

802.11ac (VHT40) / Chain 0 - CH142(UNII-2C Band)

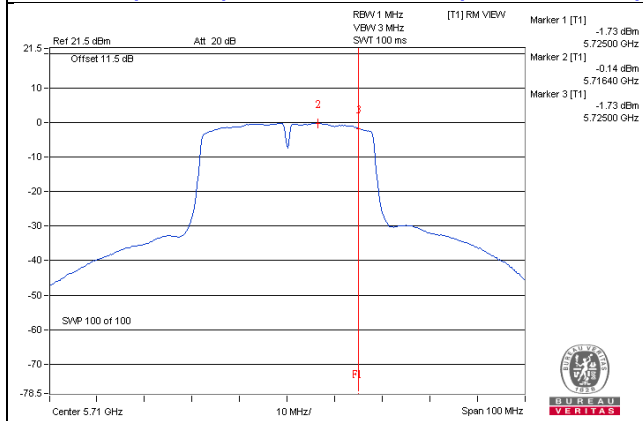

802.11ac (VHT80) / Chain 0- CH138(UNII-2C Band)

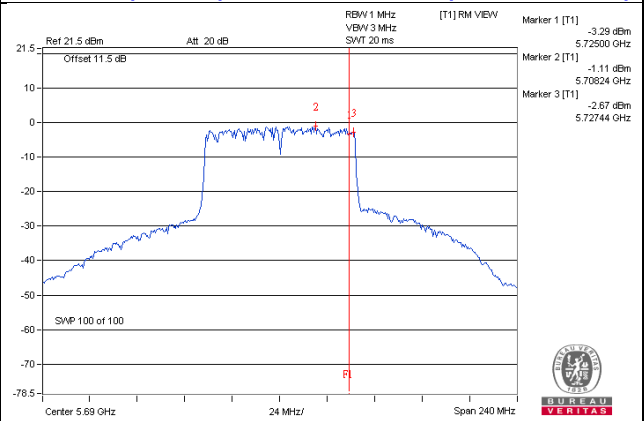

802.11ac (VHT80+80) / Chain 3 CH138(UNII-2C Band)

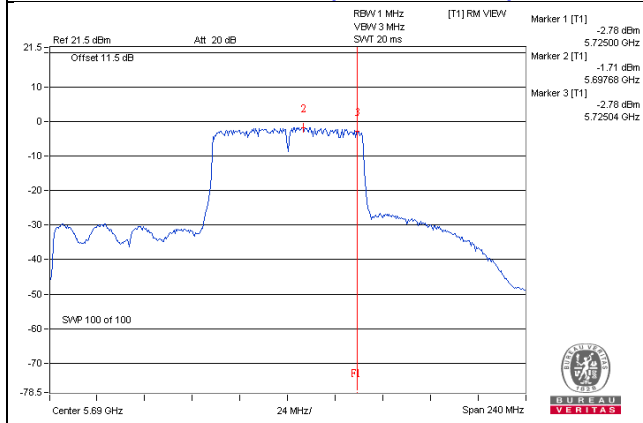

For U\_NII-3

Spectrum Plot of Worst Value

802.11a / Chain 0 – CH144(UNII-3 Band)

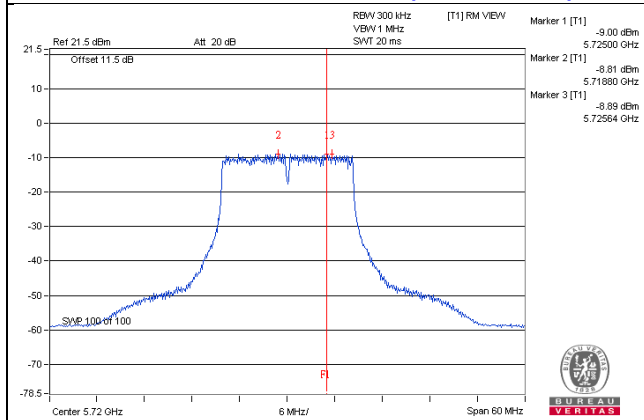

802.11ac (VHT20) / Chain 0 – CH144 (UNII-3 Band)

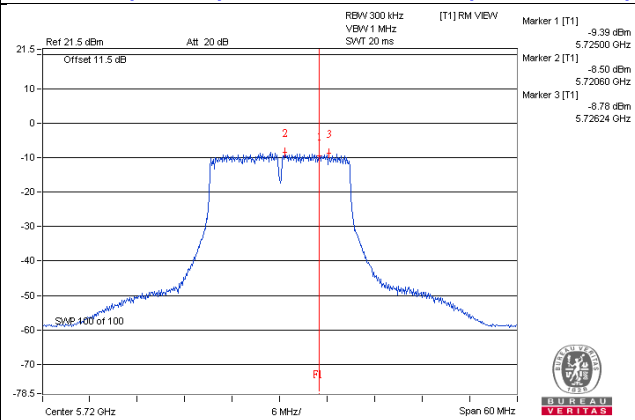

802.11ac (VHT40) / Chain 0 – CH142(UNII-3 Band)

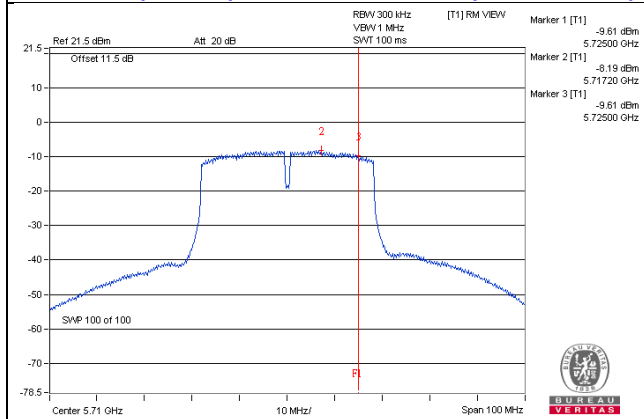

802.11ac (VHT80) / Chain 0 – CH138(UNII-3 Band)

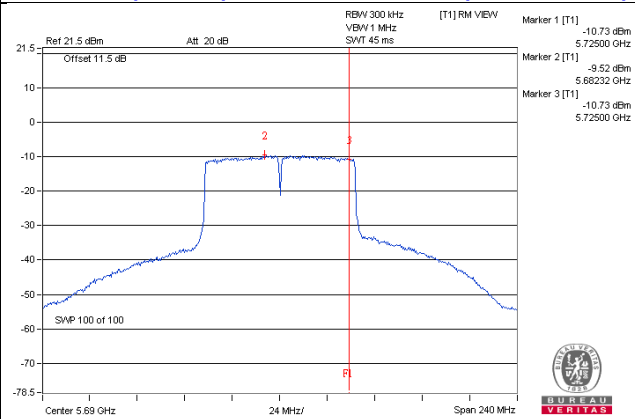

802.11ac (VHT80+80) / Chain 3– CH155(UNII-3 Band)

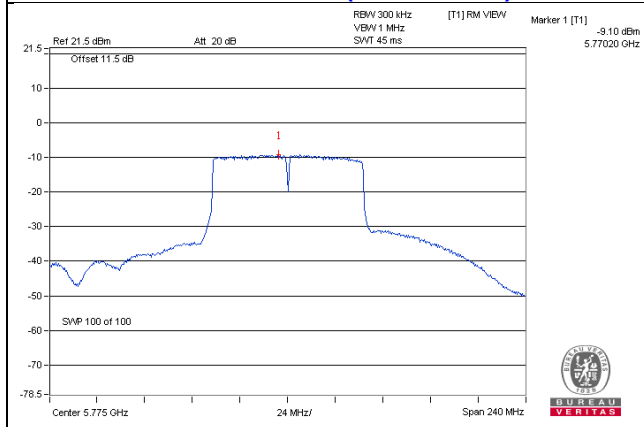

#### 4.5.8 Test Results (Mode 2)

##### 802.11a

##### For UNII-2A, UNII-2C:

Chan.	Chan. Freq. (MHz)	PSD W/O Duty Factor (dBm/MHz)			Duty Factor (dB)	Total PSD With Duty Factor (dBm/MHz)	MAX. Limit (dBm/MHz)	Pass / Fail
		Chain 0	Chain 1	Chain 2				
52	5260	0.82	0.86	-0.35	0.13	5.38	6.47	Pass
60	5300	1.64	0.00	0.71	0.13	5.74	6.47	Pass
64	5320	1.40	0.67	0.78	0.13	5.87	6.47	Pass
100	5500	1.90	0.53	-0.23	0.13	5.73	6.47	Pass
116	5580	2.07	0.50	-0.75	0.13	5.66	6.47	Pass
140	5700	1.33	1.02	-0.02	0.13	5.72	6.47	Pass
144 (UNII-2C Band)	5720	1.61	1.02	0.21	0.13	5.89	6.47	Pass

- Note:**
- Method a) of power density measurement of KDB 662911 is using for calculating total power density. Total power density is summing entire spectra across corresponding frequency bins on the various outputs by computer.
  - Directional gain =  $10 \log[(10^{G1/20} + 10^{G2/20} + 10^{G3/20})^2 / 3] = 10.53\text{dBi} > 6\text{dBi}$ , so the power density limit shall be reduced to  $11-(10.53-6) = 6.47\text{dBm}$ .
  - Refer to section 3.3 for duty cycle spectrum plot.

##### For U\_NII-3

TX chain	Chan.	Chan. Freq. (MHz)	PSD W/O Duty Factor		10 log (N=3) dB	Duty Factor (dB)	Total PSD With Duty Factor (dBm/500kHz)	Limit (dBm/500kHz)	Pass /Fail
			(dBm/300kHz)	(dBm/500kHz)					
0	144 (UNII-3 Band)	5720	-6.89	-4.67	4.77	0.13	0.23	25.47	Pass
1	144 (UNII-3 Band)	5720	-7.41	-5.19	4.77	0.13	-0.29	25.47	Pass
2	144 (UNII-3 Band)	5720	-8.38	-6.16	4.77	0.13	-1.26	25.47	Pass

- Note:**
- Directional gain =  $10 \log[(10^{G1/20} + 10^{G2/20} + 10^{G3/20})^2 / 3] = 10.53\text{dBi} > 6\text{dBi}$ , so the power density limit shall be reduced to  $30-(10.53-6) = 25.47\text{dBm}$ .
  - Refer to section 3.3 for duty cycle spectrum plot.

**802.11ac (VHT20)**
**For UNII-2A, UNII-2C:**

Chan.	Chan. Freq. (MHz)	PSD (dBm/MHz)			Total Power Density (dBm/MHz)	MAX. Limit (dBm/MHz)	Pass / Fail
		Chain 0	Chain 1	Chain 2			
52	5260	0.93	0.21	0.10	5.20	6.47	Pass
60	5300	1.25	0.56	0.76	5.64	6.47	Pass
64	5320	0.69	0.03	0.23	5.10	6.47	Pass
100	5500	1.47	0.63	-0.70	5.33	6.47	Pass
116	5580	1.47	0.33	-0.32	5.33	6.47	Pass
140	5700	1.48	0.53	-0.04	5.47	6.47	Pass
144 (UNII-2C Band)	5720	1.84	0.58	-0.03	5.64	6.47	Pass

- Note:** 1. Method a) of power density measurement of KDB 662911 is using for calculating total power density. Total power density is summing entire spectra across corresponding frequency bins on the various outputs by computer.
2. Directional gain =  $10 \log[(10^{G1/20} + 10^{G2/20} + 10^{G3/20})^2 / 3] = 10.53\text{dBi} > 6\text{dBi}$  , so the power density limit shall be reduced to  $11-(10.53-6) = 6.47\text{dBm}$ .

**For U\_NII-3**

TX chain	Chan.	Chan. Freq. (MHz)	PSD		10 log (N=3) dB	Total PSD (dBm/500kHz)	Limit (dBm/500kHz)	Pass /Fail
			(dBm/300kHz)	(dBm/500kHz)				
0	144 (UNII-3 Band)	5720	-6.35	-4.13	4.77	0.64	25.47	Pass
1	144 (UNII-3 Band)	5720	-7.79	-5.57	4.77	-0.80	25.47	Pass
2	144 (UNII-3 Band)	5720	-7.93	-5.71	4.77	-0.94	25.47	Pass

- Note:** 1. Directional gain =  $10 \log[(10^{G1/20} + 10^{G2/20} + 10^{G3/20})^2 / 3] = 10.53\text{dBi} > 6\text{dBi}$  , so the power density limit shall be reduced to  $30-(10.53-6) = 25.47\text{dBm}$ .



### 802.11ac (VHT40)

#### For UNII-2A, UNII-2C:

Chan.	Chan. Freq. (MHz)	PSD W/O Duty Factor (dBm/MHz)			Duty Factor (dB)	Total PSD With Duty Factor (dBm/MHz)	MAX. Limit (dBm/MHz)	Pass / Fail
		Chain 0	Chain 1	Chain 2				
54	5270	0.68	0.68	0.55	0.11	5.52	6.47	Pass
62	5310	-1.53	-2.57	-2.49	0.11	2.71	6.47	Pass
102	5510	-2.58	-3.83	-3.67	0.11	1.56	6.47	Pass
110	5550	2.03	0.82	0.00	0.11	5.92	6.47	Pass
134	5670	-0.09	-0.44	-1.86	0.11	4.15	6.47	Pass
142 (UNII-2C Band)	5710	1.75	0.57	0.40	0.11	5.83	6.47	Pass

- Note:**
- Method a) of power density measurement of KDB 662911 is using for calculating total power density. Total power density is summing entire spectra across corresponding frequency bins on the various outputs by computer.
  - Directional gain =  $10 \log[(10^{G1/20} + 10^{G2/20} + 10^{G3/20})^2 / 3] = 10.53\text{dBi} > 6\text{dBi}$ , so the power density limit shall be reduced to  $11 - (10.53 - 6) = 6.47\text{dBm}$ .
  - Refer to section 3.3 for duty cycle spectrum plot.

#### For U\_NII-3

TX chain	Chan.	Chan. Freq. (MHz)	PSD W/O Duty Factor		10 log (N=3) dB	Duty Factor (dB)	Total PSD With Duty Factor (dBm/500kHz)	Limit (dBm/500kHz)	Pass /Fail
			(dBm/300kHz)	(dBm/500kHz)					
0	142 (UNII-3 Band)	5710	-7.58	-5.36	4.77	0.11	-0.48	25.47	Pass
1	142 (UNII-3 Band)	5710	-9.07	-6.85	4.77	0.11	-1.97	25.47	Pass
2	142 (UNII-3 Band)	5710	-9.10	-6.88	4.77	0.11	-2.00	25.47	Pass

- Note:**
- Directional gain =  $10 \log[(10^{G1/20} + 10^{G2/20} + 10^{G3/20})^2 / 3] = 10.53\text{dBi} > 6\text{dBi}$ , so the power density limit shall be reduced to  $30 - (10.53 - 6) = 25.47\text{dBm}$ .
  - Refer to section 3.3 for duty cycle spectrum plot.

### 802.11ac (VHT80)

#### For UNII-2A, UNII-2C:

Chan.	Chan. Freq. (MHz)	PSD W/O Duty Factor (dBm/MHz)			Duty Factor (dB)	Total PSD With Duty Factor (dBm/MHz)	MAX. Limit (dBm/MHz)	Pass / Fail
		Chain 0	Chain 1	Chain 2				
58	5290	-10.96	-12.00	-12.40	0.24	-6.73	6.47	Pass
106	5530	-9.78	-11.03	-11.87	0.24	-5.80	6.47	Pass
122	5610	-3.58	-5.40	-5.95	0.24	0.15	6.47	Pass
138 (UNII-2C Band)	5690	-1.24	-1.16	-2.05	0.24	3.54	6.47	Pass

- Note:**
- Method a) of power density measurement of KDB 662911 is using for calculating total power density. Total power density is summing entire spectra across corresponding frequency bins on the various outputs by computer.
  - Directional gain =  $10 \log[(10^{G1/20} + 10^{G2/20} + 10^{G3/20})^2 / 3] = 10.53\text{dBi} > 6\text{dBi}$ , so the power density limit shall be reduced to  $11-(10.53-6) = 6.47\text{dBm}$ .
  - Refer to section 3.3 for duty cycle spectrum plot.

#### For U\_NII-3

TX chain	Chan.	Chan. Freq. (MHz)	PSD W/O Duty Factor		10 log (N=3) dB	Duty Factor (dB)	Total PSD With Duty Factor (dBm/500kHz)	Limit (dBm/500kHz)	Pass /Fail
			(dBm/300kHz)	(dBm/500kHz)					
0	138 (UNII-3 Band)	5690	-10.32	-8.10	4.77	0.24	-3.09	25.47	Pass
1	138 (UNII-3 Band)	5690	-10.37	-8.15	4.77	0.24	-3.14	25.47	Pass
2	138 (UNII-3 Band)	5690	-11.00	-8.78	4.77	0.24	-3.77	25.47	Pass

- Note:**
- Directional gain =  $10 \log[(10^{G1/20} + 10^{G2/20} + 10^{G3/20})^2 / 3] = 10.53\text{dBi} > 6\text{dBi}$ , so the power density limit shall be reduced to  $30-(10.53-6) = 25.47\text{dBm}$ .
  - Refer to section 3.3 for duty cycle spectrum plot.

For UNII-2A, UNII-2C

Spectrum Plot of Worst Value

802.11a\_Chain 0 / CH116

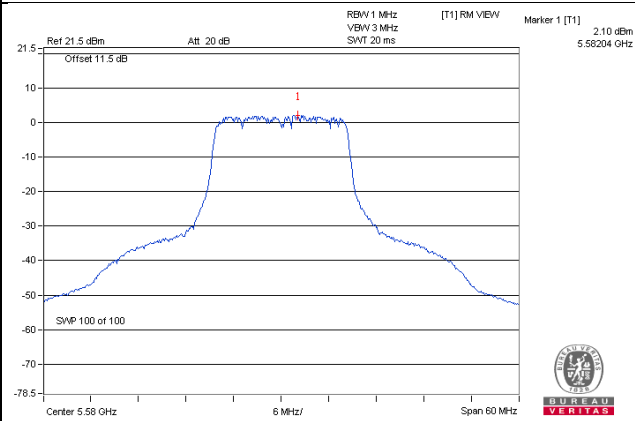

802.11ac (VHT20)\_Chain 0 / CH144 (UNII-2C band)

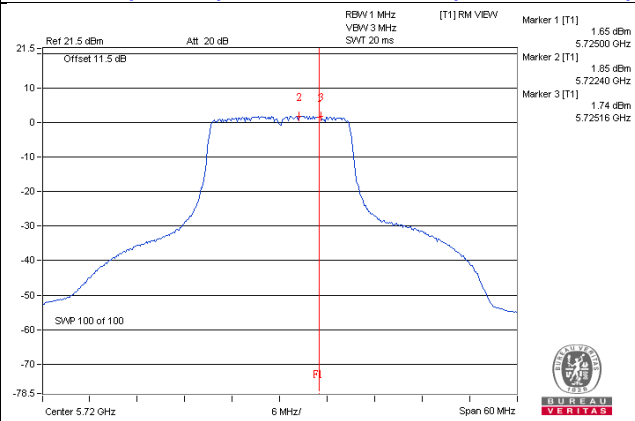

802.11ac (VHT40)\_Chain 0 / CH110

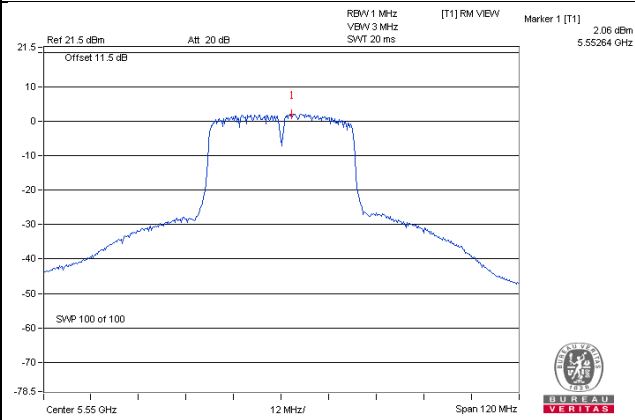

802.11ac (VHT80)\_Chain 1 / CH138 (UNII-2C band)

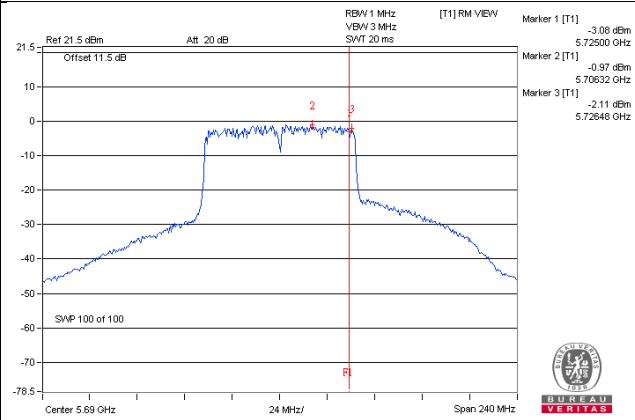

For UNII-3:

Spectrum Plot of Worst Value

802.11a / Chain 0 – CH144(UNII-3 Band)

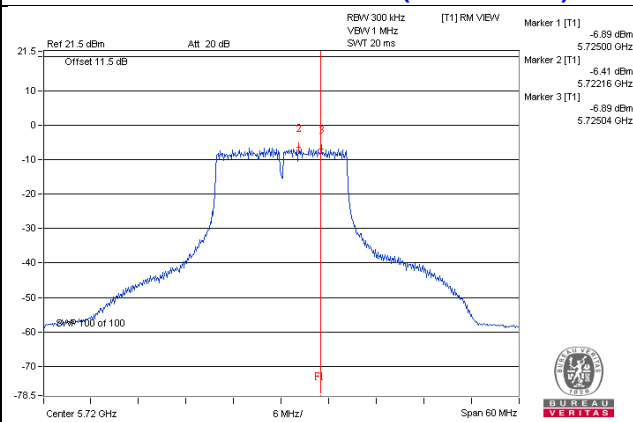

802.11ac (VHT20) / Chain 0 – CH144 (UNII-3 Band)

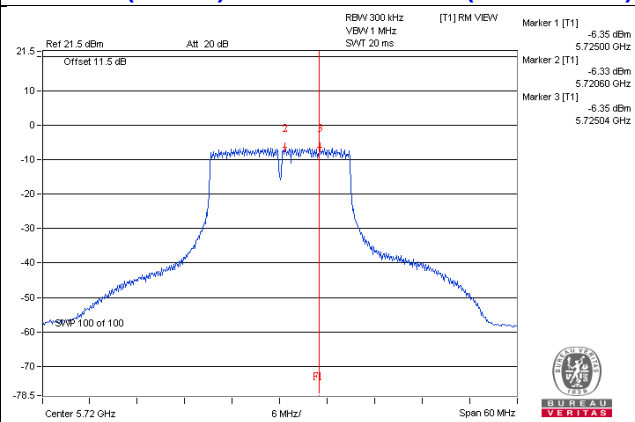

802.11ac (VHT40) / Chain 0– CH142(UNII-3 Band)

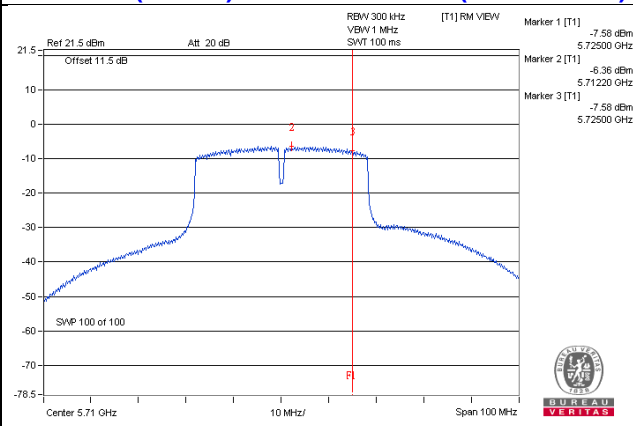

802.11ac (VHT80) / Chain 0 – CH138(UNII-3 Band)

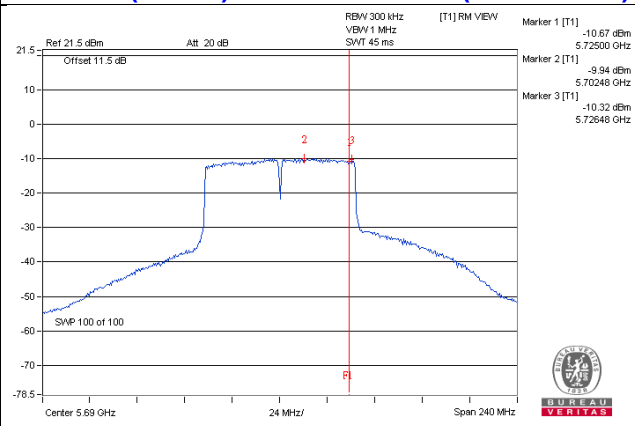

#### 4.5.9 Test Results (Mode 3)

##### 802.11a

##### For UNII-2A, UNII-2C:

Chan.	Chan. Freq. (MHz)	PSD W/O Duty Factor (dBm/MHz)		Duty Factor (dB)	Total PSD With Duty Factor (dBm/MHz)	MAX. Limit (dBm/MHz)	Pass / Fail
		Chain 0	Chain 1				
52	5260	4.22	3.97	0.13	7.24	8.16	Pass
60	5300	4.53	3.91	0.13	7.37	8.16	Pass
64	5320	4.63	3.87	0.13	7.41	8.16	Pass
100	5500	4.97	3.55	0.13	7.46	8.16	Pass
116	5580	4.88	4.08	0.13	7.64	8.16	Pass
140	5700	3.71	1.93	0.13	6.05	8.16	Pass
144 (UNII-2C Band)	5720	5.04	3.69	0.13	7.56	8.16	Pass

- Note:**
- Method a) of power density measurement of KDB 662911 is using for calculating total power density. Total power density is summing entire spectra across corresponding frequency bins on the various outputs by computer.
  - Directional gain =  $10 \log[(10^{G1/20} + 10^{G2/20})^2 / 2] = 8.84\text{dBi} > 6\text{dBi}$ , so the power density limit shall be reduced to  $11 - (8.84 - 6) = 8.16\text{dBm}$ .
  - Refer to section 3.3 for duty cycle spectrum plot.

##### For U\_NII-3

TX chain	Chan.	Chan. Freq. (MHz)	PSD W/O Duty Factor		10 log (N=2) dB	Duty Factor (dB)	Total PSD With Duty Factor (dBm/500kHz)	Limit (dBm/500kHz)	Pass /Fail
			(dBm/300kHz)	(dBm/500kHz)					
0	144 (UNII-3 Band)	5720	-3.17	-0.95	3.01	0.13	2.19	27.16	Pass
1	144 (UNII-3 Band)	5720	-4.61	-2.39	3.01	0.13	0.75	27.16	Pass

- Note:**
- Directional gain =  $10 \log[(10^{G1/20} + 10^{G2/20})^2 / 2] = 8.84\text{dBi} > 6\text{dBi}$ , so the power density limit shall be reduced to  $30 - (8.84 - 6) = 27.16\text{dBm}$ .
  - Refer to section 3.3 for duty cycle spectrum plot.

### 802.11ac (VHT20)

#### For UNII-2A, UNII-2C:

Chan.	Chan. Freq. (MHz)	PSD (dBm/MHz)		Total Power Density (dBm/MHz)	MAX. Limit (dBm/MHz)	Pass / Fail
		Chain 0	Chain 1			
52	5260	4.43	3.83	7.15	8.16	Pass
60	5300	4.74	3.75	7.28	8.16	Pass
64	5320	4.71	3.66	7.23	8.16	Pass
100	5500	4.49	3.31	6.95	8.16	Pass
116	5580	5.01	3.46	7.31	8.16	Pass
140	5700	1.77	0.27	4.09	8.16	Pass
144 (UNII-2C Band)	5720	4.39	3.33	6.90	8.16	Pass

- Note:** 1. Method a) of power density measurement of KDB 662911 is using for calculating total power density. Total power density is summing entire spectra across corresponding frequency bins on the various outputs by computer.
2. Directional gain =  $10 \log[(10^{G1/20} + 10^{G2/20})^2 / 2] = 8.84\text{dBi} > 6\text{dBi}$ , so the power density limit shall be reduced to  $11 - (8.84 - 6) = 8.16\text{dBm}$ .

#### For U\_NII-3

TX chain	Chan.	Chan. Freq. (MHz)	PSD		10 log (N=2) dB	Total PSD (dBm/500kHz)	Limit (dBm/500kHz)	Pass /Fail
			(dBm/300kHz)	(dBm/500kHz)				
0	144 (UNII-3 Band)	5720	-4.09	-1.87	3.01	1.14	27.16	Pass
1	144 (UNII-3 Band)	5720	-4.66	-2.44	3.01	0.57	27.16	Pass

- Note:** 1. Directional gain =  $10 \log[(10^{G1/20} + 10^{G2/20})^2 / 2] = 8.84\text{dBi} > 6\text{dBi}$ , so the power density limit shall be reduced to  $30 - (8.84 - 6) = 27.16\text{dBm}$ .

### 802.11ac (VHT40)

#### For UNII-2A, UNII-2C:

Chan.	Chan. Freq. (MHz)	PSD W/O Duty Factor (dBm/MHz)		Duty Factor (dB)	Total PSD With Duty Factor (dBm/MHz)	MAX. Limit (dBm/MHz)	Pass / Fail
		Chain 0	Chain 1				
54	5270	4.19	3.17	0.11	6.83	8.16	Pass
62	5310	-2.02	-2.40	0.11	0.92	8.16	Pass
102	5510	-2.58	-3.65	0.11	0.04	8.16	Pass
110	5550	4.78	3.37	0.11	7.26	8.16	Pass
134	5670	1.06	0.01	0.11	3.69	8.16	Pass
142 (UNII-2C Band)	5710	2.72	2.82	0.11	5.89	8.16	Pass

- Note:**
- Method a) of power density measurement of KDB 662911 is using for calculating total power density. Total power density is summing entire spectra across corresponding frequency bins on the various outputs by computer.
  - Directional gain =  $10 \log[(10^{G1/20} + 10^{G2/20})^2 / 2] = 8.84\text{dBi} > 6\text{dBi}$ , so the power density limit shall be reduced to  $11-(8.84-6) = 8.16\text{dBm}$ .
  - Refer to section 3.3 for duty cycle spectrum plot.

#### For U\_NII-3

TX chain	Chan.	Chan. Freq. (MHz)	PSD W/O Duty Factor		10 log (N=2) dB	Duty Factor (dB)	Total PSD With Duty Factor (dBm/500kHz)	Limit (dBm/500kHz)	Pass /Fail
			(dBm/300kHz)	(dBm/500kHz)					
0	142 (UNII-3 Band)	5710	-6.83	-4.61	3.01	0.11	-1.49	27.16	Pass
1	142 (UNII-3 Band)	5710	-6.84	-4.62	3.01	0.11	-1.50	27.16	Pass

- Note:**
- Directional gain =  $10 \log[(10^{G1/20} + 10^{G2/20})^2 / 2] = 8.84\text{dBi} > 6\text{dBi}$ , so the power density limit shall be reduced to  $30-(8.84-6) = 27.16\text{dBm}$ .
  - Refer to section 3.3 for duty cycle spectrum plot.

### 802.11ac (VHT80)

#### For UNII-2A, UNII-2C:

Chan.	Chan. Freq. (MHz)	PSD W/O Duty Factor (dBm/MHz)		Duty Factor (dB)	Total PSD With Duty Factor (dBm/MHz)	MAX. Limit (dBm/MHz)	Pass / Fail
		Chain 0	Chain 1				
58	5290	-7.70	-7.95	0.24	-4.58	8.16	Pass
106	5530	-9.45	-10.20	0.24	-6.56	8.16	Pass
122	5610	-2.72	-2.53	0.24	0.62	8.16	Pass
138 (UNII-2C Band)	5690	0.86	-1.52	0.24	3.08	8.16	Pass

- Note:**
- Method a) of power density measurement of KDB 662911 is using for calculating total power density. Total power density is summing entire spectra across corresponding frequency bins on the various outputs by computer.
  - Directional gain =  $10 \log[(10^{G1/20} + 10^{G2/20})^2 / 2] = 8.84\text{dBi} > 6\text{dBi}$ , so the power density limit shall be reduced to  $11-(8.84-6) = 8.16\text{dBm}$ .
  - Refer to section 3.3 for duty cycle spectrum plot.

#### For U\_NII-3

TX chain	Chan.	Chan. Freq. (MHz)	PSD W/O Duty Factor		10 log (N=2) dB	Duty Factor (dB)	Total PSD With Duty Factor (dBm/500kHz)	Limit (dBm/500kHz)	Pass /Fail
			(dBm/300kHz)	(dBm/500kHz)					
0	138 (UNII-3 Band)	5690	-8.85	-6.63	3.01	0.24	-3.38	27.16	Pass
1	138 (UNII-3 Band)	5690	-10.78	-8.56	3.01	0.24	-5.31	27.16	Pass

- Note:**
- Directional gain =  $10 \log[(10^{G1/20} + 10^{G2/20})^2 / 2] = 8.84\text{dBi} > 6\text{dBi}$ , so the power density limit shall be reduced to  $30-(8.84-6) = 27.16\text{dBm}$ .
  - Refer to section 3.3 for duty cycle spectrum plot.



**802.11ac (VHT80+80)**
**For U\_NII-1, U\_NII-2A, U\_NII-2C**

Chan.	Chan. Freq. (MHz)	PSD W/O Duty Factor (dBm/MHz)		Duty Factor (dB)	Total PSD With Duty Factor (dBm/MHz)	MAX. Limit (dBm/MHz)	Pass / Fail
		Chain 0	Chain 2				
42+58	5210	-6.52	-	0.16	-6.36	17.00	Pass
	5290	-	-6.87	0.16	-6.71	11.00	Pass
42+106	5210	-6.52	-	0.16	-6.36	17.00	Pass
	5530	-	-6.83	0.16	-6.67	11.00	Pass
42+122	5210	-6.52	-	0.16	-6.36	17.00	Pass
	5610	-	-7.07	0.16	-6.91	11.00	Pass
42+ 138 (UNII-2C)+ 138 (UNII-3)	5210	-6.52	-	0.16	-6.36	17.00	Pass
	5690	-	-0.50	0.16	-0.34	11.00	Pass
	5690	Test results refer to U_NII-3 data					
58+106	5290	-6.46	-	0.16	-6.30	11.00	Pass
	5530	-	-6.83	0.16	-6.67	11.00	Pass
58+122	5290	-6.46	-	0.16	-6.30	11.00	Pass
	5610	-	-7.07	0.16	-6.91	11.00	Pass
58+ 138 (UNII-2C)+ 138 (UNII-3)	5290	-6.46	-	0.16	-6.30	11.00	Pass
	5690	-	-0.50	0.16	-0.34	11.00	Pass
	5690	Test results refer to U_NII-3 data					
58+155	5290	-6.46	-	0.16	-6.30	11.00	Pass
	5775	Test results refer to U_NII-3 data					
106+122	5530	-6.43	-	0.16	-3.57	8.21	Pass
	5610	-	-7.07	0.16			Pass
106 +138(UNII-2C) +138(UNII-3)	5530	-6.43	-	0.16	-3.38	8.21	Pass
	5690	-	-6.68	0.16			Pass
	5690	Test results refer to U_NII-3 data					
106+155	5530	-6.43	-	0.16	-6.27	11.00	Pass
	5775	Test results refer to U_NII-3 data					
122 +138(UNII-2C) +138(UNII-3)	5610	0.35	-	0.16	3.11	8.21	Pass
	5690	-	-0.50	0.16			Pass
	5690	Test results refer to U_NII-3 data					
122+155	5610	0.35	-	0.16	0.51	11.00	Pass
	5775	Test results refer to U_NII-3 data					
138 (UNII-2C) +138(UNII-3) +155	5690	1.83	-	0.16	1.99	11.00	Pass
	5690	Test results refer to U_NII-3 data					
	5775	Test results refer to U_NII-3 data					

- Note:**
1. Method a) of power density measurement of KDB 662911 is using for calculating total power density. Total power density is summing entire spectra across corresponding frequency bins on the various outputs by computer.
  2. Directional gain =  $10 \log[(10^{G1/20} + 10^{G2/20})^2 / 2] = 8.79\text{dBi} > 6\text{dBi}$  , so the power density limit shall be reduced to  $11 - (8.79 - 6) = 8.21\text{dBm}$ .
  3. Refer to section 3.3 for duty cycle spectrum plot.

**For U\_NII-3**

Chan.	TX chain	Chan. Freq. (MHz)	PSD W/O Duty Factor		10 log (N=2) dB	Duty Factor (dB)	Total PSD With Duty Factor (dBm/500kHz)	Limit (dBm/500kHz)	Pass /Fail
			(dBm/300kHz)	(dBm/500kHz)					
138 (UNII-2C) +138 (UNII-3) +155	0	5690	Test results refer to U_NII-2C data						
		5690	-7.84	-5.62	3.01	0.16	-5.46	27.21	Pass
	2	5775	-8.01	-5.79	3.01	0.16	-2.62	27.21	Pass
Chan.	TX chain	Chan. Freq. (MHz)	PSD W/O Duty Factor		10 log (N=1) dB	Duty Factor (dB)	Total PSD With Duty Factor (dBm/500kHz)	Limit (dBm/500kHz)	Pass /Fail
			(dBm/300kHz)	(dBm/500kHz)					
42+ 138 (UNII-2C) +138 (UNII-3)	0	5210	Test results refer to U_NII-1 data						
	2	5690	Test results refer to U_NII-2C data						
		5690	-10.31	-8.09	0	0.16	-7.93	30.00	Pass
Chan.	TX chain	Chan. Freq. (MHz)	PSD W/O Duty Factor		10 log (N=1) dB	Duty Factor (dB)	Total PSD With Duty Factor (dBm/500kHz)	Limit (dBm/500kHz)	Pass /Fail
			(dBm/300kHz)	(dBm/500kHz)					
58+ 138 (UNII-2C) +138 (UNII-3)	0	5290	Test results refer to U_NII-2A data						
	2	5690	Test results refer to U_NII-2C data						
		5690	-10.31	-8.09	0	0.16	-7.93	30.00	Pass
Chan.	TX chain	Chan. Freq. (MHz)	PSD W/O Duty Factor		10 log (N=1) dB	Duty Factor (dB)	Total PSD With Duty Factor (dBm/500kHz)	Limit (dBm/500kHz)	Pass /Fail
			(dBm/300kHz)	(dBm/500kHz)					
58+ 155	0	5290	Test results refer to U_NII-2A data						
	2	5775	-8.01	-5.79	0	0.16	-5.63	30.00	Pass

Chan.	TX chain	Chan. Freq. (MHz)	PSD W/O Duty Factor		10 log (N=1) dB	Duty Factor (dB)	Total PSD With Duty Factor (dBm/500kHz)	Limit (dBm/500kHz)	Pass /Fail
			(dBm/300kHz)	(dBm/500kHz)					
106+ 155	0	5530	Test results refer to U_NII-2C data						
	2	5775	-8.01	-5.79	0	0.16	-5.63	30.00	Pass
Chan.	TX chain	Chan. Freq. (MHz)	PSD W/O Duty Factor		10 log (N=1) dB	Duty Factor (dB)	Total PSD With Duty Factor (dBm/500kHz)	Limit (dBm/500kHz)	Pass /Fail
			(dBm/300kHz)	(dBm/500kHz)					
122+ 155	0	5610	Test results refer to U_NII-2C data						
	2	5775	-8.01	-5.79	0	0.16	-5.63	30.00	Pass
Chan.	TX chain	Chan. Freq. (MHz)	PSD W/O Duty Factor		10 log (N=1) dB	Duty Factor (dB)	Total PSD With Duty Factor (dBm/500kHz)	Limit (dBm/500kHz)	Pass /Fail
			(dBm/300kHz)	(dBm/500kHz)					
106 +138 (UNII-2C) +138 (UNII-3)	0	5530	Test results refer to U_NII-2C data						
	2	5690	Test results refer to U_NII-2C data						
		5690	-10.31	-8.09	0	0.16	-7.93	30.00	Pass
Chan.	TX chain	Chan. Freq. (MHz)	PSD W/O Duty Factor		10 log (N=1) dB	Duty Factor (dB)	Total PSD With Duty Factor (dBm/500kHz)	Limit (dBm/500kHz)	Pass /Fail
			(dBm/300kHz)	(dBm/500kHz)					
122 +138 (UNII-2C) +138 (UNII-3)	0	5610	Test results refer to U_NII-2C data						
	2	5690	Test results refer to U_NII-2C data						
		5690	-10.31	-8.09	0	0.16	-7.93	30.00	Pass

- Note:** 1. Directional gain =  $10 \log[(10^{G1/20} + 10^{G2/20})^2 / 2] = 8.79\text{dBi} > 6\text{dBi}$ , so the power density limit shall be reduced to  $30 - (8.79 - 6) = 27.21\text{dBm}$ .
2. Refer to section 3.3 for duty cycle spectrum plot.

For UNII-1, UNII-2A, UNII-2C

Spectrum Plot of Worst Value

802.11a\_Chain 0 / CH116

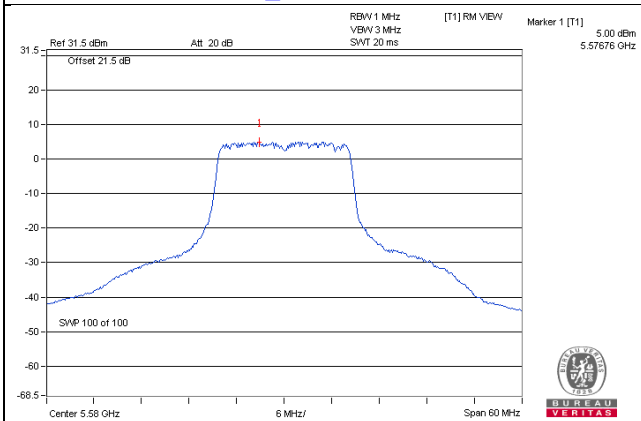

802.11ac (VHT20)\_Chain 0 / CH144 (UNII-2C band)

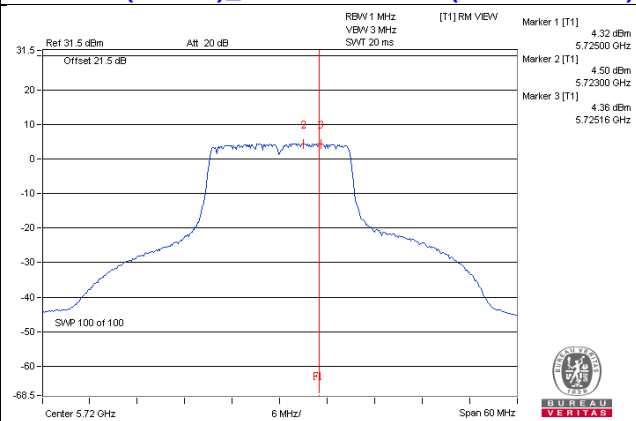

802.11ac (VHT40)\_Chain 0 / CH110

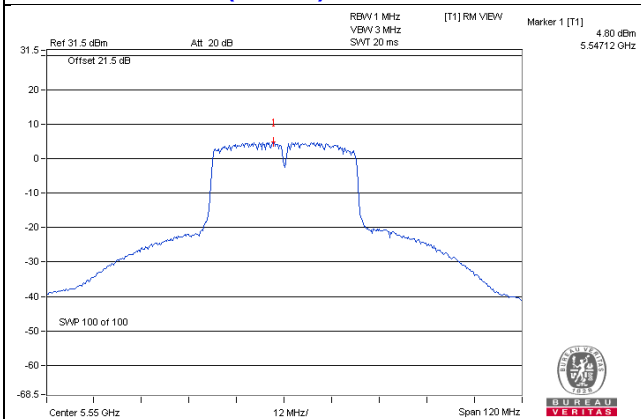

802.11ac (VHT80)\_Chain 1 / CH138 (UNII-2C band)

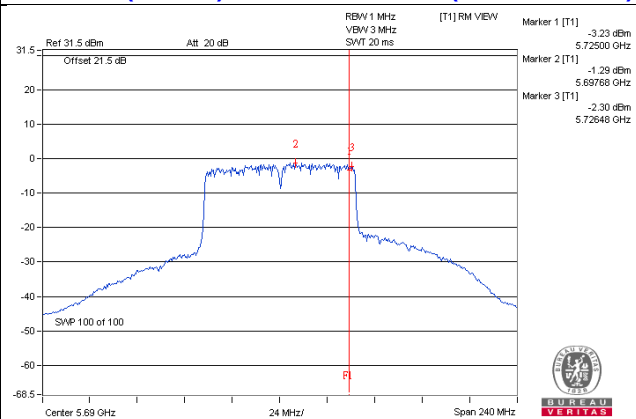

802.11ac (VHT80+80) / Chain 0 CH138(UNII-2C Band)

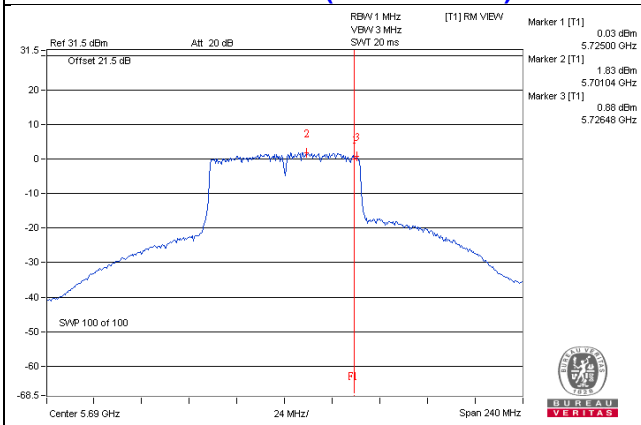

For UNII-3:

Spectrum Plot of Worst Value

802.11a / Chain 0 – CH144(UNII-3 Band)

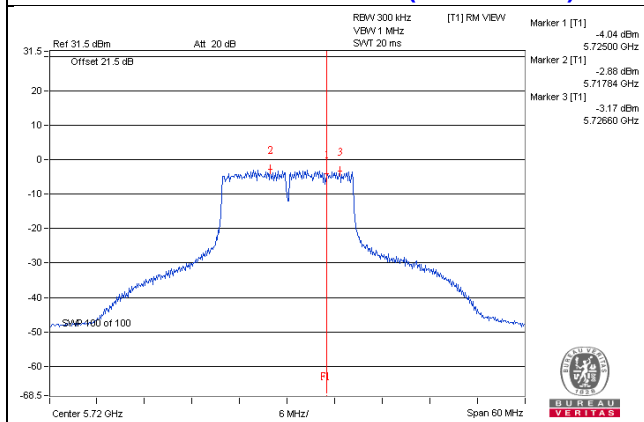

802.11ac (VHT20) / Chain 0 – CH144 (UNII-3 Band)

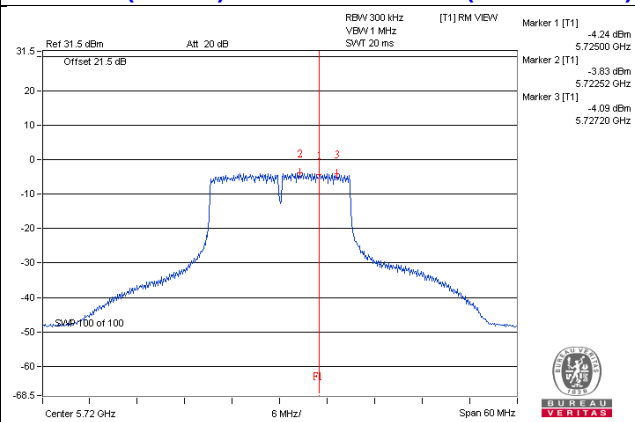

802.11ac (VHT40) / Chain 0– CH142(UNII-3 Band)

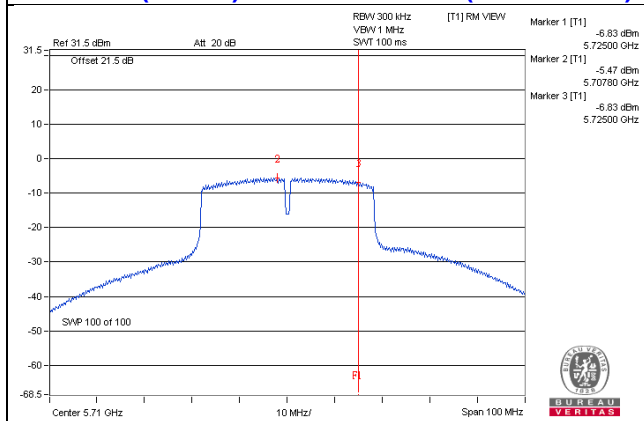

802.11ac (VHT80) / Chain 0 – CH138(UNII-3 Band)

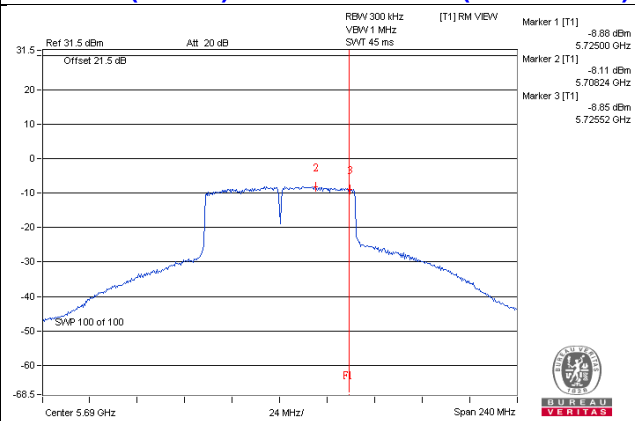

802.11ac (VHT80+80) / Chain 0– CH138(UNII-3 Band)

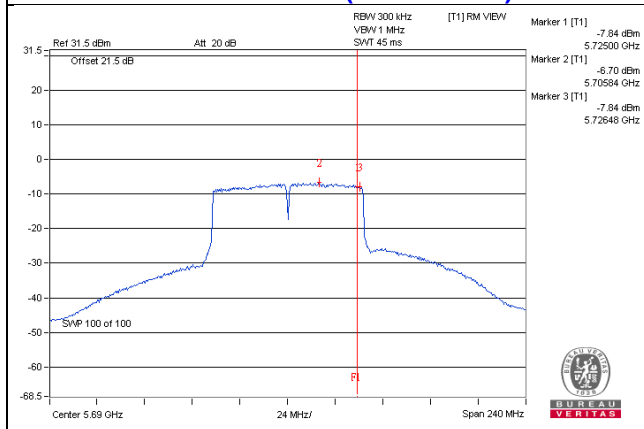

#### 4.5.10 Test Results (Mode 4)

##### 802.11a

##### For UNII-2A, UNII-2C

Chan.	Chan. Freq. (MHz)	PSD W/O Duty Factor (dBm/MHz)	Duty Factor (dB)	PSD With Duty Factor (dBm/MHz)	MAX. Limit (dBm/MHz)	Pass / Fail
52	5260	9.21	0.13	9.34	11.00	Pass
60	5300	10.01	0.13	10.14	11.00	Pass
64	5320	7.46	0.13	7.59	11.00	Pass
100	5500	6.75	0.13	6.88	11.00	Pass
116	5580	9.33	0.13	9.46	11.00	Pass
140	5700	4.15	0.13	4.28	11.00	Pass
144 (UNII-2C Band)	5720	7.66	0.13	7.79	11.00	Pass

**Note:** 1. Refer to section 3.3 for duty cycle spectrum plot.

##### For UNII-3

Chan.	Chan. Freq. (MHz)	PSD W/O Duty Factor		Duty Factor (dB)	Total PSD With Duty Factor (dBm/500kHz)	Limit (dBm/500kHz)	Pass /Fail
		(dBm/300kHz)	(dBm/500kHz)				
144 (U-NII-3 Band)	5720	-0.24	1.98	0.13	2.11	30.00	Pass

**Note:** 1. Refer to section 3.3 for duty cycle spectrum plot.

**802.11ac (VHT20)**
**For UNII-2A, UNII-2C**

Chan.	Chan. Freq. (MHz)	PSD (dBm/MHz)	MAX. Limit (dBm/MHz)	Pass / Fail
52	5260	9.36	11	Pass
60	5300	9.39	11	Pass
64	5320	6.52	11	Pass
100	5500	5.66	11	Pass
116	5580	7.49	11	Pass
140	5700	2.66	11	Pass
144 (UNII-2C Band)	5720	7.25	11	Pass

**For UNII-3**

Chan.	Chan. Freq. (MHz)	PSD (dBm/300kHz)	PSD (dBm/500kHz)	Limit (dBm/500kHz)	Pass /Fail
144 (U-NII-3 Band)	5720	-0.91	1.31	30.00	Pass



**802.11ac (VHT40)**
**For UNII-2A, UNII-2C**

Chan.	Chan. Freq. (MHz)	PSD W/O Duty Factor (dBm/MHz)	Duty Factor (dB)	PSD With Duty Factor (dBm/MHz)	MAX. Limit (dBm/MHz)	Pass / Fail
54	5270	5.88	0.11	5.99	11.00	Pass
62	5310	-1.34	0.11	-1.23	11.00	Pass
102	5510	-0.79	0.11	-0.68	11.00	Pass
110	5550	6.34	0.11	6.45	11.00	Pass
134	5670	2.05	0.11	2.16	11.00	Pass
142 (UNII-2C Band)	5710	4.67	0.11	4.78	11.00	Pass

**Note:** 1. Refer to section 3.3 for duty cycle spectrum plot.

**For UNII-3**

Chan.	Chan. Freq. (MHz)	PSD W/O Duty Factor		Duty Factor (dB)	Total PSD With Duty Factor (dBm/500kHz)	Limit (dBm/500kHz)	Pass /Fail
		(dBm/300kHz)	(dBm/500kHz)				
142 (U-NII-3 Band)	5710	-4.75	-2.53	0.11	-2.42	30.00	Pass

**802.11ac (VHT80)**
**For UNII-2A, UNII-2C**

Chan.	Chan. Freq. (MHz)	PSD W/O Duty Factor (dBm/MHz)	Duty Factor (dB)	PSD With Duty Factor (dBm/MHz)	MAX. Limit (dBm/MHz)	Pass / Fail
58	5290	-4.81	0.24	-4.57	11.00	Pass
106	5530	-4.78	0.24	-4.54	11.00	Pass
122	5610	-1.25	0.24	-1.01	11.00	Pass
138 (UNII-2C Band)	5690	0.69	0.24	0.93	11.00	Pass

**Note:** 1. Refer to section 3.3 for duty cycle spectrum plot.

**For UNII-3**

Chan.	Chan. Freq. (MHz)	PSD W/O Duty Factor		Duty Factor (dB)	Total PSD With Duty Factor (dBm/500kHz)	Limit (dBm/500kHz)	Pass /Fail
		(dBm/300kHz)	(dBm/500kHz)				
138 (U-NII-3 Band)	5690	-8.71	-6.49	0.24	-6.25	30.00	Pass

For UNII-2A, UNII-2C

Spectrum Plot of Worst Value

802.11a / CH60

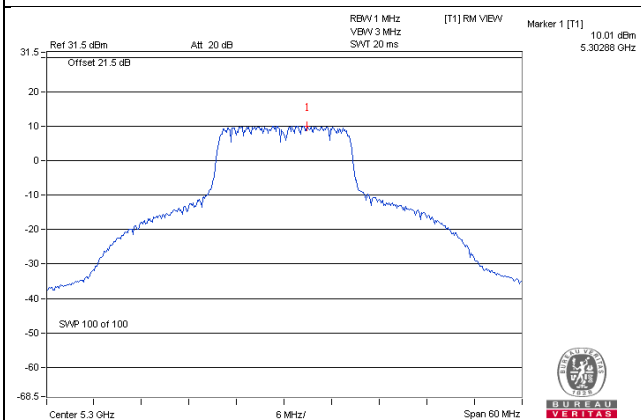

802.11ac (VHT20) / CH60

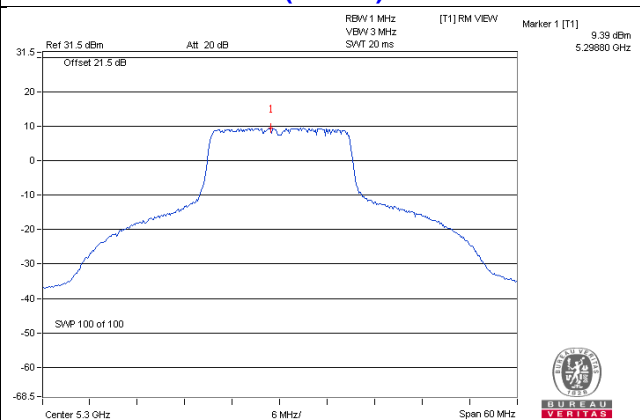

802.11ac (VHT40) / CH110

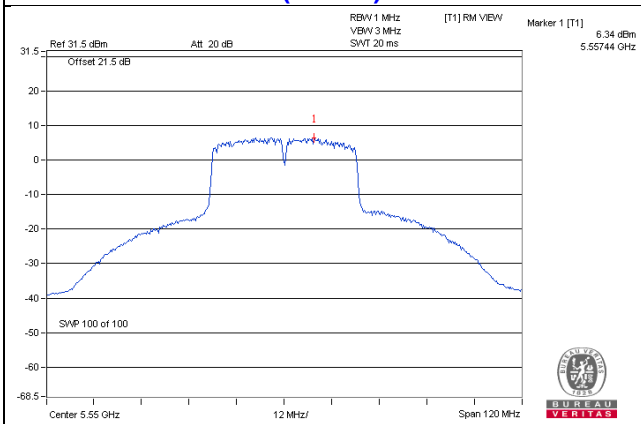

802.11ac (VHT80) / CH138 (UNII-2C band)

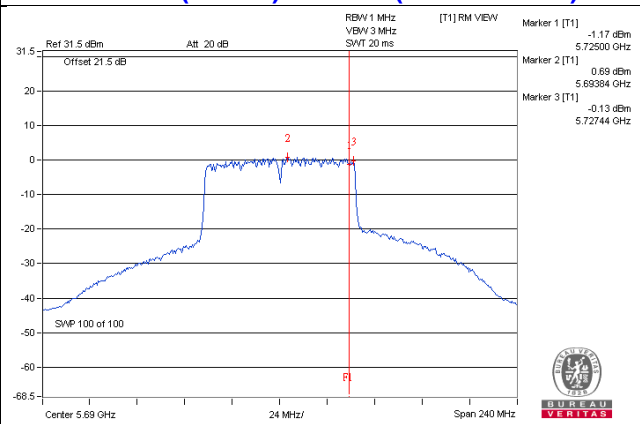

For UNII-3

Spectrum Plot of Worst Value

802.11a: CH 144 (UNII-3)

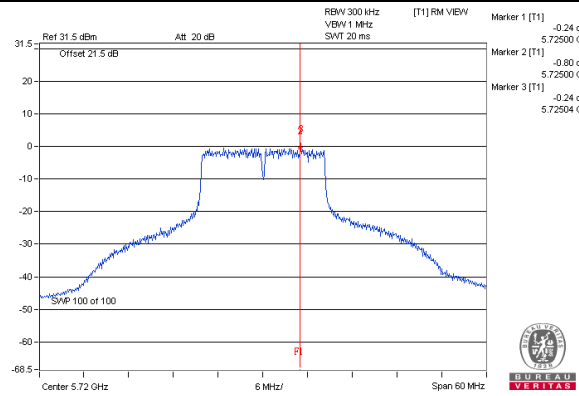

802.11ac (VHT20): CH 144 (UNII-3)

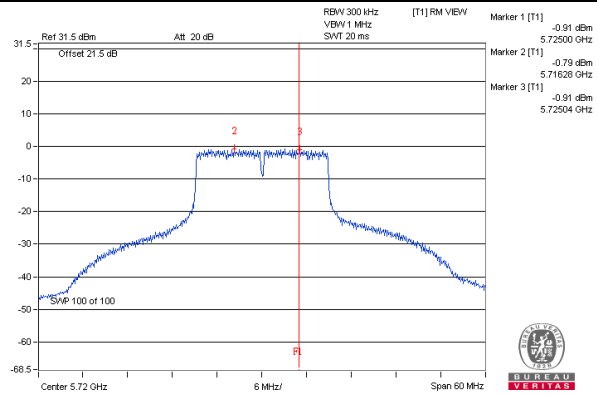

802.11ac (VHT40): CH 142 (UNII-3)

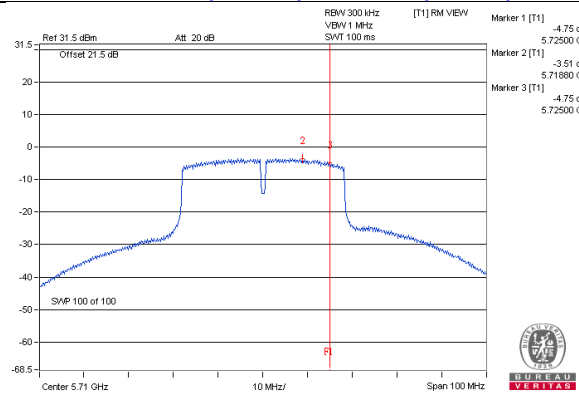

802.11ac (VHT80): CH 138 (UNII-3)

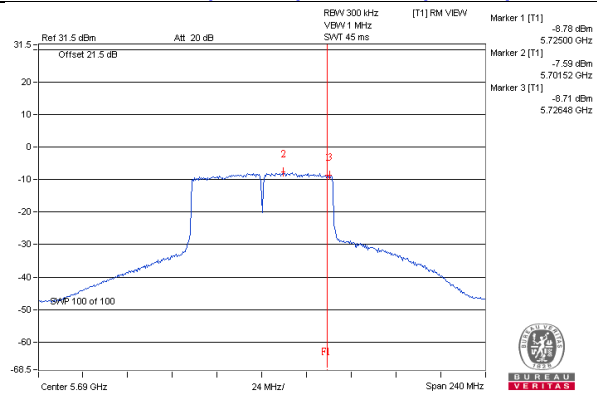

## 4.6 Frequency Stability Measurement

### 4.6.1 Limits of Frequency Stability Measurement

The frequency of the carrier signal shall be maintained within band of operation

### 4.6.2 Test Setup

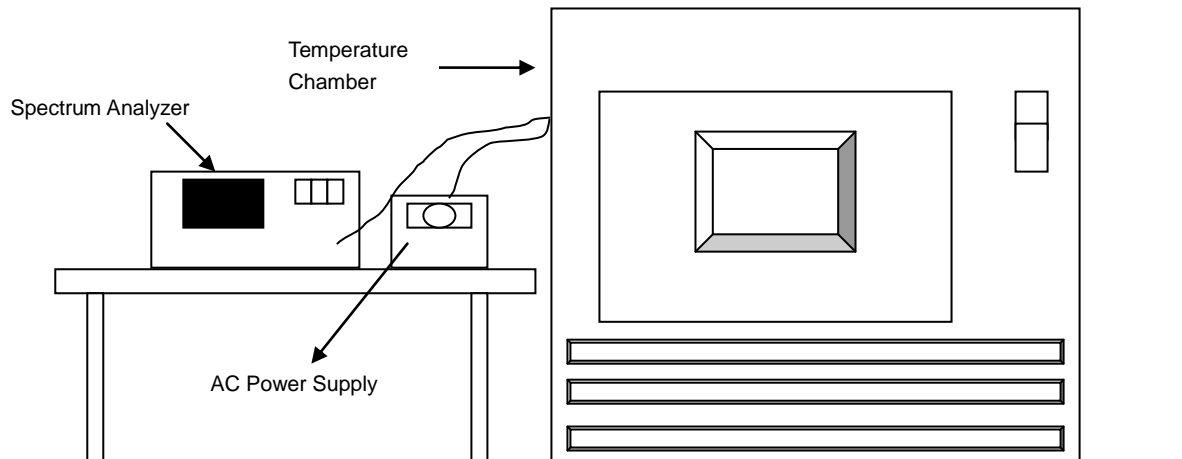

### 4.6.3 Test Instruments

Refer to section 4.1.2 to get information of above instrument.

### 4.6.4 Test Procedure

- The EUT was placed inside the environmental test chamber and powered by nominal AC voltage.
- Turn the EUT on and couple its output to a spectrum analyzer.
- Turn the EUT off and set the chamber to the highest temperature specified.
- Allow sufficient time (approximately 30 min) for the temperature of the chamber to stabilize, turn the EUT on and measure the operating frequency after 2, 5, and 10 Minutes.
- Repeat step 2 and 3 with the temperature chamber set to the lowest temperature.
- The test chamber was allowed to stabilize at +20 degree C for a minimum of 30 Minutes. The supply voltage was then adjusted on the EUT from 85% to 115% and the frequency record.

### 4.6.5 Deviation from Test Standard

No deviation.

### 4.6.6 EUT Operating Condition

Set the EUT transmit at un-modulation mode to test frequency stability.

## 4.6.7 Test Results (Mode 1)

Frequency Stability Versus Temp.									
Operating Frequency: 5260 MHz									
TEMP. (°C)	Power Supply (Vac)	0 Minute		2 Minute		5 Minute		10 Minute	
		Measured Frequency (MHz)	Pass/Fail	Measured Frequency (MHz)	Pass/Fail	Measured Frequency (MHz)	Pass/Fail	Measured Frequency (MHz)	Pass/Fail
50	120	5259.9782	PASS	5259.9764	PASS	5259.9768	PASS	5259.9788	PASS
40	120	5260.0038	PASS	5260.0002	PASS	5259.9989	PASS	5260.0014	PASS
30	120	5259.98	PASS	5259.9762	PASS	5259.9768	PASS	5259.9767	PASS
20	120	5260.021	PASS	5260.0227	PASS	5260.0196	PASS	5260.0199	PASS
10	120	5260.0138	PASS	5260.0168	PASS	5260.016	PASS	5260.0128	PASS
0	120	5259.9776	PASS	5259.9761	PASS	5259.9759	PASS	5259.9743	PASS
-10	120	5260.0069	PASS	5260.0093	PASS	5260.0093	PASS	5260.0097	PASS
-20	120	5260.0154	PASS	5260.0148	PASS	5260.0169	PASS	5260.0173	PASS
-30	120	5260.0087	PASS	5260.0045	PASS	5260.0043	PASS	5260.005	PASS

Frequency Stability Versus Voltage									
Operating Frequency: 5260 MHz									
TEMP. (°C)	Power Supply (Vac)	0 Minute		2 Minute		5 Minute		10 Minute	
		Measured Frequency (MHz)	Pass/Fail	Measured Frequency (MHz)	Pass/Fail	Measured Frequency (MHz)	Pass/Fail	Measured Frequency (MHz)	Pass/Fail
20	138	5260.0215	Pass	5260.0226	Pass	5260.0188	Pass	5260.02	Pass
	120	5260.021	Pass	5260.0227	Pass	5260.0196	Pass	5260.0199	Pass
	102	5260.0217	Pass	5260.0229	Pass	5260.0206	Pass	5260.0198	Pass

## 4.7 6dB Bandwidth Measurement

### 4.7.1 Limits of 6dB Bandwidth Measurement

The minimum of 6dB Bandwidth Measurement is 0.5MHz.

### 4.7.2 Test Setup

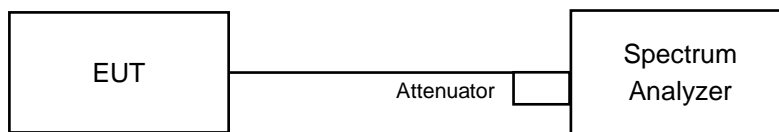

### 4.7.3 Test Instruments

Refer to section 4.1.2 to get information of above instrument.

### 4.7.4 Test Procedure

#### MEASUREMENT PROCEDURE REF

- Set resolution bandwidth (RBW) = 100kHz
- Set the video bandwidth (VBW)  $\geq 3 \times$  RBW, Detector = Peak.
- Trace mode = max hold.
- Sweep = auto couple.
- Measure the maximum width of the emission that is constrained by the frequencies associated with the two amplitude points (upper and lower) that are attenuated by 6 dB relative to the maximum level measured in the fundamental emission

### 4.7.5 Deviation from Test Standard

No deviation.

### 4.7.6 EUT Operating Condition

The software provided by client to enable the EUT under transmission condition continuously at lowest, middle and highest channel frequencies individually.

#### 4.7.7 Test Results (Mode 1)

##### 802.11a

Channel	Frequency (MHz)	6dB Bandwidth (MHz)				Minimum Limit (MHz)	Pass / Fail
		Chain 0	Chain 1	Chain 2	Chain 3		
144 (UNII-3 Band)	5720	3.15	3.17	3.17	3.18	0.5	Pass

Note: The 6dB bandwidth above 5725MHz = Marker 1 + Delta 2 - 5725MHz

##### 802.11ac (VHT20)

Channel	Frequency (MHz)	6dB Bandwidth (MHz)				Minimum Limit (MHz)	Pass / Fail
		Chain 0	Chain 1	Chain 2	Chain 3		
144 (UNII-3 Band)	5720	3.76	3.75	3.75	3.80	0.5	Pass

Note: The 6dB bandwidth above 5725MHz = Marker 1 + Delta 2 - 5725MHz

##### 802.11ac (VHT40)

Channel	Frequency (MHz)	6dB Bandwidth (MHz)				Minimum Limit (MHz)	Pass / Fail
		Chain 0	Chain 1	Chain 2	Chain 3		
142 (UNII-3 Band)	5710	2.55	2.54	2.63	2.59	0.5	Pass

Note: The 6dB bandwidth above 5725MHz = Marker 1 + Delta 2 - 5725MHz

##### 802.11ac (VHT80)

Channel	Frequency (MHz)	6dB Bandwidth (MHz)				Minimum Limit (MHz)	Pass / Fail
		Chain 0	Chain 1	Chain 2	Chain 3		
138 (UNII-3 Band)	5690	3.22	2.78	3.22	2.79	0.5	Pass

Note: The 6dB bandwidth above 5725MHz = Marker 1 + Delta 2 - 5725MHz

**802.11ac (VHT80+80)**

Channel	Frequency (MHz)	6dB Bandwidth (MHz)				Minimum Limit (MHz)	Pass / Fail
		Chain 0	Chain 1	Chain 2	Chain 3		
138 (UNII-2C) +138 (UNII-3) +155	5690	-					
	5690	2.96	2.79	-	-	0.5	Pass
	5775	-	-	74.25	75.93	0.5	Pass
42+ 138 (UNII-2C) +138 (UNII-3)	5210	-					
	5690	-					
	5690	-	-	2.74	2.74	0.5	Pass
58+ 138 (UNII-2C) +138 (UNII-3)	5290	-					
	5690	-					
	5690	-	-	2.74	2.74	0.5	Pass
58+155	5290	-					
	5775	-	-	74.25	75.93	0.5	Pass
106+155	5530	-					
	5775	-	-	74.25	75.93	0.5	Pass
122+155	5610	-					
	5775	-	-	74.25	75.93	0.5	Pass
106+ 138 (UNII-2C) +138 (UNII-3)	5530	-					
	5690	-					
	5690	-	-	2.74	2.74	0.5	Pass

Note: The 6dB bandwidth above 5725MHz = Marker 1 + Delta 2 - 5725MHz



Spectrum Plot of Worst Value

802.11a / Chain 0 - CH144 (UNII-3 Band)

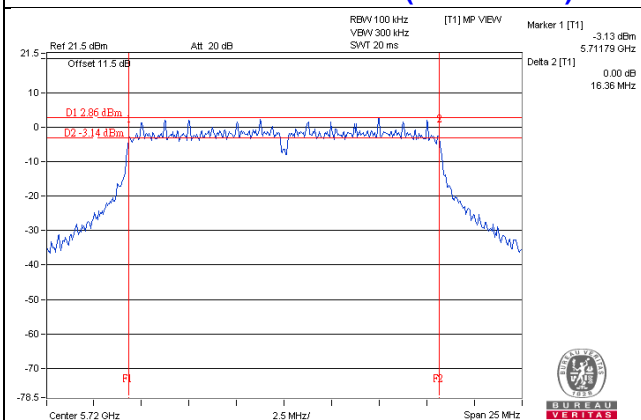

802.11ac (VHT20) / Chain 1 - CH144 (UNII-3 Band)

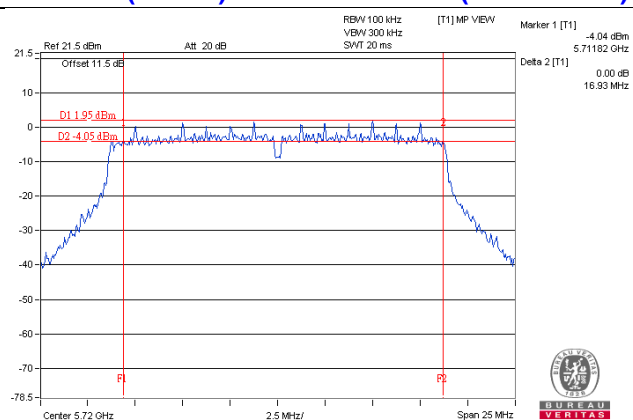

802.11ac (VHT40) / Chain 1 - CH142 (UNII-3 Band)

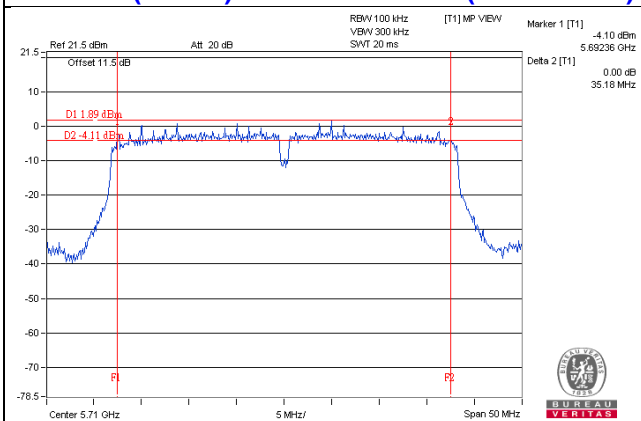

802.11ac (VHT80) / Chain 1 - CH138 (UNII-3 Band)

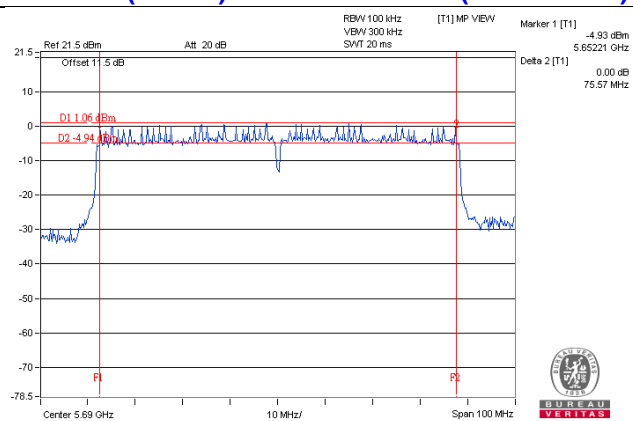

802.11ac (VHT80+80) / Chain 2 - CH138 (UNII-3 Band)

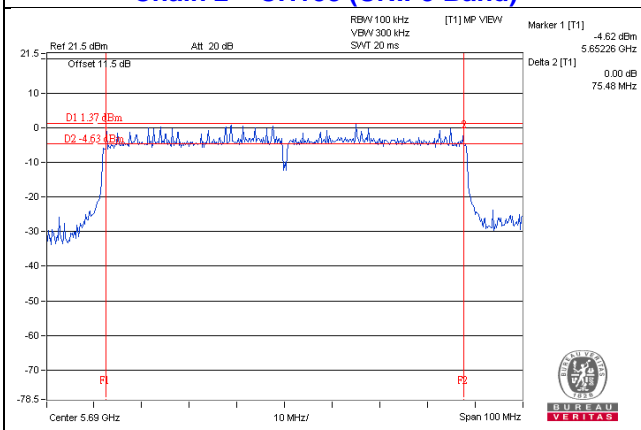

#### 4.7.8 Test Results (Mode 2)

##### 802.11a

Channel	Frequency (MHz)	6dB Bandwidth (MHz)			Minimum Limit (MHz)	Pass / Fail
		Chain 0	Chain 1	Chain 2		
144 (UNII-3 Band)	5720	3.17	3.16	3.18	0.5	Pass

Note: The 6dB bandwidth above 5725MHz = Marker 1 + Delta 2 - 5725MHz

##### 802.11ac (VHT20)

Channel	Frequency (MHz)	6dB Bandwidth (MHz)			Minimum Limit (MHz)	Pass / Fail
		Chain 0	Chain 1	Chain 2		
144 (UNII-3 Band)	5720	3.80	3.79	3.80	0.5	Pass

Note: The 6dB bandwidth above 5725MHz = Marker 1 + Delta 2 - 5725MHz

##### 802.11ac (VHT40)

Channel	Frequency (MHz)	6dB Bandwidth (MHz)			Minimum Limit (MHz)	Pass / Fail
		Chain 0	Chain 1	Chain 2		
142 (UNII-3 Band)	5710	2.60	2.67	2.57	0.5	Pass

Note: The 6dB bandwidth above 5725MHz = Marker 1 + Delta 2 - 5725MHz

##### 802.11ac (VHT80)

Channel	Frequency (MHz)	6dB Bandwidth (MHz)			Minimum Limit (MHz)	Pass / Fail
		Chain 0	Chain 1	Chain 2		
138 (UNII-3 Band)	5690	3.20	3.25	3.20	0.5	Pass

Note: The 6dB bandwidth above 5725MHz = Marker 1 + Delta 2 - 5725MHz

### Spectrum Plot of Worst Value

#### 802.11a\_Chain 1 / CH144 (UNII-3 Band)

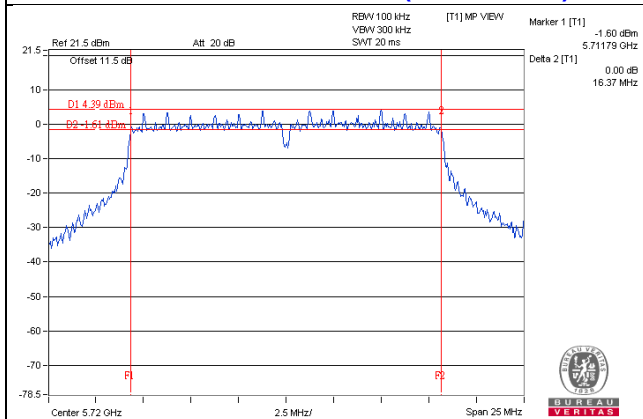

#### 802.11ac (VHT20)\_Chain 1 / CH144 (UNII-3 Band)

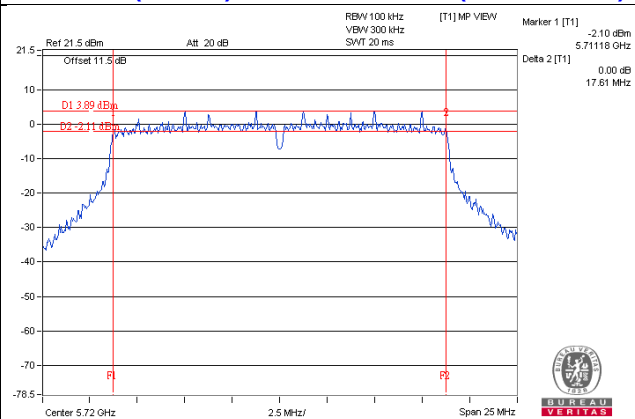

#### 802.11ac (VHT40)\_Chain 2 / CH142 (UNII-3 Band)

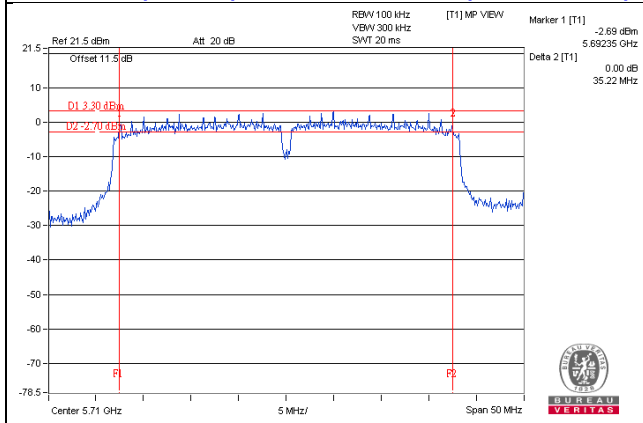

#### 802.11ac (VHT80)\_Chain 0 / CH138 (UNII-3 Band)

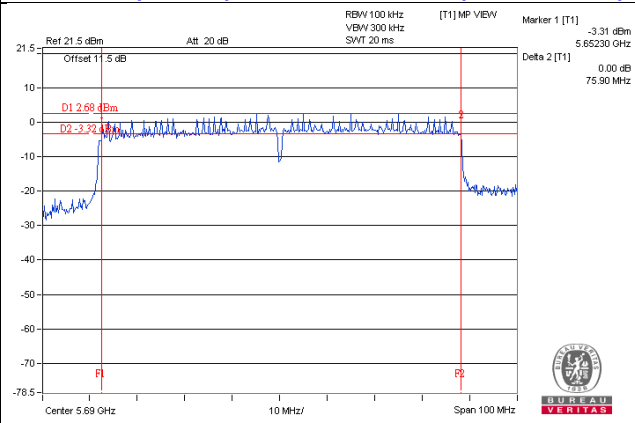

#### 4.7.9 Test Results (Mode 3)

##### 802.11a

Channel	Frequency (MHz)	6dB Bandwidth (MHz)		Minimum Limit (MHz)	Pass / Fail
		Chain 0	Chain 1		
144 (UNII-3 Band)	5720	3.17	3.17	0.5	Pass

Note: The 6dB bandwidth above 5725MHz = Marker 1 + Delta 2 - 5725MHz

##### 802.11ac (VHT20)

Channel	Frequency (MHz)	6dB Bandwidth (MHz)		Minimum Limit (MHz)	Pass / Fail
		Chain 0	Chain 1		
144 (UNII-3 Band)	5720	3.80	3.79	0.5	Pass

Note: The 6dB bandwidth above 5725MHz = Marker 1 + Delta 2 - 5725MHz

##### 802.11ac (VHT40)

Channel	Frequency (MHz)	6dB Bandwidth (MHz)		Minimum Limit (MHz)	Pass / Fail
		Chain 0	Chain 1		
142 (UNII-3 Band)	5710	2.64	2.54	0.5	Pass

Note: The 6dB bandwidth above 5725MHz = Marker 1 + Delta 2 - 5725MHz

##### 802.11ac (VHT80)

Channel	Frequency (MHz)	6dB Bandwidth (MHz)		Minimum Limit (MHz)	Pass / Fail
		Chain 0	Chain 1		
138 (UNII-3 Band)	5690	2.75	3.09	0.5	Pass

Note: The 6dB bandwidth above 5725MHz = Marker 1 + Delta 2 - 5725MHz

**802.11ac (VHT80+80)**

Channel	Frequency (MHz)	6dB Bandwidth (MHz)		Minimum Limit (MHz)	Pass / Fail
		Chain 0	Chain 2		
138 (UNII-2C) +138 (UNII-3) +155	5690	-			
	5690	2.68	-	0.5	Pass
	5775	-	73.02	0.5	Pass
42+ 138 (UNII-2C) +138 (UNII-3)	5210	-			
	5690	-			
	5690	-	2.76	0.5	Pass
58+ 138 (UNII-2C) +138 (UNII-3)	5290	-			
	5690	-			
	5690	-	2.76	0.5	Pass
58+155	5290	-			
	5775	-	73.02	0.5	Pass
106+155	5530	-			
	5775	-	73.02	0.5	Pass
122+155	5610	-			
	5775	-	73.02	0.5	Pass
106+ 138 (UNII-2C) +138 (UNII-3)	5530	-			
	5690	-			
	5690	-	2.76	0.5	Pass

Note: The 6dB bandwidth above 5725MHz = Marker 1 + Delta 2 - 5725MHz

**Spectrum Plot of Worst Value**

**802.11a / Chain 0 - CH144 (UNII-3 Band)**

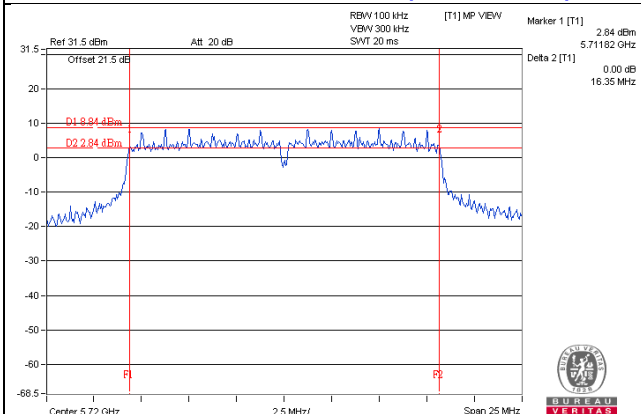

**802.11ac (VHT20) / Chain 1 - CH144 (UNII-3 Band)**

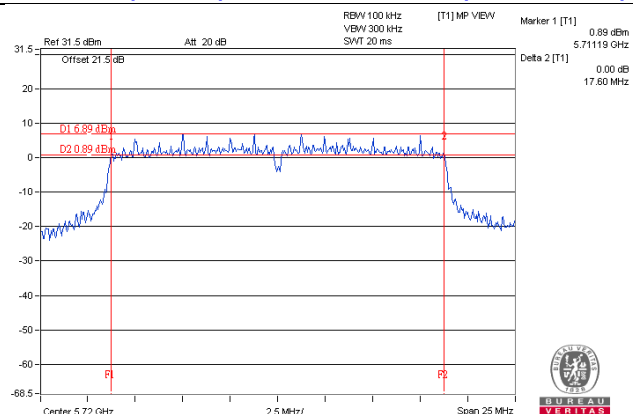

**802.11ac (VHT40) / Chain 1 - CH142 (UNII-3 Band)**

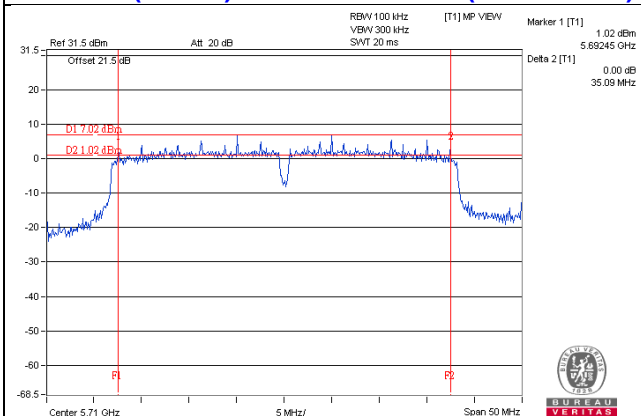

**802.11ac (VHT80) / Chain 0 - CH138 (UNII-3 Band)**

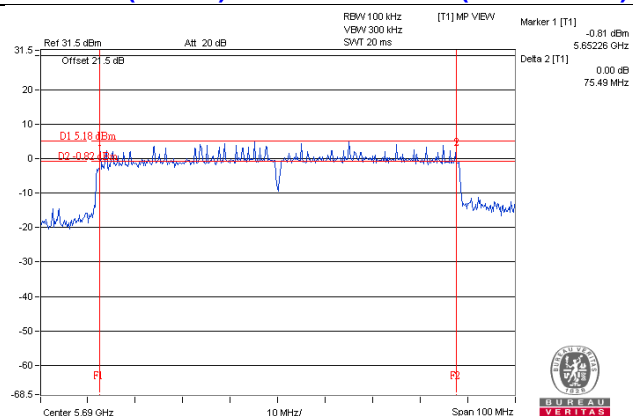

**802.11ac (VHT80+80) / Chain 0 - CH138 (UNII-3 Band)**

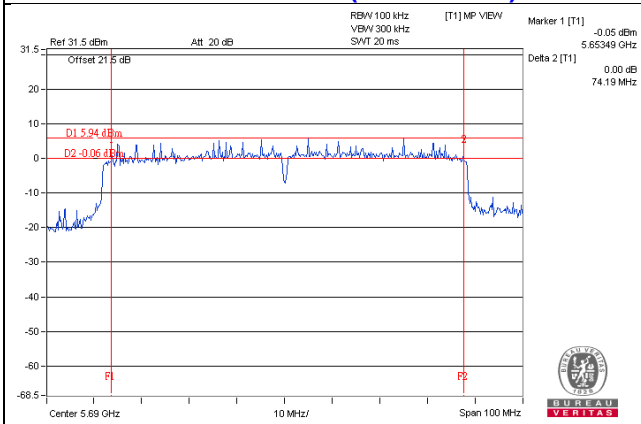

#### 4.7.10 Test Results (Mode 4)

##### 802.11a

Channel	Frequency (MHz)	6dB Bandwidth (MHz)	Minimum Limit (MHz)	Pass / Fail
144 (UNII-3 Band)	5720	3.17	0.5	PASS

Note: The 6dB bandwidth above 5725MHz = Marker 1 + Delta 2 - 5725MHz

##### 802.11ac (VHT20)

Channel	Frequency (MHz)	6dB Bandwidth (MHz)	Minimum Limit (MHz)	Pass / Fail
144 (UNII-3 Band)	5720	3.78	0.5	PASS

Note: The 6dB bandwidth above 5725MHz = Marker 1 + Delta 2 - 5725MHz

##### 802.11ac (VHT40)

Channel	Frequency (MHz)	6dB Bandwidth (MHz)	Minimum Limit (MHz)	Pass / Fail
142 (UNII-3 Band)	5710	1.51	0.5	PASS

Note: The 6dB bandwidth above 5725MHz = Marker 1 + Delta 2 - 5725MHz

##### 802.11ac (VHT80)

Channel	Frequency (MHz)	6dB Bandwidth (MHz)	Minimum Limit (MHz)	Pass / Fail
138 (UNII-3 Band)	5690	3.20	0.5	PASS

Note: The 6dB bandwidth above 5725MHz = Marker 1 + Delta 2 - 5725MHz

Spectrum Plot of Worst Value

802.11a / CH144 (UNII-3 Band)

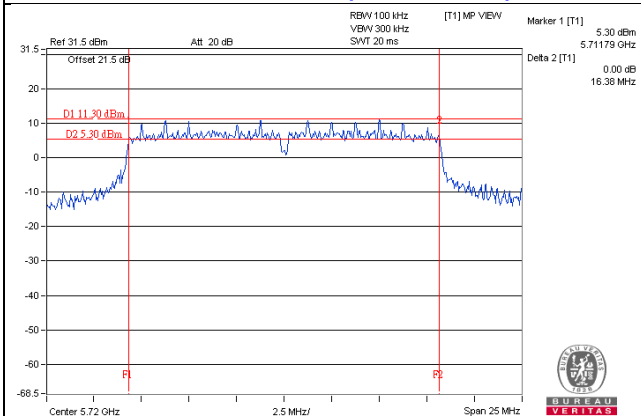

802.11ac (VHT20) / CH144 (UNII-3 Band)

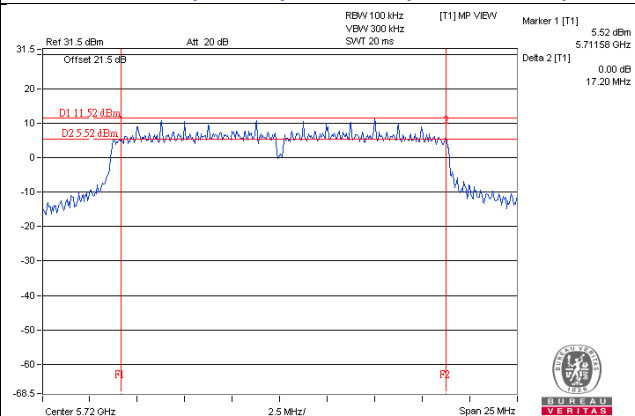

802.11ac (VHT40) / CH142 (UNII-3 Band)

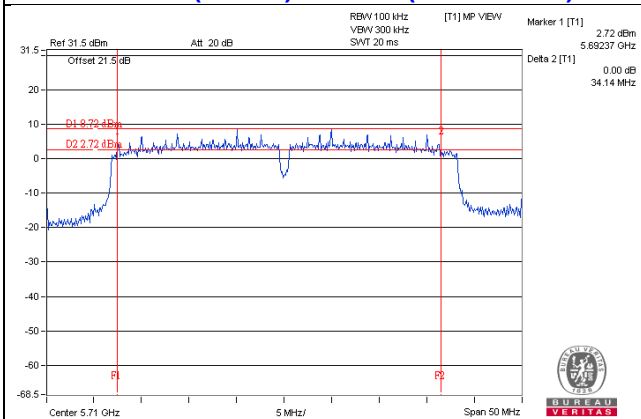

802.11ac (VHT80) / CH138 (UNII-3 Band)

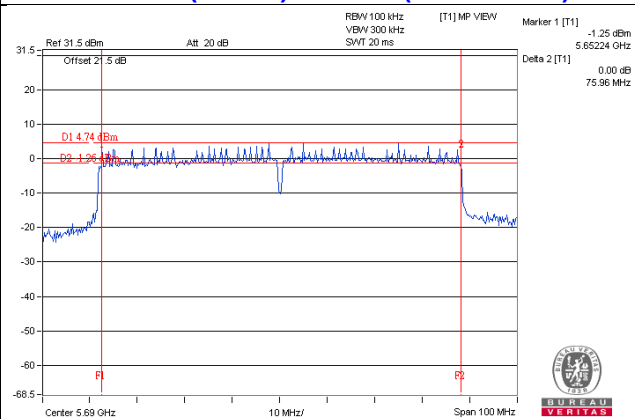



## 5 Pictures of Test Arrangements

Please refer to the attached file (Test Setup Photo).

## Appendix – Information on the Testing Laboratories

We, Bureau Veritas Consumer Products Services (H.K.) Ltd., Taoyuan Branch, were founded in 1988 to provide our best service in EMC, Radio, Telecom and Safety consultation. Our laboratories are accredited and approved according to ISO/IEC 17025.

If you have any comments, please feel free to contact us at the following:

**Linko EMC/RF Lab**

Tel: 886-2-26052180

Fax: 886-2-26051924

**Hsin Chu EMC/RF/Telecom Lab**

Tel: 886-3-6668565

Fax: 886-3-6668323

**Hwa Ya EMC/RF/Safety Lab**

Tel: 886-3-3183232

Fax: 886-3-3270892

**Email:** [service.adt@tw.bureauveritas.com](mailto:service.adt@tw.bureauveritas.com)

**Web Site:** [www.bureauveritas-adt.com](http://www.bureauveritas-adt.com)

The address and road map of all our labs can be found in our web site also.

--- END ---