

FCC Test Report (WLAN)

Report No.: RF170421E06-1

FCC ID: 2ACTO-APX740

Test Model: APX 740

Received Date: Apr. 21, 2017

Test Date: May 05 to June 09, 2017

Issued Date: July 31, 2017

Applicant: Sophos Ltd

Address: The Pentagon, Abingdon Science Park, Abingdon, OX14 3YP, United Kingdom

Issued By: Bureau Veritas Consumer Products Services (H.K.) Ltd., Taoyuan Branch
Hsin Chu Laboratory

Lab Address: E-2, No.1, Li Hsin 1st Road, Hsinchu Science Park, Hsinchu City 300,
Taiwan R.O.C.

Test Location (1): E-2, No.1, Li Hsin 1st Road, Hsinchu Science Park, Hsinchu City 300,
Taiwan R.O.C.

Test Location (2): No. 49, Ln. 206, Wende Rd., Shangshan Tsuen, Chiung Lin Hsiang, Hsin
Chu Hsien 307, Taiwan R.O.C.



This report is for your exclusive use. Any copying or replication of this report to or for any other person or entity, or use of our name or trademark, is permitted only with our prior written permission. This report sets forth our findings solely with respect to the test samples identified herein. The results set forth in this report are not indicative or representative of the quality or characteristics of the lot from which a test sample was taken or any similar or identical product unless specifically and expressly noted. Our report includes all of the tests requested by you and the results thereof based upon the information that you provided to us. You have 60 days from date of issuance of this report to notify us of any material error or omission caused by our negligence, provided, however, that such notice shall be in writing and shall specifically address the issue you wish to raise. A failure to raise such issue within the prescribed time shall constitute your unqualified acceptance of the completeness of this report, the tests conducted and the correctness of the report contents. Unless specific mention, the uncertainty of measurement has been explicitly taken into account to declare the compliance or non-compliance to the specification. The report must not be used by the client to claim product certification, approval, or endorsement by TAF or any government agencies.

Table of Contents

Release Control Record	4
1 Certificate of Conformity	5
2 Summary of Test Results	6
2.1 Measurement Uncertainty	6
2.2 Modification Record	6
3 General Information	7
3.1 General Description of EUT	7
3.2 Description of Test Modes	10
3.2.1 Test Mode Applicability and Tested Channel Detail	11
3.3 Duty Cycle of Test Signal	14
3.4 Description of Support Units	15
3.4.1 Configuration of System under Test	16
3.5 General Description of Applied Standard	18
4 Test Types and Results	19
4.1 Radiated Emission and Bandedge Measurement	19
4.1.1 Limits of Radiated Emission and Bandedge Measurement	19
4.1.2 Test Instruments	20
4.1.3 Test Procedure	22
4.1.4 Deviation from Test Standard	22
4.1.5 Test Setup	23
4.1.6 EUT Operating Condition	24
4.1.7 Test Results (Mode 1)	25
4.1.8 Test Results (Mode 2)	45
4.1.9 Test Results (Mode 3)	63
4.1.10 Test Results (Mode 4)	83
4.2 Conducted Emission Measurement	101
4.2.1 Limits of Conducted Emission Measurement	101
4.2.2 Test Instruments	101
4.2.3 Test Procedure	102
4.2.4 Deviation from Test Standard	102
4.2.5 Test Setup	102
4.2.6 EUT Operating Condition	102
4.2.7 Test Results (Mode 1)	103
4.3 Transmit Power Measurement	105
4.3.1 Limits of Transmit Power Measurement	105
4.3.2 Test Setup	105
4.3.3 Test Instruments	105
4.3.4 Test Procedure	105
4.3.5 Deviation from Test Standard	105
4.3.6 EUT Operating Condition	105
4.3.7 Test Result (Mode 1)	106
4.3.8 Test Result (Mode 2)	110
4.3.9 Test Result (Mode 3)	113
4.3.10 Test Result (Mode 4)	116
4.4 Occupied Bandwidth Measurement	117
4.4.1 Test Setup	117
4.4.2 Test Instruments	117
4.4.3 Test Procedure	117
4.4.4 Test Results (Mode 1)	118
4.4.5 Test Results (Mode 2)	126
4.4.6 Test Results (Mode 3)	132
4.4.7 Test Results (Mode 4)	139
4.5 Peak Power Spectral Density Measurement	143

4.5.1	Limits of Peak Power Spectral Density Measurement	143
4.5.2	Test Setup.....	143
4.5.3	Test Instruments	143
4.5.4	Test Procedure	144
4.5.5	Deviation from Test Standard	144
4.5.6	EUT Operating Condition	144
4.5.7	Test Results (Mode 1).....	145
4.5.8	Test Results (Mode 2).....	153
4.5.9	Test Results (Mode 3).....	159
4.5.10	Test Results (Mode 4).....	165
4.6	Frequency Stability Measurement.....	169
4.6.1	Limits of Frequency Stability Measurement	169
4.6.2	Test Setup.....	169
4.6.3	Test Instruments	169
4.6.4	Test Procedure	169
4.6.5	Deviation from Test Standard	169
4.6.6	EUT Operating Condition	169
4.6.7	Test Results (Mode 1).....	170
4.7	6dB Bandwidth Measurement.....	171
4.7.1	Limits of 6dB Bandwidth Measurement.....	171
4.7.2	Test Setup.....	171
4.7.3	Test Instruments	171
4.7.4	Test Procedure	171
4.7.5	Deviation from Test Standard	171
4.7.6	EUT Operating Condition	171
4.7.7	Test Results (Mode 1).....	172
4.7.8	Test Results (Mode 2).....	174
4.7.9	Test Results (Mode 3).....	176
4.7.10	Test Results (Mode 4).....	178
5	Pictures of Test Arrangements.....	180
	Annex A- Radiated Out of Band Emission (OOBE) Measurement (For U-NII-3 band).....	181
	Appendix – Information on the Testing Laboratories	195

Release Control Record

Issue No.	Description	Date Issued
RF170421E06-1	Original release.	July 31, 2017

1 Certificate of Conformity

Product: Sophos Access Point
Brand: SOPHOS
Test Model: APX 740
Sample Status: ENGINEERING SAMPLE
Applicant: Sophos Ltd
Test Date: May 05 to June 09, 2017
Standard: 47 CFR FCC Part 15, Subpart E (Section 15.407)
ANSI C63.10: 2013

The above equipment has been tested by **Bureau Veritas Consumer Products Services (H.K.) Ltd., Taoyuan Branch**, and found compliance with the requirement of the above standards. The test record, data evaluation & Equipment Under Test (EUT) configurations represented herein are true and accurate accounts of the measurements of the sample's EMC characteristics under the conditions specified in this report.

Prepared by : Wendy Wu , **Date:** July 31, 2017
Wendy Wu / Specialist

Approved by : May Chen , **Date:** July 31, 2017
May Chen / Manager

2 Summary of Test Results

47 CFR FCC Part 15, Subpart E (Section 15.407)			
FCC Clause	Test Item	Result	Remarks
15.407(b)(6)	AC Power Conducted Emissions	Pass	Meet the requirement of limit. Minimum passing margin is -7.97dB at 0.42331MHz.
15.407(b) (1/2/3/4(i/ii)/6)	Radiated Emissions & Band Edge Measurement*	Pass	Meet the requirement of limit. Minimum passing margin is -0.1dB at 5142.50MHz, 5150.00MHz.
15.407(a)(1/2/3)	Max Average Transmit Power	Pass	Meet the requirement of limit.
---	Occupied Bandwidth Measurement	-	Reference only.
15.407(a)(1/2/3)	Peak Power Spectral Density	Pass	Meet the requirement of limit.
15.407(e)	6dB bandwidth	Pass	Meet the requirement of limit. (U-NII-3 Band only)
15.407(g)	Frequency Stability	Pass	Meet the requirement of limit.
15.203	Antenna Requirement	Pass	Antenna connector is i-pex(MHF) not a standard connector.

*For U-NII-3 band compliance with rule part 15.407(b)(4)(i), the OOB test plots were recorded in Annex A.

2.1 Measurement Uncertainty

Where relevant, the following measurement uncertainty levels have been estimated for tests performed on the EUT as specified in CISPR 16-4-2:

Measurement	Frequency	Expanded Uncertainty (k=2) (±)
Conducted Emissions at mains ports	150kHz ~ 30MHz	1.84 dB
Radiated Emissions up to 1 GHz	30MHz ~ 1GHz	5.32 dB
Radiated Emissions above 1 GHz	1GHz ~ 6GHz	5.14 dB
	6GHz ~ 18GHz	5.04 dB
	18GHz ~ 40GHz	5.25 dB

2.2 Modification Record

There were no modifications required for compliance.

3 General Information

3.1 General Description of EUT

Product	Sophos Access Point
Brand	SOPHOS
Test Model	APX 740
Status of EUT	ENGINEERING SAMPLE
Power Supply Rating	DC 55V from POE
Modulation Type	CCK, DQPSK, DBPSK for DSSS 64QAM, 16QAM, QPSK, BPSK for OFDM 256QAM for OFDM in 11ac mode only
Modulation Technology	DSSS, OFDM
Transfer Rate	802.11b: up to 11Mbps 802.11a/g: up to 54Mbps 802.11n: up to 600Mbps 802.11ac: up to 1733.3Mbps 802.11ac (80+80): up to 3466.7Mbps
Operating Frequency	2.4GHz: 2.412 ~ 2.462GHz 5GHz: 5.18~ 5.24GHz, 5.745 ~ 5.825GHz
Number of Channel	2.4GHz: 802.11b, 802.11g, 802.11n (HT20): 11 802.11n (HT40): 7 5GHz: 802.11a, 802.11n (HT20), 802.11ac (VHT20): 9 802.11n (HT40), 802.11ac (VHT40): 4 802.11ac (VHT80): 2 802.11ac (VHT80+80): 1 set
Output Power	2.4GHz: CDD Mode: 4TX: 859.613mW (29.34dBm) 3TX: 656.377mW (28.17dBm) 2TX: 626.119mW (27.97dBm) 1TX: 320.627mW (25.06dBm) Beamforming Mode: 4TX: 314.533mW (24.98dBm) 3TX: 395.055mW (25.97dBm) 2TX: 483.741mW (26.85dBm) 5GHz: CDD Mode: 5.18 ~ 5.24GHz: 4TX: 410.091mW (26.13dBm) 3TX: 344.784mW (25.38dBm) 2TX: 387.301mW (25.88dBm) 1TX: 191.867mW (22.83dBm) 5.745 ~ 5.825GHz: 4TX: 759.756mW (28.81dBm) 3TX: 564.772mW (27.52dBm) 2TX: 353.936mW (25.49dBm) 1TX: 169.434mW (22.29dBm) Beamforming Mode: 5.18 ~ 5.24GHz: 4TX: 268.681mW (24.29dBm) 3TX: 343.787mW (25.36dBm) 2TX: 370.282mW (25.69dBm) 5.745 ~ 5.825GHz: 4TX: 263.781mW (24.21dBm) 3TX: 340.814mW (25.33dBm) 2TX: 353.936mW (25.49dBm)

Antenna Type	Refer to Note
Antenna Connector	Refer to Note
Accessory Device	NA
Data Cable Supplied	NA

Note:

- The EUT has three radio transceivers, radio 1 is WLAN technologies for single band (2.4GHz), radio 2 is WLAN technology for single band (5GHz), and radio 3 is Bluetooth low energy (BT-LE) technology only.
- Simultaneously transmission condition.

Condition	Technology	
1	WLAN 2.4GHz (Radio 1)	WLAN 5GHz (Radio 2)

Note: The emission of the simultaneous operation has been evaluated and no non-compliance was found.

- The EUT must be supplied with a POE (only for test not for sale) as following table:

Brand	Model No.	Spec.
PowerDsine	PD-9001GR/AC	Input: 100-240Vac, 50/60Hz, 0.67A Output: 55Vdc, 0.6A

- The antennas provided to the EUT, please refer to the following table:

Radio 1								
2.4GHz								
Antenna No.	Transmitter Circuit	Brand	Model No.	Antenna Net Gain (dBi)	Frequency Range (GHz)	Antenna Type	Connector Type	*Cable Length
1	Chain (0)	NA	NA	4.99	2.4~2.4835	PIFA	i-pex(MHF)	176
2	Chain (1)	NA	NA	4.47	2.4~2.4835	PIFA	i-pex(MHF)	140
3	Chain (2)	NA	NA	3.71	2.4~2.4835	PIFA	i-pex(MHF)	98
4	Chain (3)	NA	NA	4.83	2.4~2.4835	PIFA	i-pex(MHF)	70
Radio 2								
5GHz								
Antenna No.	Transmitter Circuit	Brand	Model No.	Antenna Net Gain (dBi)	Frequency Range (GHz)	Antenna Type	Connector Type	*Cable Length
1	Chain (0)	NA	NA	5.94	5.15~5.85	Dipole	i-pex(MHF)	79
2	Chain (1)	NA	NA	5.71	5.15~5.85	Dipole	i-pex(MHF)	117
3	Chain (2)	NA	NA	5.61	5.15~5.85	Dipole	i-pex(MHF)	157
4	Chain (3)	NA	NA	5.32	5.15~5.85	Dipole	i-pex(MHF)	189
Radio 3								
Bluetooth								
Antenna No.	Transmitter Circuit	Brand	Model No.	Antenna Net Gain (dBi)	Frequency Range (GHz)	Antenna Type	Connector Type	*Cable Length
1	Chain (0)	NA	NA	2.75	2.4~2.4835	PIFA	i-pex(MHF)	121

Note:

- For 1TX configuration mode, max gain was selected for the final test.
- For 2TX configuration mode, Ant 1 & Ant 2 were selected for the final test.
- For 3TX configuration mode, Ant 1, Ant 2 & Ant 3 were selected for the final test.

5. The EUT incorporates a MIMO function:

2.4GHz Band			
MODULATION MODE	DATA RATE (MCS)	TX & RX CONFIGURATION	
802.11b	1 ~ 11Mbps	4TX/3TX/2TX/1TX diversity	4Rx
802.11g	6 ~ 54Mbps	4TX/3TX/2TX/1TX diversity	4Rx
802.11n (HT20)	MCS 0~7	4TX/3TX/2TX/1TX diversity	4Rx
	MCS 8~15	4TX/3TX/2TX	4Rx
	MCS 16~23	4TX/3TX	4Rx
	MCS 24~31	4TX	4Rx
802.11n (HT40)	MCS 0~7	4TX/3TX/2TX/1TX diversity	4Rx
	MCS 8~15	4TX/3TX/2TX	4Rx
	MCS 16~23	4TX/3TX	4Rx
	MCS 24~31	4TX	4Rx
5GHz Band			
MODULATION MODE	DATA RATE (MCS)	TX & RX CONFIGURATION	
802.11a	6 ~ 54Mbps	4TX/3TX/2TX/1TX diversity	4RX
802.11n (HT20)	MCS 0~7	4TX/3TX/2TX/1TX diversity	4RX
	MCS 8~15	4TX/3TX/2TX	4RX
	MCS 16~23	4TX/3TX	4RX
	MCS 24~31	4TX	4RX
802.11n (HT40)	MCS 0~7	4TX/3TX/2TX/1TX diversity	4RX
	MCS 8~15	4TX/3TX/2TX	4RX
	MCS 16~23	4TX/3TX	4RX
	MCS 24~31	4TX	4RX
802.11ac (VHT20)	MCS 0~8, Nss=1	4TX/3TX/2TX/1TX diversity	4RX
	MCS 0~8, Nss=2	4TX/3TX/2TX	4RX
	MCS 0~9, Nss=3	4TX/3TX	4RX
	MCS 0~8, Nss=4	4TX	4RX
802.11ac (VHT40)	MCS 0~9, Nss=1	4TX/3TX/2TX/1TX diversity	4RX
	MCS 0~9, Nss=2	4TX/3TX/2TX	4RX
	MCS 0~9, Nss=3	4TX/3TX	4RX
	MCS 0~9, Nss=4	4TX	4RX
802.11ac (VHT80)	MCS 0~9, Nss=1	4TX/3TX/2TX/1TX diversity	4RX
	MCS 0~9, Nss=2	4TX/3TX/2TX	4RX
	MCS 0~9, Nss=3	4TX/3TX	4RX
	MCS 0~9, Nss=4	4TX	4RX
802.11ac (VHT80+VHT80)	MCS 0~9, Nss=2	4TX/2TX	4RX
	MCS 0~9, Nss=4	4TX	4RX

Note:

1. All of modulation mode support beamforming function except 802.11a/b/g modulation mode.
2. The EUT support Beamforming and CDD mode, therefore both mode were investigated and the worst case scenario was identified. The worst case data were presented in test report.
3. The modulation and bandwidth are similar for 802.11n mode for 20MHz (40MHz) and 802.11ac mode for 20MHz (40MHz), therefore investigated worst case to representative mode in test report. (Final test mode refer section 3.2.1)

6. The above EUT information is declared by manufacturer and for more detailed features description, please refer to the manufacturer's specifications or user's manual.

3.2 Description of Test Modes

FOR 5180 ~ 5240MHz

4 channels are provided for 802.11a, 802.11n (HT20), 802.11ac (VHT20):

Channel	Frequency	Channel	Frequency
36	5180 MHz	44	5220 MHz
40	5200 MHz	48	5240 MHz

2 channels are provided for 802.11n (HT40), 802.11ac (VHT40):

Channel	Frequency	Channel	Frequency
38	5190 MHz	46	5230 MHz

1 channel is provided for 802.11ac (VHT80):

Channel	Frequency
42	5210MHz

FOR 5745 ~ 5825MHz:

5 channels are provided for 802.11a, 802.11n (HT20), 802.11ac (VHT20):

Channel	Frequency	Channel	Frequency
149	5745MHz	161	5805MHz
153	5765MHz	165	5825MHz
157	5785MHz		

2 channels are provided for 802.11n (HT40), 802.11ac (VHT40):

Channel	Frequency	Channel	Frequency
151	5755MHz	159	5795MHz

1 channel is provided for 802.11ac (VHT80):

Channel	Frequency
155	5775MHz

For simultaneous transmission:

1 set is provided for 802.11ac (VHT80+80):

Channel	Frequency
42+155	5210MHz + 5775MHz

Note: The transmission is for noncontiguous transmission using two nonadjacent 80MHz channels.

3.2.1 Test Mode Applicability and Tested Channel Detail

EUT Configure Mode	Applicable To				Description
	RE \geq 1G	RE $<$ 1G	PLC	APCM	
1	√	√	√	√	4TX Mode
2	√	-	-	√	3TX Mode
3	√	-	-	√	2TX Mode
4	√	-	-	√	1TX Mode

Where **RE \geq 1G**: Radiated Emission above 1GHz **RE $<$ 1G**: Radiated Emission below 1GHz
PLC: Power Line Conducted Emission **APCM**: Antenna Port Conducted Measurement

NOTE:

1. The EUT had been pre-tested on the positioned of each 3 axis. The worst case was found when positioned on **X-plane**.
2. "-" means no effect.

Radiated Emission Test (Above 1GHz):

- Pre-Scan has been conducted to determine the worst-case mode from all possible combinations between available modulations, data rates and antenna ports (if EUT with antenna diversity architecture).
- Following channel(s) was (were) selected for the final test as listed below.

CDD Mode						
Mode	FREQ. Band (MHz)	Available Channel	Tested Channel	Modulation Technology	Modulation Type	Data Rate (Mbps)
802.11a	5180-5240	36 to 48	36, 40, 48	OFDM	BPSK	6
802.11ac (VHT20)		36 to 48	36, 40, 48	OFDM	BPSK	6.5
802.11ac (VHT40)		38 to 46	38, 46	OFDM	BPSK	13.5
802.11ac (VHT80)		42	42	OFDM	BPSK	29.3
802.11a	5745-5825	149 to 165	149, 157, 165	OFDM	BPSK	6
802.11ac (VHT20)		149 to 165	149, 157, 165	OFDM	BPSK	6.5
802.11ac (VHT40)		151 to 159	151, 159	OFDM	BPSK	13.5
802.11ac (VHT80)		155	155	OFDM	BPSK	29.3
802.11ac (VHT80+80)	5180-5240 5745-5825	42 to 155	42 + 155	OFDM	BPSK	58.5

Radiated Emission Test (Below 1GHz):

- Pre-Scan has been conducted to determine the worst-case mode from all possible combinations between available modulations, data rates and antenna ports (if EUT with antenna diversity architecture).
- Following channel(s) was (were) selected for the final test as listed below.

CDD Mode						
Mode	FREQ. Band (MHz)	Available Channel	Tested Channel	Modulation Technology	Modulation Type	Data Rate (Mbps)
802.11a	5180-5240 5745-5825	36 to 48 149 to 165	165	OFDM	BPSK	6

Power Line Conducted Emission Test:

- Pre-Scan has been conducted to determine the worst-case mode from all possible combinations between available modulations, data rates and antenna ports (if EUT with antenna diversity architecture).
- Following channel(s) was (were) selected for the final test as listed below.

CDD Mode						
Mode	FREQ. Band (MHz)	Available Channel	Tested Channel	Modulation Technology	Modulation Type	Data Rate (Mbps)
802.11a	5180-5240 5745-5825	36 to 48 149 to 165	165	OFDM	BPSK	6

Antenna Port Conducted Measurement:

- This item includes all test value of each mode, but only includes spectrum plot of worst value of each mode.
- Pre-Scan has been conducted to determine the worst-case mode from all possible combinations between available modulations, data rates and antenna ports (if EUT with antenna diversity architecture).
- Following channel(s) was (were) selected for the final test as listed below.

CDD Mode						
Mode	FREQ. Band (MHz)	Available Channel	Tested Channel	Modulation Technology	Modulation Type	Data Rate (Mbps)
802.11a	5180-5240	36 to 48	36, 40, 48	OFDM	BPSK	6
802.11ac (VHT20)		36 to 48	36, 40, 48	OFDM	BPSK	6.5
802.11ac (VHT40)		38 to 46	38, 46	OFDM	BPSK	13.5
802.11ac (VHT80)		42	42	OFDM	BPSK	29.3
802.11a	5745-5825	149 to 165	149, 157, 165	OFDM	BPSK	6
802.11ac (VHT20)		149 to 165	149, 157, 165	OFDM	BPSK	6.5
802.11ac (VHT40)		151 to 159	151, 159	OFDM	BPSK	13.5
802.11ac (VHT80)		155	155	OFDM	BPSK	29.3
802.11ac (VHT80+80)	5180-5240 5745-5825	42, 155	42 + 155	OFDM	BPSK	58.5
Beamforming Mode (output power only & occupied bandwidth)						
Mode	FREQ. Band (MHz)	Available Channel	Tested Channel	Modulation Technology	Modulation Type	Data Rate (Mbps)
802.11ac (VHT20)	5180-5240	36 to 48	36, 40, 48	OFDM	BPSK	6.5
802.11ac (VHT40)		38 to 46	38, 46	OFDM	BPSK	13.5
802.11ac (VHT80)		42	42	OFDM	BPSK	29.3
802.11ac (VHT20)	5745-5825	149 to 165	149, 157, 165	OFDM	BPSK	6.5
802.11ac (VHT40)		151 to 159	151, 159	OFDM	BPSK	13.5
802.11ac (VHT80)		155	155	OFDM	BPSK	29.3
802.11ac (VHT80+80)	5180-5240 5745-5825	42, 155	42 + 155	OFDM	BPSK	58.5

Test Condition:

Applicable To	Environmental Conditions	Input Power	Tested By
RE \geq 1G	22deg. C, 68%RH	120Vac, 60Hz	Rey Chen
RE<1G	25deg. C, 71%RH	120Vac, 60Hz	Andy Ho
PLC	25deg. C, 75%RH	120Vac, 60Hz	Andy Ho
APCM	25deg. C, 60%RH	120Vac, 60Hz	Anderson Chen

3.3 Duty Cycle of Test Signal

If duty cycle of test signal is $\geq 98\%$, duty factor is not required.

If duty cycle of test signal is $< 98\%$, duty factor shall be considered.

802.11a: Duty cycle = $2.027 \text{ ms} / 2.089 \text{ ms} = 0.97$, Duty factor = $10 * \log(1/0.97) = 0.13$

802.11ac (VHT20): Duty cycle = $4.97 \text{ ms} / 5.031 \text{ ms} = 0.988$

802.11ac (VHT40): Duty cycle = $2.415 \text{ ms} / 2.479 \text{ ms} = 0.974$, Duty factor = $10 * \log(1/0.974) = 0.11$

802.11ac (VHT80): Duty cycle = $1.135 \text{ ms} / 1.199 \text{ ms} = 0.947$, Duty factor = $10 * \log(1/0.947) = 0.24$

802.11ac (VHT80+80): Duty cycle = $1.135 / 1.199 = 0.947$, Duty factor = $10 * \log(1/0.947) = 0.24$

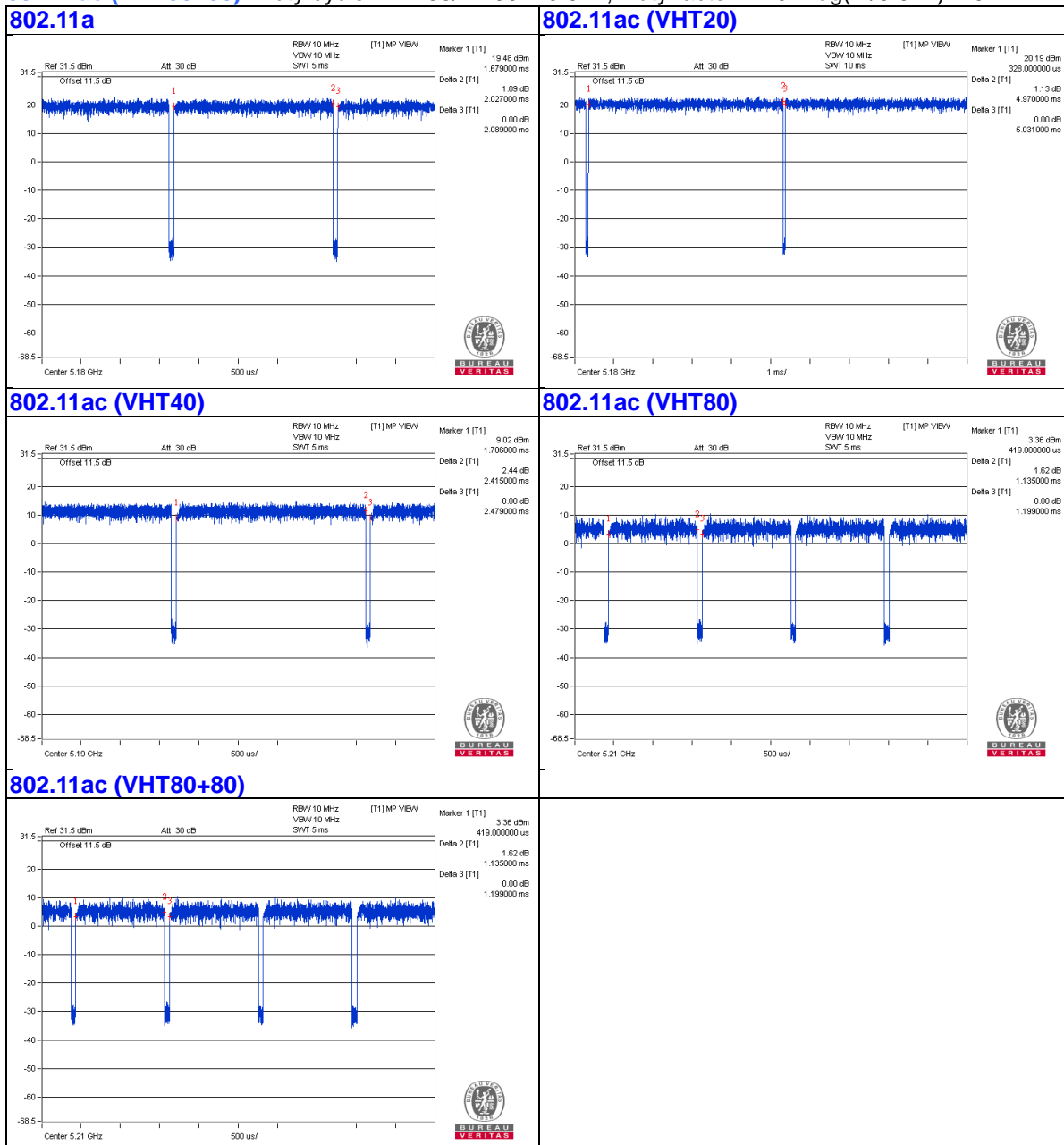

3.4 Description of Support Units

The EUT has been tested as an independent unit together with other necessary accessories or support units. The following support units or accessories were used to form a representative test configuration during the tests.

ID	Product	Brand	Model No.	Serial No.	FCC ID	Remarks
A.	Laptop	DELL	E5430	HYV4VY1	FCC DoC	Provided by Lab
B.	POE	PowerDsine	PD-9001GR/AC	NA	NA	Supplied by client
C.	Laptop	LENOVO	E440	PF071LWC	NA	Provided by Lab

Note:

1. All power cords of the above support units are non-shielded (1.8m).

ID	Descriptions	Qty.	Length (m)	Shielding (Yes/No)	Cores (Qty.)	Remarks
1.	RJ-45 Cable	1	10	No	0	Provided by Lab
2.	RJ-45 Cable	1	10	No	0	Provided by Lab
3.	RJ-45 Cable	1	3	No	0	Provided by Lab
4.	Console Cable	1	1.5	No	0	Provided by Lab

3.4.1 Configuration of System under Test

For Conducted Emission:

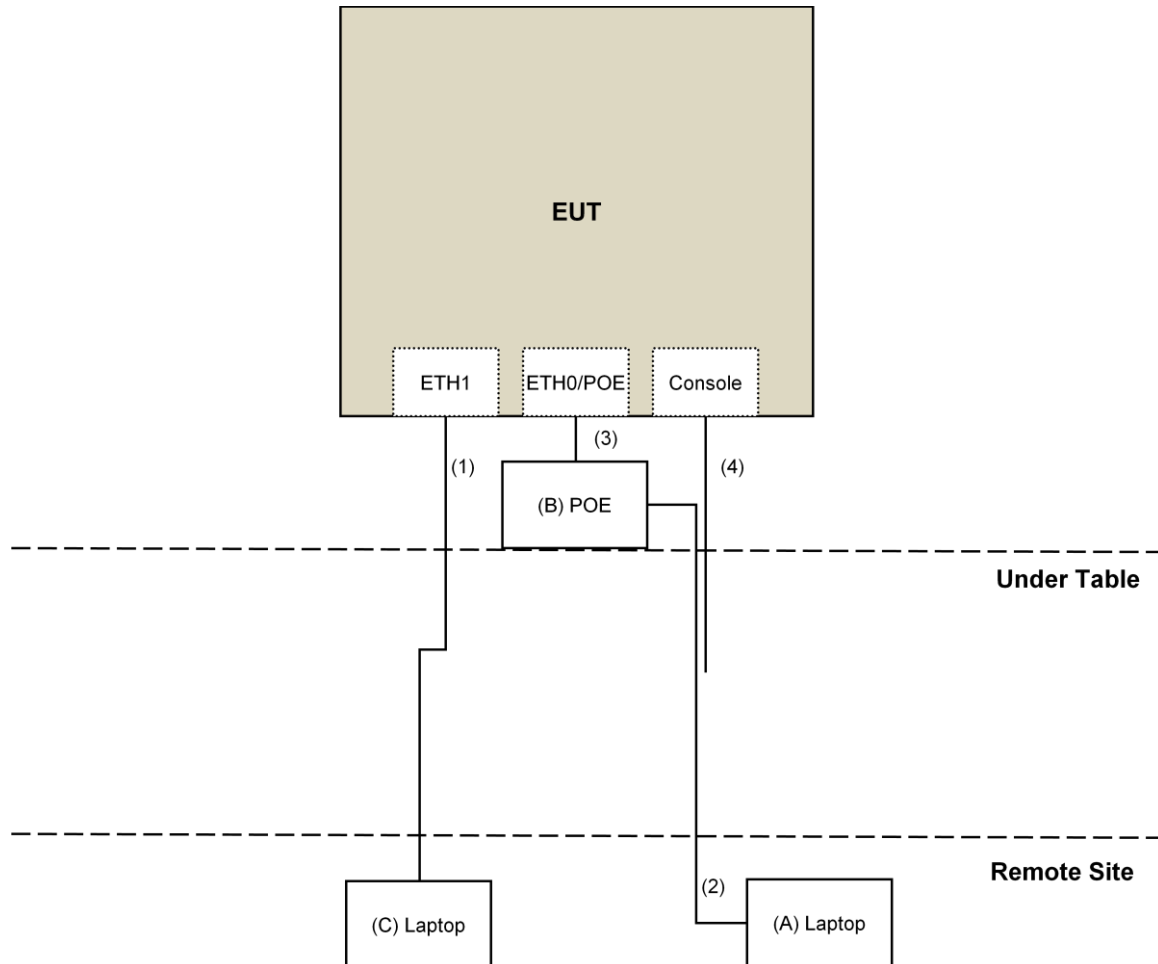

For other test:

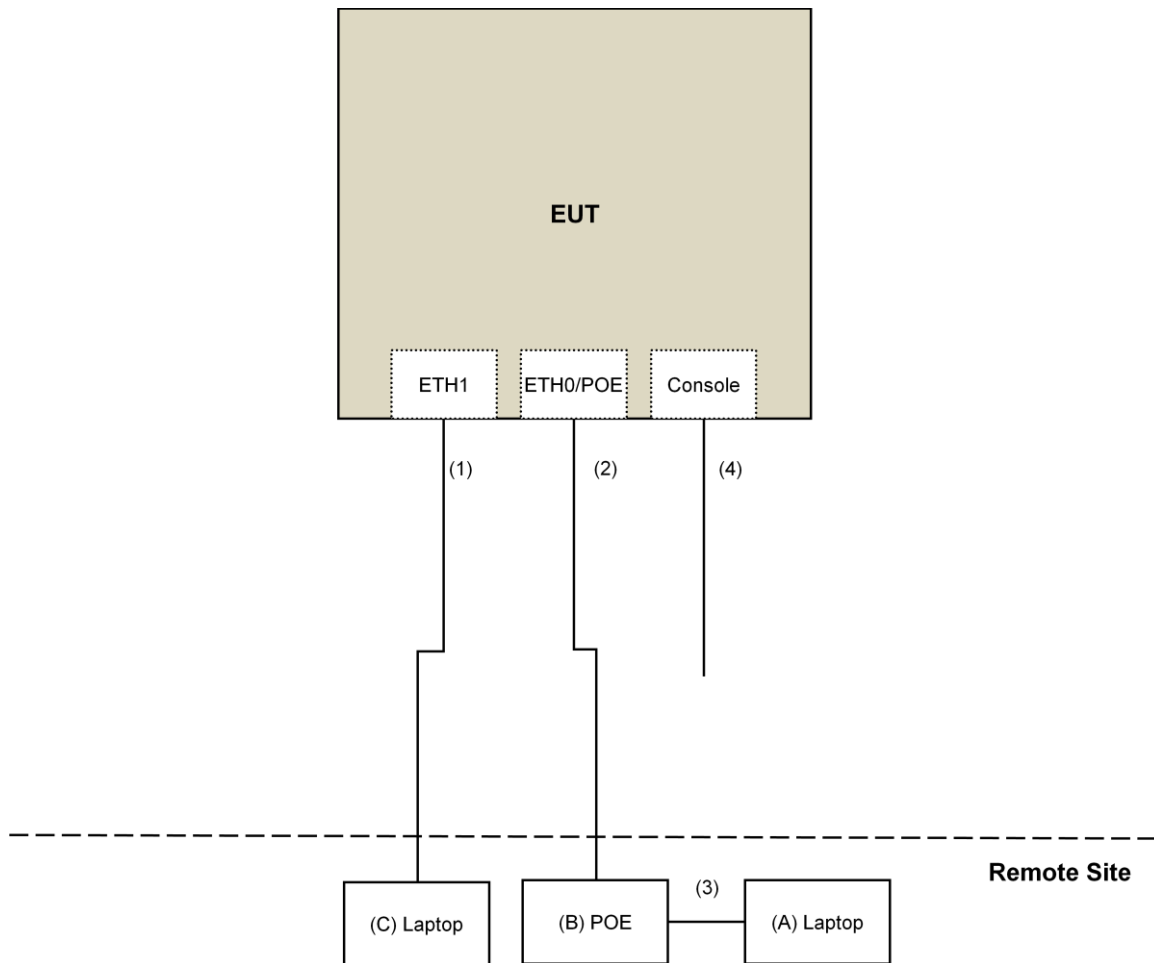

3.5 General Description of Applied Standard

The EUT is a RF Product. According to the specifications of the manufacturer, it must comply with the requirements of the following standards:

FCC Part 15, Subpart E (15.407)
KDB 789033 D02 General UNII Test Procedure New Rules v01r04
KDB 662911 D01 Multiple Transmitter Output v02r01
KDB 644545 D03 Guidance for IEEE 802.11ac New Rules v01
ANSI C63.10-2013

All test items have been performed and recorded as per the above standards.

NOTE: The EUT has been verified to comply with the requirements of FCC Part 15, Subpart B, Class B (DoC). The test report has been issued separately.

4 Test Types and Results

4.1 Radiated Emission and Bandedge Measurement

4.1.1 Limits of Radiated Emission and Bandedge Measurement

Radiated emissions which fall in the restricted bands must comply with the radiated emission limits specified as below table.

Frequencies (MHz)	Field Strength (microvolts/meter)	Measurement Distance (meters)
0.009 ~ 0.490	2400/F(kHz)	300
0.490 ~ 1.705	24000/F(kHz)	30
1.705 ~ 30.0	30	30
30 ~ 88	100	3
88 ~ 216	150	3
216 ~ 960	200	3
Above 960	500	3

NOTE:

1. The lower limit shall apply at the transition frequencies.
2. Emission level (dBuV/m) = 20 log Emission level (uV/m).
3. For frequencies above 1000MHz, the field strength limits are based on average detector, however, the peak field strength of any emission shall not exceed the maximum permitted average limits, specified above by more than 20dB under any condition of modulation.

Limits of unwanted emission out of the restricted bands

Applicable To		Limit	
789033 D02 General UNII Test Procedure New Rules v01r04		Field Strength at 3m	
		PK:74 (dBµV/m)	AV:54 (dBµV/m)
Frequency Band	Applicable To	EIRP Limit	Equivalent Field Strength at 3m
5150~5250 MHz	15.407(b)(1)	PK:-27 (dBm/MHz)	PK:68.2(dBµV/m)
5250~5350 MHz	15.407(b)(2)		
5470~5725 MHz	15.407(b)(3)		
5725~5850 MHz	<input checked="" type="checkbox"/> 15.407(b)(4)(i)	PK:-27 (dBm/MHz) ^{*1} PK:10 (dBm/MHz) ^{*2} PK:15.6 (dBm/MHz) ^{*3} PK:27 (dBm/MHz) ^{*4}	PK: 68.2(dBµV/m) ^{*1} PK:105.2 (dBµV/m) ^{*2} PK: 110.8(dBµV/m) ^{*3} PK:122.2 (dBµV/m) ^{*4}
	<input type="checkbox"/> 15.407(b)(4)(ii)	Emission limits in section 15.247(d)	
^{*1} beyond 75 MHz or more above of the band edge.		^{*2} below the band edge increasing linearly to 10 dBm/MHz at 25 MHz above.	
^{*3} below the band edge increasing linearly to a level of 15.6 dBm/MHz at 5 MHz above.		^{*4} from 5 MHz above or below the band edge increasing linearly to a level of 27 dBm/MHz at the band edge.	

Note:

The following formula is used to convert the equipment isotropic radiated power (eirp) to field strength:

$$E = \frac{1000000\sqrt{30P}}{3} \mu\text{V/m, where P is the eirp (Watts).}$$

4.1.2 Test Instruments

For below 1GHz test:

DESCRIPTION & MANUFACTURER	MODEL NO.	SERIAL NO.	CALIBRATED DATE	CALIBRATED UNTIL
Test Receiver Agilent	N9038A	MY50010156	Aug. 18, 2016	Aug. 17, 2017
Pre-Amplifier ^(*) EMCI	EMC001340	980142	Jan. 20, 2016	Jan. 19, 2018
Loop Antenna ^(*) Electro-Metrics	EM-6879	264	Dec. 16, 2016	Dec. 15, 2018
RF Cable	NA	LOOPCAB-001 LOOPCAB-002	Jan. 17, 2017	Jan. 16, 2018
Pre-Amplifier Mini-Circuits	ZFL-1000VH2 B	AMP-ZFL-05	May 07, 2016	May 06, 2017
Trilog Broadband Antenna SCHWARZBECK	VULB 9168	9168-361	Dec. 29, 2016	Dec. 28, 2017
RF Cable	8D	966-3-1 966-3-2 966-3-3	Apr. 01, 2017	Mar. 31, 2018
Fixed attenuator Mini-Circuits	UNAT-5+	PAD-3m-3-01	Oct. 05, 2016	Oct. 04, 2017
Software	ADT_Radiated _V8.7.08	NA	NA	NA
Antenna Tower & Turn Table Max-Full	MF-7802	MF780208406	NA	NA

Note:

1. The calibration interval of the above test instruments is 12 months and the calibrations are traceable to NML/ROC and NIST/USA.
2. *The calibration interval of the above test instruments is 24 months and the calibrations are traceable to NML/ROC and NIST/USA.
3. The test was performed in 966 Chamber No. 3.
4. The FCC Site Registration No. is 147459
5. The CANADA Site Registration No. is 20331-1
6. Loop antenna was used for all emissions below 30 MHz.
7. Tested Date: May 05, 2017

For other test:

DESCRIPTION & MANUFACTURER	MODEL NO.	SERIAL NO.	CALIBRATED DATE	CALIBRATED UNTIL
Test Receiver Agilent	N9038A	MY50010156	Aug. 18, 2016	Aug. 17, 2017
Horn_Antenna SCHWARZBECK	BBHA9120-D	9120D-406	Dec. 28, 2016	Dec. 27, 2017
Pre-Amplifier EMCI	EMC12630SE	980384	Feb. 02, 2017	Feb. 01, 2018
RF Cable	EMC104-SM-SM-1200 EMC104-SM-SM-2000 EMC104-SM-SM-5000	160922 150317 150322	Feb. 02, 2017 Mar. 29, 2017 Mar. 29, 2017	Feb. 01, 2018 Mar. 28, 2018 Mar. 28, 2018
Spectrum Analyzer Keysight	N9030A	MY54490520	July 29, 2016	July 28, 2017
Pre-Amplifier EMCI	EMC184045S E	980386	Feb. 02, 2017	Feb. 01, 2018
Horn_Antenna SCHWARZBECK	BBHA 9170	BBHA9170608	Dec. 15, 2016	Dec. 14, 2017
RF Cable	SUCOFLEX 102	36432/2 36433/2	Jan. 15, 2017	Jan. 14, 2018
Software	ADT_Radiated _V8.7.08	NA	NA	NA
Antenna Tower & Turn Table Max-Full	MF-7802	MF780208406	NA	NA
Boresight Antenna Fixture	FBA-01	FBA-SIP01	NA	NA
Spectrum Analyzer R&S	FSv40	100964	June 28, 2016	June 27, 2017
Power meter Anritsu	ML2495A	1014008	May 11, 2017	May 10, 2018
Power sensor Anritsu	MA2411B	0917122	May 11, 2017	May 10, 2018
Temperature & Humidity Chamber Giant Force	GTH-150-40-S P-AR	MAA0812-008	Jan. 11, 2017	Jan. 10, 2018
DC Power Supply Topward	6603D	795558	NA	NA
Digital Multimeter FLUKE	87III	73680266	Nov. 10, 2016	Nov. 09, 2017

Note:

1. The calibration interval of the above test instruments is 12 months and the calibrations are traceable to NML/ROC and NIST/USA.
2. The test was performed in 966 Chamber No. 3.
3. The FCC Site Registration No. is 147459
4. The CANADA Site Registration No. is 20331-1
5. Tested Date: May 12 to June 09, 2017

4.1.3 Test Procedure

For Radiated emission below 30MHz

- a. The EUT was placed on the top of a rotating table 0.8 meters above the ground at a 3 meter chamber room. The table was rotated 360 degrees to determine the position of the highest radiation.
- b. The EUT was set 3 meters away from the interference-receiving antenna, which was mounted on the top of a variable-height antenna tower.
- c. Both X and Y axes of the antenna are set to make the measurement.
- d. For each suspected emission, the EUT was arranged to its worst case and the rotatable table was turned from 0 degrees to 360 degrees to find the maximum reading.
- e. The test-receiver system was set to Quasi-Peak Detect Function and Specified Bandwidth with Maximum Hold Mode.

NOTE:

1. The resolution bandwidth and video bandwidth of test receiver/spectrum analyzer is 9kHz at frequency below 30MHz.

For Radiated emission above 30MHz

- a. The EUT was placed on the top of a rotating table 0.8 meters (for 30MHz ~ 1GHz) / 1.5 meters (for above 1GHz) above the ground at 3 meter chamber room for test. The table was rotated 360 degrees to determine the position of the highest radiation.
- b. The EUT was set 3 meters away from the interference-receiving antenna, which was mounted on the top of a variable-height antenna tower.
- c. The height of antenna is varied from one meter to four meters above the ground to determine the maximum value of the field strength. Both horizontal and vertical polarizations of the antenna are set to make the measurement.
- d. For each suspected emission, the EUT was arranged to its worst case and then the antenna was tuned to heights from 1 meter to 4 meters and the rotatable table was turned from 0 degrees to 360 degrees to find the maximum reading.
- e. The test-receiver system was set to quasi-peak detect function and specified bandwidth with maximum hold mode when the test frequency is below 1 GHz.
- f. The test-receiver system was set to peak and average detect function and specified bandwidth with maximum hold mode when the test frequency is above 1 GHz. If the peak reading value also meets average limit, measurement with the average detector is unnecessary.

Note:

1. The resolution bandwidth and video bandwidth of test receiver/spectrum analyzer is 120kHz for Quasi-peak detection (QP) at frequency below 1GHz.
2. The resolution bandwidth of test receiver/spectrum analyzer is 1 MHz and the video bandwidth is 3 MHz for Peak detection (PK) at frequency above 1GHz.
3. The resolution bandwidth of test receiver/spectrum analyzer is 1MHz and the video bandwidth is $\geq 1/T$ (Duty cycle < 98%) or 10Hz (Duty cycle $\geq 98\%$) for Average detection (AV) at frequency above 1GHz.
4. All modes of operation were investigated and the worst-case emissions are reported.

4.1.4 Deviation from Test Standard

No deviation.

4.1.5 Test Setup

For Radiated emission below 30MHz

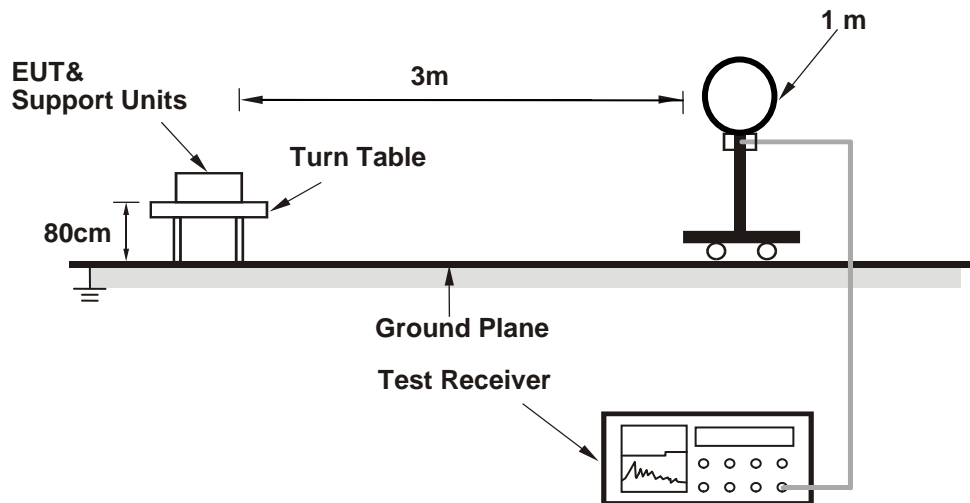

For Radiated emission 30MHz to 1GHz

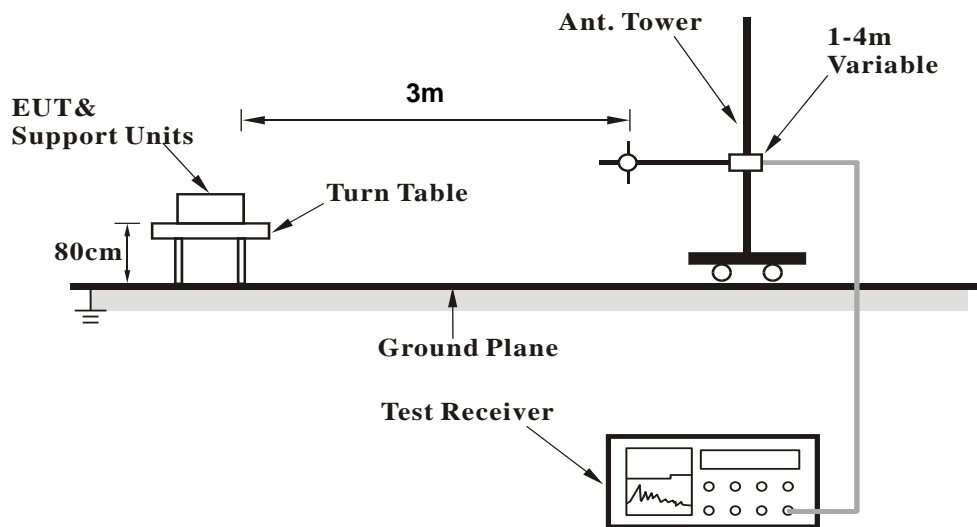

For Radiated emission above 1GHz

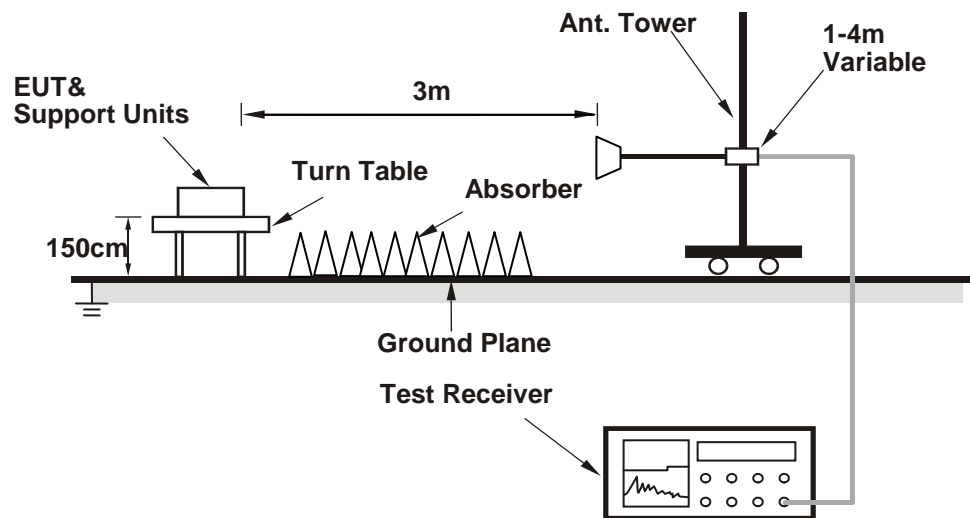

For the actual test configuration, please refer to the attached file (Test Setup Photo).

4.1.6 EUT Operating Condition

- a. Connected the EUT with the Laptop which is placed on remote site.
- b. Controlling software (QDART-QCARCT [Ver3.0.197.0]) has been activated to set the EUT on specific status.

4.1.7 Test Results (Mode 1)

Above 1GHz Data:

802.11a

CHANNEL	TX Channel 36	DETECTOR FUNCTION	Peak (PK)
FREQUENCY RANGE	1GHz ~ 40GHz		Average (AV)

ANTENNA POLARITY & TEST DISTANCE: HORIZONTAL AT 3 M

NO.	FREQ. (MHz)	EMISSION LEVEL (dBuV/m)	LIMIT (dBuV/m)	MARGIN (dB)	ANTENNA HEIGHT (m)	TABLE ANGLE (Degree)	RAW VALUE (dBuV)	CORRECTION FACTOR (dB/m)
1	5148.10	65.2 PK	74.0	-8.8	2.90 H	106	61.6	3.6
2	5148.10	52.8 AV	54.0	-1.2	2.90 H	106	49.2	3.6
3	*5180.00	119.2 PK			2.90 H	106	115.5	3.7
4	*5180.00	109.0 AV			2.90 H	106	105.3	3.7
5	#10360.00	49.4 PK	74.0	-24.6	1.69 H	74	36.4	13.0
6	#10360.00	37.5 AV	54.0	-16.5	1.69 H	74	24.5	13.0
7	15540.00	53.5 PK	74.0	-20.5	2.09 H	95	40.4	13.1
8	15540.00	39.7 AV	54.0	-14.3	2.09 H	95	26.6	13.1

ANTENNA POLARITY & TEST DISTANCE: VERTICAL AT 3 M

NO.	FREQ. (MHz)	EMISSION LEVEL (dBuV/m)	LIMIT (dBuV/m)	MARGIN (dB)	ANTENNA HEIGHT (m)	TABLE ANGLE (Degree)	RAW VALUE (dBuV)	CORRECTION FACTOR (dB/m)
1	5148.10	50.5 PK	74.0	-23.5	1.50 V	146	46.9	3.6
2	5148.10	39.3 AV	54.0	-14.7	1.50 V	146	35.7	3.6
3	*5180.00	104.5 PK			1.50 V	146	100.8	3.7
4	*5180.00	93.2 AV			1.50 V	146	89.5	3.7
5	#10360.00	49.0 PK	74.0	-25.0	2.16 V	144	36.0	13.0
6	#10360.00	36.5 AV	54.0	-17.5	2.16 V	144	23.5	13.0
7	15540.00	53.2 PK	74.0	-20.8	3.14 V	88	40.1	13.1
8	15540.00	39.8 AV	54.0	-14.2	3.14 V	88	26.7	13.1

REMARKS:

1. Emission Level(dBuV/m) = Raw Value(dBuV) + Correction Factor(dB/m)
2. Correction Factor(dB/m) = Antenna Factor(dB/m) + Cable Factor(dB) – Pre-Amplifier Factor(dB)
3. The other emission levels were very low against the limit.
4. Margin value = Emission Level – Limit value
5. " * ": Fundamental frequency.
6. " # ": The radiated frequency is out of the restricted band.

CHANNEL	TX Channel 40	DETECTOR FUNCTION	Peak (PK)
FREQUENCY RANGE	1GHz ~ 40GHz		Average (AV)

ANTENNA POLARITY & TEST DISTANCE: HORIZONTAL AT 3 M

NO.	FREQ. (MHz)	EMISSION LEVEL (dBuV/m)	LIMIT (dBuV/m)	MARGIN (dB)	ANTENNA HEIGHT (m)	TABLE ANGLE (Degree)	RAW VALUE (dBuV)	CORRECTION FACTOR (dB/m)
1	5148.00	66.7 PK	74.0	-7.3	3.55 H	109	63.1	3.6
2	5148.00	50.6 AV	54.0	-3.4	3.55 H	109	47.0	3.6
3	*5200.00	120.4 PK			3.55 H	109	116.7	3.7
4	*5200.00	110.3 AV			3.55 H	109	106.6	3.7
5	#10400.00	49.4 PK	74.0	-24.6	1.69 H	74	36.4	13.0
6	#10400.00	37.5 AV	54.0	-16.5	1.69 H	74	24.5	13.0
7	15600.00	53.6 PK	74.0	-20.4	2.09 H	95	40.3	13.3
8	15600.00	40.2 AV	54.0	-13.8	2.09 H	95	26.9	13.3

ANTENNA POLARITY & TEST DISTANCE: VERTICAL AT 3 M

NO.	FREQ. (MHz)	EMISSION LEVEL (dBuV/m)	LIMIT (dBuV/m)	MARGIN (dB)	ANTENNA HEIGHT (m)	TABLE ANGLE (Degree)	RAW VALUE (dBuV)	CORRECTION FACTOR (dB/m)
1	5148.00	52.0 PK	74.0	-22.0	1.51 V	161	48.4	3.6
2	5148.00	37.5 AV	54.0	-16.5	1.51 V	161	33.9	3.6
3	*5200.00	101.3 PK			1.51 V	161	97.6	3.7
4	*5200.00	90.1 AV			1.51 V	161	86.4	3.7
5	#10400.00	49.0 PK	74.0	-25.0	2.17 V	147	36.0	13.0
6	#10400.00	36.5 AV	54.0	-17.5	2.17 V	147	23.5	13.0
7	15600.00	53.1 PK	74.0	-20.9	3.17 V	100	39.8	13.3
8	15600.00	39.9 AV	54.0	-14.1	3.17 V	100	26.6	13.3

REMARKS:

1. Emission Level(dBuV/m) = Raw Value(dBuV) + Correction Factor(dB/m)
2. Correction Factor(dB/m) = Antenna Factor(dB/m) + Cable Factor(dB) – Pre-Amplifier Factor(dB)
3. The other emission levels were very low against the limit.
4. Margin value = Emission Level – Limit value
5. " * ": Fundamental frequency.
6. " # ": The radiated frequency is out of the restricted band.

CHANNEL	TX Channel 48	DETECTOR FUNCTION	Peak (PK)
FREQUENCY RANGE	1GHz ~ 40GHz		Average (AV)

ANTENNA POLARITY & TEST DISTANCE: HORIZONTAL AT 3 M

NO.	FREQ. (MHz)	EMISSION LEVEL (dBuV/m)	LIMIT (dBuV/m)	MARGIN (dB)	ANTENNA HEIGHT (m)	TABLE ANGLE (Degree)	RAW VALUE (dBuV)	CORRECTION FACTOR (dB/m)
1	*5240.00	120.9 PK			3.28 H	98	117.1	3.8
2	*5240.00	110.5 AV			3.28 H	98	106.7	3.8
3	5350.00	50.7 PK	74.0	-23.3	3.28 H	98	46.6	4.1
4	5350.00	39.5 AV	54.0	-14.5	3.28 H	98	35.4	4.1
5	#10480.00	49.4 PK	74.0	-24.6	1.69 H	74	36.2	13.2
6	#10480.00	37.5 AV	54.0	-16.5	1.69 H	74	24.3	13.2
7	15720.00	53.2 PK	74.0	-20.8	2.09 H	95	39.6	13.6
8	15720.00	40.1 AV	54.0	-13.9	2.09 H	95	26.5	13.6

ANTENNA POLARITY & TEST DISTANCE: VERTICAL AT 3 M

NO.	FREQ. (MHz)	EMISSION LEVEL (dBuV/m)	LIMIT (dBuV/m)	MARGIN (dB)	ANTENNA HEIGHT (m)	TABLE ANGLE (Degree)	RAW VALUE (dBuV)	CORRECTION FACTOR (dB/m)
1	*5240.00	106.1 PK			1.50 V	170	102.3	3.8
2	*5240.00	94.5 AV			1.50 V	170	90.7	3.8
3	5350.00	49.5 PK	74.0	-24.5	1.47 V	169	45.4	4.1
4	5350.00	38.6 AV	54.0	-15.4	1.47 V	169	34.5	4.1
5	#10480.00	48.5 PK	74.0	-25.5	2.13 V	146	35.3	13.2
6	#10480.00	36.1 AV	54.0	-17.9	2.13 V	146	22.9	13.2
7	15720.00	52.9 PK	74.0	-21.1	3.21 V	100	39.3	13.6
8	15720.00	39.7 AV	54.0	-14.3	3.21 V	100	26.1	13.6

REMARKS:

1. Emission Level(dBuV/m) = Raw Value(dBuV) + Correction Factor(dB/m)
2. Correction Factor(dB/m) = Antenna Factor(dB/m) + Cable Factor(dB) – Pre-Amplifier Factor(dB)
3. The other emission levels were very low against the limit.
4. Margin value = Emission Level – Limit value
5. " * ": Fundamental frequency.
6. " # ": The radiated frequency is out of the restricted band.

CHANNEL	TX Channel 149	DETECTOR FUNCTION	Peak (PK)
FREQUENCY RANGE	1GHz ~ 40GHz		Average (AV)

ANTENNA POLARITY & TEST DISTANCE: HORIZONTAL AT 3 M

NO.	FREQ. (MHz)	EMISSION LEVEL (dBuV/m)	LIMIT (dBuV/m)	MARGIN (dB)	ANTENNA HEIGHT (m)	TABLE ANGLE (Degree)	RAW VALUE (dBuV)	CORRECTION FACTOR (dB/m)
1	#5580.60	60.1 PK	68.2	-8.1	2.36 H	92	55.9	4.2
2	*5745.00	125.6 PK			2.36 H	92	121.2	4.4
3	*5745.00	114.9 AV			2.36 H	92	110.5	4.4
4	#5967.90	60.2 PK	68.2	-8.0	2.36 H	92	55.5	4.7
5	11490.00	50.5 PK	74.0	-23.5	2.15 H	292	37.0	13.5
6	11490.00	39.2 AV	54.0	-14.8	2.15 H	292	25.7	13.5
7	#17235.00	58.1 PK	74.0	-15.9	1.70 H	167	40.8	17.3
8	#17235.00	44.1 AV	54.0	-9.9	1.70 H	167	26.8	17.3

ANTENNA POLARITY & TEST DISTANCE: VERTICAL AT 3 M

NO.	FREQ. (MHz)	EMISSION LEVEL (dBuV/m)	LIMIT (dBuV/m)	MARGIN (dB)	ANTENNA HEIGHT (m)	TABLE ANGLE (Degree)	RAW VALUE (dBuV)	CORRECTION FACTOR (dB/m)
1	#5624.99	59.1 PK	68.2	-9.1	1.74 V	149	54.7	4.4
2	*5745.00	107.8 PK			1.74 V	149	103.4	4.4
3	*5745.00	97.9 AV			1.74 V	149	93.5	4.4
4	#5976.80	59.5 PK	68.2	-8.7	1.74 V	149	54.8	4.7
5	11490.00	51.5 PK	74.0	-22.5	1.67 V	225	38.0	13.5
6	11490.00	38.5 AV	54.0	-15.5	1.67 V	225	25.0	13.5
7	#17235.00	57.6 PK	74.0	-16.4	1.19 V	109	40.3	17.3
8	#17235.00	43.8 AV	54.0	-10.2	1.19 V	109	26.5	17.3

REMARKS:

1. Emission Level(dBuV/m) = Raw Value(dBuV) + Correction Factor(dB/m)
2. Correction Factor(dB/m) = Antenna Factor(dB/m) + Cable Factor(dB) – Pre-Amplifier Factor(dB)
3. The other emission levels were very low against the limit.
4. Margin value = Emission Level – Limit value
5. " * ": Fundamental frequency.
6. " # ": The radiated frequency is out of the restricted band.

CHANNEL	TX Channel 157	DETECTOR FUNCTION	Peak (PK)
FREQUENCY RANGE	1GHz ~ 40GHz		Average (AV)

ANTENNA POLARITY & TEST DISTANCE: HORIZONTAL AT 3 M

NO.	FREQ. (MHz)	EMISSION LEVEL (dBuV/m)	LIMIT (dBuV/m)	MARGIN (dB)	ANTENNA HEIGHT (m)	TABLE ANGLE (Degree)	RAW VALUE (dBuV)	CORRECTION FACTOR (dB/m)
1	#5633.04	58.5 PK	68.2	-9.7	2.73 H	95	54.1	4.4
2	*5785.00	124.8 PK			2.73 H	95	120.4	4.4
3	*5785.00	114.0 AV			2.73 H	95	109.6	4.4
4	#5975.94	59.5 PK	68.2	-8.7	2.73 H	95	54.8	4.7
5	11570.00	51.6 PK	74.0	-22.4	2.09 H	291	38.1	13.5
6	11570.00	39.1 AV	54.0	-14.9	2.09 H	291	25.6	13.5
7	#17355.00	57.9 PK	74.0	-16.1	1.72 H	154	39.9	18.0
8	#17355.00	44.2 AV	54.0	-9.8	1.72 H	154	26.2	18.0

ANTENNA POLARITY & TEST DISTANCE: VERTICAL AT 3 M

NO.	FREQ. (MHz)	EMISSION LEVEL (dBuV/m)	LIMIT (dBuV/m)	MARGIN (dB)	ANTENNA HEIGHT (m)	TABLE ANGLE (Degree)	RAW VALUE (dBuV)	CORRECTION FACTOR (dB/m)
1	#5604.42	58.0 PK	68.2	-10.2	1.73 V	159	53.6	4.4
2	*5785.00	107.9 PK			1.73 V	159	103.5	4.4
3	*5785.00	97.8 AV			1.73 V	159	93.4	4.4
4	#5961.68	58.4 PK	68.2	-9.8	1.73 V	159	53.7	4.7
5	11570.00	51.4 PK	74.0	-22.6	1.65 V	232	37.9	13.5
6	11570.00	38.4 AV	54.0	-15.6	1.65 V	232	24.9	13.5
7	#17355.00	57.8 PK	74.0	-16.2	1.17 V	115	39.8	18.0
8	#17355.00	43.8 AV	54.0	-10.2	1.17 V	115	25.8	18.0

REMARKS:

1. Emission Level(dBuV/m) = Raw Value(dBuV) + Correction Factor(dB/m)
2. Correction Factor(dB/m) = Antenna Factor(dB/m) + Cable Factor(dB) – Pre-Amplifier Factor(dB)
3. The other emission levels were very low against the limit.
4. Margin value = Emission Level – Limit value
5. " * ": Fundamental frequency.
6. " # ": The radiated frequency is out of the restricted band.

CHANNEL	TX Channel 165	DETECTOR FUNCTION	Peak (PK)
FREQUENCY RANGE	1GHz ~ 40GHz		Average (AV)

ANTENNA POLARITY & TEST DISTANCE: HORIZONTAL AT 3 M

NO.	FREQ. (MHz)	EMISSION LEVEL (dBuV/m)	LIMIT (dBuV/m)	MARGIN (dB)	ANTENNA HEIGHT (m)	TABLE ANGLE (Degree)	RAW VALUE (dBuV)	CORRECTION FACTOR (dB/m)
1	#5596.10	58.0 PK	68.2	-10.2	2.63 H	91	53.7	4.3
2	*5825.00	124.6 PK			2.63 H	91	120.2	4.4
3	*5825.00	114.2 AV			2.63 H	91	109.8	4.4
4	#5984.42	58.3 PK	68.2	-9.9	2.63 H	91	53.6	4.7
5	11650.00	51.3 PK	74.0	-22.7	2.20 H	298	37.6	13.7
6	11650.00	39.4 AV	54.0	-14.6	2.20 H	298	25.7	13.7
7	#17475.00	57.6 PK	74.0	-16.4	1.73 H	165	39.0	18.6
8	#17475.00	43.8 AV	54.0	-10.2	1.73 H	165	25.2	18.6

ANTENNA POLARITY & TEST DISTANCE: VERTICAL AT 3 M

NO.	FREQ. (MHz)	EMISSION LEVEL (dBuV/m)	LIMIT (dBuV/m)	MARGIN (dB)	ANTENNA HEIGHT (m)	TABLE ANGLE (Degree)	RAW VALUE (dBuV)	CORRECTION FACTOR (dB/m)
1	#5628.77	58.5 PK	68.2	-9.7	1.78 V	158	54.1	4.4
2	*5825.00	107.5 PK			1.78 V	158	103.1	4.4
3	*5825.00	97.3 AV			1.78 V	158	92.9	4.4
4	#5977.38	58.5 PK	68.2	-9.7	1.78 V	158	53.8	4.7
5	11650.00	51.0 PK	74.0	-23.0	1.70 V	222	37.3	13.7
6	11650.00	38.1 AV	54.0	-15.9	1.70 V	222	24.4	13.7
7	#17475.00	57.3 PK	74.0	-16.7	1.19 V	116	38.7	18.6
8	#17475.00	43.3 AV	54.0	-10.7	1.19 V	116	24.7	18.6

REMARKS:

1. Emission Level(dBuV/m) = Raw Value(dBuV) + Correction Factor(dB/m)
2. Correction Factor(dB/m) = Antenna Factor(dB/m) + Cable Factor(dB) – Pre-Amplifier Factor(dB)
3. The other emission levels were very low against the limit.
4. Margin value = Emission Level – Limit value
5. " * ": Fundamental frequency.
6. " # ": The radiated frequency is out of the restricted band.

802.11ac (VHT20)

CHANNEL	TX Channel 36	DETECTOR FUNCTION	Peak (PK)
FREQUENCY RANGE	1GHz ~ 40GHz		Average (AV)

ANTENNA POLARITY & TEST DISTANCE: HORIZONTAL AT 3 M								
NO.	FREQ. (MHz)	EMISSION LEVEL (dBuV/m)	LIMIT (dBuV/m)	MARGIN (dB)	ANTENNA HEIGHT (m)	TABLE ANGLE (Degree)	RAW VALUE (dBuV)	CORRECTION FACTOR (dB/m)
1	5147.40	66.7 PK	74.0	-7.3	2.79 H	101	63.1	3.6
2	5147.40	52.3 AV	54.0	-1.7	2.79 H	101	48.7	3.6
3	*5180.00	121.3 PK			2.79 H	101	117.6	3.7
4	*5180.00	110.5 AV			2.79 H	101	106.8	3.7
5	#10360.00	50.7 PK	74.0	-23.3	2.23 H	290	37.7	13.0
6	#10360.00	39.6 AV	54.0	-14.4	2.23 H	290	26.6	13.0
7	15540.00	58.9 PK	74.0	-15.1	1.70 H	173	45.8	13.1
8	15540.00	44.2 AV	54.0	-9.8	1.70 H	173	31.1	13.1

ANTENNA POLARITY & TEST DISTANCE: VERTICAL AT 3 M								
NO.	FREQ. (MHz)	EMISSION LEVEL (dBuV/m)	LIMIT (dBuV/m)	MARGIN (dB)	ANTENNA HEIGHT (m)	TABLE ANGLE (Degree)	RAW VALUE (dBuV)	CORRECTION FACTOR (dB/m)
1	5147.40	52.9 PK	74.0	-21.1	1.80 V	151	49.3	3.6
2	5147.40	41.1 AV	54.0	-12.9	1.80 V	151	37.5	3.6
3	*5180.00	106.9 PK			1.80 V	151	103.2	3.7
4	*5180.00	94.9 AV			1.80 V	151	91.2	3.7
5	#10360.00	51.0 PK	74.0	-23.0	1.73 V	222	38.0	13.0
6	#10360.00	38.1 AV	54.0	-15.9	1.73 V	222	25.1	13.0
7	15540.00	58.0 PK	74.0	-16.0	1.16 V	107	44.9	13.1
8	15540.00	43.8 AV	54.0	-10.2	1.16 V	107	30.7	13.1

REMARKS:

- Emission Level(dBuV/m) = Raw Value(dBuV) + Correction Factor(dB/m)
- Correction Factor(dB/m) = Antenna Factor(dB/m) + Cable Factor(dB) – Pre-Amplifier Factor(dB)
- The other emission levels were very low against the limit.
- Margin value = Emission Level – Limit value
- " * ": Fundamental frequency.
- " # ": The radiated frequency is out of the restricted band.

CHANNEL	TX Channel 40	DETECTOR FUNCTION	Peak (PK)
FREQUENCY RANGE	1GHz ~ 40GHz		Average (AV)

ANTENNA POLARITY & TEST DISTANCE: HORIZONTAL AT 3 M

NO.	FREQ. (MHz)	EMISSION LEVEL (dBuV/m)	LIMIT (dBuV/m)	MARGIN (dB)	ANTENNA HEIGHT (m)	TABLE ANGLE (Degree)	RAW VALUE (dBuV)	CORRECTION FACTOR (dB/m)
1	5150.00	58.8 PK	74.0	-15.2	3.35 H	100	55.1	3.7
2	5150.00	46.4 AV	54.0	-7.6	3.35 H	100	42.7	3.7
3	*5200.00	119.8 PK			3.35 H	100	116.1	3.7
4	*5200.00	109.3 AV			3.35 H	100	105.6	3.7
5	#10400.00	50.0 PK	74.0	-24.0	2.16 H	308	37.0	13.0
6	#10400.00	39.3 AV	54.0	-14.7	2.16 H	308	26.3	13.0
7	15600.00	58.6 PK	74.0	-15.4	1.78 H	158	45.3	13.3
8	15600.00	44.5 AV	54.0	-9.5	1.78 H	158	31.2	13.3

ANTENNA POLARITY & TEST DISTANCE: VERTICAL AT 3 M

NO.	FREQ. (MHz)	EMISSION LEVEL (dBuV/m)	LIMIT (dBuV/m)	MARGIN (dB)	ANTENNA HEIGHT (m)	TABLE ANGLE (Degree)	RAW VALUE (dBuV)	CORRECTION FACTOR (dB/m)
1	5150.00	45.4 PK	74.0	-28.6	1.79 V	165	41.7	3.7
2	5150.00	34.4 AV	54.0	-19.6	1.79 V	165	30.7	3.7
3	*5200.00	105.1 PK			1.79 V	165	101.4	3.7
4	*5200.00	93.9 AV			1.79 V	165	90.2	3.7
5	#10400.00	51.1 PK	74.0	-22.9	1.74 V	210	38.1	13.0
6	#10400.00	38.5 AV	54.0	-15.5	1.74 V	210	25.5	13.0
7	15600.00	58.2 PK	74.0	-15.8	1.22 V	96	44.9	13.3
8	15600.00	44.1 AV	54.0	-9.9	1.22 V	96	30.8	13.3

REMARKS:

1. Emission Level(dBuV/m) = Raw Value(dBuV) + Correction Factor(dB/m)
2. Correction Factor(dB/m) = Antenna Factor(dB/m) + Cable Factor(dB) – Pre-Amplifier Factor(dB)
3. The other emission levels were very low against the limit.
4. Margin value = Emission Level – Limit value
5. " * ": Fundamental frequency.
6. " # ": The radiated frequency is out of the restricted band.

CHANNEL	TX Channel 48	DETECTOR FUNCTION	Peak (PK)
FREQUENCY RANGE	1GHz ~ 40GHz		Average (AV)

ANTENNA POLARITY & TEST DISTANCE: HORIZONTAL AT 3 M

NO.	FREQ. (MHz)	EMISSION LEVEL (dBuV/m)	LIMIT (dBuV/m)	MARGIN (dB)	ANTENNA HEIGHT (m)	TABLE ANGLE (Degree)	RAW VALUE (dBuV)	CORRECTION FACTOR (dB/m)
1	*5240.00	121.9 PK			3.52 H	82	118.1	3.8
2	*5240.00	111.4 AV			3.52 H	82	107.6	3.8
3	5350.00	49.9 PK	74.0	-24.1	3.52 H	82	45.8	4.1
4	5350.00	37.8 AV	54.0	-16.2	3.52 H	82	33.7	4.1
5	#10480.00	51.6 PK	74.0	-22.4	2.13 H	312	38.4	13.2
6	#10480.00	39.7 AV	54.0	-14.3	2.13 H	312	26.5	13.2
7	15720.00	58.6 PK	74.0	-15.4	1.82 H	157	45.0	13.6
8	15720.00	44.6 AV	54.0	-9.4	1.82 H	157	31.0	13.6

ANTENNA POLARITY & TEST DISTANCE: VERTICAL AT 3 M

NO.	FREQ. (MHz)	EMISSION LEVEL (dBuV/m)	LIMIT (dBuV/m)	MARGIN (dB)	ANTENNA HEIGHT (m)	TABLE ANGLE (Degree)	RAW VALUE (dBuV)	CORRECTION FACTOR (dB/m)
1	*5240.00	107.7 PK			1.82 V	153	103.9	3.8
2	*5240.00	95.8 AV			1.82 V	153	92.0	3.8
3	5350.00	49.6 PK	74.0	-24.4	1.82 V	153	45.5	4.1
4	5350.00	37.4 AV	54.0	-16.6	1.82 V	153	33.3	4.1
5	#10480.00	51.4 PK	74.0	-22.6	1.79 V	219	38.2	13.2
6	#10480.00	38.9 AV	54.0	-15.1	1.79 V	219	25.7	13.2
7	15720.00	58.3 PK	74.0	-15.7	1.18 V	89	44.7	13.6
8	15720.00	43.9 AV	54.0	-10.1	1.18 V	89	30.3	13.6

REMARKS:

1. Emission Level(dBuV/m) = Raw Value(dBuV) + Correction Factor(dB/m)
2. Correction Factor(dB/m) = Antenna Factor(dB/m) + Cable Factor(dB) – Pre-Amplifier Factor(dB)
3. The other emission levels were very low against the limit.
4. Margin value = Emission Level – Limit value
5. " * ": Fundamental frequency.
6. " # ": The radiated frequency is out of the restricted band.

CHANNEL	TX Channel 149	DETECTOR FUNCTION	Peak (PK)
FREQUENCY RANGE	1GHz ~ 40GHz		Average (AV)

ANTENNA POLARITY & TEST DISTANCE: HORIZONTAL AT 3 M

NO.	FREQ. (MHz)	EMISSION LEVEL (dBuV/m)	LIMIT (dBuV/m)	MARGIN (dB)	ANTENNA HEIGHT (m)	TABLE ANGLE (Degree)	RAW VALUE (dBuV)	CORRECTION FACTOR (dB/m)
1	#5619.78	58.8 PK	68.2	-9.4	2.40 H	89	54.4	4.4
2	*5745.00	123.9 PK			2.40 H	89	119.5	4.4
3	*5745.00	113.4 AV			2.40 H	89	109.0	4.4
4	#5955.77	60.1 PK	68.2	-8.1	2.40 H	89	55.4	4.7
5	11490.00	51.9 PK	74.0	-22.1	2.12 H	304	38.4	13.5
6	11490.00	40.1 AV	54.0	-13.9	2.12 H	304	26.6	13.5
7	#17235.00	58.9 PK	74.0	-15.1	1.82 H	166	41.6	17.3
8	#17235.00	44.9 AV	54.0	-9.1	1.82 H	166	27.6	17.3

ANTENNA POLARITY & TEST DISTANCE: VERTICAL AT 3 M

NO.	FREQ. (MHz)	EMISSION LEVEL (dBuV/m)	LIMIT (dBuV/m)	MARGIN (dB)	ANTENNA HEIGHT (m)	TABLE ANGLE (Degree)	RAW VALUE (dBuV)	CORRECTION FACTOR (dB/m)
1	#5613.28	58.9 PK	68.2	-9.3	2.63 V	351	54.5	4.4
2	*5745.00	110.8 PK			2.63 V	351	106.4	4.4
3	*5745.00	99.8 AV			2.63 V	351	95.4	4.4
4	#5970.66	59.4 PK	68.2	-8.8	2.63 V	351	54.7	4.7
5	11490.00	51.2 PK	74.0	-22.8	1.84 V	224	37.7	13.5
6	11490.00	38.6 AV	54.0	-15.4	1.84 V	224	25.1	13.5
7	#17235.00	58.2 PK	74.0	-15.8	1.17 V	100	40.9	17.3
8	#17235.00	43.7 AV	54.0	-10.3	1.17 V	100	26.4	17.3

REMARKS:

1. Emission Level(dBuV/m) = Raw Value(dBuV) + Correction Factor(dB/m)
2. Correction Factor(dB/m) = Antenna Factor(dB/m) + Cable Factor(dB) – Pre-Amplifier Factor(dB)
3. The other emission levels were very low against the limit.
4. Margin value = Emission Level – Limit value
5. " * ": Fundamental frequency.
6. " # ": The radiated frequency is out of the restricted band.

CHANNEL	TX Channel 157	DETECTOR FUNCTION	Peak (PK)
FREQUENCY RANGE	1GHz ~ 40GHz		Average (AV)

ANTENNA POLARITY & TEST DISTANCE: HORIZONTAL AT 3 M

NO.	FREQ. (MHz)	EMISSION LEVEL (dBuV/m)	LIMIT (dBuV/m)	MARGIN (dB)	ANTENNA HEIGHT (m)	TABLE ANGLE (Degree)	RAW VALUE (dBuV)	CORRECTION FACTOR (dB/m)
1	#5596.12	58.7 PK	68.2	-9.5	2.63 H	92	54.4	4.3
2	*5785.00	123.4 PK			2.63 H	92	119.0	4.4
3	*5785.00	112.7 AV			2.63 H	92	108.3	4.4
4	#5959.43	58.8 PK	68.2	-9.4	2.63 H	92	54.1	4.7
5	11570.00	51.6 PK	74.0	-22.4	2.09 H	325	38.1	13.5
6	11570.00	39.5 AV	54.0	-14.5	2.09 H	325	26.0	13.5
7	#17355.00	58.6 PK	74.0	-15.4	1.82 H	159	40.6	18.0
8	#17355.00	44.5 AV	54.0	-9.5	1.82 H	159	26.5	18.0

ANTENNA POLARITY & TEST DISTANCE: VERTICAL AT 3 M

NO.	FREQ. (MHz)	EMISSION LEVEL (dBuV/m)	LIMIT (dBuV/m)	MARGIN (dB)	ANTENNA HEIGHT (m)	TABLE ANGLE (Degree)	RAW VALUE (dBuV)	CORRECTION FACTOR (dB/m)
1	#5604.84	59.0 PK	68.2	-9.2	2.64 V	357	54.6	4.4
2	*5785.00	110.9 PK			2.64 V	357	106.5	4.4
3	*5785.00	99.8 AV			2.64 V	357	95.4	4.4
4	#5965.65	58.7 PK	68.2	-9.5	2.64 V	357	54.0	4.7
5	11570.00	51.2 PK	74.0	-22.8	1.87 V	232	37.7	13.5
6	11570.00	38.4 AV	54.0	-15.6	1.87 V	232	24.9	13.5
7	#17355.00	58.5 PK	74.0	-15.5	1.18 V	91	40.5	18.0
8	#17355.00	44.0 AV	54.0	-10.0	1.18 V	91	26.0	18.0

REMARKS:

1. Emission Level(dBuV/m) = Raw Value(dBuV) + Correction Factor(dB/m)
2. Correction Factor(dB/m) = Antenna Factor(dB/m) + Cable Factor(dB) – Pre-Amplifier Factor(dB)
3. The other emission levels were very low against the limit.
4. Margin value = Emission Level – Limit value
5. " * ": Fundamental frequency.
6. " # ": The radiated frequency is out of the restricted band.

CHANNEL	TX Channel 165	DETECTOR FUNCTION	Peak (PK)
FREQUENCY RANGE	1GHz ~ 40GHz		Average (AV)

ANTENNA POLARITY & TEST DISTANCE: HORIZONTAL AT 3 M

NO.	FREQ. (MHz)	EMISSION LEVEL (dBuV/m)	LIMIT (dBuV/m)	MARGIN (dB)	ANTENNA HEIGHT (m)	TABLE ANGLE (Degree)	RAW VALUE (dBuV)	CORRECTION FACTOR (dB/m)
1	#5634.21	59.1 PK	68.2	-9.1	2.45 H	92	54.7	4.4
2	*5825.00	123.7 PK			2.45 H	92	119.3	4.4
3	*5825.00	112.2 AV			2.45 H	92	107.8	4.4
4	#5947.03	58.5 PK	68.2	-9.7	2.45 H	92	53.8	4.7
5	11650.00	51.6 PK	74.0	-22.4	2.11 H	309	37.9	13.7
6	11650.00	40.0 AV	54.0	-14.0	2.11 H	309	26.3	13.7
7	#17475.00	59.6 PK	74.0	-14.4	1.82 H	172	41.0	18.6
8	#17475.00	44.9 AV	54.0	-9.1	1.82 H	172	26.3	18.6

ANTENNA POLARITY & TEST DISTANCE: VERTICAL AT 3 M

NO.	FREQ. (MHz)	EMISSION LEVEL (dBuV/m)	LIMIT (dBuV/m)	MARGIN (dB)	ANTENNA HEIGHT (m)	TABLE ANGLE (Degree)	RAW VALUE (dBuV)	CORRECTION FACTOR (dB/m)
1	#5614.18	58.4 PK	68.2	-9.8	2.58 V	360	54.0	4.4
2	*5825.00	110.9 PK			2.58 V	360	106.5	4.4
3	*5825.00	99.9 AV			2.58 V	360	95.5	4.4
4	#5957.18	58.6 PK	68.2	-9.6	2.58 V	360	53.9	4.7
5	11650.00	51.8 PK	74.0	-22.2	1.82 V	239	38.1	13.7
6	11650.00	38.9 AV	54.0	-15.1	1.82 V	239	25.2	13.7
7	#17475.00	59.1 PK	74.0	-14.9	1.20 V	81	40.5	18.6
8	#17475.00	44.5 AV	54.0	-9.5	1.20 V	81	25.9	18.6

REMARKS:

1. Emission Level(dBuV/m) = Raw Value(dBuV) + Correction Factor(dB/m)
2. Correction Factor(dB/m) = Antenna Factor(dB/m) + Cable Factor(dB) – Pre-Amplifier Factor(dB)
3. The other emission levels were very low against the limit.
4. Margin value = Emission Level – Limit value
5. " * ": Fundamental frequency.
6. " # ": The radiated frequency is out of the restricted band.

802.11ac (VHT40)

CHANNEL	TX Channel 38	DETECTOR FUNCTION	Peak (PK)
FREQUENCY RANGE	1GHz ~ 40GHz		Average (AV)

ANTENNA POLARITY & TEST DISTANCE: HORIZONTAL AT 3 M

NO.	FREQ. (MHz)	EMISSION LEVEL (dBuV/m)	LIMIT (dBuV/m)	MARGIN (dB)	ANTENNA HEIGHT (m)	TABLE ANGLE (Degree)	RAW VALUE (dBuV)	CORRECTION FACTOR (dB/m)
1	5145.40	65.6 PK	74.0	-8.4	3.15 H	102	62.0	3.6
2	5145.40	53.4 AV	54.0	-0.6	3.15 H	102	49.8	3.6
3	*5190.00	111.8 PK			3.15 H	102	108.1	3.7
4	*5190.00	102.6 AV			3.15 H	102	98.9	3.7
5	5350.00	51.6 PK	74.0	-22.4	3.15 H	102	47.5	4.1
6	5350.00	40.4 AV	54.0	-13.6	3.15 H	102	36.3	4.1
7	#10380.00	52.6 PK	74.0	-21.4	2.05 H	308	39.5	13.1
8	#10380.00	39.6 AV	54.0	-14.4	2.05 H	308	26.5	13.1
9	15570.00	60.2 PK	74.0	-13.8	1.80 H	183	46.9	13.3
10	15570.00	45.2 AV	54.0	-8.8	1.80 H	183	31.9	13.3

ANTENNA POLARITY & TEST DISTANCE: VERTICAL AT 3 M

NO.	FREQ. (MHz)	EMISSION LEVEL (dBuV/m)	LIMIT (dBuV/m)	MARGIN (dB)	ANTENNA HEIGHT (m)	TABLE ANGLE (Degree)	RAW VALUE (dBuV)	CORRECTION FACTOR (dB/m)
1	5145.40	51.4 PK	74.0	-22.6	2.62 V	351	47.8	3.6
2	5145.40	40.8 AV	54.0	-13.2	2.62 V	351	37.2	3.6
3	*5190.00	97.5 PK			2.62 V	351	93.8	3.7
4	*5190.00	87.4 AV			2.62 V	351	83.7	3.7
5	5350.00	48.4 PK	74.0	-25.6	2.62 V	351	44.3	4.1
6	5350.00	34.2 AV	54.0	-19.8	2.62 V	351	30.1	4.1
7	#10380.00	52.3 PK	74.0	-21.7	1.87 V	251	39.2	13.1
8	#10380.00	39.2 AV	54.0	-14.8	1.87 V	251	26.1	13.1
9	15570.00	58.8 PK	74.0	-15.2	1.25 V	91	45.5	13.3
10	15570.00	44.4 AV	54.0	-9.6	1.25 V	91	31.1	13.3

REMARKS:

- Emission Level(dBuV/m) = Raw Value(dBuV) + Correction Factor(dB/m)
- Correction Factor(dB/m) = Antenna Factor(dB/m) + Cable Factor(dB) – Pre-Amplifier Factor(dB)
- The other emission levels were very low against the limit.
- Margin value = Emission Level – Limit value
- " * ": Fundamental frequency.
- " # ": The radiated frequency is out of the restricted band.

CHANNEL	TX Channel 46	DETECTOR FUNCTION	Peak (PK)
FREQUENCY RANGE	1GHz ~ 40GHz		Average (AV)

ANTENNA POLARITY & TEST DISTANCE: HORIZONTAL AT 3 M

NO.	FREQ. (MHz)	EMISSION LEVEL (dBuV/m)	LIMIT (dBuV/m)	MARGIN (dB)	ANTENNA HEIGHT (m)	TABLE ANGLE (Degree)	RAW VALUE (dBuV)	CORRECTION FACTOR (dB/m)
1	5139.70	65.3 PK	74.0	-8.7	3.46 H	82	61.7	3.6
2	5139.70	52.2 AV	54.0	-1.8	3.46 H	82	48.6	3.6
3	*5230.00	119.4 PK			3.46 H	82	115.6	3.8
4	*5230.00	110.1 AV			3.46 H	82	106.3	3.8
5	#10460.00	53.0 PK	74.0	-21.0	1.99 H	302	39.9	13.1
6	#10460.00	40.0 AV	54.0	-14.0	1.99 H	302	26.9	13.1
7	15690.00	59.9 PK	74.0	-14.1	1.76 H	185	46.1	13.8
8	15690.00	45.0 AV	54.0	-9.0	1.76 H	185	31.2	13.8

ANTENNA POLARITY & TEST DISTANCE: VERTICAL AT 3 M

NO.	FREQ. (MHz)	EMISSION LEVEL (dBuV/m)	LIMIT (dBuV/m)	MARGIN (dB)	ANTENNA HEIGHT (m)	TABLE ANGLE (Degree)	RAW VALUE (dBuV)	CORRECTION FACTOR (dB/m)
1	5139.70	51.5 PK	74.0	-22.5	2.62 V	360	47.9	3.6
2	5139.70	40.1 AV	54.0	-13.9	2.62 V	360	36.5	3.6
3	*5230.00	105.1 PK			2.62 V	360	101.3	3.8
4	*5230.00	94.9 AV			2.62 V	360	91.1	3.8
5	#10460.00	52.3 PK	74.0	-21.7	1.91 V	247	39.2	13.1
6	#10460.00	39.0 AV	54.0	-15.0	1.91 V	247	25.9	13.1
7	15690.00	59.2 PK	74.0	-14.8	1.20 V	90	45.4	13.8
8	15690.00	44.6 AV	54.0	-9.4	1.20 V	90	30.8	13.8

REMARKS:

1. Emission Level(dBuV/m) = Raw Value(dBuV) + Correction Factor(dB/m)
2. Correction Factor(dB/m) = Antenna Factor(dB/m) + Cable Factor(dB) – Pre-Amplifier Factor(dB)
3. The other emission levels were very low against the limit.
4. Margin value = Emission Level – Limit value
5. " * ": Fundamental frequency.
6. " # ": The radiated frequency is out of the restricted band.

CHANNEL	TX Channel 151	DETECTOR FUNCTION	Peak (PK)
FREQUENCY RANGE	1GHz ~ 40GHz		Average (AV)

ANTENNA POLARITY & TEST DISTANCE: HORIZONTAL AT 3 M

NO.	FREQ. (MHz)	EMISSION LEVEL (dBuV/m)	LIMIT (dBuV/m)	MARGIN (dB)	ANTENNA HEIGHT (m)	TABLE ANGLE (Degree)	RAW VALUE (dBuV)	CORRECTION FACTOR (dB/m)
1	#5652.12	66.1 PK	69.8	-3.7	2.60 H	94	61.8	4.3
2	*5755.00	121.6 PK			2.60 H	94	117.2	4.4
3	*5755.00	112.0 AV			2.60 H	94	107.6	4.4
4	#5946.13	59.1 PK	68.2	-9.1	2.60 H	94	54.4	4.7
5	11510.00	52.5 PK	74.0	-21.5	2.09 H	320	38.9	13.6
6	11510.00	39.3 AV	54.0	-14.7	2.09 H	320	25.7	13.6
7	#17265.00	60.5 PK	74.0	-13.5	1.81 H	187	42.9	17.6
8	#17265.00	45.4 AV	54.0	-8.6	1.81 H	187	27.8	17.6

ANTENNA POLARITY & TEST DISTANCE: VERTICAL AT 3 M

NO.	FREQ. (MHz)	EMISSION LEVEL (dBuV/m)	LIMIT (dBuV/m)	MARGIN (dB)	ANTENNA HEIGHT (m)	TABLE ANGLE (Degree)	RAW VALUE (dBuV)	CORRECTION FACTOR (dB/m)
1	#5635.48	58.1 PK	68.2	-10.1	2.14 V	140	53.7	4.4
2	*5755.00	105.9 PK			2.14 V	140	101.5	4.4
3	*5755.00	96.1 AV			2.14 V	140	91.7	4.4
4	#5953.38	58.7 PK	68.2	-9.5	2.14 V	140	54.0	4.7
5	11510.00	52.4 PK	74.0	-21.6	1.97 V	252	38.8	13.6
6	11510.00	39.0 AV	54.0	-15.0	1.97 V	252	25.4	13.6
7	#17265.00	58.8 PK	74.0	-15.2	1.15 V	85	41.2	17.6
8	#17265.00	44.1 AV	54.0	-9.9	1.15 V	85	26.5	17.6

REMARKS:

1. Emission Level(dBuV/m) = Raw Value(dBuV) + Correction Factor(dB/m)
2. Correction Factor(dB/m) = Antenna Factor(dB/m) + Cable Factor(dB) – Pre-Amplifier Factor(dB)
3. The other emission levels were very low against the limit.
4. Margin value = Emission Level – Limit value
5. " * ": Fundamental frequency.
6. " # ": The radiated frequency is out of the restricted band.

CHANNEL	TX Channel 159	DETECTOR FUNCTION	Peak (PK)
FREQUENCY RANGE	1GHz ~ 40GHz		Average (AV)

ANTENNA POLARITY & TEST DISTANCE: HORIZONTAL AT 3 M

NO.	FREQ. (MHz)	EMISSION LEVEL (dBuV/m)	LIMIT (dBuV/m)	MARGIN (dB)	ANTENNA HEIGHT (m)	TABLE ANGLE (Degree)	RAW VALUE (dBuV)	CORRECTION FACTOR (dB/m)
1	#5648.24	59.2 PK	68.2	-9.0	2.33 H	91	54.8	4.4
2	*5795.00	121.8 PK			2.33 H	91	117.4	4.4
3	*5795.00	111.9 AV			2.33 H	91	107.5	4.4
4	#5942.92	59.2 PK	68.2	-9.0	2.33 H	91	54.5	4.7
5	11590.00	53.6 PK	74.0	-20.4	2.00 H	314	40.1	13.5
6	11590.00	39.8 AV	54.0	-14.2	2.00 H	314	26.3	13.5
7	#17385.00	60.1 PK	74.0	-13.9	1.84 H	192	41.8	18.3
8	#17385.00	44.9 AV	54.0	-9.1	1.84 H	192	26.6	18.3

ANTENNA POLARITY & TEST DISTANCE: VERTICAL AT 3 M

NO.	FREQ. (MHz)	EMISSION LEVEL (dBuV/m)	LIMIT (dBuV/m)	MARGIN (dB)	ANTENNA HEIGHT (m)	TABLE ANGLE (Degree)	RAW VALUE (dBuV)	CORRECTION FACTOR (dB/m)
1	#5582.92	58.3 PK	68.2	-9.9	2.08 V	150	54.1	4.2
2	*5795.00	106.4 PK			2.08 V	150	102.0	4.4
3	*5795.00	96.3 AV			2.08 V	150	91.9	4.4
4	#5960.07	59.3 PK	68.2	-8.9	2.08 V	150	54.6	4.7
5	11590.00	53.0 PK	74.0	-21.0	2.00 V	260	39.5	13.5
6	11590.00	39.4 AV	54.0	-14.6	2.00 V	260	25.9	13.5
7	#17385.00	58.8 PK	74.0	-15.2	1.18 V	89	40.5	18.3
8	#17385.00	44.4 AV	54.0	-9.6	1.18 V	89	26.1	18.3

REMARKS:

1. Emission Level(dBuV/m) = Raw Value(dBuV) + Correction Factor(dB/m)
2. Correction Factor(dB/m) = Antenna Factor(dB/m) + Cable Factor(dB) – Pre-Amplifier Factor(dB)
3. The other emission levels were very low against the limit.
4. Margin value = Emission Level – Limit value
5. " * ": Fundamental frequency.
6. " # ": The radiated frequency is out of the restricted band.

802.11ac (VHT80)

CHANNEL	TX Channel 42	DETECTOR FUNCTION	Peak (PK)
FREQUENCY RANGE	1GHz ~ 40GHz		Average (AV)

ANTENNA POLARITY & TEST DISTANCE: HORIZONTAL AT 3 M

NO.	FREQ. (MHz)	EMISSION LEVEL (dBuV/m)	LIMIT (dBuV/m)	MARGIN (dB)	ANTENNA HEIGHT (m)	TABLE ANGLE (Degree)	RAW VALUE (dBuV)	CORRECTION FACTOR (dB/m)
1	5142.50	66.6 PK	74.0	-7.4	3.32 H	96	63.0	3.6
2	5142.50	53.9 AV	54.0	-0.1	3.32 H	96	50.3	3.6
3	*5210.00	105.1 PK			3.32 H	96	101.4	3.7
4	*5210.00	95.8 AV			3.32 H	96	92.1	3.7
5	5350.00	49.3 PK	74.0	-24.7	3.32 H	96	45.2	4.1
6	5350.00	38.3 AV	54.0	-15.7	3.32 H	96	34.2	4.1
7	#10420.00	53.4 PK	74.0	-20.6	2.12 H	331	40.3	13.1
8	#10420.00	39.4 AV	54.0	-14.6	2.12 H	331	26.3	13.1
9	15630.00	60.5 PK	74.0	-13.5	1.84 H	183	46.9	13.6
10	15630.00	45.2 AV	54.0	-8.8	1.84 H	183	31.6	13.6

ANTENNA POLARITY & TEST DISTANCE: VERTICAL AT 3 M

NO.	FREQ. (MHz)	EMISSION LEVEL (dBuV/m)	LIMIT (dBuV/m)	MARGIN (dB)	ANTENNA HEIGHT (m)	TABLE ANGLE (Degree)	RAW VALUE (dBuV)	CORRECTION FACTOR (dB/m)
1	5142.50	52.0 PK	74.0	-22.0	2.08 V	143	48.4	3.6
2	5142.50	39.5 AV	54.0	-14.5	2.08 V	143	35.9	3.6
3	*5210.00	91.3 PK			2.08 V	143	87.6	3.7
4	*5210.00	81.2 AV			2.08 V	143	77.5	3.7
5	5350.00	48.5 PK	74.0	-25.5	2.08 V	143	44.4	4.1
6	5350.00	37.4 AV	54.0	-16.6	2.08 V	143	33.3	4.1
7	#10420.00	53.0 PK	74.0	-21.0	1.96 V	276	39.9	13.1
8	#10420.00	39.2 AV	54.0	-14.8	1.96 V	276	26.1	13.1
9	15630.00	58.7 PK	74.0	-15.3	1.12 V	82	45.1	13.6
10	15630.00	44.1 AV	54.0	-9.9	1.12 V	82	30.5	13.6

REMARKS:

- Emission Level(dBuV/m) = Raw Value(dBuV) + Correction Factor(dB/m)
- Correction Factor(dB/m) = Antenna Factor(dB/m) + Cable Factor(dB) – Pre-Amplifier Factor(dB)
- The other emission levels were very low against the limit.
- Margin value = Emission Level – Limit value
- " * ": Fundamental frequency.
- " # ": The radiated frequency is out of the restricted band.

CHANNEL	TX Channel 155	DETECTOR FUNCTION	Peak (PK)
FREQUENCY RANGE	1GHz ~ 40GHz		Average (AV)

ANTENNA POLARITY & TEST DISTANCE: HORIZONTAL AT 3 M

NO.	FREQ. (MHz)	EMISSION LEVEL (dBuV/m)	LIMIT (dBuV/m)	MARGIN (dB)	ANTENNA HEIGHT (m)	TABLE ANGLE (Degree)	RAW VALUE (dBuV)	CORRECTION FACTOR (dB/m)
1	#5649.14	67.3 PK	68.2	-0.9	2.70 H	93	62.9	4.4
2	*5775.00	114.3 PK			2.65 H	93	109.9	4.4
3	*5775.00	105.2 AV			2.65 H	93	100.8	4.4
4	#5928.98	62.4 PK	68.2	-5.8	2.70 H	93	57.7	4.7
5	11550.00	54.1 PK	74.0	-19.9	2.17 H	343	40.6	13.5
6	11550.00	40.2 AV	54.0	-13.8	2.17 H	343	26.7	13.5
7	#17325.00	59.8 PK	74.0	-14.2	1.83 H	174	42.0	17.8
8	#17325.00	44.7 AV	54.0	-9.3	1.83 H	174	26.9	17.8

ANTENNA POLARITY & TEST DISTANCE: VERTICAL AT 3 M

NO.	FREQ. (MHz)	EMISSION LEVEL (dBuV/m)	LIMIT (dBuV/m)	MARGIN (dB)	ANTENNA HEIGHT (m)	TABLE ANGLE (Degree)	RAW VALUE (dBuV)	CORRECTION FACTOR (dB/m)
1	#5616.44	59.0 PK	68.2	-9.2	2.32 V	154	54.6	4.4
2	*5775.00	100.1 PK			2.32 V	154	95.7	4.4
3	*5775.00	91.0 AV			2.32 V	154	86.6	4.4
4	#5986.99	58.4 PK	68.2	-9.8	2.32 V	154	53.7	4.7
5	11550.00	53.5 PK	74.0	-20.5	1.93 V	271	40.0	13.5
6	11550.00	39.6 AV	54.0	-14.4	1.93 V	271	26.1	13.5
7	#17325.00	58.7 PK	74.0	-15.3	1.13 V	72	40.9	17.8
8	#17325.00	44.0 AV	54.0	-10.0	1.13 V	72	26.2	17.8

REMARKS:

1. Emission Level(dBuV/m) = Raw Value(dBuV) + Correction Factor(dB/m)
2. Correction Factor(dB/m) = Antenna Factor(dB/m) + Cable Factor(dB) – Pre-Amplifier Factor(dB)
3. The other emission levels were very low against the limit.
4. Margin value = Emission Level – Limit value
5. " * ": Fundamental frequency.
6. " # ": The radiated frequency is out of the restricted band.

802.11ac (VHT80+80)

CHANNEL	TX Channel 42+155	DETECTOR FUNCTION	Peak (PK)
FREQUENCY RANGE	1GHz ~ 40GHz		Average (AV)

ANTENNA POLARITY & TEST DISTANCE: HORIZONTAL AT 3 M

NO.	FREQ. (MHz)	EMISSION LEVEL (dBuV/m)	LIMIT (dBuV/m)	MARGIN (dB)	ANTENNA HEIGHT (m)	TABLE ANGLE (Degree)	RAW VALUE (dBuV)	CORRECTION FACTOR (dB/m)
1	5141.00	66.7 PK	74.0	-7.3	2.90 H	302	63.1	3.6
2	5141.00	53.8 AV	54.0	-0.2	2.90 H	302	50.2	3.6
3	*5210.00	103.3 PK			2.90 H	302	99.6	3.7
4	*5210.00	94.4 AV			2.90 H	302	90.7	3.7
5	#5604.71	59.5 PK	68.2	-8.7	2.74 H	91	55.1	4.4
6	*5775.00	104.7 PK			2.74 H	91	100.3	4.4
7	*5775.00	95.0 AV			2.74 H	91	90.6	4.4
8	#5960.20	59.9 PK	68.2	-8.3	2.74 H	91	55.2	4.7
9	#10420.00	54.4 PK	74.0	-19.6	2.16 H	358	41.3	13.1
10	#10420.00	40.5 AV	54.0	-13.5	2.16 H	358	27.4	13.1
11	11550.00	54.3 PK	74.0	-19.7	2.18 H	360	40.8	13.5
12	11550.00	40.1 AV	54.0	-13.9	2.18 H	360	26.6	13.5
13	15630.00	59.5 PK	74.0	-14.5	1.79 H	184	45.9	13.6
14	15630.00	44.6 AV	54.0	-9.4	1.79 H	184	31.0	13.6
15	#17325.00	59.6 PK	74.0	-14.4	1.73 H	198	41.8	17.8
16	#17325.00	44.5 AV	54.0	-9.5	1.73 H	198	26.7	17.8

ANTENNA POLARITY & TEST DISTANCE: VERTICAL AT 3 M

NO.	FREQ. (MHz)	EMISSION LEVEL (dBuV/m)	LIMIT (dBuV/m)	MARGIN (dB)	ANTENNA HEIGHT (m)	TABLE ANGLE (Degree)	RAW VALUE (dBuV)	CORRECTION FACTOR (dB/m)
1	5141.00	56.7 PK	74.0	-17.3	2.32 V	352	53.1	3.6
2	5141.00	43.0 AV	54.0	-11.0	2.32 V	352	39.4	3.6
3	*5210.00	90.7 PK			2.32 V	352	87.0	3.7
4	*5210.00	81.7 AV			2.32 V	352	78.0	3.7
5	#5609.11	58.1 PK	68.2	-10.1	2.33 V	218	53.7	4.4
6	*5775.00	93.4 PK			2.33 V	218	89.0	4.4
7	*5775.00	84.0 AV			2.33 V	218	79.6	4.4
8	#5969.12	59.1 PK	68.2	-9.1	2.33 V	218	54.4	4.7
9	#10420.00	53.4 PK	74.0	-20.6	1.99 V	261	40.3	13.1
10	#10420.00	39.5 AV	54.0	-14.5	1.99 V	261	26.4	13.1
11	11550.00	53.8 PK	74.0	-20.2	1.93 V	275	40.3	13.5
12	11550.00	40.0 AV	54.0	-14.0	1.93 V	275	26.5	13.5
13	15630.00	59.2 PK	74.0	-14.8	1.12 V	85	45.6	13.6
14	15630.00	44.2 AV	54.0	-9.8	1.12 V	85	30.6	13.6
15	#17325.00	58.1 PK	74.0	-15.9	1.18 V	63	40.3	17.8
16	#17325.00	43.6 AV	54.0	-10.4	1.18 V	63	25.8	17.8

REMARKS:

- Emission Level(dBuV/m) = Raw Value(dBuV) + Correction Factor(dB/m)
- Correction Factor(dB/m) = Antenna Factor(dB/m) + Cable Factor(dB) – Pre-Amplifier Factor(dB)
- The other emission levels were very low against the limit.
- Margin value = Emission Level – Limit value
- " * ": Fundamental frequency.
- " # ": The radiated frequency is out of the restricted band.

Below 1GHz Data:

802.11a

CHANNEL	TX Channel 165	DETECTOR FUNCTION	Quasi-Peak (QP)
FREQUENCY RANGE	9kHz ~ 1GHz		

ANTENNA POLARITY & TEST DISTANCE: HORIZONTAL AT 3 M

NO.	FREQ. (MHz)	EMISSION LEVEL (dBuV/m)	LIMIT (dBuV/m)	MARGIN (dB)	ANTENNA HEIGHT (m)	TABLE ANGLE (Degree)	RAW VALUE (dBuV)	CORRECTION FACTOR (dB/m)
1	95.31	35.2 QP	43.5	-8.3	2.00 H	224	48.6	-13.4
2	250.71	39.4 QP	46.0	-6.6	1.43 H	179	48.9	-9.5
3	281.18	38.1 QP	46.0	-7.9	1.50 H	303	46.1	-8.0
4	415.70	35.3 QP	46.0	-10.7	1.46 H	159	40.0	-4.7
5	499.96	36.4 QP	46.0	-9.6	1.50 H	226	39.1	-2.7
6	665.45	30.3 QP	46.0	-15.7	1.26 H	159	29.8	0.5

ANTENNA POLARITY & TEST DISTANCE: VERTICAL AT 3 M

NO.	FREQ. (MHz)	EMISSION LEVEL (dBuV/m)	LIMIT (dBuV/m)	MARGIN (dB)	ANTENNA HEIGHT (m)	TABLE ANGLE (Degree)	RAW VALUE (dBuV)	CORRECTION FACTOR (dB/m)
1	37.50	33.5 QP	40.0	-6.5	1.06 V	289	42.6	-9.1
2	65.24	34.4 QP	40.0	-5.6	1.00 V	226	44.3	-9.9
3	110.15	35.8 QP	43.5	-7.7	1.50 V	326	47.0	-11.2
4	255.46	34.3 QP	46.0	-11.7	1.00 V	229	43.6	-9.3
5	500.01	33.7 QP	46.0	-12.3	1.00 V	226	36.3	-2.6
6	941.22	33.6 QP	46.0	-12.4	1.50 V	118	28.9	4.7

REMARKS:

1. Emission Level(dBuV/m) = Raw Value(dBuV) + Correction Factor(dB/m)
2. Correction Factor(dB/m) = Antenna Factor(dB/m) + Cable Factor(dB) – Pre-Amplifier Factor(dB)
3. The other emission levels were very low against the limit.
4. Margin value = Emission Level – Limit value

4.1.8 Test Results (Mode 2)

Above 1GHz Data:

802.11a

CHANNEL	TX Channel 36	DETECTOR FUNCTION	Peak (PK)
FREQUENCY RANGE	1GHz ~ 40GHz		Average (AV)

ANTENNA POLARITY & TEST DISTANCE: HORIZONTAL AT 3 M								
NO.	FREQ. (MHz)	EMISSION LEVEL (dBuV/m)	LIMIT (dBuV/m)	MARGIN (dB)	ANTENNA HEIGHT (m)	TABLE ANGLE (Degree)	RAW VALUE (dBuV)	CORRECTION FACTOR (dB/m)
1	5146.00	67.5 PK	74.0	-6.5	2.97 H	86	63.9	3.6
2	5146.00	53.2 AV	54.0	-0.8	2.97 H	86	49.6	3.6
3	*5180.00	120.3 PK			2.97 H	86	116.6	3.7
4	*5180.00	110.3 AV			2.97 H	86	106.6	3.7
5	#10360.00	47.1 PK	74.0	-26.9	1.71 H	185	34.1	13.0
6	#10360.00	33.5 AV	54.0	-20.5	1.71 H	185	20.5	13.0
7	15540.00	46.2 PK	74.0	-27.8	2.08 H	296	33.1	13.1
8	15540.00	33.9 AV	54.0	-20.1	2.08 H	296	20.8	13.1

ANTENNA POLARITY & TEST DISTANCE: VERTICAL AT 3 M								
NO.	FREQ. (MHz)	EMISSION LEVEL (dBuV/m)	LIMIT (dBuV/m)	MARGIN (dB)	ANTENNA HEIGHT (m)	TABLE ANGLE (Degree)	RAW VALUE (dBuV)	CORRECTION FACTOR (dB/m)
1	5146.00	52.7 PK	74.0	-21.3	2.64 V	246	49.1	3.6
2	5146.00	41.3 AV	54.0	-12.7	2.64 V	246	37.7	3.6
3	*5180.00	108.4 PK			2.64 V	246	104.7	3.7
4	*5180.00	98.8 AV			2.64 V	246	95.1	3.7
5	#10360.00	47.0 PK	74.0	-27.0	1.59 V	302	34.0	13.0
6	#10360.00	33.4 AV	54.0	-20.6	1.59 V	302	20.4	13.0
7	15540.00	42.3 PK	74.0	-31.7	1.35 V	217	29.2	13.1
8	15540.00	31.9 AV	54.0	-22.1	1.35 V	217	18.8	13.1

REMARKS:

- Emission Level(dBuV/m) = Raw Value(dBuV) + Correction Factor(dB/m)
- Correction Factor(dB/m) = Antenna Factor(dB/m) + Cable Factor(dB) – Pre-Amplifier Factor(dB)
- The other emission levels were very low against the limit.
- Margin value = Emission Level – Limit value
- " * ": Fundamental frequency.
- " # ": The radiated frequency is out of the restricted band.

CHANNEL	TX Channel 40	DETECTOR FUNCTION	Peak (PK)
FREQUENCY RANGE	1GHz ~ 40GHz		Average (AV)

ANTENNA POLARITY & TEST DISTANCE: HORIZONTAL AT 3 M

NO.	FREQ. (MHz)	EMISSION LEVEL (dBuV/m)	LIMIT (dBuV/m)	MARGIN (dB)	ANTENNA HEIGHT (m)	TABLE ANGLE (Degree)	RAW VALUE (dBuV)	CORRECTION FACTOR (dB/m)
1	5148.00	65.6 PK	74.0	-8.4	2.64 H	101	62.0	3.6
2	5148.00	50.7 AV	54.0	-3.3	2.64 H	101	47.1	3.6
3	*5200.00	120.7 PK			2.64 H	101	117.0	3.7
4	*5200.00	110.6 AV			2.64 H	101	106.9	3.7
5	#10400.00	46.9 PK	74.0	-27.1	1.76 H	179	33.9	13.0
6	#10400.00	33.6 AV	54.0	-20.4	1.76 H	179	20.6	13.0
7	15600.00	46.2 PK	74.0	-27.8	2.13 H	308	32.9	13.3
8	15600.00	33.7 AV	54.0	-20.3	2.13 H	308	20.4	13.3

ANTENNA POLARITY & TEST DISTANCE: VERTICAL AT 3 M

NO.	FREQ. (MHz)	EMISSION LEVEL (dBuV/m)	LIMIT (dBuV/m)	MARGIN (dB)	ANTENNA HEIGHT (m)	TABLE ANGLE (Degree)	RAW VALUE (dBuV)	CORRECTION FACTOR (dB/m)
1	5148.00	50.5 PK	74.0	-23.5	2.64 V	256	46.9	3.6
2	5148.00	38.9 AV	54.0	-15.1	2.64 V	256	35.3	3.6
3	*5200.00	115.8 PK			2.64 V	256	112.1	3.7
4	*5200.00	100.5 AV			2.64 V	256	96.8	3.7
5	#10400.00	46.8 PK	74.0	-27.2	1.55 V	288	33.8	13.0
6	#10400.00	33.5 AV	54.0	-20.5	1.55 V	288	20.5	13.0
7	15600.00	42.1 PK	74.0	-31.9	1.34 V	211	28.8	13.3
8	15600.00	31.8 AV	54.0	-22.2	1.34 V	211	18.5	13.3

REMARKS:

1. Emission Level(dBuV/m) = Raw Value(dBuV) + Correction Factor(dB/m)
2. Correction Factor(dB/m) = Antenna Factor(dB/m) + Cable Factor(dB) – Pre-Amplifier Factor(dB)
3. The other emission levels were very low against the limit.
4. Margin value = Emission Level – Limit value
5. " * ": Fundamental frequency.
6. " # ": The radiated frequency is out of the restricted band.

CHANNEL	TX Channel 48	DETECTOR FUNCTION	Peak (PK)
FREQUENCY RANGE	1GHz ~ 40GHz		Average (AV)

ANTENNA POLARITY & TEST DISTANCE: HORIZONTAL AT 3 M

NO.	FREQ. (MHz)	EMISSION LEVEL (dBuV/m)	LIMIT (dBuV/m)	MARGIN (dB)	ANTENNA HEIGHT (m)	TABLE ANGLE (Degree)	RAW VALUE (dBuV)	CORRECTION FACTOR (dB/m)
1	*5240.00	122.2 PK			3.54 H	85	118.4	3.8
2	*5240.00	111.7 AV			3.54 H	85	107.9	3.8
3	5350.00	49.5 PK	74.0	-24.5	3.54 H	85	45.4	4.1
4	5350.00	37.5 AV	54.0	-16.5	3.54 H	85	33.4	4.1
5	#10480.00	46.8 PK	74.0	-27.2	1.79 H	163	33.6	13.2
6	#10480.00	33.5 AV	54.0	-20.5	1.79 H	163	20.3	13.2
7	15720.00	45.8 PK	74.0	-28.2	2.12 H	319	32.2	13.6
8	15720.00	33.3 AV	54.0	-20.7	2.12 H	319	19.7	13.6

ANTENNA POLARITY & TEST DISTANCE: VERTICAL AT 3 M

NO.	FREQ. (MHz)	EMISSION LEVEL (dBuV/m)	LIMIT (dBuV/m)	MARGIN (dB)	ANTENNA HEIGHT (m)	TABLE ANGLE (Degree)	RAW VALUE (dBuV)	CORRECTION FACTOR (dB/m)
1	*5240.00	112.1 PK			2.60 V	247	108.3	3.8
2	*5240.00	101.7 AV			2.60 V	247	97.9	3.8
3	5350.00	47.8 PK	74.0	-26.2	2.60 V	247	43.7	4.1
4	5350.00	35.3 AV	54.0	-18.7	2.60 V	247	31.2	4.1
5	#10480.00	46.7 PK	74.0	-27.3	1.55 V	300	33.5	13.2
6	#10480.00	33.2 AV	54.0	-20.8	1.55 V	300	20.0	13.2
7	15720.00	42.1 PK	74.0	-31.9	1.35 V	220	28.5	13.6
8	15720.00	31.4 AV	54.0	-22.6	1.35 V	220	17.8	13.6

REMARKS:

1. Emission Level(dBuV/m) = Raw Value(dBuV) + Correction Factor(dB/m)
2. Correction Factor(dB/m) = Antenna Factor(dB/m) + Cable Factor(dB) – Pre-Amplifier Factor(dB)
3. The other emission levels were very low against the limit.
4. Margin value = Emission Level – Limit value
5. " * ": Fundamental frequency.
6. " # ": The radiated frequency is out of the restricted band.

CHANNEL	TX Channel 149	DETECTOR FUNCTION	Peak (PK)
FREQUENCY RANGE	1GHz ~ 40GHz		Average (AV)

ANTENNA POLARITY & TEST DISTANCE: HORIZONTAL AT 3 M

NO.	FREQ. (MHz)	EMISSION LEVEL (dBuV/m)	LIMIT (dBuV/m)	MARGIN (dB)	ANTENNA HEIGHT (m)	TABLE ANGLE (Degree)	RAW VALUE (dBuV)	CORRECTION FACTOR (dB/m)
1	#5613.60	59.6 PK	68.2	-8.6	2.86 H	93	55.2	4.4
2	*5745.00	123.7 PK			2.86 H	93	119.3	4.4
3	*5745.00	113.0 AV			2.86 H	93	108.6	4.4
4	#5964.52	59.8 PK	68.2	-8.4	2.86 H	93	55.1	4.7
5	11490.00	46.8 PK	74.0	-27.2	1.79 H	185	33.3	13.5
6	11490.00	33.2 AV	54.0	-20.8	1.79 H	185	19.7	13.5
7	#17235.00	46.8 PK	74.0	-27.2	2.18 H	308	29.5	17.3
8	#17235.00	34.1 AV	54.0	-19.9	2.18 H	308	16.8	17.3

ANTENNA POLARITY & TEST DISTANCE: VERTICAL AT 3 M

NO.	FREQ. (MHz)	EMISSION LEVEL (dBuV/m)	LIMIT (dBuV/m)	MARGIN (dB)	ANTENNA HEIGHT (m)	TABLE ANGLE (Degree)	RAW VALUE (dBuV)	CORRECTION FACTOR (dB/m)
1	#5569.97	58.0 PK	68.2	-10.2	2.53 V	5	53.8	4.2
2	*5745.00	109.9 PK			2.53 V	5	105.5	4.4
3	*5745.00	99.6 AV			2.53 V	5	95.2	4.4
4	#5969.35	59.9 PK	68.2	-8.3	2.53 V	5	55.2	4.7
5	11490.00	46.6 PK	74.0	-27.4	1.58 V	307	33.1	13.5
6	11490.00	33.0 AV	54.0	-21.0	1.58 V	307	19.5	13.5
7	#17235.00	42.7 PK	74.0	-31.3	1.40 V	235	25.4	17.3
8	#17235.00	32.2 AV	54.0	-21.8	1.40 V	235	14.9	17.3

REMARKS:

1. Emission Level(dBuV/m) = Raw Value(dBuV) + Correction Factor(dB/m)
2. Correction Factor(dB/m) = Antenna Factor(dB/m) + Cable Factor(dB) – Pre-Amplifier Factor(dB)
3. The other emission levels were very low against the limit.
4. Margin value = Emission Level – Limit value
5. " * ": Fundamental frequency.
6. " # ": The radiated frequency is out of the restricted band.

CHANNEL	TX Channel 157	DETECTOR FUNCTION	Peak (PK)
FREQUENCY RANGE	1GHz ~ 40GHz		Average (AV)

ANTENNA POLARITY & TEST DISTANCE: HORIZONTAL AT 3 M

NO.	FREQ. (MHz)	EMISSION LEVEL (dBuV/m)	LIMIT (dBuV/m)	MARGIN (dB)	ANTENNA HEIGHT (m)	TABLE ANGLE (Degree)	RAW VALUE (dBuV)	CORRECTION FACTOR (dB/m)
1	#5612.84	59.2 PK	68.2	-9.0	2.46 H	92	54.8	4.4
2	*5785.00	122.0 PK			2.46 H	92	117.6	4.4
3	*5785.00	112.5 AV			2.46 H	92	108.1	4.4
4	#5937.42	59.4 PK	68.2	-8.8	2.46 H	92	54.7	4.7
5	11570.00	46.6 PK	74.0	-27.4	1.77 H	191	33.1	13.5
6	11570.00	33.2 AV	54.0	-20.8	1.77 H	191	19.7	13.5
7	#17355.00	45.7 PK	74.0	-28.3	2.17 H	323	27.7	18.0
8	#17355.00	33.4 AV	54.0	-20.6	2.17 H	323	15.4	18.0

ANTENNA POLARITY & TEST DISTANCE: VERTICAL AT 3 M

NO.	FREQ. (MHz)	EMISSION LEVEL (dBuV/m)	LIMIT (dBuV/m)	MARGIN (dB)	ANTENNA HEIGHT (m)	TABLE ANGLE (Degree)	RAW VALUE (dBuV)	CORRECTION FACTOR (dB/m)
1	#5593.40	57.8 PK	68.2	-10.4	2.50 V	13	53.5	4.3
2	*5785.00	110.4 PK			2.50 V	13	106.0	4.4
3	*5785.00	100.1 AV			2.50 V	13	95.7	4.4
4	#5939.99	59.4 PK	68.2	-8.8	2.50 V	13	54.7	4.7
5	11570.00	46.5 PK	74.0	-27.5	1.56 V	312	33.0	13.5
6	11570.00	33.1 AV	54.0	-20.9	1.56 V	312	19.6	13.5
7	#17355.00	41.8 PK	74.0	-32.2	1.38 V	217	23.8	18.0
8	#17355.00	31.6 AV	54.0	-22.4	1.38 V	217	13.6	18.0

REMARKS:

1. Emission Level(dBuV/m) = Raw Value(dBuV) + Correction Factor(dB/m)
2. Correction Factor(dB/m) = Antenna Factor(dB/m) + Cable Factor(dB) – Pre-Amplifier Factor(dB)
3. The other emission levels were very low against the limit.
4. Margin value = Emission Level – Limit value
5. " * ": Fundamental frequency.
6. " # ": The radiated frequency is out of the restricted band.

CHANNEL	TX Channel 165	DETECTOR FUNCTION	Peak (PK)
FREQUENCY RANGE	1GHz ~ 40GHz		Average (AV)

ANTENNA POLARITY & TEST DISTANCE: HORIZONTAL AT 3 M

NO.	FREQ. (MHz)	EMISSION LEVEL (dBuV/m)	LIMIT (dBuV/m)	MARGIN (dB)	ANTENNA HEIGHT (m)	TABLE ANGLE (Degree)	RAW VALUE (dBuV)	CORRECTION FACTOR (dB/m)
1	#5616.64	58.3 PK	68.2	-9.9	2.34 H	95	53.9	4.4
2	*5825.00	121.8 PK			2.34 H	95	117.4	4.4
3	*5825.00	112.0 AV			2.34 H	95	107.6	4.4
4	#5970.51	58.2 PK	68.2	-10.0	2.34 H	95	53.5	4.7
5	11650.00	47.0 PK	74.0	-27.0	1.80 H	171	33.3	13.7
6	11650.00	33.5 AV	54.0	-20.5	1.80 H	171	19.8	13.7
7	#17475.00	46.4 PK	74.0	-27.6	2.09 H	308	27.8	18.6
8	#17475.00	33.8 AV	54.0	-20.2	2.09 H	308	15.2	18.6

ANTENNA POLARITY & TEST DISTANCE: VERTICAL AT 3 M

NO.	FREQ. (MHz)	EMISSION LEVEL (dBuV/m)	LIMIT (dBuV/m)	MARGIN (dB)	ANTENNA HEIGHT (m)	TABLE ANGLE (Degree)	RAW VALUE (dBuV)	CORRECTION FACTOR (dB/m)
1	#5594.27	58.5 PK	68.2	-9.7	2.46 V	7	54.2	4.3
2	*5825.00	111.0 PK			2.46 V	7	106.6	4.4
3	*5825.00	100.5 AV			2.46 V	7	96.1	4.4
4	#5989.97	59.8 PK	68.2	-8.4	2.46 V	7	55.1	4.7
5	11650.00	46.8 PK	74.0	-27.2	1.52 V	321	33.1	13.7
6	11650.00	33.3 AV	54.0	-20.7	1.52 V	321	19.6	13.7
7	#17475.00	42.5 PK	74.0	-31.5	1.40 V	232	23.9	18.6
8	#17475.00	31.9 AV	54.0	-22.1	1.40 V	232	13.3	18.6

REMARKS:

1. Emission Level(dBuV/m) = Raw Value(dBuV) + Correction Factor(dB/m)
2. Correction Factor(dB/m) = Antenna Factor(dB/m) + Cable Factor(dB) – Pre-Amplifier Factor(dB)
3. The other emission levels were very low against the limit.
4. Margin value = Emission Level – Limit value
5. " * ": Fundamental frequency.
6. " # ": The radiated frequency is out of the restricted band.

802.11ac (VHT20)

CHANNEL	TX Channel 36	DETECTOR FUNCTION	Peak (PK)
FREQUENCY RANGE	1GHz ~ 40GHz		Average (AV)

ANTENNA POLARITY & TEST DISTANCE: HORIZONTAL AT 3 M

NO.	FREQ. (MHz)	EMISSION LEVEL (dBuV/m)	LIMIT (dBuV/m)	MARGIN (dB)	ANTENNA HEIGHT (m)	TABLE ANGLE (Degree)	RAW VALUE (dBuV)	CORRECTION FACTOR (dB/m)
1	5150.00	66.2 PK	74.0	-7.8	3.00 H	105	62.5	3.7
2	5150.00	53.4 AV	54.0	-0.6	3.00 H	105	49.7	3.7
3	*5180.00	120.8 PK			3.00 H	105	117.1	3.7
4	*5180.00	110.2 AV			3.00 H	105	106.5	3.7
5	#10360.00	46.8 PK	74.0	-27.2	1.82 H	204	33.8	13.0
6	#10360.00	33.2 AV	54.0	-20.8	1.82 H	204	20.2	13.0
7	15540.00	46.0 PK	74.0	-28.0	2.17 H	328	32.9	13.1
8	15540.00	33.7 AV	54.0	-20.3	2.17 H	328	20.6	13.1

ANTENNA POLARITY & TEST DISTANCE: VERTICAL AT 3 M

NO.	FREQ. (MHz)	EMISSION LEVEL (dBuV/m)	LIMIT (dBuV/m)	MARGIN (dB)	ANTENNA HEIGHT (m)	TABLE ANGLE (Degree)	RAW VALUE (dBuV)	CORRECTION FACTOR (dB/m)
1	5150.00	51.3 PK	74.0	-22.7	2.56 V	232	47.6	3.7
2	5150.00	41.5 AV	54.0	-12.5	2.56 V	232	37.8	3.7
3	*5180.00	105.9 PK			2.56 V	232	102.2	3.7
4	*5180.00	95.3 AV			2.56 V	232	91.6	3.7
5	#10360.00	46.6 PK	74.0	-27.4	1.53 V	295	33.6	13.0
6	#10360.00	33.1 AV	54.0	-20.9	1.53 V	295	20.1	13.0
7	15540.00	44.8 PK	74.0	-29.2	1.38 V	227	31.7	13.1
8	15540.00	31.6 AV	54.0	-22.4	1.38 V	227	18.5	13.1

REMARKS:

- Emission Level(dBuV/m) = Raw Value(dBuV) + Correction Factor(dB/m)
- Correction Factor(dB/m) = Antenna Factor(dB/m) + Cable Factor(dB) – Pre-Amplifier Factor(dB)
- The other emission levels were very low against the limit.
- Margin value = Emission Level – Limit value
- " * ": Fundamental frequency.
- " # ": The radiated frequency is out of the restricted band.

CHANNEL	TX Channel 40	DETECTOR FUNCTION	Peak (PK)
FREQUENCY RANGE	1GHz ~ 40GHz		Average (AV)

ANTENNA POLARITY & TEST DISTANCE: HORIZONTAL AT 3 M

NO.	FREQ. (MHz)	EMISSION LEVEL (dBuV/m)	LIMIT (dBuV/m)	MARGIN (dB)	ANTENNA HEIGHT (m)	TABLE ANGLE (Degree)	RAW VALUE (dBuV)	CORRECTION FACTOR (dB/m)
1	5150.00	61.7 PK	74.0	-12.3	2.72 H	103	58.0	3.7
2	5150.00	49.0 AV	54.0	-5.0	2.72 H	103	45.3	3.7
3	*5200.00	120.1 PK			2.72 H	103	116.4	3.7
4	*5200.00	109.6 AV			2.72 H	103	105.9	3.7
5	#10400.00	47.2 PK	74.0	-26.8	1.82 H	196	34.2	13.0
6	#10400.00	33.7 AV	54.0	-20.3	1.82 H	196	20.7	13.0
7	15600.00	46.3 PK	74.0	-27.7	2.20 H	312	33.0	13.3
8	15600.00	33.9 AV	54.0	-20.1	2.20 H	312	20.6	13.3

ANTENNA POLARITY & TEST DISTANCE: VERTICAL AT 3 M

NO.	FREQ. (MHz)	EMISSION LEVEL (dBuV/m)	LIMIT (dBuV/m)	MARGIN (dB)	ANTENNA HEIGHT (m)	TABLE ANGLE (Degree)	RAW VALUE (dBuV)	CORRECTION FACTOR (dB/m)
1	5150.00	49.9 PK	74.0	-24.1	2.60 V	232	46.2	3.7
2	5150.00	37.8 AV	54.0	-16.2	2.60 V	232	34.1	3.7
3	*5200.00	107.8 PK			2.60 V	232	104.1	3.7
4	*5200.00	97.3 AV			2.60 V	232	93.6	3.7
5	#10400.00	47.1 PK	74.0	-26.9	1.60 V	302	34.1	13.0
6	#10400.00	33.6 AV	54.0	-20.4	1.60 V	302	20.6	13.0
7	15600.00	43.5 PK	74.0	-30.5	1.41 V	227	30.2	13.3
8	15600.00	31.8 AV	54.0	-22.2	1.41 V	227	18.5	13.3

REMARKS:

- Emission Level(dBuV/m) = Raw Value(dBuV) + Correction Factor(dB/m)
- Correction Factor(dB/m) = Antenna Factor(dB/m) + Cable Factor(dB) – Pre-Amplifier Factor(dB)
- The other emission levels were very low against the limit.
- Margin value = Emission Level – Limit value
- " * ": Fundamental frequency.
- " # ": The radiated frequency is out of the restricted band.

CHANNEL	TX Channel 48	DETECTOR FUNCTION	Peak (PK)
FREQUENCY RANGE	1GHz ~ 40GHz		Average (AV)

ANTENNA POLARITY & TEST DISTANCE: HORIZONTAL AT 3 M

NO.	FREQ. (MHz)	EMISSION LEVEL (dBuV/m)	LIMIT (dBuV/m)	MARGIN (dB)	ANTENNA HEIGHT (m)	TABLE ANGLE (Degree)	RAW VALUE (dBuV)	CORRECTION FACTOR (dB/m)
1	*5240.00	120.3 PK			2.71 H	106	116.5	3.8
2	*5240.00	109.6 AV			2.71 H	106	105.8	3.8
3	5350.00	48.9 PK	74.0	-25.1	2.71 H	106	44.8	4.1
4	5350.00	36.7 AV	54.0	-17.3	2.71 H	106	32.6	4.1
5	#10480.00	47.2 PK	74.0	-26.8	1.75 H	204	34.0	13.2
6	#10480.00	33.6 AV	54.0	-20.4	1.75 H	204	20.4	13.2
7	15720.00	45.2 PK	74.0	-28.8	2.19 H	321	31.6	13.6
8	15720.00	33.1 AV	54.0	-20.9	2.19 H	321	19.5	13.6

ANTENNA POLARITY & TEST DISTANCE: VERTICAL AT 3 M

NO.	FREQ. (MHz)	EMISSION LEVEL (dBuV/m)	LIMIT (dBuV/m)	MARGIN (dB)	ANTENNA HEIGHT (m)	TABLE ANGLE (Degree)	RAW VALUE (dBuV)	CORRECTION FACTOR (dB/m)
1	*5240.00	105.4 PK			2.59 V	244	101.6	3.8
2	*5240.00	94.2 AV			2.59 V	244	90.4	3.8
3	5350.00	46.7 PK	74.0	-27.3	2.59 V	244	42.6	4.1
4	5350.00	34.8 AV	54.0	-19.2	2.59 V	244	30.7	4.1
5	#10480.00	47.1 PK	74.0	-26.9	1.57 V	290	33.9	13.2
6	#10480.00	33.5 AV	54.0	-20.5	1.57 V	290	20.3	13.2
7	15720.00	43.3 PK	74.0	-30.7	1.31 V	226	29.7	13.6
8	15720.00	31.2 AV	54.0	-22.8	1.31 V	226	17.6	13.6

REMARKS:

1. Emission Level(dBuV/m) = Raw Value(dBuV) + Correction Factor(dB/m)
2. Correction Factor(dB/m) = Antenna Factor(dB/m) + Cable Factor(dB) – Pre-Amplifier Factor(dB)
3. The other emission levels were very low against the limit.
4. Margin value = Emission Level – Limit value
5. " * ": Fundamental frequency.
6. " # ": The radiated frequency is out of the restricted band.

CHANNEL	TX Channel 149	DETECTOR FUNCTION	Peak (PK)
FREQUENCY RANGE	1GHz ~ 40GHz		Average (AV)

ANTENNA POLARITY & TEST DISTANCE: HORIZONTAL AT 3 M

NO.	FREQ. (MHz)	EMISSION LEVEL (dBuV/m)	LIMIT (dBuV/m)	MARGIN (dB)	ANTENNA HEIGHT (m)	TABLE ANGLE (Degree)	RAW VALUE (dBuV)	CORRECTION FACTOR (dB/m)
1	#5613.27	58.9 PK	68.2	-9.3	2.38 H	93	54.5	4.4
2	*5745.00	123.7 PK			2.38 H	93	119.3	4.4
3	*5745.00	112.5 AV			2.38 H	93	108.1	4.4
4	#5939.84	59.2 PK	68.2	-9.0	2.38 H	93	54.5	4.7
5	11490.00	46.3 PK	74.0	-27.7	1.75 H	179	32.8	13.5
6	11490.00	33.2 AV	54.0	-20.8	1.75 H	179	19.7	13.5
7	#17235.00	45.3 PK	74.0	-28.7	2.14 H	336	28.0	17.3
8	#17235.00	33.2 AV	54.0	-20.8	2.14 H	336	15.9	17.3

ANTENNA POLARITY & TEST DISTANCE: VERTICAL AT 3 M

NO.	FREQ. (MHz)	EMISSION LEVEL (dBuV/m)	LIMIT (dBuV/m)	MARGIN (dB)	ANTENNA HEIGHT (m)	TABLE ANGLE (Degree)	RAW VALUE (dBuV)	CORRECTION FACTOR (dB/m)
1	#5594.85	58.9 PK	68.2	-9.3	3.83 V	29	54.6	4.3
2	*5745.00	110.2 PK			3.31 V	29	105.8	4.4
3	*5745.00	99.8 AV			3.31 V	29	95.4	4.4
4	#5974.09	59.0 PK	68.2	-9.2	3.83 V	29	54.3	4.7
5	11490.00	46.2 PK	74.0	-27.8	1.58 V	282	32.7	13.5
6	11490.00	33.1 AV	54.0	-20.9	1.58 V	282	19.6	13.5
7	#17235.00	43.3 PK	74.0	-30.7	1.31 V	222	26.0	17.3
8	#17235.00	31.7 AV	54.0	-22.3	1.31 V	222	14.4	17.3

REMARKS:

1. Emission Level(dBuV/m) = Raw Value(dBuV) + Correction Factor(dB/m)
2. Correction Factor(dB/m) = Antenna Factor(dB/m) + Cable Factor(dB) – Pre-Amplifier Factor(dB)
3. The other emission levels were very low against the limit.
4. Margin value = Emission Level – Limit value
5. " * ": Fundamental frequency.
6. " # ": The radiated frequency is out of the restricted band.

CHANNEL	TX Channel 157	DETECTOR FUNCTION	Peak (PK)
FREQUENCY RANGE	1GHz ~ 40GHz		Average (AV)

ANTENNA POLARITY & TEST DISTANCE: HORIZONTAL AT 3 M

NO.	FREQ. (MHz)	EMISSION LEVEL (dBuV/m)	LIMIT (dBuV/m)	MARGIN (dB)	ANTENNA HEIGHT (m)	TABLE ANGLE (Degree)	RAW VALUE (dBuV)	CORRECTION FACTOR (dB/m)
1	#5637.13	58.1 PK	68.2	-10.1	2.36 H	91	53.7	4.4
2	*5785.00	121.9 PK			2.36 H	91	117.5	4.4
3	*5785.00	111.2 AV			2.36 H	91	106.8	4.4
4	#5948.49	58.4 PK	68.2	-9.8	2.36 H	91	53.7	4.7
5	11570.00	46.9 PK	74.0	-27.1	1.77 H	175	33.4	13.5
6	11570.00	33.4 AV	54.0	-20.6	1.77 H	175	19.9	13.5
7	#17355.00	45.4 PK	74.0	-28.6	2.12 H	316	27.4	18.0
8	#17355.00	33.3 AV	54.0	-20.7	2.12 H	316	15.3	18.0

ANTENNA POLARITY & TEST DISTANCE: VERTICAL AT 3 M

NO.	FREQ. (MHz)	EMISSION LEVEL (dBuV/m)	LIMIT (dBuV/m)	MARGIN (dB)	ANTENNA HEIGHT (m)	TABLE ANGLE (Degree)	RAW VALUE (dBuV)	CORRECTION FACTOR (dB/m)
1	#5611.33	58.1 PK	68.2	-10.1	3.80 V	19	53.7	4.4
2	*5785.00	110.3 PK			3.80 V	19	105.9	4.4
3	*5785.00	99.8 AV			3.80 V	19	95.4	4.4
4	#6016.40	59.2 PK	68.2	-9.0	3.80 V	19	54.4	4.8
5	11570.00	46.8 PK	74.0	-27.2	1.61 V	282	33.3	13.5
6	11570.00	33.2 AV	54.0	-20.8	1.61 V	282	19.7	13.5
7	#17355.00	43.5 PK	74.0	-30.5	1.31 V	238	25.5	18.0
8	#17355.00	31.4 AV	54.0	-22.6	1.31 V	238	13.4	18.0

REMARKS:

1. Emission Level(dBuV/m) = Raw Value(dBuV) + Correction Factor(dB/m)
2. Correction Factor(dB/m) = Antenna Factor(dB/m) + Cable Factor(dB) – Pre-Amplifier Factor(dB)
3. The other emission levels were very low against the limit.
4. Margin value = Emission Level – Limit value
5. " * ": Fundamental frequency.
6. " # ": The radiated frequency is out of the restricted band.

CHANNEL	TX Channel 165	DETECTOR FUNCTION	Peak (PK)
FREQUENCY RANGE	1GHz ~ 40GHz		Average (AV)

ANTENNA POLARITY & TEST DISTANCE: HORIZONTAL AT 3 M

NO.	FREQ. (MHz)	EMISSION LEVEL (dBuV/m)	LIMIT (dBuV/m)	MARGIN (dB)	ANTENNA HEIGHT (m)	TABLE ANGLE (Degree)	RAW VALUE (dBuV)	CORRECTION FACTOR (dB/m)
1	#5614.62	57.6 PK	68.2	-10.6	2.97 H	91	53.2	4.4
2	*5825.00	121.3 PK			2.97 H	93	116.9	4.4
3	*5825.00	110.2 AV			2.97 H	93	105.8	4.4
4	#5935.69	59.4 PK	68.2	-8.8	2.97 H	91	54.7	4.7
5	11650.00	47.2 PK	74.0	-26.8	1.72 H	195	33.5	13.7
6	11650.00	33.6 AV	54.0	-20.4	1.72 H	195	19.9	13.7
7	#17475.00	45.8 PK	74.0	-28.2	2.21 H	324	27.2	18.6
8	#17475.00	33.6 AV	54.0	-20.4	2.21 H	324	15.0	18.6

ANTENNA POLARITY & TEST DISTANCE: VERTICAL AT 3 M

NO.	FREQ. (MHz)	EMISSION LEVEL (dBuV/m)	LIMIT (dBuV/m)	MARGIN (dB)	ANTENNA HEIGHT (m)	TABLE ANGLE (Degree)	RAW VALUE (dBuV)	CORRECTION FACTOR (dB/m)
1	#5634.34	57.6 PK	68.2	-10.6	3.87 V	14	53.2	4.4
2	*5825.00	109.8 PK			3.45 V	14	105.4	4.4
3	*5825.00	98.9 AV			3.45 V	14	94.5	4.4
4	#5983.76	60.4 PK	68.2	-7.8	3.87 V	14	55.7	4.7
5	11650.00	47.0 PK	74.0	-27.0	1.52 V	291	33.3	13.7
6	11650.00	33.5 AV	54.0	-20.5	1.52 V	291	19.8	13.7
7	#17475.00	43.9 PK	74.0	-30.1	1.27 V	226	25.3	18.6
8	#17475.00	31.7 AV	54.0	-22.3	1.27 V	226	13.1	18.6

REMARKS:

1. Emission Level(dBuV/m) = Raw Value(dBuV) + Correction Factor(dB/m)
2. Correction Factor(dB/m) = Antenna Factor(dB/m) + Cable Factor(dB) – Pre-Amplifier Factor(dB)
3. The other emission levels were very low against the limit.
4. Margin value = Emission Level – Limit value
5. " * ": Fundamental frequency.
6. " # ": The radiated frequency is out of the restricted band.

802.11ac (VHT40)

CHANNEL	TX Channel 38	DETECTOR FUNCTION	Peak (PK)
FREQUENCY RANGE	1GHz ~ 40GHz		Average (AV)

ANTENNA POLARITY & TEST DISTANCE: HORIZONTAL AT 3 M								
NO.	FREQ. (MHz)	EMISSION LEVEL (dBuV/m)	LIMIT (dBuV/m)	MARGIN (dB)	ANTENNA HEIGHT (m)	TABLE ANGLE (Degree)	RAW VALUE (dBuV)	CORRECTION FACTOR (dB/m)
1	5144.70	66.7 PK	74.0	-7.3	3.02 H	100	63.1	3.6
2	5144.70	53.5 AV	54.0	-0.5	3.02 H	100	49.9	3.6
3	*5190.00	111.0 PK			3.02 H	100	107.3	3.7
4	*5190.00	102.2 AV			3.02 H	100	98.5	3.7
5	#10380.00	47.3 PK	74.0	-26.7	1.73 H	200	34.2	13.1
6	#10380.00	33.9 AV	54.0	-20.1	1.73 H	200	20.8	13.1
7	15570.00	45.0 PK	74.0	-29.0	2.26 H	333	31.7	13.3
8	15570.00	33.1 AV	54.0	-20.9	2.26 H	333	19.8	13.3

ANTENNA POLARITY & TEST DISTANCE: VERTICAL AT 3 M								
NO.	FREQ. (MHz)	EMISSION LEVEL (dBuV/m)	LIMIT (dBuV/m)	MARGIN (dB)	ANTENNA HEIGHT (m)	TABLE ANGLE (Degree)	RAW VALUE (dBuV)	CORRECTION FACTOR (dB/m)
1	5144.70	53.0 PK	74.0	-21.0	3.40 V	18	49.4	3.6
2	5144.70	41.5 AV	54.0	-12.5	3.40 V	18	37.9	3.6
3	*5190.00	97.2 PK			3.40 V	18	93.5	3.7
4	*5190.00	89.7 AV			3.40 V	18	86.0	3.7
5	#10380.00	47.1 PK	74.0	-26.9	1.51 V	281	34.0	13.1
6	#10380.00	33.6 AV	54.0	-20.4	1.51 V	281	20.5	13.1
7	15570.00	43.7 PK	74.0	-30.3	1.23 V	214	30.4	13.3
8	15570.00	31.5 AV	54.0	-22.5	1.23 V	214	18.2	13.3

REMARKS:

- Emission Level(dBuV/m) = Raw Value(dBuV) + Correction Factor(dB/m)
- Correction Factor(dB/m) = Antenna Factor(dB/m) + Cable Factor(dB) – Pre-Amplifier Factor(dB)
- The other emission levels were very low against the limit.
- Margin value = Emission Level – Limit value
- " * ": Fundamental frequency.
- " # ": The radiated frequency is out of the restricted band.

CHANNEL	TX Channel 46	DETECTOR FUNCTION	Peak (PK)
FREQUENCY RANGE	1GHz ~ 40GHz		Average (AV)

ANTENNA POLARITY & TEST DISTANCE: HORIZONTAL AT 3 M

NO.	FREQ. (MHz)	EMISSION LEVEL (dBuV/m)	LIMIT (dBuV/m)	MARGIN (dB)	ANTENNA HEIGHT (m)	TABLE ANGLE (Degree)	RAW VALUE (dBuV)	CORRECTION FACTOR (dB/m)
1	5141.70	65.4 PK	74.0	-8.6	3.36 H	94	61.8	3.6
2	5141.70	53.2 AV	54.0	-0.8	3.36 H	94	49.6	3.6
3	*5230.00	118.2 PK			3.36 H	94	114.4	3.8
4	*5230.00	108.7 AV			3.36 H	94	104.9	3.8
5	5350.00	50.0 PK	74.0	-24.0	3.36 H	94	45.9	4.1
6	5350.00	38.6 AV	54.0	-15.4	3.36 H	94	34.5	4.1
7	#10460.00	47.4 PK	74.0	-26.6	1.77 H	207	34.3	13.1
8	#10460.00	33.7 AV	54.0	-20.3	1.77 H	207	20.6	13.1
9	15690.00	46.1 PK	74.0	-27.9	2.23 H	309	32.3	13.8
10	15690.00	34.0 AV	54.0	-20.0	2.23 H	309	20.2	13.8

ANTENNA POLARITY & TEST DISTANCE: VERTICAL AT 3 M

NO.	FREQ. (MHz)	EMISSION LEVEL (dBuV/m)	LIMIT (dBuV/m)	MARGIN (dB)	ANTENNA HEIGHT (m)	TABLE ANGLE (Degree)	RAW VALUE (dBuV)	CORRECTION FACTOR (dB/m)
1	5141.70	51.3 PK	74.0	-22.7	3.39 V	3	47.7	3.6
2	5141.70	42.2 AV	54.0	-11.8	3.39 V	3	38.6	3.6
3	*5230.00	106.4 PK			3.39 V	3	102.6	3.8
4	*5230.00	96.1 AV			3.39 V	3	92.3	3.8
5	5350.00	48.0 PK	74.0	-26.0	3.39 V	3	43.9	4.1
6	5350.00	37.4 AV	54.0	-16.6	3.39 V	3	33.3	4.1
7	#10460.00	46.7 PK	74.0	-27.3	1.47 V	279	33.6	13.1
8	#10460.00	33.3 AV	54.0	-20.7	1.47 V	279	20.2	13.1
9	15690.00	43.5 PK	74.0	-30.5	1.26 V	213	29.7	13.8
10	15690.00	31.2 AV	54.0	-22.8	1.26 V	213	17.4	13.8

REMARKS:

- Emission Level(dBuV/m) = Raw Value(dBuV) + Correction Factor(dB/m)
- Correction Factor(dB/m) = Antenna Factor(dB/m) + Cable Factor(dB) – Pre-Amplifier Factor(dB)
- The other emission levels were very low against the limit.
- Margin value = Emission Level – Limit value
- " * ": Fundamental frequency.
- " # ": The radiated frequency is out of the restricted band.

CHANNEL	TX Channel 151	DETECTOR FUNCTION	Peak (PK)
FREQUENCY RANGE	1GHz ~ 40GHz		Average (AV)

ANTENNA POLARITY & TEST DISTANCE: HORIZONTAL AT 3 M

NO.	FREQ. (MHz)	EMISSION LEVEL (dBuV/m)	LIMIT (dBuV/m)	MARGIN (dB)	ANTENNA HEIGHT (m)	TABLE ANGLE (Degree)	RAW VALUE (dBuV)	CORRECTION FACTOR (dB/m)
1	#5647.35	64.8 PK	68.2	-3.4	2.74 H	93	60.4	4.4
2	*5755.00	119.7 PK			2.74 H	93	115.3	4.4
3	*5755.00	109.7 AV			2.74 H	93	105.3	4.4
4	#5942.34	59.8 PK	68.2	-8.4	2.74 H	93	55.1	4.7
5	11510.00	47.5 PK	74.0	-26.5	1.74 H	184	33.9	13.6
6	11510.00	34.1 AV	54.0	-19.9	1.74 H	184	20.5	13.6
7	#17265.00	46.3 PK	74.0	-27.7	2.23 H	320	28.7	17.6
8	#17265.00	34.5 AV	54.0	-19.5	2.23 H	320	16.9	17.6

ANTENNA POLARITY & TEST DISTANCE: VERTICAL AT 3 M

NO.	FREQ. (MHz)	EMISSION LEVEL (dBuV/m)	LIMIT (dBuV/m)	MARGIN (dB)	ANTENNA HEIGHT (m)	TABLE ANGLE (Degree)	RAW VALUE (dBuV)	CORRECTION FACTOR (dB/m)
1	#5571.73	59.3 PK	68.2	-8.9	2.38 V	14	55.1	4.2
2	*5755.00	107.2 PK			2.38 V	14	102.8	4.4
3	*5755.00	97.3 AV			2.38 V	14	92.9	4.4
4	#5953.88	58.7 PK	68.2	-9.5	2.38 V	14	54.0	4.7
5	11510.00	47.3 PK	74.0	-26.7	1.47 V	297	33.7	13.6
6	11510.00	33.9 AV	54.0	-20.1	1.47 V	297	20.3	13.6
7	#17265.00	43.8 PK	74.0	-30.2	1.25 V	217	26.2	17.6
8	#17265.00	31.4 AV	54.0	-22.6	1.25 V	217	13.8	17.6

REMARKS:

1. Emission Level(dBuV/m) = Raw Value(dBuV) + Correction Factor(dB/m)
2. Correction Factor(dB/m) = Antenna Factor(dB/m) + Cable Factor(dB) – Pre-Amplifier Factor(dB)
3. The other emission levels were very low against the limit.
4. Margin value = Emission Level – Limit value
5. " * ": Fundamental frequency.
6. " # ": The radiated frequency is out of the restricted band.

CHANNEL	TX Channel 159	DETECTOR FUNCTION	Peak (PK)
FREQUENCY RANGE	1GHz ~ 40GHz		Average (AV)

ANTENNA POLARITY & TEST DISTANCE: HORIZONTAL AT 3 M

NO.	FREQ. (MHz)	EMISSION LEVEL (dBuV/m)	LIMIT (dBuV/m)	MARGIN (dB)	ANTENNA HEIGHT (m)	TABLE ANGLE (Degree)	RAW VALUE (dBuV)	CORRECTION FACTOR (dB/m)
1	#5650.97	58.8 PK	68.9	-10.1	2.74 H	94	54.5	4.3
2	*5795.00	118.5 PK			2.74 H	94	114.1	4.4
3	*5795.00	109.0 AV			2.74 H	94	104.6	4.4
4	#5942.56	59.7 PK	68.2	-8.5	2.74 H	94	55.0	4.7
5	11590.00	47.7 PK	74.0	-26.3	1.80 H	196	34.2	13.5
6	11590.00	34.1 AV	54.0	-19.9	1.80 H	196	20.6	13.5
7	#17385.00	46.6 PK	74.0	-27.4	2.29 H	308	28.3	18.3
8	#17385.00	34.6 AV	54.0	-19.4	2.29 H	308	16.3	18.3

ANTENNA POLARITY & TEST DISTANCE: VERTICAL AT 3 M

NO.	FREQ. (MHz)	EMISSION LEVEL (dBuV/m)	LIMIT (dBuV/m)	MARGIN (dB)	ANTENNA HEIGHT (m)	TABLE ANGLE (Degree)	RAW VALUE (dBuV)	CORRECTION FACTOR (dB/m)
1	#5595.59	58.2 PK	68.2	-10.0	2.42 V	0	53.9	4.3
2	*5795.00	106.9 PK			2.42 V	0	102.5	4.4
3	*5795.00	97.2 AV			2.42 V	0	92.8	4.4
4	#5955.45	58.6 PK	68.2	-9.6	2.42 V	0	53.9	4.7
5	11590.00	47.4 PK	74.0	-26.6	1.54 V	287	33.9	13.5
6	11590.00	33.6 AV	54.0	-20.4	1.54 V	287	20.1	13.5
7	#17385.00	43.9 PK	74.0	-30.1	1.28 V	232	25.6	18.3
8	#17385.00	31.8 AV	54.0	-22.2	1.28 V	232	13.5	18.3

REMARKS:

1. Emission Level(dBuV/m) = Raw Value(dBuV) + Correction Factor(dB/m)
2. Correction Factor(dB/m) = Antenna Factor(dB/m) + Cable Factor(dB) – Pre-Amplifier Factor(dB)
3. The other emission levels were very low against the limit.
4. Margin value = Emission Level – Limit value
5. " * ": Fundamental frequency.
6. " # ": The radiated frequency is out of the restricted band.

802.11ac (VHT80)

CHANNEL	TX Channel 42	DETECTOR FUNCTION	Peak (PK)
FREQUENCY RANGE	1GHz ~ 40GHz		Average (AV)

ANTENNA POLARITY & TEST DISTANCE: HORIZONTAL AT 3 M

NO.	FREQ. (MHz)	EMISSION LEVEL (dBuV/m)	LIMIT (dBuV/m)	MARGIN (dB)	ANTENNA HEIGHT (m)	TABLE ANGLE (Degree)	RAW VALUE (dBuV)	CORRECTION FACTOR (dB/m)
1	5140.90	65.4 PK	74.0	-8.6	3.48 H	88	61.8	3.6
2	5140.90	53.7 AV	54.0	-0.3	3.48 H	88	50.1	3.6
3	*5210.00	104.4 PK			3.48 H	88	100.7	3.7
4	*5210.00	95.0 AV			3.48 H	88	91.3	3.7
5	5350.00	49.4 PK	74.0	-24.6	3.48 H	88	45.3	4.1
6	5350.00	38.2 AV	54.0	-15.8	3.48 H	88	34.1	4.1
7	#10420.00	47.4 PK	74.0	-26.6	1.73 H	199	34.3	13.1
8	#10420.00	33.9 AV	54.0	-20.1	1.73 H	199	20.8	13.1
9	15630.00	46.1 PK	74.0	-27.9	2.26 H	336	32.5	13.6
10	15630.00	34.2 AV	54.0	-19.8	2.26 H	336	20.6	13.6

ANTENNA POLARITY & TEST DISTANCE: VERTICAL AT 3 M

NO.	FREQ. (MHz)	EMISSION LEVEL (dBuV/m)	LIMIT (dBuV/m)	MARGIN (dB)	ANTENNA HEIGHT (m)	TABLE ANGLE (Degree)	RAW VALUE (dBuV)	CORRECTION FACTOR (dB/m)
1	5140.90	52.3 PK	74.0	-21.7	2.37 V	14	48.7	3.6
2	5140.90	41.1 AV	54.0	-12.9	2.37 V	14	37.5	3.6
3	*5210.00	91.2 PK			2.37 V	14	87.5	3.7
4	*5210.00	82.9 AV			2.37 V	14	79.2	3.7
5	5350.00	48.2 PK	74.0	-25.8	2.37 V	14	44.1	4.1
6	5350.00	37.4 AV	54.0	-16.6	2.37 V	14	33.3	4.1
7	#10420.00	46.7 PK	74.0	-27.3	1.57 V	296	33.6	13.1
8	#10420.00	33.3 AV	54.0	-20.7	1.57 V	296	20.2	13.1
9	15630.00	44.4 PK	74.0	-29.6	1.30 V	229	30.8	13.6
10	15630.00	32.1 AV	54.0	-21.9	1.30 V	229	18.5	13.6

REMARKS:

- Emission Level(dBuV/m) = Raw Value(dBuV) + Correction Factor(dB/m)
- Correction Factor(dB/m) = Antenna Factor(dB/m) + Cable Factor(dB) – Pre-Amplifier Factor(dB)
- The other emission levels were very low against the limit.
- Margin value = Emission Level – Limit value
- " * ": Fundamental frequency.
- " # ": The radiated frequency is out of the restricted band.

CHANNEL	TX Channel 155	DETECTOR FUNCTION	Peak (PK)
FREQUENCY RANGE	1GHz ~ 40GHz		Average (AV)

ANTENNA POLARITY & TEST DISTANCE: HORIZONTAL AT 3 M

NO.	FREQ. (MHz)	EMISSION LEVEL (dBuV/m)	LIMIT (dBuV/m)	MARGIN (dB)	ANTENNA HEIGHT (m)	TABLE ANGLE (Degree)	RAW VALUE (dBuV)	CORRECTION FACTOR (dB/m)
1	#5651.61	68.7 PK	69.4	-0.7	2.92 H	92	64.4	4.3
2	*5775.00	110.8 PK			2.92 H	92	106.4	4.4
3	*5775.00	101.5 AV			2.92 H	92	97.1	4.4
4	#5930.90	64.3 PK	68.2	-3.9	2.92 H	92	59.6	4.7
5	11550.00	47.2 PK	74.0	-26.8	1.71 H	190	33.7	13.5
6	11550.00	34.1 AV	54.0	-19.9	1.71 H	190	20.6	13.5
7	#17325.00	46.4 PK	74.0	-27.6	2.26 H	309	28.6	17.8
8	#17325.00	34.4 AV	54.0	-19.6	2.26 H	309	16.6	17.8

ANTENNA POLARITY & TEST DISTANCE: VERTICAL AT 3 M

NO.	FREQ. (MHz)	EMISSION LEVEL (dBuV/m)	LIMIT (dBuV/m)	MARGIN (dB)	ANTENNA HEIGHT (m)	TABLE ANGLE (Degree)	RAW VALUE (dBuV)	CORRECTION FACTOR (dB/m)
1	#5607.39	58.4 PK	68.2	-9.8	2.42 V	2	54.0	4.4
2	*5775.00	99.2 PK			2.42 V	2	94.8	4.4
3	*5775.00	89.9 AV			2.42 V	2	85.5	4.4
4	#5980.75	58.4 PK	68.2	-9.8	2.42 V	2	53.7	4.7
5	11550.00	46.9 PK	74.0	-27.1	1.49 V	293	33.4	13.5
6	11550.00	33.2 AV	54.0	-20.8	1.49 V	293	19.7	13.5
7	#17325.00	44.2 PK	74.0	-29.8	1.29 V	216	26.4	17.8
8	#17325.00	31.9 AV	54.0	-22.1	1.29 V	216	14.1	17.8

REMARKS:

1. Emission Level(dBuV/m) = Raw Value(dBuV) + Correction Factor(dB/m)
2. Correction Factor(dB/m) = Antenna Factor(dB/m) + Cable Factor(dB) – Pre-Amplifier Factor(dB)
3. The other emission levels were very low against the limit.
4. Margin value = Emission Level – Limit value
5. " * ": Fundamental frequency.
6. " # ": The radiated frequency is out of the restricted band.

4.1.9 Test Results (Mode 3)

Above 1GHz Data:

802.11a

CHANNEL	TX Channel 36	DETECTOR FUNCTION	Peak (PK)
FREQUENCY RANGE	1GHz ~ 40GHz		Average (AV)

ANTENNA POLARITY & TEST DISTANCE: HORIZONTAL AT 3 M								
NO.	FREQ. (MHz)	EMISSION LEVEL (dBuV/m)	LIMIT (dBuV/m)	MARGIN (dB)	ANTENNA HEIGHT (m)	TABLE ANGLE (Degree)	RAW VALUE (dBuV)	CORRECTION FACTOR (dB/m)
1	5148.20	66.0 PK	74.0	-8.0	3.11 H	303	62.3	3.7
2	5148.20	53.5 AV	54.0	-0.5	3.11 H	303	49.8	3.7
3	*5180.00	118.1 PK			3.11 H	303	114.4	3.7
4	*5180.00	107.8 AV			3.11 H	303	104.1	3.7
5	#10360.00	45.6 PK	74.0	-28.4	1.60 H	262	32.6	13.0
6	#10360.00	32.4 AV	54.0	-21.6	1.60 H	262	19.4	13.0
7	15540.00	44.4 PK	74.0	-29.6	1.83 H	239	31.3	13.1
8	15540.00	32.2 AV	54.0	-21.8	1.83 H	239	19.1	13.1

ANTENNA POLARITY & TEST DISTANCE: VERTICAL AT 3 M								
NO.	FREQ. (MHz)	EMISSION LEVEL (dBuV/m)	LIMIT (dBuV/m)	MARGIN (dB)	ANTENNA HEIGHT (m)	TABLE ANGLE (Degree)	RAW VALUE (dBuV)	CORRECTION FACTOR (dB/m)
1	5148.20	52.4 PK	74.0	-21.6	2.46 V	353	48.7	3.7
2	5148.20	42.5 AV	54.0	-11.5	2.46 V	353	38.8	3.7
3	*5180.00	105.0 PK			2.46 V	353	101.3	3.7
4	*5180.00	95.3 AV			2.46 V	353	91.6	3.7
5	#10360.00	45.5 PK	74.0	-28.5	1.90 V	229	32.5	13.0
6	#10360.00	32.2 AV	54.0	-21.8	1.90 V	229	19.2	13.0
7	15540.00	44.3 PK	74.0	-29.7	1.78 V	250	31.2	13.1
8	15540.00	32.0 AV	54.0	-22.0	1.78 V	250	18.9	13.1

REMARKS:

- Emission Level(dBuV/m) = Raw Value(dBuV) + Correction Factor(dB/m)
- Correction Factor(dB/m) = Antenna Factor(dB/m) + Cable Factor(dB) – Pre-Amplifier Factor(dB)
- The other emission levels were very low against the limit.
- Margin value = Emission Level – Limit value
- " * ": Fundamental frequency.
- " # ": The radiated frequency is out of the restricted band.

CHANNEL	TX Channel 40	DETECTOR FUNCTION	Peak (PK)
FREQUENCY RANGE	1GHz ~ 40GHz		Average (AV)

ANTENNA POLARITY & TEST DISTANCE: HORIZONTAL AT 3 M

NO.	FREQ. (MHz)	EMISSION LEVEL (dBuV/m)	LIMIT (dBuV/m)	MARGIN (dB)	ANTENNA HEIGHT (m)	TABLE ANGLE (Degree)	RAW VALUE (dBuV)	CORRECTION FACTOR (dB/m)
1	5147.00	65.8 PK	74.0	-8.2	2.74 H	99	62.2	3.6
2	5147.00	53.1 AV	54.0	-0.9	2.74 H	99	49.5	3.6
3	*5200.00	121.0 PK			2.74 H	99	117.3	3.7
4	*5200.00	108.5 AV			2.74 H	99	104.8	3.7
5	5350.00	49.4 PK	74.0	-24.6	2.74 H	99	45.3	4.1
6	5350.00	36.8 AV	54.0	-17.2	2.74 H	99	32.7	4.1
7	#10400.00	46.0 PK	74.0	-28.0	1.63 H	241	33.0	13.0
8	#10400.00	33.1 AV	54.0	-20.9	1.63 H	241	20.1	13.0
9	15600.00	45.5 PK	74.0	-28.5	1.85 H	222	32.2	13.3
10	15600.00	32.8 AV	54.0	-21.2	1.85 H	222	19.5	13.3

ANTENNA POLARITY & TEST DISTANCE: VERTICAL AT 3 M

NO.	FREQ. (MHz)	EMISSION LEVEL (dBuV/m)	LIMIT (dBuV/m)	MARGIN (dB)	ANTENNA HEIGHT (m)	TABLE ANGLE (Degree)	RAW VALUE (dBuV)	CORRECTION FACTOR (dB/m)
1	5147.00	54.2 PK	74.0	-19.8	2.82 V	252	50.6	3.6
2	5147.00	42.6 AV	54.0	-11.4	2.82 V	252	39.0	3.6
3	*5200.00	108.5 PK			2.82 V	252	104.8	3.7
4	*5200.00	97.1 AV			2.82 V	252	93.4	3.7
5	5350.00	49.1 PK	74.0	-24.9	2.82 V	252	45.0	4.1
6	5350.00	35.9 AV	54.0	-18.1	2.82 V	252	31.8	4.1
7	#10400.00	45.8 PK	74.0	-28.2	1.85 V	214	32.8	13.0
8	#10400.00	33.0 AV	54.0	-21.0	1.85 V	214	20.0	13.0
9	15600.00	45.3 PK	74.0	-28.7	1.74 V	243	32.0	13.3
10	15600.00	32.6 AV	54.0	-21.4	1.74 V	243	19.3	13.3

REMARKS:

1. Emission Level(dBuV/m) = Raw Value(dBuV) + Correction Factor(dB/m)
2. Correction Factor(dB/m) = Antenna Factor(dB/m) + Cable Factor(dB) – Pre-Amplifier Factor(dB)
3. The other emission levels were very low against the limit.
4. Margin value = Emission Level – Limit value
5. " * ": Fundamental frequency.
6. " # ": The radiated frequency is out of the restricted band.

CHANNEL	TX Channel 48	DETECTOR FUNCTION	Peak (PK)
FREQUENCY RANGE	1GHz ~ 40GHz		Average (AV)

ANTENNA POLARITY & TEST DISTANCE: HORIZONTAL AT 3 M

NO.	FREQ. (MHz)	EMISSION LEVEL (dBuV/m)	LIMIT (dBuV/m)	MARGIN (dB)	ANTENNA HEIGHT (m)	TABLE ANGLE (Degree)	RAW VALUE (dBuV)	CORRECTION FACTOR (dB/m)
1	*5240.00	119.3 PK			2.72 H	102	115.5	3.8
2	*5240.00	107.7 AV			2.72 H	102	103.9	3.8
3	5350.00	48.7 PK	74.0	-25.3	2.72 H	102	44.6	4.1
4	5350.00	37.2 AV	54.0	-16.8	2.72 H	102	33.1	4.1
5	#10480.00	45.8 PK	74.0	-28.2	1.62 H	254	32.6	13.2
6	#10480.00	32.8 AV	54.0	-21.2	1.62 H	254	19.6	13.2
7	15720.00	45.1 PK	74.0	-28.9	1.80 H	216	31.5	13.6
8	15720.00	32.6 AV	54.0	-21.4	1.80 H	216	19.0	13.6

ANTENNA POLARITY & TEST DISTANCE: VERTICAL AT 3 M

NO.	FREQ. (MHz)	EMISSION LEVEL (dBuV/m)	LIMIT (dBuV/m)	MARGIN (dB)	ANTENNA HEIGHT (m)	TABLE ANGLE (Degree)	RAW VALUE (dBuV)	CORRECTION FACTOR (dB/m)
1	*5240.00	107.3 PK			2.87 V	241	103.5	3.8
2	*5240.00	96.2 AV			2.87 V	241	92.4	3.8
3	5350.00	48.5 PK	74.0	-25.5	2.87 V	241	44.4	4.1
4	5350.00	36.3 AV	54.0	-17.7	2.87 V	241	32.2	4.1
5	#10480.00	45.6 PK	74.0	-28.4	1.88 V	199	32.4	13.2
6	#10480.00	32.6 AV	54.0	-21.4	1.88 V	199	19.4	13.2
7	15720.00	45.0 PK	74.0	-29.0	1.78 V	257	31.4	13.6
8	15720.00	32.4 AV	54.0	-21.6	1.78 V	257	18.8	13.6

REMARKS:

- Emission Level(dBuV/m) = Raw Value(dBuV) + Correction Factor(dB/m)
- Correction Factor(dB/m) = Antenna Factor(dB/m) + Cable Factor(dB) – Pre-Amplifier Factor(dB)
- The other emission levels were very low against the limit.
- Margin value = Emission Level – Limit value
- " * ": Fundamental frequency.
- " # ": The radiated frequency is out of the restricted band.

CHANNEL	TX Channel 149	DETECTOR FUNCTION	Peak (PK)
FREQUENCY RANGE	1GHz ~ 40GHz		Average (AV)

ANTENNA POLARITY & TEST DISTANCE: HORIZONTAL AT 3 M

NO.	FREQ. (MHz)	EMISSION LEVEL (dBuV/m)	LIMIT (dBuV/m)	MARGIN (dB)	ANTENNA HEIGHT (m)	TABLE ANGLE (Degree)	RAW VALUE (dBuV)	CORRECTION FACTOR (dB/m)
1	#5648.04	57.6 PK	68.2	-10.6	2.64 H	94	53.2	4.4
2	*5745.00	122.8 PK			2.64 H	94	118.4	4.4
3	*5745.00	109.7 AV			2.64 H	94	105.3	4.4
4	#6002.79	55.1 PK	68.2	-13.1	2.64 H	94	50.3	4.8
5	11490.00	46.4 PK	74.0	-27.6	1.58 H	233	32.9	13.5
6	11490.00	33.4 AV	54.0	-20.6	1.58 H	233	19.9	13.5
7	#17235.00	45.5 PK	74.0	-28.5	1.82 H	222	28.2	17.3
8	#17235.00	32.8 AV	54.0	-21.2	1.82 H	222	15.5	17.3

ANTENNA POLARITY & TEST DISTANCE: VERTICAL AT 3 M

NO.	FREQ. (MHz)	EMISSION LEVEL (dBuV/m)	LIMIT (dBuV/m)	MARGIN (dB)	ANTENNA HEIGHT (m)	TABLE ANGLE (Degree)	RAW VALUE (dBuV)	CORRECTION FACTOR (dB/m)
1	#5636.20	50.7 PK	68.2	-17.5	3.73 V	310	46.3	4.4
2	*5745.00	107.3 PK			3.73 V	310	102.9	4.4
3	*5745.00	95.8 AV			3.73 V	310	91.4	4.4
4	#5948.09	50.2 PK	68.2	-18.0	3.73 V	310	45.5	4.7
5	11490.00	46.1 PK	74.0	-27.9	1.84 V	216	32.6	13.5
6	11490.00	33.0 AV	54.0	-21.0	1.84 V	216	19.5	13.5
7	#17235.00	45.8 PK	74.0	-28.2	1.79 V	247	28.5	17.3
8	#17235.00	32.9 AV	54.0	-21.1	1.79 V	247	15.6	17.3

REMARKS:

1. Emission Level(dBuV/m) = Raw Value(dBuV) + Correction Factor(dB/m)
2. Correction Factor(dB/m) = Antenna Factor(dB/m) + Cable Factor(dB) – Pre-Amplifier Factor(dB)
3. The other emission levels were very low against the limit.
4. Margin value = Emission Level – Limit value
5. " * ": Fundamental frequency.
6. " # ": The radiated frequency is out of the restricted band.

CHANNEL	TX Channel 157	DETECTOR FUNCTION	Peak (PK)
FREQUENCY RANGE	1GHz ~ 40GHz		Average (AV)

ANTENNA POLARITY & TEST DISTANCE: HORIZONTAL AT 3 M

NO.	FREQ. (MHz)	EMISSION LEVEL (dBuV/m)	LIMIT (dBuV/m)	MARGIN (dB)	ANTENNA HEIGHT (m)	TABLE ANGLE (Degree)	RAW VALUE (dBuV)	CORRECTION FACTOR (dB/m)
1	#5635.70	55.4 PK	68.2	-12.8	2.61 H	92	51.0	4.4
2	*5785.00	122.2 PK			2.61 H	92	117.8	4.4
3	*5785.00	109.2 AV			2.61 H	92	104.8	4.4
4	#6016.60	55.8 PK	68.2	-12.4	2.91 H	92	51.0	4.8
5	11570.00	46.1 PK	74.0	-27.9	1.69 H	250	32.6	13.5
6	11570.00	33.3 AV	54.0	-20.7	1.69 H	250	19.8	13.5
7	#17355.00	45.7 PK	74.0	-28.3	1.85 H	223	27.7	18.0
8	#17355.00	32.9 AV	54.0	-21.1	1.85 H	223	14.9	18.0

ANTENNA POLARITY & TEST DISTANCE: VERTICAL AT 3 M

NO.	FREQ. (MHz)	EMISSION LEVEL (dBuV/m)	LIMIT (dBuV/m)	MARGIN (dB)	ANTENNA HEIGHT (m)	TABLE ANGLE (Degree)	RAW VALUE (dBuV)	CORRECTION FACTOR (dB/m)
1	#5614.79	50.0 PK	68.2	-18.2	3.71 V	308	45.6	4.4
2	*5785.00	107.3 PK			3.71 V	308	102.9	4.4
3	*5785.00	95.9 AV			3.71 V	308	91.5	4.4
4	#5948.32	50.9 PK	68.2	-17.3	3.71 V	308	46.2	4.7
5	11570.00	45.8 PK	74.0	-28.2	1.79 V	205	32.3	13.5
6	11570.00	32.7 AV	54.0	-21.3	1.79 V	205	19.2	13.5
7	#17355.00	45.1 PK	74.0	-28.9	1.77 V	245	27.1	18.0
8	#17355.00	32.2 AV	54.0	-21.8	1.77 V	245	14.2	18.0

REMARKS:

1. Emission Level(dBuV/m) = Raw Value(dBuV) + Correction Factor(dB/m)
2. Correction Factor(dB/m) = Antenna Factor(dB/m) + Cable Factor(dB) – Pre-Amplifier Factor(dB)
3. The other emission levels were very low against the limit.
4. Margin value = Emission Level – Limit value
5. " * ": Fundamental frequency.
6. " # ": The radiated frequency is out of the restricted band.

CHANNEL	TX Channel 165	DETECTOR FUNCTION	Peak (PK)
FREQUENCY RANGE	1GHz ~ 40GHz		Average (AV)

ANTENNA POLARITY & TEST DISTANCE: HORIZONTAL AT 3 M

NO.	FREQ. (MHz)	EMISSION LEVEL (dBuV/m)	LIMIT (dBuV/m)	MARGIN (dB)	ANTENNA HEIGHT (m)	TABLE ANGLE (Degree)	RAW VALUE (dBuV)	CORRECTION FACTOR (dB/m)
1	#5585.85	56.3 PK	68.2	-11.9	2.45 H	90	52.1	4.2
2	*5825.00	121.5 PK			2.45 H	90	117.1	4.4
3	*5825.00	109.1 AV			2.45 H	90	104.7	4.4
4	#5933.41	55.2 PK	68.2	-13.0	2.45 H	90	50.5	4.7
5	11650.00	46.5 PK	74.0	-27.5	1.60 H	238	32.8	13.7
6	11650.00	33.3 AV	54.0	-20.7	1.60 H	238	19.6	13.7
7	#17475.00	46.1 PK	74.0	-27.9	1.81 H	208	27.5	18.6
8	#17475.00	33.2 AV	54.0	-20.8	1.81 H	208	14.6	18.6

ANTENNA POLARITY & TEST DISTANCE: VERTICAL AT 3 M

NO.	FREQ. (MHz)	EMISSION LEVEL (dBuV/m)	LIMIT (dBuV/m)	MARGIN (dB)	ANTENNA HEIGHT (m)	TABLE ANGLE (Degree)	RAW VALUE (dBuV)	CORRECTION FACTOR (dB/m)
1	#5625.36	51.1 PK	68.2	-17.1	3.74 V	305	46.7	4.4
2	*5825.00	107.2 PK			3.74 V	305	102.8	4.4
3	*5825.00	95.7 AV			3.74 V	305	91.3	4.4
4	#5980.72	51.4 PK	68.2	-16.8	3.74 V	305	46.7	4.7
5	11650.00	45.4 PK	74.0	-28.6	1.88 V	206	31.7	13.7
6	11650.00	32.9 AV	54.0	-21.1	1.88 V	206	19.2	13.7
7	#17475.00	45.6 PK	74.0	-28.4	1.76 V	257	27.0	18.6
8	#17475.00	32.7 AV	54.0	-21.3	1.76 V	257	14.1	18.6

REMARKS:

1. Emission Level(dBuV/m) = Raw Value(dBuV) + Correction Factor(dB/m)
2. Correction Factor(dB/m) = Antenna Factor(dB/m) + Cable Factor(dB) – Pre-Amplifier Factor(dB)
3. The other emission levels were very low against the limit.
4. Margin value = Emission Level – Limit value
5. " * ": Fundamental frequency.
6. " # ": The radiated frequency is out of the restricted band.

802.11ac (VHT20)

CHANNEL	TX Channel 36	DETECTOR FUNCTION	Peak (PK)
FREQUENCY RANGE	1GHz ~ 40GHz		Average (AV)

ANTENNA POLARITY & TEST DISTANCE: HORIZONTAL AT 3 M								
NO.	FREQ. (MHz)	EMISSION LEVEL (dBuV/m)	LIMIT (dBuV/m)	MARGIN (dB)	ANTENNA HEIGHT (m)	TABLE ANGLE (Degree)	RAW VALUE (dBuV)	CORRECTION FACTOR (dB/m)
1	5150.00	64.3 PK	74.0	-9.7	2.84 H	103	60.6	3.7
2	5150.00	53.2 AV	54.0	-0.8	2.84 H	103	49.5	3.7
3	*5180.00	118.5 PK			2.84 H	103	114.8	3.7
4	*5180.00	106.9 AV			2.84 H	103	103.2	3.7
5	#10360.00	46.6 PK	74.0	-27.4	1.66 H	261	33.6	13.0
6	#10360.00	33.3 AV	54.0	-20.7	1.66 H	261	20.3	13.0
7	15540.00	46.1 PK	74.0	-27.9	1.82 H	219	33.0	13.1
8	15540.00	33.1 AV	54.0	-20.9	1.82 H	219	20.0	13.1

ANTENNA POLARITY & TEST DISTANCE: VERTICAL AT 3 M								
NO.	FREQ. (MHz)	EMISSION LEVEL (dBuV/m)	LIMIT (dBuV/m)	MARGIN (dB)	ANTENNA HEIGHT (m)	TABLE ANGLE (Degree)	RAW VALUE (dBuV)	CORRECTION FACTOR (dB/m)
1	5150.00	49.3 PK	74.0	-24.7	2.88 V	259	45.6	3.7
2	5150.00	36.1 AV	54.0	-17.9	2.88 V	259	32.4	3.7
3	*5180.00	106.7 PK			2.88 V	259	103.0	3.7
4	*5180.00	93.9 AV			2.88 V	259	90.2	3.7
5	#10360.00	45.5 PK	74.0	-28.5	1.80 V	221	32.5	13.0
6	#10360.00	32.8 AV	54.0	-21.2	1.80 V	221	19.8	13.0
7	15540.00	44.4 PK	74.0	-29.6	1.69 V	256	31.3	13.1
8	15540.00	32.1 AV	54.0	-21.9	1.69 V	256	19.0	13.1

REMARKS:

- Emission Level(dBuV/m) = Raw Value(dBuV) + Correction Factor(dB/m)
- Correction Factor(dB/m) = Antenna Factor(dB/m) + Cable Factor(dB) – Pre-Amplifier Factor(dB)
- The other emission levels were very low against the limit.
- Margin value = Emission Level – Limit value
- " * ": Fundamental frequency.
- " # ": The radiated frequency is out of the restricted band.

CHANNEL	TX Channel 40	DETECTOR FUNCTION	Peak (PK)
FREQUENCY RANGE	1GHz ~ 40GHz		Average (AV)

ANTENNA POLARITY & TEST DISTANCE: HORIZONTAL AT 3 M

NO.	FREQ. (MHz)	EMISSION LEVEL (dBuV/m)	LIMIT (dBuV/m)	MARGIN (dB)	ANTENNA HEIGHT (m)	TABLE ANGLE (Degree)	RAW VALUE (dBuV)	CORRECTION FACTOR (dB/m)
1	5150.00	65.3 PK	74.0	-8.7	2.92 H	103	61.6	3.7
2	5150.00	53.6 AV	54.0	-0.4	2.92 H	103	49.9	3.7
3	*5200.00	120.8 PK			2.92 H	103	117.1	3.7
4	*5200.00	109.5 AV			2.92 H	103	105.8	3.7
5	#10400.00	46.3 PK	74.0	-27.7	1.64 H	249	33.3	13.0
6	#10400.00	33.4 AV	54.0	-20.6	1.64 H	249	20.4	13.0
7	15600.00	46.1 PK	74.0	-27.9	1.81 H	230	32.8	13.3
8	15600.00	33.1 AV	54.0	-20.9	1.81 H	230	19.8	13.3

ANTENNA POLARITY & TEST DISTANCE: VERTICAL AT 3 M

NO.	FREQ. (MHz)	EMISSION LEVEL (dBuV/m)	LIMIT (dBuV/m)	MARGIN (dB)	ANTENNA HEIGHT (m)	TABLE ANGLE (Degree)	RAW VALUE (dBuV)	CORRECTION FACTOR (dB/m)
1	5150.00	49.6 PK	74.0	-24.4	2.88 V	259	45.9	3.7
2	5150.00	36.2 AV	54.0	-17.8	2.88 V	259	32.5	3.7
3	*5200.00	108.5 PK			2.88 V	259	104.8	3.7
4	*5200.00	96.8 AV			2.88 V	259	93.1	3.7
5	#10400.00	45.7 PK	74.0	-28.3	1.91 V	229	32.7	13.0
6	#10400.00	33.0 AV	54.0	-21.0	1.91 V	229	20.0	13.0
7	15600.00	45.1 PK	74.0	-28.9	1.78 V	243	31.8	13.3
8	15600.00	32.6 AV	54.0	-21.4	1.78 V	243	19.3	13.3

REMARKS:

1. Emission Level(dBuV/m) = Raw Value(dBuV) + Correction Factor(dB/m)
2. Correction Factor(dB/m) = Antenna Factor(dB/m) + Cable Factor(dB) – Pre-Amplifier Factor(dB)
3. The other emission levels were very low against the limit.
4. Margin value = Emission Level – Limit value
5. " * ": Fundamental frequency.
6. " # ": The radiated frequency is out of the restricted band.

CHANNEL	TX Channel 48	DETECTOR FUNCTION	Peak (PK)
FREQUENCY RANGE	1GHz ~ 40GHz		Average (AV)

ANTENNA POLARITY & TEST DISTANCE: HORIZONTAL AT 3 M

NO.	FREQ. (MHz)	EMISSION LEVEL (dBuV/m)	LIMIT (dBuV/m)	MARGIN (dB)	ANTENNA HEIGHT (m)	TABLE ANGLE (Degree)	RAW VALUE (dBuV)	CORRECTION FACTOR (dB/m)
1	*5240.00	119.8 PK			2.77 H	104	116.0	3.8
2	*5240.00	108.7 AV			2.77 H	104	104.9	3.8
3	5350.00	49.5 PK	74.0	-24.5	2.77 H	104	45.4	4.1
4	5350.00	37.4 AV	54.0	-16.6	2.77 H	104	33.3	4.1
5	#10480.00	46.8 PK	74.0	-27.2	1.56 H	254	33.6	13.2
6	#10480.00	33.8 AV	54.0	-20.2	1.56 H	254	20.6	13.2
7	15720.00	46.2 PK	74.0	-27.8	1.78 H	244	32.6	13.6
8	15720.00	33.4 AV	54.0	-20.6	1.78 H	244	19.8	13.6

ANTENNA POLARITY & TEST DISTANCE: VERTICAL AT 3 M

NO.	FREQ. (MHz)	EMISSION LEVEL (dBuV/m)	LIMIT (dBuV/m)	MARGIN (dB)	ANTENNA HEIGHT (m)	TABLE ANGLE (Degree)	RAW VALUE (dBuV)	CORRECTION FACTOR (dB/m)
1	*5240.00	107.6 PK			2.27 V	297	103.8	3.8
2	*5240.00	95.9 AV			2.27 V	297	92.1	3.8
3	5350.00	48.7 PK	74.0	-25.3	2.27 V	297	44.6	4.1
4	5350.00	36.3 AV	54.0	-17.7	2.27 V	297	32.2	4.1
5	#10480.00	45.5 PK	74.0	-28.5	1.81 V	217	32.3	13.2
6	#10480.00	33.0 AV	54.0	-21.0	1.81 V	217	19.8	13.2
7	15720.00	44.5 PK	74.0	-29.5	1.71 V	251	30.9	13.6
8	15720.00	32.3 AV	54.0	-21.7	1.71 V	251	18.7	13.6

REMARKS:

1. Emission Level(dBuV/m) = Raw Value(dBuV) + Correction Factor(dB/m)
2. Correction Factor(dB/m) = Antenna Factor(dB/m) + Cable Factor(dB) – Pre-Amplifier Factor(dB)
3. The other emission levels were very low against the limit.
4. Margin value = Emission Level – Limit value
5. " * ": Fundamental frequency.
6. " # ": The radiated frequency is out of the restricted band.

CHANNEL	TX Channel 149	DETECTOR FUNCTION	Peak (PK)
FREQUENCY RANGE	1GHz ~ 40GHz		Average (AV)

ANTENNA POLARITY & TEST DISTANCE: HORIZONTAL AT 3 M

NO.	FREQ. (MHz)	EMISSION LEVEL (dBuV/m)	LIMIT (dBuV/m)	MARGIN (dB)	ANTENNA HEIGHT (m)	TABLE ANGLE (Degree)	RAW VALUE (dBuV)	CORRECTION FACTOR (dB/m)
1	#5640.70	58.1 PK	68.2	-10.1	2.59 H	91	53.7	4.4
2	*5745.00	121.1 PK			2.59 H	91	116.7	4.4
3	*5745.00	109.9 AV			2.59 H	91	105.5	4.4
4	#5945.84	55.6 PK	68.2	-12.6	2.59 H	91	50.9	4.7
5	11490.00	46.0 PK	74.0	-28.0	1.62 H	247	32.5	13.5
6	11490.00	33.1 AV	54.0	-20.9	1.62 H	247	19.6	13.5
7	#17235.00	45.9 PK	74.0	-28.1	1.82 H	228	28.6	17.3
8	#17235.00	32.9 AV	54.0	-21.1	1.82 H	228	15.6	17.3

ANTENNA POLARITY & TEST DISTANCE: VERTICAL AT 3 M

NO.	FREQ. (MHz)	EMISSION LEVEL (dBuV/m)	LIMIT (dBuV/m)	MARGIN (dB)	ANTENNA HEIGHT (m)	TABLE ANGLE (Degree)	RAW VALUE (dBuV)	CORRECTION FACTOR (dB/m)
1	#5649.71	51.3 PK	68.2	-16.9	2.32 V	305	46.9	4.4
2	*5745.00	107.5 PK			2.32 V	305	103.1	4.4
3	*5745.00	95.6 AV			2.32 V	305	91.2	4.4
4	#6016.73	50.5 PK	68.2	-17.7	2.32 V	305	45.7	4.8
5	11490.00	45.9 PK	74.0	-28.1	1.87 V	240	32.4	13.5
6	11490.00	33.2 AV	54.0	-20.8	1.87 V	240	19.7	13.5
7	#17235.00	44.8 PK	74.0	-29.2	1.76 V	241	27.5	17.3
8	#17235.00	32.3 AV	54.0	-21.7	1.76 V	241	15.0	17.3

REMARKS:

1. Emission Level(dBuV/m) = Raw Value(dBuV) + Correction Factor(dB/m)
2. Correction Factor(dB/m) = Antenna Factor(dB/m) + Cable Factor(dB) – Pre-Amplifier Factor(dB)
3. The other emission levels were very low against the limit.
4. Margin value = Emission Level – Limit value
5. " * ": Fundamental frequency.
6. " # ": The radiated frequency is out of the restricted band.

CHANNEL	TX Channel 157	DETECTOR FUNCTION	Peak (PK)
FREQUENCY RANGE	1GHz ~ 40GHz		Average (AV)

ANTENNA POLARITY & TEST DISTANCE: HORIZONTAL AT 3 M

NO.	FREQ. (MHz)	EMISSION LEVEL (dBuV/m)	LIMIT (dBuV/m)	MARGIN (dB)	ANTENNA HEIGHT (m)	TABLE ANGLE (Degree)	RAW VALUE (dBuV)	CORRECTION FACTOR (dB/m)
1	#5650.27	55.6 PK	68.4	-12.8	2.78 H	91	51.3	4.3
2	*5785.00	121.2 PK			2.78 H	91	116.8	4.4
3	*5785.00	109.6 AV			2.78 H	91	105.2	4.4
4	#5968.20	55.5 PK	68.2	-12.7	2.78 H	91	50.8	4.7
5	11570.00	46.9 PK	74.0	-27.1	1.59 H	263	33.4	13.5
6	11570.00	33.7 AV	54.0	-20.3	1.59 H	263	20.2	13.5
7	#17355.00	46.0 PK	74.0	-28.0	1.77 H	219	28.0	18.0
8	#17355.00	33.0 AV	54.0	-21.0	1.77 H	219	15.0	18.0

ANTENNA POLARITY & TEST DISTANCE: VERTICAL AT 3 M

NO.	FREQ. (MHz)	EMISSION LEVEL (dBuV/m)	LIMIT (dBuV/m)	MARGIN (dB)	ANTENNA HEIGHT (m)	TABLE ANGLE (Degree)	RAW VALUE (dBuV)	CORRECTION FACTOR (dB/m)
1	#5595.23	50.8 PK	68.2	-17.4	2.30 V	305	46.5	4.3
2	*5785.00	107.2 PK			2.30 V	305	102.8	4.4
3	*5785.00	95.4 AV			2.30 V	305	91.0	4.4
4	#6006.49	50.1 PK	68.2	-18.1	2.30 V	305	45.3	4.8
5	11570.00	45.6 PK	74.0	-28.4	1.90 V	224	32.1	13.5
6	11570.00	32.8 AV	54.0	-21.2	1.90 V	224	19.3	13.5
7	#17355.00	45.2 PK	74.0	-28.8	1.76 V	257	27.2	18.0
8	#17355.00	32.9 AV	54.0	-21.1	1.76 V	257	14.9	18.0

REMARKS:

1. Emission Level(dBuV/m) = Raw Value(dBuV) + Correction Factor(dB/m)
2. Correction Factor(dB/m) = Antenna Factor(dB/m) + Cable Factor(dB) – Pre-Amplifier Factor(dB)
3. The other emission levels were very low against the limit.
4. Margin value = Emission Level – Limit value
5. " * ": Fundamental frequency.
6. " # ": The radiated frequency is out of the restricted band.

CHANNEL	TX Channel 165	DETECTOR FUNCTION	Peak (PK)
FREQUENCY RANGE	1GHz ~ 40GHz		Average (AV)

ANTENNA POLARITY & TEST DISTANCE: HORIZONTAL AT 3 M

NO.	FREQ. (MHz)	EMISSION LEVEL (dBuV/m)	LIMIT (dBuV/m)	MARGIN (dB)	ANTENNA HEIGHT (m)	TABLE ANGLE (Degree)	RAW VALUE (dBuV)	CORRECTION FACTOR (dB/m)
1	#5617.87	54.9 PK	68.2	-13.3	2.74 H	91	50.5	4.4
2	*5825.00	120.9 PK			2.74 H	91	116.5	4.4
3	*5825.00	109.3 AV			2.74 H	91	104.9	4.4
4	#5942.22	55.7 PK	68.2	-12.5	2.74 H	91	51.0	4.7
5	11650.00	46.0 PK	74.0	-28.0	1.67 H	252	32.3	13.7
6	11650.00	33.0 AV	54.0	-21.0	1.67 H	252	19.3	13.7
7	#17475.00	45.7 PK	74.0	-28.3	1.82 H	227	27.1	18.6
8	#17475.00	32.8 AV	54.0	-21.2	1.82 H	227	14.2	18.6

ANTENNA POLARITY & TEST DISTANCE: VERTICAL AT 3 M

NO.	FREQ. (MHz)	EMISSION LEVEL (dBuV/m)	LIMIT (dBuV/m)	MARGIN (dB)	ANTENNA HEIGHT (m)	TABLE ANGLE (Degree)	RAW VALUE (dBuV)	CORRECTION FACTOR (dB/m)
1	#5627.88	50.5 PK	68.2	-17.7	2.31 V	305	46.1	4.4
2	*5825.00	106.1 PK			2.31 V	305	101.7	4.4
3	*5825.00	95.1 AV			2.31 V	305	90.7	4.4
4	#6015.23	50.1 PK	68.2	-18.1	2.31 V	305	45.3	4.8
5	11650.00	46.3 PK	74.0	-27.7	1.97 V	229	32.6	13.7
6	11650.00	33.4 AV	54.0	-20.6	1.97 V	229	19.7	13.7
7	#17475.00	44.7 PK	74.0	-29.3	1.75 V	236	26.1	18.6
8	#17475.00	32.2 AV	54.0	-21.8	1.75 V	236	13.6	18.6

REMARKS:

1. Emission Level(dBuV/m) = Raw Value(dBuV) + Correction Factor(dB/m)
2. Correction Factor(dB/m) = Antenna Factor(dB/m) + Cable Factor(dB) – Pre-Amplifier Factor(dB)
3. The other emission levels were very low against the limit.
4. Margin value = Emission Level – Limit value
5. " * ": Fundamental frequency.
6. " # ": The radiated frequency is out of the restricted band.

802.11ac (VHT40)

CHANNEL	TX Channel 38	DETECTOR FUNCTION	Peak (PK)
FREQUENCY RANGE	1GHz ~ 40GHz		Average (AV)

ANTENNA POLARITY & TEST DISTANCE: HORIZONTAL AT 3 M

NO.	FREQ. (MHz)	EMISSION LEVEL (dBuV/m)	LIMIT (dBuV/m)	MARGIN (dB)	ANTENNA HEIGHT (m)	TABLE ANGLE (Degree)	RAW VALUE (dBuV)	CORRECTION FACTOR (dB/m)
1	5150.00	66.6 PK	74.0	-7.4	3.56 H	107	62.9	3.7
2	5150.00	53.6 AV	54.0	-0.4	3.56 H	107	49.9	3.7
3	*5190.00	109.5 PK			3.56 H	107	105.8	3.7
4	*5190.00	98.7 AV			3.56 H	107	95.0	3.7
5	5350.00	49.1 PK	74.0	-24.9	3.56 H	107	45.0	4.1
6	5350.00	37.7 AV	54.0	-16.3	3.56 H	107	33.6	4.1
7	#10380.00	45.2 PK	74.0	-28.8	1.60 H	273	32.1	13.1
8	#10380.00	33.8 AV	54.0	-20.2	1.60 H	273	20.7	13.1
9	15570.00	44.7 PK	74.0	-29.3	1.79 H	244	31.4	13.3
10	15570.00	32.3 AV	54.0	-21.7	1.79 H	244	19.0	13.3

ANTENNA POLARITY & TEST DISTANCE: VERTICAL AT 3 M

NO.	FREQ. (MHz)	EMISSION LEVEL (dBuV/m)	LIMIT (dBuV/m)	MARGIN (dB)	ANTENNA HEIGHT (m)	TABLE ANGLE (Degree)	RAW VALUE (dBuV)	CORRECTION FACTOR (dB/m)
1	5150.00	50.3 PK	74.0	-23.7	2.29 V	294	46.6	3.7
2	5150.00	36.7 AV	54.0	-17.3	2.29 V	294	33.0	3.7
3	*5190.00	96.7 PK			2.29 V	294	93.0	3.7
4	*5190.00	86.2 AV			2.29 V	294	82.5	3.7
5	5350.00	48.2 PK	74.0	-25.8	2.29 V	294	44.1	4.1
6	5350.00	36.8 AV	54.0	-17.2	2.29 V	294	32.7	4.1
7	#10380.00	44.8 PK	74.0	-29.2	1.79 V	197	31.7	13.1
8	#10380.00	32.1 AV	54.0	-21.9	1.79 V	197	19.0	13.1
9	15570.00	43.7 PK	74.0	-30.3	1.73 V	262	30.4	13.3
10	15570.00	31.2 AV	54.0	-22.8	1.73 V	262	17.9	13.3

REMARKS:

- Emission Level(dBuV/m) = Raw Value(dBuV) + Correction Factor(dB/m)
- Correction Factor(dB/m) = Antenna Factor(dB/m) + Cable Factor(dB) – Pre-Amplifier Factor(dB)
- The other emission levels were very low against the limit.
- Margin value = Emission Level – Limit value
- " * ": Fundamental frequency.
- " # ": The radiated frequency is out of the restricted band.

CHANNEL	TX Channel 46	DETECTOR FUNCTION	Peak (PK)
FREQUENCY RANGE	1GHz ~ 40GHz		Average (AV)

ANTENNA POLARITY & TEST DISTANCE: HORIZONTAL AT 3 M

NO.	FREQ. (MHz)	EMISSION LEVEL (dBuV/m)	LIMIT (dBuV/m)	MARGIN (dB)	ANTENNA HEIGHT (m)	TABLE ANGLE (Degree)	RAW VALUE (dBuV)	CORRECTION FACTOR (dB/m)
1	*5230.00	115.2 PK			3.48 H	107	111.4	3.8
2	*5230.00	104.4 AV			3.48 H	107	100.6	3.8
3	5350.00	50.0 PK	74.0	-24.0	3.48 H	107	45.9	4.1
4	5350.00	37.6 AV	54.0	-16.4	3.48 H	107	33.5	4.1
5	#10460.00	47.1 PK	74.0	-26.9	1.61 H	266	34.0	13.1
6	#10460.00	34.1 AV	54.0	-19.9	1.61 H	266	21.0	13.1
7	15690.00	45.6 PK	74.0	-28.4	1.78 H	245	31.8	13.8
8	15690.00	32.9 AV	54.0	-21.1	1.78 H	245	19.1	13.8

ANTENNA POLARITY & TEST DISTANCE: VERTICAL AT 3 M

NO.	FREQ. (MHz)	EMISSION LEVEL (dBuV/m)	LIMIT (dBuV/m)	MARGIN (dB)	ANTENNA HEIGHT (m)	TABLE ANGLE (Degree)	RAW VALUE (dBuV)	CORRECTION FACTOR (dB/m)
1	*5230.00	103.5 PK			2.32 V	288	99.7	3.8
2	*5230.00	91.7 AV			2.32 V	288	87.9	3.8
3	5350.00	49.1 PK	74.0	-24.9	2.32 V	288	45.0	4.1
4	5350.00	36.5 AV	54.0	-17.5	2.32 V	288	32.4	4.1
5	#10460.00	45.2 PK	74.0	-28.8	1.77 V	203	32.1	13.1
6	#10460.00	32.7 AV	54.0	-21.3	1.77 V	203	19.6	13.1
7	15690.00	44.0 PK	74.0	-30.0	1.73 V	253	30.2	13.8
8	15690.00	31.9 AV	54.0	-22.1	1.73 V	253	18.1	13.8

REMARKS:

1. Emission Level(dBuV/m) = Raw Value(dBuV) + Correction Factor(dB/m)
2. Correction Factor(dB/m) = Antenna Factor(dB/m) + Cable Factor(dB) – Pre-Amplifier Factor(dB)
3. The other emission levels were very low against the limit.
4. Margin value = Emission Level – Limit value
5. " * ": Fundamental frequency.
6. " # ": The radiated frequency is out of the restricted band.

CHANNEL	TX Channel 151	DETECTOR FUNCTION	Peak (PK)
FREQUENCY RANGE	1GHz ~ 40GHz		Average (AV)

ANTENNA POLARITY & TEST DISTANCE: HORIZONTAL AT 3 M

NO.	FREQ. (MHz)	EMISSION LEVEL (dBuV/m)	LIMIT (dBuV/m)	MARGIN (dB)	ANTENNA HEIGHT (m)	TABLE ANGLE (Degree)	RAW VALUE (dBuV)	CORRECTION FACTOR (dB/m)
1	#5648.82	65.2 PK	68.2	-3.0	3.09 H	93	60.8	4.4
2	*5755.00	117.7 PK			3.09 H	93	113.3	4.4
3	*5755.00	106.3 AV			3.09 H	93	101.9	4.4
4	#5932.78	55.5 PK	68.2	-12.7	3.09 H	93	50.8	4.7
5	11510.00	46.5 PK	74.0	-27.5	1.59 H	232	32.9	13.6
6	11510.00	34.4 AV	54.0	-19.6	1.59 H	232	20.8	13.6
7	#17265.00	46.1 PK	74.0	-27.9	1.84 H	228	28.5	17.6
8	#17265.00	33.3 AV	54.0	-20.7	1.84 H	228	15.7	17.6

ANTENNA POLARITY & TEST DISTANCE: VERTICAL AT 3 M

NO.	FREQ. (MHz)	EMISSION LEVEL (dBuV/m)	LIMIT (dBuV/m)	MARGIN (dB)	ANTENNA HEIGHT (m)	TABLE ANGLE (Degree)	RAW VALUE (dBuV)	CORRECTION FACTOR (dB/m)
1	#5640.63	53.3 PK	68.2	-14.9	2.35 V	302	48.9	4.4
2	*5755.00	104.5 PK			2.35 V	302	100.1	4.4
3	*5755.00	92.6 AV			2.35 V	302	88.2	4.4
4	#5942.44	49.9 PK	68.2	-18.3	2.35 V	302	45.2	4.7
5	11510.00	46.0 PK	74.0	-28.0	1.84 V	242	32.4	13.6
6	11510.00	33.5 AV	54.0	-20.5	1.84 V	242	19.9	13.6
7	#17265.00	44.6 PK	74.0	-29.4	1.72 V	254	27.0	17.6
8	#17265.00	32.2 AV	54.0	-21.8	1.72 V	254	14.6	17.6

REMARKS:

1. Emission Level(dBuV/m) = Raw Value(dBuV) + Correction Factor(dB/m)
2. Correction Factor(dB/m) = Antenna Factor(dB/m) + Cable Factor(dB) – Pre-Amplifier Factor(dB)
3. The other emission levels were very low against the limit.
4. Margin value = Emission Level – Limit value
5. " * ": Fundamental frequency.
6. " # ": The radiated frequency is out of the restricted band.

CHANNEL	TX Channel 159	DETECTOR FUNCTION	Peak (PK)
FREQUENCY RANGE	1GHz ~ 40GHz		Average (AV)

ANTENNA POLARITY & TEST DISTANCE: HORIZONTAL AT 3 M

NO.	FREQ. (MHz)	EMISSION LEVEL (dBuV/m)	LIMIT (dBuV/m)	MARGIN (dB)	ANTENNA HEIGHT (m)	TABLE ANGLE (Degree)	RAW VALUE (dBuV)	CORRECTION FACTOR (dB/m)
1	#5638.90	58.0 PK	68.2	-10.2	3.02 H	95	53.6	4.4
2	*5795.00	118.0 PK			3.02 H	95	113.6	4.4
3	*5795.00	106.6 AV			3.02 H	95	102.2	4.4
4	#5929.38	56.7 PK	68.2	-11.5	3.02 H	95	52.0	4.7
5	11590.00	46.4 PK	74.0	-27.6	1.65 H	261	32.9	13.5
6	11590.00	34.3 AV	54.0	-19.7	1.65 H	261	20.8	13.5
7	#17385.00	46.6 PK	74.0	-27.4	1.80 H	235	28.3	18.3
8	#17385.00	33.4 AV	54.0	-20.6	1.80 H	235	15.1	18.3

ANTENNA POLARITY & TEST DISTANCE: VERTICAL AT 3 M

NO.	FREQ. (MHz)	EMISSION LEVEL (dBuV/m)	LIMIT (dBuV/m)	MARGIN (dB)	ANTENNA HEIGHT (m)	TABLE ANGLE (Degree)	RAW VALUE (dBuV)	CORRECTION FACTOR (dB/m)
1	#5587.83	50.6 PK	68.2	-17.6	2.29 V	303	46.4	4.2
2	*5795.00	104.3 PK			2.29 V	303	99.9	4.4
3	*5795.00	92.6 AV			2.29 V	303	88.2	4.4
4	#5925.01	50.5 PK	68.2	-17.7	2.29 V	303	45.8	4.7
5	11590.00	46.2 PK	74.0	-27.8	1.85 V	244	32.7	13.5
6	11590.00	33.6 AV	54.0	-20.4	1.85 V	244	20.1	13.5
7	#17385.00	45.4 PK	74.0	-28.6	1.78 V	230	27.1	18.3
8	#17385.00	32.7 AV	54.0	-21.3	1.78 V	230	14.4	18.3

REMARKS:

- Emission Level(dBuV/m) = Raw Value(dBuV) + Correction Factor(dB/m)
- Correction Factor(dB/m) = Antenna Factor(dB/m) + Cable Factor(dB) – Pre-Amplifier Factor(dB)
- The other emission levels were very low against the limit.
- Margin value = Emission Level – Limit value
- " * ": Fundamental frequency.
- " # ": The radiated frequency is out of the restricted band.

802.11ac (VHT80)

CHANNEL	TX Channel 42	DETECTOR FUNCTION	Peak (PK)
FREQUENCY RANGE	1GHz ~ 40GHz		Average (AV)

ANTENNA POLARITY & TEST DISTANCE: HORIZONTAL AT 3 M

NO.	FREQ. (MHz)	EMISSION LEVEL (dBuV/m)	LIMIT (dBuV/m)	MARGIN (dB)	ANTENNA HEIGHT (m)	TABLE ANGLE (Degree)	RAW VALUE (dBuV)	CORRECTION FACTOR (dB/m)
1	5150.00	64.4 PK	74.0	-9.6	3.94 H	98	60.7	3.7
2	5150.00	53.5 AV	54.0	-0.5	3.94 H	98	49.8	3.7
3	*5210.00	103.3 PK			3.94 H	98	99.6	3.7
4	*5210.00	94.6 AV			3.94 H	98	90.9	3.7
5	5350.00	50.5 PK	74.0	-23.5	3.94 H	98	46.4	4.1
6	5350.00	38.7 AV	54.0	-15.3	3.94 H	98	34.6	4.1
7	#10420.00	45.2 PK	74.0	-28.8	1.59 H	274	32.1	13.1
8	#10420.00	33.7 AV	54.0	-20.3	1.59 H	274	20.6	13.1
9	15630.00	44.4 PK	74.0	-29.6	1.80 H	237	30.8	13.6
10	15630.00	32.3 AV	54.0	-21.7	1.80 H	237	18.7	13.6

ANTENNA POLARITY & TEST DISTANCE: VERTICAL AT 3 M

NO.	FREQ. (MHz)	EMISSION LEVEL (dBuV/m)	LIMIT (dBuV/m)	MARGIN (dB)	ANTENNA HEIGHT (m)	TABLE ANGLE (Degree)	RAW VALUE (dBuV)	CORRECTION FACTOR (dB/m)
1	5150.00	48.5 PK	74.0	-25.5	2.37 V	293	44.8	3.7
2	5150.00	37.6 AV	54.0	-16.4	2.37 V	293	33.9	3.7
3	*5210.00	89.9 PK			2.37 V	293	86.2	3.7
4	*5210.00	80.8 AV			2.37 V	293	77.1	3.7
5	5350.00	49.7 PK	74.0	-24.3	2.37 V	293	45.6	4.1
6	5350.00	37.6 AV	54.0	-16.4	2.37 V	293	33.5	4.1
7	#10420.00	44.2 PK	74.0	-29.8	1.89 V	191	31.1	13.1
8	#10420.00	31.6 AV	54.0	-22.4	1.89 V	191	18.5	13.1
9	15630.00	43.9 PK	74.0	-30.1	1.79 V	257	30.3	13.6
10	15630.00	31.1 AV	54.0	-22.9	1.79 V	257	17.5	13.6

REMARKS:

- Emission Level(dBuV/m) = Raw Value(dBuV) + Correction Factor(dB/m)
- Correction Factor(dB/m) = Antenna Factor(dB/m) + Cable Factor(dB) – Pre-Amplifier Factor(dB)
- The other emission levels were very low against the limit.
- Margin value = Emission Level – Limit value
- " * ": Fundamental frequency.
- " # ": The radiated frequency is out of the restricted band.

CHANNEL	TX Channel 155	DETECTOR FUNCTION	Peak (PK)
FREQUENCY RANGE	1GHz ~ 40GHz		Average (AV)

ANTENNA POLARITY & TEST DISTANCE: HORIZONTAL AT 3 M

NO.	FREQ. (MHz)	EMISSION LEVEL (dBuV/m)	LIMIT (dBuV/m)	MARGIN (dB)	ANTENNA HEIGHT (m)	TABLE ANGLE (Degree)	RAW VALUE (dBuV)	CORRECTION FACTOR (dB/m)
1	#5645.48	66.3 PK	68.2	-1.9	2.53 H	96	61.9	4.4
2	*5775.00	109.8 PK			2.53 H	96	105.4	4.4
3	*5775.00	100.0 AV			2.53 H	96	95.6	4.4
4	#5932.43	55.0 PK	68.2	-13.2	2.53 H	96	50.3	4.7
5	11550.00	45.6 PK	74.0	-28.4	1.54 H	274	32.1	13.5
6	11550.00	34.1 AV	54.0	-19.9	1.54 H	274	20.6	13.5
7	#17325.00	44.7 PK	74.0	-29.3	1.82 H	245	26.9	17.8
8	#17325.00	32.5 AV	54.0	-21.5	1.82 H	245	14.7	17.8

ANTENNA POLARITY & TEST DISTANCE: VERTICAL AT 3 M

NO.	FREQ. (MHz)	EMISSION LEVEL (dBuV/m)	LIMIT (dBuV/m)	MARGIN (dB)	ANTENNA HEIGHT (m)	TABLE ANGLE (Degree)	RAW VALUE (dBuV)	CORRECTION FACTOR (dB/m)
1	#5649.70	52.1 PK	68.2	-16.1	2.35 V	305	47.7	4.4
2	*5775.00	95.8 PK			2.35 V	305	91.4	4.4
3	*5775.00	86.2 AV			2.35 V	305	81.8	4.4
4	#6010.60	50.0 PK	68.2	-18.2	2.35 V	305	45.2	4.8
5	11550.00	44.4 PK	74.0	-29.6	1.84 V	195	30.9	13.5
6	11550.00	31.9 AV	54.0	-22.1	1.84 V	195	18.4	13.5
7	#17325.00	44.1 PK	74.0	-29.9	1.76 V	269	26.3	17.8
8	#17325.00	31.3 AV	54.0	-22.7	1.76 V	269	13.5	17.8

REMARKS:

1. Emission Level(dBuV/m) = Raw Value(dBuV) + Correction Factor(dB/m)
2. Correction Factor(dB/m) = Antenna Factor(dB/m) + Cable Factor(dB) – Pre-Amplifier Factor(dB)
3. The other emission levels were very low against the limit.
4. Margin value = Emission Level – Limit value
5. " * ": Fundamental frequency.
6. " # ": The radiated frequency is out of the restricted band.

802.11ac (VHT80+80)

CHANNEL	TX Channel 42+155	DETECTOR FUNCTION	Peak (PK)
FREQUENCY RANGE	1GHz ~ 40GHz		Average (AV)

ANTENNA POLARITY & TEST DISTANCE: HORIZONTAL AT 3 M

NO.	FREQ. (MHz)	EMISSION LEVEL (dBuV/m)	LIMIT (dBuV/m)	MARGIN (dB)	ANTENNA HEIGHT (m)	TABLE ANGLE (Degree)	RAW VALUE (dBuV)	CORRECTION FACTOR (dB/m)
1	5150.00	63.7 PK	74.0	-10.3	3.12 H	287	60.0	3.7
2	5150.00	53.7 AV	54.0	-0.3	3.12 H	287	50.0	3.7
3	*5210.00	100.7 PK			3.12 H	287	97.0	3.7
4	*5210.00	90.1 AV			3.12 H	287	86.4	3.7
5	5350.00	50.1 PK	74.0	-23.9	3.12 H	287	46.0	4.1
6	5350.00	39.0 AV	54.0	-15.0	3.12 H	287	34.9	4.1
7	#5611.68	58.8 PK	68.2	-9.4	2.62 H	200	54.4	4.4
8	*5775.00	99.4 PK			2.62 H	200	95.0	4.4
9	*5775.00	88.7 AV			2.62 H	200	84.3	4.4
10	#5968.50	59.6 PK	68.2	-8.6	2.62 H	200	54.9	4.7
11	#10420.00	44.5 PK	74.0	-29.5	1.63 H	266	31.4	13.1
12	#10420.00	33.3 AV	54.0	-20.7	1.63 H	266	20.2	13.1
13	11550.00	44.7 PK	74.0	-29.3	1.59 H	270	31.2	13.5
14	11550.00	33.2 AV	54.0	-20.8	1.59 H	270	19.7	13.5
15	15630.00	43.3 PK	74.0	-30.7	1.81 H	244	29.7	13.6
16	15630.00	31.6 AV	54.0	-22.4	1.81 H	244	18.0	13.6
17	#17325.00	43.7 PK	74.0	-30.3	1.83 H	236	25.9	17.8
18	#17325.00	31.2 AV	54.0	-22.8	1.83 H	236	13.4	17.8

ANTENNA POLARITY & TEST DISTANCE: VERTICAL AT 3 M

NO.	FREQ. (MHz)	EMISSION LEVEL (dBuV/m)	LIMIT (dBuV/m)	MARGIN (dB)	ANTENNA HEIGHT (m)	TABLE ANGLE (Degree)	RAW VALUE (dBuV)	CORRECTION FACTOR (dB/m)
1	5150.00	48.3 PK	74.0	-25.7	1.75 V	214	44.6	3.7
2	5150.00	37.4 AV	54.0	-16.6	1.75 V	214	33.7	3.7
3	*5210.00	84.3 PK			1.75 V	214	80.6	3.7
4	*5210.00	76.2 AV			1.75 V	214	72.5	3.7
5	5350.00	49.6 PK	74.0	-24.4	1.75 V	214	45.5	4.1
6	5350.00	37.5 AV	54.0	-16.5	1.75 V	214	33.4	4.1
7	#5606.47	57.8 PK	68.2	-10.4	1.50 V	158	53.4	4.4
8	*5775.00	83.2 PK			1.50 V	158	78.8	4.4
9	*5775.00	74.3 AV			1.50 V	158	69.9	4.4
10	#5959.60	58.1 PK	68.2	-10.1	1.50 V	158	53.4	4.7
11	#10420.00	43.8 PK	74.0	-30.2	1.89 V	199	30.7	13.1
12	#10420.00	32.8 AV	54.0	-21.2	1.89 V	199	19.7	13.1
13	11550.00	43.9 PK	74.0	-30.1	1.81 V	194	30.4	13.5
14	11550.00	32.3 AV	54.0	-21.7	1.81 V	194	18.8	13.5
15	15630.00	42.9 PK	74.0	-31.1	1.80 V	255	29.3	13.6
16	15630.00	31.1 AV	54.0	-22.9	1.80 V	255	17.5	13.6
17	#17325.00	43.1 PK	74.0	-30.9	1.72 V	254	25.3	17.8
18	#17325.00	30.6 AV	54.0	-23.4	1.72 V	254	12.8	17.8

REMARKS:

1. Emission Level(dBuV/m) = Raw Value(dBuV) + Correction Factor(dB/m)
2. Correction Factor(dB/m) = Antenna Factor(dB/m) + Cable Factor(dB) – Pre-Amplifier Factor(dB)
3. The other emission levels were very low against the limit.
4. Margin value = Emission Level – Limit value
5. " * ": Fundamental frequency.
6. " # ": The radiated frequency is out of the restricted band.

4.1.10 Test Results (Mode 4)

Above 1GHz Data:

802.11a

CHANNEL	TX Channel 36	DETECTOR FUNCTION	Peak (PK)
FREQUENCY RANGE	1GHz ~ 40GHz		Average (AV)

ANTENNA POLARITY & TEST DISTANCE: HORIZONTAL AT 3 M								
NO.	FREQ. (MHz)	EMISSION LEVEL (dBuV/m)	LIMIT (dBuV/m)	MARGIN (dB)	ANTENNA HEIGHT (m)	TABLE ANGLE (Degree)	RAW VALUE (dBuV)	CORRECTION FACTOR (dB/m)
1	5150.00	64.9 PK	74.0	-9.1	3.55 H	113	61.2	3.7
2	5150.00	53.4 AV	54.0	-0.6	3.55 H	113	49.7	3.7
3	*5180.00	113.4 PK			3.55 H	113	109.7	3.7
4	*5180.00	103.7 AV			3.55 H	113	100.0	3.7
5	#10360.00	45.7 PK	74.0	-28.3	1.77 H	210	32.7	13.0
6	#10360.00	33.6 AV	54.0	-20.4	1.77 H	210	20.6	13.0
7	15540.00	46.8 PK	74.0	-27.2	1.41 H	211	33.7	13.1
8	15540.00	34.1 AV	54.0	-19.9	1.41 H	211	21.0	13.1

ANTENNA POLARITY & TEST DISTANCE: VERTICAL AT 3 M								
NO.	FREQ. (MHz)	EMISSION LEVEL (dBuV/m)	LIMIT (dBuV/m)	MARGIN (dB)	ANTENNA HEIGHT (m)	TABLE ANGLE (Degree)	RAW VALUE (dBuV)	CORRECTION FACTOR (dB/m)
1	5150.00	51.7 PK	74.0	-22.3	2.48 V	313	48.0	3.7
2	5150.00	46.5 AV	54.0	-7.5	2.48 V	313	42.8	3.7
3	*5180.00	102.5 PK			2.48 V	313	98.8	3.7
4	*5180.00	93.6 AV			2.48 V	313	89.9	3.7
5	#10360.00	45.6 PK	74.0	-28.4	1.00 V	138	32.6	13.0
6	#10360.00	33.2 AV	54.0	-20.8	1.00 V	138	20.2	13.0
7	15540.00	46.6 PK	74.0	-27.4	1.00 V	171	33.5	13.1
8	15540.00	34.0 AV	54.0	-20.0	1.00 V	171	20.9	13.1

REMARKS:

- Emission Level(dBuV/m) = Raw Value(dBuV) + Correction Factor(dB/m)
- Correction Factor(dB/m) = Antenna Factor(dB/m) + Cable Factor(dB) – Pre-Amplifier Factor(dB)
- The other emission levels were very low against the limit.
- Margin value = Emission Level – Limit value
- " * ": Fundamental frequency.
- " # ": The radiated frequency is out of the restricted band.

CHANNEL	TX Channel 40	DETECTOR FUNCTION	Peak (PK)
FREQUENCY RANGE	1GHz ~ 40GHz		Average (AV)

ANTENNA POLARITY & TEST DISTANCE: HORIZONTAL AT 3 M

NO.	FREQ. (MHz)	EMISSION LEVEL (dBuV/m)	LIMIT (dBuV/m)	MARGIN (dB)	ANTENNA HEIGHT (m)	TABLE ANGLE (Degree)	RAW VALUE (dBuV)	CORRECTION FACTOR (dB/m)
1	5150.00	63.4 PK	74.0	-10.6	3.36 H	112	59.7	3.7
2	5150.00	50.3 AV	54.0	-3.7	3.36 H	112	46.6	3.7
3	*5200.00	116.8 PK			3.36 H	112	113.1	3.7
4	*5200.00	106.7 AV			3.36 H	112	103.0	3.7
5	5350.00	50.1 PK	74.0	-23.9	3.36 H	112	46.0	4.1
6	5350.00	37.6 AV	54.0	-16.4	3.36 H	112	33.5	4.1
7	#10400.00	46.3 PK	74.0	-27.7	1.72 H	227	33.3	13.0
8	#10400.00	34.2 AV	54.0	-19.8	1.72 H	227	21.2	13.0
9	15600.00	47.8 PK	74.0	-26.2	1.49 H	220	34.5	13.3
10	15600.00	35.1 AV	54.0	-18.9	1.49 H	220	21.8	13.3

ANTENNA POLARITY & TEST DISTANCE: VERTICAL AT 3 M

NO.	FREQ. (MHz)	EMISSION LEVEL (dBuV/m)	LIMIT (dBuV/m)	MARGIN (dB)	ANTENNA HEIGHT (m)	TABLE ANGLE (Degree)	RAW VALUE (dBuV)	CORRECTION FACTOR (dB/m)
1	5150.00	50.9 PK	74.0	-23.1	2.42 V	313	47.2	3.7
2	5150.00	41.7 AV	54.0	-12.3	2.42 V	313	38.0	3.7
3	*5200.00	105.5 PK			2.42 V	313	101.8	3.7
4	*5200.00	96.0 AV			2.42 V	313	92.3	3.7
5	5350.00	47.9 PK	74.0	-26.1	2.42 V	313	43.8	4.1
6	5350.00	36.4 AV	54.0	-17.6	2.42 V	313	32.3	4.1
7	#10400.00	46.1 PK	74.0	-27.9	1.00 V	140	33.1	13.0
8	#10400.00	33.9 AV	54.0	-20.1	1.00 V	140	20.9	13.0
9	15600.00	47.6 PK	74.0	-26.4	1.00 V	169	34.3	13.3
10	15600.00	34.8 AV	54.0	-19.2	1.00 V	169	21.5	13.3

REMARKS:

1. Emission Level(dBuV/m) = Raw Value(dBuV) + Correction Factor(dB/m)
2. Correction Factor(dB/m) = Antenna Factor(dB/m) + Cable Factor(dB) – Pre-Amplifier Factor(dB)
3. The other emission levels were very low against the limit.
4. Margin value = Emission Level – Limit value
5. " * ": Fundamental frequency.
6. " # ": The radiated frequency is out of the restricted band.

CHANNEL	TX Channel 48	DETECTOR FUNCTION	Peak (PK)
FREQUENCY RANGE	1GHz ~ 40GHz		Average (AV)

ANTENNA POLARITY & TEST DISTANCE: HORIZONTAL AT 3 M

NO.	FREQ. (MHz)	EMISSION LEVEL (dBuV/m)	LIMIT (dBuV/m)	MARGIN (dB)	ANTENNA HEIGHT (m)	TABLE ANGLE (Degree)	RAW VALUE (dBuV)	CORRECTION FACTOR (dB/m)
1	*5240.00	115.2 PK			3.49 H	110	111.4	3.8
2	*5240.00	105.0 AV			3.49 H	110	101.2	3.8
3	5350.00	49.4 PK	74.0	-24.6	3.49 H	110	45.3	4.1
4	5350.00	38.0 AV	54.0	-16.0	3.49 H	110	33.9	4.1
5	#10480.00	45.9 PK	74.0	-28.1	1.73 H	214	32.7	13.2
6	#10480.00	33.8 AV	54.0	-20.2	1.73 H	214	20.6	13.2
7	15720.00	47.3 PK	74.0	-26.7	1.47 H	225	33.7	13.6
8	15720.00	34.2 AV	54.0	-19.8	1.47 H	225	20.6	13.6

ANTENNA POLARITY & TEST DISTANCE: VERTICAL AT 3 M

NO.	FREQ. (MHz)	EMISSION LEVEL (dBuV/m)	LIMIT (dBuV/m)	MARGIN (dB)	ANTENNA HEIGHT (m)	TABLE ANGLE (Degree)	RAW VALUE (dBuV)	CORRECTION FACTOR (dB/m)
1	*5240.00	104.3 PK			2.42 V	293	100.5	3.8
2	*5240.00	95.2 AV			2.42 V	293	91.4	3.8
3	5350.00	46.8 PK	74.0	-27.2	2.42 V	293	42.7	4.1
4	5350.00	36.9 AV	54.0	-17.1	2.42 V	293	32.8	4.1
5	#10480.00	45.8 PK	74.0	-28.2	1.00 V	148	32.6	13.2
6	#10480.00	33.6 AV	54.0	-20.4	1.00 V	148	20.4	13.2
7	15720.00	47.2 PK	74.0	-26.8	1.00 V	174	33.6	13.6
8	15720.00	34.0 AV	54.0	-20.0	1.00 V	174	20.4	13.6

REMARKS:

- Emission Level(dBuV/m) = Raw Value(dBuV) + Correction Factor(dB/m)
- Correction Factor(dB/m) = Antenna Factor(dB/m) + Cable Factor(dB) – Pre-Amplifier Factor(dB)
- The other emission levels were very low against the limit.
- Margin value = Emission Level – Limit value
- " * ": Fundamental frequency.
- " # ": The radiated frequency is out of the restricted band.

CHANNEL	TX Channel 149	DETECTOR FUNCTION	Peak (PK)
FREQUENCY RANGE	1GHz ~ 40GHz		Average (AV)

ANTENNA POLARITY & TEST DISTANCE: HORIZONTAL AT 3 M

NO.	FREQ. (MHz)	EMISSION LEVEL (dBuV/m)	LIMIT (dBuV/m)	MARGIN (dB)	ANTENNA HEIGHT (m)	TABLE ANGLE (Degree)	RAW VALUE (dBuV)	CORRECTION FACTOR (dB/m)
1	#5612.14	54.7 PK	68.2	-13.5	2.91 H	95	50.3	4.4
2	*5745.00	117.9 PK			2.91 H	95	113.5	4.4
3	*5745.00	107.4 AV			2.91 H	95	103.0	4.4
4	#5989.78	54.5 PK	68.2	-13.7	2.91 H	95	49.8	4.7
5	11490.00	46.1 PK	74.0	-27.9	1.68 H	231	32.6	13.5
6	11490.00	33.9 AV	54.0	-20.1	1.68 H	231	20.4	13.5
7	#17235.00	47.8 PK	74.0	-26.2	1.53 H	216	30.5	17.3
8	#17235.00	35.4 AV	54.0	-18.6	1.53 H	216	18.1	17.3

ANTENNA POLARITY & TEST DISTANCE: VERTICAL AT 3 M

NO.	FREQ. (MHz)	EMISSION LEVEL (dBuV/m)	LIMIT (dBuV/m)	MARGIN (dB)	ANTENNA HEIGHT (m)	TABLE ANGLE (Degree)	RAW VALUE (dBuV)	CORRECTION FACTOR (dB/m)
1	#5621.84	51.6 PK	68.2	-16.6	2.43 V	308	47.2	4.4
2	*5745.00	104.1 PK			2.43 V	308	99.7	4.4
3	*5745.00	93.8 AV			2.43 V	308	89.4	4.4
4	#5970.32	50.2 PK	68.2	-18.0	2.43 V	308	45.5	4.7
5	11490.00	46.0 PK	74.0	-28.0	1.00 V	134	32.5	13.5
6	11490.00	34.1 AV	54.0	-19.9	1.00 V	134	20.6	13.5
7	#17235.00	47.9 PK	74.0	-26.1	1.00 V	164	30.6	17.3
8	#17235.00	34.9 AV	54.0	-19.1	1.00 V	164	17.6	17.3

REMARKS:

1. Emission Level(dBuV/m) = Raw Value(dBuV) + Correction Factor(dB/m)
2. Correction Factor(dB/m) = Antenna Factor(dB/m) + Cable Factor(dB) – Pre-Amplifier Factor(dB)
3. The other emission levels were very low against the limit.
4. Margin value = Emission Level – Limit value
5. " * ": Fundamental frequency.
6. " # ": The radiated frequency is out of the restricted band.

CHANNEL	TX Channel 157	DETECTOR FUNCTION	Peak (PK)
FREQUENCY RANGE	1GHz ~ 40GHz		Average (AV)

ANTENNA POLARITY & TEST DISTANCE: HORIZONTAL AT 3 M

NO.	FREQ. (MHz)	EMISSION LEVEL (dBuV/m)	LIMIT (dBuV/m)	MARGIN (dB)	ANTENNA HEIGHT (m)	TABLE ANGLE (Degree)	RAW VALUE (dBuV)	CORRECTION FACTOR (dB/m)
1	#5623.44	54.4 PK	68.2	-13.8	3.04 H	95	50.0	4.4
2	*5785.00	117.4 PK			3.04 H	95	113.0	4.4
3	*5785.00	107.2 AV			3.04 H	95	102.8	4.4
4	#5961.68	54.5 PK	68.2	-13.7	3.04 H	95	49.8	4.7
5	11570.00	46.0 PK	74.0	-28.0	1.73 H	245	32.5	13.5
6	11570.00	33.9 AV	54.0	-20.1	1.73 H	245	20.4	13.5
7	#17355.00	47.9 PK	74.0	-26.1	1.48 H	219	29.9	18.0
8	#17355.00	35.8 AV	54.0	-18.2	1.48 H	219	17.8	18.0

ANTENNA POLARITY & TEST DISTANCE: VERTICAL AT 3 M

NO.	FREQ. (MHz)	EMISSION LEVEL (dBuV/m)	LIMIT (dBuV/m)	MARGIN (dB)	ANTENNA HEIGHT (m)	TABLE ANGLE (Degree)	RAW VALUE (dBuV)	CORRECTION FACTOR (dB/m)
1	#5623.73	50.1 PK	68.2	-18.1	2.59 V	310	45.7	4.4
2	*5785.00	103.9 PK			2.59 V	310	99.5	4.4
3	*5785.00	93.4 AV			2.59 V	310	89.0	4.4
4	#5990.66	50.3 PK	68.2	-17.9	2.59 V	310	45.6	4.7
5	11570.00	45.7 PK	74.0	-28.3	1.00 V	150	32.2	13.5
6	11570.00	33.6 AV	54.0	-20.4	1.00 V	150	20.1	13.5
7	#17355.00	47.0 PK	74.0	-27.0	1.00 V	164	29.0	18.0
8	#17355.00	34.4 AV	54.0	-19.6	1.00 V	164	16.4	18.0

REMARKS:

1. Emission Level(dBuV/m) = Raw Value(dBuV) + Correction Factor(dB/m)
2. Correction Factor(dB/m) = Antenna Factor(dB/m) + Cable Factor(dB) – Pre-Amplifier Factor(dB)
3. The other emission levels were very low against the limit.
4. Margin value = Emission Level – Limit value
5. " * ": Fundamental frequency.
6. " # ": The radiated frequency is out of the restricted band.

CHANNEL	TX Channel 165	DETECTOR FUNCTION	Peak (PK)
FREQUENCY RANGE	1GHz ~ 40GHz		Average (AV)

ANTENNA POLARITY & TEST DISTANCE: HORIZONTAL AT 3 M

NO.	FREQ. (MHz)	EMISSION LEVEL (dBuV/m)	LIMIT (dBuV/m)	MARGIN (dB)	ANTENNA HEIGHT (m)	TABLE ANGLE (Degree)	RAW VALUE (dBuV)	CORRECTION FACTOR (dB/m)
1	#5640.89	53.9 PK	68.2	-14.3	3.03 H	96	49.5	4.4
2	*5825.00	117.2 PK			3.03 H	96	112.8	4.4
3	*5825.00	106.9 AV			3.03 H	96	102.5	4.4
4	#5962.60	53.7 PK	68.2	-14.5	3.03 H	96	49.0	4.7
5	11650.00	45.9 PK	74.0	-28.1	1.68 H	236	32.2	13.7
6	11650.00	33.6 AV	54.0	-20.4	1.68 H	236	19.9	13.7
7	#17475.00	47.5 PK	74.0	-26.5	1.48 H	228	28.9	18.6
8	#17475.00	35.5 AV	54.0	-18.5	1.48 H	228	16.9	18.6

ANTENNA POLARITY & TEST DISTANCE: VERTICAL AT 3 M

NO.	FREQ. (MHz)	EMISSION LEVEL (dBuV/m)	LIMIT (dBuV/m)	MARGIN (dB)	ANTENNA HEIGHT (m)	TABLE ANGLE (Degree)	RAW VALUE (dBuV)	CORRECTION FACTOR (dB/m)
1	#5608.73	53.1 PK	68.2	-15.1	2.43 V	310	48.7	4.4
2	*5825.00	103.6 PK			2.43 V	310	99.2	4.4
3	*5825.00	93.3 AV			2.43 V	310	88.9	4.4
4	#5926.54	54.0 PK	68.2	-14.2	2.43 V	310	49.3	4.7
5	11650.00	45.6 PK	74.0	-28.4	1.00 V	131	31.9	13.7
6	11650.00	33.5 AV	54.0	-20.5	1.00 V	131	19.8	13.7
7	#17475.00	47.7 PK	74.0	-26.3	1.00 V	182	29.1	18.6
8	#17475.00	34.9 AV	54.0	-19.1	1.00 V	182	16.3	18.6

REMARKS:

1. Emission Level(dBuV/m) = Raw Value(dBuV) + Correction Factor(dB/m)
2. Correction Factor(dB/m) = Antenna Factor(dB/m) + Cable Factor(dB) – Pre-Amplifier Factor(dB)
3. The other emission levels were very low against the limit.
4. Margin value = Emission Level – Limit value
5. " * ": Fundamental frequency.
6. " # ": The radiated frequency is out of the restricted band.

802.11ac (VHT20)

CHANNEL	TX Channel 36	DETECTOR FUNCTION	Peak (PK)
FREQUENCY RANGE	1GHz ~ 40GHz		Average (AV)

ANTENNA POLARITY & TEST DISTANCE: HORIZONTAL AT 3 M

NO.	FREQ. (MHz)	EMISSION LEVEL (dBuV/m)	LIMIT (dBuV/m)	MARGIN (dB)	ANTENNA HEIGHT (m)	TABLE ANGLE (Degree)	RAW VALUE (dBuV)	CORRECTION FACTOR (dB/m)
1	5150.00	67.4 PK	74.0	-6.6	3.60 H	111	63.7	3.7
2	5150.00	53.9 AV	54.0	-0.1	3.60 H	111	50.2	3.7
3	*5180.00	113.7 PK			3.60 H	111	110.0	3.7
4	*5180.00	102.4 AV			3.60 H	111	98.7	3.7
5	#10360.00	46.1 PK	74.0	-27.9	1.72 H	229	33.1	13.0
6	#10360.00	34.8 AV	54.0	-19.2	1.72 H	229	21.8	13.0
7	15540.00	46.6 PK	74.0	-27.4	1.52 H	210	33.5	13.1
8	15540.00	35.1 AV	54.0	-18.9	1.52 H	210	22.0	13.1

ANTENNA POLARITY & TEST DISTANCE: VERTICAL AT 3 M

NO.	FREQ. (MHz)	EMISSION LEVEL (dBuV/m)	LIMIT (dBuV/m)	MARGIN (dB)	ANTENNA HEIGHT (m)	TABLE ANGLE (Degree)	RAW VALUE (dBuV)	CORRECTION FACTOR (dB/m)
1	5150.00	54.6 PK	74.0	-19.4	2.53 V	317	50.9	3.7
2	5150.00	46.8 AV	54.0	-7.2	2.53 V	317	43.1	3.7
3	*5180.00	102.8 PK			2.53 V	317	99.1	3.7
4	*5180.00	92.7 AV			2.53 V	317	89.0	3.7
5	#10360.00	45.8 PK	74.0	-28.2	1.34 V	213	32.8	13.0
6	#10360.00	34.3 AV	54.0	-19.7	1.34 V	213	21.3	13.0
7	15540.00	46.2 PK	74.0	-27.8	1.82 V	161	33.1	13.1
8	15540.00	34.8 AV	54.0	-19.2	1.82 V	161	21.7	13.1

REMARKS:

- Emission Level(dBuV/m) = Raw Value(dBuV) + Correction Factor(dB/m)
- Correction Factor(dB/m) = Antenna Factor(dB/m) + Cable Factor(dB) – Pre-Amplifier Factor(dB)
- The other emission levels were very low against the limit.
- Margin value = Emission Level – Limit value
- " * ": Fundamental frequency.
- " # ": The radiated frequency is out of the restricted band.

CHANNEL	TX Channel 40	DETECTOR FUNCTION	Peak (PK)
FREQUENCY RANGE	1GHz ~ 40GHz		Average (AV)

ANTENNA POLARITY & TEST DISTANCE: HORIZONTAL AT 3 M

NO.	FREQ. (MHz)	EMISSION LEVEL (dBuV/m)	LIMIT (dBuV/m)	MARGIN (dB)	ANTENNA HEIGHT (m)	TABLE ANGLE (Degree)	RAW VALUE (dBuV)	CORRECTION FACTOR (dB/m)
1	5150.00	64.8 PK	74.0	-9.2	3.56 H	115	61.1	3.7
2	5150.00	52.0 AV	54.0	-2.0	3.56 H	115	48.3	3.7
3	*5200.00	116.2 PK			3.56 H	115	112.5	3.7
4	*5200.00	106.8 AV			3.56 H	115	103.1	3.7
5	5350.00	49.2 PK	74.0	-24.8	3.56 H	115	45.1	4.1
6	5350.00	38.5 AV	54.0	-15.5	3.56 H	115	34.4	4.1
7	#10400.00	46.5 PK	74.0	-27.5	1.71 H	214	33.5	13.0
8	#10400.00	35.2 AV	54.0	-18.8	1.71 H	214	22.2	13.0
9	15600.00	47.5 PK	74.0	-26.5	1.51 H	229	34.2	13.3
10	15600.00	35.8 AV	54.0	-18.2	1.51 H	229	22.5	13.3

ANTENNA POLARITY & TEST DISTANCE: VERTICAL AT 3 M

NO.	FREQ. (MHz)	EMISSION LEVEL (dBuV/m)	LIMIT (dBuV/m)	MARGIN (dB)	ANTENNA HEIGHT (m)	TABLE ANGLE (Degree)	RAW VALUE (dBuV)	CORRECTION FACTOR (dB/m)
1	5150.00	51.9 PK	74.0	-22.1	2.46 V	303	48.2	3.7
2	5150.00	45.3 AV	54.0	-8.7	2.46 V	303	41.6	3.7
3	*5200.00	105.3 PK			2.46 V	303	101.6	3.7
4	*5200.00	96.7 AV			2.46 V	303	93.0	3.7
5	5350.00	46.3 PK	74.0	-27.7	2.46 V	303	42.2	4.1
6	5350.00	37.4 AV	54.0	-16.6	2.46 V	303	33.3	4.1
7	#10400.00	46.0 PK	74.0	-28.0	1.38 V	215	33.0	13.0
8	#10400.00	35.1 AV	54.0	-18.9	1.38 V	215	22.1	13.0
9	15600.00	46.4 PK	74.0	-27.6	1.79 V	170	33.1	13.3
10	15600.00	34.8 AV	54.0	-19.2	1.79 V	170	21.5	13.3

REMARKS:

1. Emission Level(dBuV/m) = Raw Value(dBuV) + Correction Factor(dB/m)
2. Correction Factor(dB/m) = Antenna Factor(dB/m) + Cable Factor(dB) – Pre-Amplifier Factor(dB)
3. The other emission levels were very low against the limit.
4. Margin value = Emission Level – Limit value
5. " * ": Fundamental frequency.
6. " # ": The radiated frequency is out of the restricted band.

CHANNEL	TX Channel 48	DETECTOR FUNCTION	Peak (PK)
FREQUENCY RANGE	1GHz ~ 40GHz		Average (AV)

ANTENNA POLARITY & TEST DISTANCE: HORIZONTAL AT 3 M

NO.	FREQ. (MHz)	EMISSION LEVEL (dBuV/m)	LIMIT (dBuV/m)	MARGIN (dB)	ANTENNA HEIGHT (m)	TABLE ANGLE (Degree)	RAW VALUE (dBuV)	CORRECTION FACTOR (dB/m)
1	*5240.00	115.5 PK			3.52 H	118	111.7	3.8
2	*5240.00	105.5 AV			3.52 H	118	101.7	3.8
3	5350.00	49.5 PK	74.0	-24.5	3.52 H	118	45.4	4.1
4	5350.00	39.1 AV	54.0	-14.9	3.52 H	118	35.0	4.1
5	#10480.00	46.2 PK	74.0	-27.8	1.68 H	210	33.0	13.2
6	#10480.00	35.0 AV	54.0	-19.0	1.68 H	210	21.8	13.2
7	15720.00	46.8 PK	74.0	-27.2	1.45 H	227	33.2	13.6
8	15720.00	35.3 AV	54.0	-18.7	1.45 H	227	21.7	13.6

ANTENNA POLARITY & TEST DISTANCE: VERTICAL AT 3 M

NO.	FREQ. (MHz)	EMISSION LEVEL (dBuV/m)	LIMIT (dBuV/m)	MARGIN (dB)	ANTENNA HEIGHT (m)	TABLE ANGLE (Degree)	RAW VALUE (dBuV)	CORRECTION FACTOR (dB/m)
1	*5240.00	104.6 PK			2.56 V	294	100.8	3.8
2	*5240.00	95.7 AV			2.56 V	294	91.9	3.8
3	5350.00	46.3 PK	74.0	-27.7	2.56 V	294	42.2	4.1
4	5350.00	38.0 AV	54.0	-16.0	2.56 V	294	33.9	4.1
5	#10480.00	46.1 PK	74.0	-27.9	1.43 V	213	32.9	13.2
6	#10480.00	34.9 AV	54.0	-19.1	1.43 V	213	21.7	13.2
7	15720.00	46.6 PK	74.0	-27.4	1.72 V	147	33.0	13.6
8	15720.00	35.1 AV	54.0	-18.9	1.72 V	147	21.5	13.6

REMARKS:

1. Emission Level(dBuV/m) = Raw Value(dBuV) + Correction Factor(dB/m)
2. Correction Factor(dB/m) = Antenna Factor(dB/m) + Cable Factor(dB) – Pre-Amplifier Factor(dB)
3. The other emission levels were very low against the limit.
4. Margin value = Emission Level – Limit value
5. " * ": Fundamental frequency.
6. " # ": The radiated frequency is out of the restricted band.

CHANNEL	TX Channel 149	DETECTOR FUNCTION	Peak (PK)
FREQUENCY RANGE	1GHz ~ 40GHz		Average (AV)

ANTENNA POLARITY & TEST DISTANCE: HORIZONTAL AT 3 M

NO.	FREQ. (MHz)	EMISSION LEVEL (dBuV/m)	LIMIT (dBuV/m)	MARGIN (dB)	ANTENNA HEIGHT (m)	TABLE ANGLE (Degree)	RAW VALUE (dBuV)	CORRECTION FACTOR (dB/m)
1	#5643.75	55.1 PK	68.2	-13.1	2.76 H	99	50.7	4.4
2	*5745.00	117.4 PK			2.76 H	99	113.0	4.4
3	*5745.00	107.7 AV			2.76 H	99	103.3	4.4
4	#5971.44	54.4 PK	68.2	-13.8	2.76 H	99	49.7	4.7
5	11490.00	46.3 PK	74.0	-27.7	1.71 H	199	32.8	13.5
6	11490.00	35.2 AV	54.0	-18.8	1.71 H	199	21.7	13.5
7	#17235.00	46.9 PK	74.0	-27.1	1.47 H	218	29.6	17.3
8	#17235.00	35.4 AV	54.0	-18.6	1.47 H	218	18.1	17.3

ANTENNA POLARITY & TEST DISTANCE: VERTICAL AT 3 M

NO.	FREQ. (MHz)	EMISSION LEVEL (dBuV/m)	LIMIT (dBuV/m)	MARGIN (dB)	ANTENNA HEIGHT (m)	TABLE ANGLE (Degree)	RAW VALUE (dBuV)	CORRECTION FACTOR (dB/m)
1	#5614.22	50.4 PK	68.2	-17.8	2.51 V	310	46.0	4.4
2	*5745.00	104.8 PK			2.51 V	310	100.4	4.4
3	*5745.00	92.8 AV			2.51 V	310	88.4	4.4
4	#5978.84	51.1 PK	68.2	-17.1	2.51 V	310	46.4	4.7
5	11490.00	46.2 PK	74.0	-27.8	1.43 V	201	32.7	13.5
6	11490.00	35.0 AV	54.0	-19.0	1.43 V	201	21.5	13.5
7	#17235.00	46.7 PK	74.0	-27.3	1.77 V	163	29.4	17.3
8	#17235.00	35.2 AV	54.0	-18.8	1.77 V	163	17.9	17.3

REMARKS:

1. Emission Level(dBuV/m) = Raw Value(dBuV) + Correction Factor(dB/m)
2. Correction Factor(dB/m) = Antenna Factor(dB/m) + Cable Factor(dB) – Pre-Amplifier Factor(dB)
3. The other emission levels were very low against the limit.
4. Margin value = Emission Level – Limit value
5. " * ": Fundamental frequency.
6. " # ": The radiated frequency is out of the restricted band.

CHANNEL	TX Channel 157	DETECTOR FUNCTION	Peak (PK)
FREQUENCY RANGE	1GHz ~ 40GHz		Average (AV)

ANTENNA POLARITY & TEST DISTANCE: HORIZONTAL AT 3 M

NO.	FREQ. (MHz)	EMISSION LEVEL (dBuV/m)	LIMIT (dBuV/m)	MARGIN (dB)	ANTENNA HEIGHT (m)	TABLE ANGLE (Degree)	RAW VALUE (dBuV)	CORRECTION FACTOR (dB/m)
1	#5623.71	53.8 PK	68.2	-14.4	3.04 H	94	49.4	4.4
2	*5785.00	117.2 PK			3.03 H	94	112.8	4.4
3	*5785.00	107.5 AV			3.03 H	94	103.1	4.4
4	#6019.49	53.8 PK	68.2	-14.4	3.04 H	94	49.0	4.8
5	11570.00	46.6 PK	74.0	-27.4	1.73 H	220	33.1	13.5
6	11570.00	35.6 AV	54.0	-18.4	1.73 H	220	22.1	13.5
7	#17355.00	47.3 PK	74.0	-26.7	1.44 H	211	29.3	18.0
8	#17355.00	35.6 AV	54.0	-18.4	1.44 H	211	17.6	18.0

ANTENNA POLARITY & TEST DISTANCE: VERTICAL AT 3 M

NO.	FREQ. (MHz)	EMISSION LEVEL (dBuV/m)	LIMIT (dBuV/m)	MARGIN (dB)	ANTENNA HEIGHT (m)	TABLE ANGLE (Degree)	RAW VALUE (dBuV)	CORRECTION FACTOR (dB/m)
1	#5604.57	50.3 PK	68.2	-17.9	2.50 V	313	45.9	4.4
2	*5785.00	104.4 PK			2.50 V	313	100.0	4.4
3	*5785.00	92.6 AV			2.50 V	313	88.2	4.4
4	#5994.67	50.3 PK	68.2	-17.9	2.50 V	313	45.6	4.7
5	11570.00	46.1 PK	74.0	-27.9	1.44 V	204	32.6	13.5
6	11570.00	35.0 AV	54.0	-19.0	1.44 V	204	21.5	13.5
7	#17355.00	47.2 PK	74.0	-26.8	1.73 V	142	29.2	18.0
8	#17355.00	35.4 AV	54.0	-18.6	1.73 V	142	17.4	18.0

REMARKS:

1. Emission Level(dBuV/m) = Raw Value(dBuV) + Correction Factor(dB/m)
2. Correction Factor(dB/m) = Antenna Factor(dB/m) + Cable Factor(dB) – Pre-Amplifier Factor(dB)
3. The other emission levels were very low against the limit.
4. Margin value = Emission Level – Limit value
5. " * ": Fundamental frequency.
6. " # ": The radiated frequency is out of the restricted band.

CHANNEL	TX Channel 165	DETECTOR FUNCTION	Peak (PK)
FREQUENCY RANGE	1GHz ~ 40GHz		Average (AV)

ANTENNA POLARITY & TEST DISTANCE: HORIZONTAL AT 3 M

NO.	FREQ. (MHz)	EMISSION LEVEL (dBuV/m)	LIMIT (dBuV/m)	MARGIN (dB)	ANTENNA HEIGHT (m)	TABLE ANGLE (Degree)	RAW VALUE (dBuV)	CORRECTION FACTOR (dB/m)
1	#5635.43	54.0 PK	68.2	-14.2	3.05 H	98	49.6	4.4
2	*5825.00	117.1 PK			3.05 H	98	112.7	4.4
3	*5825.00	107.0 AV			3.05 H	98	102.6	4.4
4	#5938.62	54.3 PK	68.2	-13.9	3.05 H	98	49.6	4.7
5	11650.00	46.3 PK	74.0	-27.7	1.72 H	196	32.6	13.7
6	11650.00	34.9 AV	54.0	-19.1	1.72 H	196	21.2	13.7
7	#17475.00	46.9 PK	74.0	-27.1	1.44 H	241	28.3	18.6
8	#17475.00	35.4 AV	54.0	-18.6	1.44 H	241	16.8	18.6

ANTENNA POLARITY & TEST DISTANCE: VERTICAL AT 3 M

NO.	FREQ. (MHz)	EMISSION LEVEL (dBuV/m)	LIMIT (dBuV/m)	MARGIN (dB)	ANTENNA HEIGHT (m)	TABLE ANGLE (Degree)	RAW VALUE (dBuV)	CORRECTION FACTOR (dB/m)
1	#5580.01	50.9 PK	68.2	-17.3	3.73 V	309	46.7	4.2
2	*5825.00	104.1 PK			3.73 V	309	99.7	4.4
3	*5825.00	92.6 AV			3.73 V	309	88.2	4.4
4	#5970.74	50.6 PK	68.2	-17.6	3.73 V	309	45.9	4.7
5	11650.00	46.1 PK	74.0	-27.9	1.47 V	218	32.4	13.7
6	11650.00	34.8 AV	54.0	-19.2	1.47 V	218	21.1	13.7
7	#17475.00	46.8 PK	74.0	-27.2	1.74 V	132	28.2	18.6
8	#17475.00	35.3 AV	54.0	-18.7	1.74 V	132	16.7	18.6

REMARKS:

1. Emission Level(dBuV/m) = Raw Value(dBuV) + Correction Factor(dB/m)
2. Correction Factor(dB/m) = Antenna Factor(dB/m) + Cable Factor(dB) – Pre-Amplifier Factor(dB)
3. The other emission levels were very low against the limit.
4. Margin value = Emission Level – Limit value
5. " * ": Fundamental frequency.
6. " # ": The radiated frequency is out of the restricted band.

802.11ac (VHT40)

CHANNEL	TX Channel 38	DETECTOR FUNCTION	Peak (PK)
FREQUENCY RANGE	1GHz ~ 40GHz		Average (AV)

ANTENNA POLARITY & TEST DISTANCE: HORIZONTAL AT 3 M

NO.	FREQ. (MHz)	EMISSION LEVEL (dBuV/m)	LIMIT (dBuV/m)	MARGIN (dB)	ANTENNA HEIGHT (m)	TABLE ANGLE (Degree)	RAW VALUE (dBuV)	CORRECTION FACTOR (dB/m)
1	5150.00	67.0 PK	74.0	-7.0	3.01 H	112	63.3	3.7
2	5150.00	53.7 AV	54.0	-0.3	3.01 H	112	50.0	3.7
3	*5190.00	104.4 PK			3.01 H	112	100.7	3.7
4	*5190.00	93.7 AV			3.01 H	112	90.0	3.7
5	5350.00	48.9 PK	74.0	-25.1	3.01 H	112	44.8	4.1
6	5350.00	37.6 AV	54.0	-16.4	3.01 H	112	33.5	4.1
7	#10380.00	45.3 PK	74.0	-28.7	1.68 H	202	32.2	13.1
8	#10380.00	34.3 AV	54.0	-19.7	1.68 H	202	21.2	13.1
9	15570.00	46.4 PK	74.0	-27.6	1.42 H	218	33.1	13.3
10	15570.00	34.4 AV	54.0	-19.6	1.42 H	218	21.1	13.3

ANTENNA POLARITY & TEST DISTANCE: VERTICAL AT 3 M

NO.	FREQ. (MHz)	EMISSION LEVEL (dBuV/m)	LIMIT (dBuV/m)	MARGIN (dB)	ANTENNA HEIGHT (m)	TABLE ANGLE (Degree)	RAW VALUE (dBuV)	CORRECTION FACTOR (dB/m)
1	5150.00	54.3 PK	74.0	-19.7	2.39 V	316	50.6	3.7
2	5150.00	46.6 AV	54.0	-7.4	2.39 V	316	42.9	3.7
3	*5190.00	93.6 PK			2.39 V	316	89.9	3.7
4	*5190.00	83.6 AV			2.39 V	316	79.9	3.7
5	5350.00	48.7 PK	74.0	-25.3	2.39 V	316	44.6	4.1
6	5350.00	36.9 AV	54.0	-17.1	2.39 V	316	32.8	4.1
7	#10380.00	45.2 PK	74.0	-28.8	1.49 V	211	32.1	13.1
8	#10380.00	34.1 AV	54.0	-19.9	1.49 V	211	21.0	13.1
9	15570.00	46.2 PK	74.0	-27.8	1.61 V	147	32.9	13.3
10	15570.00	34.3 AV	54.0	-19.7	1.61 V	147	21.0	13.3

REMARKS:

- Emission Level(dBuV/m) = Raw Value(dBuV) + Correction Factor(dB/m)
- Correction Factor(dB/m) = Antenna Factor(dB/m) + Cable Factor(dB) – Pre-Amplifier Factor(dB)
- The other emission levels were very low against the limit.
- Margin value = Emission Level – Limit value
- " * ": Fundamental frequency.
- " # ": The radiated frequency is out of the restricted band.

CHANNEL	TX Channel 46	DETECTOR FUNCTION	Peak (PK)
FREQUENCY RANGE	1GHz ~ 40GHz		Average (AV)

ANTENNA POLARITY & TEST DISTANCE: HORIZONTAL AT 3 M

NO.	FREQ. (MHz)	EMISSION LEVEL (dBuV/m)	LIMIT (dBuV/m)	MARGIN (dB)	ANTENNA HEIGHT (m)	TABLE ANGLE (Degree)	RAW VALUE (dBuV)	CORRECTION FACTOR (dB/m)
1	*5230.00	110.8 PK			3.00 H	114	107.0	3.8
2	*5230.00	99.6 AV			3.00 H	114	95.8	3.8
3	5350.00	52.4 PK	74.0	-21.6	3.00 H	114	48.3	4.1
4	5350.00	38.8 AV	54.0	-15.2	3.00 H	114	34.7	4.1
5	#10460.00	46.3 PK	74.0	-27.7	1.67 H	209	33.2	13.1
6	#10460.00	35.2 AV	54.0	-18.8	1.67 H	209	22.1	13.1
7	15690.00	47.3 PK	74.0	-26.7	1.44 H	221	33.5	13.8
8	15690.00	35.5 AV	54.0	-18.5	1.44 H	221	21.7	13.8

ANTENNA POLARITY & TEST DISTANCE: VERTICAL AT 3 M

NO.	FREQ. (MHz)	EMISSION LEVEL (dBuV/m)	LIMIT (dBuV/m)	MARGIN (dB)	ANTENNA HEIGHT (m)	TABLE ANGLE (Degree)	RAW VALUE (dBuV)	CORRECTION FACTOR (dB/m)
1	*5230.00	99.9 PK			2.43 V	303	96.1	3.8
2	*5230.00	89.7 AV			2.43 V	303	85.9	3.8
3	5350.00	51.7 PK	74.0	-22.3	2.43 V	303	47.6	4.1
4	5350.00	38.2 AV	54.0	-15.8	2.43 V	303	34.1	4.1
5	#10460.00	46.2 PK	74.0	-27.8	1.44 V	218	33.1	13.1
6	#10460.00	35.0 AV	54.0	-19.0	1.44 V	218	21.9	13.1
7	15690.00	47.1 PK	74.0	-26.9	1.67 V	162	33.3	13.8
8	15690.00	35.4 AV	54.0	-18.6	1.67 V	162	21.6	13.8

REMARKS:

1. Emission Level(dBuV/m) = Raw Value(dBuV) + Correction Factor(dB/m)
2. Correction Factor(dB/m) = Antenna Factor(dB/m) + Cable Factor(dB) – Pre-Amplifier Factor(dB)
3. The other emission levels were very low against the limit.
4. Margin value = Emission Level – Limit value
5. " * ": Fundamental frequency.
6. " # ": The radiated frequency is out of the restricted band.

CHANNEL	TX Channel 151	DETECTOR FUNCTION	Peak (PK)
FREQUENCY RANGE	1GHz ~ 40GHz		Average (AV)

ANTENNA POLARITY & TEST DISTANCE: HORIZONTAL AT 3 M

NO.	FREQ. (MHz)	EMISSION LEVEL (dBuV/m)	LIMIT (dBuV/m)	MARGIN (dB)	ANTENNA HEIGHT (m)	TABLE ANGLE (Degree)	RAW VALUE (dBuV)	CORRECTION FACTOR (dB/m)
1	#5649.98	58.2 PK	68.2	-10.0	2.60 H	96	53.8	4.4
2	*5755.00	114.6 PK			2.60 H	96	110.2	4.4
3	*5755.00	102.5 AV			2.60 H	96	98.1	4.4
4	#5937.97	54.9 PK	68.2	-13.3	2.60 H	96	50.2	4.7
5	11510.00	46.8 PK	74.0	-27.2	1.64 H	199	33.2	13.6
6	11510.00	35.9 AV	54.0	-18.1	1.64 H	199	22.3	13.6
7	#17265.00	47.8 PK	74.0	-26.2	1.48 H	221	30.2	17.6
8	#17265.00	36.2 AV	54.0	-17.8	1.48 H	221	18.6	17.6

ANTENNA POLARITY & TEST DISTANCE: VERTICAL AT 3 M

NO.	FREQ. (MHz)	EMISSION LEVEL (dBuV/m)	LIMIT (dBuV/m)	MARGIN (dB)	ANTENNA HEIGHT (m)	TABLE ANGLE (Degree)	RAW VALUE (dBuV)	CORRECTION FACTOR (dB/m)
1	#5565.86	51.0 PK	68.2	-17.2	2.41 V	311	46.8	4.2
2	*5755.00	100.4 PK			2.41 V	311	96.0	4.4
3	*5755.00	88.6 AV			2.41 V	311	84.2	4.4
4	#6019.31	49.9 PK	68.2	-18.3	2.41 V	311	45.1	4.8
5	11510.00	46.5 PK	74.0	-27.5	1.40 V	219	32.9	13.6
6	11510.00	35.6 AV	54.0	-18.4	1.40 V	219	22.0	13.6
7	#17265.00	47.4 PK	74.0	-26.6	1.69 V	161	29.8	17.6
8	#17265.00	35.9 AV	54.0	-18.1	1.69 V	161	18.3	17.6

REMARKS:

1. Emission Level(dBuV/m) = Raw Value(dBuV) + Correction Factor(dB/m)
2. Correction Factor(dB/m) = Antenna Factor(dB/m) + Cable Factor(dB) – Pre-Amplifier Factor(dB)
3. The other emission levels were very low against the limit.
4. Margin value = Emission Level – Limit value
5. " * ": Fundamental frequency.
6. " # ": The radiated frequency is out of the restricted band.

CHANNEL	TX Channel 159	DETECTOR FUNCTION	Peak (PK)
FREQUENCY RANGE	1GHz ~ 40GHz		Average (AV)

ANTENNA POLARITY & TEST DISTANCE: HORIZONTAL AT 3 M

NO.	FREQ. (MHz)	EMISSION LEVEL (dBuV/m)	LIMIT (dBuV/m)	MARGIN (dB)	ANTENNA HEIGHT (m)	TABLE ANGLE (Degree)	RAW VALUE (dBuV)	CORRECTION FACTOR (dB/m)
1	#5584.44	54.2 PK	68.2	-14.0	2.87 H	94	50.0	4.2
2	*5795.00	114.5 PK			2.87 H	94	110.1	4.4
3	*5795.00	102.3 AV			2.87 H	94	97.9	4.4
4	#5931.72	56.1 PK	68.2	-12.1	2.87 H	94	51.4	4.7
5	11590.00	46.9 PK	74.0	-27.1	1.61 H	186	33.4	13.5
6	11590.00	36.1 AV	54.0	-17.9	1.61 H	186	22.6	13.5
7	#17385.00	48.1 PK	74.0	-25.9	1.54 H	231	29.8	18.3
8	#17385.00	36.3 AV	54.0	-17.7	1.54 H	231	18.0	18.3

ANTENNA POLARITY & TEST DISTANCE: VERTICAL AT 3 M

NO.	FREQ. (MHz)	EMISSION LEVEL (dBuV/m)	LIMIT (dBuV/m)	MARGIN (dB)	ANTENNA HEIGHT (m)	TABLE ANGLE (Degree)	RAW VALUE (dBuV)	CORRECTION FACTOR (dB/m)
1	#5622.32	50.9 PK	68.2	-17.3	2.27 V	311	46.5	4.4
2	*5795.00	100.0 PK			2.27 V	311	95.6	4.4
3	*5795.00	88.4 AV			2.27 V	311	84.0	4.4
4	#5925.26	50.4 PK	68.2	-17.8	2.27 V	311	45.7	4.7
5	11590.00	46.7 PK	74.0	-27.3	1.37 V	211	33.2	13.5
6	11590.00	35.8 AV	54.0	-18.2	1.37 V	211	22.3	13.5
7	#17385.00	47.9 PK	74.0	-26.1	1.65 V	153	29.6	18.3
8	#17385.00	35.9 AV	54.0	-18.1	1.65 V	153	17.6	18.3

REMARKS:

1. Emission Level(dBuV/m) = Raw Value(dBuV) + Correction Factor(dB/m)
2. Correction Factor(dB/m) = Antenna Factor(dB/m) + Cable Factor(dB) – Pre-Amplifier Factor(dB)
3. The other emission levels were very low against the limit.
4. Margin value = Emission Level – Limit value
5. " * ": Fundamental frequency.
6. " # ": The radiated frequency is out of the restricted band.

802.11ac (VHT80)

CHANNEL	TX Channel 42	DETECTOR FUNCTION	Peak (PK)
FREQUENCY RANGE	1GHz ~ 40GHz		Average (AV)

ANTENNA POLARITY & TEST DISTANCE: HORIZONTAL AT 3 M

NO.	FREQ. (MHz)	EMISSION LEVEL (dBuV/m)	LIMIT (dBuV/m)	MARGIN (dB)	ANTENNA HEIGHT (m)	TABLE ANGLE (Degree)	RAW VALUE (dBuV)	CORRECTION FACTOR (dB/m)
1	5150.00	67.1 PK	74.0	-6.9	2.94 H	107	63.4	3.7
2	5150.00	53.8 AV	54.0	-0.2	2.94 H	107	50.1	3.7
3	*5210.00	98.2 PK			2.94 H	107	94.5	3.7
4	*5210.00	89.1 AV			2.94 H	107	85.4	3.7
5	5350.00	50.3 PK	74.0	-23.7	2.94 H	107	46.2	4.1
6	5350.00	39.4 AV	54.0	-14.6	2.94 H	107	35.3	4.1
7	#10420.00	45.3 PK	74.0	-28.7	1.70 H	198	32.2	13.1
8	#10420.00	34.4 AV	54.0	-19.6	1.70 H	198	21.3	13.1
9	15630.00	46.4 PK	74.0	-27.6	1.47 H	214	32.8	13.6
10	15630.00	34.7 AV	54.0	-19.3	1.47 H	214	21.1	13.6

ANTENNA POLARITY & TEST DISTANCE: VERTICAL AT 3 M

NO.	FREQ. (MHz)	EMISSION LEVEL (dBuV/m)	LIMIT (dBuV/m)	MARGIN (dB)	ANTENNA HEIGHT (m)	TABLE ANGLE (Degree)	RAW VALUE (dBuV)	CORRECTION FACTOR (dB/m)
1	5150.00	54.3 PK	74.0	-19.7	2.78 V	352	50.6	3.7
2	5150.00	46.7 AV	54.0	-7.3	2.78 V	352	43.0	3.7
3	*5210.00	89.2 PK			2.78 V	352	85.5	3.7
4	*5210.00	81.2 AV			2.78 V	352	77.5	3.7
5	5350.00	50.1 PK	74.0	-23.9	2.78 V	352	46.0	4.1
6	5350.00	39.2 AV	54.0	-14.8	2.78 V	352	35.1	4.1
7	#10420.00	45.2 PK	74.0	-28.8	1.48 V	209	32.1	13.1
8	#10420.00	33.9 AV	54.0	-20.1	1.48 V	209	20.8	13.1
9	15630.00	46.1 PK	74.0	-27.9	1.66 V	146	32.5	13.6
10	15630.00	34.0 AV	54.0	-20.0	1.66 V	146	20.4	13.6

REMARKS:

- Emission Level(dBuV/m) = Raw Value(dBuV) + Correction Factor(dB/m)
- Correction Factor(dB/m) = Antenna Factor(dB/m) + Cable Factor(dB) – Pre-Amplifier Factor(dB)
- The other emission levels were very low against the limit.
- Margin value = Emission Level – Limit value
- " * ": Fundamental frequency.
- " # ": The radiated frequency is out of the restricted band.

CHANNEL	TX Channel 155	DETECTOR FUNCTION	Peak (PK)
FREQUENCY RANGE	1GHz ~ 40GHz		Average (AV)

ANTENNA POLARITY & TEST DISTANCE: HORIZONTAL AT 3 M

NO.	FREQ. (MHz)	EMISSION LEVEL (dBuV/m)	LIMIT (dBuV/m)	MARGIN (dB)	ANTENNA HEIGHT (m)	TABLE ANGLE (Degree)	RAW VALUE (dBuV)	CORRECTION FACTOR (dB/m)
1	#5649.10	64.0 PK	68.2	-4.2	2.66 H	98	59.6	4.4
2	*5775.00	107.5 PK			2.66 H	98	103.1	4.4
3	*5775.00	97.6 AV			2.66 H	98	93.2	4.4
4	#5930.25	63.0 PK	68.2	-5.2	2.66 H	98	58.3	4.7
5	11550.00	46.1 PK	74.0	-27.9	1.68 H	211	32.6	13.5
6	11550.00	35.1 AV	54.0	-18.9	1.68 H	211	21.6	13.5
7	#17325.00	46.9 PK	74.0	-27.1	1.48 H	207	29.1	17.8
8	#17325.00	35.2 AV	54.0	-18.8	1.48 H	207	17.4	17.8

ANTENNA POLARITY & TEST DISTANCE: VERTICAL AT 3 M

NO.	FREQ. (MHz)	EMISSION LEVEL (dBuV/m)	LIMIT (dBuV/m)	MARGIN (dB)	ANTENNA HEIGHT (m)	TABLE ANGLE (Degree)	RAW VALUE (dBuV)	CORRECTION FACTOR (dB/m)
1	#5651.34	54.2 PK	69.2	-15.0	2.74 V	360	49.9	4.3
2	*5775.00	96.3 PK			2.74 V	360	91.9	4.4
3	*5775.00	89.4 AV			2.74 V	360	85.0	4.4
4	#5940.02	52.8 PK	68.2	-15.4	2.74 V	360	48.1	4.7
5	11550.00	45.7 PK	74.0	-28.3	1.46 V	231	32.2	13.5
6	11550.00	34.8 AV	54.0	-19.2	1.46 V	231	21.3	13.5
7	#17325.00	46.8 PK	74.0	-27.2	1.68 V	152	29.0	17.8
8	#17325.00	35.1 AV	54.0	-18.9	1.68 V	152	17.3	17.8

REMARKS:

1. Emission Level(dBuV/m) = Raw Value(dBuV) + Correction Factor(dB/m)
2. Correction Factor(dB/m) = Antenna Factor(dB/m) + Cable Factor(dB) – Pre-Amplifier Factor(dB)
3. The other emission levels were very low against the limit.
4. Margin value = Emission Level – Limit value
5. " * ": Fundamental frequency.
6. " # ": The radiated frequency is out of the restricted band.

4.2 Conducted Emission Measurement

4.2.1 Limits of Conducted Emission Measurement

Frequency (MHz)	Conducted Limit (dBuV)	
	Quasi-peak	Average
0.15 - 0.5	66 - 56	56 - 46
0.50 - 5.0	56	46
5.0 - 30.0	60	50

Note: 1. The lower limit shall apply at the transition frequencies.

2. The limit decreases in line with the logarithm of the frequency in the range of 0.15 to 0.50MHz.

4.2.2 Test Instruments

DESCRIPTION & MANUFACTURER	MODEL NO.	SERIAL NO.	CALIBRATED DATE	CALIBRATED UNTIL
Test Receiver R&S	ESCS 30	847124/029	Oct. 24, 2016	Oct. 23, 2017
Line-Impedance Stabilization Network (for EUT) R&S	ESH3-Z5	848773/004	Oct. 26, 2016	Oct. 25, 2017
Line-Impedance Stabilization Network (for Peripheral) R&S	ENV216	100072	June 13, 2016	June 12, 2017
50 ohms Terminator	N/A	EMC-02	Sep. 29, 2016	Sep. 28, 2017
RF Cable	5D-FB	COCCAB-001	Sep. 30, 2016	Sep. 29, 2017
10 dB PAD Mini-Circuits	HAT-10+	CONATT-004	June 20, 2016	June 19, 2017
Software BVADT	BVADT_Cond_ V7.3.7.4	NA	NA	NA

Note:

1. The calibration interval of the above test instruments are 12 months and the calibrations are traceable to NML/ROC and NIST/USA.
2. The test was performed in Shielded Room No. 1.
3. Tested Date: May 17, 2017

4.2.3 Test Procedure

- The EUT was placed 0.4 meters from the conducting wall of the shielded room with EUT being connected to the power mains through a line impedance stabilization network (LISN). Other support units were connected to the power mains through another LISN. The two LISNs provide 50 ohm/ 50uH of coupling impedance for the measuring instrument.
- Both lines of the power mains connected to the EUT were checked for maximum conducted interference.
- The frequency range from 150kHz to 30MHz was searched. Emission levels under (Limit - 20dB) was not recorded.

NOTE: All modes of operation were investigated and the worst-case emissions are reported.

4.2.4 Deviation from Test Standard

No deviation.

4.2.5 Test Setup

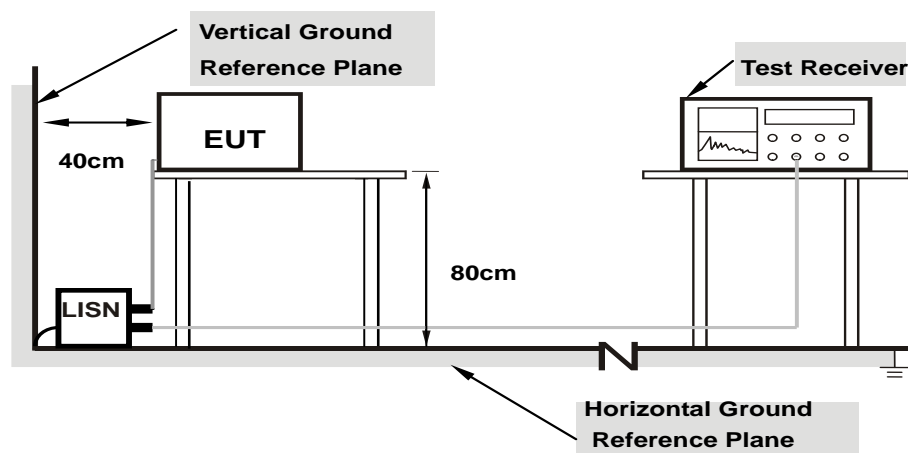

Note: 1.Support units were connected to second LISN.

For the actual test configuration, please refer to the attached file (Test Setup Photo).

4.2.6 EUT Operating Condition

Same as 4.1.6.

4.2.7 Test Results (Mode 1)

Phase	Line (L)	Detector Function	Quasi-Peak (QP) / Average (AV)
-------	----------	-------------------	--------------------------------

No	Freq. [MHz]	Corr.	Reading Value		Emission Level		Limit		Margin	
		Factor (dB)	[dB (uV)]		[dB (uV)]		[dB (uV)]		(dB)	
		Q.P.	AV.	Q.P.	AV.	Q.P.	AV.	Q.P.	AV.	
1	0.15000	10.19	35.92	15.24	46.11	25.43	66.00	56.00	-19.89	-30.57
2	0.16953	10.19	35.57	23.19	45.76	33.38	64.98	54.98	-19.22	-21.60
3	0.41953	10.22	35.52	0.30	45.74	10.52	57.46	47.46	-11.72	-36.94
4	0.48203	10.23	22.28	6.04	32.51	16.27	56.30	46.30	-23.79	-30.03
5	17.64453	11.22	13.72	7.72	24.94	18.94	60.00	50.00	-35.06	-31.06
6	22.03125	11.40	19.89	13.96	31.29	25.36	60.00	50.00	-28.71	-24.64

REMARKS:

1. Q.P. and AV. are abbreviations of quasi-peak and average individually.
2. The emission levels of other frequencies were very low against the limit.
3. Margin value = Emission level - Limit value
4. Correction factor = Insertion loss + Cable loss
5. Emission Level = Correction Factor + Reading Value.

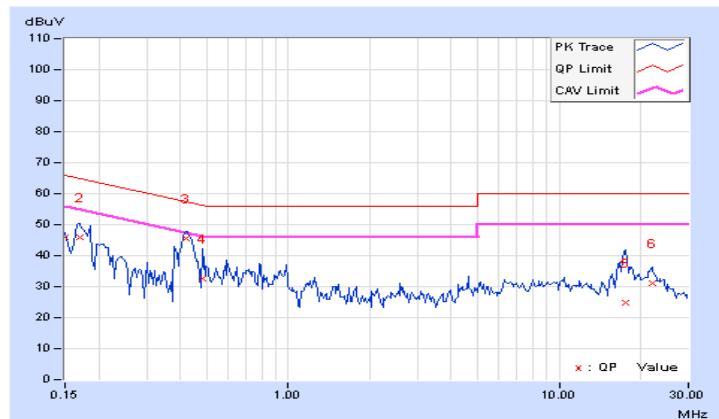

Phase	Neutral (N)	Detector Function	Quasi-Peak (QP) / Average (AV)
-------	-------------	-------------------	--------------------------------

No	Freq.	Corr.	Reading Value		Emission Level		Limit		Margin	
	[MHz]	Factor	[dB (uV)]		[dB (uV)]		[dB (uV)]		(dB)	
		(dB)	Q.P.	AV.	Q.P.	AV.	Q.P.	AV.	Q.P.	AV.
1	0.15391	10.18	32.21	9.88	42.39	20.06	65.79	55.79	-23.40	-35.73
2	0.20078	10.16	32.42	18.34	42.58	28.50	63.58	53.58	-21.00	-25.08
3	0.42331	10.21	36.82	29.20	47.03	39.41	57.38	47.38	-10.35	-7.97
4	0.79453	10.22	19.29	7.53	29.51	17.75	56.00	46.00	-26.49	-28.25
5	7.65625	10.36	16.93	10.11	27.29	20.47	60.00	50.00	-32.71	-29.53
6	17.64147	11.00	30.24	28.21	41.24	39.21	60.00	50.00	-18.76	-10.79

REMARKS:

1. Q.P. and AV. are abbreviations of quasi-peak and average individually.
2. The emission levels of other frequencies were very low against the limit.
3. Margin value = Emission level - Limit value
4. Correction factor = Insertion loss + Cable loss
5. Emission Level = Correction Factor + Reading Value.

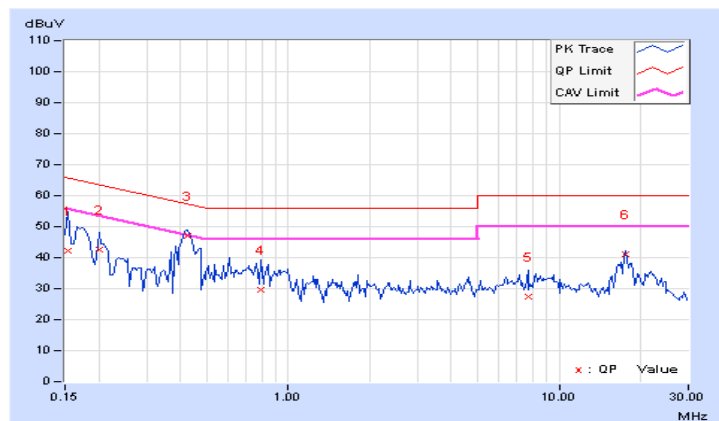

4.3 Transmit Power Measurement

4.3.1 Limits of Transmit Power Measurement

Operation Band	EUT Category		Limit
U-NII-1		Outdoor Access Point	1 Watt (30 dBm) (Max. e.i.r.p \leq 125mW(21 dBm) at any elevation angle above 30 degrees as measured from the horizon)
		Fixed point-to-point Access Point	1 Watt (30 dBm)
	√	Indoor Access Point	1 Watt (30 dBm)
		Mobile and Portable client device	250mW (24 dBm)
U-NII-2A			250mW (24 dBm) or 11 dBm+10 log B*
U-NII-2C			250mW (24 dBm) or 11 dBm+10 log B*
U-NII-3	√		1 Watt (30 dBm)

*B is the 26 dB emission bandwidth in megahertz

Per KDB 662911 Method of conducted output power measurement on IEEE 802.11 devices,

Array Gain = 0 dB (i.e., no array gain) for $N_{ANT} \leq 4$;

Array Gain = 0 dB (i.e., no array gain) for channel widths ≥ 40 MHz for any N_{ANT} ;

Array Gain = $5 \log(N_{ANT}/N_{SS})$ dB or 3 dB, whichever is less for 20-MHz channel widths with $N_{ANT} \geq 5$.

For power measurements on all other devices: Array Gain = $10 \log(N_{ANT}/N_{SS})$ dB.

4.3.2 Test Setup

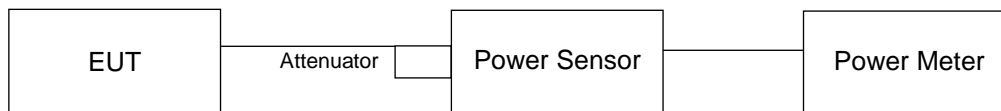

4.3.3 Test Instruments

Refer to section 4.1.2 to get information of above instrument.

4.3.4 Test Procedure

Method PM is used to perform output power measurement, trigger and gating function of wide band power meter is enabled to measure max output power of TX on burst. Duty factor is not added to measured value.

4.3.5 Deviation from Test Standard

No deviation.

4.3.6 EUT Operating Condition

The software provided by client to enable the EUT under transmission condition continuously at lowest, middle and highest channel frequencies individually.

4.3.7 Test Result (Mode 1)

CDD Mode
802.11a

Chan.	Chan. Freq. (MHz)	Maximum Conducted Power (dBm)				Total Power (mW)	Total Power (dBm)	Limit (dBm)	Pass / Fail
		Chain 0	Chain 1	Chain 2	Chain 3				
36	5180	18.13	18.32	18.22	18.36	267.856	24.28	30.00	Pass
40	5200	18.23	18.30	18.09	18.10	263.117	24.20	30.00	Pass
48	5240	18.10	17.93	18.08	18.33	258.998	24.13	30.00	Pass
149	5745	22.25	22.66	22.77	22.18	706.812	28.49	30.00	Pass
157	5785	22.26	22.63	22.90	22.29	715.916	28.55	30.00	Pass
165	5825	22.18	22.69	23.30	22.90	759.756	28.81	30.00	Pass

802.11ac (VHT20)

Chan.	Chan. Freq. (MHz)	Maximum Conducted Power (dBm)				Total Power (mW)	Total Power (dBm)	Limit (dBm)	Pass / Fail
		Chain 0	Chain 1	Chain 2	Chain 3				
36	5180	18.15	18.45	18.16	18.32	268.681	24.29	30.00	Pass
40	5200	18.16	18.10	17.93	18.22	258.49	24.12	30.00	Pass
48	5240	18.27	18.02	18.23	18.38	265.922	24.25	30.00	Pass
149	5745	22.29	22.66	22.83	22.16	710.24	28.51	30.00	Pass
157	5785	22.22	22.61	22.80	22.22	706.386	28.49	30.00	Pass
165	5825	22.17	22.67	23.08	22.81	743.964	28.72	30.00	Pass

802.11ac (VHT40)

Chan.	Chan. Freq. (MHz)	Maximum Conducted Power (dBm)				Total Power (mW)	Total Power (dBm)	Limit (dBm)	Pass / Fail
		Chain 0	Chain 1	Chain 2	Chain 3				
38	5190	12.10	12.66	12.35	12.39	69.185	18.40	30.00	Pass
46	5230	20.04	20.07	20.08	20.24	410.091	26.13	30.00	Pass
151	5755	21.98	22.30	22.34	21.95	655.656	28.17	30.00	Pass
159	5795	22.06	22.54	23.01	22.78	729.824	28.63	30.00	Pass

802.11ac (VHT80)

Chan.	Chan. Freq. (MHz)	Maximum Conducted Power (dBm)				Total Power (mW)	Total Power (dBm)	Limit (dBm)	Pass / Fail
		Chain 0	Chain 1	Chain 2	Chain 3				
42	5210	9.19	9.33	9.29	9.40	34.071	15.32	30.00	Pass
155	5775	17.80	16.79	17.02	17.83	219.033	23.41	30.00	Pass

802.11ac (VHT80+80)

Chan.	Chan. Freq. (MHz)	Maximum Conducted Power (dBm)				Total Power (mW)	Total Power (dBm)	Limit (dBm)	Pass / Fail
		Chain 0	Chain 1	Chain 2	Chain 3				
42 +155	5210	11.93	12.31	-	-	32.618	15.13	30.00	Pass
	5775	-	-	12.50	13.46	39.965	16.02	30.00	Pass

Beamforming Mode

802.11ac (VHT20)

Chan.	Chan. Freq. (MHz)	Maximum Conducted Power (dBm)				Total Power (mW)	Total Power (dBm)	Limit (dBm)	Pass / Fail
		Chain 0	Chain 1	Chain 2	Chain 3				
36	5180	18.15	18.45	18.16	18.32	268.681	24.29	24.33	Pass
40	5200	18.16	18.10	17.93	18.22	258.49	24.12	24.33	Pass
48	5240	18.27	18.02	18.23	18.38	265.922	24.25	24.33	Pass
149	5745	17.74	18.17	18.21	17.57	248.414	23.95	24.33	Pass
157	5785	17.73	18.03	18.43	17.86	253.583	24.04	24.33	Pass
165	5825	17.64	18.07	18.70	18.29	263.781	24.21	24.33	Pass

Note: 1. Directional gain = $10 \log[(10^{G1/20} + 10^{G2/20} + 10^{G2/20} + 10^{G2/20})^2 / 4]$ = 11.67dBi > 6dBi , so the power limit shall be reduced to $30-(11.67-6) = 24.33$ dBm.

802.11ac (VHT40)

Chan.	Chan. Freq. (MHz)	Maximum Conducted Power (dBm)				Total Power (mW)	Total Power (dBm)	Limit (dBm)	Pass / Fail
		Chain 0	Chain 1	Chain 2	Chain 3				
38	5190	12.10	12.66	12.35	12.39	69.185	18.40	24.33	Pass
46	5230	18.02	18.06	18.10	18.19	257.842	24.11	24.33	Pass
151	5755	17.97	18.19	18.33	17.83	257.329	24.10	24.33	Pass
159	5795	17.55	18.10	18.39	18.30	258.082	24.12	24.33	Pass

Note: 1. Directional gain = $10 \log[(10^{G1/20} + 10^{G2/20} + 10^{G2/20} + 10^{G2/20})^2 / 4]$ = 11.67dBi > 6dBi , so the power limit shall be reduced to $30-(11.67-6) = 24.33$ dBm.

802.11ac (VHT80)

Chan.	Chan. Freq. (MHz)	Maximum Conducted Power (dBm)				Total Power (mW)	Total Power (dBm)	Limit (dBm)	Pass / Fail
		Chain 0	Chain 1	Chain 2	Chain 3				
42	5210	9.19	9.33	9.29	9.40	34.071	15.32	24.33	Pass
155	5775	17.80	16.79	17.02	17.83	219.033	23.41	24.33	Pass

Note: 1. Directional gain = $10 \log[(10^{G1/20} + 10^{G2/20} + 10^{G2/20} + 10^{G2/20})^2 / 4]$ = 11.67dBi > 6dBi , so the power limit shall be reduced to $30-(11.67-6) = 24.33$ dBm.

802.11ac (VHT80+80)

Chan.	Chan. Freq. (MHz)	Maximum Conducted Power (dBm)				Total Power (mW)	Total Power (dBm)	Limit (dBm)	Pass / Fail
		Chain 0	Chain 1	Chain 2	Chain 3				
42+155	5210	11.93	12.31	-	-	32.618	15.13	27.16	Pass
	5775	-	-	12.50	13.46	39.965	16.02	27.52	Pass

- Note:** 1. For UNII-1: Directional gain = $10 \log[(10^{G1/20} + 10^{G2/20})^2 / 2] = 8.84\text{dBi} > 6\text{dBi}$, so the power limit shall be reduced to $30 - (8.84 - 6) = 27.16\text{dBm}$.
2. For UNII-3: Directional gain = $10 \log[(10^{G3/20} + 10^{G4/20})^2 / 2] = 8.48\text{dBi} > 6\text{dBi}$, so the power limit shall be reduced to $30 - (8.48 - 6) = 27.52\text{dBm}$.

4.3.8 Test Result (Mode 2)

CDD Mode
802.11a

Chan.	Chan. Freq. (MHz)	Maximum Conducted Power (dBm)			Total Power (mW)	Total Power (dBm)	Limit (dBm)	Pass / Fail
		Chain 0	Chain 1	Chain 2				
36	5180	19.13	19.32	19.22	250.913	24.00	30.00	Pass
40	5200	20.35	20.42	20.16	322.3	25.08	30.00	Pass
48	5240	20.77	20.33	20.70	344.784	25.38	30.00	Pass
149	5745	22.25	22.66	22.77	541.616	27.34	30.00	Pass
157	5785	22.26	22.63	22.90	546.482	27.38	30.00	Pass
165	5825	22.18	22.69	23.30	564.772	27.52	30.00	Pass

802.11ac (VHT20)

Chan.	Chan. Freq. (MHz)	Maximum Conducted Power (dBm)			Total Power (mW)	Total Power (dBm)	Limit (dBm)	Pass / Fail
		Chain 0	Chain 1	Chain 2				
36	5180	19.81	20.09	19.82	293.753	24.68	30.00	Pass
40	5200	20.66	20.69	20.42	343.787	25.36	30.00	Pass
48	5240	20.60	20.16	20.59	333.119	25.23	30.00	Pass
149	5745	22.29	22.66	22.83	545.803	27.37	30.00	Pass
157	5785	22.22	22.61	22.80	539.661	27.32	30.00	Pass
165	5825	22.17	22.67	23.08	552.979	27.43	30.00	Pass

802.11ac (VHT40)

Chan.	Chan. Freq. (MHz)	Maximum Conducted Power (dBm)			Total Power (mW)	Total Power (dBm)	Limit (dBm)	Pass / Fail
		Chain 0	Chain 1	Chain 2				
38	5190	13.99	14.17	14.02	76.418	18.83	30.00	Pass
46	5230	20.69	20.43	20.45	338.545	25.30	30.00	Pass
151	5755	21.98	22.30	22.34	498.981	26.98	30.00	Pass
159	5795	22.06	22.54	23.01	540.153	27.33	30.00	Pass

802.11ac (VHT80)

Chan.	Chan. Freq. (MHz)	Maximum Conducted Power (dBm)			Total Power (mW)	Total Power (dBm)	Limit (dBm)	Pass / Fail
		Chain 0	Chain 1	Chain 2				
42	5210	10.54	10.47	10.32	33.232	15.22	30.00	Pass
155	5775	18.36	17.21	17.49	177.256	22.49	30.00	Pass

Beamforming Mode

802.11ac (VHT20)

Chan.	Chan. Freq. (MHz)	Maximum Conducted Power (dBm)			Total Power (mW)	Total Power (dBm)	Limit (dBm)	Pass / Fail
		Chain 0	Chain 1	Chain 2				
36	5180	19.81	20.09	19.82	293.753	24.68	25.47	Pass
40	5200	20.66	20.69	20.42	343.787	25.36	25.47	Pass
48	5240	20.60	20.16	20.59	333.119	25.23	25.47	Pass
149	5745	19.84	20.38	20.34	313.67	24.96	25.47	Pass
157	5785	19.93	20.26	20.55	318.072	25.03	25.47	Pass
165	5825	19.84	20.20	20.91	324.406	25.11	25.47	Pass

Note: 1. Directional gain = $10 \log[(10^{G1/20} + 10^{G2/20} + 10^{G2/20})^2 / 3] = 10.53\text{dBi} > 6\text{dBi}$, so the power limit shall be reduced to $30 - (10.53 - 6) = 25.47\text{dBm}$.

802.11ac (VHT40)

Chan.	Chan. Freq. (MHz)	Maximum Conducted Power (dBm)			Total Power (mW)	Total Power (dBm)	Limit (dBm)	Pass / Fail
		Chain 0	Chain 1	Chain 2				
38	5190	13.99	14.17	14.02	76.418	18.83	25.47	Pass
46	5230	20.69	20.43	20.45	338.545	25.30	25.47	Pass
151	5755	19.96	20.27	20.30	312.649	24.95	25.47	Pass
159	5795	20.06	20.54	21.01	340.814	25.33	25.47	Pass

Note: 1. Directional gain = $10 \log[(10^{G1/20} + 10^{G2/20} + 10^{G2/20})^2 / 3] = 10.53\text{dBi} > 6\text{dBi}$, so the power limit shall be reduced to $30 - (10.53 - 6) = 25.47\text{dBm}$.

802.11ac (VHT80)

Chan.	Chan. Freq. (MHz)	Maximum Conducted Power (dBm)			Total Power (mW)	Total Power (dBm)	Limit (dBm)	Pass / Fail
		Chain 0	Chain 1	Chain 2				
42	5210	10.54	10.47	10.32	33.232	15.22	25.47	Pass
155	5775	18.36	17.21	17.49	177.256	22.49	25.47	Pass

Note: 1. Directional gain = $10 \log[(10^{G1/20} + 10^{G2/20} + 10^{G2/20})^2 / 3] = 10.53\text{dBi} > 6\text{dBi}$, so the power limit shall be reduced to $30 - (10.53 - 6) = 25.47\text{dBm}$.

4.3.9 Test Result (Mode 3)

CDD Mode
802.11a

Chan.	Chan. Freq. (MHz)	Maximum Conducted Power (dBm)		Total Power (mW)	Total Power (dBm)	Limit (dBm)	Pass / Fail
		Chain 0	Chain 1				
36	5180	19.85	19.91	194.554	22.89	30.00	Pass
40	5200	22.83	22.91	387.301	25.88	30.00	Pass
48	5240	22.58	22.34	352.53	25.47	30.00	Pass
149	5745	22.25	22.66	352.382	25.47	30.00	Pass
157	5785	22.26	22.63	351.498	25.46	30.00	Pass
165	5825	22.18	22.69	350.976	25.45	30.00	Pass

802.11ac (VHT20)

Chan.	Chan. Freq. (MHz)	Maximum Conducted Power (dBm)		Total Power (mW)	Total Power (dBm)	Limit (dBm)	Pass / Fail
		Chain 0	Chain 1				
36	5180	20.67	20.75	235.531	23.72	30.00	Pass
40	5200	22.66	22.69	370.282	25.69	30.00	Pass
48	5240	22.18	21.61	310.073	24.91	30.00	Pass
149	5745	22.29	22.66	353.936	25.49	30.00	Pass
157	5785	22.22	22.61	349.115	25.43	30.00	Pass
165	5825	22.17	22.67	349.743	25.44	30.00	Pass

802.11ac (VHT40)

Chan.	Chan. Freq. (MHz)	Maximum Conducted Power (dBm)		Total Power (mW)	Total Power (dBm)	Limit (dBm)	Pass / Fail
		Chain 0	Chain 1				
38	5190	15.23	15.36	67.699	18.31	30.00	Pass
46	5230	21.69	21.47	287.852	24.59	30.00	Pass
151	5755	21.98	22.30	327.585	25.15	30.00	Pass
159	5795	22.06	22.54	340.167	25.32	30.00	Pass

802.11ac (VHT80)

Chan.	Chan. Freq. (MHz)	Maximum Conducted Power (dBm)		Total Power (mW)	Total Power (dBm)	Limit (dBm)	Pass / Fail
		Chain 0	Chain 1				
42	5210	13.46	13.37	43.909	16.43	30.00	Pass
155	5775	18.36	17.21	121.151	20.83	30.00	Pass

802.11ac (VHT80+80)

Chan.	Chan. Freq. (MHz)	Maximum Conducted Power (dBm)		Total Power (mW)	Total Power (dBm)	Limit (dBm)	Pass / Fail
		Chain 0	Chain 2				
42+155	5210	13.75	-	23.714	13.75	30.00	Pass
	5775	-	13.30	21.38	13.30	30.00	Pass

Beamforming Mode

802.11ac (VHT20)

Chan.	Chan. Freq. (MHz)	Maximum Conducted Power (dBm)		Total Power (mW)	Total Power (dBm)	Limit (dBm)	Pass / Fail
		Chain 0	Chain 1				
36	5180	20.67	20.75	235.531	23.72	27.16	Pass
40	5200	22.66	22.69	370.282	25.69	27.16	Pass
48	5240	22.18	21.61	310.073	24.91	27.16	Pass
149	5745	22.29	22.66	353.936	25.49	27.16	Pass
157	5785	22.22	22.61	349.115	25.43	27.16	Pass
165	5825	22.17	22.67	349.743	25.44	27.16	Pass

Note: 1. Directional gain = $10 \log[(10^{G1/20} + 10^{G2/20})^2 / 2] = 8.84\text{dBi} > 6\text{dBi}$, so the power limit shall be reduced to $30 - (8.84 - 6) = 27.16\text{dBm}$.

802.11ac (VHT40)

Chan.	Chan. Freq. (MHz)	Maximum Conducted Power (dBm)		Total Power (mW)	Total Power (dBm)	Limit (dBm)	Pass / Fail
		Chain 0	Chain 1				
38	5190	15.23	15.36	67.699	18.31	27.16	Pass
46	5230	21.69	21.47	287.852	24.59	27.16	Pass
151	5755	21.98	22.30	327.585	25.15	27.16	Pass
159	5795	22.06	22.54	340.167	25.32	27.16	Pass

Note: 1. Directional gain = $10 \log[(10^{G1/20} + 10^{G2/20})^2 / 2] = 8.84\text{dBi} > 6\text{dBi}$, so the power limit shall be reduced to $30 - (8.84 - 6) = 27.16\text{dBm}$.

802.11ac (VHT80)

Chan.	Chan. Freq. (MHz)	Maximum Conducted Power (dBm)		Total Power (mW)	Total Power (dBm)	Limit (dBm)	Pass / Fail
		Chain 0	Chain 1				
42	5210	13.46	13.37	43.909	16.43	27.16	Pass
155	5775	18.36	17.21	121.151	20.83	27.16	Pass

Note: 1. Directional gain = $10 \log[(10^{G1/20} + 10^{G2/20})^2 / 2] = 8.84\text{dBi} > 6\text{dBi}$, so the power limit shall be reduced to $30 - (8.84 - 6) = 27.16\text{dBm}$.

4.3.10 Test Result (Mode 4)

CDD Mode

802.11a

Channel	Channel Frequency (MHz)	Maximum Conducted Power (mW)	Maximum Conducted Power (dBm)	Power Limit (dBm)	Pass/Fail
36	5180	138.995	21.43	30.00	Pass
40	5200	191.867	22.83	30.00	Pass
48	5240	181.134	22.58	30.00	Pass
149	5745	167.88	22.25	30.00	Pass
157	5785	168.267	22.26	30.00	Pass
165	5825	165.196	22.18	30.00	Pass

802.11ac (VHT20)

Channel	Channel Frequency (MHz)	Maximum Conducted Power (mW)	Maximum Conducted Power (dBm)	Power Limit (dBm)	Pass/Fail
36	5180	131.522	21.19	30.00	Pass
40	5200	184.502	22.66	30.00	Pass
48	5240	165.196	22.18	30.00	Pass
149	5745	169.434	22.29	30.00	Pass
157	5785	166.725	22.22	30.00	Pass
165	5825	164.816	22.17	30.00	Pass

802.11ac (VHT40)

Channel	Channel Frequency (MHz)	Maximum Conducted Power (mW)	Maximum Conducted Power (dBm)	Power Limit (dBm)	Pass/Fail
38	5190	39.084	15.92	30.00	Pass
46	5230	147.231	21.68	30.00	Pass
151	5755	157.761	21.98	30.00	Pass
159	5795	160.694	22.06	30.00	Pass

802.11ac (VHT80)

Channel	Channel Frequency (MHz)	Maximum Conducted Power (mW)	Maximum Conducted Power (dBm)	Power Limit (dBm)	Pass/Fail
42	5210	25.061	13.99	30.00	Pass
155	5775	88.512	19.47	30.00	Pass

4.4 Occupied Bandwidth Measurement

4.4.1 Test Setup

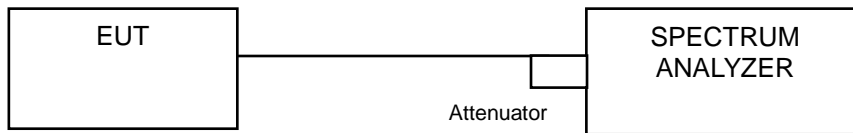

4.4.2 Test Instruments

Refer to section 4.1.2 to get information of above instrument.

4.4.3 Test Procedure

The transmitter output was connected to the spectrum analyzer through an attenuator. The bandwidth of the fundamental frequency was measured by spectrum analyzer with resolution bandwidth in the range of 1% to 5% of the anticipated emission bandwidth, and a video bandwidth at least 3x the resolution bandwidth and set the detector to SAMPLE. The width of a frequency band such that, below the lower and above the upper frequency limits, the mean powers emitted are each equal to a specified percentage 0.5 %of the total mean power of a given emission.

4.4.4 Test Results (Mode 1)

802.11a

Channel	Channel Frequency (MHz)	Occupied Bandwidth (MHz)			
		Chain 0	Chain 1	Chain 2	Chain 3
36	5180	16.68	16.68	17.16	16.56
40	5200	16.68	16.68	17.28	16.56
48	5240	16.68	16.68	16.56	16.56
149	5745	29.52	29.16	28.56	29.04
157	5785	30.00	29.76	28.69	28.32
165	5825	29.40	29.40	27.12	29.52

802.11ac (VHT20)

Channel	Channel Frequency (MHz)	Occupied Bandwidth (MHz)			
		Chain 0	Chain 1	Chain 2	Chain 3
36	5180	16.68	16.68	17.16	16.56
40	5200	16.68	16.68	17.28	16.56
48	5240	16.68	16.68	16.56	16.56
149	5745	29.52	29.16	28.56	29.04
157	5785	30.00	29.76	28.69	28.32
165	5825	29.40	29.40	27.12	29.52

802.11ac (VHT40)

Channel	Channel Frequency (MHz)	Occupied Bandwidth (MHz)			
		Chain 0	Chain 1	Chain 2	Chain 3
38	5190	36.24	36.24	36.24	36.00
46	5230	36.48	36.48	36.48	36.96
151	5755	50.88	49.92	47.76	52.56
159	5795	51.36	52.08	50.64	57.36

802.11ac (VHT80)

Channel	Channel Frequency (MHz)	Occupied Bandwidth (MHz)			
		Chain 0	Chain 1	Chain 2	Chain 3
42	5210	76.32	75.84	75.84	75.84
155	5775	79.68	76.32	76.32	77.28

802.11ac (VHT80+80)

Channel	Channel Frequency (MHz)	Occupied Bandwidth (MHz)			
		Chain 0	Chain 1	Chain 2	Chain 3
42+155	5210	76.32	75.84	-	-
	5775	-	-	75.84	75.84

Spectrum Plot of Worst Value

802.11a / Chain 0 : CH157

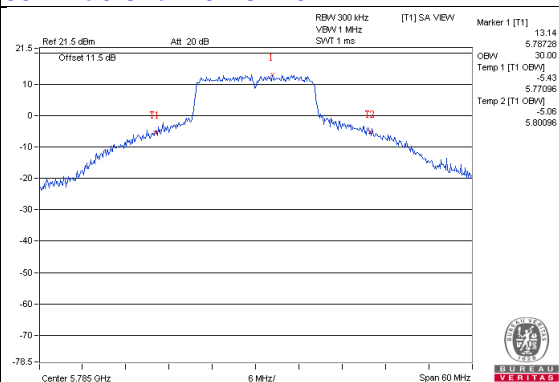

802.11ac (VHT20) / Chain 0 : CH157

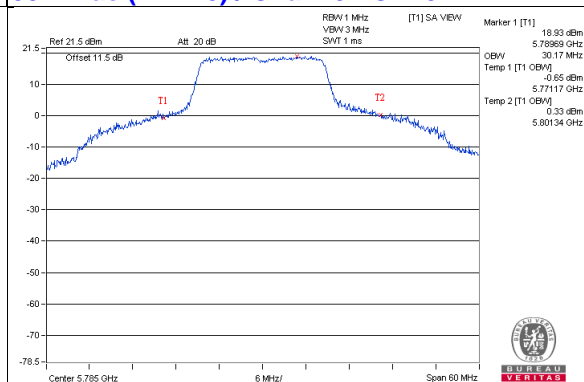

802.11ac (VHT40) / Chain 3: CH159

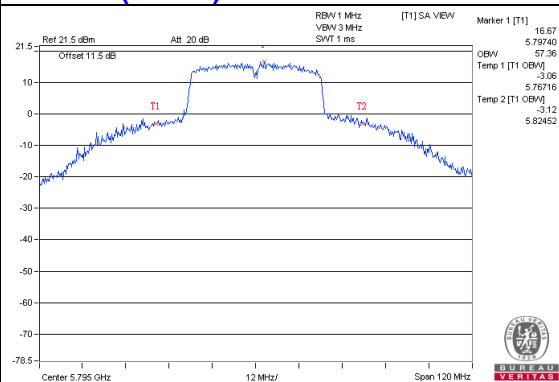

802.11ac (VHT80) / Chain 0 : CH155

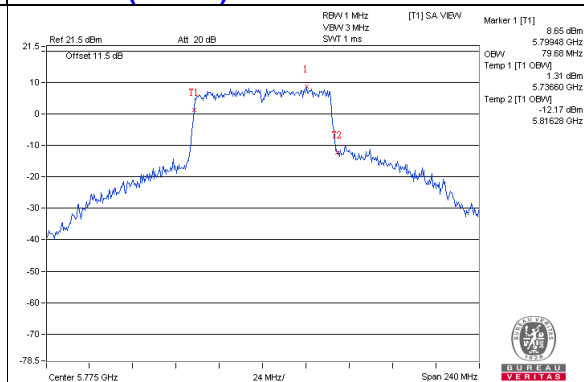

802.11ac (VHT80+80) / Chain 0: CH42

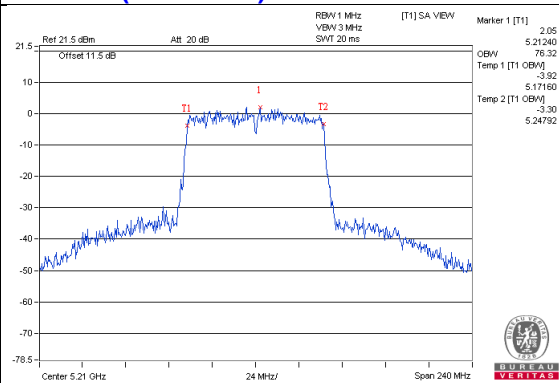

Spectrum Plot for near by DFS band (DFS is required, if 99% OCP straddle into U-NII-2A band)

802.11a / Chain 0 : CH48

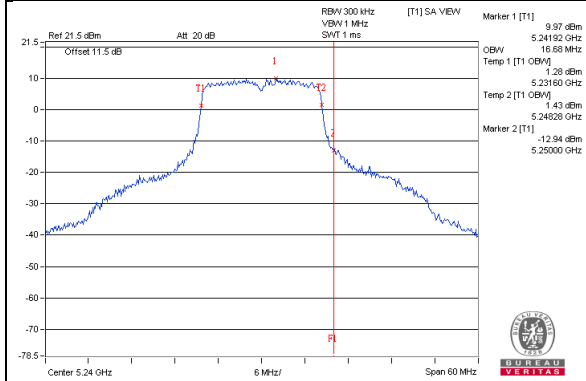

802.11a / Chain 1 : CH48

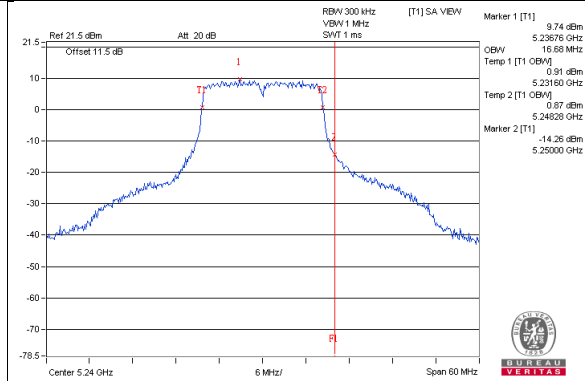

802.11a / Chain 2 : CH48

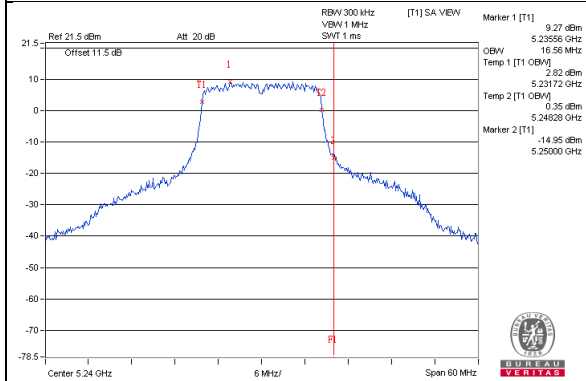

802.11a / Chain 3 : CH48

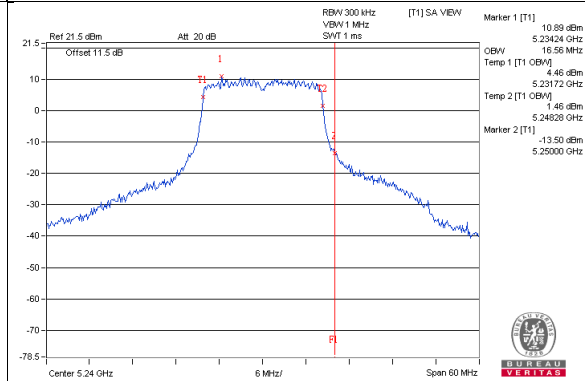

802.11ac (VHT20) / Chain 0 : CH48

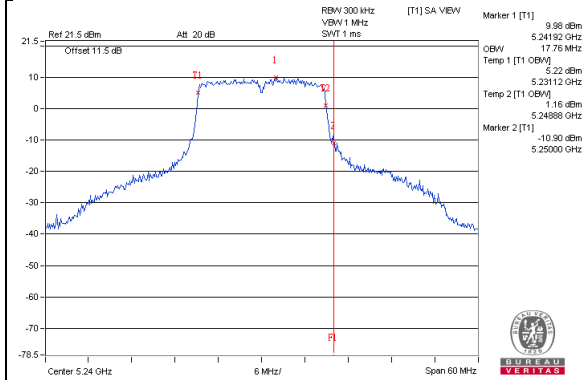

802.11ac (VHT20) / Chain 1 : CH48

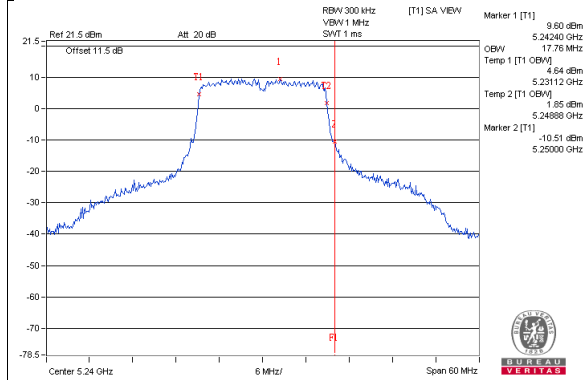

802.11ac (VHT20) / Chain 2 : CH48

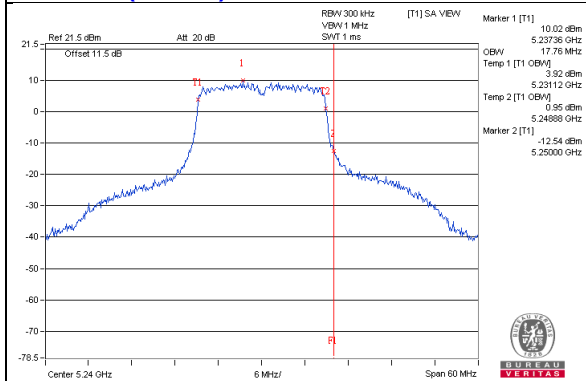

802.11ac (VHT20) / Chain 3 : CH48

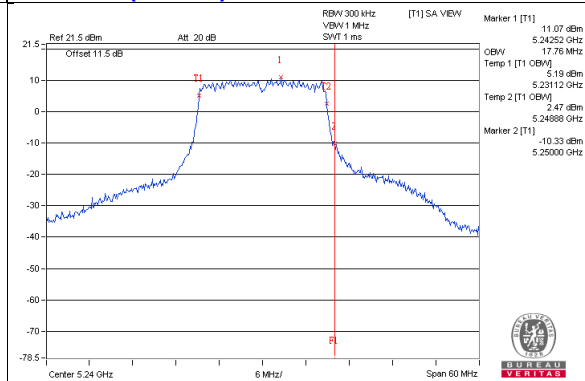

Spectrum Plot for near by DFS band (DFS is required, if 99% OCP straddle into U-NII-2A band)

802.11ac (VHT40) / Chain 0 : CH46

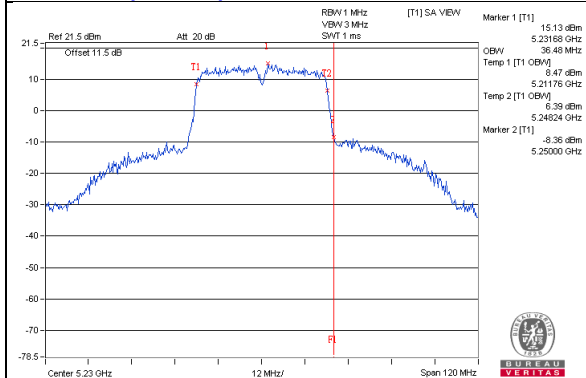

802.11ac (VHT40) / Chain 1 : CH46

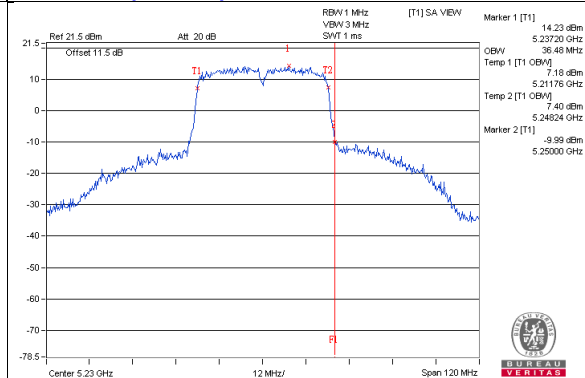

802.11ac (VHT40) / Chain 2 : CH46

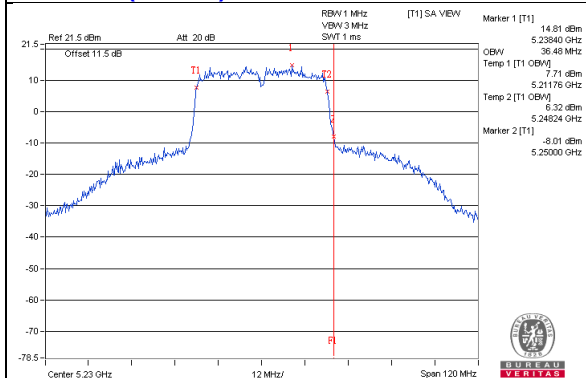

802.11ac (VHT40) / Chain 3 : CH46

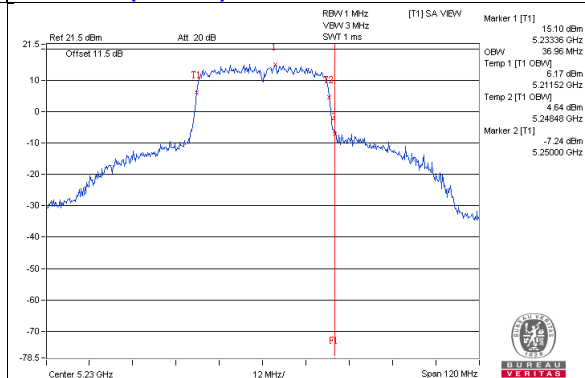

802.11ac (VHT80) / Chain 0 : CH42

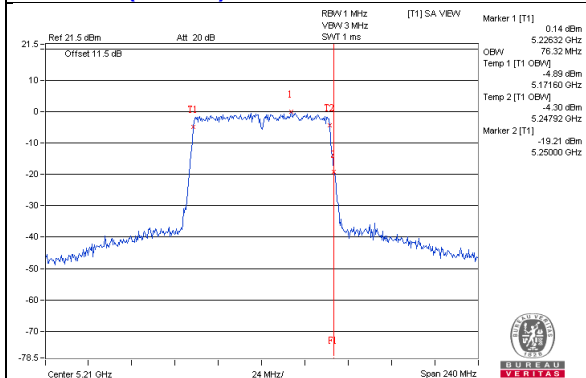

802.11ac (VHT80) / Chain 1 : CH42

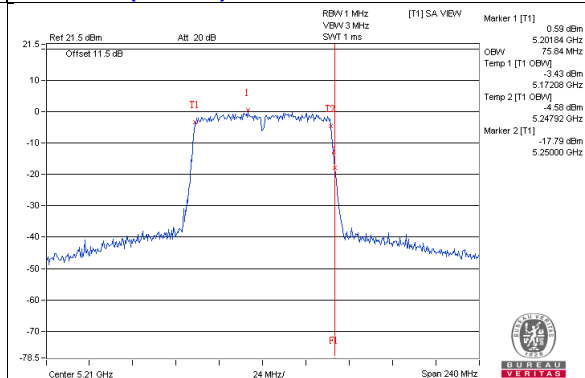

802.11ac (VHT80) / Chain 2 : CH42

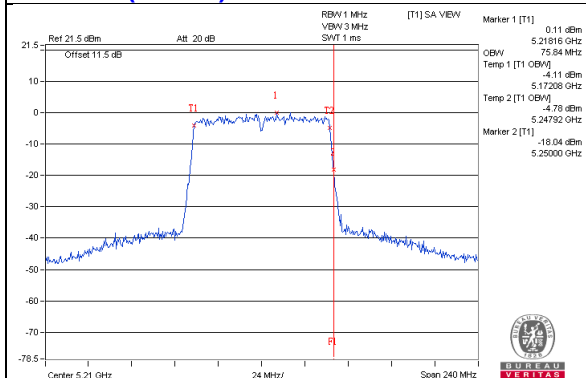

802.11ac (VHT80) / Chain 3 : CH42

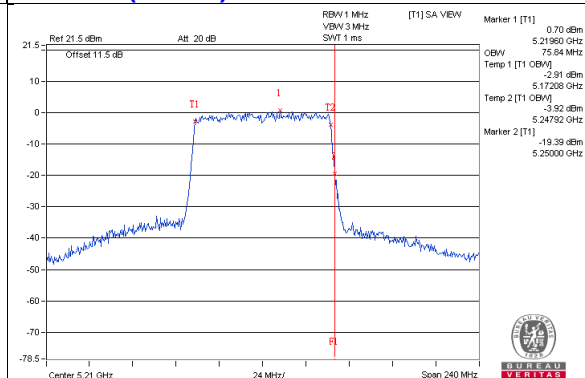

**Spectrum Plot for near by DFS band
(DFS is required, if 99% OCP straddle into U-NII-2A band)**

802.11ac(VHT80+80) / Chain 0 : CH42

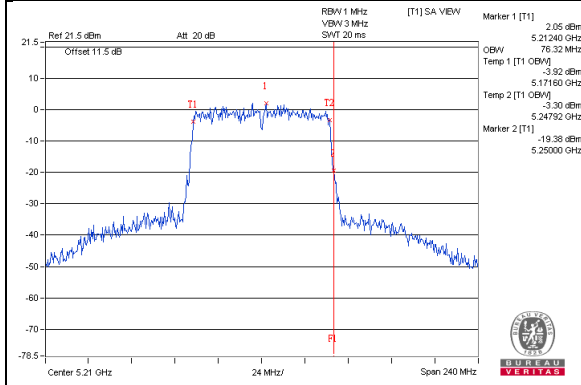

802.11ac(VHT80+80) / Chain 1 : CH42

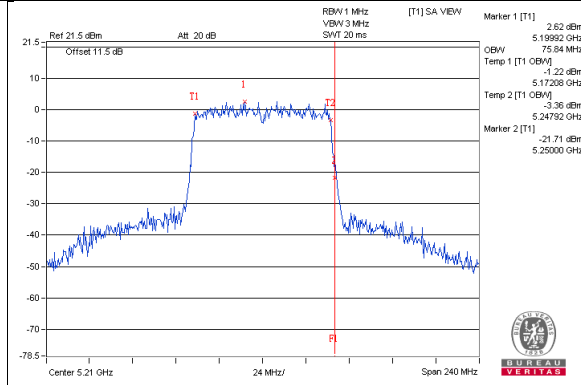

Spectrum Plot for near by DFS band (DFS is required, if 99% OCP straddle into U-NII-2C band)

802.11a / Chain 0 : CH149

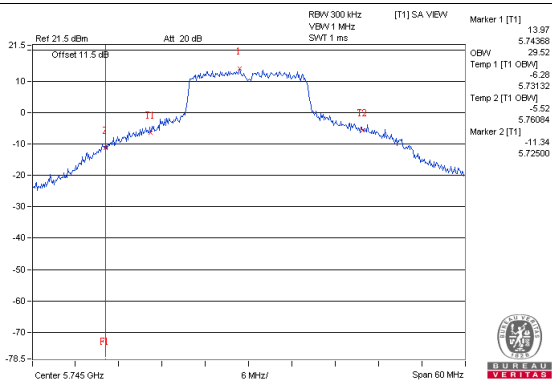

802.11a / Chain 1 : CH149

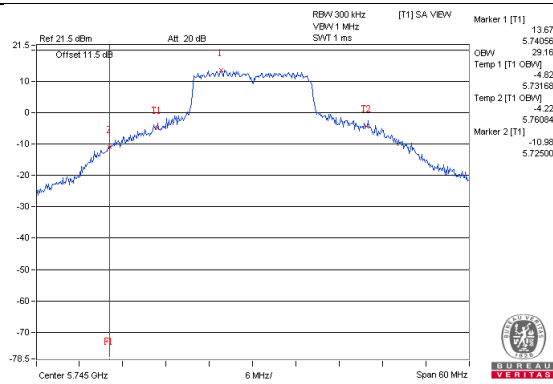

802.11a / Chain 2 : CH149

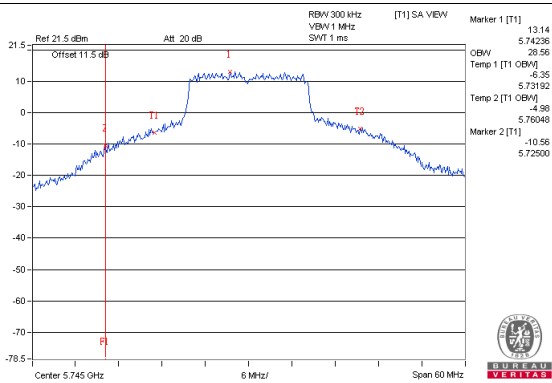

802.11a / Chain 3 : CH149

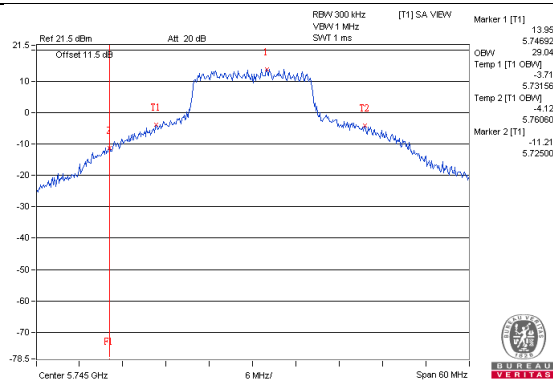

802.11ac (VHT20) / Chain 0 : CH149

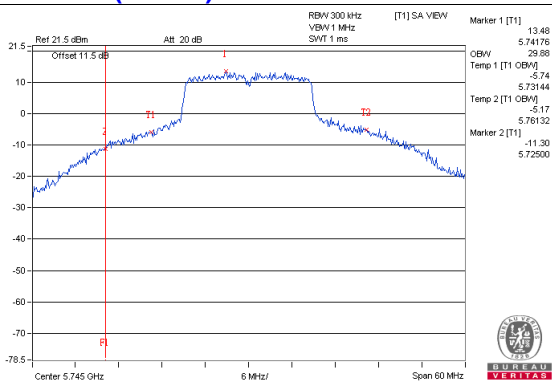

802.11ac (VHT20) / Chain 1 : CH149

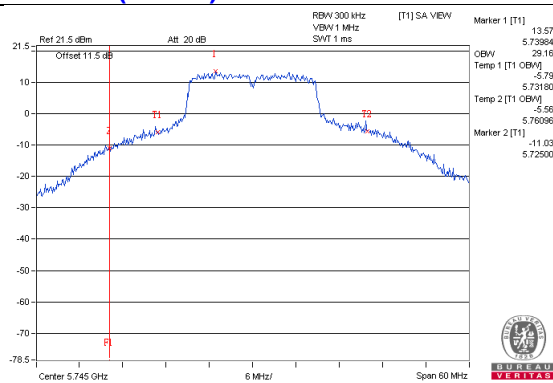

802.11ac (VHT20) / Chain 2 : CH149

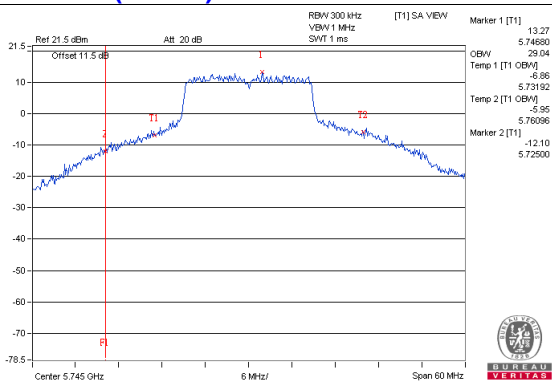

802.11ac (VHT20) / Chain 3 : CH149

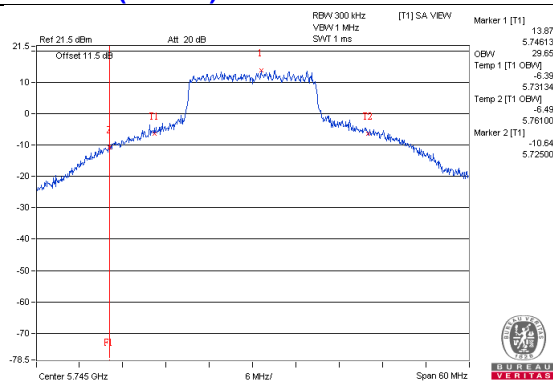

Spectrum Plot for near by DFS band (DFS is required, if 99% OCP straddle into U-NII-2C band)

802.11ac (VHT40) / Chain 0 : CH151

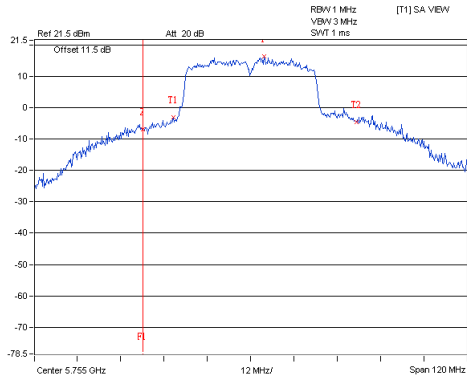

802.11ac (VHT40) / Chain 1 : CH151

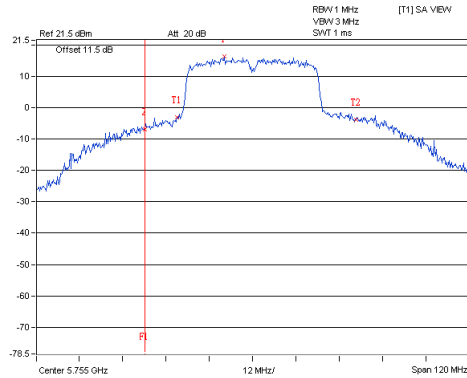

802.11ac (VHT40) / Chain 2 : CH151

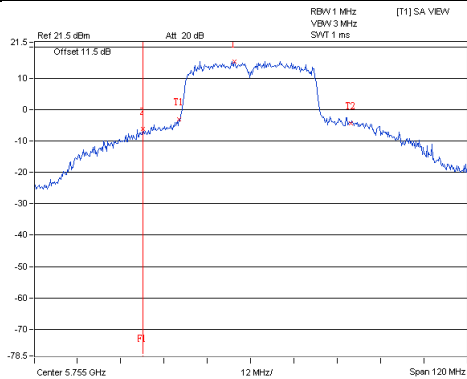

802.11ac (VHT40) / Chain 3 : CH151

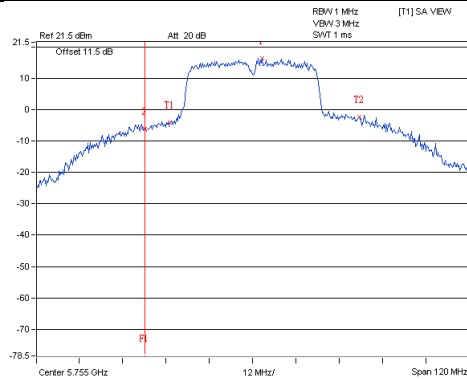

802.11ac (VHT80) / Chain 0 : CH155

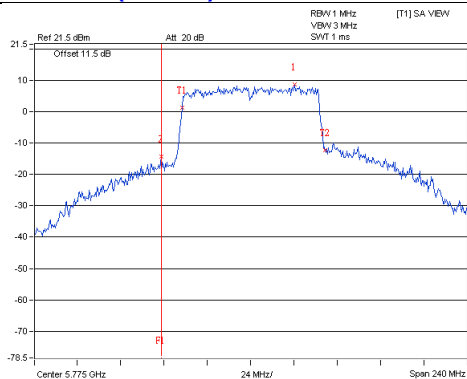

802.11ac (VHT80) / Chain 1 : CH155

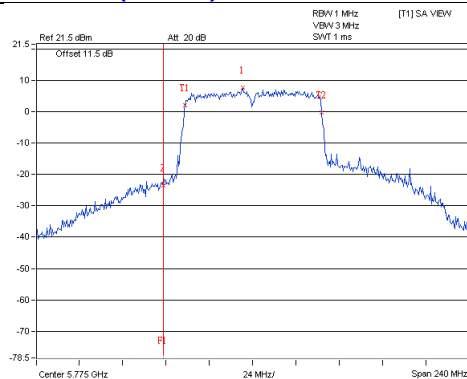

802.11ac (VHT80) / Chain 2 : CH155

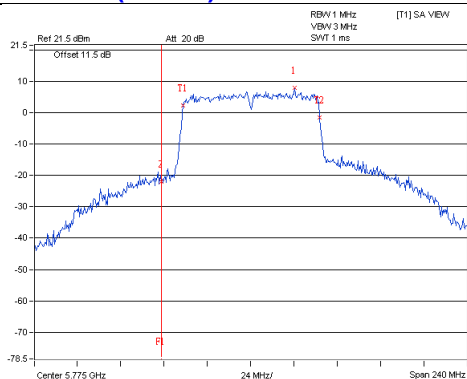

802.11ac (VHT80) / Chain 3 : CH155

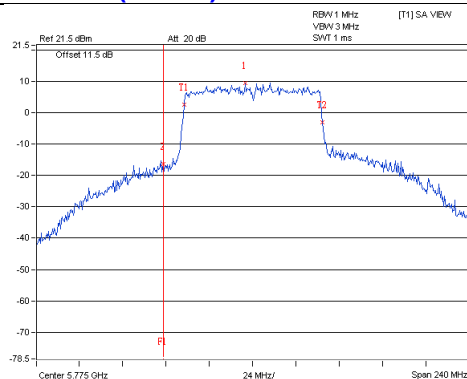

Spectrum Plot for near by DFS band (DFS is required, if 99% OCP straddle into U-NII-2C band)

802.11ac (VHT80+80) / Chain 2 : CH155

802.11ac (VHT80+80) / Chain 3 : CH155

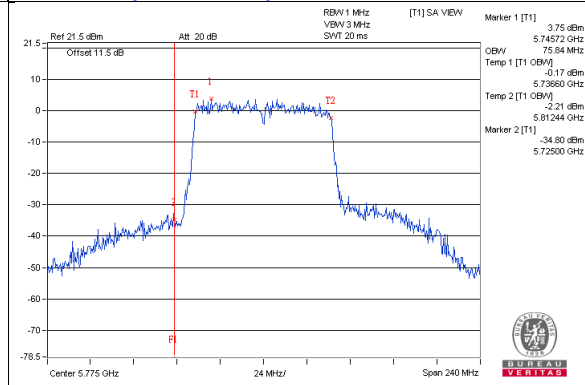
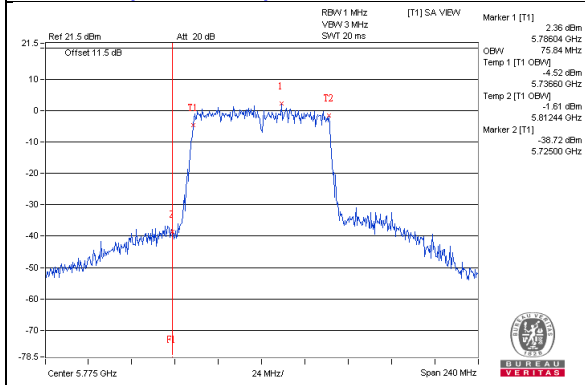

4.4.5 Test Results (Mode 2)

802.11a

Channel	Channel Frequency (MHz)	Occupied Bandwidth (MHz)		
		Chain 0	Chain 1	Chain 2
36	5180	16.68	16.56	16.68
40	5200	16.80	16.68	16.80
48	5240	16.80	16.68	16.68
149	5745	27.24	26.28	27.12
157	5785	27.60	25.44	26.28
165	5825	24.24	24.72	27.36

802.11ac (VHT20)

Channel	Channel Frequency (MHz)	Occupied Bandwidth (MHz)		
		Chain 0	Chain 1	Chain 2
36	5180	17.88	17.88	17.88
40	5200	17.88	17.88	17.88
48	5240	18.00	17.88	17.88
149	5745	27.60	24.84	27.00
157	5785	25.80	26.16	26.04
165	5825	25.08	24.12	27.00

802.11ac (VHT40)

Channel	Channel Frequency (MHz)	Occupied Bandwidth (MHz)		
		Chain 0	Chain 1	Chain 2
38	5190	36.24	36.24	36.24
46	5230	36.72	36.24	36.48
151	5755	47.52	44.64	47.76
159	5795	45.36	44.64	49.68

802.11ac (VHT80)

Channel	Channel Frequency (MHz)	Occupied Bandwidth (MHz)		
		Chain 0	Chain 1	Chain 2
42	5210	75.84	75.36	75.84
155	5775	76.80	76.80	76.80

Spectrum Plot of Worst Value

802.11a_Chain0 / CH157

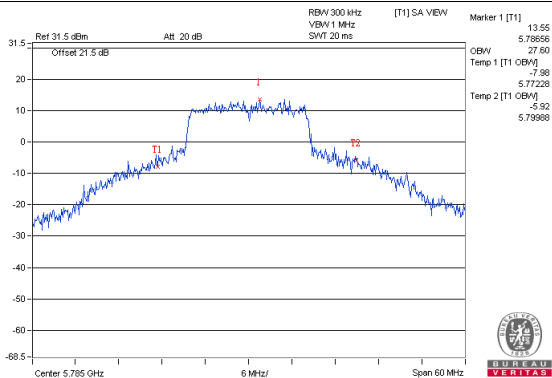

802.11ac (VHT20)_Chain0 / CH149

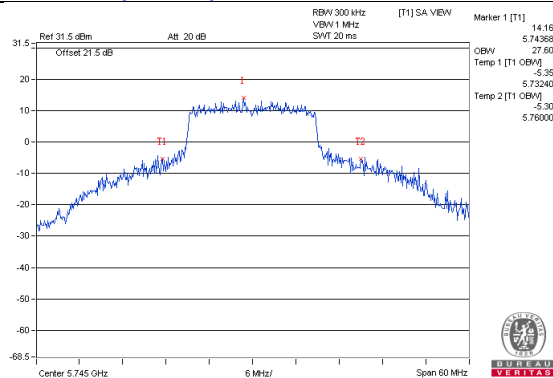

802.11ac (VHT40)_Chain2 / CH159

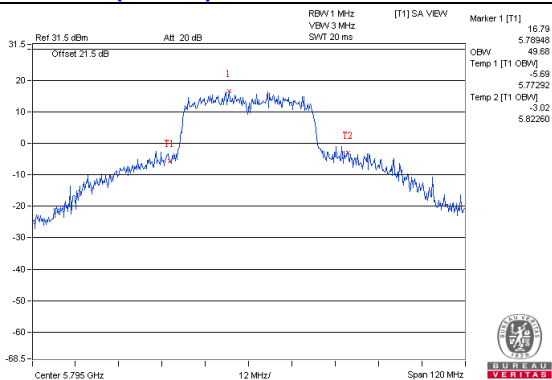

802.11ac (VHT80)_Chain0 / CH155

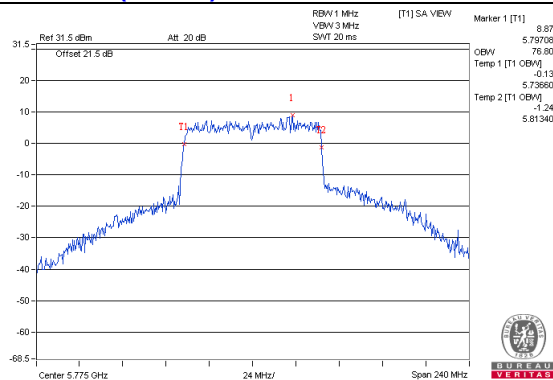

Spectrum Plot for near by DFS band (DFS is required, if 99% OCP straddle into U-NII-2A band)

802.11a_Chain0 / CH48

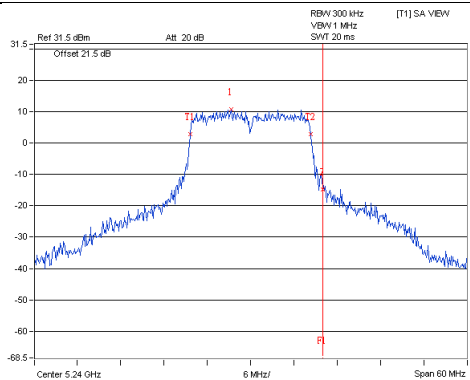

802.11a_Chain1 / CH48

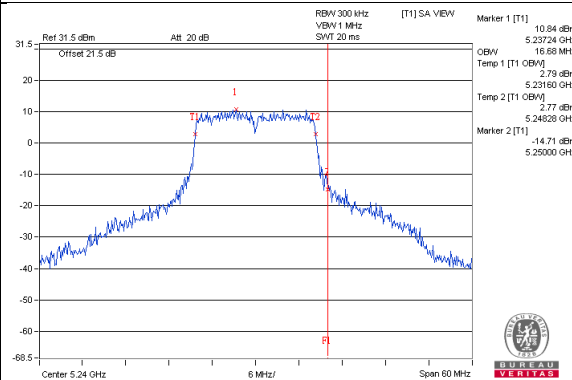

802.11a_Chain2 / CH48

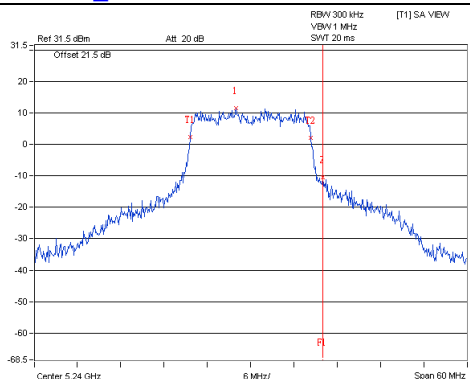

802.11ac(VHT20)_Chain0 / CH48

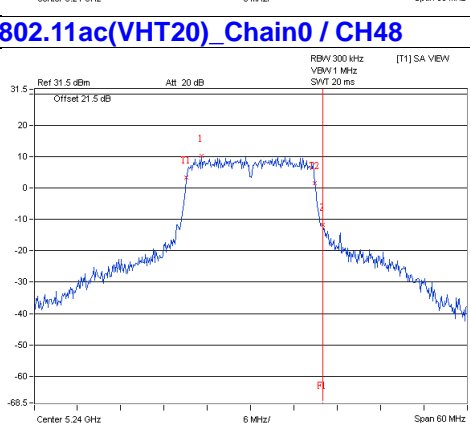

802.11ac(VHT20)_Chain1 / CH48

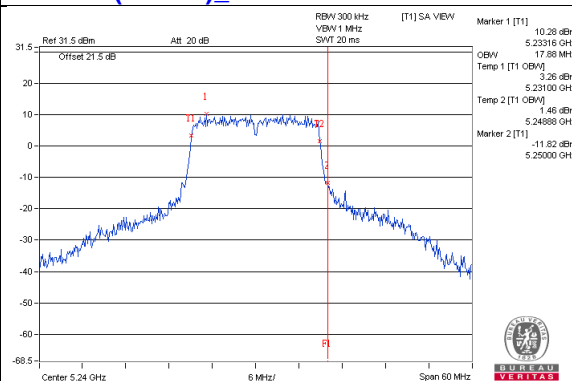

802.11ac(VHT20)_Chain2 / CH48

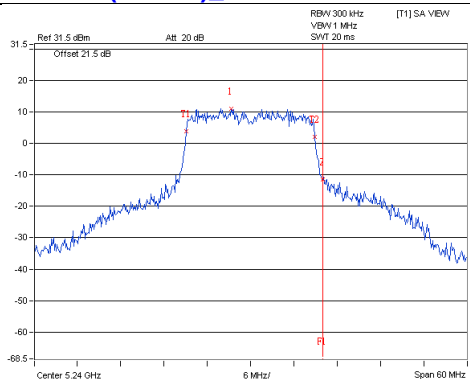

802.11ac(VHT20)_Chain3 / CH48

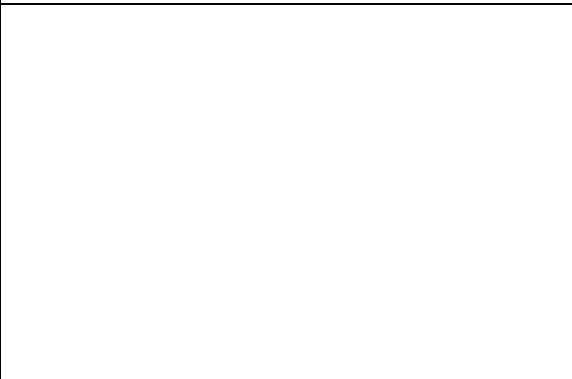

Spectrum Plot for near by DFS band (DFS is required, if 99% OCP straddle into U-NII-2A band)

802.11ac(VHT40)_Chain0 / CH46

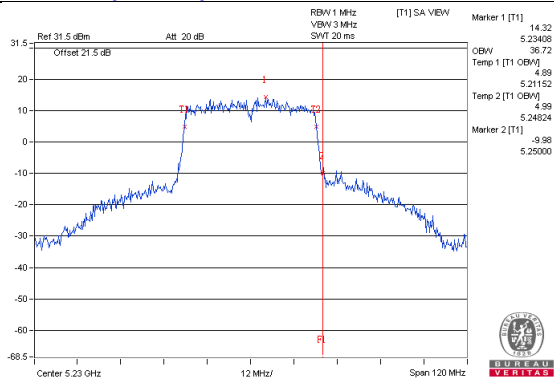

802.11ac(VHT40)_Chain1 / CH46

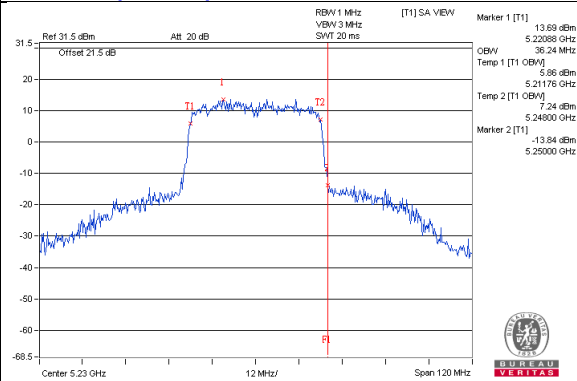

802.11ac(VHT40)_Chain2 / CH46

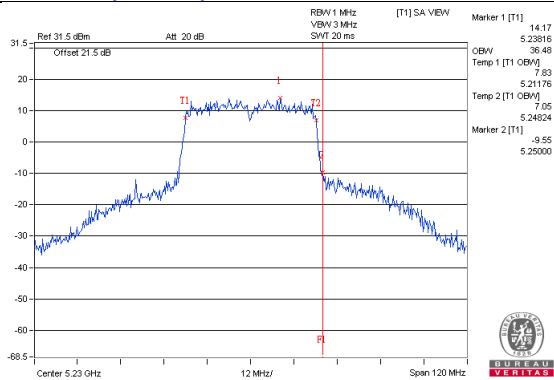

802.11ac(VHT80)_Chain0 / CH42

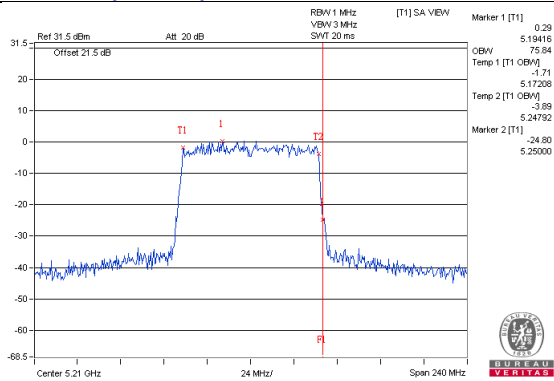

802.11ac(VHT80)_Chain1 / CH42

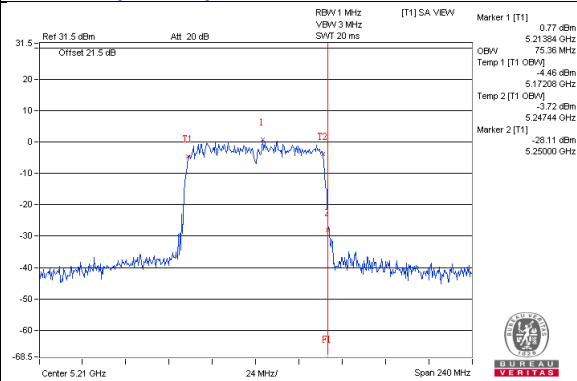

802.11ac(VHT80)_Chain2 / CH42

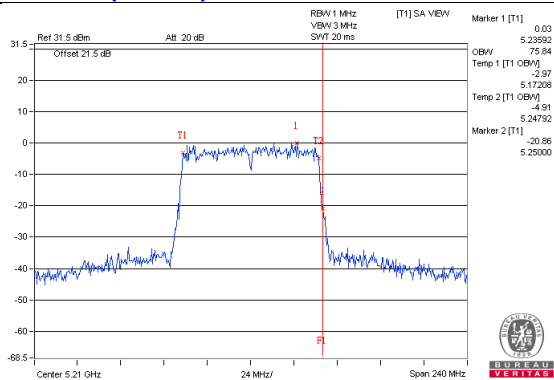

Spectrum Plot for near by DFS band (DFS is required, if 99% OCP straddle into U-NII-2C band)

802.11a_Chain0 / CH149

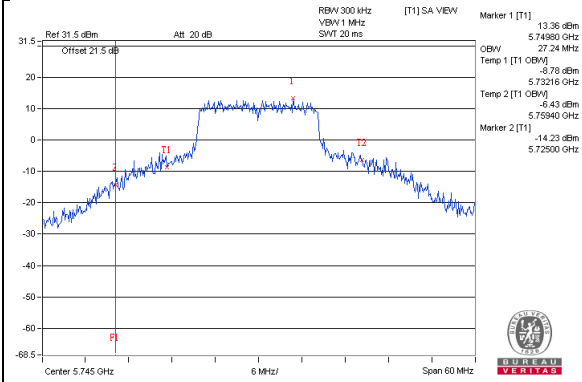

802.11a_Chain1 / CH149

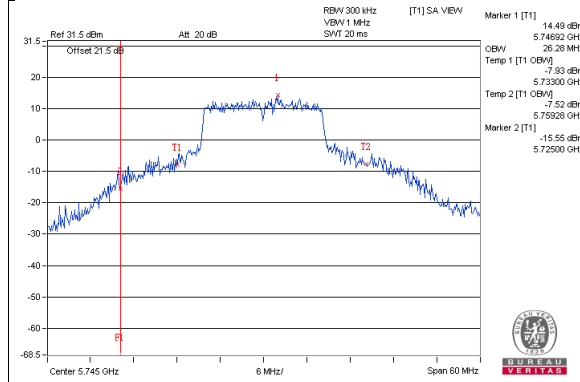

802.11a_Chain2 / CH149

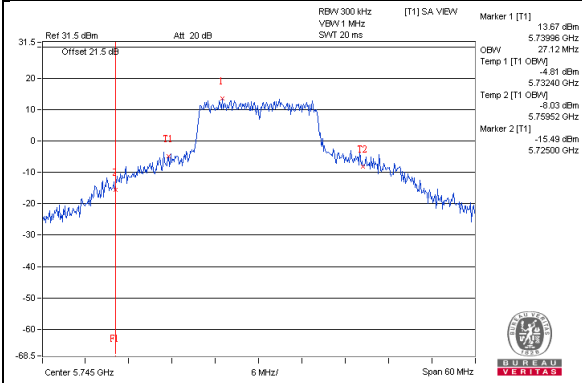

802.11ac(VHT20)_Chain0 / CH149

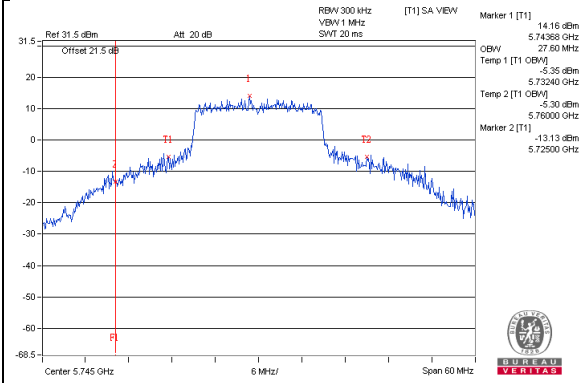

802.11ac(VHT20)_Chain1 / CH149

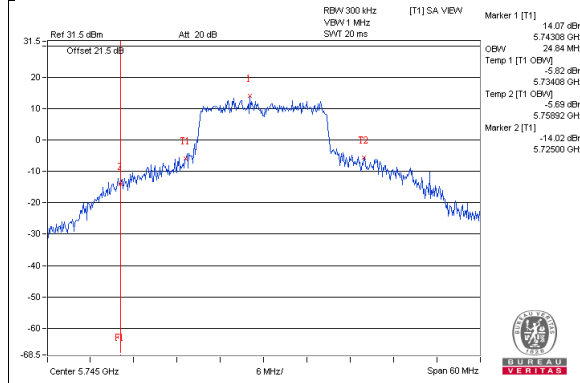

802.11ac(VHT20)_Chain2 / CH149

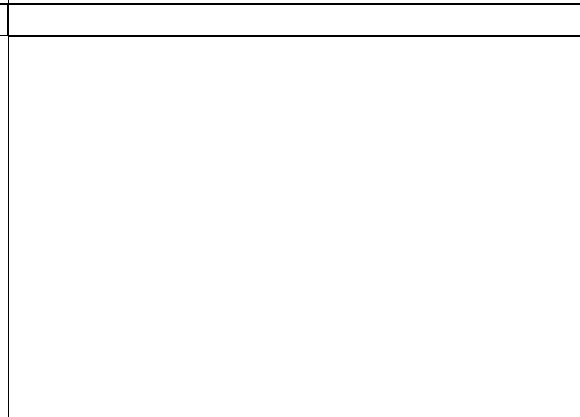
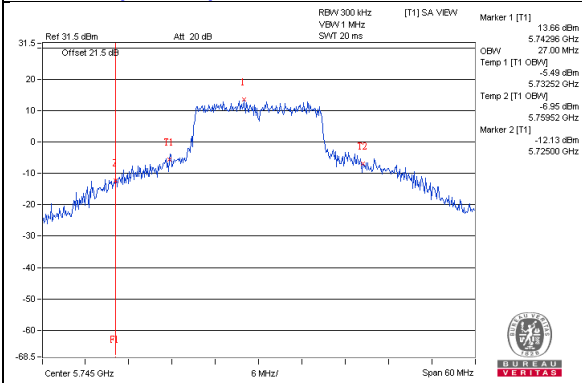

Spectrum Plot for near by DFS band (DFS is required, if 99% OCP straddle into U-NII-2C band)

802.11ac(VHT40)_Chain0 / CH151

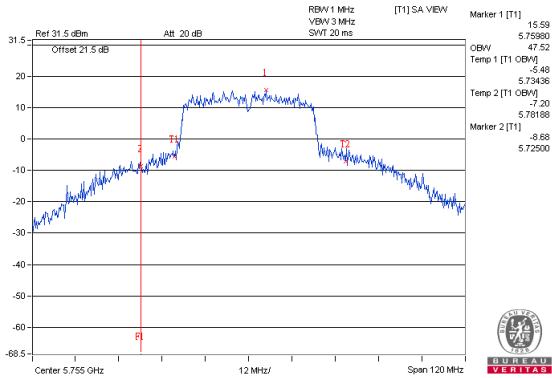

802.11ac(VHT40)_Chain1 / CH151

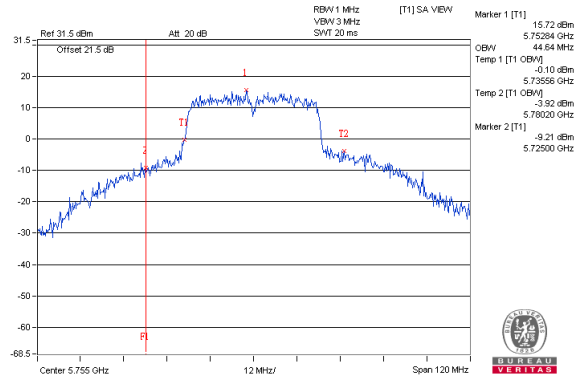

802.11ac(VHT40)_Chain2 / CH151

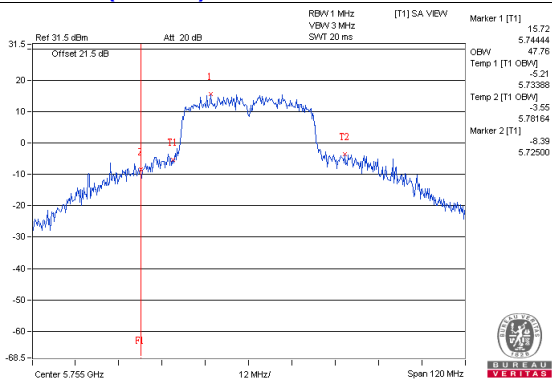

802.11ac(VHT80)_Chain0 / CH155

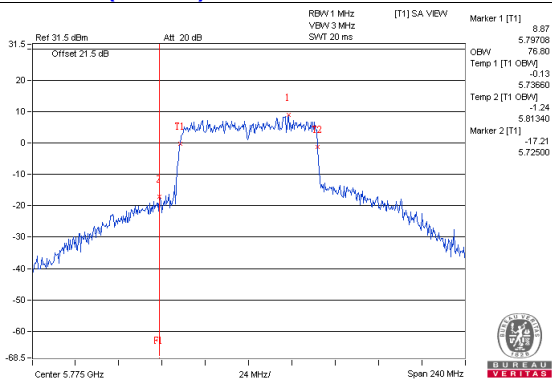

802.11ac(VHT80)_Chain1 / CH155

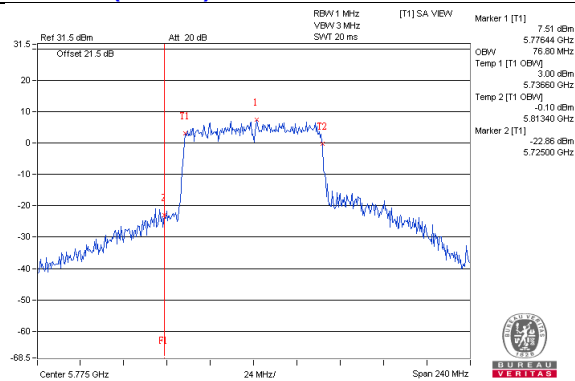

802.11ac(VHT80)_Chain2 / CH155

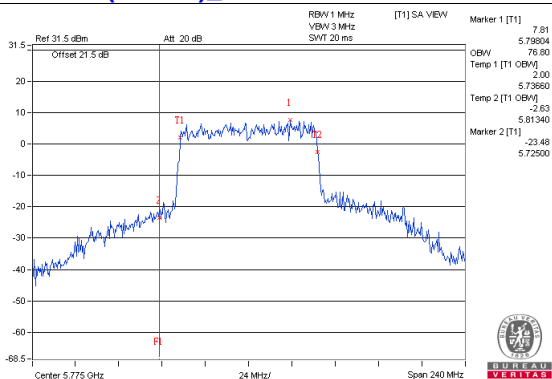

4.4.6 Test Results (Mode 3)

802.11a

Channel	Channel Frequency (MHz)	Occupied Bandwidth (MHz)	
		CHAIN 0	CHAIN 1
36	5180	16.68	16.56
40	5200	22.08	17.28
48	5240	19.08	17.28
149	5745	26.28	25.20
157	5785	25.80	26.88
165	5825	25.92	23.52

802.11ac (VHT20)

Channel	Channel Frequency (MHz)	Occupied Bandwidth (MHz)	
		CHAIN 0	CHAIN 1
36	5180	17.88	17.88
40	5200	18.24	18.24
48	5240	18.24	17.88
149	5745	26.76	26.16
157	5785	26.76	27.12
165	5825	24.72	23.88

802.11ac (VHT40)

Channel	Channel Frequency (MHz)	Occupied Bandwidth (MHz)	
		CHAIN 0	CHAIN 1
38	5190	36.24	36.24
46	5230	36.72	36.72
151	5755	44.88	44.88
159	5795	50.16	46.80

802.11ac (VHT80)

Channel	Channel Frequency (MHz)	Occupied Bandwidth (MHz)	
		CHAIN 0	CHAIN 1
42	5210	76.32	75.84
155	5775	77.28	76.32

802.11ac (VHT80+80)

Channel	Channel Frequency (MHz)	Occupied Bandwidth (MHz)	
		Chain 0	Chain 2
42+155	5210	76.32	-
	5775	-	76.32

Spectrum Plot of Worst Value

802.11a_Chain1 / CH157

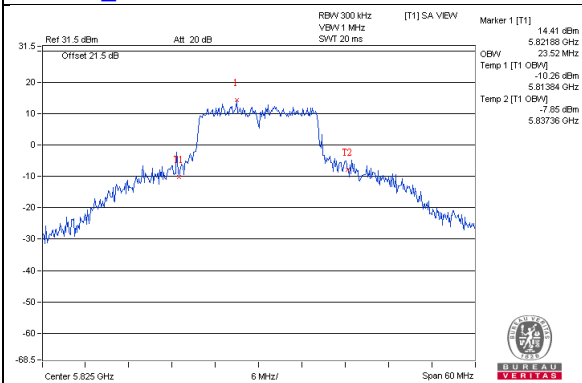

802.11ac (VHT20)_Chain1 / CH157

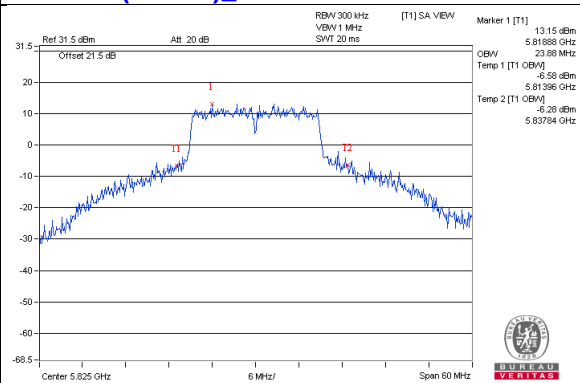

802.11ac (VHT40)_Chain0 / CH159

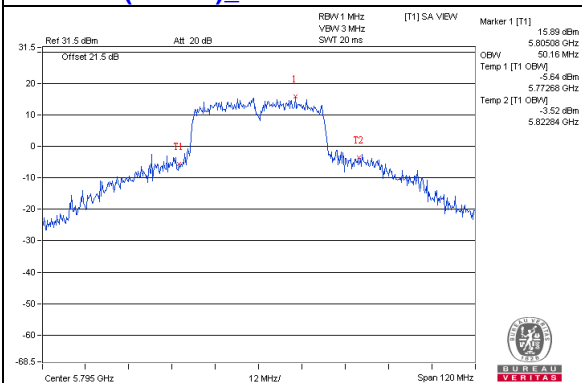

802.11ac (VHT80)_Chain0 / CH155

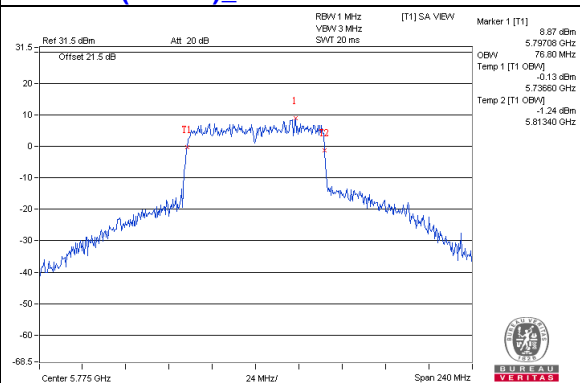

802.11ac (VHT80+80)_Chain2 / CH155

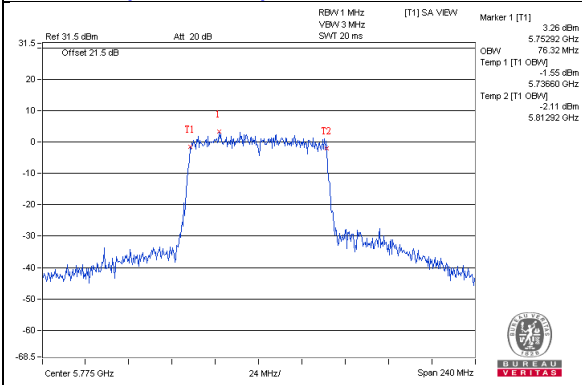

Spectrum Plot for near by DFS band (DFS is required, if 99% OCP straddle into U-NII-2A band)

802.11a_Chain0 / CH48

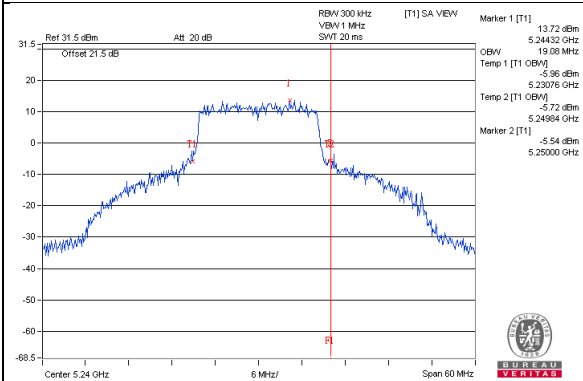

802.11a_Chain1 / CH48

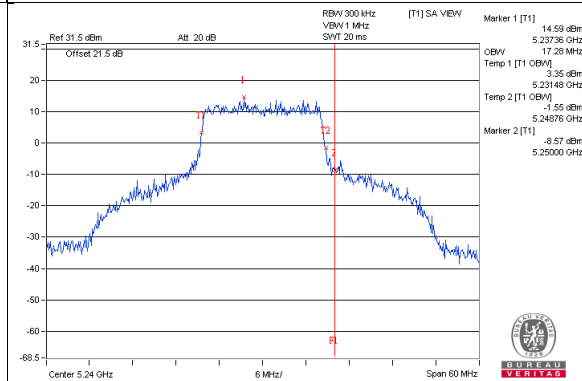

802.11ac(VHT20)_Chain0 / CH48

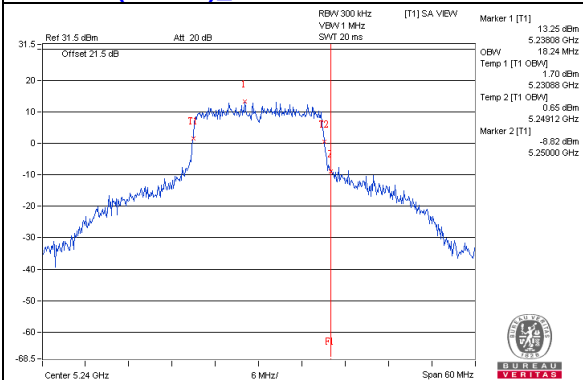

802.11ac(VHT20)_Chain1 / CH48

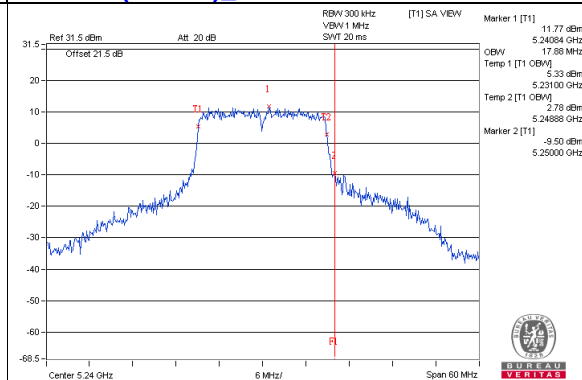

802.11ac(VHT40)_Chain0 / CH46

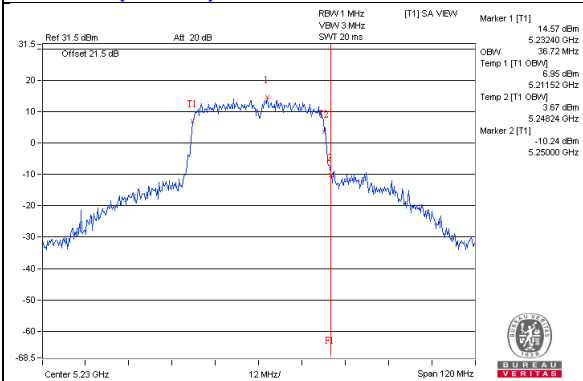

802.11ac(VHT40)_Chain1 / CH46

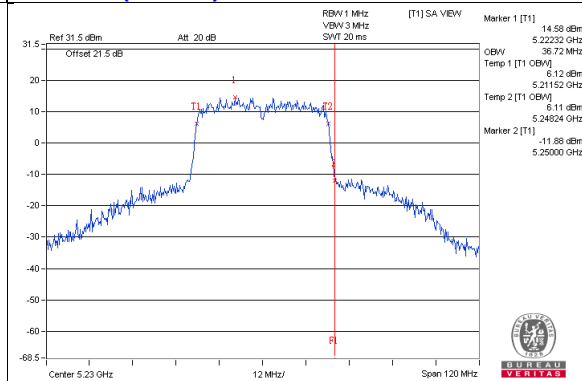

802.11ac(VHT80)_Chain0 / CH42

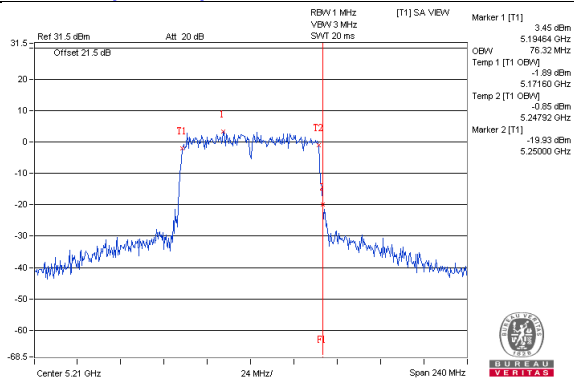

802.11ac(VHT80)_Chain1 / CH42

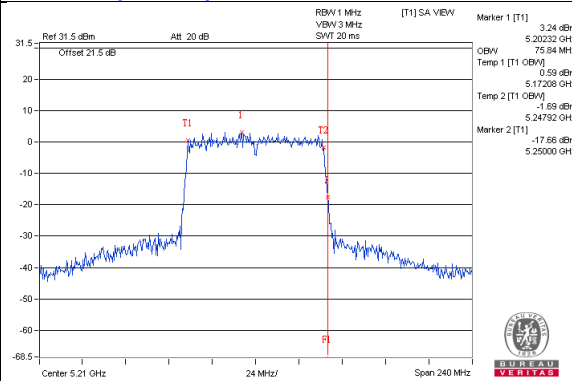

802.11ac(VHT80+80)_Chain0 / CH42

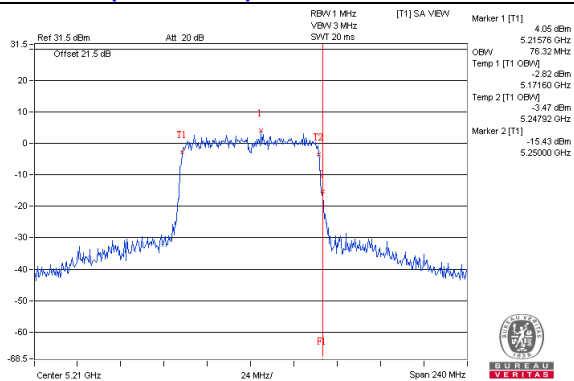

Spectrum Plot for near by DFS band (DFS is required, if 99% OCP straddle into U-NII-2C band)

802.11a_Chain0 / CH149

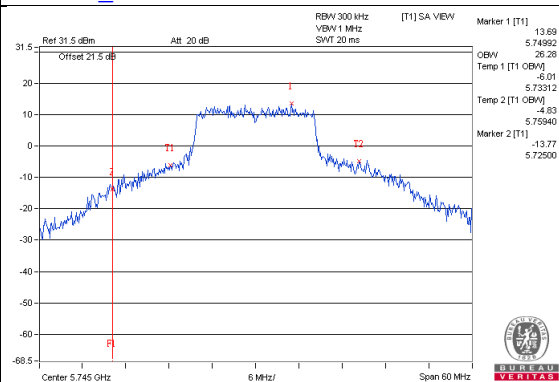

802.11a_Chain1 / CH149

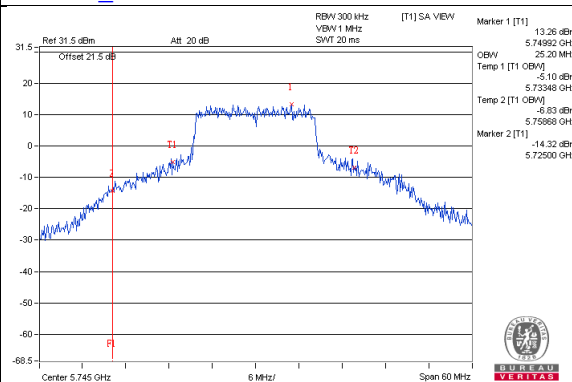

802.11ac(VHT20)_Chain0 / CH149

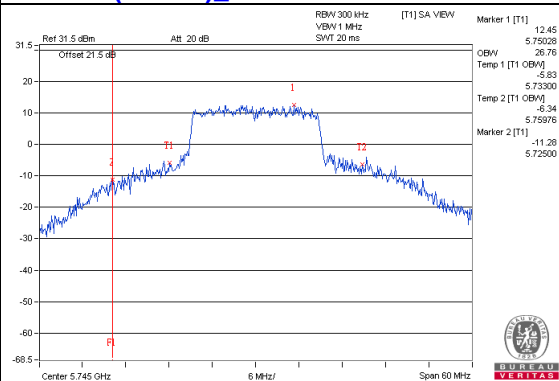

802.11ac(VHT20)_Chain1 / CH149

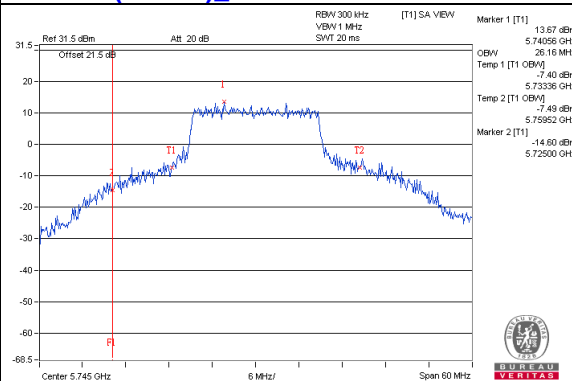

802.11ac(VHT40)_Chain0 / CH151

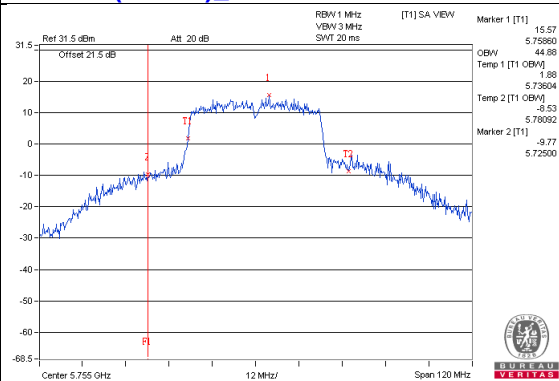

802.11ac(VHT40)_Chain1 / CH151

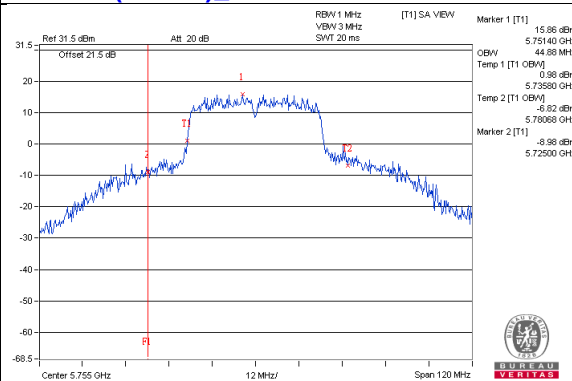

802.11ac(VHT80)_Chain0 / CH155

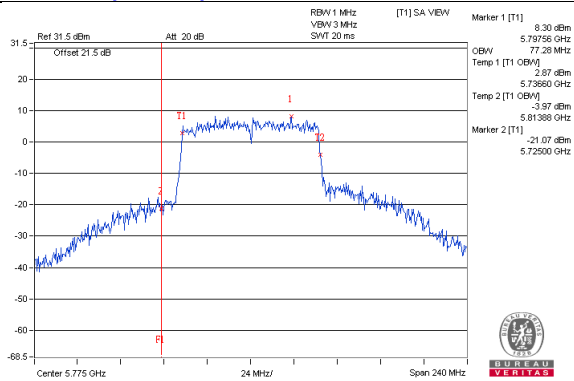

802.11ac(VHT80)_Chain1 / CH155

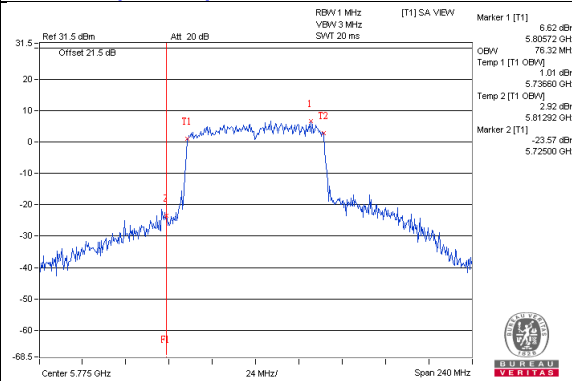

802.11ac(VHT80+80)_Chain2 / CH155

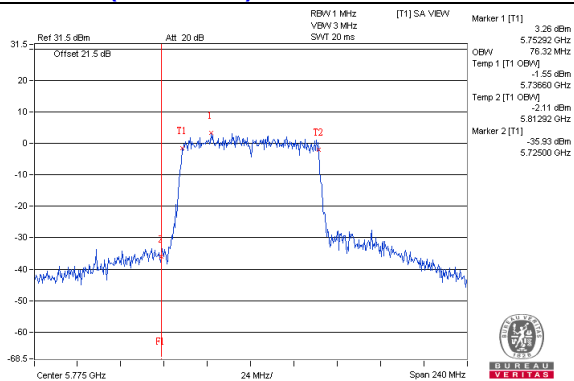

4.4.7 Test Results (Mode 4)

802.11a

Channel	Channel Frequency (MHz)	Occupied Bandwidth (MHz)
36	5180	16.80
40	5200	20.76
48	5240	18.36
149	5745	27.84
157	5785	24.48
165	5825	23.88

802.11ac (VHT20)

Channel	Channel Frequency (MHz)	Occupied Bandwidth (MHz)
36	5180	18.12
40	5200	18.24
48	5240	18.24
149	5745	25.68
157	5785	25.08
165	5825	24.84

802.11ac (VHT40)

Channel	Channel Frequency (MHz)	Occupied Bandwidth (MHz)
38	5190	36.48
46	5230	36.72
151	5755	42.96
159	5795	43.92

802.11ac (VHT80)

Channel	Channel Frequency (MHz)	Occupied Bandwidth (MHz)
42	5210	75.84
155	5775	77.76

Spectrum Plot of Worst Value

802.11a / CH149

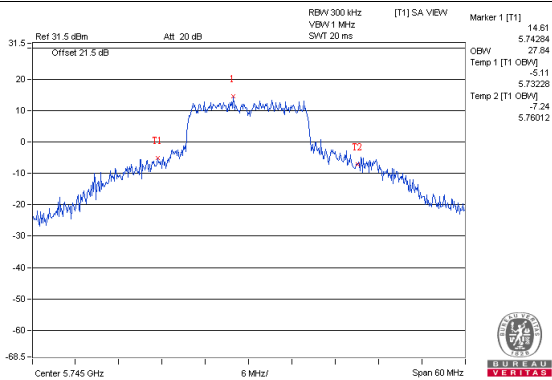

802.11ac (VHT20) / CH149

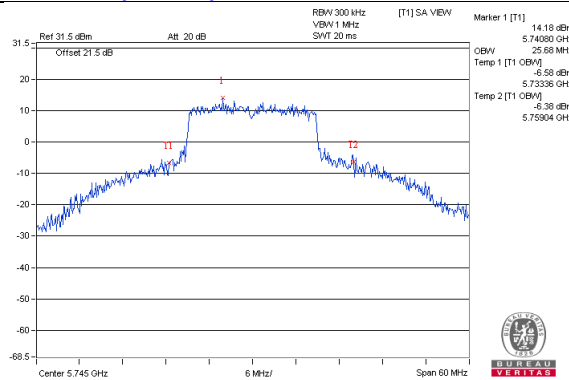

802.11ac (VHT40) / CH159

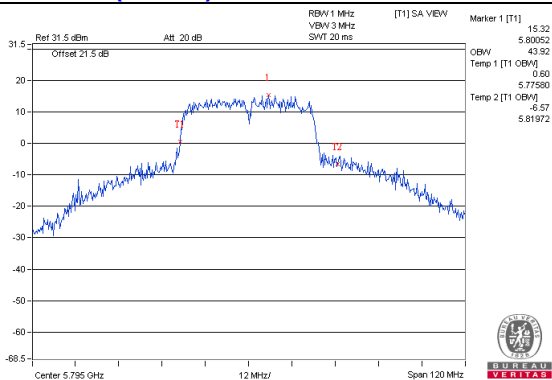

802.11ac (VHT80) / CH155

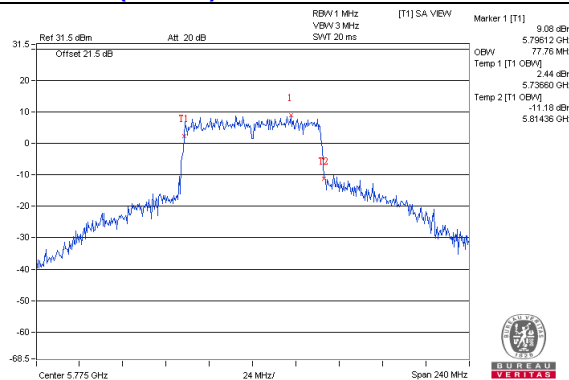

Spectrum Plot for near by DFS band (DFS is required, if 99% OCP straddle into U-NII-2A band)

802.11a / CH48

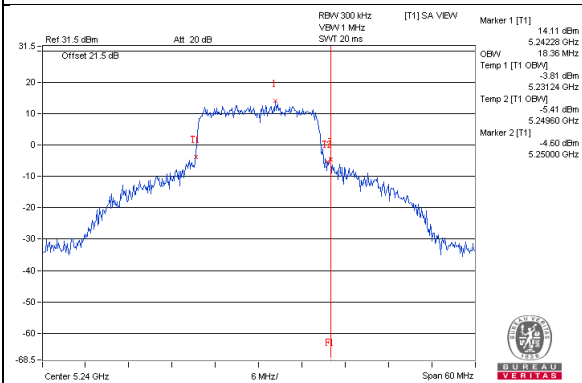

802.11ac(VHT20) / CH48

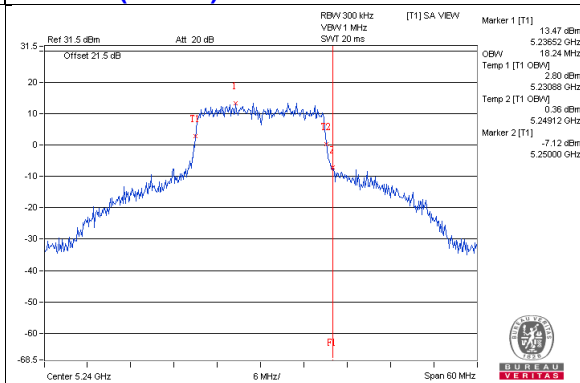

802.11ac(VHT40) / CH46

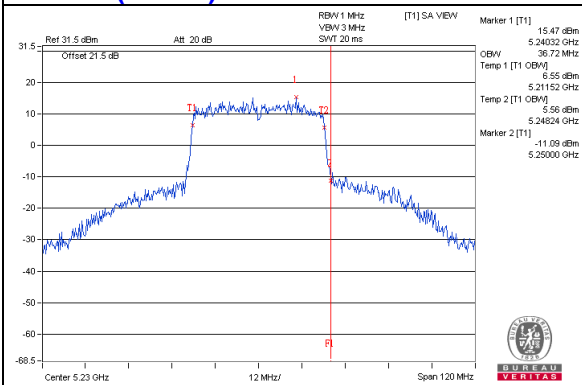

802.11ac(VHT80) / CH42

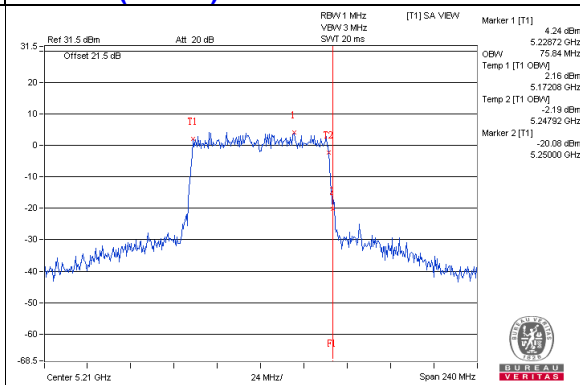

Spectrum Plot for near by DFS band (DFS is required, if 99% OCP straddle into U-NII-2C band)

802.11a / CH149

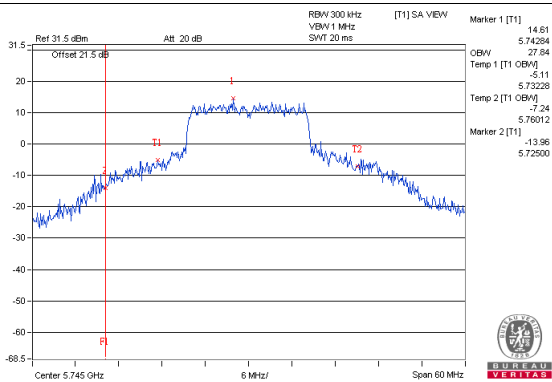

802.11ac(VHT20) / CH149

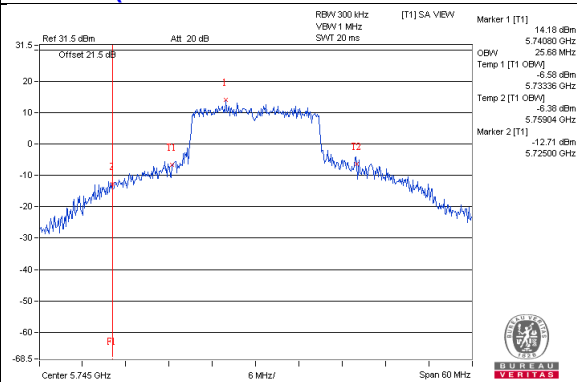

802.11ac(VHT40) / CH151

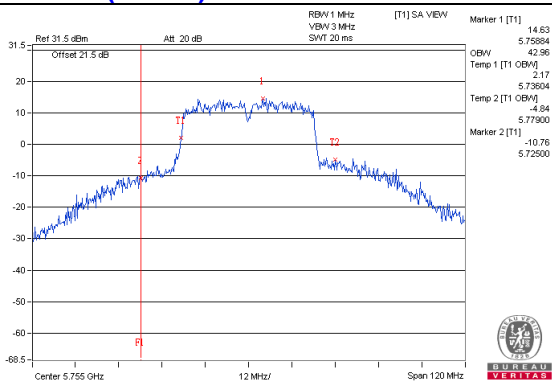

802.11ac(VHT80) / CH155

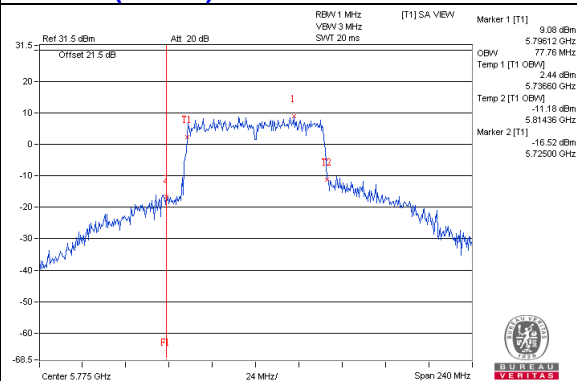

4.5 Peak Power Spectral Density Measurement

4.5.1 Limits of Peak Power Spectral Density Measurement

Operation Band	EUT Category		Limit
U-NII-1		Outdoor Access Point	17dBm/ MHz
		Fixed point-to-point Access Point	
	√	Indoor Access Point	
		Mobile and Portable client device	11dBm/ MHz
U-NII-2A			11dBm/ MHz
U-NII-2C			11dBm/ MHz
U-NII-3	√		30dBm/ 500kHz

4.5.2 Test Setup

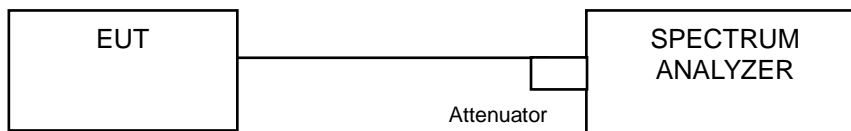

4.5.3 Test Instruments

Refer to section 4.1.2 to get information of above instrument.

4.5.4 Test Procedure

802.11ac (VHT20)

For U-NII-1:

Using method SA-1

1. Set span to encompass the entire emission bandwidth (EBW) of the signal.
2. Set RBW = 1 MHz, Set VBW \geq 3 MHz, Detector = RMS
3. Sweep time = auto, trigger set to "free run".
4. Trace average at least 100 traces in power averaging mode.
5. Record the max value

For U-NII-3:

1. Set span to encompass the entire emission bandwidth (EBW) of the signal.
2. Set RBW = 300 kHz, Set VBW \geq 1 MHz, Detector = RMS
3. Use the peak marker function to determine the maximum power level in any 300 kHz band segment within the fundamental EBW.
4. Scale the observed power level to an equivalent value in 500 kHz by adjusting (reducing) the measured power by a bandwidth correction factor (BWCF) where $BWCF = 10\log(500 \text{ kHz}/300\text{kHz})$
5. Sweep time = auto, trigger set to "free run".
6. Trace average at least 100 traces in power averaging mode.
7. Record the max value

802.11a, 802.11ac (VHT40), 802.11ac (VHT80)

For U-NII-1:

Using method SA-2

1. Set span to encompass the entire emission bandwidth (EBW) of the signal.
2. Set RBW = 1 MHz, Set VBW \geq 3 MHz, Detector = RMS
3. Sweep time = auto, trigger set to "free run".
4. Trace average at least 100 traces in power averaging mode.
5. Record the max value and add $10 \log (1/\text{duty cycle})$

For U-NII-3:

1. Set span to encompass the entire emission bandwidth (EBW) of the signal.
2. Set RBW = 300 kHz, Set VBW \geq 1 MHz, Detector = RMS
3. Use the peak marker function to determine the maximum power level in any 300 kHz band segment within the fundamental EBW.
4. Scale the observed power level to an equivalent value in 500 kHz by adjusting (reducing) the measured power by a bandwidth correction factor (BWCF) where $BWCF = 10\log(500 \text{ kHz}/300\text{kHz})$
5. Sweep time = auto, trigger set to "free run".
6. Trace average at least 100 traces in power averaging mode.
7. Record the max value and add $10 \log (1/\text{duty cycle})$

4.5.5 Deviation from Test Standard

No deviation.

4.5.6 EUT Operating Condition

Same as Item 4.3.6.

4.5.7 Test Results (Mode 1)

For U-NII-1:

802.11a

Chan.	Chan. Freq. (MHz)	PSD W/O Duty Factor (dBm)				Duty Factor (dB)	Total PSD With Duty Factor (dBm)	MAX. Limit (dBm/MHz)	Pass / Fail
		Chain 0	Chain 1	Chain 2	Chain 3				
36	5180	5.27	5.43	4.88	4.60	0.13	11.21	11.33	Pass
40	5200	5.00	5.41	3.95	5.26	0.13	11.09	11.33	Pass
48	5240	5.31	3.99	4.17	5.46	0.13	10.93	11.33	Pass

- Note:** 1. Method a) of power density measurement of KDB 662911 is using for calculating total power density. Total power density is summing entire spectra across corresponding frequency bins on the various outputs by computer.
2. Directional gain = $10 \log[(10^{G1/20} + 10^{G2/20} + 10^{G2/20} + 10^{G2/20})^2 / 4] = 11.67\text{dBi} > 6\text{dBi}$, so the power density limit shall be reduced to $17 - (11.67 - 6) = 11.33\text{dBm}$.
3. Refer to section 3.3 for duty cycle spectrum plot.

802.11ac (VHT20)

Chan.	Chan. Freq. (MHz)	PSD (dBm/MHz)				Total Power Density (dBm/MHz)	MAX. Limit (dBm/MHz)	Pass / Fail
		Chain 0	Chain 1	Chain 2	Chain 3			
36	5180	5.20	5.04	4.98	5.32	11.16	11.33	Pass
40	5200	4.74	4.99	4.47	4.92	10.81	11.33	Pass
48	5240	5.17	4.93	4.52	5.47	11.06	11.33	Pass

- Note:** 1. Method a) of power density measurement of KDB 662911 is using for calculating total power density. Total power density is summing entire spectra across corresponding frequency bins on the various outputs by computer.
2. Directional gain = $10 \log[(10^{G1/20} + 10^{G2/20} + 10^{G2/20} + 10^{G2/20})^2 / 4] = 11.67\text{dBi} > 6\text{dBi}$, so the power density limit shall be reduced to $17 - (11.67 - 6) = 11.33\text{dBm}$.

802.11ac (VHT40)

Chan.	Chan. Freq. (MHz)	PSD W/O Duty Factor (dBm)				Duty Factor (dB)	Total PSD With Duty Factor (dBm)	MAX. Limit (dBm/MHz)	Pass / Fail
		Chain 0	Chain 1	Chain 2	Chain 3				
38	5190	-3.92	-3.46	-4.69	-3.82	0.11	2.18	11.33	Pass
46	5230	4.38	3.80	3.29	4.57	0.11	10.17	11.33	Pass

- Note:** 1. Method a) of power density measurement of KDB 662911 is using for calculating total power density. Total power density is summing entire spectra across corresponding frequency bins on the various outputs by computer.
2. Directional gain = $10 \log[(10^{G1/20} + 10^{G2/20} + 10^{G2/20} + 10^{G2/20})^2 / 4] = 11.67\text{dBi} > 6\text{dBi}$, so the power density limit shall be reduced to $17 - (11.67 - 6) = 11.33\text{dBm}$.
3. Refer to section 3.3 for duty cycle spectrum plot.

802.11ac (VHT80)

Chan.	Chan. Freq. (MHz)	PSD W/O Duty Factor (dBm)				Duty Factor (dB)	Total PSD With Duty Factor (dBm)	MAX. Limit (dBm/MHz)	Pass / Fail
		Chain 0	Chain 1	Chain 2	Chain 3				
42	5210	-10.40	-10.65	-11.33	-9.94	0.24	-4.29	11.33	Pass

- Note:**
- Method a) of power density measurement of KDB 662911 is using for calculating total power density. Total power density is summing entire spectra across corresponding frequency bins on the various outputs by computer.
 - Directional gain = $10 \log[(10^{G1/20} + 10^{G2/20} + 10^{G2/20} + 10^{G2/20})^2 / 4] = 11.67\text{dBi} > 6\text{dBi}$, so the power density limit shall be reduced to $17 - (11.67 - 6) = 11.33\text{dBm}$.
 - Refer to section 3.3 for duty cycle spectrum plot.

802.11ac (VHT80+80)

Chan.	Chan. Freq. (MHz)	PSD W/O Duty Factor (dBm)				Duty Factor (dB)	Total Power Density (dBm/MHz)	MAX. Limit (dBm/MHz)	Pass / Fail
		Chain 0	Chain 1	Chain 2	Chain 3				
42+ 155	5210	-8.16	-7.78	-	-	0.24	-4.72	14.16	Pass
	5775	Test results refer to U_NII-3 data							

- Note:**
- Method a) of power density measurement of KDB 662911 is using for calculating total power density. Total power density is summing entire spectra across corresponding frequency bins on the various outputs by computer.
 - Directional gain = $10 \log[(10^{G1/20} + 10^{G2/20})^2 / 2] = 8.84\text{dBi} > 6\text{dBi}$, so the power density limit shall be reduced to $17 - (8.84 - 6) = 14.16\text{dBm}$.
 - Refer to section 3.3 for duty cycle spectrum plot.

Spectrum Plot of Worst Value

802.11a / Chain 1 : CH36

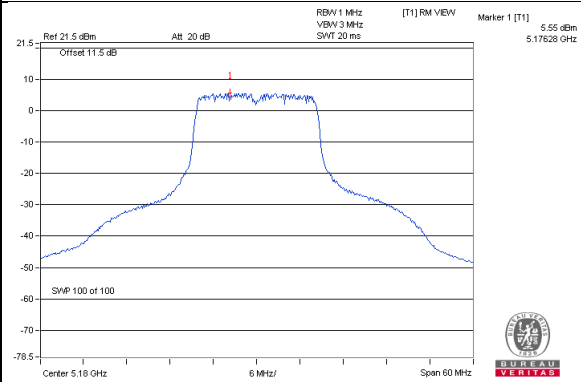

802.11ac (VHT20) / Chain 3 : CH48

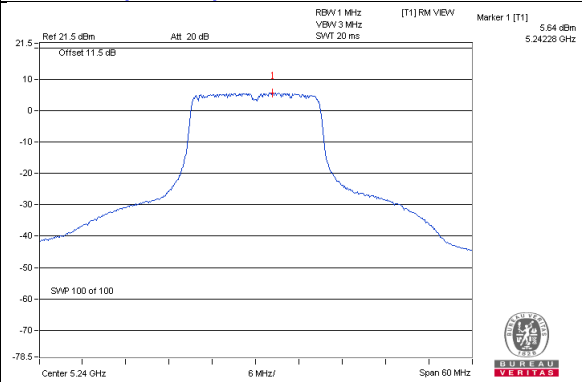

802.11ac (VHT40) / Chain 3: CH46

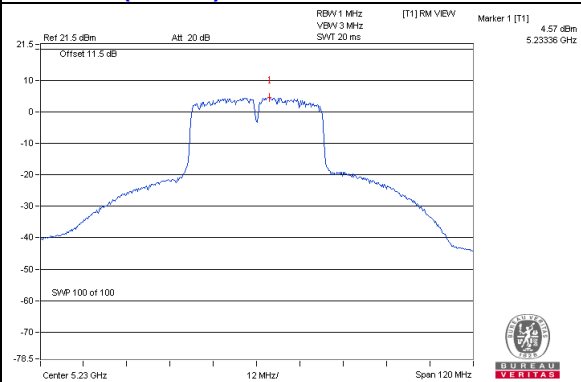

802.11ac (VHT80) / Chain 3 : CH42

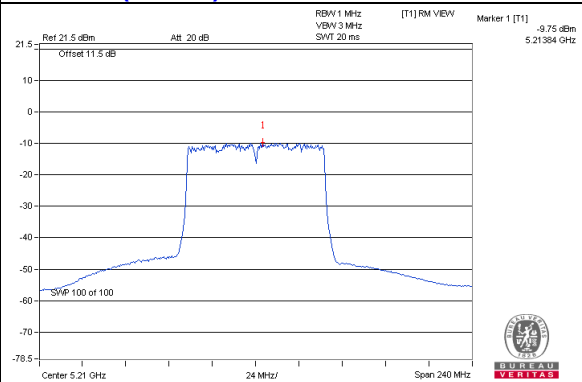

802.11ac (VHT80+80) / Chain 1: CH42

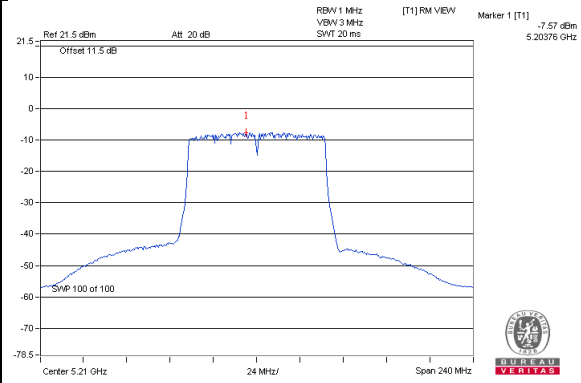

For U-NII-3:

802.11a

TX chain	Chan.	Chan. Freq. (MHz)	PSD W/O Duty Factor		10 log (N=4) dB	Duty Factor (dB)	Total PSD With Duty Factor (dBm/500kHz)	Limit (dBm/500kHz)	Pass /Fail
			(dBm/300kHz)	(dBm/500kHz)					
0	149	5745	0.07	2.29	6.02	0.13	8.44	24.33	Pass
	157	5785	-0.22	2.00	6.02	0.13	8.15	24.33	Pass
	165	5825	-0.33	1.89	6.02	0.13	8.04	24.33	Pass
1	149	5745	0.05	2.27	6.02	0.13	8.42	24.33	Pass
	157	5785	0.14	2.36	6.02	0.13	8.51	24.33	Pass
	165	5825	-0.22	2.00	6.02	0.13	8.15	24.33	Pass
2	149	5745	-0.78	1.44	6.02	0.13	7.59	24.33	Pass
	157	5785	-0.67	1.55	6.02	0.13	7.70	24.33	Pass
	165	5825	-0.18	2.04	6.02	0.13	8.19	24.33	Pass
3	149	5745	-0.33	1.89	6.02	0.13	8.04	24.33	Pass
	157	5785	-0.41	1.81	6.02	0.13	7.96	24.33	Pass
	165	5825	0.35	2.57	6.02	0.13	8.72	24.33	Pass

Note: 1. Directional gain = $10 \log[(10^{G1/20} + 10^{G2/20} + 10^{G2/20} + 10^{G2/20})^2 / 4] = 11.67\text{dBi} > 6\text{dBi}$, so the power density limit shall be reduced to $30 - (11.67 - 6) = 24.33\text{dBm}$.

2. Refer to section 3.3 for duty cycle spectrum plot.

802.11ac (VHT20)

TX chain	Channel	Freq. (MHz)	PSD (dBm/300kHz)	PSD (dBm/500kHz)	10 log (N=4) dB	Total PSD (dBm/500kHz)	Limit (dBm/500kHz)	Pass /Fail
0	149	5745	-0.43	1.79	6.02	7.81	24.33	Pass
	157	5785	-0.56	1.66	6.02	7.68	24.33	Pass
	165	5825	-0.78	1.44	6.02	7.46	24.33	Pass
1	149	5745	-0.19	2.03	6.02	8.05	24.33	Pass
	157	5785	-0.38	1.84	6.02	7.86	24.33	Pass
	165	5825	-0.14	2.08	6.02	8.10	24.33	Pass
2	149	5745	-0.93	1.29	6.02	7.31	24.33	Pass
	157	5785	-0.78	1.44	6.02	7.46	24.33	Pass
	165	5825	-0.72	1.50	6.02	7.52	24.33	Pass
3	149	5745	-0.03	2.19	6.02	8.21	24.33	Pass
	157	5785	-0.35	1.87	6.02	7.89	24.33	Pass
	165	5825	0.33	2.55	6.02	8.57	24.33	Pass

Note: 1. Directional gain = $10 \log[(10^{G1/20} + 10^{G2/20} + 10^{G2/20} + 10^{G2/20})^2 / 4] = 11.67\text{dBi} > 6\text{dBi}$, so the power density limit shall be reduced to $30 - (11.67 - 6) = 24.33\text{dBm}$.

802.11ac (VHT40)

TX chain	Chan.	Chan. Freq. (MHz)	PSD W/O Duty Factor		10 log (N=4) dB	Duty Factor (dB)	Total PSD With Duty Factor (dBm/500kHz)	Limit (dBm/500kHz)	Pass /Fail
			(dBm/300kHz)	(dBm/500kHz)					
0	151	5755	-4.00	-1.78	6.02	0.11	4.35	24.33	Pass
	159	5795	-3.79	-1.57	6.02	0.11	4.56	24.33	Pass
1	151	5755	-3.91	-1.69	6.02	0.11	4.44	24.33	Pass
	159	5795	-3.63	-1.41	6.02	0.11	4.72	24.33	Pass
2	151	5755	-4.70	-2.48	6.02	0.11	3.65	24.33	Pass
	159	5795	-4.08	-1.86	6.02	0.11	4.27	24.33	Pass
3	151	5755	-3.82	-1.60	6.02	0.11	4.53	24.33	Pass
	159	5795	-3.04	-0.82	6.02	0.11	5.31	24.33	Pass

- Note: 1. Directional gain = $10 \log[(10^{G1/20} + 10^{G2/20} + 10^{G2/20} + 10^{G2/20})^2 / 4] = 11.67\text{dBi} > 6\text{dBi}$, so the power density limit shall be reduced to $30-(11.67-6) = 24.33\text{dBm}$.
2. Refer to section 3.3 for duty cycle spectrum plot.

802.11ac (VHT80)

TX chain	Chan.	Chan. Freq. (MHz)	PSD W/O Duty Factor		10 log (N=4) dB	Duty Factor (dB)	Total PSD With Duty Factor (dBm/500kHz)	Limit (dBm/500kHz)	Pass /Fail
			(dBm/300kHz)	(dBm/500kHz)					
0	155	5775	-10.49	-8.27	6.02	0.24	-2.01	24.33	Pass
1	155	5775	-12.01	-9.79	6.02	0.24	-3.53	24.33	Pass
2	155	5775	-12.61	-10.39	6.02	0.24	-4.13	24.33	Pass
3	155	5775	-10.83	-8.61	6.02	0.24	-2.35	24.33	Pass

Note: 1. Directional gain = $10 \log[(10^{G1/20} + 10^{G2/20} + 10^{G2/20} + 10^{G2/20})^2 / 4] = 11.67\text{dBi} > 6\text{dBi}$, so the power density limit shall be reduced to $30 - (11.67 - 6) = 24.33\text{dBm}$.

2. Refer to section 3.3 for duty cycle spectrum plot.

802.11ac (VHT80+80)

TX chain	Chan.	Chan. Freq. (MHz)	PSD W/O Duty Factor		10 log (N=2) dB	Duty Factor (dB)	Total PSD With Duty Factor (dBm/500kHz)	Limit (dBm/500kHz)	Pass /Fail
			(dBm/300kHz)	(dBm/500kHz)					
0	42	5210	Test results refer to U_NII-1 data						
1	42	5210	Test results refer to U_NII-1 data						
2	155	5775	-16.47	-14.25	3.01	0.24	-11.00	27.52	Pass
3	155	5775	-14.52	-12.30	3.01	0.24	-9.05	27.52	Pass

Note: 1. Directional gain = $10 \log[(10^{G3/20} + 10^{G4/20})^2 / 2] = 8.84\text{dBi} > 6\text{dBi}$, so the power density limit shall be reduced to $30 - (8.84 - 6) = 27.52\text{dBm}$.

2. Refer to section 3.3 for duty cycle spectrum plot.

Spectrum Plot of Worst Value

802.11a / Chain 3 : CH165

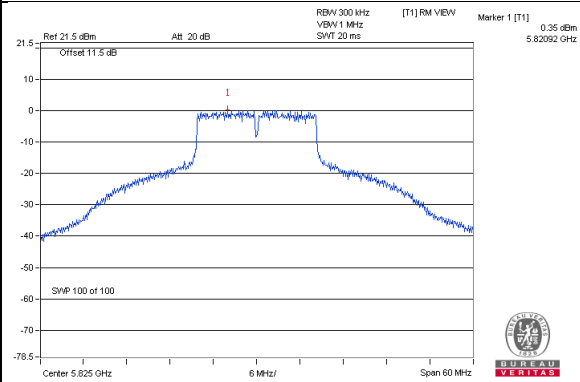

802.11a (VHT20) / Chain 3 : CH165

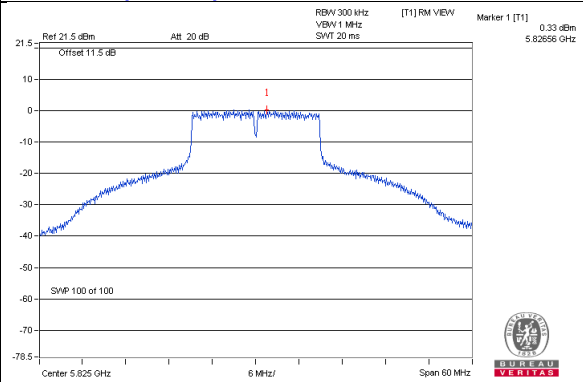

802.11ac (VHT40) / Chain 3: CH159

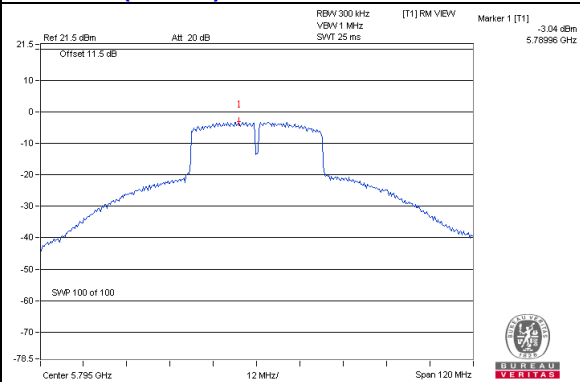

802.11ac (VHT80) / Chain 0 : CH155

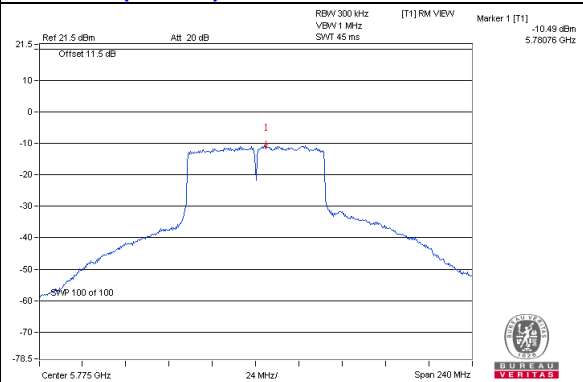

802.11ac (VHT80+80) / Chain 3: CH155

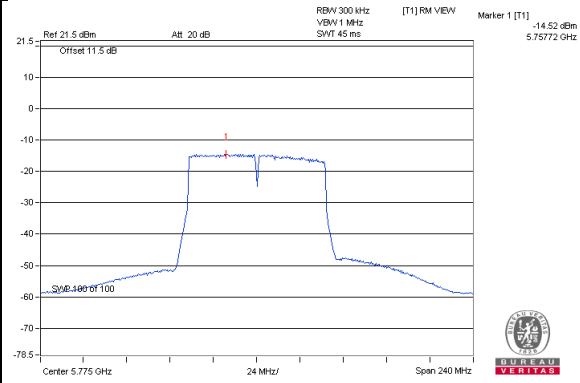

4.5.8 Test Results (Mode 2)

For U-NII-1:

802.11a

Chan.	Chan. Freq. (MHz)	PSD W/O Duty Factor (dBm/MHz)			Duty Factor (dB)	Total PSD With Duty Factor (dBm/MHz)	MAX. Limit (dBm/MHz)	Pass / Fail
		Chain 0	Chain 1	Chain 2				
36	5180	5.75	5.64	5.42	0.13	10.51	12.47	Pass
40	5200	6.64	6.23	6.64	0.13	11.41	12.47	Pass
48	5240	6.78	6.52	6.92	0.13	11.65	12.47	Pass

- Note:**
- Method a) of power density measurement of KDB 662911 is using for calculating total power density. Total power density is summing entire spectra across corresponding frequency bins on the various outputs by computer.
 - Directional gain = $10 \log[(10^{G1/20} + 10^{G2/20} + 10^{G3/20})^2 / 3] = 10.53\text{dBi} > 6\text{dBi}$, so the power density limit shall be reduced to $17 - (10.53 - 6) = 12.47\text{dBm}$.
 - Refer to section 3.3 for duty cycle spectrum plot.

802.11ac (VHT20)

Chan.	Chan. Freq. (MHz)	PSD (dBm/MHz)			Total Power Density (dBm/MHz)	MAX. Limit (dBm/MHz)	Pass / Fail
		Chain 0	Chain 1	Chain 2			
36	5180	6.10	5.92	6.12	10.82	12.47	Pass
40	5200	6.26	6.77	6.90	11.42	12.47	Pass
48	5240	6.59	6.22	7.00	11.39	12.47	Pass

- Note:**
- Method a) of power density measurement of KDB 662911 is using for calculating total power density. Total power density is summing entire spectra across corresponding frequency bins on the various outputs by computer.
 - Directional gain = $10 \log[(10^{G1/20} + 10^{G2/20} + 10^{G3/20})^2 / 3] = 10.53\text{dBi} > 6\text{dBi}$, so the power density limit shall be reduced to $17 - (10.53 - 6) = 12.47\text{dBm}$.

802.11ac (VHT40)

Chan.	Chan. Freq. (MHz)	PSD W/O Duty Factor (dBm/MHz)			Duty Factor (dB)	Total PSD With Duty Factor (dBm/MHz)	MAX. Limit (dBm/MHz)	Pass / Fail
		Chain 0	Chain 1	Chain 2				
38	5190	-2.30	-3.00	-2.39	0.11	2.33	12.47	Pass
46	5230	3.92	3.60	3.95	0.11	8.71	12.47	Pass

- Note:**
- Method a) of power density measurement of KDB 662911 is using for calculating total power density. Total power density is summing entire spectra across corresponding frequency bins on the various outputs by computer.
 - Directional gain = $10 \log[(10^{G1/20} + 10^{G2/20} + 10^{G3/20})^2 / 3] = 10.53\text{dBi} > 6\text{dBi}$, so the power density limit shall be reduced to $17 - (10.53 - 6) = 12.47\text{dBm}$.
 - Refer to section 3.3 for duty cycle spectrum plot.

802.11ac (VHT80)

Chan.	Chan. Freq. (MHz)	PSD W/O Duty Factor (dBm/MHz)			Duty Factor (dB)	Total PSD With Duty Factor (dBm/MHz)	MAX. Limit (dBm/MHz)	Pass / Fail
		Chain 0	Chain 1	Chain 2				
42	5210	-9.80	-9.47	-9.61	0.24	-4.62	12.47	Pass

- Note:**
- Method a) of power density measurement of KDB 662911 is using for calculating total power density. Total power density is summing entire spectra across corresponding frequency bins on the various outputs by computer.
 - Directional gain = $10 \log[(10^{G1/20} + 10^{G2/20} + 10^{G3/20})^2 / 3] = 10.53\text{dBi} > 6\text{dBi}$, so the power density limit shall be reduced to $17 - (10.53 - 6) = 12.47\text{dBm}$.
 - Refer to section 3.3 for duty cycle spectrum plot.

Spectrum Plot of Worst Value

802.11a_Chain 2 / CH48

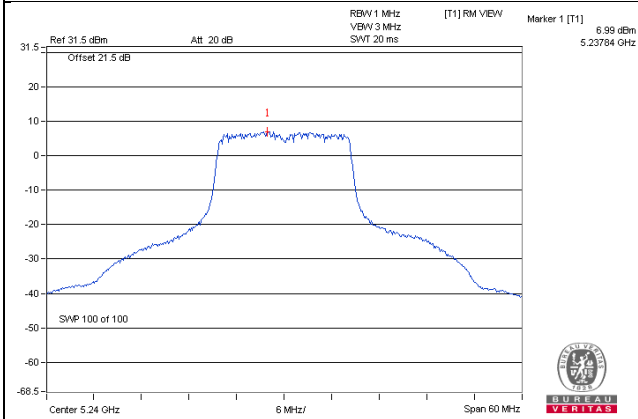

802.11ac (VHT20)_Chain 2 / CH48

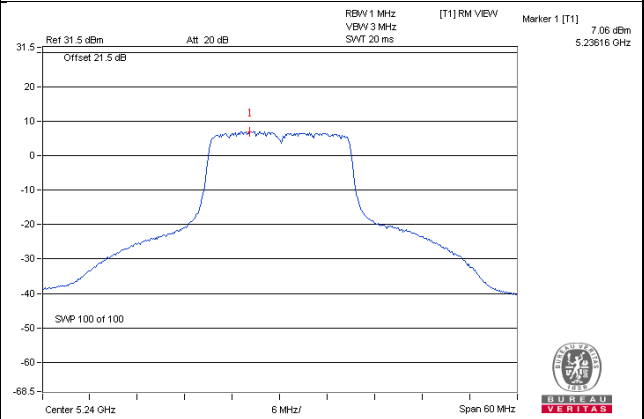

802.11ac (VHT40)_Chain 2 / CH46

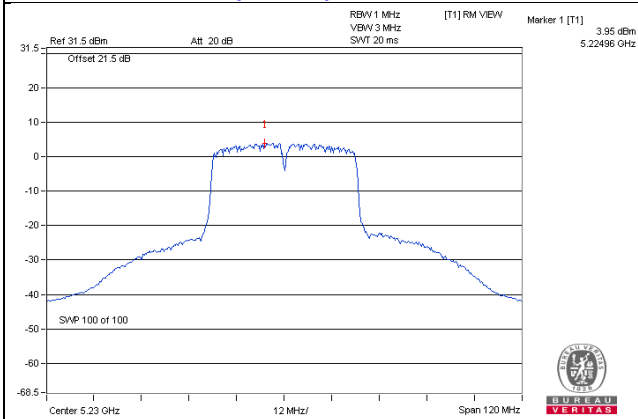

802.11ac (VHT80)_Chain 1 / CH42

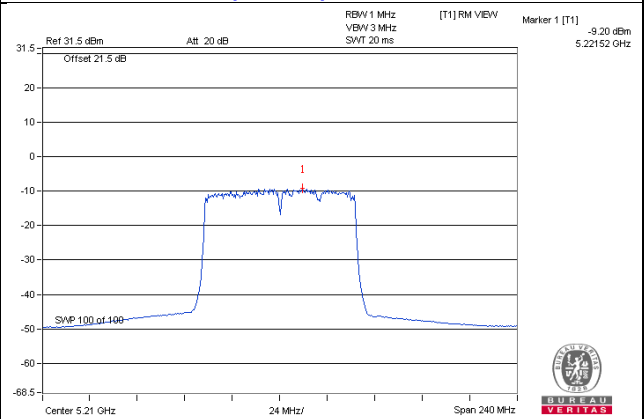

For U-NII-3:
802.11a

TX chain	Chan.	Chan. Freq. (MHz)	PSD W/O Duty Factor		10 log (N=3) dB	Duty Factor (dB)	Total PSD With Duty Factor (dBm/500kHz)	Limit (dBm/500kHz)	Pass /Fail
			(dBm/300kHz)	(dBm/500kHz)					
0	149	5745	0.36	2.58	4.77	0.13	7.48	25.47	Pass
	157	5785	0.54	2.76	4.77	0.13	7.66	25.47	Pass
	165	5825	0.30	2.52	4.77	0.13	7.42	25.47	Pass
1	149	5745	0.81	3.03	4.77	0.13	7.93	25.47	Pass
	157	5785	0.61	2.83	4.77	0.13	7.73	25.47	Pass
	165	5825	0.85	3.07	4.77	0.13	7.97	25.47	Pass
2	149	5745	0.85	3.07	4.77	0.13	7.97	25.47	Pass
	157	5785	0.74	2.96	4.77	0.13	7.86	25.47	Pass
	165	5825	1.08	3.30	4.77	0.13	8.20	25.47	Pass

Note: 1. Directional gain = $10 \log[(10^{G1/20} + 10^{G2/20} + 10^{G2/20})^2 / 3] = 10.53\text{dBi} > 6\text{dBi}$, so the power density limit shall be reduced to $30 - (10.53 - 6) = 25.47\text{dBm}$.

2. Refer to section 3.3 for duty cycle spectrum plot.

802.11ac (VHT20)

TX chain	Channel	Freq. (MHz)	PSD (dBm/300kHz)	PSD (dBm/500kHz)	10 log (N=3) dB	Total PSD (dBm/500kHz)	Limit (dBm/500kHz)	Pass /Fail
0	149	5745	0.52	2.74	4.77	7.51	25.47	Pass
	157	5785	0.10	2.32	4.77	7.09	25.47	Pass
	165	5825	-0.13	2.09	4.77	6.86	25.47	Pass
1	149	5745	0.10	2.32	4.77	7.09	25.47	Pass
	157	5785	0.24	2.46	4.77	7.23	25.47	Pass
	165	5825	0.34	2.56	4.77	7.33	25.47	Pass
2	149	5745	0.52	2.74	4.77	7.51	25.47	Pass
	157	5785	0.39	2.61	4.77	7.38	25.47	Pass
	165	5825	1.02	3.24	4.77	8.01	25.47	Pass

Note: 1. Directional gain = $10 \log[(10^{G1/20} + 10^{G2/20} + 10^{G2/20})^2 / 3] = 10.53\text{dBi} > 6\text{dBi}$, so the power density limit shall be reduced to $30 - (10.53 - 6) = 25.47\text{dBm}$.

2. Refer to section 3.3 for duty cycle spectrum plot.

802.11ac (VHT40)

TX chain	Chan.	Chan. Freq. (MHz)	PSD W/O Duty Factor		10 log (N=3) dB	Duty Factor (dB)	Total PSD With Duty Factor (dBm/500kHz)	Limit (dBm/500kHz)	Pass /Fail
			(dBm/300kHz)	(dBm/500kHz)					
0	151	5755	-2.95	-0.73	4.77	0.11	4.15	25.47	Pass
	159	5795	-3.32	-1.10	4.77	0.11	3.78	25.47	Pass
1	151	5755	-3.43	-1.21	4.77	0.11	3.67	25.47	Pass
	159	5795	-3.14	-0.92	4.77	0.11	3.96	25.47	Pass
2	151	5755	-3.17	-0.95	4.77	0.11	3.93	25.47	Pass
	159	5795	-2.53	-0.31	4.77	0.11	4.57	25.47	Pass

Note: 1. Directional gain = $10 \log[(10^{G1/20} + 10^{G2/20} + 10^{G2/20})^2 / 3] = 10.53\text{dBi} > 6\text{dBi}$, so the power density limit shall be reduced to $30-(10.53-6) = 25.47\text{dBm}$.

2. Refer to section 3.3 for duty cycle spectrum plot.

802.11ac (VHT80)

TX chain	Chan.	Chan. Freq. (MHz)	PSD W/O Duty Factor		10 log (N=3) dB	Duty Factor (dB)	Total PSD With Duty Factor (dBm/500kHz)	Limit (dBm/500kHz)	Pass /Fail
			(dBm/300kHz)	(dBm/500kHz)					
0	155	5775	-10.39	-8.17	4.77	0.24	-3.16	25.47	Pass
1	155	5775	-11.35	-9.13	4.77	0.24	-4.12	25.47	Pass
2	155	5775	-11.29	-9.07	4.77	0.24	-4.06	25.47	Pass

Note: 1. Directional gain = $10 \log[(10^{G1/20} + 10^{G2/20} + 10^{G2/20})^2 / 3] = 10.53\text{dBi} > 6\text{dBi}$, so the power density limit shall be reduced to $30-(10.53-6) = 25.47\text{dBm}$.

2. Refer to section 3.3 for duty cycle spectrum plot.

Spectrum Plot of Worst Value

802.11a – Chain 2: CH 165

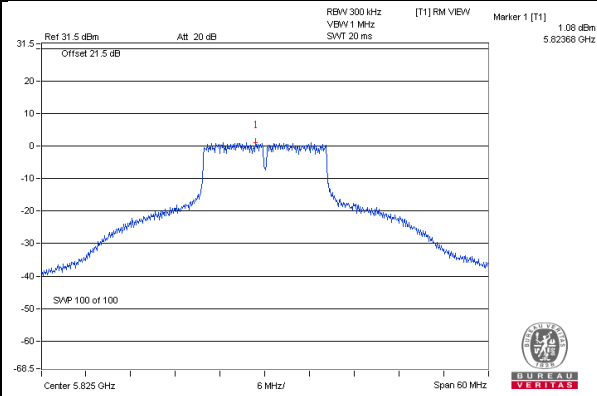

802.11ac (VHT20) – Chain 2: CH 165

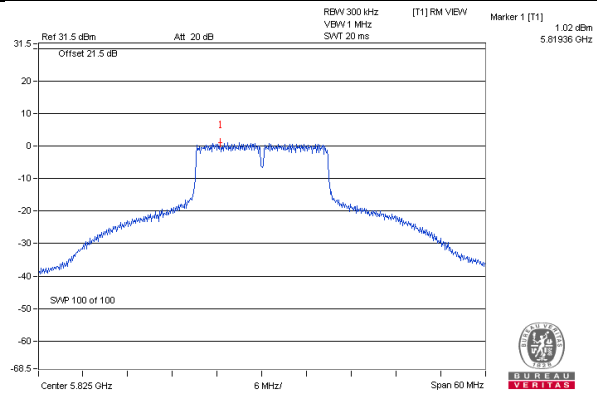

802.11ac (VHT40) – Chain 2: CH 159

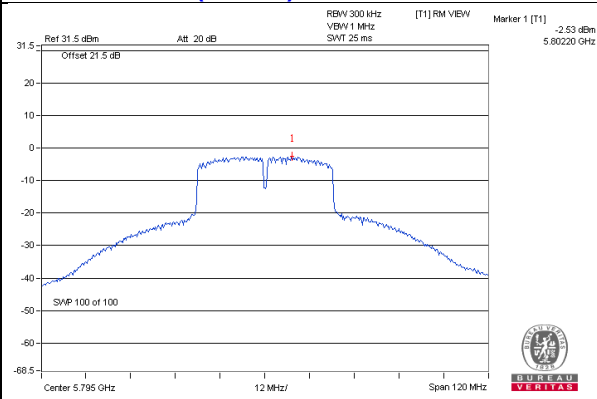

802.11ac (VHT80) – Chain 0: CH 155

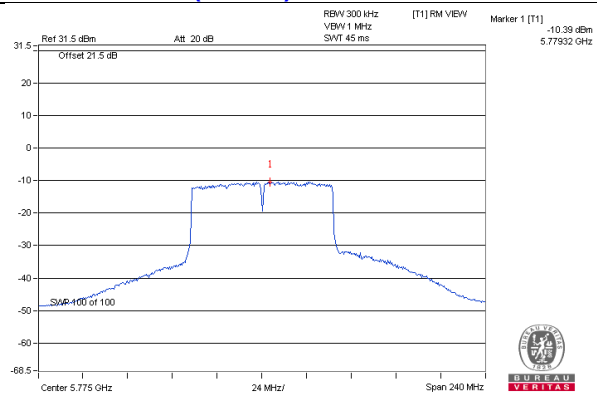

4.5.9 Test Results (Mode 3)

For U-NII-1:

802.11a

Chan.	Chan. Freq. (MHz)	PSD W/O Duty Factor (dBm)		Duty Factor (dB)	Total PSD With Duty Factor (dBm)	MAX. Limit (dBm)	Pass / Fail
		Chain 0	Chain 1				
36	5180	6.21	5.76	0.13	9.13	14.16	Pass
40	5200	9.66	9.03	0.13	12.50	14.16	Pass
48	5240	9.00	8.80	0.13	12.04	14.16	Pass

- Note:**
- Method a) of power density measurement of KDB 662911 is using for calculating total power density. Total power density is summing entire spectra across corresponding frequency bins on the various outputs by computer.
 - Directional gain = $10 \log[(10^{G1/20} + 10^{G2/20})^2 / 2] = 8.84\text{dBi} > 6\text{dBi}$, so the power density limit shall be reduced to $17-(8.84-6) = 14.16\text{dBm}$.
 - Refer to section 3.3 for duty cycle spectrum plot.

802.11ac (VHT20)

Chan.	Chan. Freq. (MHz)	PSD (dBm/MHz)		Total Power Density (dBm/MHz)	MAX. Limit (dBm/MHz)	Pass / Fail
		Chain 0	Chain 1			
36	5180	6.57	6.69	9.64	14.16	Pass
40	5200	8.47	8.43	11.46	14.16	Pass
48	5240	8.09	7.43	10.78	14.16	Pass

- Note:**
- Method a) of power density measurement of KDB 662911 is using for calculating total power density. Total power density is summing entire spectra across corresponding frequency bins on the various outputs by computer.
 - Directional gain = $10 \log[(10^{G1/20} + 10^{G2/20})^2 / 2] = 8.84\text{dBi} > 6\text{dBi}$, so the power density limit shall be reduced to $17-(8.84-6) = 14.16\text{dBm}$.

802.11ac (VHT40)

Chan.	Chan. Freq. (MHz)	PSD W/O Duty Factor (dBm)		Duty Factor (dB)	Total PSD With Duty Factor (dBm)	MAX. Limit (dBm)	Pass / Fail
		Chain 0	Chain 1				
38	5190	-1.38	-1.59	0.11	1.64	14.16	Pass
46	5230	4.38	4.55	0.11	7.59	14.16	Pass

- Note:**
- Method a) of power density measurement of KDB 662911 is using for calculating total power density. Total power density is summing entire spectra across corresponding frequency bins on the various outputs by computer.
 - Directional gain = $10 \log[(10^{G1/20} + 10^{G2/20})^2 / 2] = 8.84\text{dBi} > 6\text{dBi}$, so the power density limit shall be reduced to $17-(8.84-6) = 14.16\text{dBm}$.
 - Refer to section 3.3 for duty cycle spectrum plot.

802.11ac (VHT80)

Chan.	Chan. Freq. (MHz)	PSD W/O Duty Factor (dBm)		Duty Factor (dB)	Total PSD With Duty Factor (dBm)	MAX. Limit (dBm)	Pass / Fail
		Chain 0	Chain 1				
42	5210	-6.77	-6.59	0.24	-3.43	14.16	Pass

- Note:**
- Method a) of power density measurement of KDB 662911 is using for calculating total power density. Total power density is summing entire spectra across corresponding frequency bins on the various outputs by computer.
 - Directional gain = $10 \log[(10^{G1/20} + 10^{G2/20})^2 / 2] = 8.84\text{dBi} > 6\text{dBi}$, so the power density limit shall be reduced to $17-(8.84-6) = 14.16\text{dBm}$.
 - Refer to section 3.3 for duty cycle spectrum plot.

802.11ac (VHT80+80)

Chan.	Chan. Freq. (MHz)	PSD W/O Duty Factor (dBm)		Duty Factor (dB)	Total PSD With Duty Factor (dBm)	MAX. Limit (dBm)	Pass / Fail
		Chain 0	Chain 1				
42+155	5210	-6.43	-	0.24	-6.19	17.00	Pass
	5775	Test results refer to U_NII-3 data					

- Note:**
- Refer to section 3.3 for duty cycle spectrum plot.

Spectrum Plot of Worst Value

802.11a_Chain 0 / CH40

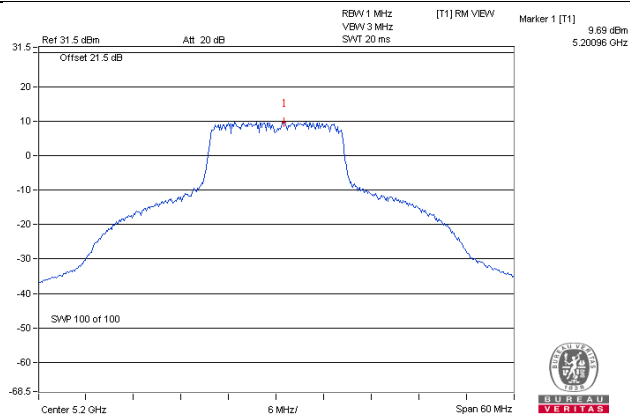

802.11ac (VHT20)_Chain 0 / CH40

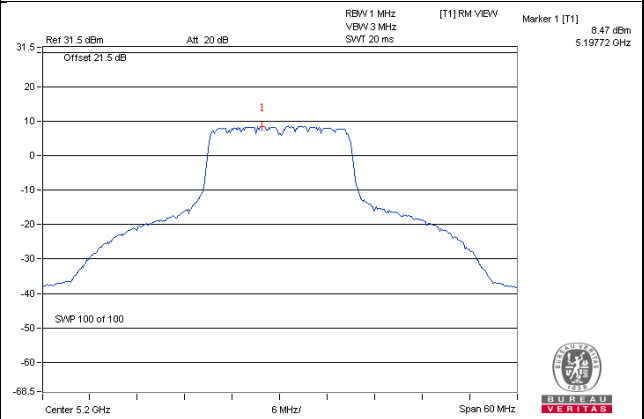

802.11ac (VHT40)_Chain 1 / CH46

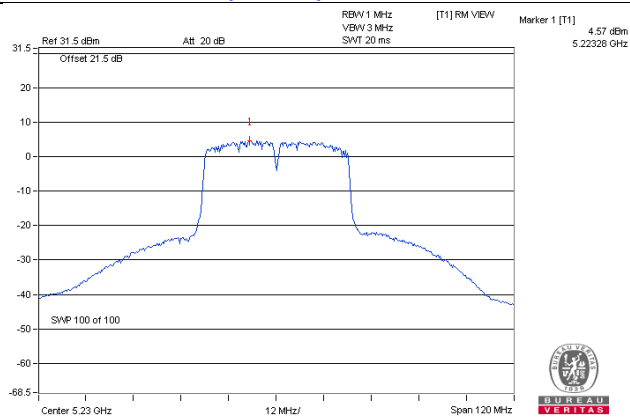

802.11ac (VHT80)_Chain 1 / CH42

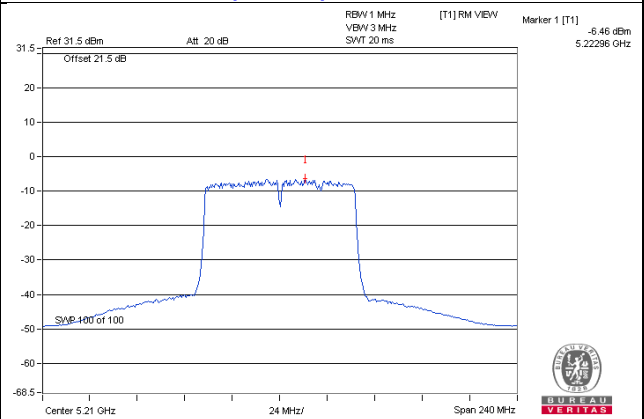

802.11ac (VHT80+80)_Chain 0 / CH42

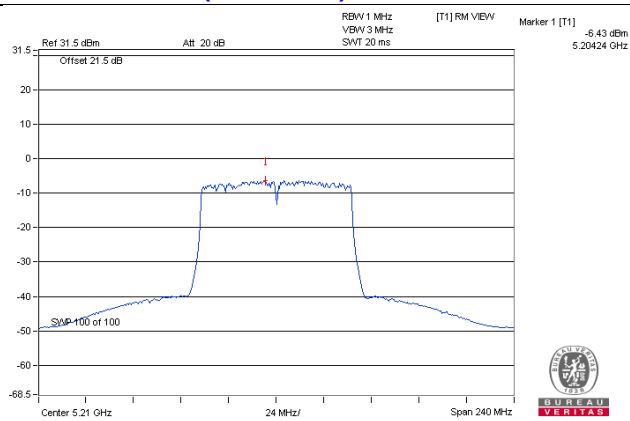

For U-NII-3:
802.11a

TX chain	Chan.	Chan. Freq. (MHz)	PSD W/O Duty Factor		10 log (N=2) dB	Duty Factor (dB)	Total PSD With Duty Factor (dBm/500kHz)	Limit (dBm/500kHz)	Pass /Fail
			(dBm/300kHz)	(dBm/500kHz)					
0	149	5745	0.50	2.72	3.01	0.13	5.86	27.16	Pass
	157	5785	0.56	2.78	3.01	0.13	5.92	27.16	Pass
	165	5825	0.86	3.08	3.01	0.13	6.22	27.16	Pass
1	149	5745	0.48	2.70	3.01	0.13	5.84	27.16	Pass
	157	5785	0.85	3.07	3.01	0.13	6.21	27.16	Pass
	165	5825	0.61	2.83	3.01	0.13	5.97	27.16	Pass

Note: 1. Directional gain = $10 \log[(10^{G1/20} + 10^{G2/20})^2 / 2] = 8.84\text{dBi} > 6\text{dBi}$, so the power density limit shall be reduced to $30-(8.84-6) = 27.16\text{dBm}$.

2. Refer to section 3.3 for duty cycle spectrum plot.

802.11ac (VHT20)

TX chain	Channel	Freq. (MHz)	PSD (dBm/300kHz)	PSD (dBm/500kHz)	10 log (N=2) dB	Total PSD (dBm/500kHz)	Limit (dBm/500kHz)	Pass /Fail
0	149	5745	0.62	2.84	3.01	5.85	27.16	Pass
	157	5785	0.32	2.54	3.01	5.55	27.16	Pass
	165	5825	-0.07	2.15	3.01	5.16	27.16	Pass
1	149	5745	0.24	2.46	3.01	5.47	27.16	Pass
	157	5785	0.84	3.06	3.01	6.07	27.16	Pass
	165	5825	0.31	2.53	3.01	5.54	27.16	Pass

Note: 1. Directional gain = $10 \log[(10^{G1/20} + 10^{G2/20})^2 / 2] = 8.84\text{dBi} > 6\text{dBi}$, so the power density limit shall be reduced to $30-(8.84-6) = 27.16\text{dBm}$.

802.11ac (VHT40)

TX chain	Chan.	Chan. Freq. (MHz)	PSD W/O Duty Factor		10 log (N=2) dB	Duty Factor (dB)	Total PSD With Duty Factor (dBm/500kHz)	Limit (dBm/500kHz)	Pass /Fail
			(dBm/300kHz)	(dBm/500kHz)					
0	151	5755	-3.61	-1.39	3.01	0.11	1.73	27.16	Pass
	159	5795	-2.73	-0.51	3.01	0.11	2.61	27.16	Pass
1	151	5755	-2.84	-0.62	3.01	0.11	2.50	27.16	Pass
	159	5795	-2.42	-0.20	3.01	0.11	2.92	27.16	Pass

Note: 1. Directional gain = $10 \log[(10^{G1/20} + 10^{G2/20})^2 / 2] = 8.84\text{dBi} > 6\text{dBi}$, so the power density limit shall be reduced to $30 - (8.84 - 6) = 27.16\text{dBm}$.

2. Refer to section 3.3 for duty cycle spectrum plot.

802.11ac (VHT80)

TX chain	Chan.	Chan. Freq. (MHz)	PSD W/O Duty Factor		10 log (N=2) dB	Duty Factor (dB)	Total PSD With Duty Factor (dBm/500kHz)	Limit (dBm/500kHz)	Pass /Fail
			(dBm/300kHz)	(dBm/500kHz)					
0	155	5775	-10.35	-8.13	3.01	0.24	-4.88	27.16	Pass
1	155	5775	-11.46	-9.24	3.01	0.24	-5.99	27.16	Pass

Note: 1. Directional gain = $10 \log[(10^{G1/20} + 10^{G2/20})^2 / 2] = 8.84\text{dBi} > 6\text{dBi}$, so the power density limit shall be reduced to $30 - (8.84 - 6) = 27.16\text{dBm}$.

2. Refer to section 3.3 for duty cycle spectrum plot.

802.11ac (VHT80+80)

TX chain	Chan.	Chan. Freq. (MHz)	PSD W/O Duty Factor		Duty Factor (dB)	Total PSD With Duty Factor (dBm/500kHz)	Limit (dBm/500kHz)	Pass /Fail
			(dBm/300kHz)	(dBm/500kHz)				
0	42	5210	Test results refer to U_NII-1 data					
2	155	5775	-15.40	-13.18	0.24	-12.94	30.00	Pass

Note: 1. Refer to section 3.3 for duty cycle spectrum plot.

Spectrum Plot of Worst Value

802.11a – Chain 0: CH 165

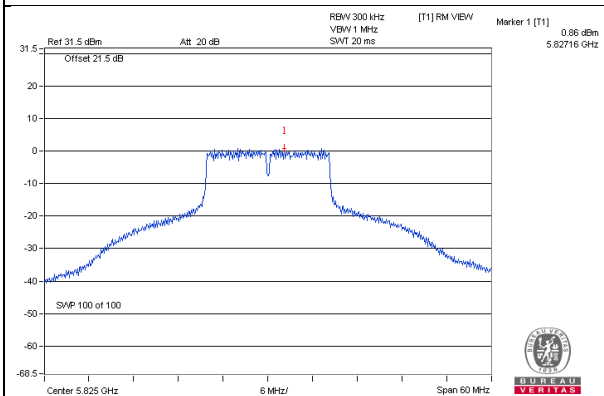

802.11ac (VHT20) – Chain 1: CH 157

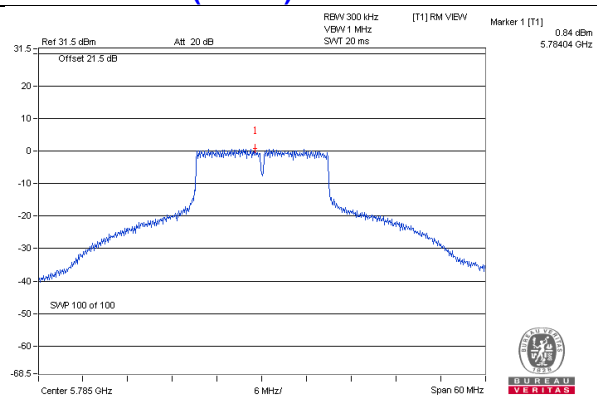

802.11ac (VHT40) – Chain 1: CH 159

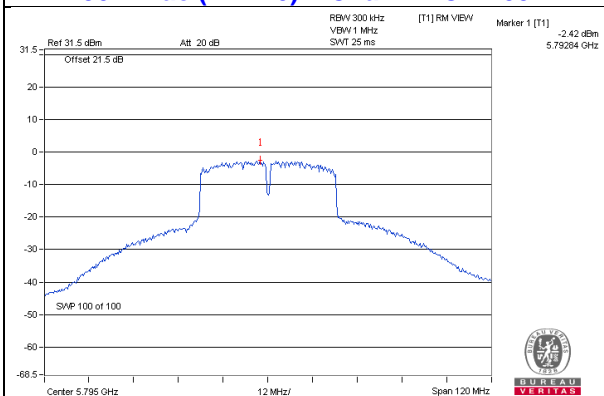

802.11ac (VHT80) – Chain 0: CH 155

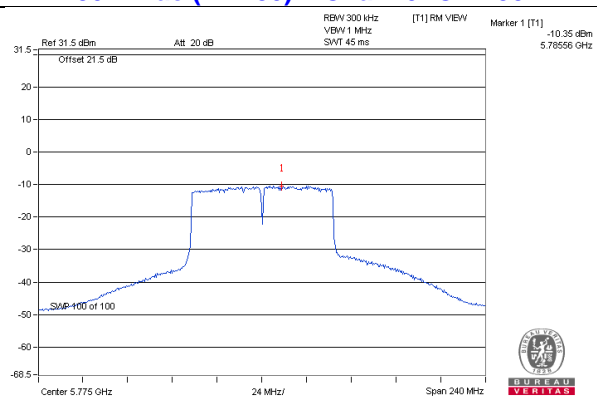

802.11ac (VHT80+80) – Chain 2: CH 155

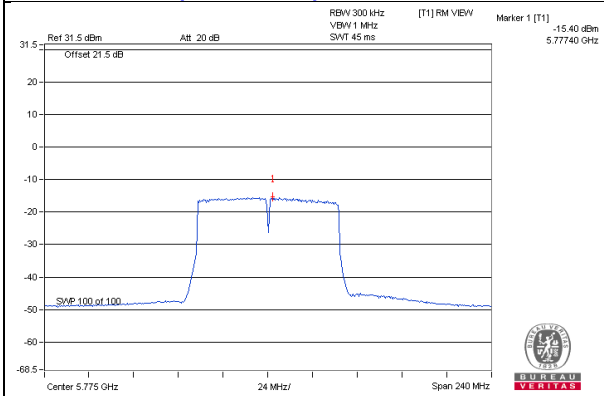

4.5.10 Test Results (Mode 4)

For U-NII-1:

802.11a

Chan.	Chan. Freq. (MHz)	PSD W/O Duty Factor (dBm/MHz)	Duty Factor (dB)	PSD With Duty Factor (dBm/MHz)	MAX. Limit (dBm/MHz)	Pass / Fail
36	5180	7.91	0.13	8.04	17.00	Pass
40	5200	9.75	0.13	9.88	17.00	Pass
48	5240	9.11	0.13	9.24	17.00	Pass

Note: 1. Refer to section 3.3 for duty cycle spectrum plot.

802.11ac (VHT20)

Chan.	Chan. Freq. (MHz)	PSD (dBm/MHz)	MAX. Limit (dBm/MHz)	Pass / Fail
36	5180	7.59	17.00	Pass
40	5200	8.44	17.00	Pass
48	5240	8.68	17.00	Pass

802.11ac (VHT40)

Chan.	Chan. Freq. (MHz)	PSD W/O Duty Factor (dBm/MHz)	Duty Factor (dB)	PSD With Duty Factor (dBm/MHz)	MAX. Limit (dBm/MHz)	Pass / Fail
38	5190	-0.54	0.11	-0.43	17.00	Pass
46	5230	4.47	0.11	4.58	17.00	Pass

Note: 1. Refer to section 3.3 for duty cycle spectrum plot.

802.11ac (VHT80)

Chan.	Chan. Freq. (MHz)	PSD W/O Duty Factor (dBm/MHz)	Duty Factor (dB)	PSD With Duty Factor (dBm/MHz)	MAX. Limit (dBm/MHz)	Pass / Fail
42	5210	-6.01	0.24	-5.77	17.00	Pass

Note: 1. Refer to section 3.3 for duty cycle spectrum plot.

Spectrum Plot of Worst Value

802.11a / CH40

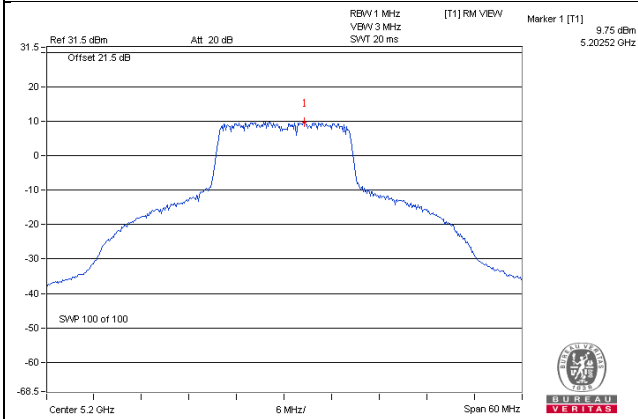

802.11ac (VHT20) / CH48

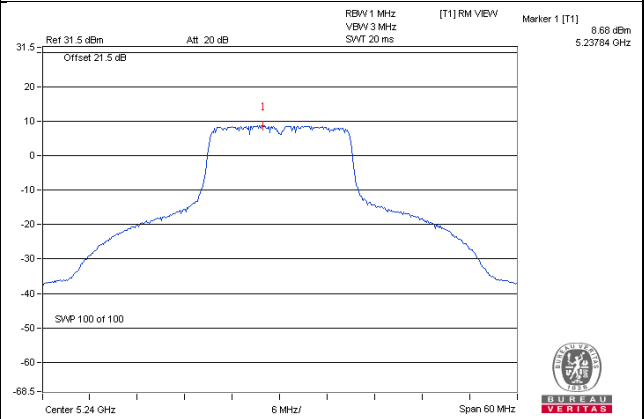

802.11ac (VHT40) / CH46

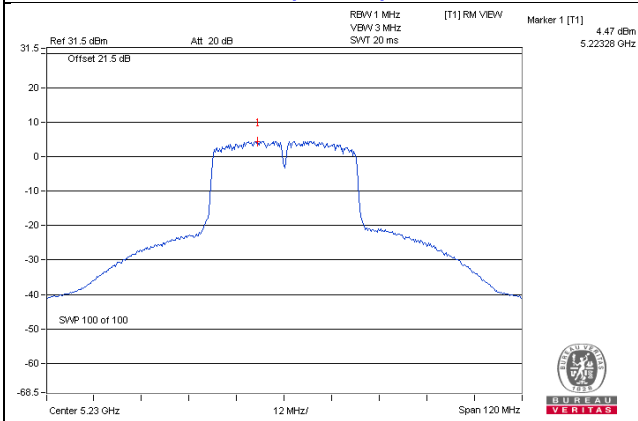

802.11ac (VHT80) / CH42

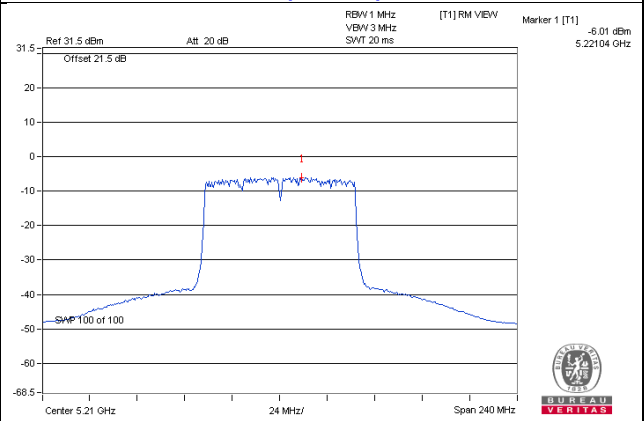

For U-NII-3:
802.11a

Chan.	Chan. Freq. (MHz)	PSD W/O Duty Factor		Duty Factor (dB)	Total PSD With Duty Factor (dBm/500kHz)	Limit (dBm/500kHz)	Pass /Fail
		(dBm/300kHz)	(dBm/500kHz)				
149	5745	0.99	3.21	0.13	3.34	30.00	Pass
157	5785	0.44	2.66	0.13	2.79	30.00	Pass
165	5825	0.74	2.96	0.13	3.09	30.00	Pass

Note: 1. Refer to section 3.3 for duty cycle spectrum plot.

802.11ac (VHT20)

Chan.	Chan. Freq. (MHz)	PSD (dBm/300kHz)	PSD (dBm/500kHz)	Limit (dBm/500kHz)	Pass /Fail
149	5745	0.41	2.63	30.00	Pass
157	5785	0.02	2.24	30.00	Pass
165	5825	0.35	2.57	30.00	Pass

802.11ac (VHT40)

Chan.	Chan. Freq. (MHz)	PSD W/O Duty Factor		Duty Factor (dB)	Total PSD With Duty Factor (dBm/500kHz)	Limit (dBm/500kHz)	Pass /Fail
		(dBm/300kHz)	(dBm/500kHz)				
151	5755	-4.01	-1.79	0.11	-1.68	30.00	Pass
159	5795	-3.42	-1.20	0.11	-1.09	30.00	Pass

Note: 1. Refer to section 3.3 for duty cycle spectrum plot.

802.11ac (VHT80)

Chan.	Chan. Freq. (MHz)	PSD W/O Duty Factor		Duty Factor (dB)	Total PSD With Duty Factor (dBm/500kHz)	Limit (dBm/500kHz)	Pass /Fail
		(dBm/300kHz)	(dBm/500kHz)				
155	5775	-9.58	-7.36	0.24	-7.12	30.00	Pass

Note: 1. Refer to section 3.3 for duty cycle spectrum plot.

Spectrum Plot of Worst Value

802.11a: CH 149

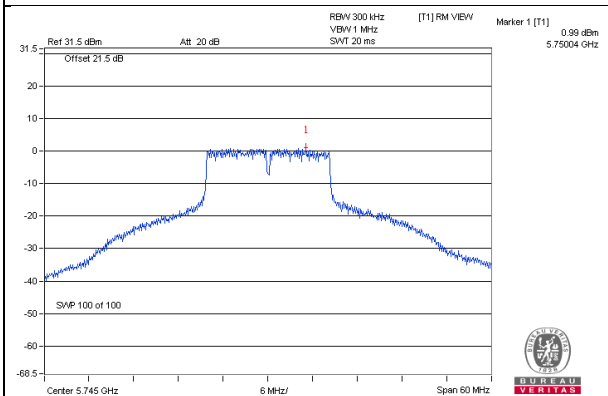

802.11a (VHT20): CH 149

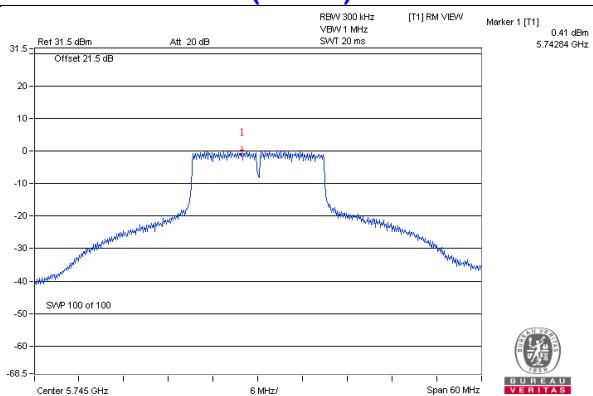

802.11ac (VHT40): CH 159

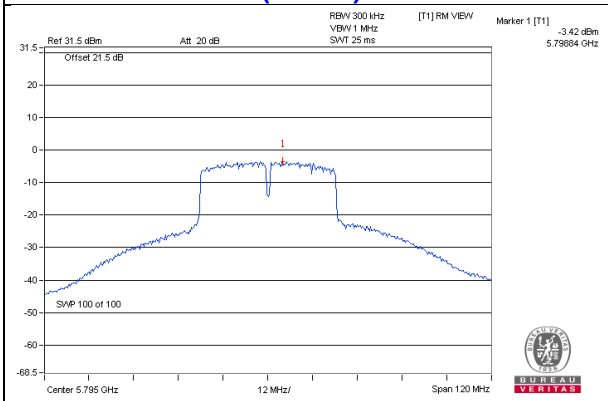

802.11ac (VHT80): CH 155

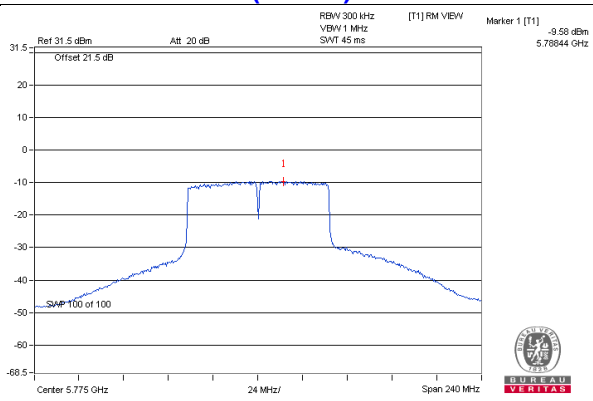

4.6 Frequency Stability Measurement

4.6.1 Limits of Frequency Stability Measurement

The frequency of the carrier signal shall be maintained within band of operation

4.6.2 Test Setup

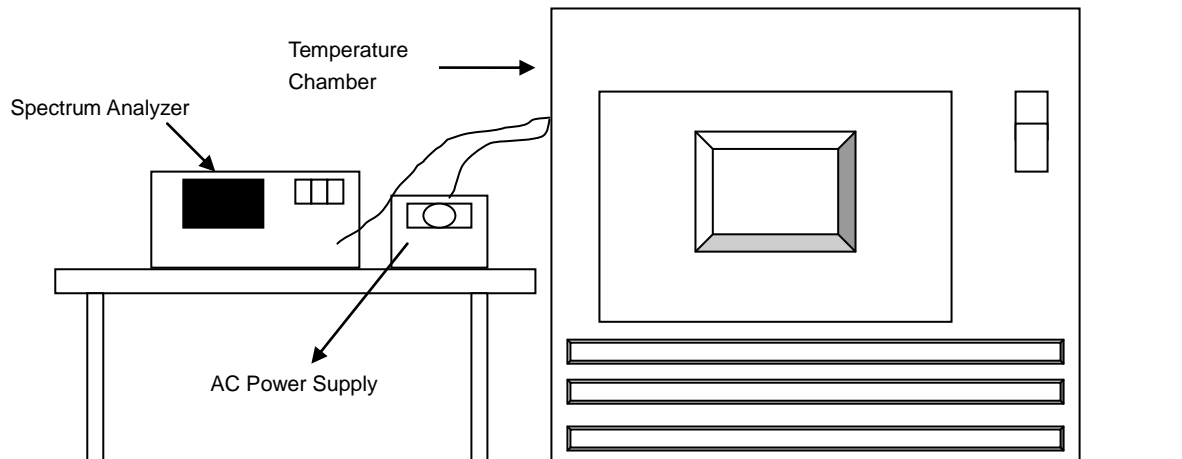

4.6.3 Test Instruments

Refer to section 4.1.2 to get information of above instrument.

4.6.4 Test Procedure

- The EUT was placed inside the environmental test chamber and powered by nominal AC voltage.
- Turn the EUT on and couple its output to a spectrum analyzer.
- Turn the EUT off and set the chamber to the highest temperature specified.
- Allow sufficient time (approximately 30 min) for the temperature of the chamber to stabilize, turn the EUT on and measure the operating frequency after 2, 5, and 10 Minutes.
- Repeat step 2 and 3 with the temperature chamber set to the lowest temperature.
- The test chamber was allowed to stabilize at +20 degree C for a minimum of 30 Minutes. The supply voltage was then adjusted on the EUT from 85% to 115% and the frequency record.

4.6.5 Deviation from Test Standard

No deviation.

4.6.6 EUT Operating Condition

Set the EUT transmit at un-modulation mode to test frequency stability.

4.6.7 Test Results (Mode 1)

Frequency Stability Versus Temp.									
Operating Frequency: 5180 MHz									
TEMP. (°C)	Power Supply (Vac)	0 Minute		2 Minute		5 Minute		10 Minute	
		Measured Frequency (MHz)	Pass/Fail	Measured Frequency (MHz)	Pass/Fail	Measured Frequency (MHz)	Pass/Fail	Measured Frequency (MHz)	Pass/Fail
50	120	5179.9847	PASS	5179.9849	PASS	5179.9803	PASS	5179.984	PASS
40	120	5180.0037	PASS	5180.0022	PASS	5180.0023	PASS	5179.9992	PASS
30	120	5180.0115	PASS	5180.014	PASS	5180.0097	PASS	5180.0137	PASS
20	120	5179.9845	PASS	5179.9851	PASS	5179.9851	PASS	5179.9823	PASS
10	120	5179.9775	PASS	5179.977	PASS	5179.9772	PASS	5179.9786	PASS
0	120	5180.0065	PASS	5180.0101	PASS	5180.0074	PASS	5180.0065	PASS
-10	120	5179.983	PASS	5179.9852	PASS	5179.984	PASS	5179.9822	PASS
-20	120	5180.0059	PASS	5180.0044	PASS	5180.009	PASS	5180.008	PASS
-30	120	5180.0076	PASS	5180.009	PASS	5180.0086	PASS	5180.0123	PASS

Frequency Stability Versus Voltage									
Operating Frequency: 5180 MHz									
TEMP. (°C)	Power Supply (Vac)	0 Minute		2 Minute		5 Minute		10 Minute	
		Measured Frequency (MHz)	Pass/Fail	Measured Frequency (MHz)	Pass/Fail	Measured Frequency (MHz)	Pass/Fail	Measured Frequency (MHz)	Pass/Fail
20	138	5179.9842	PASS	5179.9842	PASS	5179.9861	PASS	5179.9813	PASS
	120	5179.9845	PASS	5179.9851	PASS	5179.9851	PASS	5179.9823	PASS
	102	5179.9846	PASS	5179.9859	PASS	5179.9843	PASS	5179.9819	PASS

4.7 6dB Bandwidth Measurement

4.7.1 Limits of 6dB Bandwidth Measurement

The minimum of 6dB Bandwidth Measurement is 0.5MHz.

4.7.2 Test Setup

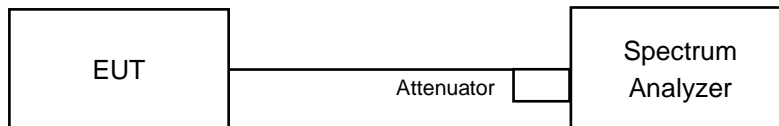

4.7.3 Test Instruments

Refer to section 4.1.2 to get information of above instrument.

4.7.4 Test Procedure

MEASUREMENT PROCEDURE REF

- a. Set resolution bandwidth (RBW) = 100kHz
- b. Set the video bandwidth (VBW) $\geq 3 \times$ RBW, Detector = Peak.
- c. Trace mode = max hold.
- d. Sweep = auto couple.
- e. Measure the maximum width of the emission that is constrained by the frequencies associated with the two amplitude points (upper and lower) that are attenuated by 6 dB relative to the maximum level measured in the fundamental emission

4.7.5 Deviation from Test Standard

No deviation.

4.7.6 EUT Operating Condition

The software provided by client to enable the EUT under transmission condition continuously at lowest, middle and highest channel frequencies individually.

4.7.7 Test Results (Mode 1)

802.11a

Channel	Frequency (MHz)	6dB Bandwidth (MHz)				Minimum Limit (MHz)	Pass / Fail
		Chain 0	Chain 1	Chain 2	Chain 3		
149	5745	16.38	16.41	16.37	16.38	0.5	PASS
157	5785	16.39	16.38	16.38	16.38	0.5	PASS
165	5825	16.41	16.39	16.39	16.38	0.5	PASS

802.11ac (VHT20)

Channel	Frequency (MHz)	6dB Bandwidth (MHz)				Minimum Limit (MHz)	Pass / Fail
		Chain 0	Chain 1	Chain 2	Chain 3		
149	5745	17.60	17.36	17.65	17.61	0.5	PASS
157	5785	17.58	17.62	17.62	17.62	0.5	PASS
165	5825	17.66	17.62	17.62	17.61	0.5	PASS

802.11ac (VHT40)

Channel	Frequency (MHz)	6dB Bandwidth (MHz)				Minimum Limit (MHz)	Pass / Fail
		Chain 0	Chain 1	Chain 2	Chain 3		
151	5755	35.19	35.18	35.15	35.16	0.5	PASS
159	5795	35.16	35.16	35.16	33.94	0.5	PASS

802.11ac (VHT80)

Channel	Frequency (MHz)	6dB Bandwidth (MHz)				Minimum Limit (MHz)	Pass / Fail
		Chain 0	Chain 1	Chain 2	Chain 3		
155	5775	75.54	75.96	75.52	75.52	0.5	PASS

802.11ac (VHT80+80)

Channel	Frequency (MHz)	6dB Bandwidth (MHz)				Minimum Limit (MHz)	Pass / Fail
		Chain 0	Chain 1	Chain 2	Chain 3		
42+155	5210	-					
	5775	-	-	75.90	75.80	0.5	PASS

Spectrum Plot of Worst Value

802.11a_Chain 2 / CH149

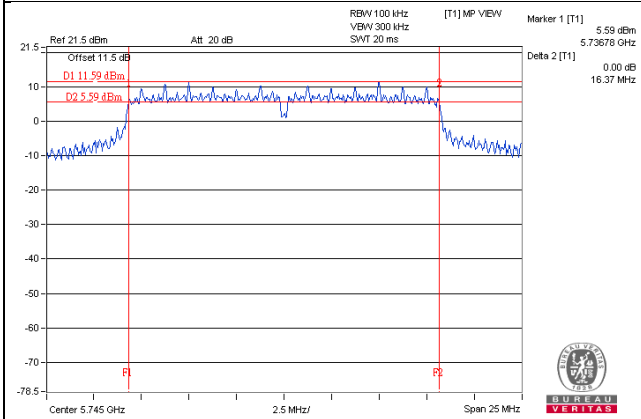

802.11ac (VHT20)_Chain 1 / CH149

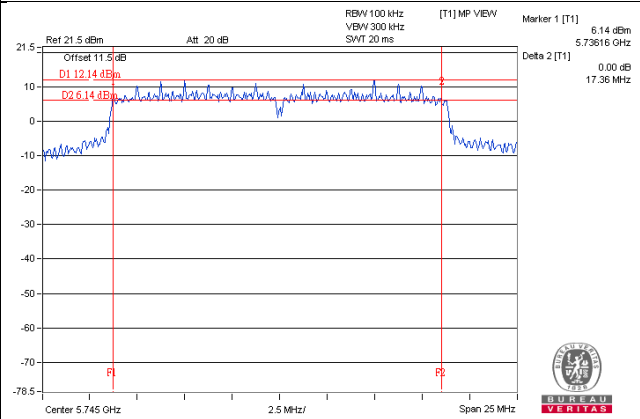

802.11ac (VHT40)_Chain 3 / CH159

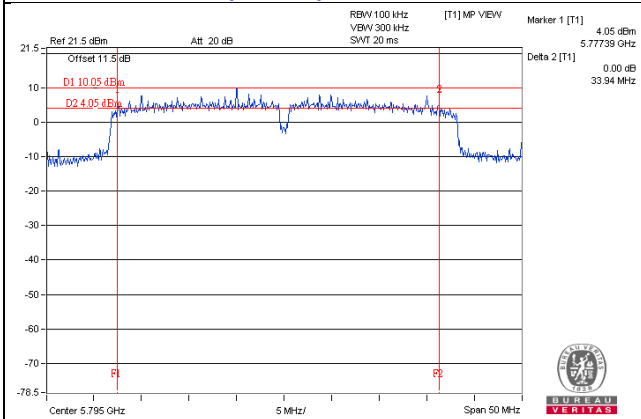

802.11ac (VHT80)_Chain 2 / CH155

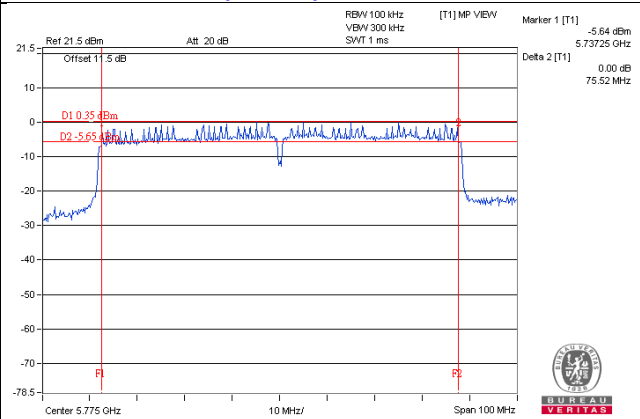

802.11ac (VHT80+80)_Chain 3 / CH155

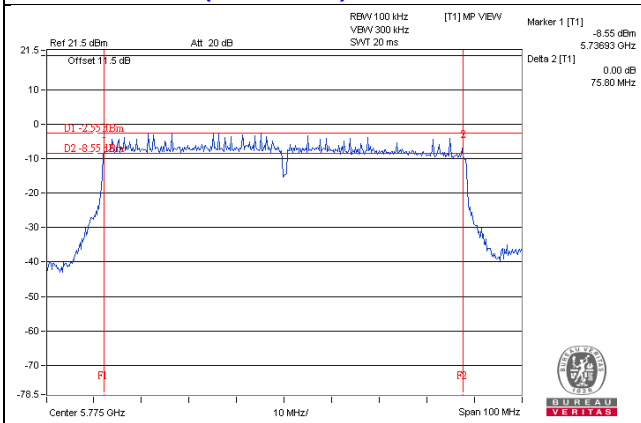

4.7.8 Test Results (Mode 2)

802.11a

Channel	Frequency (MHz)	6dB Bandwidth (MHz)			Minimum Limit (MHz)	Pass / Fail
		Chain 0	Chain 1	Chain 2		
149	5745	16.39	16.38	16.37	0.5	PASS
157	5785	16.39	16.37	16.35	0.5	PASS
165	5825	16.35	16.36	16.36	0.5	PASS

802.11ac (VHT20)

Channel	Frequency (MHz)	6dB Bandwidth (MHz)			Minimum Limit (MHz)	Pass / Fail
		Chain 0	Chain 1	Chain 2		
149	5745	17.58	17.59	17.62	0.5	PASS
157	5785	17.19	17.61	17.62	0.5	PASS
165	5825	17.58	17.64	17.59	0.5	PASS

802.11ac (VHT40)

Channel	Frequency (MHz)	6dB Bandwidth (MHz)			Minimum Limit (MHz)	Pass / Fail
		Chain 0	Chain 1	Chain 2		
151	5755	35.21	35.43	35.84	0.5	PASS
159	5795	32.65	35.09	35.12	0.5	PASS

802.11ac (VHT80)

Channel	Frequency (MHz)	6dB Bandwidth (MHz)			Minimum Limit (MHz)	Pass / Fail
		Chain 0	Chain 1	Chain 2		
155	5775	75.53	75.87	74.37	0.5	PASS

Spectrum Plot of Worst Value

802.11a_Chain 2 / CH157

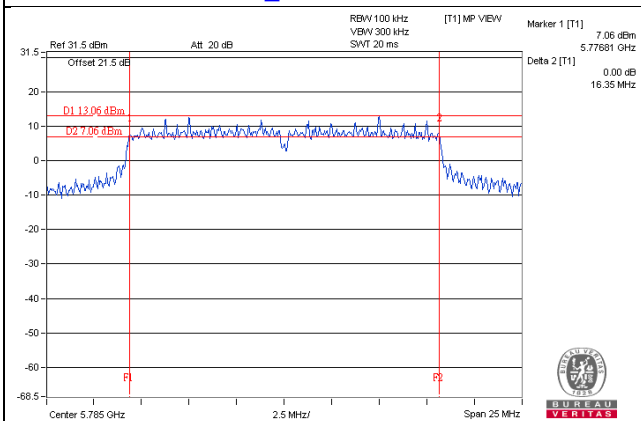

802.11ac (VHT20)_Chain 0 / CH157

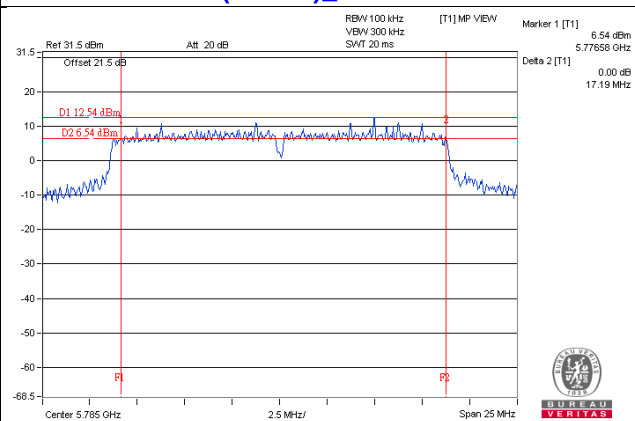

802.11ac (VHT40)_Chain 0 / CH159

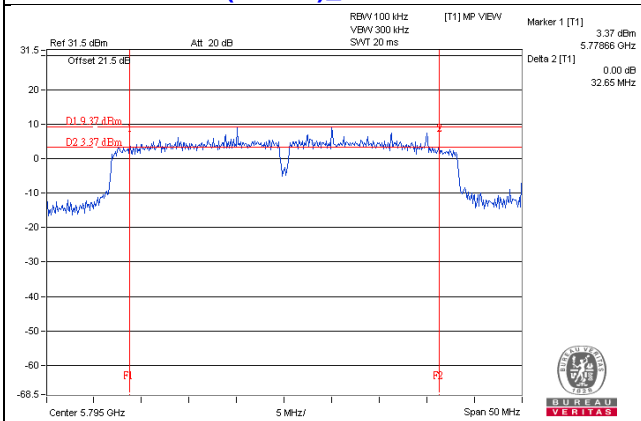

802.11ac (VHT80)_Chain 2 / CH155

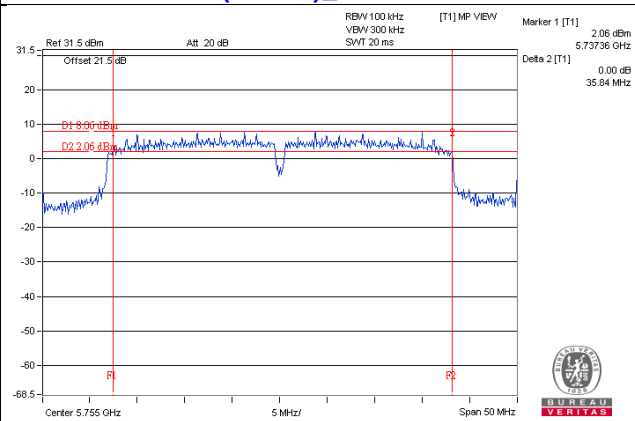

4.7.9 Test Results (Mode 3)

802.11a

Channel	Frequency (MHz)	6dB Bandwidth (MHz)		Minimum Limit (MHz)	Pass / Fail
		Chain 0	Chain 1		
149	5745	16.37	16.36	0.5	PASS
157	5785	16.34	16.37	0.5	PASS
165	5825	16.38	16.38	0.5	PASS

802.11ac (VHT20)

Channel	Frequency (MHz)	6dB Bandwidth (MHz)		Minimum Limit (MHz)	Pass / Fail
		Chain 0	Chain 1		
149	5745	17.20	17.64	0.5	PASS
157	5785	17.62	17.62	0.5	PASS
165	5825	17.61	17.60	0.5	PASS

802.11ac (VHT40)

Channel	Frequency (MHz)	6dB Bandwidth (MHz)		Minimum Limit (MHz)	Pass / Fail
		Chain 0	Chain 1		
151	5755	33.89	35.03	0.5	PASS
159	5795	34.45	35.10	0.5	PASS

802.11ac (VHT80)

Channel	Frequency (MHz)	6dB Bandwidth (MHz)		Minimum Limit (MHz)	Pass / Fail
		Chain 0	Chain 1		
155	5775	75.99	75.99	0.5	PASS

802.11ac (VHT80+80)

Channel	Frequency (MHz)	6dB Bandwidth (MHz)		Minimum Limit (MHz)	Pass / Fail
		Chain 0	Chain 2		
42+155	5775	-	75.34	0.5	PASS

Spectrum Plot of Worst Value

802.11a_Chain 0 / CH157

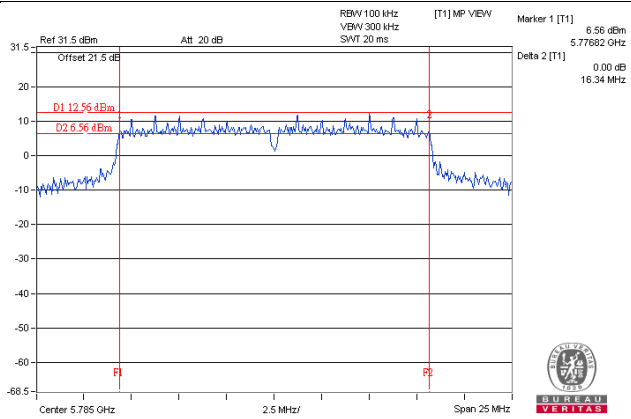

802.11ac (VHT20)_Chain 0 / CH149

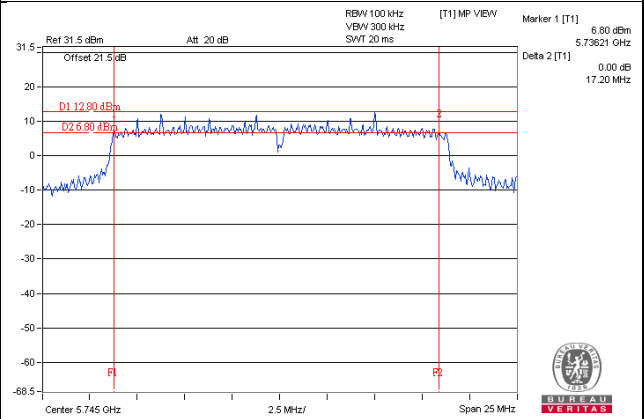

802.11ac (VHT40)_Chain 0 / CH151

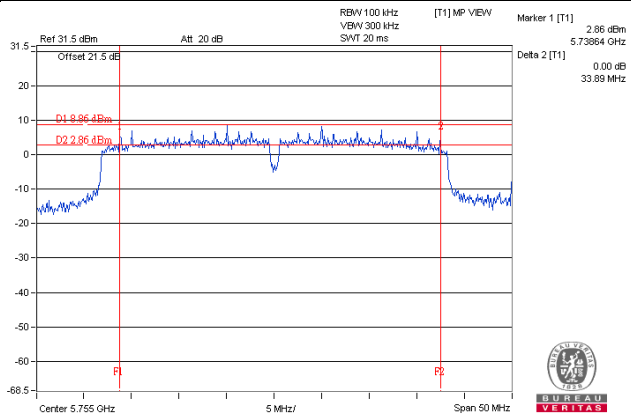

802.11ac (VHT80)_Chain 0 / CH155

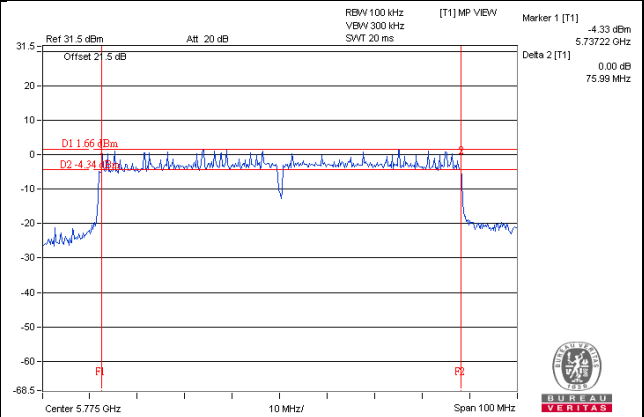

802.11ac (VHT80 + VHT80)_Chain 2 / CH155

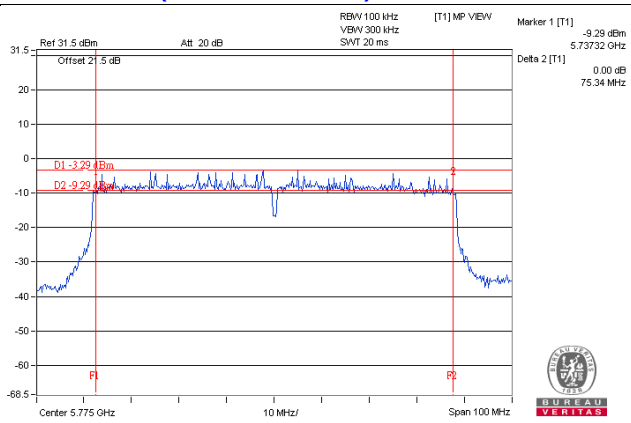

4.7.10 Test Results (Mode 4)

802.11a

Channel	Frequency (MHz)	6dB Bandwidth (MHz)	Minimum Limit (MHz)	Pass / Fail
149	5745	16.37	0.5	PASS
157	5785	16.31	0.5	PASS
165	5825	16.35	0.5	PASS

802.11ac (VHT20)

Channel	Frequency (MHz)	6dB Bandwidth (MHz)	Minimum Limit (MHz)	Pass / Fail
149	5745	17.34	0.5	PASS
157	5785	17.35	0.5	PASS
165	5825	17.61	0.5	PASS

802.11ac (VHT40)

Channel	Frequency (MHz)	6dB Bandwidth (MHz)	Minimum Limit (MHz)	Pass / Fail
151	5755	35.16	0.5	PASS
159	5795	35.12	0.5	PASS

802.11ac (VHT80)

Channel	Frequency (MHz)	6dB Bandwidth (MHz)	Minimum Limit (MHz)	Pass / Fail
155	5775	75.94	0.5	PASS

Spectrum Plot of Worst Value

802.11a / CH157

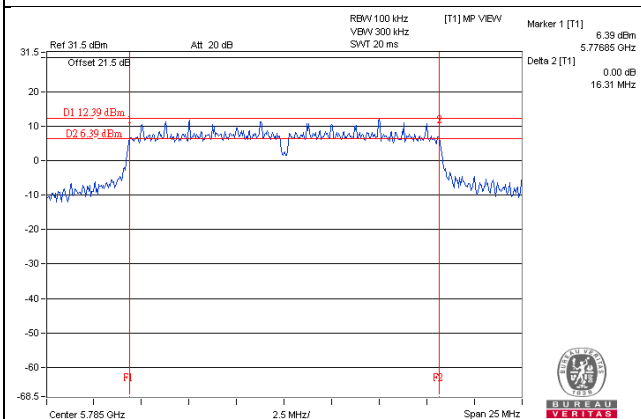

802.11ac (VHT20) / CH149

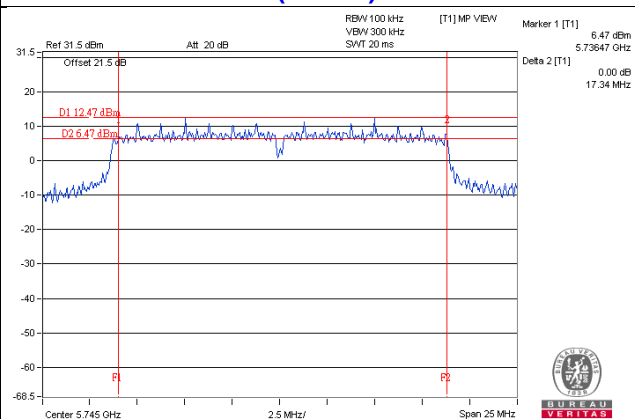

802.11ac (VHT40) / CH159

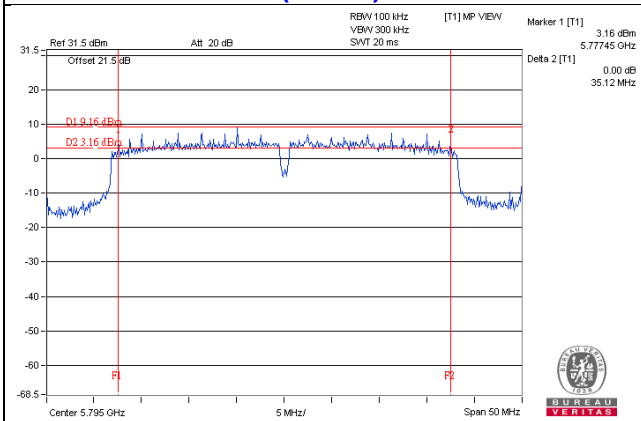

802.11ac (VHT80) / CH155

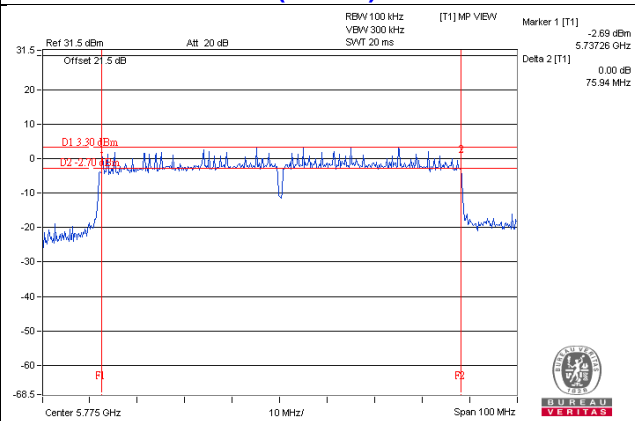

5 Pictures of Test Arrangements

Please refer to the attached file (Test Setup Photo).

Annex A- Radiated Out of Band Emission (OOBE) Measurement (For U-NII-3 band)

4TX Mode

802.11a

CH 149 5745 MHz

Horizontal

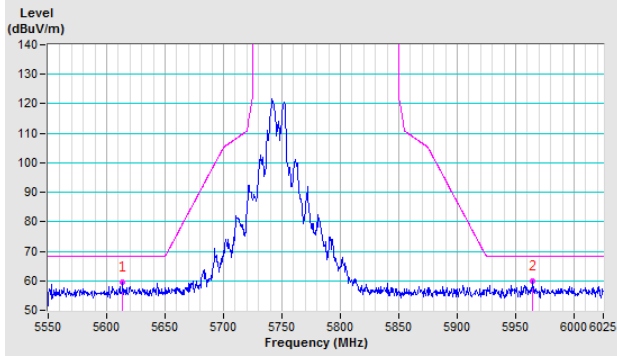

Vertical

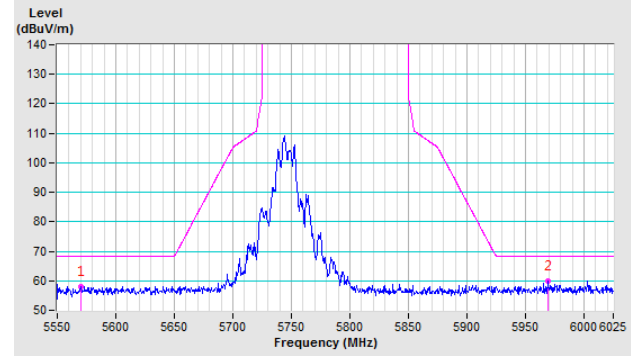

CH 157 5785 MHz

Horizontal

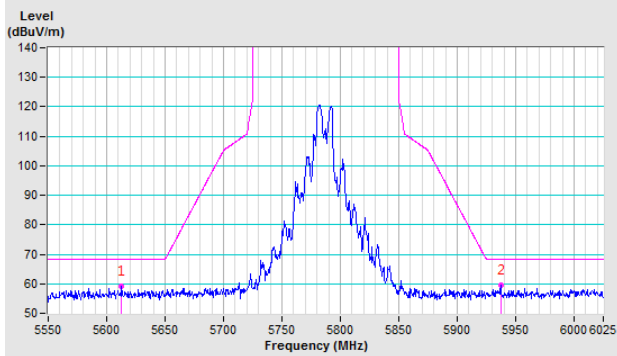

Vertical

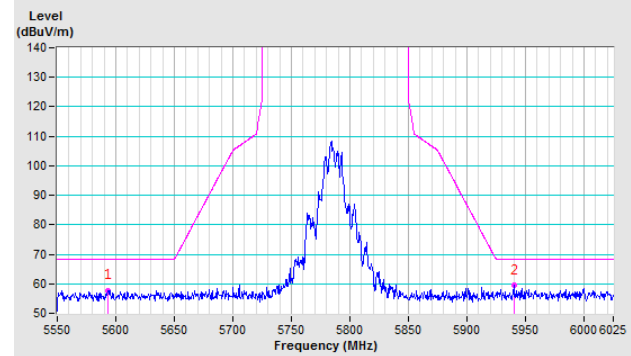

CH 165 5825 MHz

Horizontal

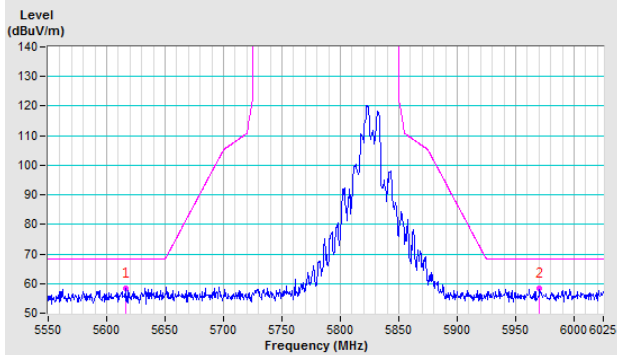

Vertical

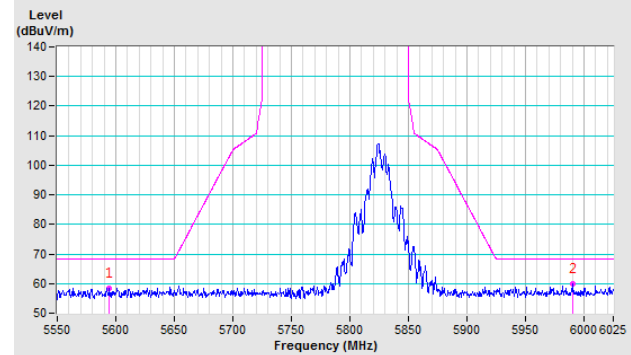

802.11ac (VHT20)

CH 149 5745 MHz

Horizontal

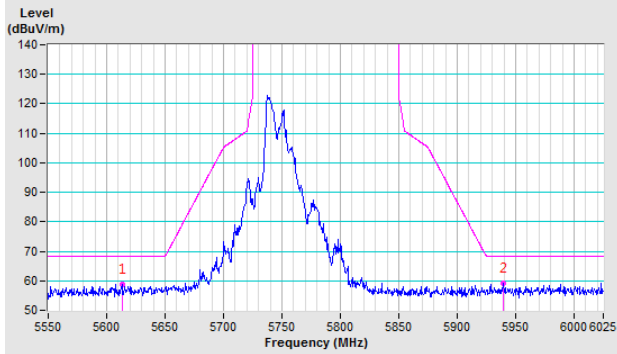

Vertical

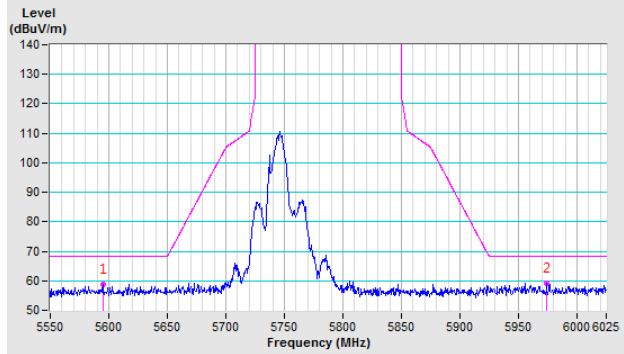

CH 157 5785 MHz

Horizontal

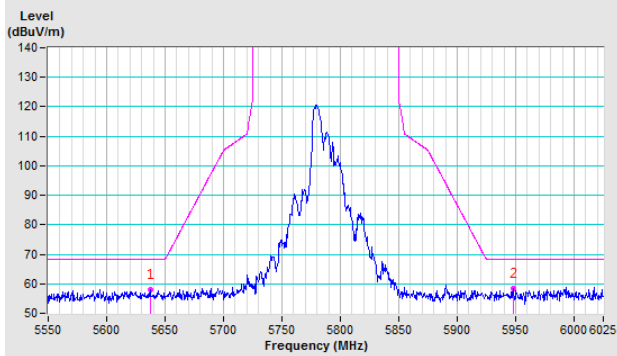

Vertical

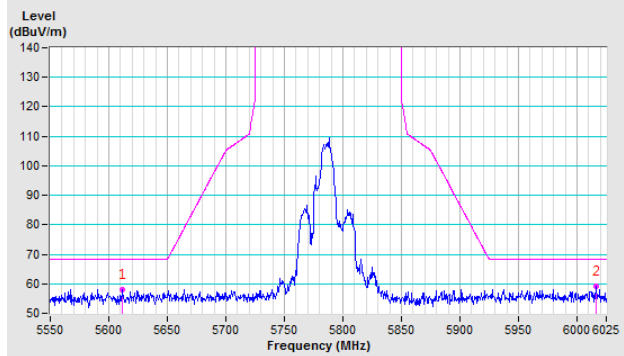

CH 165 5825 MHz

Horizontal

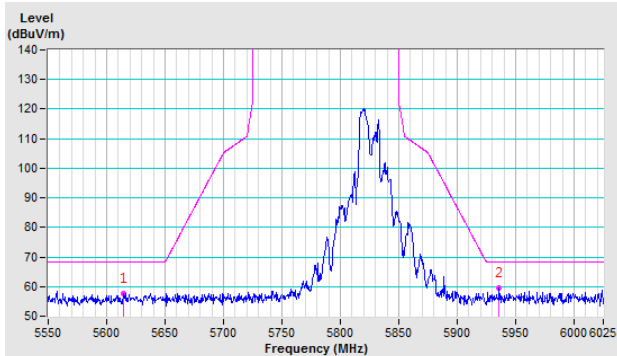

Vertical

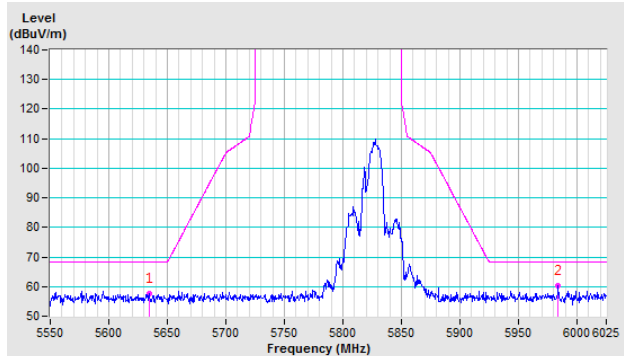

802.11ac (VHT40)

CH 151 5755 MHz

Horizontal

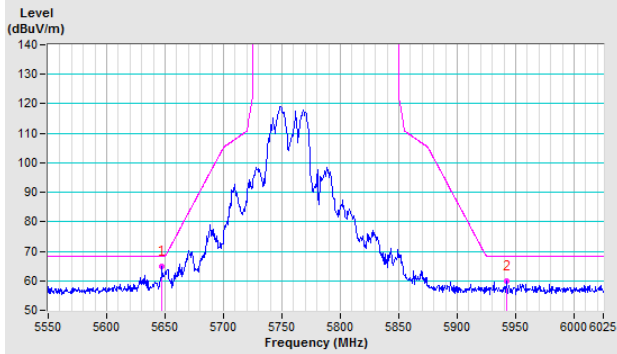

Vertical

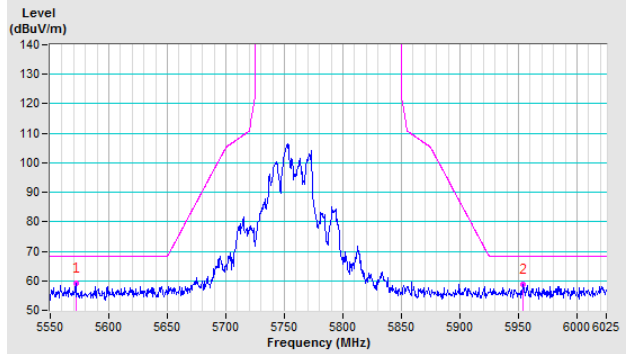

CH 159 5795 MHz

Horizontal

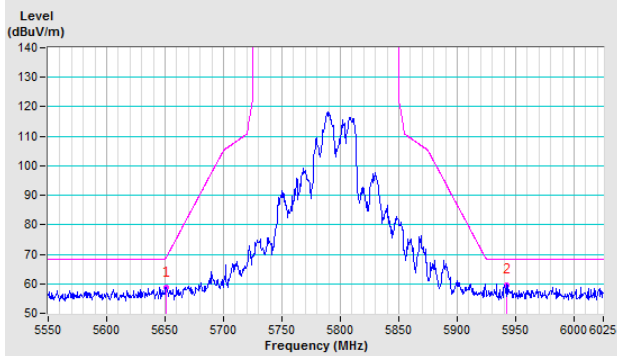

Vertical

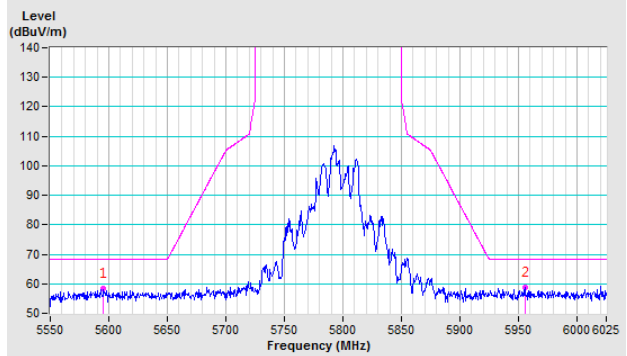

802.11ac (VHT80)

CH 155 5775 MHz

Horizontal

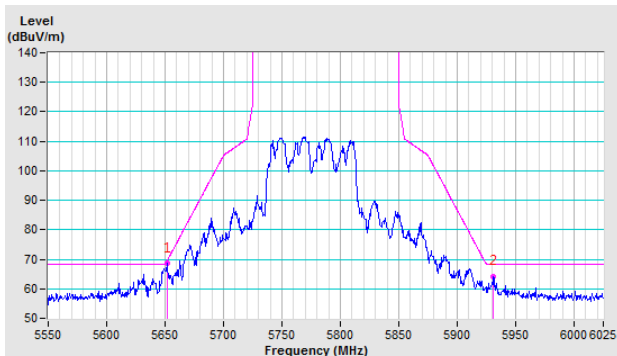

Vertical

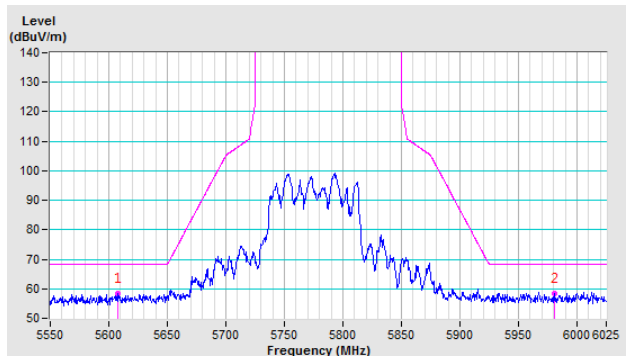

802.11ac (VHT80+80)

CH 42+155 5210+5775 MHz

Horizontal

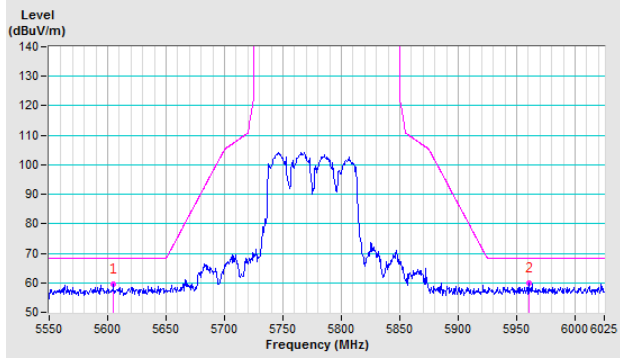

Vertical

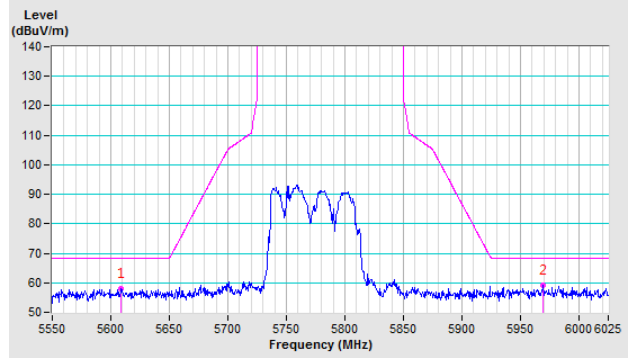

3TX Mode

802.11a

CH 149 5745 MHz

Horizontal

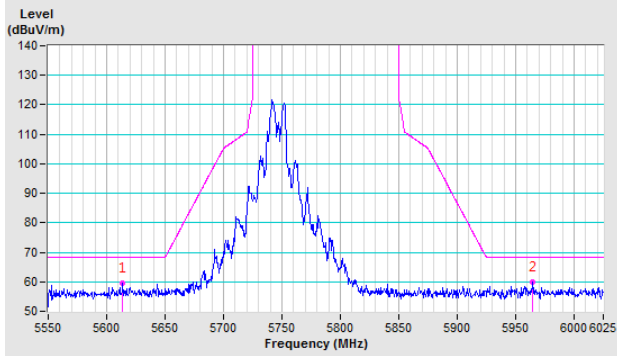

Vertical

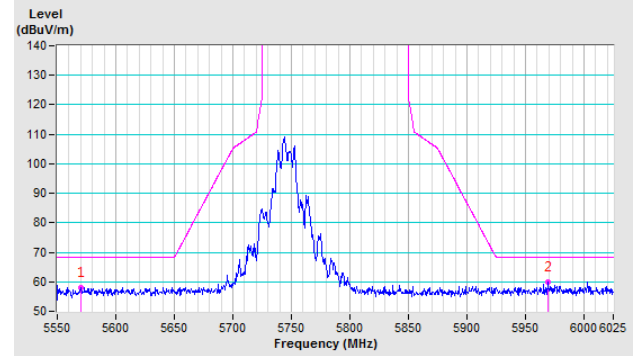

CH 157 5785 MHz

Horizontal

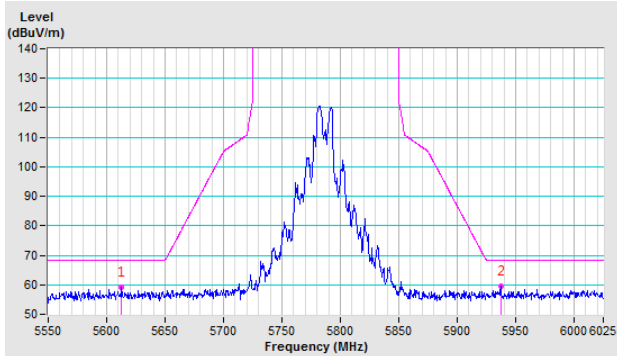

Vertical

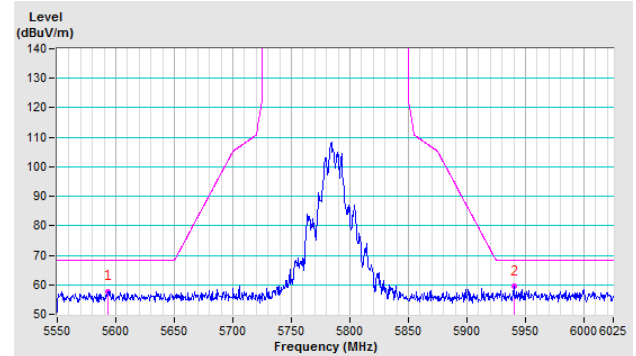

CH 165 5825 MHz

Horizontal

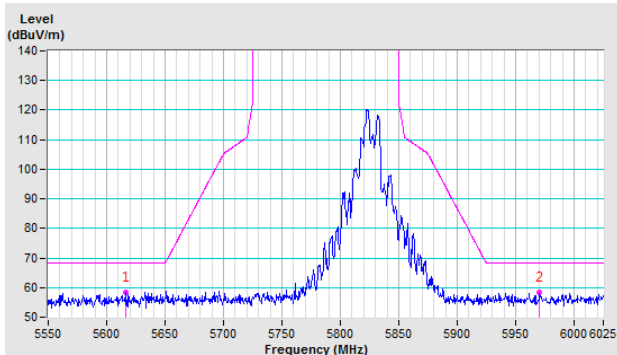

Vertical

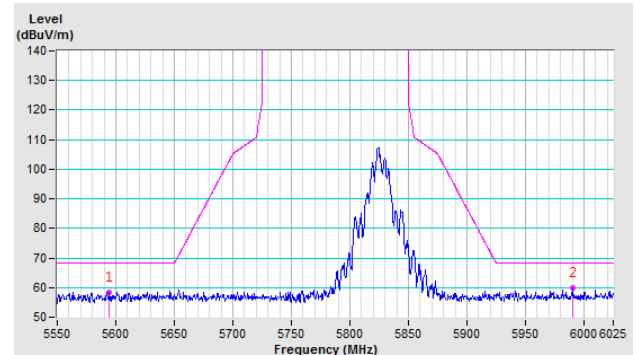

802.11ac (VHT20)

CH 149 5745 MHz

Horizontal

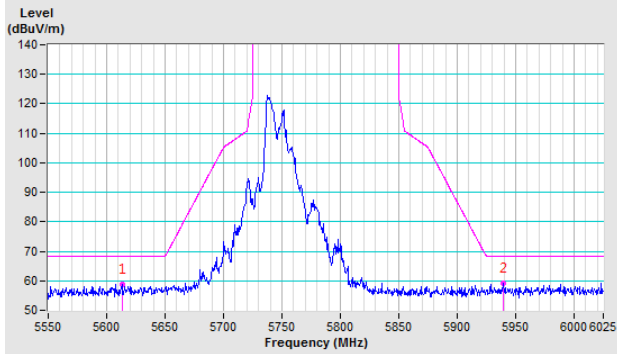

Vertical

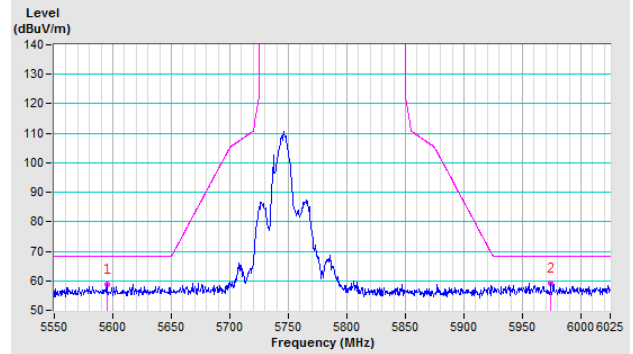

CH 157 5785 MHz

Horizontal

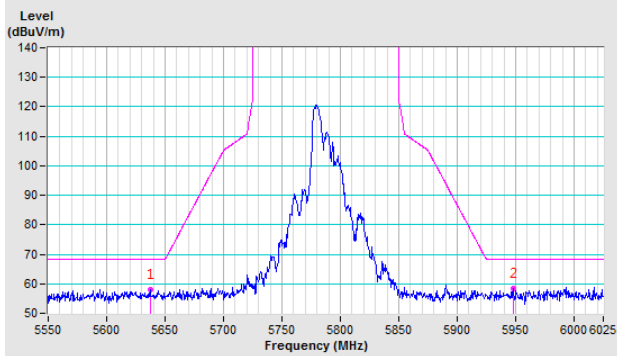

Vertical

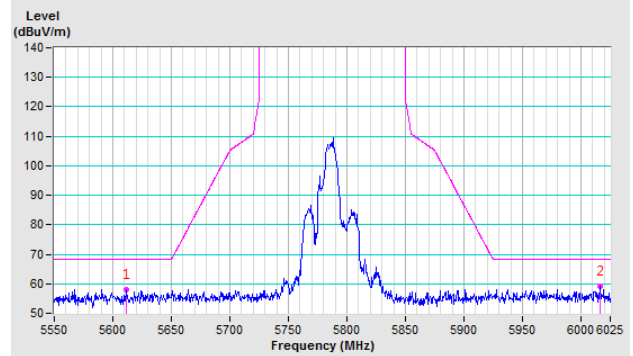

CH 165 5825 MHz

Horizontal

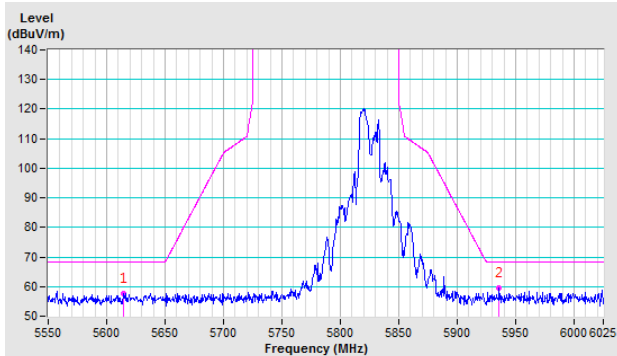

Vertical

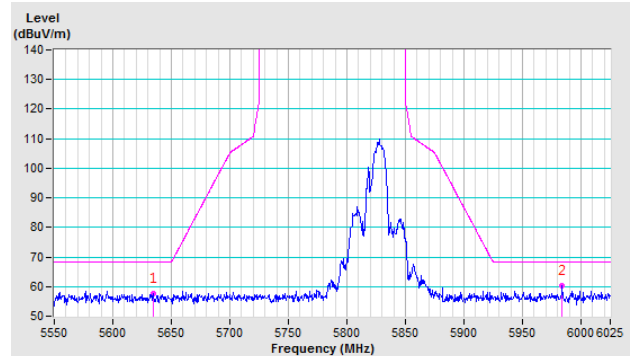

802.11ac (VHT40)

CH 151 5755 MHz

Horizontal

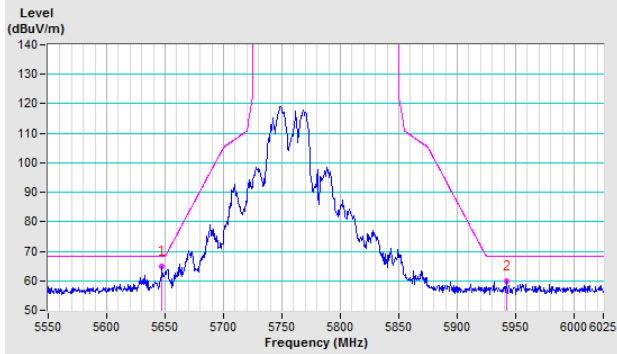

Vertical

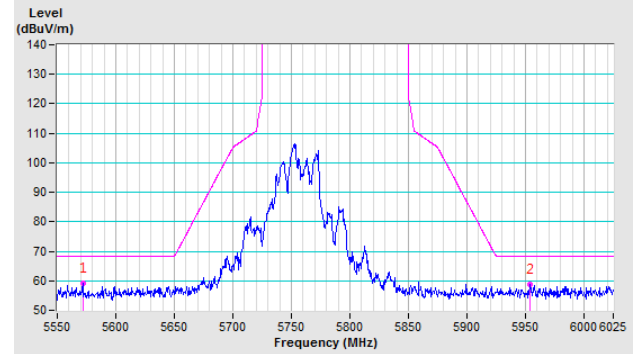

CH 159 5795 MHz

Horizontal

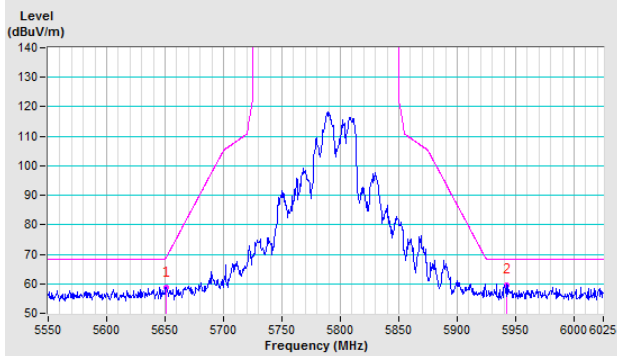

Vertical

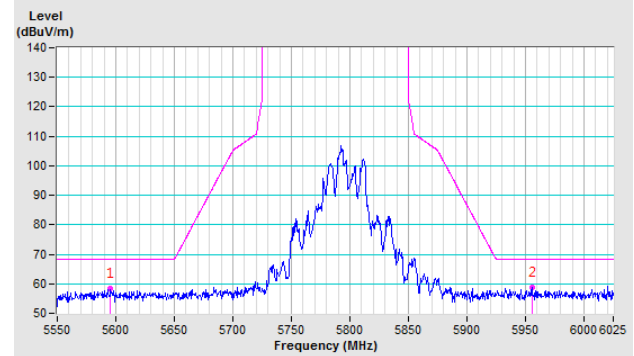

802.11ac (VHT80)

CH 155 5775 MHz

Horizontal

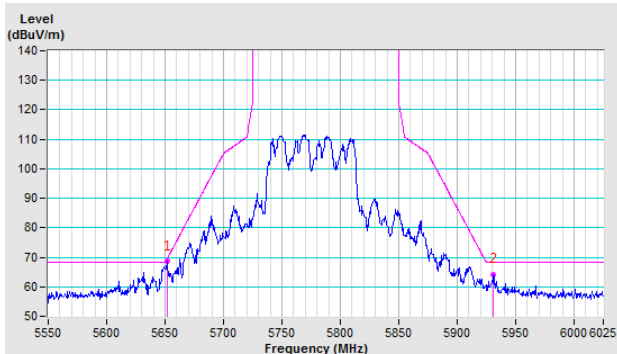

Vertical

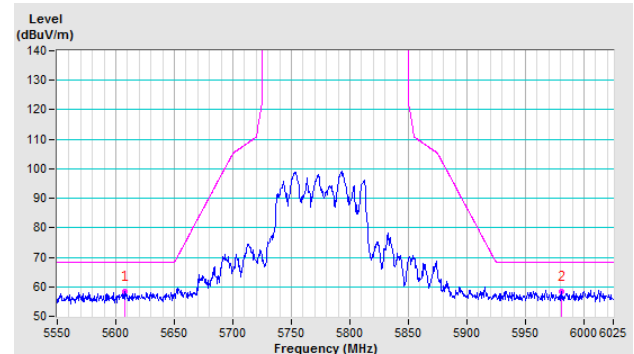

2TX Mode

802.11a

CH 149 5745 MHz

Horizontal

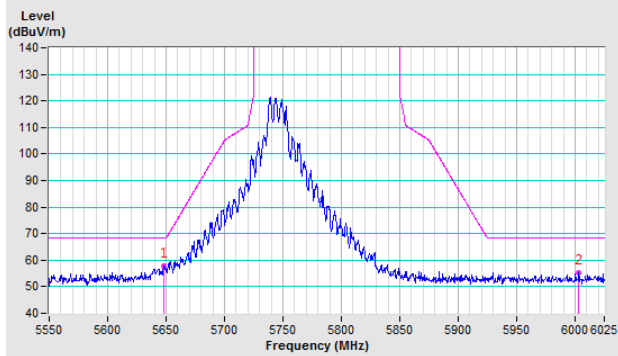

Vertical

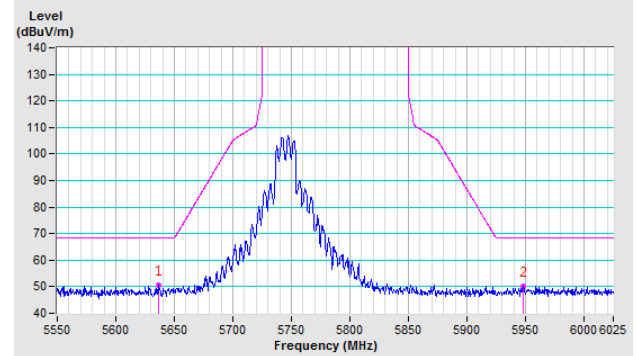

CH 157 5785 MHz

Horizontal

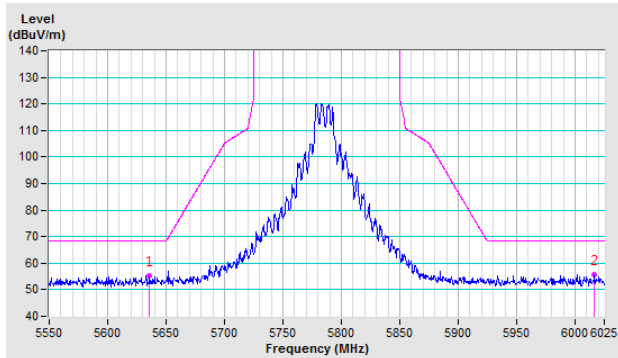

Vertical

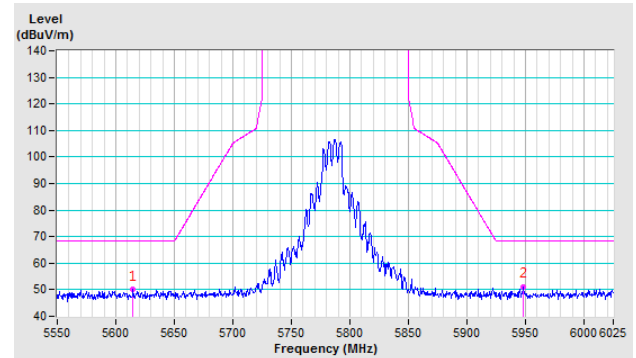

CH 165 5825 MHz

Horizontal

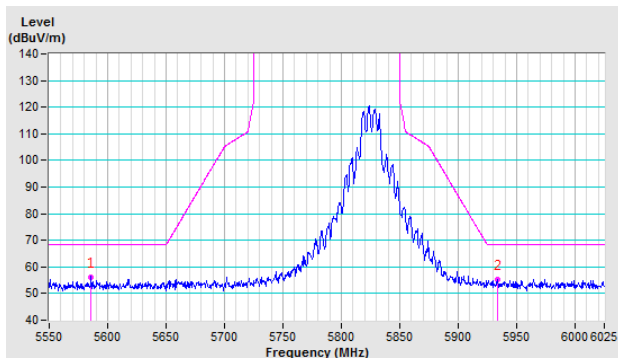

Vertical

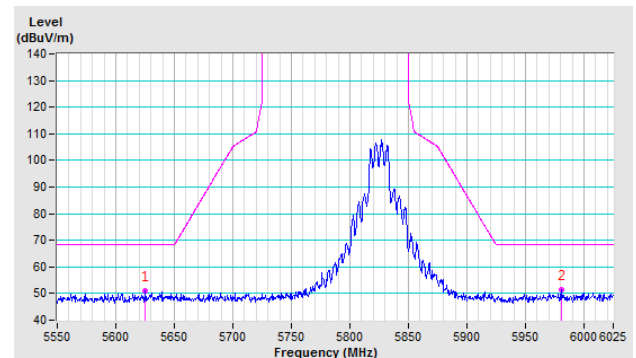

802.11ac (VHT20)

CH 149 5745 MHz

Horizontal

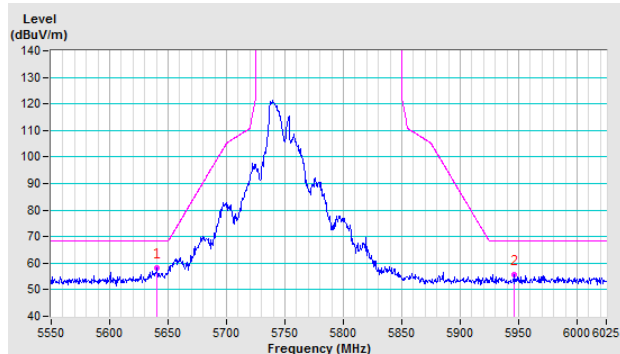

Vertical

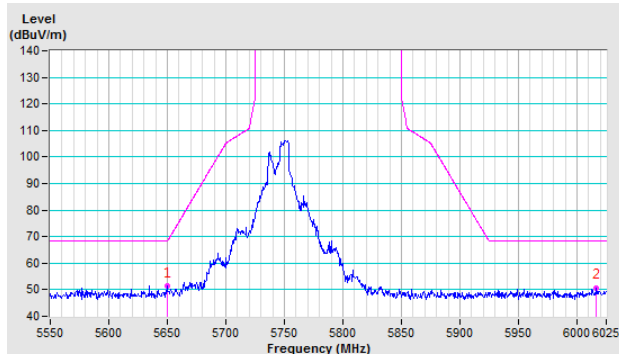

CH 157 5785 MHz

Horizontal

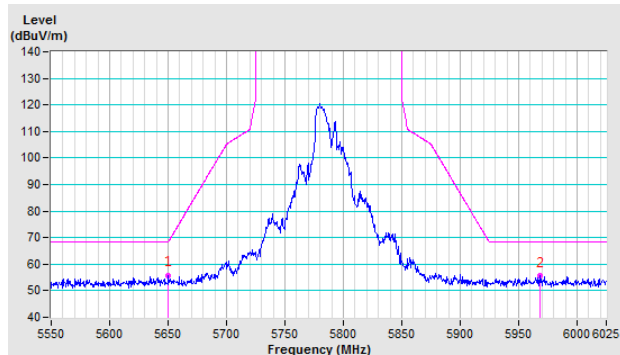

Vertical

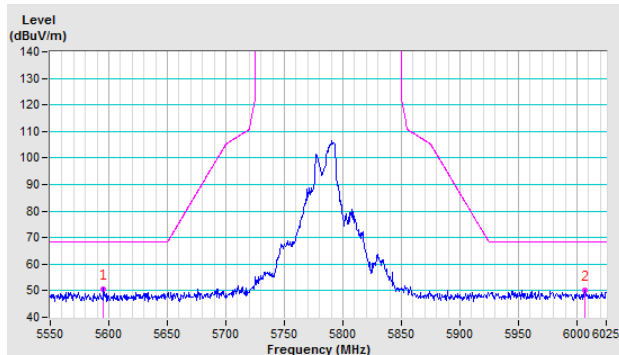

CH 165 5825 MHz

Horizontal

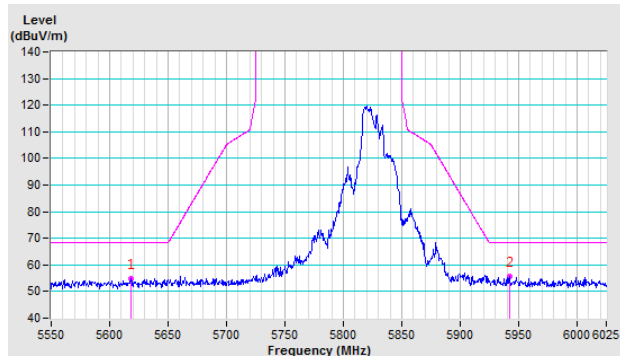

Vertical

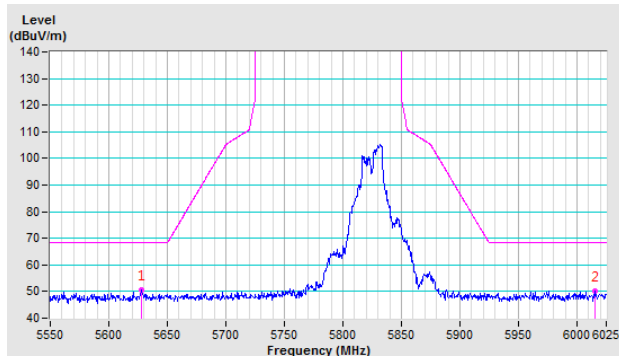

802.11ac (VHT40)

CH 151 5755 MHz

Horizontal

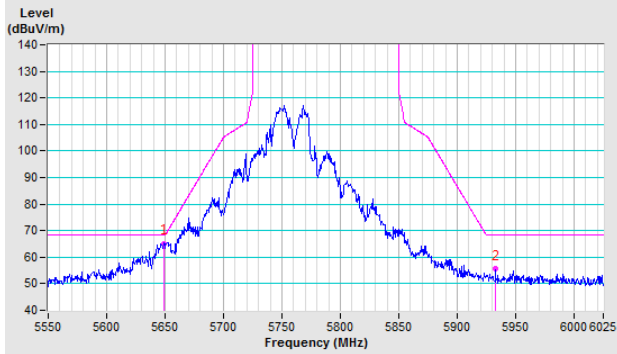

Vertical

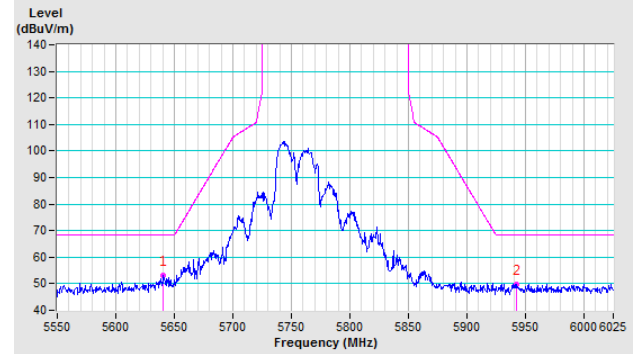

CH 159 5795 MHz

Horizontal

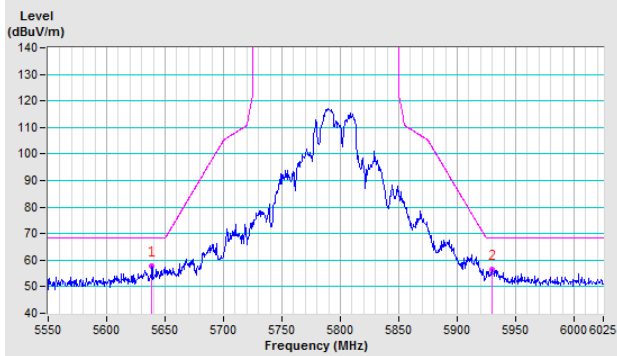

Vertical

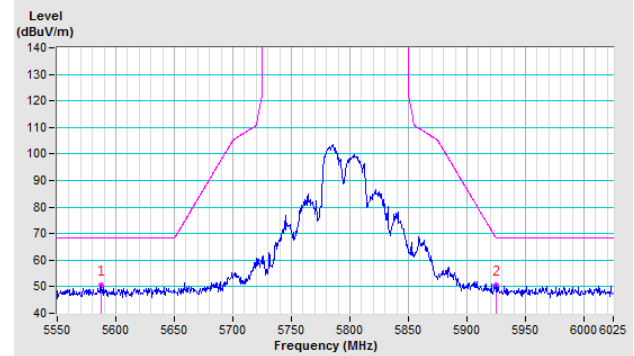

802.11ac (VHT80)

CH 155 5775 MHz

Horizontal

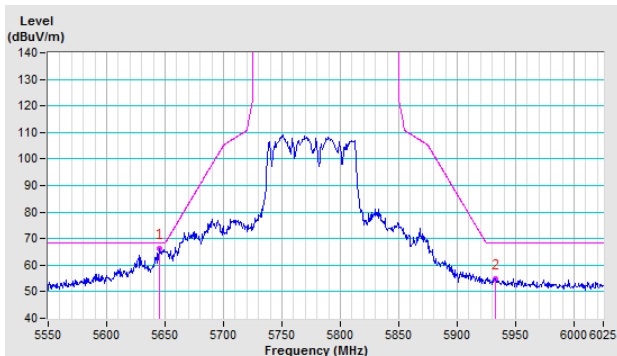

Vertical

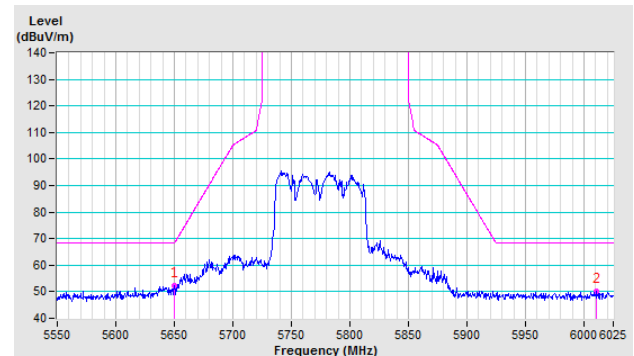

802.11ac (VHT80+80)

CH 42+155 5210+5775 MHz

Horizontal

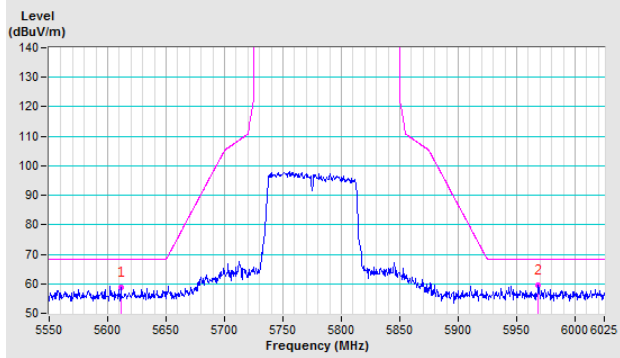

Vertical

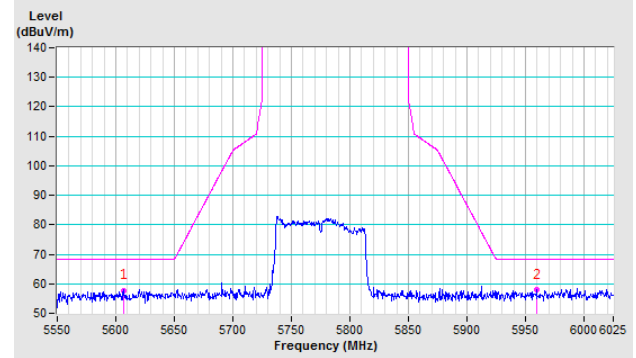

1TX Mode

802.11a

CH 149 5745 MHz

Horizontal

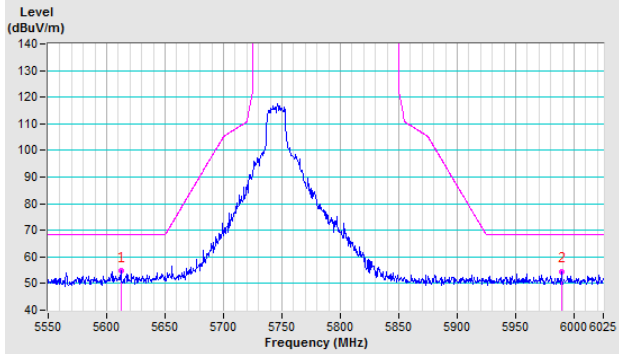

Vertical

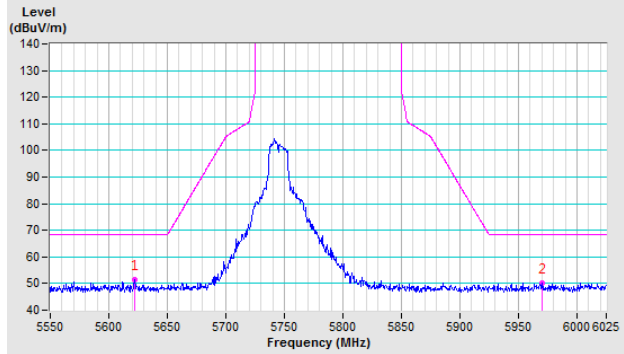

CH 157 5785 MHz

Horizontal

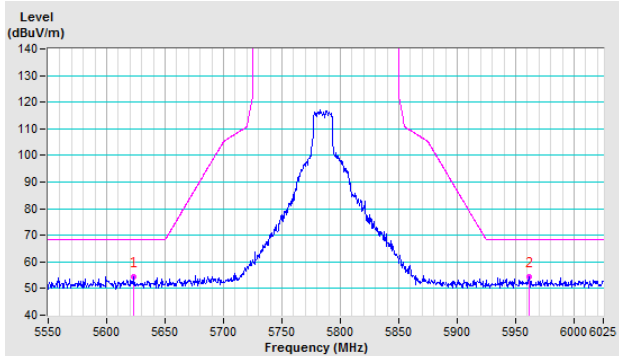

Vertical

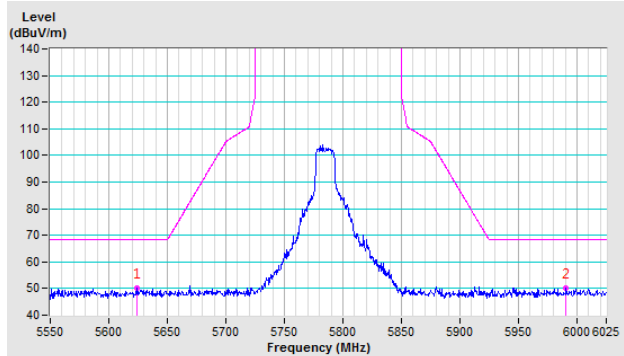

CH 165 5825 MHz

Horizontal

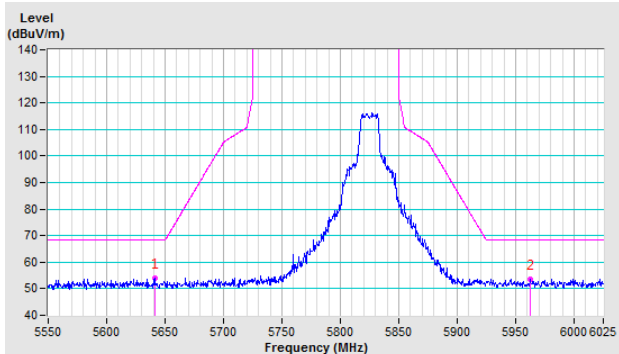

Vertical

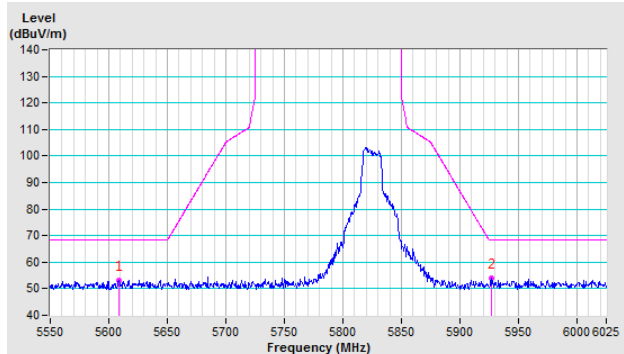

802.11ac (VHT20)

CH 149 5745 MHz

Horizontal

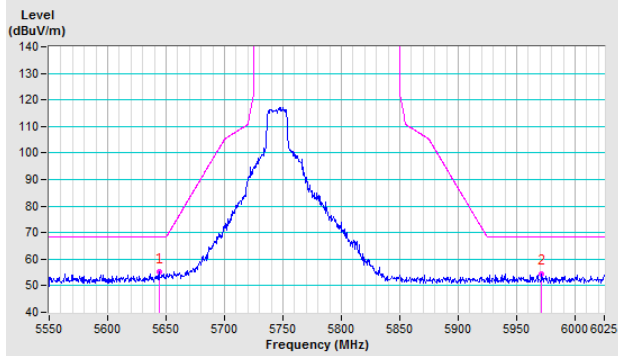

Vertical

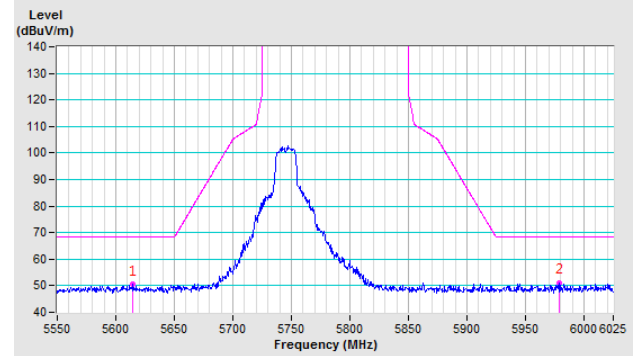

CH 157 5785 MHz

Horizontal

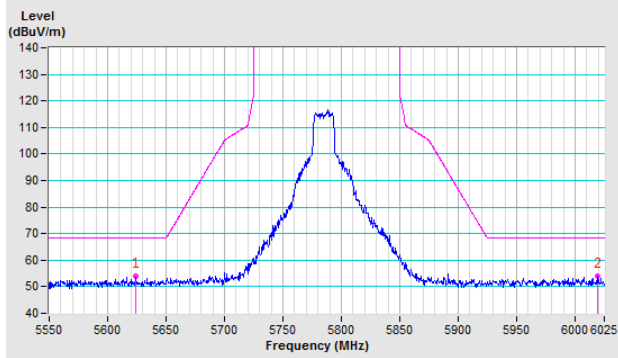

Vertical

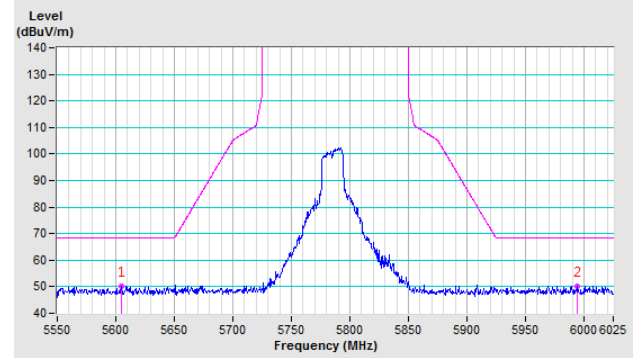

CH 165 5825 MHz

Horizontal

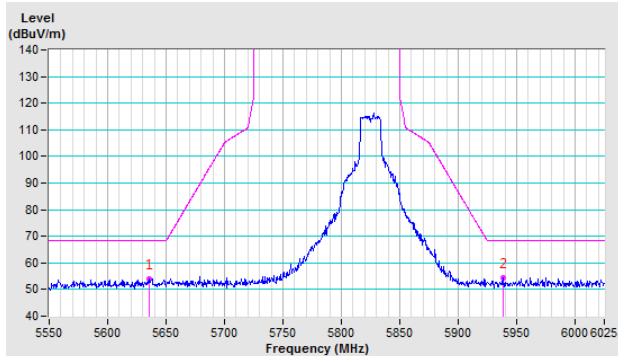

Vertical

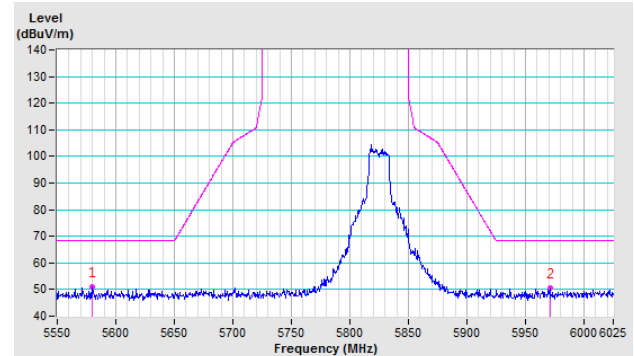

802.11ac (VHT40)

CH 151 5755 MHz

Horizontal

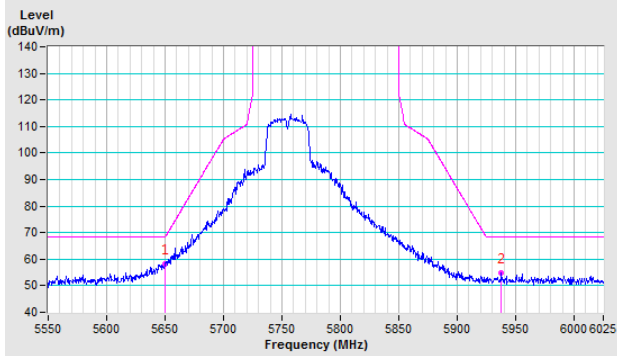

Vertical

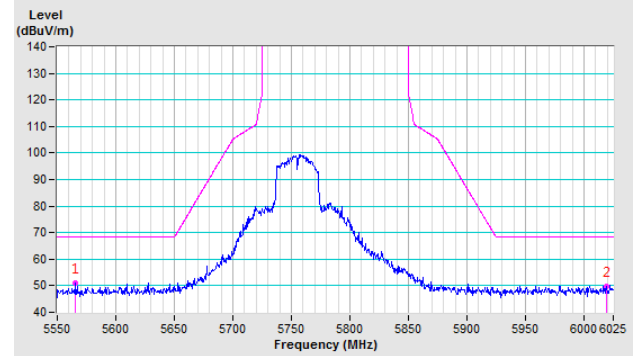

CH 159 5795 MHz

Horizontal

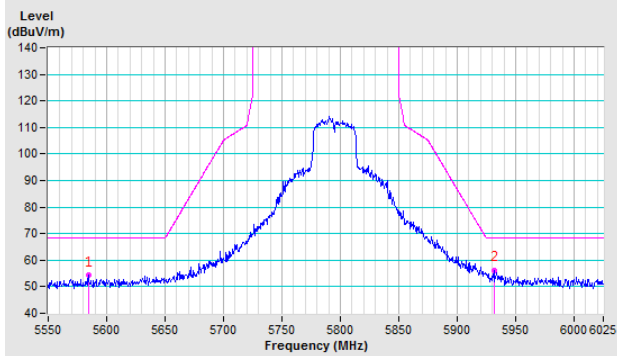

Vertical

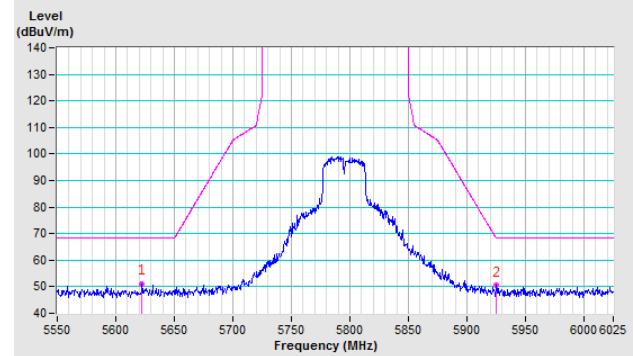

802.11ac (VHT80)

CH 155 5775 MHz

Horizontal

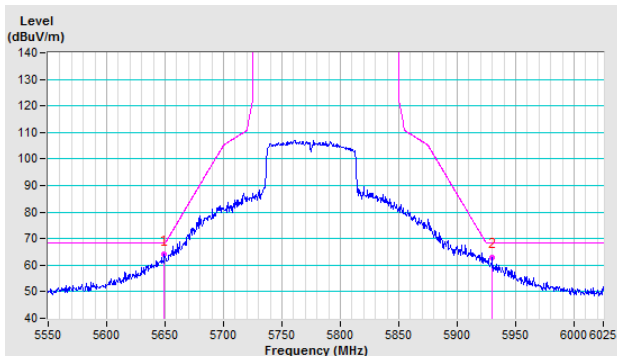

Vertical

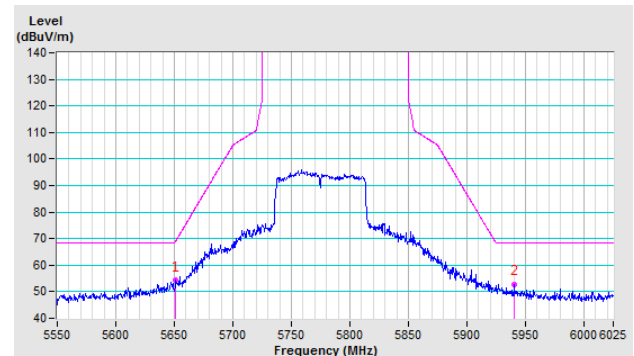

Appendix – Information on the Testing Laboratories

We, Bureau Veritas Consumer Products Services (H.K.) Ltd., Taoyuan Branch, were founded in 1988 to provide our best service in EMC, Radio, Telecom and Safety consultation. Our laboratories are accredited and approved according to ISO/IEC 17025.

If you have any comments, please feel free to contact us at the following:

Linko EMC/RF Lab

Tel: 886-2-26052180

Fax: 886-2-26051924

Hsin Chu EMC/RF/Telecom Lab

Tel: 886-3-6668565

Fax: 886-3-6668323

Hwa Ya EMC/RF/Safety Lab

Tel: 886-3-3183232

Fax: 886-3-3270892

Email: service.adt@tw.bureauveritas.com

Web Site: www.bureauveritas-adt.com

The address and road map of all our labs can be found in our web site also.

--- END ---