

FCC Test Report

(WLAN UNII-2A / UNII-2C Band)

Report No.: RF170619E02A-1

FCC ID: 2ACTO-APX530

Test Model: APX 530

Received Date: June 22, 2017

Test Date: June 28 to July 20, 2017

Issued Date: Oct. 13, 2017

Applicant: Sophos Ltd

Address: The Pentagon, Abingdon Science Park, Abingdon, OX14 3YP, United Kingdom

Issued By: Bureau Veritas Consumer Products Services (H.K.) Ltd., Taoyuan Branch
Hsin Chu Laboratory

Lab Address: E-2, No.1, Li Hsin 1st Road, Hsinchu Science Park, Hsinchu City 300,
Taiwan R.O.C.

Test Location (1): E-2, No.1, Li Hsin 1st Road, Hsinchu Science Park, Hsinchu City 300,
Taiwan R.O.C.

**FCC Registration /
Designation Number:** 723255 / TW2022



This report is for your exclusive use. Any copying or replication of this report to or for any other person or entity, or use of our name or trademark, is permitted only with our prior written permission. This report sets forth our findings solely with respect to the test samples identified herein. The results set forth in this report are not indicative or representative of the quality or characteristics of the lot from which a test sample was taken or any similar or identical product unless specifically and expressly noted. Our report includes all of the tests requested by you and the results thereof based upon the information that you provided to us. You have 60 days from date of issuance of this report to notify us of any material error or omission caused by our negligence, provided, however, that such notice shall be in writing and shall specifically address the issue you wish to raise. A failure to raise such issue within the prescribed time shall constitute your unqualified acceptance of the completeness of this report, the tests conducted and the correctness of the report contents. Unless specific mention, the uncertainty of measurement has been explicitly taken into account to declare the compliance or non-compliance to the specification. The report must not be used by the client to claim product certification, approval, or endorsement by TAF or any government agencies.

Table of Contents

Release Control Record	4
1 Certificate of Conformity	5
2 Summary of Test Results	6
2.1 Measurement Uncertainty	6
2.2 Modification Record	6
3 General Information	7
3.1 General Description of EUT (DFS Band)	7
3.2 Description of Test Modes	10
3.2.1 Test Mode Applicability and Tested Channel Detail	11
3.3 Duty Cycle of Test Signal	13
3.4 Description of Support Units	14
3.4.1 Configuration of System under Test	15
3.5 General Description of Applied Standard	17
4 Test Types and Results	18
4.1 Radiated Emission and Bandedge Measurement	18
4.1.1 Limits of Radiated Emission and Bandedge Measurement	18
4.1.2 Test Instruments	19
4.1.3 Test Procedure	21
4.1.4 Deviation from Test Standard	21
4.1.5 Test Setup	22
4.1.6 EUT Operating Condition	23
4.1.7 Test Results (Mode 1)	24
4.1.8 Test Results (Mode 2)	49
4.1.9 Test Results (Mode 3)	73
4.2 Conducted Emission Measurement	97
4.2.1 Limits of Conducted Emission Measurement	97
4.2.2 Test Instruments	97
4.2.3 Test Procedure	98
4.2.4 Deviation from Test Standard	98
4.2.5 Test Setup	98
4.2.6 EUT Operating Condition	98
4.2.7 Test Results (Mode 1)	99
4.3 Transmit Power Measurement	101
4.3.1 Limits of Transmit Power Measurement	101
4.3.2 Test Setup	102
4.3.3 Test Instruments	102
4.3.4 Test Procedure	103
4.3.5 Deviation from Test Standard	103
4.3.6 EUT Operating Condition	103
4.3.7 Test Result (Mode 1)	104
4.3.8 Test Result (Mode 2)	120
4.3.9 Test Result (Mode 3)	136
4.4 Occupied Bandwidth Measurement	143
4.4.1 Test Setup	143
4.4.2 Test Instruments	143
4.4.3 Test Procedure	143
4.4.4 Test Results (Mode 1)	144
4.4.5 Test Results (Mode 2)	147
4.4.6 Test Results (Mode 3)	150
4.5 Peak Power Spectral Density Measurement	152
4.5.1 Limits of Peak Power Spectral Density Measurement	152
4.5.2 Test Setup	152
4.5.3 Test Instruments	152

4.5.4	Test Procedure	153
4.5.5	Deviation from Test Standard	153
4.5.6	EUT Operating Condition	153
4.5.7	Test Results (Mode 1).....	154
4.5.8	Test Results (Mode 2).....	160
4.5.9	Test Results (Mode 3).....	166
4.6	Frequency Stability Measurement.....	171
4.6.1	Limits of Frequency Stability Measurement	171
4.6.2	Test Setup.....	171
4.6.3	Test Instruments	171
4.6.4	Test Procedure	171
4.6.5	Deviation from Test Standard	171
4.6.6	EUT Operating Condition	171
4.6.7	Test Results	172
4.7	6dB Bandwidth Measurement.....	173
4.7.1	Limits of 6dB Bandwidth Measurement.....	173
4.7.2	Test Setup.....	173
4.7.3	Test Instruments	173
4.7.4	Test Procedure	173
4.7.5	Deviation from Test Standard	173
4.7.6	EUT Operating Condition	173
4.7.7	Test Results (Mode 1).....	174
4.7.8	Test Results (Mode 2).....	176
4.7.9	Test Results (Mode 3).....	178
5	Pictures of Test Arrangements.....	180
	Appendix – Information on the Testing Laboratories	181

Release Control Record

Issue No.	Description	Date Issued
RF170619E02A-1	Original release.	Oct. 13, 2017

1 Certificate of Conformity

Product: Sophos Access Point
Brand: SOPHOS
Test Model: APX 530
Sample Status: ENGINEERING SAMPLE
Applicant: Sophos Ltd
Test Date: June 28 to July 20, 2017
Standard: 47 CFR FCC Part 15, Subpart E (Section 15.407)
ANSI C63.10: 2013

The above equipment has been tested by **Bureau Veritas Consumer Products Services (H.K.) Ltd., Taoyuan Branch**, and found compliance with the requirement of the above standards. The test record, data evaluation & Equipment Under Test (EUT) configurations represented herein are true and accurate accounts of the measurements of the sample's EMC characteristics under the conditions specified in this report.

Prepared by : Wendy Wu , **Date:** Oct. 13, 2017
Wendy Wu / Specialist

Approved by : May Chen , **Date:** Oct. 13, 2017
May Chen / Manager

2 Summary of Test Results

47 CFR FCC Part 15, Subpart E (Section 15.407)			
FCC Clause	Test Item	Result	Remarks
15.407(b)(6)	AC Power Conducted Emissions	Pass	Meet the requirement of limit. Minimum passing margin is -7.18dB at 0.40416MHz.
15.407(b) (1/2/3/4(i/ii)/6)	Radiated Emissions & Band Edge Measurement*	Pass	Meet the requirement of limit. Minimum passing margin is -0.1dB at 5470.00MHz, 5350.00MHz, 5725.00MHz, 5850.00MHz.
15.407(a)(1/2/3)	Max Average Transmit Power	Pass	Meet the requirement of limit.
---	Occupied Bandwidth Measurement	-	Reference only.
15.407(a)(1/2/3)	Peak Power Spectral Density	Pass	Meet the requirement of limit.
15.407(e)	6dB bandwidth	Pass	Meet the requirement of limit. (U-NII-3 Band only)
15.407(g)	Frequency Stability	Pass	Meet the requirement of limit.
15.203	Antenna Requirement	Pass	Antenna connector is i-pex(MHF) not a standard connector.

2.1 Measurement Uncertainty

Where relevant, the following measurement uncertainty levels have been estimated for tests performed on the EUT as specified in CISPR 16-4-2:

Measurement	Frequency	Expanded Uncertainty (k=2) (±)
Conducted Emissions at mains ports	150kHz ~ 30MHz	1.84 dB
Radiated Emissions up to 1 GHz	30MHz ~ 1GHz	5.32 dB
Radiated Emissions above 1 GHz	1GHz ~ 6GHz	5.14 dB
	6GHz ~ 18GHz	5.04 dB
	18GHz ~ 40GHz	5.25 dB

2.2 Modification Record

There were no modifications required for compliance.

3 General Information

3.1 General Description of EUT (DFS Band)

Product	Sophos Access Point
Brand	SOPHOS
Test Model	APX 530
Status of EUT	ENGINEERING SAMPLE
Power Supply Rating	DC 55V from POE
Modulation Type	64QAM, 16QAM, QPSK, BPSK for OFDM 256QAM for OFDM in 11ac mode only
Modulation Technology	OFDM
Transfer Rate	802.11a: up to 54Mbps 802.11n: up to 450Mbps 802.11ac: up to 1300Mbps
Operating Frequency	5.26GHz ~ 5.32GHz, 5.50GHz ~ 5.72GHz
Number of Channel	802.11a, 802.11n (HT20), 802.11ac (VHT20): 16 802.11n (HT40), 802.11ac (VHT40): 8 802.11ac (VHT80): 4
Output Power	<p>CDD Mode:</p> <p>5.26 ~ 5.32GHz: 3TX: 177.159mW (22.48dBm) 2TX: 249.115mW (23.96dBm) 1TX: 180.302mW (22.56dBm)</p> <p>5.50 ~ 5.72GHz: 3TX: 176.615mW (22.47dBm) 2TX: 192.719mW (22.85dBm) 1TX: 146.893mW (21.67dBm)</p> <p>Beamforming Mode:</p> <p>5.26 ~ 5.32GHz: 3TX: 88.38mW (19.46dBm) 2TX: 129.897mW (21.14dBm)</p> <p>5.50 ~ 5.72GHz: 3TX: 88.867mW (19.49dBm) 2TX: 126.609mW (21.02dBm)</p>
Antenna Type	Refer to Note
Antenna Connector	Refer to Note
Accessory Device	NA
Data Cable Supplied	NA

Note:

- This report is prepared for FCC class II permissive change. The difference compared with the Report No.: RF170619E02-1 as the following:
 - ◆ Add DFS band <5.26 ~ 5.32GHz, 5.5 ~ 5.72GHz>
- According to above condition, all test items need to be performed. And all data weres verified to meet the requirements.
- The EUT has three radio transceivers, radio 1 is WLAN technologies for single band (2.4GHz), radio 2 is WLAN technology for single band (5GHz), and radio 3 is Bluetooth low energy (BT-LE) technology only.
- Simultaneously transmission condition.

Condition	Technology	
1	WLAN 2.4GHz (Radio 1)	WLAN 5GHz (Radio 2)

Note: The emission of the simultaneous operation has been evaluated and no non-compliance was found.

- The EUT must be supplied with a POE (only for test not for sale) as following table:

Brand	Model No.	Spec.
Microsemi	PD-9001GR/AC	Input: 100-240Vac, 50/60Hz, 0.67A Output: 55Vdc, 0.6A

- The antennas provided to the EUT, please refer to the following table:

Radio 1								
2.4GHz								
Antenna No.	Transmitter Circuit	Brand	Model No.	Antenna Net Gain (dBi)	Frequency Range (GHz)	Antenna Type	Connector Type	Cable Length
1	Chain (0)	NA	NA	4.71	2.4~2.4835	PIFA	i-pex(MHF)	48
2	Chain (1)	NA	NA	3.54	2.4~2.4835	PIFA	i-pex(MHF)	138
3	Chain (2)	NA	NA	4.6	2.4~2.4835	PIFA	i-pex(MHF)	145
Radio 2								
5GHz								
Antenna No.	Transmitter Circuit	Brand	Model No.	Antenna Net Gain (dBi)	Frequency Range (GHz)	Antenna Type	Connector Type	Cable Length
1	Chain (0)	NA	NA	5.5	5.15~5.85	PIFA	i-pex(MHF)	42
2	Chain (1)	NA	NA	5.76	5.15~5.85	PIFA	i-pex(MHF)	140
3	Chain (2)	NA	NA	5.91	5.15~5.85	PIFA	i-pex(MHF)	145
Radio 3								
Bluetooth								
Antenna No.	Transmitter Circuit	Brand	Model No.	Antenna Net Gain (dBi)	Frequency Range (GHz)	Antenna Type	Connector Type	Cable Length
1	Chain (0)	NA	NA	2.95	2.4~2.4835	PIFA	i-pex(MHF)	74

Note: For 1TX/2TX configuration mode, max gain was selected for the final test.

7. The EUT incorporates a MIMO function:

2.4GHz Band			
MODULATION MODE	DATA RATE (MCS)	TX & RX CONFIGURATION	
802.11b	1 ~ 11Mbps	3TX/2TX/1TX diversity	3RX
802.11g	6 ~ 54Mbps	3TX/2TX/1TX diversity	3RX
802.11n (HT20)	MCS 0~7	3TX/2TX/1TX diversity	3RX
	MCS 8~15	3TX/2TX diversity	3RX
	MCS 16~23	3TX	3RX
802.11n (HT40)	MCS 0~7	3TX/2TX/1TX diversity	3RX
	MCS 8~15	3TX/2TX diversity	3RX
	MCS 16~23	3TX	3RX
5GHz Band			
MODULATION MODE	DATA RATE (MCS)	TX & RX CONFIGURATION	
802.11a	6 ~ 54Mbps	3TX/2TX/1TX diversity	3RX
802.11n (HT20)	MCS 0~7	3TX/2TX/1TX diversity	3RX
	MCS 8~15	3TX/2TX	3RX
	MCS 16~23	3TX	3RX
802.11n (HT40)	MCS 0~7	3TX/2TX/1TX diversity	3RX
	MCS 8~15	3TX/2TX	3RX
	MCS 16~23	3TX	3RX
802.11ac (VHT20)	MCS 0~8, Nss=1	3TX/2TX/1TX diversity	3RX
	MCS 0~8, Nss=2	3TX/2TX	3RX
	MCS 0~9, Nss=3	/3TX	3RX
802.11ac (VHT40)	MCS 0~9, Nss=1	3TX/2TX/1TX diversity	3RX
	MCS 0~9, Nss=2	3TX/2TX	3RX
	MCS 0~9, Nss=3	/3TX	3RX
802.11ac (VHT80)	MCS 0~9, Nss=1	3TX/2TX/1TX diversity	3RX
	MCS 0~9, Nss=2	3TX/2TX	3RX
	MCS 0~9, Nss=3	3TX	3RX

Note:

1. All of modulation mode support beamforming function except 802.11a/b/g modulation mode.
2. The EUT support Beamforming and CDD mode, therefore both mode were investigated and the worst case scenario was identified. The worst case data were presented in test report.
3. The modulation and bandwidth are similar for 802.11n mode for 20MHz (40MHz) and 802.11ac mode for 20MHz (40MHz), therefore investigated worst case to representative mode in test report. (Final test mode refer section 3.2.1)

8. The above EUT information is declared by manufacturer and for more detailed features description, please refer to the manufacturer's specifications or user's manual.

3.2 Description of Test Modes

FOR 5260 ~ 5320MHz

4 channels are provided for 802.11a, 802.11n (HT20), 802.11ac (VHT20):

Channel	Frequency	Channel	Frequency
52	5260 MHz	60	5300 MHz
56	5280 MHz	64	5320 MHz

2 channels are provided for 802.11n (HT40), 802.11ac (VHT40):

Channel	Frequency	Channel	Frequency
54	5270 MHz	62	5310 MHz

1 channel is provided for 802.11ac (VHT80):

Channel	Frequency
58	5290 MHz

FOR 5500 ~ 5720MHz

12 channels are provided for 802.11a, 802.11n (HT20), 802.11ac (VHT20):

Channel	Frequency	Channel	Frequency
100	5500 MHz	124	5620 MHz
104	5520 MHz	128	5640 MHz
108	5540 MHz	132	5660 MHz
112	5560 MHz	136	5680 MHz
116	5580 MHz	140	5700 MHz
120	5600 MHz	144	5720 MHz

6 channels are provided for 802.11n (HT40), 802.11ac (VHT40):

Channel	Frequency	Channel	Frequency
102	5510 MHz	126	5630 MHz
110	5550 MHz	134	5670 MHz
118	5590 MHz	142	5710 MHz

3 channels are provided for 802.11ac (VHT80):

Channel	Frequency	Channel	Frequency
106	5530 MHz	122	5610 MHz
138	5690 MHz		

3.2.1 Test Mode Applicability and Tested Channel Detail

EUT Configure Mode	Applicable To				Description
	RE \geq 1G	RE $<$ 1G	PLC	APCM	
1	√	√	√	√	3TX Mode
2	√	-	-	√	2TX Mode
3	√	-	-	√	1TX Mode

Where **RE \geq 1G**: Radiated Emission above 1GHz **RE $<$ 1G**: Radiated Emission below 1GHz
PLC: Power Line Conducted Emission **APCM**: Antenna Port Conducted Measurement

NOTE:

1. The EUT had been pre-tested on the positioned of each 2 axis. The worst case was found when positioned on **X-plane**.
2. "-" means no effect.

Radiated Emission Test (Above 1GHz):

- Pre-Scan has been conducted to determine the worst-case mode from all possible combinations between available modulations, data rates and antenna ports (if EUT with antenna diversity architecture).
- Following channel(s) was (were) selected for the final test as listed below.

CDD Mode						
Mode	FREQ. Band (MHz)	Available Channel	Tested Channel	Modulation Technology	Modulation Type	Data Rate (Mbps)
802.11a	5260-5320	52 to 64	52, 60, 64	OFDM	BPSK	6
802.11ac (VHT20)		52 to 64	52, 60, 64	OFDM	BPSK	6.5
802.11ac (VHT40)		54 to 62	54, 62	OFDM	BPSK	13.5
802.11ac (VHT80)		58	58	OFDM	BPSK	29.3
802.11a	5500-5720	100 to 144	100, 116, 140, 144	OFDM	BPSK	6
802.11ac (VHT20)		100 to 144	100, 116, 140, 144	OFDM	BPSK	6.5
802.11ac (VHT40)		102 to 142	102, 110, 134, 142	OFDM	BPSK	13.5
802.11ac (VHT80)		106 to 138	106, 122, 138	OFDM	BPSK	29.3

Radiated Emission Test (Below 1GHz):

- Pre-Scan has been conducted to determine the worst-case mode from all possible combinations between available modulations, data rates and antenna ports (if EUT with antenna diversity architecture).
- Following channel(s) was (were) selected for the final test as listed below.

CDD Mode						
Mode	FREQ. Band (MHz)	Available Channel	Tested Channel	Modulation Technology	Modulation Type	Data Rate (Mbps)
802.11ac (VHT40)	5260-5320 5500-5720	54 to 62 102 to 142	54	OFDM	BPSK	13.5

Power Line Conducted Emission Test:

- Pre-Scan has been conducted to determine the worst-case mode from all possible combinations between available modulations, data rates and antenna ports (if EUT with antenna diversity architecture).
- Following channel(s) was (were) selected for the final test as listed below.

CDD Mode						
Mode	FREQ. Band (MHz)	Available Channel	Tested Channel	Modulation Technology	Modulation Type	Data Rate (Mbps)
802.11ac (VHT40)	5260-5320 5500-5720	54 to 62 102 to 142	54	OFDM	BPSK	13.5

Antenna Port Conducted Measurement:

- This item includes all test value of each mode, but only includes spectrum plot of worst value of each mode.
- Pre-Scan has been conducted to determine the worst-case mode from all possible combinations between available modulations, data rates and antenna ports (if EUT with antenna diversity architecture).
- Following channel(s) was (were) selected for the final test as listed below.

CDD Mode						
Mode	FREQ. Band (MHz)	Available Channel	Tested Channel	Modulation Technology	Modulation Type	Data Rate (Mbps)
802.11a	5260-5320	52 to 64	52, 60, 64	OFDM	BPSK	6
802.11ac (VHT20)		52 to 64	52, 60, 64	OFDM	BPSK	6.5
802.11ac (VHT40)		54 to 62	54, 62	OFDM	BPSK	13.5
802.11ac (VHT80)		58	58	OFDM	BPSK	29.3
802.11a	5500-5720	100 to 144	100, 116, 140, 144	OFDM	BPSK	6
802.11ac (VHT20)		100 to 144	100, 116, 140, 144	OFDM	BPSK	6.5
802.11ac (VHT40)		102 to 142	102, 110, 134, 142	OFDM	BPSK	13.5
802.11ac (VHT80)		106 to 138	106, 122, 138	OFDM	BPSK	29.3
Beamforming Mode (Output power only)						
Mode	FREQ. Band (MHz)	Available Channel	Tested Channel	Modulation Technology	Modulation Type	Data Rate (Mbps)
802.11ac (VHT20)	5260-5320	52 to 64	52, 60, 64	OFDM	BPSK	6.5
802.11ac (VHT40)		54 to 62	54, 62	OFDM	BPSK	13.5
802.11ac (VHT80)		58	58	OFDM	BPSK	29.3
802.11ac (VHT20)	5500-5720	100 to 144	100, 116, 140, 144	OFDM	BPSK	6.5
802.11ac (VHT40)		102 to 142	102, 110, 134, 142	OFDM	BPSK	13.5
802.11ac (VHT80)		106 to 138	106, 122, 138	OFDM	BPSK	29.3

Test Condition:

Applicable To	Environmental Conditions	Input Power (system)	Tested By
RE \geq 1G	21deg. C, 65%RH	120Vac, 60Hz	Weiwei Lo
RE $<$ 1G	23deg. C, 69%RH	120Vac, 60Hz	Weiwei Lo
PLC	25deg. C, 68%RH	120Vac, 60Hz	Andy Ho
APCM	25deg. C, 60%RH	120Vac, 60Hz	Robert Cheng

3.3 Duty Cycle of Test Signal

If duty cycle of test signal is $\geq 98\%$, duty factor is not required.

If duty cycle of test signal is $< 98\%$, duty factor shall be considered.

802.11a: Duty cycle = $2.027 \text{ ms} / 2.094 \text{ ms} = 0.968$, Duty factor = $10 * \log(1/0.968) = 0.14$

802.11ac (VHT20): Duty cycle = $4.967 \text{ ms} / 5.054 \text{ ms} = 0.983$

802.11ac (VHT40): Duty cycle = $2.414 \text{ ms} / 2.49 \text{ ms} = 0.969$, Duty factor = $10 * \log(1/0.969) = 0.13$

802.11ac (VHT80): Duty cycle = $1.144 \text{ ms} / 1.208 \text{ ms} = 0.947$, Duty factor = $10 * \log(1/0.947) = 0.24$

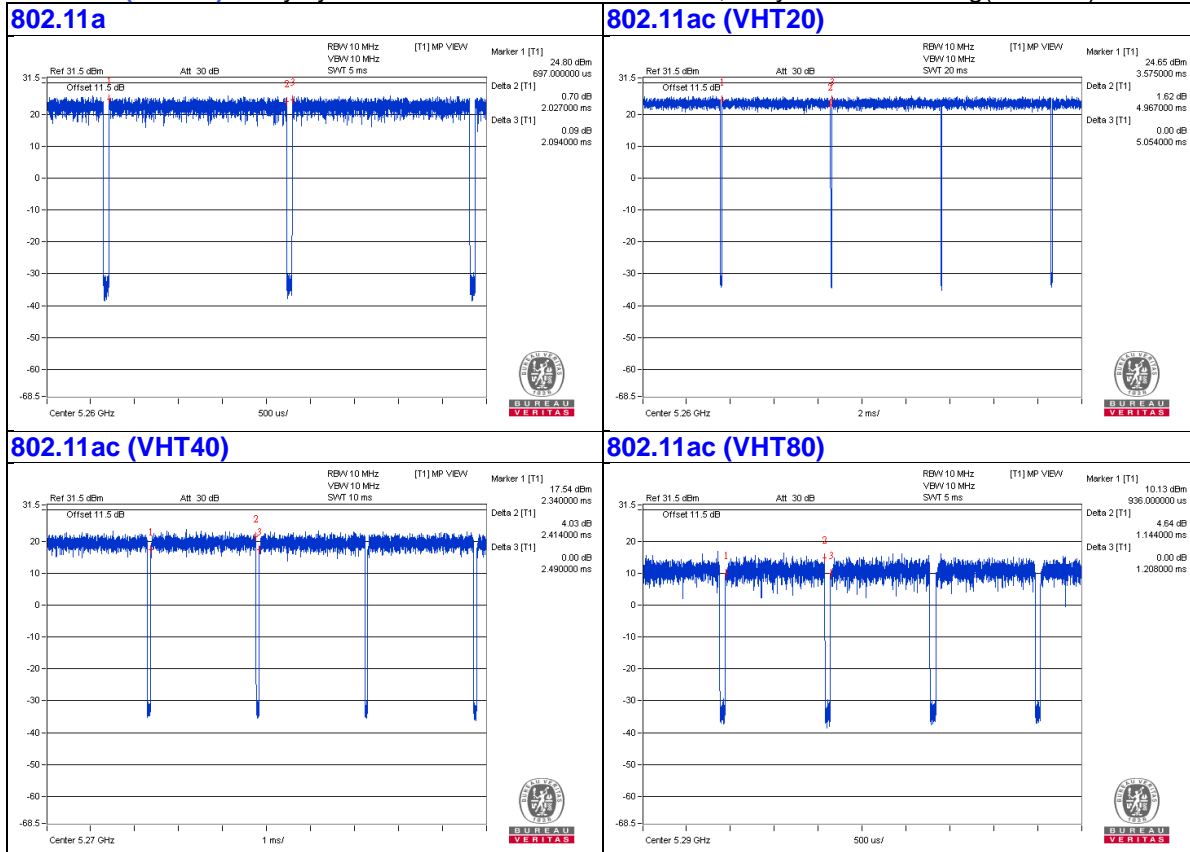

3.4 Description of Support Units

The EUT has been tested as an independent unit together with other necessary accessories or support units. The following support units or accessories were used to form a representative test configuration during the tests.

ID	Product	Brand	Model No.	Serial No.	FCC ID	Remarks
A.	Laptop	DELL	E5430	HYV4VY1	FCC DoC	Provided by Lab
B.	POE	PowerDsine	PD-9001GR/AC	NA	NA	Supplied by client
C.	Laptop	LENOVO	E440	PF071LWC	NA	Provided by Lab

Note:

1. All power cords of the above support units are non-shielded (1.8m).

ID	Descriptions	Qty.	Length (m)	Shielding (Yes/No)	Cores (Qty.)	Remarks
1.	RJ-45 Cable	1	10	No	0	Provided by Lab
2.	RJ-45 Cable	1	10	No	0	Provided by Lab
3.	RJ-45 Cable	1	3	No	0	Provided by Lab
4.	Console Cable	1	3	No	0	Provided by Lab

3.4.1 Configuration of System under Test

For Conducted Emission:

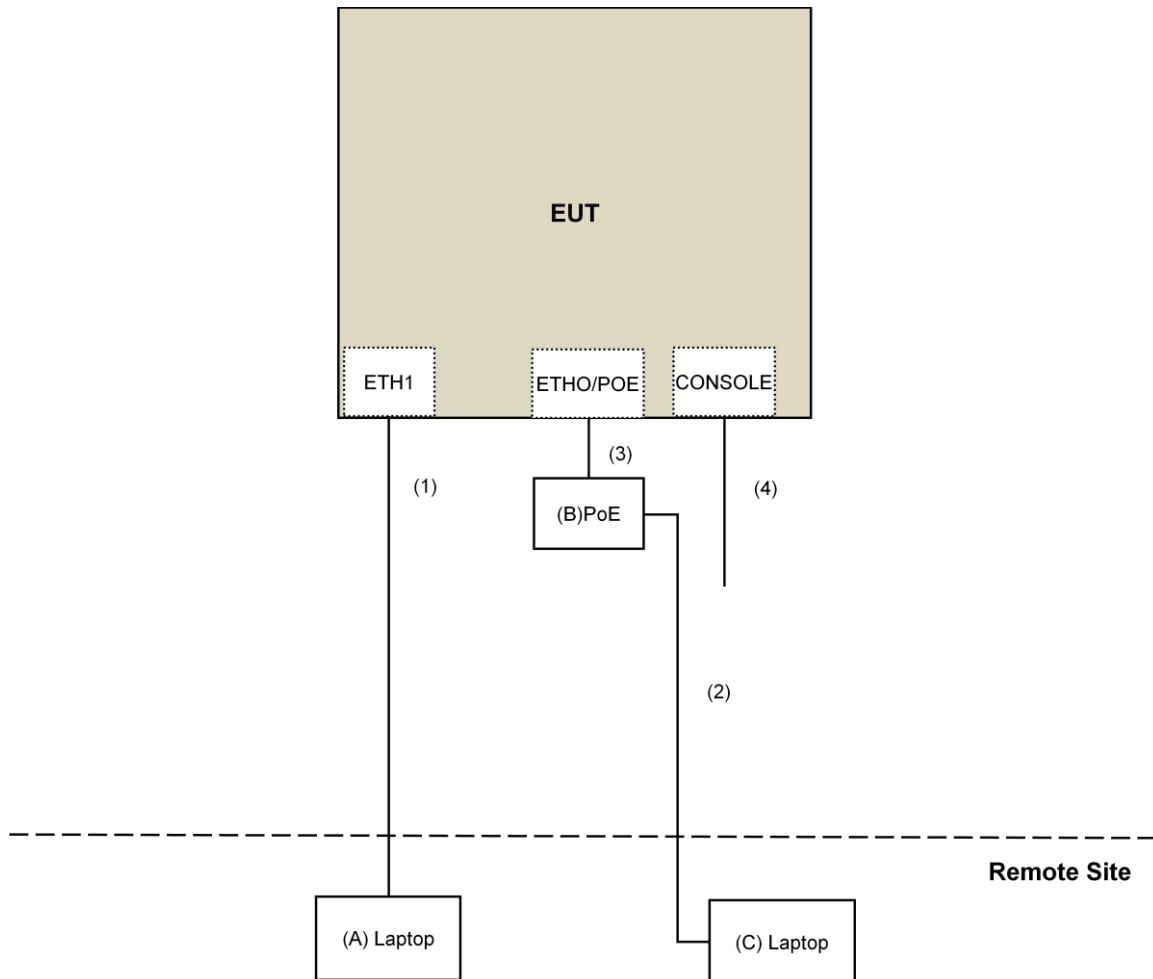

For other test:

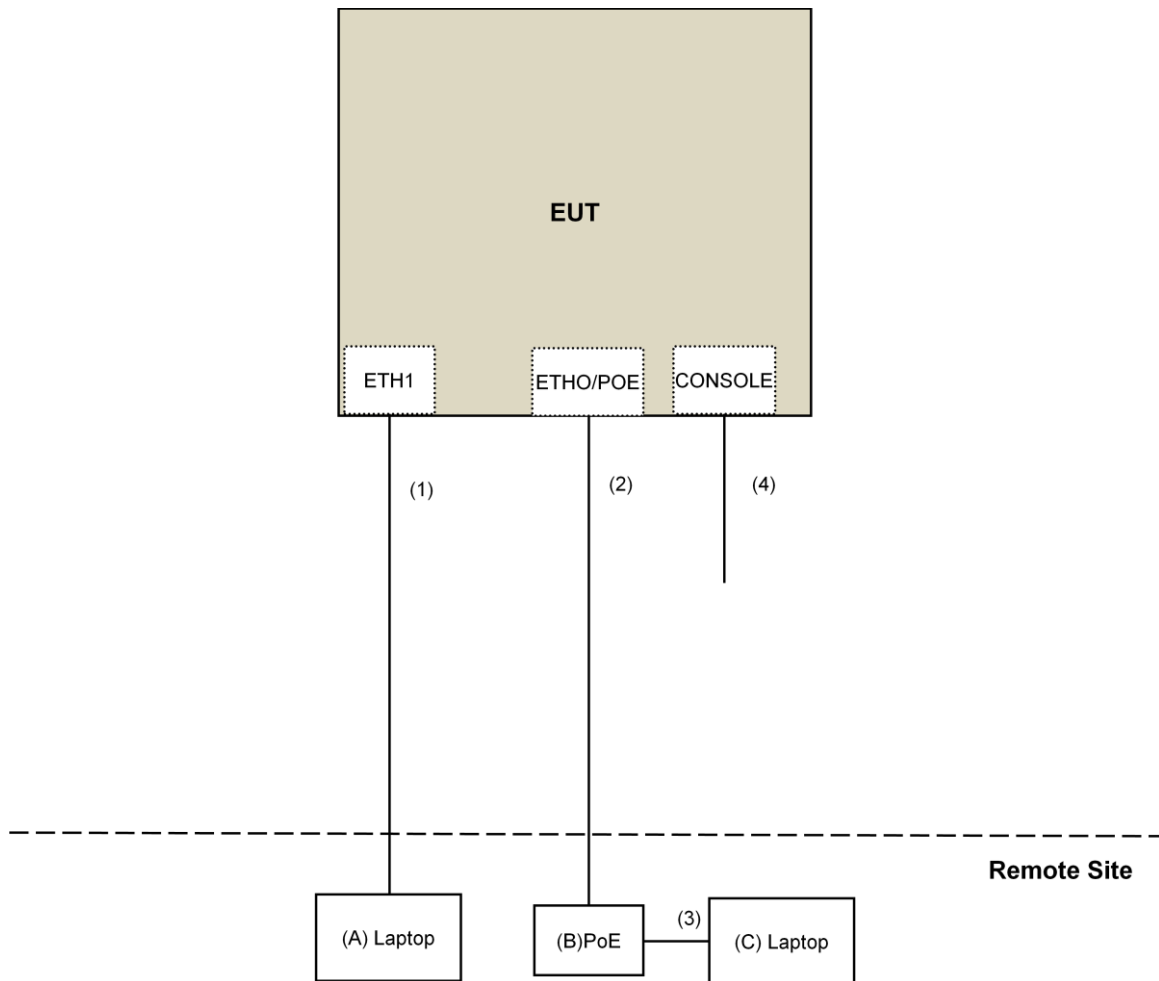

3.5 General Description of Applied Standard

The EUT is a RF Product. According to the specifications of the manufacturer, it must comply with the requirements of the following standards:

FCC Part 15, Subpart E (15.407)
KDB 789033 D02 General UNII Test Procedure New Rules v01r04
KDB 662911 D01 Multiple Transmitter Output v02r01
ANSI C63.10-2013

All test items have been performed and recorded as per the above standards.

NOTE: The EUT has been verified to comply with the requirements of FCC Part 15, Subpart B, Class B (DoC). The test report has been issued separately.

4 Test Types and Results

4.1 Radiated Emission and Bandedge Measurement

4.1.1 Limits of Radiated Emission and Bandedge Measurement

Radiated emissions which fall in the restricted bands must comply with the radiated emission limits specified as below table.

Frequencies (MHz)	Field Strength (microvolts/meter)	Measurement Distance (meters)
0.009 ~ 0.490	2400/F(kHz)	300
0.490 ~ 1.705	24000/F(kHz)	30
1.705 ~ 30.0	30	30
30 ~ 88	100	3
88 ~ 216	150	3
216 ~ 960	200	3
Above 960	500	3

NOTE:

- The lower limit shall apply at the transition frequencies.
- Emission level (dBuV/m) = 20 log Emission level (uV/m).
- For frequencies above 1000MHz, the field strength limits are based on average detector, however, the peak field strength of any emission shall not exceed the maximum permitted average limits, specified above by more than 20dB under any condition of modulation.

Limits of unwanted emission out of the restricted bands

Applicable To		Limit	
789033 D02 General UNII Test Procedure New Rules v01r04		Field Strength at 3m	
		PK:74 (dBµV/m)	AV:54 (dBµV/m)
Frequency Band	Applicable To	EIRP Limit	Equivalent Field Strength at 3m
5150~5250 MHz	15.407(b)(1)	PK:-27 (dBm/MHz)	PK:68.2(dBµV/m)
5250~5350 MHz	15.407(b)(2)		
5470~5725 MHz	15.407(b)(3)		
5725~5850 MHz	<input checked="" type="checkbox"/> 15.407(b)(4)(i)	PK:-27 (dBm/MHz) ^{*1} PK:10 (dBm/MHz) ^{*2} PK:15.6 (dBm/MHz) ^{*3} PK:27 (dBm/MHz) ^{*4}	PK: 68.2(dBµV/m) ^{*1} PK:105.2 (dBµV/m) ^{*2} PK: 110.8(dBµV/m) ^{*3} PK:122.2 (dBµV/m) ^{*4}
	<input type="checkbox"/> 15.407(b)(4)(ii)	Emission limits in section 15.247(d)	
^{*1} beyond 75 MHz or more above of the band edge.		^{*2} below the band edge increasing linearly to 10 dBm/MHz at 25 MHz above.	
^{*3} below the band edge increasing linearly to a level of 15.6 dBm/MHz at 5 MHz above.		^{*4} from 5 MHz above or below the band edge increasing linearly to a level of 27 dBm/MHz at the band edge.	

Note:

The following formula is used to convert the equipment isotropic radiated power (eirp) to field strength:

$$E = \frac{1000000\sqrt{30P}}{3} \mu\text{V/m, where } P \text{ is the eirp (Watts).}$$

4.1.2 Test Instruments

For below 1GHz test:

DESCRIPTION & MANUFACTURER	MODEL NO.	SERIAL NO.	CALIBRATED DATE	CALIBRATED UNTIL
Test Receiver Agilent	N9038A	MY50010156	Aug. 18, 2016	Aug. 17, 2017
Pre-Amplifier ^(*) EMCI	EMC001340	980142	Jan. 20, 2016	Jan. 19, 2018
Loop Antenna ^(*) Electro-Metrics	EM-6879	264	Dec. 16, 2016	Dec. 15, 2018
RF Cable	NA	LOOPCAB-001 LOOPCAB-002	Jan. 17, 2017	Jan. 16, 2018
Pre-Amplifier Mini-Circuits	ZFL-1000VH2 B	AMP-ZFL-05	May 06, 2017	May 05, 2018
Trilog Broadband Antenna SCHWARZBECK	VULB 9168	9168-361	Dec. 29, 2016	Dec. 28, 2017
RF Cable	8D	966-3-1 966-3-2 966-3-3	Apr. 01, 2017	Mar. 31, 2018
Fixed attenuator Mini-Circuits	UNAT-5+	PAD-3m-3-01	Oct. 05, 2016	Oct. 04, 2017
Software	ADT_Radiated _V8.7.08	NA	NA	NA
Antenna Tower & Turn Table Max-Full	MF-7802	MF780208406	NA	NA

Note:

1. The calibration interval of the above test instruments is 12 months and the calibrations are traceable to NML/ROC and NIST/USA.
2. *The calibration interval of the above test instruments is 24 months and the calibrations are traceable to NML/ROC and NIST/USA.
3. The test was performed in 966 Chamber No. 3.
4. The CANADA Site Registration No. is 20331-1
5. Loop antenna was used for all emissions below 30 MHz.
6. Tested Date: June 28, 2017

For other test:

DESCRIPTION & MANUFACTURER	MODEL NO.	SERIAL NO.	CALIBRATED DATE	CALIBRATED UNTIL
Test Receiver Agilent	N9038A	MY50010156	Aug. 18, 2016	Aug. 17, 2017
Horn_Antenna SCHWARZBECK	BBHA9120-D	9120D-406	Dec. 28, 2016	Dec. 27, 2017
Pre-Amplifier EMCI	EMC12630SE	980384	Feb. 02, 2017	Feb. 01, 2018
RF Cable	EMC104-SM- SM-1200 EMC104-SM- SM-2000 EMC104-SM- SM-5000	160922 150317 150322	Feb. 02, 2017 Mar. 29, 2017 Mar. 29, 2017	Feb. 01, 2018 Mar. 28, 2018 Mar. 28, 2018
Spectrum Analyzer Keysight	N9030A	MY54490520	July 29, 2016	July 28, 2017
Pre-Amplifier EMCI	EMC184045S E	980386	Feb. 02, 2017	Feb. 01, 2018
Horn_Antenna SCHWARZBECK	BBHA 9170	BBHA9170608	Dec. 15, 2016	Dec. 14, 2017
RF Cable	SUCOFLEX 102	36432/2 36433/2	Jan. 15, 2017	Jan. 14, 2018
Software	ADT_Radiated _V8.7.08	NA	NA	NA
Antenna Tower & Turn Table Max-Full	MF-7802	MF780208406	NA	NA
Boresight Antenna Fixture	FBA-01	FBA-SIP01	NA	NA
Spectrum Analyzer R&S	FSV40	100964	July 1, 2017	June 30, 2018
Power meter Anritsu	ML2495A	1014008	May 11, 2017	May 10, 2018
Power sensor Anritsu	MA2411B	0917122	May 11, 2017	May 10, 2018
Temperature & Humidity Chamber Giant Force	GTH-150-40-S P-AR	MAA0812-008	Jan. 11, 2017	Jan. 10, 2018
AC Power Source Extech Electronics	6205	1440452	NA	NA
Digital Multimeter FLUKE	87III	73680266	Nov. 10, 2016	Nov. 09, 2017

Note:

1. The calibration interval of the above test instruments is 12 months and the calibrations are traceable to NML/ROC and NIST/USA.
2. The test was performed in 966 Chamber No. 3.
3. The CANADA Site Registration No. is 20331-1
4. Tested Date: July 11 to 20, 2017

4.1.3 Test Procedure

For Radiated emission below 30MHz

- a. The EUT was placed on the top of a rotating table 0.8 meters above the ground at a 3 meter chamber room. The table was rotated 360 degrees to determine the position of the highest radiation.
- b. The EUT was set 3 meters away from the interference-receiving antenna, which was mounted on the top of a variable-height antenna tower.
- c. Both X and Y axes of the antenna are set to make the measurement.
- d. For each suspected emission, the EUT was arranged to its worst case and the rotatable table was turned from 0 degrees to 360 degrees to find the maximum reading.
- e. The test-receiver system was set to Quasi-Peak Detect Function and Specified Bandwidth with Maximum Hold Mode.

NOTE:

1. The resolution bandwidth and video bandwidth of test receiver/spectrum analyzer is 9kHz at frequency below 30MHz.

For Radiated emission above 30MHz

- a. The EUT was placed on the top of a rotating table 0.8 meters (for 30MHz ~ 1GHz) / 1.5 meters (for above 1GHz) above the ground at 3 meter chamber room for test. The table was rotated 360 degrees to determine the position of the highest radiation.
- b. The EUT was set 3 meters away from the interference-receiving antenna, which was mounted on the top of a variable-height antenna tower.
- c. The height of antenna is varied from one meter to four meters above the ground to determine the maximum value of the field strength. Both horizontal and vertical polarizations of the antenna are set to make the measurement.
- d. For each suspected emission, the EUT was arranged to its worst case and then the antenna was tuned to heights from 1 meter to 4 meters and the rotatable table was turned from 0 degrees to 360 degrees to find the maximum reading.
- e. The test-receiver system was set to quasi-peak detect function and specified bandwidth with maximum hold mode when the test frequency is below 1 GHz.
- f. The test-receiver system was set to peak and average detect function and specified bandwidth with maximum hold mode when the test frequency is above 1 GHz. If the peak reading value also meets average limit, measurement with the average detector is unnecessary.

Note:

1. The resolution bandwidth and video bandwidth of test receiver/spectrum analyzer is 120kHz for Quasi-peak detection (QP) at frequency below 1GHz.
2. The resolution bandwidth of test receiver/spectrum analyzer is 1 MHz and the video bandwidth is 3 MHz for Peak detection (PK) at frequency above 1GHz.
3. The resolution bandwidth of test receiver/spectrum analyzer is 1MHz and the video bandwidth is $\geq 1/T$ (Duty cycle < 98%) or 10Hz (Duty cycle $\geq 98\%$) for Average detection (AV) at frequency above 1GHz.
4. All modes of operation were investigated and the worst-case emissions are reported.

4.1.4 Deviation from Test Standard

No deviation.

4.1.5 Test Setup

For Radiated emission below 30MHz

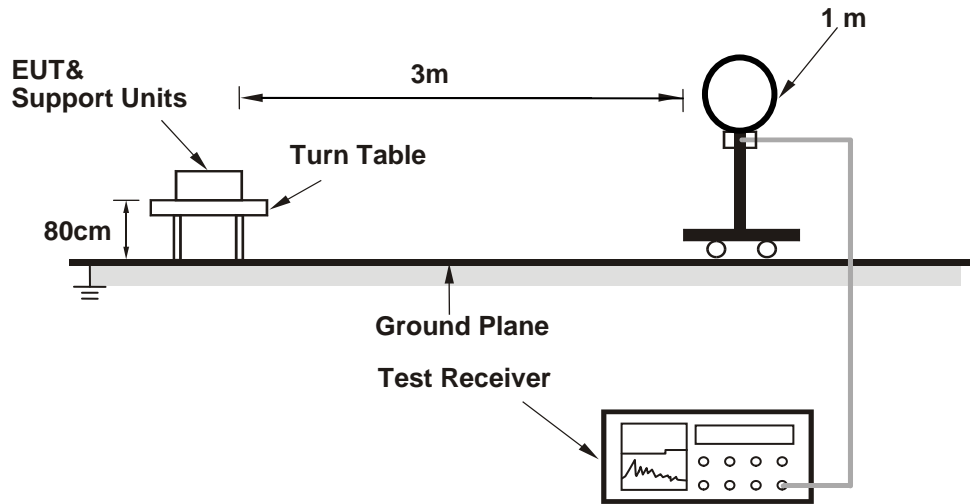

For Radiated emission 30MHz to 1GHz

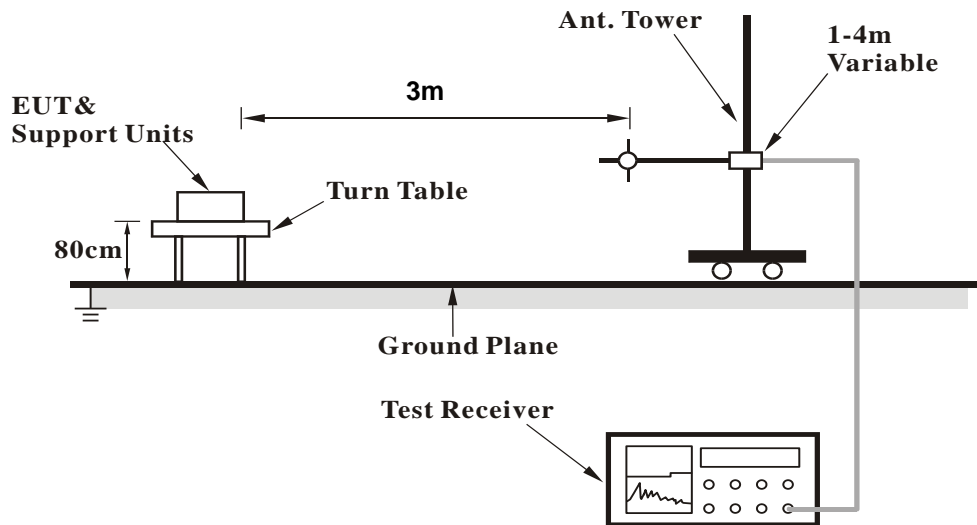

For Radiated emission above 1GHz

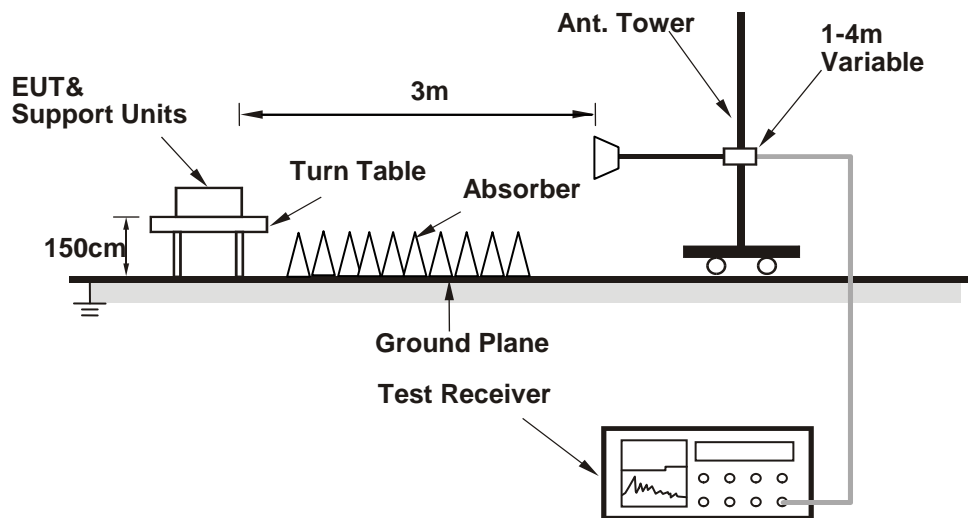

For the actual test configuration, please refer to the attached file (Test Setup Photo).

4.1.6 EUT Operating Condition

- a. Connected the EUT with the Laptop which is placed on remote site.
- b. Controlling software (QDART-Connectivity100039.exe) has been activated to set the EUT on specific status.

4.1.7 Test Results (Mode 1)

Above 1GHz Data:

802.11a

CHANNEL	TX Channel 52	DETECTOR FUNCTION	Peak (PK)
FREQUENCY RANGE	1GHz ~ 40GHz		Average (AV)

ANTENNA POLARITY & TEST DISTANCE: HORIZONTAL AT 3 M

NO.	FREQ. (MHz)	EMISSION LEVEL (dBuV/m)	LIMIT (dBuV/m)	MARGIN (dB)	ANTENNA HEIGHT (m)	TABLE ANGLE (Degree)	RAW VALUE (dBuV)	CORRECTION FACTOR (dB/m)
1	5150.00	44.1 PK	74.0	-29.9	1.30 H	160	40.4	3.7
2	5150.00	33.6 AV	54.0	-20.4	1.30 H	160	29.9	3.7
3	*5260.00	118.7 PK			1.30 H	160	114.7	4.0
4	*5260.00	109.1 AV			1.30 H	160	105.1	4.0
5	#10520.00	50.2 PK	74.0	-23.8	1.84 H	221	37.0	13.2
6	#10520.00	37.9 AV	54.0	-16.1	1.84 H	221	24.7	13.2
7	15780.00	43.1 PK	74.0	-30.9	2.11 H	351	29.5	13.6
8	15780.00	31.9 AV	54.0	-22.1	2.11 H	351	18.3	13.6

ANTENNA POLARITY & TEST DISTANCE: VERTICAL AT 3 M

NO.	FREQ. (MHz)	EMISSION LEVEL (dBuV/m)	LIMIT (dBuV/m)	MARGIN (dB)	ANTENNA HEIGHT (m)	TABLE ANGLE (Degree)	RAW VALUE (dBuV)	CORRECTION FACTOR (dB/m)
1	5150.00	49.2 PK	74.0	-24.8	2.70 V	326	45.5	3.7
2	5150.00	39.2 AV	54.0	-14.8	2.70 V	326	35.5	3.7
3	*5260.00	122.3 PK			2.70 V	326	118.3	4.0
4	*5260.00	112.2 AV			2.70 V	326	108.2	4.0
5	#10520.00	49.7 PK	74.0	-24.3	2.18 V	223	36.5	13.2
6	#10520.00	38.1 AV	54.0	-15.9	2.18 V	223	24.9	13.2
7	15780.00	43.5 PK	74.0	-30.5	1.83 V	297	29.9	13.6
8	15780.00	32.4 AV	54.0	-21.6	1.83 V	297	18.8	13.6

REMARKS:

- Emission Level(dBuV/m) = Raw Value(dBuV) + Correction Factor(dB/m)
- Correction Factor(dB/m) = Antenna Factor(dB/m) + Cable Factor(dB) – Pre-Amplifier Factor(dB)
- The other emission levels were very low against the limit.
- Margin value = Emission Level – Limit value
- " * ": Fundamental frequency.
- " # ": The radiated frequency is out of the restricted band.

CHANNEL	TX Channel 60	DETECTOR FUNCTION	Peak (PK)
FREQUENCY RANGE	1GHz ~ 40GHz		Average (AV)

ANTENNA POLARITY & TEST DISTANCE: HORIZONTAL AT 3 M

NO.	FREQ. (MHz)	EMISSION LEVEL (dBuV/m)	LIMIT (dBuV/m)	MARGIN (dB)	ANTENNA HEIGHT (m)	TABLE ANGLE (Degree)	RAW VALUE (dBuV)	CORRECTION FACTOR (dB/m)
1	5150.00	44.7 PK	74.0	-29.3	1.38 H	145	41.0	3.7
2	5150.00	34.4 AV	54.0	-19.6	1.38 H	145	30.7	3.7
3	*5300.00	118.3 PK			1.38 H	145	114.2	4.1
4	*5300.00	108.8 AV			1.38 H	145	104.7	4.1
5	5350.00	63.7 PK	74.0	-10.3	1.38 H	145	59.6	4.1
6	5350.00	52.2 AV	54.0	-1.8	1.38 H	145	48.1	4.1
7	10600.00	49.9 PK	74.0	-24.1	1.93 H	226	36.4	13.5
8	10600.00	37.5 AV	54.0	-16.5	1.93 H	226	24.0	13.5
9	15900.00	44.2 PK	74.0	-29.8	2.13 H	332	31.3	12.9
10	15900.00	32.7 AV	54.0	-21.3	2.13 H	332	19.8	12.9

ANTENNA POLARITY & TEST DISTANCE: VERTICAL AT 3 M

NO.	FREQ. (MHz)	EMISSION LEVEL (dBuV/m)	LIMIT (dBuV/m)	MARGIN (dB)	ANTENNA HEIGHT (m)	TABLE ANGLE (Degree)	RAW VALUE (dBuV)	CORRECTION FACTOR (dB/m)
1	5150.00	48.5 PK	74.0	-25.5	2.57 V	329	44.8	3.7
2	5150.00	38.7 AV	54.0	-15.3	2.57 V	329	35.0	3.7
3	*5300.00	122.1 PK			2.57 V	329	118.0	4.1
4	*5300.00	111.6 AV			2.57 V	329	107.5	4.1
5	5350.00	66.5 PK	74.0	-7.5	2.57 V	329	62.4	4.1
6	5350.00	53.3 AV	54.0	-0.7	2.57 V	329	49.2	4.1
7	10600.00	49.4 PK	74.0	-24.6	2.15 V	214	35.9	13.5
8	10600.00	37.9 AV	54.0	-16.1	2.15 V	214	24.4	13.5
9	15900.00	44.7 PK	74.0	-29.3	1.76 V	308	31.8	12.9
10	15900.00	33.0 AV	54.0	-21.0	1.76 V	308	20.1	12.9

REMARKS:

1. Emission Level(dBuV/m) = Raw Value(dBuV) + Correction Factor(dB/m)
2. Correction Factor(dB/m) = Antenna Factor(dB/m) + Cable Factor(dB) – Pre-Amplifier Factor(dB)
3. The other emission levels were very low against the limit.
4. Margin value = Emission Level – Limit value
5. " * ": Fundamental frequency.

CHANNEL	TX Channel 64	DETECTOR FUNCTION	Peak (PK)
FREQUENCY RANGE	1GHz ~ 40GHz		Average (AV)

ANTENNA POLARITY & TEST DISTANCE: HORIZONTAL AT 3 M

NO.	FREQ. (MHz)	EMISSION LEVEL (dBuV/m)	LIMIT (dBuV/m)	MARGIN (dB)	ANTENNA HEIGHT (m)	TABLE ANGLE (Degree)	RAW VALUE (dBuV)	CORRECTION FACTOR (dB/m)
1	*5320.00	115.1 PK			1.36 H	158	111.0	4.1
2	*5320.00	105.2 AV			1.36 H	158	101.1	4.1
3	5350.00	62.9 PK	74.0	-11.1	1.36 H	158	58.8	4.1
4	5350.00	51.4 AV	54.0	-2.6	1.36 H	158	47.3	4.1
5	10640.00	50.0 PK	74.0	-24.0	1.90 H	207	36.5	13.5
6	10640.00	38.0 AV	54.0	-16.0	1.90 H	207	24.5	13.5
7	15960.00	43.9 PK	74.0	-30.1	2.08 H	357	31.0	12.9
8	15960.00	32.4 AV	54.0	-21.6	2.08 H	357	19.5	12.9

ANTENNA POLARITY & TEST DISTANCE: VERTICAL AT 3 M

NO.	FREQ. (MHz)	EMISSION LEVEL (dBuV/m)	LIMIT (dBuV/m)	MARGIN (dB)	ANTENNA HEIGHT (m)	TABLE ANGLE (Degree)	RAW VALUE (dBuV)	CORRECTION FACTOR (dB/m)
1	*5320.00	118.6 PK			2.54 V	329	114.5	4.1
2	*5320.00	108.5 AV			2.54 V	329	104.4	4.1
3	5350.00	67.2 PK	74.0	-6.8	2.54 V	329	63.1	4.1
4	5350.00	53.9 AV	54.0	-0.1	2.54 V	329	49.8	4.1
5	10640.00	49.8 PK	74.0	-24.2	2.19 V	230	36.3	13.5
6	10640.00	38.1 AV	54.0	-15.9	2.19 V	230	24.6	13.5
7	15960.00	43.9 PK	74.0	-30.1	1.85 V	297	31.0	12.9
8	15960.00	32.7 AV	54.0	-21.3	1.85 V	297	19.8	12.9

REMARKS:

1. Emission Level(dBuV/m) = Raw Value(dBuV) + Correction Factor(dB/m)
2. Correction Factor(dB/m) = Antenna Factor(dB/m) + Cable Factor(dB) – Pre-Amplifier Factor(dB)
3. The other emission levels were very low against the limit.
4. Margin value = Emission Level – Limit value
5. " * ": Fundamental frequency.

CHANNEL	TX Channel 100	DETECTOR FUNCTION	Peak (PK)
FREQUENCY RANGE	1GHz ~ 40GHz		Average (AV)

ANTENNA POLARITY & TEST DISTANCE: HORIZONTAL AT 3 M

NO.	FREQ. (MHz)	EMISSION LEVEL (dBuV/m)	LIMIT (dBuV/m)	MARGIN (dB)	ANTENNA HEIGHT (m)	TABLE ANGLE (Degree)	RAW VALUE (dBuV)	CORRECTION FACTOR (dB/m)
1	#5470.00	62.8 PK	74.0	-11.2	1.35 H	164	58.6	4.2
2	#5470.00	51.6 AV	54.0	-2.4	1.35 H	164	47.4	4.2
3	*5500.00	114.8 PK			1.35 H	164	110.6	4.2
4	*5500.00	104.9 AV			1.35 H	164	100.7	4.2
5	11000.00	50.0 PK	74.0	-24.0	1.92 H	229	35.9	14.1
6	11000.00	38.1 AV	54.0	-15.9	1.92 H	229	24.0	14.1
7	#16500.00	43.6 PK	74.0	-30.4	2.12 H	349	29.1	14.5
8	#16500.00	32.3 AV	54.0	-21.7	2.12 H	349	17.8	14.5

ANTENNA POLARITY & TEST DISTANCE: VERTICAL AT 3 M

NO.	FREQ. (MHz)	EMISSION LEVEL (dBuV/m)	LIMIT (dBuV/m)	MARGIN (dB)	ANTENNA HEIGHT (m)	TABLE ANGLE (Degree)	RAW VALUE (dBuV)	CORRECTION FACTOR (dB/m)
1	#5470.00	68.5 PK	74.0	-5.5	2.56 V	328	64.3	4.2
2	#5470.00	53.6 AV	54.0	-0.4	2.56 V	328	49.4	4.2
3	*5500.00	117.9 PK			2.56 V	328	113.7	4.2
4	*5500.00	107.8 AV			2.56 V	328	103.6	4.2
5	11000.00	49.5 PK	74.0	-24.5	2.21 V	236	35.4	14.1
6	11000.00	38.1 AV	54.0	-15.9	2.21 V	236	24.0	14.1
7	#16500.00	44.0 PK	74.0	-30.0	1.87 V	297	29.5	14.5
8	#16500.00	32.8 AV	54.0	-21.2	1.87 V	297	18.3	14.5

REMARKS:

1. Emission Level(dBuV/m) = Raw Value(dBuV) + Correction Factor(dB/m)
2. Correction Factor(dB/m) = Antenna Factor(dB/m) + Cable Factor(dB) – Pre-Amplifier Factor(dB)
3. The other emission levels were very low against the limit.
4. Margin value = Emission Level – Limit value
5. " * ": Fundamental frequency.
6. " # ": The radiated frequency is out of the restricted band.

CHANNEL	TX Channel 116	DETECTOR FUNCTION	Peak (PK)
FREQUENCY RANGE	1GHz ~ 40GHz		Average (AV)

ANTENNA POLARITY & TEST DISTANCE: HORIZONTAL AT 3 M

NO.	FREQ. (MHz)	EMISSION LEVEL (dBuV/m)	LIMIT (dBuV/m)	MARGIN (dB)	ANTENNA HEIGHT (m)	TABLE ANGLE (Degree)	RAW VALUE (dBuV)	CORRECTION FACTOR (dB/m)
1	#5470.00	51.0 PK	74.0	-23.0	1.32 H	167	46.8	4.2
2	#5470.00	39.2 AV	54.0	-14.8	1.32 H	167	35.0	4.2
3	*5580.00	116.2 PK			1.32 H	167	112.0	4.2
4	*5580.00	107.5 AV			1.32 H	167	103.3	4.2
5	#5960.00	46.4 PK	74.0	-27.6	1.32 H	167	41.7	4.7
6	#5960.00	35.7 AV	54.0	-18.3	1.32 H	167	31.0	4.7
7	11160.00	50.6 PK	74.0	-23.4	1.83 H	223	36.9	13.7
8	11160.00	38.4 AV	54.0	-15.6	1.83 H	223	24.7	13.7
9	#16740.00	43.1 PK	74.0	-30.9	2.11 H	347	27.4	15.7
10	#16740.00	31.8 AV	54.0	-22.2	2.11 H	347	16.1	15.7

ANTENNA POLARITY & TEST DISTANCE: VERTICAL AT 3 M

NO.	FREQ. (MHz)	EMISSION LEVEL (dBuV/m)	LIMIT (dBuV/m)	MARGIN (dB)	ANTENNA HEIGHT (m)	TABLE ANGLE (Degree)	RAW VALUE (dBuV)	CORRECTION FACTOR (dB/m)
1	#5470.00	59.2 PK	74.0	-14.8	2.52 V	324	55.0	4.2
2	#5470.00	44.2 AV	54.0	-9.8	2.52 V	324	40.0	4.2
3	*5580.00	120.4 PK			2.52 V	324	116.2	4.2
4	*5580.00	110.6 AV			2.52 V	324	106.4	4.2
5	#5960.00	50.1 PK	74.0	-23.9	2.52 V	325	45.4	4.7
6	#5960.00	39.9 AV	54.0	-14.1	2.52 V	325	35.2	4.7
7	11160.00	50.2 PK	74.0	-23.8	2.16 V	226	36.5	13.7
8	11160.00	38.6 AV	54.0	-15.4	2.16 V	226	24.9	13.7
9	#16740.00	44.2 PK	74.0	-29.8	1.84 V	305	28.5	15.7
10	#16740.00	33.0 AV	54.0	-21.0	1.84 V	305	17.3	15.7

REMARKS:

1. Emission Level(dBuV/m) = Raw Value(dBuV) + Correction Factor(dB/m)
2. Correction Factor(dB/m) = Antenna Factor(dB/m) + Cable Factor(dB) – Pre-Amplifier Factor(dB)
3. The other emission levels were very low against the limit.
4. Margin value = Emission Level – Limit value
5. " * ": Fundamental frequency.
6. " # ": The radiated frequency is out of the restricted band.

CHANNEL	TX Channel 140	DETECTOR FUNCTION	Peak (PK)
FREQUENCY RANGE	1GHz ~ 40GHz		Average (AV)

ANTENNA POLARITY & TEST DISTANCE: HORIZONTAL AT 3 M

NO.	FREQ. (MHz)	EMISSION LEVEL (dBuV/m)	LIMIT (dBuV/m)	MARGIN (dB)	ANTENNA HEIGHT (m)	TABLE ANGLE (Degree)	RAW VALUE (dBuV)	CORRECTION FACTOR (dB/m)
1	*5700.00	115.9 PK			1.37 H	151	111.4	4.5
2	*5700.00	106.2 AV			1.37 H	151	101.7	4.5
3	#5725.00	63.7 PK	74.0	-10.3	1.37 H	151	59.3	4.4
4	#5725.00	51.8 AV	54.0	-2.2	1.37 H	151	47.4	4.4
5	11400.00	50.5 PK	74.0	-23.5	1.83 H	204	36.9	13.6
6	11400.00	38.2 AV	54.0	-15.8	1.83 H	204	24.6	13.6
7	#17100.00	43.5 PK	74.0	-30.5	2.13 H	350	26.1	17.4
8	#17100.00	32.0 AV	54.0	-22.0	2.13 H	350	14.6	17.4

ANTENNA POLARITY & TEST DISTANCE: VERTICAL AT 3 M

NO.	FREQ. (MHz)	EMISSION LEVEL (dBuV/m)	LIMIT (dBuV/m)	MARGIN (dB)	ANTENNA HEIGHT (m)	TABLE ANGLE (Degree)	RAW VALUE (dBuV)	CORRECTION FACTOR (dB/m)
1	*5700.00	119.4 PK			2.53 V	358	114.9	4.5
2	*5700.00	109.7 AV			2.53 V	358	105.2	4.5
3	#5725.00	69.2 PK	74.0	-4.8	2.53 V	358	64.8	4.4
4	#5725.00	53.9 AV	54.0	-0.1	2.53 V	358	49.5	4.4
5	11400.00	49.8 PK	74.0	-24.2	2.17 V	205	36.2	13.6
6	11400.00	38.2 AV	54.0	-15.8	2.17 V	205	24.6	13.6
7	#17100.00	44.8 PK	74.0	-29.2	1.77 V	311	27.4	17.4
8	#17100.00	33.2 AV	54.0	-20.8	1.77 V	311	15.8	17.4

REMARKS:

1. Emission Level(dBuV/m) = Raw Value(dBuV) + Correction Factor(dB/m)
2. Correction Factor(dB/m) = Antenna Factor(dB/m) + Cable Factor(dB) – Pre-Amplifier Factor(dB)
3. The other emission levels were very low against the limit.
4. Margin value = Emission Level – Limit value
5. " * ": Fundamental frequency.
6. " # ": The radiated frequency is out of the restricted band.

CHANNEL	TX Channel 144	DETECTOR FUNCTION	Peak (PK)
FREQUENCY RANGE	1GHz ~ 40GHz		Average (AV)

ANTENNA POLARITY & TEST DISTANCE: HORIZONTAL AT 3 M

NO.	FREQ. (MHz)	EMISSION LEVEL (dBuV/m)	LIMIT (dBuV/m)	MARGIN (dB)	ANTENNA HEIGHT (m)	TABLE ANGLE (Degree)	RAW VALUE (dBuV)	CORRECTION FACTOR (dB/m)
1	#5470.00	45.6 PK	74.0	-28.4	1.30 H	140	41.4	4.2
2	#5470.00	34.8 AV	54.0	-19.2	1.30 H	140	30.6	4.2
3	*5720.00	117.2 PK			1.30 H	140	112.8	4.4
4	*5720.00	108.0 AV			1.30 H	140	103.6	4.4
5	#5850.00	45.9 PK	74.0	-28.1	1.30 H	140	41.4	4.5
6	#5850.00	35.2 AV	54.0	-18.8	1.30 H	140	30.7	4.5
7	11440.00	50.0 PK	74.0	-24.0	1.87 H	212	36.5	13.5
8	11440.00	37.8 AV	54.0	-16.2	1.87 H	212	24.3	13.5
9	#17160.00	44.0 PK	74.0	-30.0	2.14 H	360	26.7	17.3
10	#17160.00	32.7 AV	54.0	-21.3	2.14 H	360	15.4	17.3

ANTENNA POLARITY & TEST DISTANCE: VERTICAL AT 3 M

NO.	FREQ. (MHz)	EMISSION LEVEL (dBuV/m)	LIMIT (dBuV/m)	MARGIN (dB)	ANTENNA HEIGHT (m)	TABLE ANGLE (Degree)	RAW VALUE (dBuV)	CORRECTION FACTOR (dB/m)
1	#5470.00	49.2 PK	74.0	-24.8	2.52 V	353	45.0	4.2
2	#5470.00	37.2 AV	54.0	-16.8	2.52 V	353	33.0	4.2
3	*5720.00	120.7 PK			2.52 V	353	116.3	4.4
4	*5720.00	111.2 AV			2.52 V	353	106.8	4.4
5	#5850.00	50.8 PK	74.0	-23.2	2.52 V	353	46.3	4.5
6	#5850.00	38.7 AV	54.0	-15.3	2.52 V	353	34.2	4.5
7	11440.00	50.4 PK	74.0	-23.6	2.25 V	215	36.9	13.5
8	11440.00	38.5 AV	54.0	-15.5	2.25 V	215	25.0	13.5
9	#17160.00	44.2 PK	74.0	-29.8	1.83 V	293	26.9	17.3
10	#17160.00	32.9 AV	54.0	-21.1	1.83 V	293	15.6	17.3

REMARKS:

1. Emission Level(dBuV/m) = Raw Value(dBuV) + Correction Factor(dB/m)
2. Correction Factor(dB/m) = Antenna Factor(dB/m) + Cable Factor(dB) – Pre-Amplifier Factor(dB)
3. The other emission levels were very low against the limit.
4. Margin value = Emission Level – Limit value
5. " * ": Fundamental frequency.
6. " # ": The radiated frequency is out of the restricted band.

802.11ac (VHT20)

CHANNEL	TX Channel 52	DETECTOR FUNCTION	Peak (PK)
FREQUENCY RANGE	1GHz ~ 40GHz		Average (AV)

ANTENNA POLARITY & TEST DISTANCE: HORIZONTAL AT 3 M

NO.	FREQ. (MHz)	EMISSION LEVEL (dBuV/m)	LIMIT (dBuV/m)	MARGIN (dB)	ANTENNA HEIGHT (m)	TABLE ANGLE (Degree)	RAW VALUE (dBuV)	CORRECTION FACTOR (dB/m)
1	5150.00	46.3 PK	74.0	-27.7	1.32 H	162	42.6	3.7
2	5150.00	34.7 AV	54.0	-19.3	1.32 H	162	31.0	3.7
3	*5260.00	118.2 PK			1.32 H	162	114.2	4.0
4	*5260.00	108.0 AV			1.32 H	162	104.0	4.0
5	#10520.00	49.5 PK	74.0	-24.5	1.92 H	229	36.3	13.2
6	#10520.00	37.7 AV	54.0	-16.3	1.92 H	229	24.5	13.2
7	15780.00	44.0 PK	74.0	-30.0	2.08 H	336	30.4	13.6
8	15780.00	32.6 AV	54.0	-21.4	2.08 H	336	19.0	13.6

ANTENNA POLARITY & TEST DISTANCE: VERTICAL AT 3 M

NO.	FREQ. (MHz)	EMISSION LEVEL (dBuV/m)	LIMIT (dBuV/m)	MARGIN (dB)	ANTENNA HEIGHT (m)	TABLE ANGLE (Degree)	RAW VALUE (dBuV)	CORRECTION FACTOR (dB/m)
1	5150.00	49.5 PK	74.0	-24.5	2.73 V	360	45.8	3.7
2	5150.00	38.7 AV	54.0	-15.3	2.73 V	360	35.0	3.7
3	*5260.00	121.7 PK			2.73 V	360	117.7	4.0
4	*5260.00	111.1 AV			2.73 V	360	107.1	4.0
5	#10520.00	49.6 PK	74.0	-24.4	2.23 V	226	36.4	13.2
6	#10520.00	38.0 AV	54.0	-16.0	2.23 V	226	24.8	13.2
7	15780.00	44.8 PK	74.0	-29.2	1.77 V	311	31.2	13.6
8	15780.00	33.3 AV	54.0	-20.7	1.77 V	311	19.7	13.6

REMARKS:

- Emission Level(dBuV/m) = Raw Value(dBuV) + Correction Factor(dB/m)
- Correction Factor(dB/m) = Antenna Factor(dB/m) + Cable Factor(dB) – Pre-Amplifier Factor(dB)
- The other emission levels were very low against the limit.
- Margin value = Emission Level – Limit value
- " * ": Fundamental frequency.
- " # ": The radiated frequency is out of the restricted band.

CHANNEL	TX Channel 60	DETECTOR FUNCTION	Peak (PK)
FREQUENCY RANGE	1GHz ~ 40GHz		Average (AV)

ANTENNA POLARITY & TEST DISTANCE: HORIZONTAL AT 3 M

NO.	FREQ. (MHz)	EMISSION LEVEL (dBuV/m)	LIMIT (dBuV/m)	MARGIN (dB)	ANTENNA HEIGHT (m)	TABLE ANGLE (Degree)	RAW VALUE (dBuV)	CORRECTION FACTOR (dB/m)
1	5150.00	45.1 PK	74.0	-28.9	1.30 H	159	41.4	3.7
2	5150.00	33.9 AV	54.0	-20.1	1.30 H	159	30.2	3.7
3	*5300.00	118.4 PK			1.30 H	159	114.3	4.1
4	*5300.00	108.2 AV			1.30 H	159	104.1	4.1
5	5350.00	60.3 PK	74.0	-13.7	1.30 H	159	56.2	4.1
6	5350.00	49.1 AV	54.0	-4.9	1.30 H	159	45.0	4.1
7	10600.00	49.5 PK	74.0	-24.5	1.83 H	214	36.0	13.5
8	10600.00	37.6 AV	54.0	-16.4	1.83 H	214	24.1	13.5
9	15900.00	44.1 PK	74.0	-29.9	2.12 H	354	31.2	12.9
10	15900.00	32.6 AV	54.0	-21.4	2.12 H	354	19.7	12.9

ANTENNA POLARITY & TEST DISTANCE: VERTICAL AT 3 M

NO.	FREQ. (MHz)	EMISSION LEVEL (dBuV/m)	LIMIT (dBuV/m)	MARGIN (dB)	ANTENNA HEIGHT (m)	TABLE ANGLE (Degree)	RAW VALUE (dBuV)	CORRECTION FACTOR (dB/m)
1	5150.00	48.5 PK	74.0	-25.5	2.61 V	360	44.8	3.7
2	5150.00	37.8 AV	54.0	-16.2	2.61 V	360	34.1	3.7
3	*5300.00	121.5 PK			2.61 V	360	117.4	4.1
4	*5300.00	111.3 AV			2.61 V	360	107.2	4.1
5	5350.00	62.9 PK	74.0	-11.1	2.61 V	360	58.8	4.1
6	5350.00	50.9 AV	54.0	-3.1	2.61 V	360	46.8	4.1
7	10600.00	50.1 PK	74.0	-23.9	2.16 V	218	36.6	13.5
8	10600.00	38.0 AV	54.0	-16.0	2.16 V	218	24.5	13.5
9	15900.00	43.9 PK	74.0	-30.1	1.85 V	302	31.0	12.9
10	15900.00	32.6 AV	54.0	-21.4	1.85 V	302	19.7	12.9

REMARKS:

1. Emission Level(dBuV/m) = Raw Value(dBuV) + Correction Factor(dB/m)
2. Correction Factor(dB/m) = Antenna Factor(dB/m) + Cable Factor(dB) – Pre-Amplifier Factor(dB)
3. The other emission levels were very low against the limit.
4. Margin value = Emission Level – Limit value
5. " * ": Fundamental frequency.

CHANNEL	TX Channel 64	DETECTOR FUNCTION	Peak (PK)
FREQUENCY RANGE	1GHz ~ 40GHz		Average (AV)

ANTENNA POLARITY & TEST DISTANCE: HORIZONTAL AT 3 M

NO.	FREQ. (MHz)	EMISSION LEVEL (dBuV/m)	LIMIT (dBuV/m)	MARGIN (dB)	ANTENNA HEIGHT (m)	TABLE ANGLE (Degree)	RAW VALUE (dBuV)	CORRECTION FACTOR (dB/m)
1	*5320.00	114.2 PK			1.32 H	151	110.1	4.1
2	*5320.00	104.0 AV			1.32 H	151	99.9	4.1
3	5350.00	63.4 PK	74.0	-10.6	1.32 H	151	59.3	4.1
4	5350.00	52.2 AV	54.0	-1.8	1.32 H	151	48.1	4.1
5	10640.00	50.3 PK	74.0	-23.7	1.89 H	218	36.8	13.5
6	10640.00	38.1 AV	54.0	-15.9	1.89 H	218	24.6	13.5
7	15960.00	43.8 PK	74.0	-30.2	2.16 H	350	30.9	12.9
8	15960.00	32.3 AV	54.0	-21.7	2.16 H	350	19.4	12.9

ANTENNA POLARITY & TEST DISTANCE: VERTICAL AT 3 M

NO.	FREQ. (MHz)	EMISSION LEVEL (dBuV/m)	LIMIT (dBuV/m)	MARGIN (dB)	ANTENNA HEIGHT (m)	TABLE ANGLE (Degree)	RAW VALUE (dBuV)	CORRECTION FACTOR (dB/m)
1	*5320.00	117.7 PK			2.60 V	360	113.6	4.1
2	*5320.00	107.8 AV			2.60 V	360	103.7	4.1
3	5350.00	64.5 PK	74.0	-9.5	2.60 V	360	60.4	4.1
4	5350.00	53.8 AV	54.0	-0.2	2.60 V	360	49.7	4.1
5	10640.00	50.4 PK	74.0	-23.6	2.21 V	211	36.9	13.5
6	10640.00	38.4 AV	54.0	-15.6	2.21 V	211	24.9	13.5
7	15960.00	44.2 PK	74.0	-29.8	1.76 V	297	31.3	12.9
8	15960.00	33.1 AV	54.0	-20.9	1.76 V	297	20.2	12.9

REMARKS:

1. Emission Level(dBuV/m) = Raw Value(dBuV) + Correction Factor(dB/m)
2. Correction Factor(dB/m) = Antenna Factor(dB/m) + Cable Factor(dB) – Pre-Amplifier Factor(dB)
3. The other emission levels were very low against the limit.
4. Margin value = Emission Level – Limit value
5. " * ": Fundamental frequency.

CHANNEL	TX Channel 100	DETECTOR FUNCTION	Peak (PK)
FREQUENCY RANGE	1GHz ~ 40GHz		Average (AV)

ANTENNA POLARITY & TEST DISTANCE: HORIZONTAL AT 3 M

NO.	FREQ. (MHz)	EMISSION LEVEL (dBuV/m)	LIMIT (dBuV/m)	MARGIN (dB)	ANTENNA HEIGHT (m)	TABLE ANGLE (Degree)	RAW VALUE (dBuV)	CORRECTION FACTOR (dB/m)
1	#5470.00	63.0 PK	74.0	-11.0	1.38 H	151	58.8	4.2
2	#5470.00	51.7 AV	54.0	-2.3	1.38 H	151	47.5	4.2
3	*5500.00	114.0 PK			1.38 H	151	109.8	4.2
4	*5500.00	103.9 AV			1.38 H	151	99.7	4.2
5	11000.00	50.2 PK	74.0	-23.8	1.84 H	232	36.1	14.1
6	11000.00	38.4 AV	54.0	-15.6	1.84 H	232	24.3	14.1
7	#16500.00	43.6 PK	74.0	-30.4	2.12 H	354	29.1	14.5
8	#16500.00	32.2 AV	54.0	-21.8	2.12 H	354	17.7	14.5

ANTENNA POLARITY & TEST DISTANCE: VERTICAL AT 3 M

NO.	FREQ. (MHz)	EMISSION LEVEL (dBuV/m)	LIMIT (dBuV/m)	MARGIN (dB)	ANTENNA HEIGHT (m)	TABLE ANGLE (Degree)	RAW VALUE (dBuV)	CORRECTION FACTOR (dB/m)
1	#5470.00	67.9 PK	74.0	-6.1	2.68 V	359	63.7	4.2
2	#5470.00	53.6 AV	54.0	-0.4	2.68 V	359	49.4	4.2
3	*5500.00	117.6 PK			2.68 V	359	113.4	4.2
4	*5500.00	107.1 AV			2.68 V	359	102.9	4.2
5	11000.00	50.2 PK	74.0	-23.8	2.20 V	209	36.1	14.1
6	11000.00	38.7 AV	54.0	-15.3	2.20 V	209	24.6	14.1
7	#16500.00	43.9 PK	74.0	-30.1	1.83 V	281	29.4	14.5
8	#16500.00	32.7 AV	54.0	-21.3	1.83 V	281	18.2	14.5

REMARKS:

1. Emission Level(dBuV/m) = Raw Value(dBuV) + Correction Factor(dB/m)
2. Correction Factor(dB/m) = Antenna Factor(dB/m) + Cable Factor(dB) – Pre-Amplifier Factor(dB)
3. The other emission levels were very low against the limit.
4. Margin value = Emission Level – Limit value
5. " * ": Fundamental frequency.
6. " # ": The radiated frequency is out of the restricted band.

CHANNEL	TX Channel 116	DETECTOR FUNCTION	Peak (PK)
FREQUENCY RANGE	1GHz ~ 40GHz		Average (AV)

ANTENNA POLARITY & TEST DISTANCE: HORIZONTAL AT 3 M

NO.	FREQ. (MHz)	EMISSION LEVEL (dBuV/m)	LIMIT (dBuV/m)	MARGIN (dB)	ANTENNA HEIGHT (m)	TABLE ANGLE (Degree)	RAW VALUE (dBuV)	CORRECTION FACTOR (dB/m)
1	#5470.00	46.3 PK	74.0	-27.7	1.35 H	153	42.1	4.2
2	#5470.00	35.3 AV	54.0	-18.7	1.35 H	153	31.1	4.2
3	*5580.00	118.3 PK			1.35 H	153	114.1	4.2
4	*5580.00	108.1 AV			1.35 H	153	103.9	4.2
5	#5725.00	45.0 PK	74.0	-29.0	1.35 H	153	40.6	4.4
6	#5725.00	34.4 AV	54.0	-19.6	1.35 H	153	30.0	4.4
7	11160.00	49.8 PK	74.0	-24.2	1.84 H	218	36.1	13.7
8	11160.00	37.9 AV	54.0	-16.1	1.84 H	218	24.2	13.7
9	#16740.00	44.0 PK	74.0	-30.0	2.10 H	344	28.3	15.7
10	#16740.00	32.4 AV	54.0	-21.6	2.10 H	344	16.7	15.7

ANTENNA POLARITY & TEST DISTANCE: VERTICAL AT 3 M

NO.	FREQ. (MHz)	EMISSION LEVEL (dBuV/m)	LIMIT (dBuV/m)	MARGIN (dB)	ANTENNA HEIGHT (m)	TABLE ANGLE (Degree)	RAW VALUE (dBuV)	CORRECTION FACTOR (dB/m)
1	#5470.00	50.8 PK	74.0	-23.2	2.44 V	360	46.6	4.2
2	#5470.00	37.8 AV	54.0	-16.2	2.44 V	360	33.6	4.2
3	*5580.00	120.7 PK			2.44 V	360	116.5	4.2
4	*5580.00	110.6 AV			2.44 V	360	106.4	4.2
5	#5725.00	49.5 PK	74.0	-24.5	2.44 V	360	45.1	4.4
6	#5725.00	38.9 AV	54.0	-15.1	2.44 V	360	34.5	4.4
7	11160.00	50.0 PK	74.0	-24.0	2.23 V	209	36.3	13.7
8	11160.00	38.4 AV	54.0	-15.6	2.23 V	209	24.7	13.7
9	#16740.00	43.4 PK	74.0	-30.6	1.88 V	290	27.7	15.7
10	#16740.00	32.3 AV	54.0	-21.7	1.88 V	290	16.6	15.7

REMARKS:

1. Emission Level(dBuV/m) = Raw Value(dBuV) + Correction Factor(dB/m)
2. Correction Factor(dB/m) = Antenna Factor(dB/m) + Cable Factor(dB) – Pre-Amplifier Factor(dB)
3. The other emission levels were very low against the limit.
4. Margin value = Emission Level – Limit value
5. " * ": Fundamental frequency.
6. " # ": The radiated frequency is out of the restricted band.

CHANNEL	TX Channel 140	DETECTOR FUNCTION	Peak (PK)
FREQUENCY RANGE	1GHz ~ 40GHz		Average (AV)

ANTENNA POLARITY & TEST DISTANCE: HORIZONTAL AT 3 M

NO.	FREQ. (MHz)	EMISSION LEVEL (dBuV/m)	LIMIT (dBuV/m)	MARGIN (dB)	ANTENNA HEIGHT (m)	TABLE ANGLE (Degree)	RAW VALUE (dBuV)	CORRECTION FACTOR (dB/m)
1	*5700.00	114.6 PK			1.34 H	151	110.1	4.5
2	*5700.00	103.5 AV			1.34 H	151	99.0	4.5
3	#5725.00	62.9 PK	74.0	-11.1	1.34 H	151	58.5	4.4
4	#5725.00	51.5 AV	54.0	-2.5	1.34 H	151	47.1	4.4
5	11400.00	49.7 PK	74.0	-24.3	1.82 H	207	36.1	13.6
6	11400.00	37.8 AV	54.0	-16.2	1.82 H	207	24.2	13.6
7	#17100.00	44.3 PK	74.0	-29.7	2.10 H	357	26.9	17.4
8	#17100.00	32.5 AV	54.0	-21.5	2.10 H	357	15.1	17.4

ANTENNA POLARITY & TEST DISTANCE: VERTICAL AT 3 M

NO.	FREQ. (MHz)	EMISSION LEVEL (dBuV/m)	LIMIT (dBuV/m)	MARGIN (dB)	ANTENNA HEIGHT (m)	TABLE ANGLE (Degree)	RAW VALUE (dBuV)	CORRECTION FACTOR (dB/m)
1	*5700.00	117.9 PK			2.49 V	359	113.4	4.5
2	*5700.00	106.6 AV			2.49 V	359	102.1	4.5
3	#5725.00	67.8 PK	74.0	-6.2	2.49 V	359	63.4	4.4
4	#5725.00	53.8 AV	54.0	-0.2	2.49 V	359	49.4	4.4
5	11400.00	49.6 PK	74.0	-24.4	2.22 V	206	36.0	13.6
6	11400.00	37.9 AV	54.0	-16.1	2.22 V	206	24.3	13.6
7	#17100.00	43.6 PK	74.0	-30.4	1.77 V	302	26.2	17.4
8	#17100.00	32.5 AV	54.0	-21.5	1.77 V	302	15.1	17.4

REMARKS:

1. Emission Level(dBuV/m) = Raw Value(dBuV) + Correction Factor(dB/m)
2. Correction Factor(dB/m) = Antenna Factor(dB/m) + Cable Factor(dB) – Pre-Amplifier Factor(dB)
3. The other emission levels were very low against the limit.
4. Margin value = Emission Level – Limit value
5. " * ": Fundamental frequency.
6. " # ": The radiated frequency is out of the restricted band.

CHANNEL	TX Channel 144	DETECTOR FUNCTION	Peak (PK)
FREQUENCY RANGE	1GHz ~ 40GHz		Average (AV)

ANTENNA POLARITY & TEST DISTANCE: HORIZONTAL AT 3 M

NO.	FREQ. (MHz)	EMISSION LEVEL (dBuV/m)	LIMIT (dBuV/m)	MARGIN (dB)	ANTENNA HEIGHT (m)	TABLE ANGLE (Degree)	RAW VALUE (dBuV)	CORRECTION FACTOR (dB/m)
1	#5470.00	46.5 PK	74.0	-27.5	1.35 H	159	42.3	4.2
2	#5470.00	35.8 AV	54.0	-18.2	1.35 H	159	31.6	4.2
3	*5720.00	118.8 PK			1.35 H	159	114.4	4.4
4	*5720.00	108.5 AV			1.35 H	159	104.1	4.4
5	#5919.00	45.9 PK	74.0	-28.1	1.35 H	159	41.3	4.6
6	#5919.00	35.3 AV	54.0	-18.7	1.35 H	159	30.7	4.6
7	11440.00	50.1 PK	74.0	-23.9	1.85 H	214	36.6	13.5
8	11440.00	38.1 AV	54.0	-15.9	1.85 H	214	24.6	13.5
9	#17160.00	44.3 PK	74.0	-29.7	2.11 H	343	27.0	17.3
10	#17160.00	32.6 AV	54.0	-21.4	2.11 H	343	15.3	17.3

ANTENNA POLARITY & TEST DISTANCE: VERTICAL AT 3 M

NO.	FREQ. (MHz)	EMISSION LEVEL (dBuV/m)	LIMIT (dBuV/m)	MARGIN (dB)	ANTENNA HEIGHT (m)	TABLE ANGLE (Degree)	RAW VALUE (dBuV)	CORRECTION FACTOR (dB/m)
1	#5470.00	48.9 PK	74.0	-25.1	2.50 V	352	44.7	4.2
2	#5470.00	36.9 AV	54.0	-17.1	2.50 V	352	32.7	4.2
3	*5720.00	120.1 PK			2.50 V	352	115.7	4.4
4	*5720.00	110.2 AV			2.50 V	352	105.8	4.4
5	#5919.00	51.3 PK	74.0	-22.7	2.50 V	352	46.7	4.6
6	#5919.00	39.0 AV	54.0	-15.0	2.50 V	352	34.4	4.6
7	11440.00	50.1 PK	74.0	-23.9	2.24 V	228	36.6	13.5
8	11440.00	38.2 AV	54.0	-15.8	2.24 V	228	24.7	13.5
9	#17160.00	44.1 PK	74.0	-29.9	1.79 V	280	26.8	17.3
10	#17160.00	32.8 AV	54.0	-21.2	1.79 V	280	15.5	17.3

REMARKS:

1. Emission Level(dBuV/m) = Raw Value(dBuV) + Correction Factor(dB/m)
2. Correction Factor(dB/m) = Antenna Factor(dB/m) + Cable Factor(dB) – Pre-Amplifier Factor(dB)
3. The other emission levels were very low against the limit.
4. Margin value = Emission Level – Limit value
5. " * ": Fundamental frequency.
6. " # ": The radiated frequency is out of the restricted band.

802.11ac (VHT40)

CHANNEL	TX Channel 54	DETECTOR FUNCTION	Peak (PK)
FREQUENCY RANGE	1GHz ~ 40GHz		Average (AV)

ANTENNA POLARITY & TEST DISTANCE: HORIZONTAL AT 3 M

NO.	FREQ. (MHz)	EMISSION LEVEL (dBuV/m)	LIMIT (dBuV/m)	MARGIN (dB)	ANTENNA HEIGHT (m)	TABLE ANGLE (Degree)	RAW VALUE (dBuV)	CORRECTION FACTOR (dB/m)
1	5150.00	43.0 PK	74.0	-31.0	1.31 H	140	39.3	3.7
2	5150.00	31.7 AV	54.0	-22.3	1.31 H	140	28.0	3.7
3	*5270.00	105.0 PK			1.31 H	140	101.0	4.0
4	*5270.00	104.6 AV			1.31 H	140	100.6	4.0
5	5350.00	63.4 PK	74.0	-10.6	1.31 H	140	59.3	4.1
6	5350.00	51.7 AV	54.0	-2.3	1.31 H	140	47.6	4.1
7	#10540.00	46.2 PK	74.0	-27.8	1.86 H	221	32.9	13.3
8	#10540.00	34.6 AV	54.0	-19.4	1.86 H	221	21.3	13.3
9	15810.00	44.4 PK	74.0	-29.6	2.01 H	360	31.0	13.4
10	15810.00	32.9 AV	54.0	-21.1	2.01 H	360	19.5	13.4

ANTENNA POLARITY & TEST DISTANCE: VERTICAL AT 3 M

NO.	FREQ. (MHz)	EMISSION LEVEL (dBuV/m)	LIMIT (dBuV/m)	MARGIN (dB)	ANTENNA HEIGHT (m)	TABLE ANGLE (Degree)	RAW VALUE (dBuV)	CORRECTION FACTOR (dB/m)
1	5150.00	53.8 PK	74.0	-20.2	2.16 V	326	50.1	3.7
2	5150.00	44.0 AV	54.0	-10.0	2.16 V	326	40.3	3.7
3	*5270.00	108.3 PK			2.16 V	326	104.3	4.0
4	*5270.00	107.9 AV			2.16 V	326	103.9	4.0
5	5350.00	67.5 PK	74.0	-6.5	2.16 V	326	63.4	4.1
6	5350.00	53.7 AV	54.0	-0.3	2.16 V	326	49.6	4.1
7	#10540.00	47.4 PK	74.0	-26.6	2.16 V	173	34.1	13.3
8	#10540.00	35.7 AV	54.0	-18.3	2.16 V	173	22.4	13.3
9	15810.00	44.5 PK	74.0	-29.5	1.66 V	293	31.1	13.4
10	15810.00	33.1 AV	54.0	-20.9	1.66 V	293	19.7	13.4

REMARKS:

1. Emission Level(dBuV/m) = Raw Value(dBuV) + Correction Factor(dB/m)
2. Correction Factor(dB/m) = Antenna Factor(dB/m) + Cable Factor(dB) – Pre-Amplifier Factor(dB)
3. The other emission levels were very low against the limit.
4. Margin value = Emission Level – Limit value
5. " * ": Fundamental frequency.
6. " # ": The radiated frequency is out of the restricted band.

CHANNEL	TX Channel 62	DETECTOR FUNCTION	Peak (PK)
FREQUENCY RANGE	1GHz ~ 40GHz		Average (AV)

ANTENNA POLARITY & TEST DISTANCE: HORIZONTAL AT 3 M

NO.	FREQ. (MHz)	EMISSION LEVEL (dBuV/m)	LIMIT (dBuV/m)	MARGIN (dB)	ANTENNA HEIGHT (m)	TABLE ANGLE (Degree)	RAW VALUE (dBuV)	CORRECTION FACTOR (dB/m)
1	*5310.00	111.3 PK			1.28 H	171	107.2	4.1
2	*5310.00	102.0 AV			1.28 H	171	97.9	4.1
3	5350.00	63.8 PK	74.0	-10.2	1.28 H	171	59.7	4.1
4	5350.00	52.2 AV	54.0	-1.8	1.28 H	171	48.1	4.1
5	10620.00	45.5 PK	74.0	-28.5	1.86 H	226	32.0	13.5
6	10620.00	33.8 AV	54.0	-20.2	1.86 H	226	20.3	13.5
7	15930.00	44.4 PK	74.0	-29.6	2.01 H	360	31.6	12.8
8	15930.00	32.6 AV	54.0	-21.4	2.01 H	360	19.8	12.8

ANTENNA POLARITY & TEST DISTANCE: VERTICAL AT 3 M

NO.	FREQ. (MHz)	EMISSION LEVEL (dBuV/m)	LIMIT (dBuV/m)	MARGIN (dB)	ANTENNA HEIGHT (m)	TABLE ANGLE (Degree)	RAW VALUE (dBuV)	CORRECTION FACTOR (dB/m)
1	*5310.00	114.5 PK			2.19 V	326	110.4	4.1
2	*5310.00	105.2 AV			2.19 V	326	101.1	4.1
3	5350.00	69.2 PK	74.0	-4.8	2.19 V	326	65.1	4.1
4	5350.00	53.9 AV	54.0	-0.1	2.19 V	326	49.8	4.1
5	10620.00	46.4 PK	74.0	-27.6	2.15 V	199	32.9	13.5
6	10620.00	34.5 AV	54.0	-19.5	2.15 V	199	21.0	13.5
7	15930.00	44.3 PK	74.0	-29.7	1.80 V	289	31.5	12.8
8	15930.00	33.3 AV	54.0	-20.7	1.80 V	289	20.5	12.8

REMARKS:

1. Emission Level(dBuV/m) = Raw Value(dBuV) + Correction Factor(dB/m)
2. Correction Factor(dB/m) = Antenna Factor(dB/m) + Cable Factor(dB) – Pre-Amplifier Factor(dB)
3. The other emission levels were very low against the limit.
4. Margin value = Emission Level – Limit value
5. " * ": Fundamental frequency.

CHANNEL	TX Channel 102	DETECTOR FUNCTION	Peak (PK)
FREQUENCY RANGE	1GHz ~ 40GHz		Average (AV)

ANTENNA POLARITY & TEST DISTANCE: HORIZONTAL AT 3 M

NO.	FREQ. (MHz)	EMISSION LEVEL (dBuV/m)	LIMIT (dBuV/m)	MARGIN (dB)	ANTENNA HEIGHT (m)	TABLE ANGLE (Degree)	RAW VALUE (dBuV)	CORRECTION FACTOR (dB/m)
1	#5470.00	63.6 PK	74.0	-10.4	1.28 H	143	59.4	4.2
2	#5470.00	52.1 AV	54.0	-1.9	1.28 H	143	47.9	4.2
3	*5510.00	108.2 PK			1.28 H	143	104.0	4.2
4	*5510.00	99.5 AV			1.28 H	143	95.3	4.2
5	11020.00	43.7 PK	74.0	-30.3	1.84 H	236	29.7	14.0
6	11020.00	31.6 AV	54.0	-22.4	1.84 H	236	17.6	14.0
7	#16530.00	43.9 PK	74.0	-30.1	2.02 H	359	29.0	14.9
8	#16530.00	32.0 AV	54.0	-22.0	2.02 H	359	17.1	14.9

ANTENNA POLARITY & TEST DISTANCE: VERTICAL AT 3 M

NO.	FREQ. (MHz)	EMISSION LEVEL (dBuV/m)	LIMIT (dBuV/m)	MARGIN (dB)	ANTENNA HEIGHT (m)	TABLE ANGLE (Degree)	RAW VALUE (dBuV)	CORRECTION FACTOR (dB/m)
1	#5470.00	68.2 PK	74.0	-5.8	2.19 V	325	64.0	4.2
2	#5470.00	53.9 AV	54.0	-0.1	2.19 V	325	49.7	4.2
3	*5510.00	111.6 PK			2.19 V	325	107.4	4.2
4	*5510.00	102.7 AV			2.19 V	325	98.5	4.2
5	11020.00	46.0 PK	74.0	-28.0	2.17 V	223	32.0	14.0
6	11020.00	33.8 AV	54.0	-20.2	2.17 V	223	19.8	14.0
7	#16530.00	44.4 PK	74.0	-29.6	1.77 V	283	29.5	14.9
8	#16530.00	33.0 AV	54.0	-21.0	1.77 V	283	18.1	14.9

REMARKS:

1. Emission Level(dBuV/m) = Raw Value(dBuV) + Correction Factor(dB/m)
2. Correction Factor(dB/m) = Antenna Factor(dB/m) + Cable Factor(dB) – Pre-Amplifier Factor(dB)
3. The other emission levels were very low against the limit.
4. Margin value = Emission Level – Limit value
5. " * ": Fundamental frequency.
6. " # ": The radiated frequency is out of the restricted band.

CHANNEL	TX Channel 110	DETECTOR FUNCTION	Peak (PK)
FREQUENCY RANGE	1GHz ~ 40GHz		Average (AV)

ANTENNA POLARITY & TEST DISTANCE: HORIZONTAL AT 3 M

NO.	FREQ. (MHz)	EMISSION LEVEL (dBuV/m)	LIMIT (dBuV/m)	MARGIN (dB)	ANTENNA HEIGHT (m)	TABLE ANGLE (Degree)	RAW VALUE (dBuV)	CORRECTION FACTOR (dB/m)
1	#5470.00	63.3 PK	74.0	-10.7	1.33 H	165	59.1	4.2
2	#5470.00	51.7 AV	54.0	-2.3	1.33 H	165	47.5	4.2
3	*5550.00	112.5 PK			1.33 H	165	108.3	4.2
4	*5550.00	103.3 AV			1.33 H	165	99.1	4.2
5	#5725.00	43.9 PK	74.0	-30.1	1.33 H	165	39.5	4.4
6	#5725.00	32.5 AV	54.0	-21.5	1.33 H	165	28.1	4.4
7	11100.00	46.1 PK	74.0	-27.9	1.78 H	214	32.3	13.8
8	11100.00	33.6 AV	54.0	-20.4	1.78 H	214	19.8	13.8
9	#16650.00	45.3 PK	74.0	-28.7	2.02 H	360	29.7	15.6
10	#16650.00	33.4 AV	54.0	-20.6	2.02 H	360	17.8	15.6

ANTENNA POLARITY & TEST DISTANCE: VERTICAL AT 3 M

NO.	FREQ. (MHz)	EMISSION LEVEL (dBuV/m)	LIMIT (dBuV/m)	MARGIN (dB)	ANTENNA HEIGHT (m)	TABLE ANGLE (Degree)	RAW VALUE (dBuV)	CORRECTION FACTOR (dB/m)
1	#5470.00	68.9 PK	74.0	-5.1	2.18 V	326	64.7	4.2
2	#5470.00	53.9 AV	54.0	-0.1	2.18 V	326	49.7	4.2
3	*5550.00	115.9 PK			2.18 V	326	111.7	4.2
4	*5550.00	106.7 AV			2.18 V	326	102.5	4.2
5	#5725.00	51.6 PK	74.0	-22.4	2.18 V	326	47.2	4.4
6	#5725.00	38.9 AV	54.0	-15.1	2.18 V	326	34.5	4.4
7	11100.00	48.3 PK	74.0	-25.7	2.16 V	192	34.5	13.8
8	11100.00	35.9 AV	54.0	-18.1	2.16 V	192	22.1	13.8
9	#16650.00	45.4 PK	74.0	-28.6	1.85 V	300	29.8	15.6
10	#16650.00	33.8 AV	54.0	-20.2	1.85 V	300	18.2	15.6

REMARKS:

1. Emission Level(dBuV/m) = Raw Value(dBuV) + Correction Factor(dB/m)
2. Correction Factor(dB/m) = Antenna Factor(dB/m) + Cable Factor(dB) – Pre-Amplifier Factor(dB)
3. The other emission levels were very low against the limit.
4. Margin value = Emission Level – Limit value
5. " * ": Fundamental frequency.
6. " # ": The radiated frequency is out of the restricted band.

CHANNEL	TX Channel 134	DETECTOR FUNCTION	Peak (PK)
FREQUENCY RANGE	1GHz ~ 40GHz		Average (AV)

ANTENNA POLARITY & TEST DISTANCE: HORIZONTAL AT 3 M

NO.	FREQ. (MHz)	EMISSION LEVEL (dBuV/m)	LIMIT (dBuV/m)	MARGIN (dB)	ANTENNA HEIGHT (m)	TABLE ANGLE (Degree)	RAW VALUE (dBuV)	CORRECTION FACTOR (dB/m)
1	*5670.00	110.1 PK			1.30 H	148	105.8	4.3
2	*5670.00	101.0 AV			1.30 H	148	96.7	4.3
3	#5725.00	63.5 PK	74.0	-10.5	1.30 H	148	59.1	4.4
4	#5725.00	52.0 AV	54.0	-2.0	1.30 H	148	47.6	4.4
5	11340.00	44.9 PK	74.0	-29.1	1.83 H	242	31.3	13.6
6	11340.00	32.9 AV	54.0	-21.1	1.83 H	242	19.3	13.6
7	#17010.00	44.4 PK	74.0	-29.6	2.05 H	339	27.3	17.1
8	#17010.00	32.3 AV	54.0	-21.7	2.05 H	339	15.2	17.1

ANTENNA POLARITY & TEST DISTANCE: VERTICAL AT 3 M

NO.	FREQ. (MHz)	EMISSION LEVEL (dBuV/m)	LIMIT (dBuV/m)	MARGIN (dB)	ANTENNA HEIGHT (m)	TABLE ANGLE (Degree)	RAW VALUE (dBuV)	CORRECTION FACTOR (dB/m)
1	*5670.00	113.7 PK			2.22 V	321	109.4	4.3
2	*5670.00	104.3 AV			2.22 V	321	100.0	4.3
3	#5725.00	67.8 PK	74.0	-6.2	2.22 V	321	63.4	4.4
4	#5725.00	53.9 AV	54.0	-0.1	2.22 V	321	49.5	4.4
5	11340.00	47.4 PK	74.0	-26.6	2.14 V	193	33.8	13.6
6	11340.00	35.2 AV	54.0	-18.8	2.14 V	193	21.6	13.6
7	#17010.00	44.6 PK	74.0	-29.4	1.79 V	312	27.5	17.1
8	#17010.00	32.6 AV	54.0	-21.4	1.79 V	312	15.5	17.1

REMARKS:

1. Emission Level(dBuV/m) = Raw Value(dBuV) + Correction Factor(dB/m)
2. Correction Factor(dB/m) = Antenna Factor(dB/m) + Cable Factor(dB) – Pre-Amplifier Factor(dB)
3. The other emission levels were very low against the limit.
4. Margin value = Emission Level – Limit value
5. " * ": Fundamental frequency.
6. " # ": The radiated frequency is out of the restricted band.

CHANNEL	TX Channel 142	DETECTOR FUNCTION	Peak (PK)
FREQUENCY RANGE	1GHz ~ 40GHz		Average (AV)

ANTENNA POLARITY & TEST DISTANCE: HORIZONTAL AT 3 M

NO.	FREQ. (MHz)	EMISSION LEVEL (dBuV/m)	LIMIT (dBuV/m)	MARGIN (dB)	ANTENNA HEIGHT (m)	TABLE ANGLE (Degree)	RAW VALUE (dBuV)	CORRECTION FACTOR (dB/m)
1	#5470.00	45.1 PK	74.0	-28.9	1.28 H	145	40.9	4.2
2	#5470.00	34.6 AV	54.0	-19.4	1.28 H	145	30.4	4.2
3	*5710.00	112.9 PK			1.28 H	145	108.4	4.5
4	*5710.00	104.2 AV			1.28 H	145	99.7	4.5
5	#5850.00	46.5 PK	74.0	-27.5	1.28 H	145	42.0	4.5
6	#5850.00	35.4 AV	54.0	-18.6	1.28 H	145	30.9	4.5
7	11420.00	47.0 PK	74.0	-27.0	1.76 H	219	33.4	13.6
8	11420.00	34.8 AV	54.0	-19.2	1.76 H	219	21.2	13.6
9	#17130.00	45.1 PK	74.0	-28.9	1.99 H	360	27.7	17.4
10	#17130.00	33.5 AV	54.0	-20.5	1.99 H	360	16.1	17.4

ANTENNA POLARITY & TEST DISTANCE: VERTICAL AT 3 M

NO.	FREQ. (MHz)	EMISSION LEVEL (dBuV/m)	LIMIT (dBuV/m)	MARGIN (dB)	ANTENNA HEIGHT (m)	TABLE ANGLE (Degree)	RAW VALUE (dBuV)	CORRECTION FACTOR (dB/m)
1	#5470.00	49.5 PK	74.0	-24.5	2.24 V	320	45.3	4.2
2	#5470.00	37.8 AV	54.0	-16.2	2.24 V	320	33.6	4.2
3	*5710.00	116.2 PK			2.24 V	320	111.7	4.5
4	*5710.00	107.3 AV			2.24 V	320	102.8	4.5
5	#5850.00	51.5 PK	74.0	-22.5	2.24 V	320	47.0	4.5
6	#5850.00	39.7 AV	54.0	-14.3	2.24 V	320	35.2	4.5
7	11420.00	48.0 PK	74.0	-26.0	2.23 V	193	34.4	13.6
8	11420.00	36.3 AV	54.0	-17.7	2.23 V	193	22.7	13.6
9	#17130.00	44.0 PK	74.0	-30.0	1.81 V	285	26.6	17.4
10	#17130.00	32.7 AV	54.0	-21.3	1.81 V	285	15.3	17.4

REMARKS:

1. Emission Level(dBuV/m) = Raw Value(dBuV) + Correction Factor(dB/m)
2. Correction Factor(dB/m) = Antenna Factor(dB/m) + Cable Factor(dB) – Pre-Amplifier Factor(dB)
3. The other emission levels were very low against the limit.
4. Margin value = Emission Level – Limit value
5. " * ": Fundamental frequency.
6. " # ": The radiated frequency is out of the restricted band.

802.11ac (VHT80)

CHANNEL	TX Channel 58	DETECTOR FUNCTION	Peak (PK)
FREQUENCY RANGE	1GHz ~ 40GHz		Average (AV)

ANTENNA POLARITY & TEST DISTANCE: HORIZONTAL AT 3 M

NO.	FREQ. (MHz)	EMISSION LEVEL (dBuV/m)	LIMIT (dBuV/m)	MARGIN (dB)	ANTENNA HEIGHT (m)	TABLE ANGLE (Degree)	RAW VALUE (dBuV)	CORRECTION FACTOR (dB/m)
1	5150.00	51.2 PK	74.0	-22.8	1.30 H	157	47.5	3.7
2	5150.00	41.3 AV	54.0	-12.7	1.30 H	157	37.6	3.7
3	*5290.00	105.1 PK			1.30 H	157	101.0	4.1
4	*5290.00	95.0 AV			1.30 H	157	90.9	4.1
5	5350.00	63.6 PK	74.0	-10.4	1.30 H	157	59.5	4.1
6	5350.00	51.9 AV	54.0	-2.1	1.30 H	157	47.8	4.1
7	#10580.00	42.3 PK	74.0	-31.7	1.78 H	228	28.9	13.4
8	#10580.00	30.3 AV	54.0	-23.7	1.78 H	228	16.9	13.4
9	15870.00	44.8 PK	74.0	-29.2	2.10 H	346	31.8	13.0
10	15870.00	33.3 AV	54.0	-20.7	2.10 H	346	20.3	13.0

ANTENNA POLARITY & TEST DISTANCE: VERTICAL AT 3 M

NO.	FREQ. (MHz)	EMISSION LEVEL (dBuV/m)	LIMIT (dBuV/m)	MARGIN (dB)	ANTENNA HEIGHT (m)	TABLE ANGLE (Degree)	RAW VALUE (dBuV)	CORRECTION FACTOR (dB/m)
1	5150.00	55.2 PK	74.0	-18.8	2.79 V	326	51.5	3.7
2	5150.00	44.4 AV	54.0	-9.6	2.79 V	326	40.7	3.7
3	*5290.00	108.7 PK			2.79 V	326	104.6	4.1
4	*5290.00	98.3 AV			2.79 V	326	94.2	4.1
5	5350.00	66.9 PK	74.0	-7.1	2.79 V	326	62.8	4.1
6	5350.00	53.9 AV	54.0	-0.1	2.79 V	326	49.8	4.1
7	#10580.00	43.3 PK	74.0	-30.7	2.24 V	191	29.9	13.4
8	#10580.00	31.0 AV	54.0	-23.0	2.24 V	191	17.6	13.4
9	15870.00	43.4 PK	74.0	-30.6	1.68 V	273	30.4	13.0
10	15870.00	32.4 AV	54.0	-21.6	1.68 V	273	19.4	13.0

REMARKS:

1. Emission Level(dBuV/m) = Raw Value(dBuV) + Correction Factor(dB/m)
2. Correction Factor(dB/m) = Antenna Factor(dB/m) + Cable Factor(dB) – Pre-Amplifier Factor(dB)
3. The other emission levels were very low against the limit.
4. Margin value = Emission Level – Limit value
5. " * ": Fundamental frequency.
6. " # ": The radiated frequency is out of the restricted band.

CHANNEL	TX Channel 106	DETECTOR FUNCTION	Peak (PK)
FREQUENCY RANGE	1GHz ~ 40GHz		Average (AV)

ANTENNA POLARITY & TEST DISTANCE: HORIZONTAL AT 3 M

NO.	FREQ. (MHz)	EMISSION LEVEL (dBuV/m)	LIMIT (dBuV/m)	MARGIN (dB)	ANTENNA HEIGHT (m)	TABLE ANGLE (Degree)	RAW VALUE (dBuV)	CORRECTION FACTOR (dB/m)
1	#5470.00	63.1 PK	74.0	-10.9	1.27 H	168	58.9	4.2
2	#5470.00	51.6 AV	54.0	-2.4	1.27 H	168	47.4	4.2
3	*5530.00	102.9 PK			1.27 H	168	98.7	4.2
4	*5530.00	92.0 AV			1.27 H	168	87.8	4.2
5	#5725.00	45.8 PK	74.0	-28.2	1.27 H	168	41.4	4.4
6	#5725.00	35.0 AV	54.0	-19.0	1.27 H	168	30.6	4.4
7	11060.00	41.3 PK	74.0	-32.7	1.81 H	231	27.4	13.9
8	11060.00	29.6 AV	54.0	-24.4	1.81 H	231	15.7	13.9
9	#16590.00	43.8 PK	74.0	-30.2	1.97 H	359	28.2	15.6
10	#16590.00	31.9 AV	54.0	-22.1	1.97 H	359	16.3	15.6

ANTENNA POLARITY & TEST DISTANCE: VERTICAL AT 3 M

NO.	FREQ. (MHz)	EMISSION LEVEL (dBuV/m)	LIMIT (dBuV/m)	MARGIN (dB)	ANTENNA HEIGHT (m)	TABLE ANGLE (Degree)	RAW VALUE (dBuV)	CORRECTION FACTOR (dB/m)
1	#5470.00	67.7 PK	74.0	-6.3	2.81 V	341	63.5	4.2
2	#5470.00	53.9 AV	54.0	-0.1	2.81 V	341	49.7	4.2
3	*5530.00	104.8 PK			2.81 V	341	100.6	4.2
4	*5530.00	95.2 AV			2.81 V	341	91.0	4.2
5	#5725.00	51.9 PK	74.0	-22.1	2.81 V	341	47.5	4.4
6	#5725.00	38.9 AV	54.0	-15.1	2.81 V	341	34.5	4.4
7	11060.00	41.5 PK	74.0	-32.5	2.13 V	183	27.6	13.9
8	11060.00	29.3 AV	54.0	-24.7	2.13 V	183	15.4	13.9
9	#16590.00	45.3 PK	74.0	-28.7	1.73 V	291	29.7	15.6
10	#16590.00	33.7 AV	54.0	-20.3	1.73 V	291	18.1	15.6

REMARKS:

1. Emission Level(dBuV/m) = Raw Value(dBuV) + Correction Factor(dB/m)
2. Correction Factor(dB/m) = Antenna Factor(dB/m) + Cable Factor(dB) – Pre-Amplifier Factor(dB)
3. The other emission levels were very low against the limit.
4. Margin value = Emission Level – Limit value
5. " * ": Fundamental frequency.
6. " # ": The radiated frequency is out of the restricted band.

CHANNEL	TX Channel 122	DETECTOR FUNCTION	Peak (PK)
FREQUENCY RANGE	1GHz ~ 40GHz		Average (AV)

ANTENNA POLARITY & TEST DISTANCE: HORIZONTAL AT 3 M

NO.	FREQ. (MHz)	EMISSION LEVEL (dBuV/m)	LIMIT (dBuV/m)	MARGIN (dB)	ANTENNA HEIGHT (m)	TABLE ANGLE (Degree)	RAW VALUE (dBuV)	CORRECTION FACTOR (dB/m)
1	*5610.00	106.1 PK			1.31 H	155	101.7	4.4
2	*5610.00	97.0 AV			1.31 H	155	92.6	4.4
3	#5725.00	63.7 PK	74.0	-10.3	1.31 H	155	59.3	4.4
4	#5725.00	52.2 AV	54.0	-1.8	1.31 H	155	47.8	4.4
5	11220.00	50.8 PK	74.0	-23.2	1.86 H	212	37.1	13.7
6	11220.00	38.5 AV	54.0	-15.5	1.86 H	212	24.8	13.7
7	#16830.00	44.6 PK	74.0	-29.4	1.90 H	360	28.7	15.9
8	#16830.00	32.3 AV	54.0	-21.7	1.90 H	360	16.4	15.9

ANTENNA POLARITY & TEST DISTANCE: VERTICAL AT 3 M

NO.	FREQ. (MHz)	EMISSION LEVEL (dBuV/m)	LIMIT (dBuV/m)	MARGIN (dB)	ANTENNA HEIGHT (m)	TABLE ANGLE (Degree)	RAW VALUE (dBuV)	CORRECTION FACTOR (dB/m)
1	*5610.00	109.6 PK			2.81 V	357	105.2	4.4
2	*5610.00	100.2 AV			2.81 V	357	95.8	4.4
3	#5725.00	67.8 PK	74.0	-6.2	2.81 V	357	63.4	4.4
4	#5725.00	53.9 AV	54.0	-0.1	2.81 V	357	49.5	4.4
5	11220.00	43.3 PK	74.0	-30.7	2.17 V	196	29.6	13.7
6	11220.00	31.1 AV	54.0	-22.9	2.17 V	196	17.4	13.7
7	#16830.00	44.0 PK	74.0	-30.0	1.71 V	298	28.1	15.9
8	#16830.00	32.7 AV	54.0	-21.3	1.71 V	298	16.8	15.9

REMARKS:

1. Emission Level(dBuV/m) = Raw Value(dBuV) + Correction Factor(dB/m)
2. Correction Factor(dB/m) = Antenna Factor(dB/m) + Cable Factor(dB) – Pre-Amplifier Factor(dB)
3. The other emission levels were very low against the limit.
4. Margin value = Emission Level – Limit value
5. " * ": Fundamental frequency.
6. " # ": The radiated frequency is out of the restricted band.

CHANNEL	TX Channel 138	DETECTOR FUNCTION	Peak (PK)
FREQUENCY RANGE	1GHz ~ 40GHz		Average (AV)

ANTENNA POLARITY & TEST DISTANCE: HORIZONTAL AT 3 M

NO.	FREQ. (MHz)	EMISSION LEVEL (dBuV/m)	LIMIT (dBuV/m)	MARGIN (dB)	ANTENNA HEIGHT (m)	TABLE ANGLE (Degree)	RAW VALUE (dBuV)	CORRECTION FACTOR (dB/m)
1	#5470.00	60.3 PK	74.0	-13.7	1.28 H	160	56.1	4.2
2	#5470.00	40.0 AV	54.0	-14.0	1.28 H	160	35.8	4.2
3	*5690.00	109.2 PK			1.28 H	160	104.7	4.5
4	*5690.00	99.2 AV			1.28 H	160	94.7	4.5
5	#5850.00	63.8 PK	74.0	-10.2	1.28 H	160	59.3	4.5
6	#5850.00	52.2 AV	54.0	-1.8	1.28 H	160	47.7	4.5
7	11380.00	42.3 PK	74.0	-31.7	1.74 H	218	28.7	13.6
8	11380.00	29.9 AV	54.0	-24.1	1.74 H	218	16.3	13.6
9	#17070.00	44.3 PK	74.0	-29.7	1.92 H	360	27.0	17.3
10	#17070.00	31.9 AV	54.0	-22.1	1.92 H	360	14.6	17.3

ANTENNA POLARITY & TEST DISTANCE: VERTICAL AT 3 M

NO.	FREQ. (MHz)	EMISSION LEVEL (dBuV/m)	LIMIT (dBuV/m)	MARGIN (dB)	ANTENNA HEIGHT (m)	TABLE ANGLE (Degree)	RAW VALUE (dBuV)	CORRECTION FACTOR (dB/m)
1	#5470.00	63.9 PK	74.0	-10.1	2.87 V	338	59.7	4.2
2	#5470.00	43.2 AV	54.0	-10.8	2.87 V	338	39.0	4.2
3	*5690.00	112.7 PK			2.87 V	338	108.2	4.5
4	*5690.00	102.1 AV			2.87 V	338	97.6	4.5
5	#5850.00	68.5 PK	74.0	-5.5	2.87 V	338	64.0	4.5
6	#5850.00	53.9 AV	54.0	-0.1	2.87 V	338	49.4	4.5
7	11380.00	43.4 PK	74.0	-30.6	2.22 V	201	29.8	13.6
8	11380.00	31.3 AV	54.0	-22.7	2.22 V	201	17.7	13.6
9	#17070.00	44.5 PK	74.0	-29.5	1.80 V	303	27.2	17.3
10	#17070.00	33.2 AV	54.0	-20.8	1.80 V	303	15.9	17.3

REMARKS:

1. Emission Level(dBuV/m) = Raw Value(dBuV) + Correction Factor(dB/m)
2. Correction Factor(dB/m) = Antenna Factor(dB/m) + Cable Factor(dB) – Pre-Amplifier Factor(dB)
3. The other emission levels were very low against the limit.
4. Margin value = Emission Level – Limit value
5. " * ": Fundamental frequency.
6. " # ": The radiated frequency is out of the restricted band.

Below 1GHz Data:

802.11ac (VHT40)

CHANNEL	TX Channel 54	DETECTOR FUNCTION	Quasi-Peak (QP)
FREQUENCY RANGE	9kHz ~ 1GHz		

ANTENNA POLARITY & TEST DISTANCE: HORIZONTAL AT 3 M

NO.	FREQ. (MHz)	EMISSION LEVEL (dBuV/m)	LIMIT (dBuV/m)	MARGIN (dB)	ANTENNA HEIGHT (m)	TABLE ANGLE (Degree)	RAW VALUE (dBuV)	CORRECTION FACTOR (dB/m)
1	89.63	39.6 QP	43.5	-3.9	2.00 H	292	53.6	-14.0
2	98.00	37.7 QP	43.5	-5.8	2.00 H	272	50.5	-12.8
3	146.84	29.7 QP	43.5	-13.8	2.00 H	89	37.9	-8.2
4	204.02	29.7 QP	43.5	-13.8	2.00 H	75	41.2	-11.5
5	252.78	36.0 QP	46.0	-10.0	1.00 H	298	45.4	-9.4
6	307.88	34.2 QP	46.0	-11.8	1.00 H	303	41.4	-7.2

ANTENNA POLARITY & TEST DISTANCE: VERTICAL AT 3 M

NO.	FREQ. (MHz)	EMISSION LEVEL (dBuV/m)	LIMIT (dBuV/m)	MARGIN (dB)	ANTENNA HEIGHT (m)	TABLE ANGLE (Degree)	RAW VALUE (dBuV)	CORRECTION FACTOR (dB/m)
1	98.43	34.0 QP	43.5	-9.5	3.00 V	346	46.8	-12.8
2	147.22	28.8 QP	43.5	-14.7	1.00 V	0	37.0	-8.2
3	230.21	30.2 QP	46.0	-15.8	2.00 V	360	40.8	-10.6
4	249.97	29.2 QP	46.0	-16.8	1.00 V	360	38.8	-9.6
5	285.74	31.0 QP	46.0	-15.0	1.00 V	0	39.0	-8.0
6	414.77	25.5 QP	46.0	-20.5	1.00 V	351	30.4	-4.9

REMARKS:

1. Emission Level(dBuV/m) = Raw Value(dBuV) + Correction Factor(dB/m)
2. Correction Factor(dB/m) = Antenna Factor(dB/m) + Cable Factor(dB) – Pre-Amplifier Factor(dB)
3. The other emission levels were very low against the limit.
4. Margin value = Emission Level – Limit value

4.1.8 Test Results (Mode 2)

Above 1GHz Data:

802.11a

CHANNEL	TX Channel 52	DETECTOR FUNCTION	Peak (PK)
FREQUENCY RANGE	1GHz ~ 40GHz		Average (AV)

ANTENNA POLARITY & TEST DISTANCE: HORIZONTAL AT 3 M								
NO.	FREQ. (MHz)	EMISSION LEVEL (dBuV/m)	LIMIT (dBuV/m)	MARGIN (dB)	ANTENNA HEIGHT (m)	TABLE ANGLE (Degree)	RAW VALUE (dBuV)	CORRECTION FACTOR (dB/m)
1	5150.00	44.5 PK	74.0	-29.5	1.33 H	156	40.8	3.7
2	5150.00	33.8 AV	54.0	-20.2	1.33 H	156	30.1	3.7
3	*5260.00	117.6 PK			1.33 H	156	113.6	4.0
4	*5260.00	108.1 AV			1.33 H	156	104.1	4.0
5	#10520.00	50.1 PK	74.0	-23.9	1.87 H	217	36.9	13.2
6	#10520.00	38.0 AV	54.0	-16.0	1.87 H	217	24.8	13.2
7	15780.00	43.8 PK	74.0	-30.2	2.10 H	346	30.2	13.6
8	15780.00	32.3 AV	54.0	-21.7	2.10 H	346	18.7	13.6

ANTENNA POLARITY & TEST DISTANCE: VERTICAL AT 3 M								
NO.	FREQ. (MHz)	EMISSION LEVEL (dBuV/m)	LIMIT (dBuV/m)	MARGIN (dB)	ANTENNA HEIGHT (m)	TABLE ANGLE (Degree)	RAW VALUE (dBuV)	CORRECTION FACTOR (dB/m)
1	5150.00	49.2 PK	74.0	-24.8	2.80 V	336	45.5	3.7
2	5150.00	39.2 AV	54.0	-14.8	2.80 V	336	35.5	3.7
3	*5260.00	120.3 PK			2.80 V	336	116.3	4.0
4	*5260.00	110.8 AV			2.80 V	336	106.8	4.0
5	#10520.00	50.0 PK	74.0	-24.0	2.19 V	214	36.8	13.2
6	#10520.00	38.2 AV	54.0	-15.8	2.19 V	214	25.0	13.2
7	15780.00	44.2 PK	74.0	-29.8	1.80 V	295	30.6	13.6
8	15780.00	32.8 AV	54.0	-21.2	1.80 V	295	19.2	13.6

REMARKS:

- Emission Level(dBuV/m) = Raw Value(dBuV) + Correction Factor(dB/m)
- Correction Factor(dB/m) = Antenna Factor(dB/m) + Cable Factor(dB) – Pre-Amplifier Factor(dB)
- The other emission levels were very low against the limit.
- Margin value = Emission Level – Limit value
- " * ": Fundamental frequency.
- " # ": The radiated frequency is out of the restricted band.

CHANNEL	TX Channel 60	DETECTOR FUNCTION	Peak (PK)
FREQUENCY RANGE	1GHz ~ 40GHz		Average (AV)

ANTENNA POLARITY & TEST DISTANCE: HORIZONTAL AT 3 M

NO.	FREQ. (MHz)	EMISSION LEVEL (dBuV/m)	LIMIT (dBuV/m)	MARGIN (dB)	ANTENNA HEIGHT (m)	TABLE ANGLE (Degree)	RAW VALUE (dBuV)	CORRECTION FACTOR (dB/m)
1	5150.00	45.1 PK	74.0	-28.9	1.39 H	164	41.4	3.7
2	5150.00	34.5 AV	54.0	-19.5	1.39 H	164	30.8	3.7
3	*5300.00	117.8 PK			1.39 H	164	113.7	4.1
4	*5300.00	108.3 AV			1.39 H	164	104.2	4.1
5	5350.00	63.5 PK	74.0	-10.5	1.39 H	164	59.4	4.1
6	5350.00	51.9 AV	54.0	-2.1	1.39 H	164	47.8	4.1
7	10600.00	49.7 PK	74.0	-24.3	1.92 H	231	36.2	13.5
8	10600.00	37.8 AV	54.0	-16.2	1.92 H	231	24.3	13.5
9	15900.00	44.1 PK	74.0	-29.9	2.13 H	338	31.2	12.9
10	15900.00	32.5 AV	54.0	-21.5	2.13 H	338	19.6	12.9

ANTENNA POLARITY & TEST DISTANCE: VERTICAL AT 3 M

NO.	FREQ. (MHz)	EMISSION LEVEL (dBuV/m)	LIMIT (dBuV/m)	MARGIN (dB)	ANTENNA HEIGHT (m)	TABLE ANGLE (Degree)	RAW VALUE (dBuV)	CORRECTION FACTOR (dB/m)
1	5150.00	48.3 PK	74.0	-25.7	2.76 V	333	44.6	3.7
2	5150.00	38.7 AV	54.0	-15.3	2.76 V	333	35.0	3.7
3	*5300.00	121.2 PK			2.76 V	333	117.1	4.1
4	*5300.00	111.3 AV			2.76 V	333	107.2	4.1
5	5350.00	66.9 PK	74.0	-7.1	2.76 V	333	62.8	4.1
6	5350.00	53.3 AV	54.0	-0.7	2.76 V	333	49.2	4.1
7	10600.00	49.5 PK	74.0	-24.5	2.14 V	224	36.0	13.5
8	10600.00	38.2 AV	54.0	-15.8	2.14 V	224	24.7	13.5
9	15900.00	45.3 PK	74.0	-28.7	1.79 V	312	32.4	12.9
10	15900.00	33.5 AV	54.0	-20.5	1.79 V	312	20.6	12.9

REMARKS:

1. Emission Level(dBuV/m) = Raw Value(dBuV) + Correction Factor(dB/m)
2. Correction Factor(dB/m) = Antenna Factor(dB/m) + Cable Factor(dB) – Pre-Amplifier Factor(dB)
3. The other emission levels were very low against the limit.
4. Margin value = Emission Level – Limit value
5. " * ": Fundamental frequency.

CHANNEL	TX Channel 64	DETECTOR FUNCTION	Peak (PK)
FREQUENCY RANGE	1GHz ~ 40GHz		Average (AV)

ANTENNA POLARITY & TEST DISTANCE: HORIZONTAL AT 3 M

NO.	FREQ. (MHz)	EMISSION LEVEL (dBuV/m)	LIMIT (dBuV/m)	MARGIN (dB)	ANTENNA HEIGHT (m)	TABLE ANGLE (Degree)	RAW VALUE (dBuV)	CORRECTION FACTOR (dB/m)
1	*5320.00	115.8 PK			1.36 H	161	111.7	4.1
2	*5320.00	105.8 AV			1.36 H	161	101.7	4.1
3	5350.00	62.6 PK	74.0	-11.4	1.36 H	161	58.5	4.1
4	5350.00	51.3 AV	54.0	-2.7	1.36 H	161	47.2	4.1
5	10640.00	50.1 PK	74.0	-23.9	1.91 H	212	36.6	13.5
6	10640.00	38.1 AV	54.0	-15.9	1.91 H	212	24.6	13.5
7	15960.00	44.1 PK	74.0	-29.9	2.04 H	353	31.2	12.9
8	15960.00	32.2 AV	54.0	-21.8	2.04 H	353	19.3	12.9

ANTENNA POLARITY & TEST DISTANCE: VERTICAL AT 3 M

NO.	FREQ. (MHz)	EMISSION LEVEL (dBuV/m)	LIMIT (dBuV/m)	MARGIN (dB)	ANTENNA HEIGHT (m)	TABLE ANGLE (Degree)	RAW VALUE (dBuV)	CORRECTION FACTOR (dB/m)
1	*5320.00	118.2 PK			2.80 V	336	114.1	4.1
2	*5320.00	108.2 AV			2.80 V	336	104.1	4.1
3	5350.00	65.9 PK	74.0	-8.1	2.80 V	336	61.8	4.1
4	5350.00	53.7 AV	54.0	-0.3	2.80 V	336	49.6	4.1
5	10640.00	50.3 PK	74.0	-23.7	2.17 V	210	36.8	13.5
6	10640.00	38.7 AV	54.0	-15.3	2.17 V	210	25.2	13.5
7	15960.00	44.5 PK	74.0	-29.5	1.70 V	302	31.6	12.9
8	15960.00	33.0 AV	54.0	-21.0	1.70 V	302	20.1	12.9

REMARKS:

1. Emission Level(dBuV/m) = Raw Value(dBuV) + Correction Factor(dB/m)
2. Correction Factor(dB/m) = Antenna Factor(dB/m) + Cable Factor(dB) – Pre-Amplifier Factor(dB)
3. The other emission levels were very low against the limit.
4. Margin value = Emission Level – Limit value
5. " * ": Fundamental frequency.

CHANNEL	TX Channel 100	DETECTOR FUNCTION	Peak (PK)
FREQUENCY RANGE	1GHz ~ 40GHz		Average (AV)

ANTENNA POLARITY & TEST DISTANCE: HORIZONTAL AT 3 M

NO.	FREQ. (MHz)	EMISSION LEVEL (dBuV/m)	LIMIT (dBuV/m)	MARGIN (dB)	ANTENNA HEIGHT (m)	TABLE ANGLE (Degree)	RAW VALUE (dBuV)	CORRECTION FACTOR (dB/m)
1	#5470.00	63.4 PK	74.0	-10.6	1.40 H	151	59.2	4.2
2	#5470.00	52.0 AV	54.0	-2.0	1.40 H	151	47.8	4.2
3	*5500.00	112.4 PK			1.40 H	151	108.2	4.2
4	*5500.00	103.0 AV			1.40 H	151	98.8	4.2
5	11000.00	50.5 PK	74.0	-23.5	1.90 H	205	36.4	14.1
6	11000.00	38.3 AV	54.0	-15.7	1.90 H	205	24.2	14.1
7	#16500.00	44.1 PK	74.0	-29.9	2.08 H	357	29.6	14.5
8	#16500.00	32.4 AV	54.0	-21.6	2.08 H	357	17.9	14.5

ANTENNA POLARITY & TEST DISTANCE: VERTICAL AT 3 M

NO.	FREQ. (MHz)	EMISSION LEVEL (dBuV/m)	LIMIT (dBuV/m)	MARGIN (dB)	ANTENNA HEIGHT (m)	TABLE ANGLE (Degree)	RAW VALUE (dBuV)	CORRECTION FACTOR (dB/m)
1	#5470.00	69.2 PK	74.0	-4.8	2.77 V	330	65.0	4.2
2	#5470.00	53.9 AV	54.0	-0.1	2.77 V	330	49.7	4.2
3	*5500.00	115.6 PK			2.77 V	330	111.4	4.2
4	*5500.00	106.2 AV			2.77 V	330	102.0	4.2
5	11000.00	49.7 PK	74.0	-24.3	2.07 V	206	35.6	14.1
6	11000.00	38.2 AV	54.0	-15.8	2.07 V	206	24.1	14.1
7	#16500.00	44.7 PK	74.0	-29.3	1.72 V	287	30.2	14.5
8	#16500.00	33.2 AV	54.0	-20.8	1.72 V	287	18.7	14.5

REMARKS:

1. Emission Level(dBuV/m) = Raw Value(dBuV) + Correction Factor(dB/m)
2. Correction Factor(dB/m) = Antenna Factor(dB/m) + Cable Factor(dB) – Pre-Amplifier Factor(dB)
3. The other emission levels were very low against the limit.
4. Margin value = Emission Level – Limit value
5. " * ": Fundamental frequency.
6. " # ": The radiated frequency is out of the restricted band.

CHANNEL	TX Channel 116	DETECTOR FUNCTION	Peak (PK)
FREQUENCY RANGE	1GHz ~ 40GHz		Average (AV)

ANTENNA POLARITY & TEST DISTANCE: HORIZONTAL AT 3 M

NO.	FREQ. (MHz)	EMISSION LEVEL (dBuV/m)	LIMIT (dBuV/m)	MARGIN (dB)	ANTENNA HEIGHT (m)	TABLE ANGLE (Degree)	RAW VALUE (dBuV)	CORRECTION FACTOR (dB/m)
1	#5470.00	45.6 PK	74.0	-28.4	1.37 H	178	41.4	4.2
2	#5470.00	34.6 AV	54.0	-19.4	1.37 H	178	30.4	4.2
3	*5580.00	116.6 PK			1.37 H	178	112.4	4.2
4	*5580.00	107.4 AV			1.37 H	178	103.2	4.2
5	#5959.00	46.4 PK	74.0	-27.6	1.37 H	178	41.7	4.7
6	#5959.00	35.4 AV	54.0	-18.6	1.37 H	178	30.7	4.7
7	11160.00	49.7 PK	74.0	-24.3	1.87 H	230	36.0	13.7
8	11160.00	37.9 AV	54.0	-16.1	1.87 H	230	24.2	13.7
9	#16740.00	43.3 PK	74.0	-30.7	2.10 H	350	27.6	15.7
10	#16740.00	31.8 AV	54.0	-22.2	2.10 H	350	16.1	15.7

ANTENNA POLARITY & TEST DISTANCE: VERTICAL AT 3 M

NO.	FREQ. (MHz)	EMISSION LEVEL (dBuV/m)	LIMIT (dBuV/m)	MARGIN (dB)	ANTENNA HEIGHT (m)	TABLE ANGLE (Degree)	RAW VALUE (dBuV)	CORRECTION FACTOR (dB/m)
1	#5470.00	50.8 PK	74.0	-23.2	2.77 V	324	46.6	4.2
2	#5470.00	38.9 AV	54.0	-15.1	2.77 V	324	34.7	4.2
3	*5580.00	119.9 PK			2.77 V	324	115.7	4.2
4	*5580.00	110.1 AV			2.77 V	324	105.9	4.2
5	#5959.00	49.7 PK	74.0	-24.3	2.77 V	324	45.0	4.7
6	#5959.00	38.9 AV	54.0	-15.1	2.77 V	324	34.2	4.7
7	11160.00	49.6 PK	74.0	-24.4	2.18 V	206	35.9	13.7
8	11160.00	38.0 AV	54.0	-16.0	2.18 V	206	24.3	13.7
9	#16740.00	44.5 PK	74.0	-29.5	1.78 V	299	28.8	15.7
10	#16740.00	33.2 AV	54.0	-20.8	1.78 V	299	17.5	15.7

REMARKS:

1. Emission Level(dBuV/m) = Raw Value(dBuV) + Correction Factor(dB/m)
2. Correction Factor(dB/m) = Antenna Factor(dB/m) + Cable Factor(dB) – Pre-Amplifier Factor(dB)
3. The other emission levels were very low against the limit.
4. Margin value = Emission Level – Limit value
5. " * ": Fundamental frequency.
6. " # ": The radiated frequency is out of the restricted band.

CHANNEL	TX Channel 140	DETECTOR FUNCTION	Peak (PK)
FREQUENCY RANGE	1GHz ~ 40GHz		Average (AV)

ANTENNA POLARITY & TEST DISTANCE: HORIZONTAL AT 3 M

NO.	FREQ. (MHz)	EMISSION LEVEL (dBuV/m)	LIMIT (dBuV/m)	MARGIN (dB)	ANTENNA HEIGHT (m)	TABLE ANGLE (Degree)	RAW VALUE (dBuV)	CORRECTION FACTOR (dB/m)
1	*5700.00	114.1 PK			1.41 H	168	109.6	4.5
2	*5700.00	103.2 AV			1.41 H	168	98.7	4.5
3	#5725.00	63.6 PK	74.0	-10.4	1.41 H	168	59.2	4.4
4	#5725.00	51.7 AV	54.0	-2.3	1.41 H	168	47.3	4.4
5	11400.00	50.1 PK	74.0	-23.9	1.83 H	224	36.5	13.6
6	11400.00	37.8 AV	54.0	-16.2	1.83 H	224	24.2	13.6
7	#17100.00	44.4 PK	74.0	-29.6	2.03 H	358	27.0	17.4
8	#17100.00	32.7 AV	54.0	-21.3	2.03 H	358	15.3	17.4

ANTENNA POLARITY & TEST DISTANCE: VERTICAL AT 3 M

NO.	FREQ. (MHz)	EMISSION LEVEL (dBuV/m)	LIMIT (dBuV/m)	MARGIN (dB)	ANTENNA HEIGHT (m)	TABLE ANGLE (Degree)	RAW VALUE (dBuV)	CORRECTION FACTOR (dB/m)
1	*5700.00	117.3 PK			2.76 V	331	112.8	4.5
2	*5700.00	106.3 AV			2.76 V	331	101.8	4.5
3	#5725.00	64.5 PK	74.0	-9.5	2.76 V	331	60.1	4.4
4	#5725.00	53.9 AV	54.0	-0.1	2.76 V	331	49.5	4.4
5	11400.00	49.9 PK	74.0	-24.1	2.11 V	230	36.3	13.6
6	11400.00	38.4 AV	54.0	-15.6	2.11 V	230	24.8	13.6
7	#17100.00	44.6 PK	74.0	-29.4	1.72 V	293	27.2	17.4
8	#17100.00	33.0 AV	54.0	-21.0	1.72 V	293	15.6	17.4

REMARKS:

1. Emission Level(dBuV/m) = Raw Value(dBuV) + Correction Factor(dB/m)
2. Correction Factor(dB/m) = Antenna Factor(dB/m) + Cable Factor(dB) – Pre-Amplifier Factor(dB)
3. The other emission levels were very low against the limit.
4. Margin value = Emission Level – Limit value
5. " * ": Fundamental frequency.
6. " # ": The radiated frequency is out of the restricted band.

CHANNEL	TX Channel 144	DETECTOR FUNCTION	Peak (PK)
FREQUENCY RANGE	1GHz ~ 40GHz		Average (AV)

ANTENNA POLARITY & TEST DISTANCE: HORIZONTAL AT 3 M

NO.	FREQ. (MHz)	EMISSION LEVEL (dBuV/m)	LIMIT (dBuV/m)	MARGIN (dB)	ANTENNA HEIGHT (m)	TABLE ANGLE (Degree)	RAW VALUE (dBuV)	CORRECTION FACTOR (dB/m)
1	#5470.00	45.9 PK	74.0	-28.1	1.30 H	179	41.7	4.2
2	#5470.00	35.0 AV	54.0	-19.0	1.30 H	179	30.8	4.2
3	*5720.00	115.9 PK			1.30 H	179	111.5	4.4
4	*5720.00	106.0 AV			1.30 H	179	101.6	4.4
5	#5912.00	46.1 PK	74.0	-27.9	1.30 H	179	41.5	4.6
6	#5912.00	35.2 AV	54.0	-18.8	1.30 H	179	30.6	4.6
7	11440.00	50.5 PK	74.0	-23.5	1.79 H	239	37.0	13.5
8	11440.00	38.1 AV	54.0	-15.9	1.79 H	239	24.6	13.5
9	#17160.00	44.4 PK	74.0	-29.6	2.00 H	355	27.1	17.3
10	#17160.00	32.5 AV	54.0	-21.5	2.00 H	355	15.2	17.3

ANTENNA POLARITY & TEST DISTANCE: VERTICAL AT 3 M

NO.	FREQ. (MHz)	EMISSION LEVEL (dBuV/m)	LIMIT (dBuV/m)	MARGIN (dB)	ANTENNA HEIGHT (m)	TABLE ANGLE (Degree)	RAW VALUE (dBuV)	CORRECTION FACTOR (dB/m)
1	#5470.00	49.8 PK	74.0	-24.2	2.66 V	324	45.6	4.2
2	#5470.00	37.3 AV	54.0	-16.7	2.66 V	324	33.1	4.2
3	*5720.00	119.2 PK			2.66 V	324	114.8	4.4
4	*5720.00	109.2 AV			2.66 V	324	104.8	4.4
5	#5912.00	50.3 PK	74.0	-23.7	2.66 V	325	45.7	4.6
6	#5912.00	39.2 AV	54.0	-14.8	2.66 V	325	34.6	4.6
7	11440.00	50.0 PK	74.0	-24.0	2.07 V	229	36.5	13.5
8	11440.00	38.3 AV	54.0	-15.7	2.07 V	229	24.8	13.5
9	#17160.00	44.7 PK	74.0	-29.3	1.78 V	314	27.4	17.3
10	#17160.00	32.9 AV	54.0	-21.1	1.78 V	314	15.6	17.3

REMARKS:

1. Emission Level(dBuV/m) = Raw Value(dBuV) + Correction Factor(dB/m)
2. Correction Factor(dB/m) = Antenna Factor(dB/m) + Cable Factor(dB) – Pre-Amplifier Factor(dB)
3. The other emission levels were very low against the limit.
4. Margin value = Emission Level – Limit value
5. " * ": Fundamental frequency.
6. " # ": The radiated frequency is out of the restricted band.

802.11ac (VHT20)

CHANNEL	TX Channel 52	DETECTOR FUNCTION	Peak (PK)
FREQUENCY RANGE	1GHz ~ 40GHz		Average (AV)

ANTENNA POLARITY & TEST DISTANCE: HORIZONTAL AT 3 M

NO.	FREQ. (MHz)	EMISSION LEVEL (dBuV/m)	LIMIT (dBuV/m)	MARGIN (dB)	ANTENNA HEIGHT (m)	TABLE ANGLE (Degree)	RAW VALUE (dBuV)	CORRECTION FACTOR (dB/m)
1	5150.00	46.0 PK	74.0	-28.0	1.37 H	149	42.3	3.7
2	5150.00	34.7 AV	54.0	-19.3	1.37 H	149	31.0	3.7
3	*5260.00	116.2 PK			1.37 H	149	112.2	4.0
4	*5260.00	106.4 AV			1.37 H	149	102.4	4.0
5	#10520.00	49.9 PK	74.0	-24.1	1.88 H	234	36.7	13.2
6	#10520.00	37.4 AV	54.0	-16.6	1.88 H	234	24.2	13.2
7	15780.00	45.0 PK	74.0	-29.0	2.01 H	355	31.4	13.6
8	15780.00	33.2 AV	54.0	-20.8	2.01 H	355	19.6	13.6

ANTENNA POLARITY & TEST DISTANCE: VERTICAL AT 3 M

NO.	FREQ. (MHz)	EMISSION LEVEL (dBuV/m)	LIMIT (dBuV/m)	MARGIN (dB)	ANTENNA HEIGHT (m)	TABLE ANGLE (Degree)	RAW VALUE (dBuV)	CORRECTION FACTOR (dB/m)
1	5150.00	49.3 PK	74.0	-24.7	2.97 V	336	45.6	3.7
2	5150.00	38.5 AV	54.0	-15.5	2.97 V	336	34.8	3.7
3	*5260.00	119.5 PK			2.97 V	336	115.5	4.0
4	*5260.00	109.6 AV			2.97 V	336	105.6	4.0
5	#10520.00	49.9 PK	74.0	-24.1	2.09 V	216	36.7	13.2
6	#10520.00	38.5 AV	54.0	-15.5	2.09 V	216	25.3	13.2
7	15780.00	44.1 PK	74.0	-29.9	1.77 V	304	30.5	13.6
8	15780.00	32.7 AV	54.0	-21.3	1.77 V	304	19.1	13.6

REMARKS:

- Emission Level(dBuV/m) = Raw Value(dBuV) + Correction Factor(dB/m)
- Correction Factor(dB/m) = Antenna Factor(dB/m) + Cable Factor(dB) – Pre-Amplifier Factor(dB)
- The other emission levels were very low against the limit.
- Margin value = Emission Level – Limit value
- " * ": Fundamental frequency.
- " # ": The radiated frequency is out of the restricted band.

CHANNEL	TX Channel 60	DETECTOR FUNCTION	Peak (PK)
FREQUENCY RANGE	1GHz ~ 40GHz		Average (AV)

ANTENNA POLARITY & TEST DISTANCE: HORIZONTAL AT 3 M

NO.	FREQ. (MHz)	EMISSION LEVEL (dBuV/m)	LIMIT (dBuV/m)	MARGIN (dB)	ANTENNA HEIGHT (m)	TABLE ANGLE (Degree)	RAW VALUE (dBuV)	CORRECTION FACTOR (dB/m)
1	5150.00	45.3 PK	74.0	-28.7	1.39 H	152	41.6	3.7
2	5150.00	34.3 AV	54.0	-19.7	1.39 H	152	30.6	3.7
3	*5300.00	117.3 PK			1.39 H	152	113.2	4.1
4	*5300.00	107.1 AV			1.39 H	152	103.0	4.1
5	5350.00	59.5 PK	74.0	-14.5	1.39 H	152	55.4	4.1
6	5350.00	43.2 AV	54.0	-10.8	1.39 H	152	39.1	4.1
7	10600.00	49.8 PK	74.0	-24.2	1.86 H	216	36.3	13.5
8	10600.00	37.6 AV	54.0	-16.4	1.86 H	216	24.1	13.5
9	15900.00	44.4 PK	74.0	-29.6	2.07 H	360	31.5	12.9
10	15900.00	32.4 AV	54.0	-21.6	2.07 H	360	19.5	12.9

ANTENNA POLARITY & TEST DISTANCE: VERTICAL AT 3 M

NO.	FREQ. (MHz)	EMISSION LEVEL (dBuV/m)	LIMIT (dBuV/m)	MARGIN (dB)	ANTENNA HEIGHT (m)	TABLE ANGLE (Degree)	RAW VALUE (dBuV)	CORRECTION FACTOR (dB/m)
1	5150.00	48.9 PK	74.0	-25.1	2.98 V	333	45.2	3.7
2	5150.00	37.9 AV	54.0	-16.1	2.98 V	333	34.2	3.7
3	*5300.00	121.3 PK			2.98 V	333	117.2	4.1
4	*5300.00	110.1 AV			2.98 V	333	106.0	4.1
5	5350.00	61.7 PK	74.0	-12.3	2.98 V	333	57.6	4.1
6	5350.00	49.4 AV	54.0	-4.6	2.98 V	333	45.3	4.1
7	10600.00	49.7 PK	74.0	-24.3	2.14 V	212	36.2	13.5
8	10600.00	38.3 AV	54.0	-15.7	2.14 V	212	24.8	13.5
9	15900.00	44.8 PK	74.0	-29.2	1.77 V	289	31.9	12.9
10	15900.00	33.4 AV	54.0	-20.6	1.77 V	289	20.5	12.9

REMARKS:

1. Emission Level(dBuV/m) = Raw Value(dBuV) + Correction Factor(dB/m)
2. Correction Factor(dB/m) = Antenna Factor(dB/m) + Cable Factor(dB) – Pre-Amplifier Factor(dB)
3. The other emission levels were very low against the limit.
4. Margin value = Emission Level – Limit value
5. " * ": Fundamental frequency.

CHANNEL	TX Channel 64	DETECTOR FUNCTION	Peak (PK)
FREQUENCY RANGE	1GHz ~ 40GHz		Average (AV)

ANTENNA POLARITY & TEST DISTANCE: HORIZONTAL AT 3 M

NO.	FREQ. (MHz)	EMISSION LEVEL (dBuV/m)	LIMIT (dBuV/m)	MARGIN (dB)	ANTENNA HEIGHT (m)	TABLE ANGLE (Degree)	RAW VALUE (dBuV)	CORRECTION FACTOR (dB/m)
1	*5320.00	114.2 PK			1.34 H	154	110.1	4.1
2	*5320.00	104.0 AV			1.34 H	154	99.9	4.1
3	5350.00	63.4 PK	74.0	-10.6	1.34 H	154	59.3	4.1
4	5350.00	52.0 AV	54.0	-2.0	1.34 H	154	47.9	4.1
5	10640.00	49.7 PK	74.0	-24.3	1.85 H	239	36.2	13.5
6	10640.00	37.3 AV	54.0	-16.7	1.85 H	239	23.8	13.5
7	15960.00	44.7 PK	74.0	-29.3	2.07 H	356	31.8	12.9
8	15960.00	32.9 AV	54.0	-21.1	2.07 H	356	20.0	12.9

ANTENNA POLARITY & TEST DISTANCE: VERTICAL AT 3 M

NO.	FREQ. (MHz)	EMISSION LEVEL (dBuV/m)	LIMIT (dBuV/m)	MARGIN (dB)	ANTENNA HEIGHT (m)	TABLE ANGLE (Degree)	RAW VALUE (dBuV)	CORRECTION FACTOR (dB/m)
1	*5320.00	117.2 PK			2.93 V	329	113.1	4.1
2	*5320.00	107.2 AV			2.93 V	329	103.1	4.1
3	5350.00	66.6 PK	74.0	-7.4	2.93 V	329	62.5	4.1
4	5350.00	53.6 AV	54.0	-0.4	2.93 V	329	49.5	4.1
5	10640.00	49.8 PK	74.0	-24.2	2.13 V	212	36.3	13.5
6	10640.00	38.1 AV	54.0	-15.9	2.13 V	212	24.6	13.5
7	15960.00	44.5 PK	74.0	-29.5	1.76 V	300	31.6	12.9
8	15960.00	33.2 AV	54.0	-20.8	1.76 V	300	20.3	12.9

REMARKS:

1. Emission Level(dBuV/m) = Raw Value(dBuV) + Correction Factor(dB/m)
2. Correction Factor(dB/m) = Antenna Factor(dB/m) + Cable Factor(dB) – Pre-Amplifier Factor(dB)
3. The other emission levels were very low against the limit.
4. Margin value = Emission Level – Limit value
5. " * ": Fundamental frequency.

CHANNEL	TX Channel 100	DETECTOR FUNCTION	Peak (PK)
FREQUENCY RANGE	1GHz ~ 40GHz		Average (AV)

ANTENNA POLARITY & TEST DISTANCE: HORIZONTAL AT 3 M

NO.	FREQ. (MHz)	EMISSION LEVEL (dBuV/m)	LIMIT (dBuV/m)	MARGIN (dB)	ANTENNA HEIGHT (m)	TABLE ANGLE (Degree)	RAW VALUE (dBuV)	CORRECTION FACTOR (dB/m)
1	#5470.00	63.8 PK	74.0	-10.2	1.41 H	177	59.6	4.2
2	#5470.00	52.1 AV	54.0	-1.9	1.41 H	177	47.9	4.2
3	*5500.00	112.9 PK			1.41 H	177	108.7	4.2
4	*5500.00	102.4 AV			1.41 H	177	98.2	4.2
5	11000.00	49.6 PK	74.0	-24.4	1.84 H	222	35.5	14.1
6	11000.00	37.5 AV	54.0	-16.5	1.84 H	222	23.4	14.1
7	#16500.00	43.6 PK	74.0	-30.4	2.05 H	360	29.1	14.5
8	#16500.00	32.2 AV	54.0	-21.8	2.05 H	360	17.7	14.5

ANTENNA POLARITY & TEST DISTANCE: VERTICAL AT 3 M

NO.	FREQ. (MHz)	EMISSION LEVEL (dBuV/m)	LIMIT (dBuV/m)	MARGIN (dB)	ANTENNA HEIGHT (m)	TABLE ANGLE (Degree)	RAW VALUE (dBuV)	CORRECTION FACTOR (dB/m)
1	#5470.00	68.1 PK	74.0	-5.9	2.86 V	332	63.9	4.2
2	#5470.00	53.9 AV	54.0	-0.1	2.86 V	332	49.7	4.2
3	*5500.00	116.3 PK			2.86 V	332	112.1	4.2
4	*5500.00	105.9 AV			2.86 V	332	101.7	4.2
5	11000.00	49.3 PK	74.0	-24.7	2.13 V	219	35.2	14.1
6	11000.00	37.8 AV	54.0	-16.2	2.13 V	219	23.7	14.1
7	#16500.00	43.9 PK	74.0	-30.1	1.77 V	288	29.4	14.5
8	#16500.00	32.6 AV	54.0	-21.4	1.77 V	288	18.1	14.5

REMARKS:

1. Emission Level(dBuV/m) = Raw Value(dBuV) + Correction Factor(dB/m)
2. Correction Factor(dB/m) = Antenna Factor(dB/m) + Cable Factor(dB) – Pre-Amplifier Factor(dB)
3. The other emission levels were very low against the limit.
4. Margin value = Emission Level – Limit value
5. " * ": Fundamental frequency.
6. " # ": The radiated frequency is out of the restricted band.

CHANNEL	TX Channel 116	DETECTOR FUNCTION	Peak (PK)
FREQUENCY RANGE	1GHz ~ 40GHz		Average (AV)

ANTENNA POLARITY & TEST DISTANCE: HORIZONTAL AT 3 M

NO.	FREQ. (MHz)	EMISSION LEVEL (dBuV/m)	LIMIT (dBuV/m)	MARGIN (dB)	ANTENNA HEIGHT (m)	TABLE ANGLE (Degree)	RAW VALUE (dBuV)	CORRECTION FACTOR (dB/m)
1	#5470.00	46.2 PK	74.0	-27.8	1.34 H	178	42.0	4.2
2	#5470.00	35.4 AV	54.0	-18.6	1.34 H	178	31.2	4.2
3	*5580.00	115.3 PK			1.34 H	178	111.1	4.2
4	*5580.00	105.2 AV			1.34 H	178	101.0	4.2
5	#5961.00	45.6 PK	74.0	-28.4	1.34 H	178	40.9	4.7
6	#5961.00	34.9 AV	54.0	-19.1	1.34 H	178	30.2	4.7
7	11160.00	49.7 PK	74.0	-24.3	1.86 H	230	36.0	13.7
8	11160.00	37.4 AV	54.0	-16.6	1.86 H	230	23.7	13.7
9	#16740.00	43.8 PK	74.0	-30.2	2.09 H	360	28.1	15.7
10	#16740.00	32.3 AV	54.0	-21.7	2.09 H	360	16.6	15.7

ANTENNA POLARITY & TEST DISTANCE: VERTICAL AT 3 M

NO.	FREQ. (MHz)	EMISSION LEVEL (dBuV/m)	LIMIT (dBuV/m)	MARGIN (dB)	ANTENNA HEIGHT (m)	TABLE ANGLE (Degree)	RAW VALUE (dBuV)	CORRECTION FACTOR (dB/m)
1	#5470.00	50.7 PK	74.0	-23.3	2.92 V	331	46.5	4.2
2	#5470.00	38.7 AV	54.0	-15.3	2.92 V	331	34.5	4.2
3	*5580.00	118.8 PK			2.92 V	331	114.6	4.2
4	*5580.00	108.8 AV			2.92 V	331	104.6	4.2
5	#5961.00	50.3 PK	74.0	-23.7	2.92 V	331	45.6	4.7
6	#5961.00	39.0 AV	54.0	-15.0	2.92 V	331	34.3	4.7
7	11160.00	49.5 PK	74.0	-24.5	2.18 V	202	35.8	13.7
8	11160.00	38.2 AV	54.0	-15.8	2.18 V	202	24.5	13.7
9	#16740.00	44.6 PK	74.0	-29.4	1.76 V	292	28.9	15.7
10	#16740.00	33.1 AV	54.0	-20.9	1.76 V	292	17.4	15.7

REMARKS:

1. Emission Level(dBuV/m) = Raw Value(dBuV) + Correction Factor(dB/m)
2. Correction Factor(dB/m) = Antenna Factor(dB/m) + Cable Factor(dB) – Pre-Amplifier Factor(dB)
3. The other emission levels were very low against the limit.
4. Margin value = Emission Level – Limit value
5. " * ": Fundamental frequency.
6. " # ": The radiated frequency is out of the restricted band.

CHANNEL	TX Channel 140	DETECTOR FUNCTION	Peak (PK)
FREQUENCY RANGE	1GHz ~ 40GHz		Average (AV)

ANTENNA POLARITY & TEST DISTANCE: HORIZONTAL AT 3 M

NO.	FREQ. (MHz)	EMISSION LEVEL (dBuV/m)	LIMIT (dBuV/m)	MARGIN (dB)	ANTENNA HEIGHT (m)	TABLE ANGLE (Degree)	RAW VALUE (dBuV)	CORRECTION FACTOR (dB/m)
1	*5700.00	112.7 PK			1.41 H	158	108.2	4.5
2	*5700.00	102.9 AV			1.41 H	158	98.4	4.5
3	#5725.00	63.2 PK	74.0	-10.8	1.41 H	158	58.8	4.4
4	#5725.00	51.6 AV	54.0	-2.4	1.41 H	158	47.2	4.4
5	11400.00	50.3 PK	74.0	-23.7	1.84 H	236	36.7	13.6
6	11400.00	38.0 AV	54.0	-16.0	1.84 H	236	24.4	13.6
7	#17100.00	44.8 PK	74.0	-29.2	2.07 H	357	27.4	17.4
8	#17100.00	32.8 AV	54.0	-21.2	2.07 H	357	15.4	17.4

ANTENNA POLARITY & TEST DISTANCE: VERTICAL AT 3 M

NO.	FREQ. (MHz)	EMISSION LEVEL (dBuV/m)	LIMIT (dBuV/m)	MARGIN (dB)	ANTENNA HEIGHT (m)	TABLE ANGLE (Degree)	RAW VALUE (dBuV)	CORRECTION FACTOR (dB/m)
1	*5700.00	116.0 PK			2.98 V	328	111.5	4.5
2	*5700.00	106.1 AV			2.98 V	328	101.6	4.5
3	#5725.00	67.8 PK	74.0	-6.2	2.98 V	328	63.4	4.4
4	#5725.00	53.9 AV	54.0	-0.1	2.98 V	328	49.5	4.4
5	11400.00	49.8 PK	74.0	-24.2	2.18 V	216	36.2	13.6
6	11400.00	38.4 AV	54.0	-15.6	2.18 V	216	24.8	13.6
7	#17100.00	44.8 PK	74.0	-29.2	1.71 V	281	27.4	17.4
8	#17100.00	33.0 AV	54.0	-21.0	1.71 V	281	15.6	17.4

REMARKS:

1. Emission Level(dBuV/m) = Raw Value(dBuV) + Correction Factor(dB/m)
2. Correction Factor(dB/m) = Antenna Factor(dB/m) + Cable Factor(dB) – Pre-Amplifier Factor(dB)
3. The other emission levels were very low against the limit.
4. Margin value = Emission Level – Limit value
5. " * ": Fundamental frequency.
6. " # ": The radiated frequency is out of the restricted band.

CHANNEL	TX Channel 144	DETECTOR FUNCTION	Peak (PK)
FREQUENCY RANGE	1GHz ~ 40GHz		Average (AV)

ANTENNA POLARITY & TEST DISTANCE: HORIZONTAL AT 3 M

NO.	FREQ. (MHz)	EMISSION LEVEL (dBuV/m)	LIMIT (dBuV/m)	MARGIN (dB)	ANTENNA HEIGHT (m)	TABLE ANGLE (Degree)	RAW VALUE (dBuV)	CORRECTION FACTOR (dB/m)
1	#5470.00	44.9 PK	74.0	-29.1	1.38 H	166	40.7	4.2
2	#5470.00	34.2 AV	54.0	-19.8	1.38 H	166	30.0	4.2
3	*5720.00	113.0 PK			1.38 H	166	108.6	4.4
4	*5720.00	103.2 AV			1.38 H	166	98.8	4.4
5	#5913.00	46.3 PK	74.0	-27.7	1.38 H	166	41.7	4.6
6	#5913.00	35.1 AV	54.0	-18.9	1.38 H	166	30.5	4.6
7	11440.00	49.9 PK	74.0	-24.1	1.86 H	231	36.4	13.5
8	11440.00	37.9 AV	54.0	-16.1	1.86 H	231	24.4	13.5
9	#17160.00	44.3 PK	74.0	-29.7	2.00 H	360	27.0	17.3
10	#17160.00	32.6 AV	54.0	-21.4	2.00 H	360	15.3	17.3

ANTENNA POLARITY & TEST DISTANCE: VERTICAL AT 3 M

NO.	FREQ. (MHz)	EMISSION LEVEL (dBuV/m)	LIMIT (dBuV/m)	MARGIN (dB)	ANTENNA HEIGHT (m)	TABLE ANGLE (Degree)	RAW VALUE (dBuV)	CORRECTION FACTOR (dB/m)
1	#5470.00	48.9 PK	74.0	-25.1	2.88 V	338	44.7	4.2
2	#5470.00	37.2 AV	54.0	-16.8	2.88 V	338	33.0	4.2
3	*5720.00	116.5 PK			2.88 V	338	112.1	4.4
4	*5720.00	106.6 AV			2.88 V	338	102.2	4.4
5	#5913.00	50.4 PK	74.0	-23.6	2.88 V	339	45.8	4.6
6	#5913.00	38.6 AV	54.0	-15.4	2.88 V	339	34.0	4.6
7	11440.00	49.7 PK	74.0	-24.3	2.19 V	210	36.2	13.5
8	11440.00	38.2 AV	54.0	-15.8	2.19 V	210	24.7	13.5
9	#17160.00	44.5 PK	74.0	-29.5	1.78 V	301	27.2	17.3
10	#17160.00	32.8 AV	54.0	-21.2	1.78 V	301	15.5	17.3

REMARKS:

1. Emission Level(dBuV/m) = Raw Value(dBuV) + Correction Factor(dB/m)
2. Correction Factor(dB/m) = Antenna Factor(dB/m) + Cable Factor(dB) – Pre-Amplifier Factor(dB)
3. The other emission levels were very low against the limit.
4. Margin value = Emission Level – Limit value
5. " * ": Fundamental frequency.
6. " # ": The radiated frequency is out of the restricted band.

802.11ac (VHT40)

CHANNEL	TX Channel 54	DETECTOR FUNCTION	Peak (PK)
FREQUENCY RANGE	1GHz ~ 40GHz		Average (AV)

ANTENNA POLARITY & TEST DISTANCE: HORIZONTAL AT 3 M

NO.	FREQ. (MHz)	EMISSION LEVEL (dBuV/m)	LIMIT (dBuV/m)	MARGIN (dB)	ANTENNA HEIGHT (m)	TABLE ANGLE (Degree)	RAW VALUE (dBuV)	CORRECTION FACTOR (dB/m)
1	5150.00	59.4 PK	74.0	-14.6	1.42 H	150	55.7	3.7
2	5150.00	43.1 AV	54.0	-10.9	1.42 H	150	39.4	3.7
3	*5270.00	112.9 PK			1.42 H	150	108.9	4.0
4	*5270.00	103.1 AV			1.42 H	150	99.1	4.0
5	5350.00	62.6 PK	74.0	-11.4	1.42 H	150	58.5	4.1
6	5350.00	51.4 AV	54.0	-2.6	1.42 H	150	47.3	4.1
7	#10540.00	46.2 PK	74.0	-27.8	1.80 H	223	32.9	13.3
8	#10540.00	34.9 AV	54.0	-19.1	1.80 H	223	21.6	13.3
9	15810.00	44.4 PK	74.0	-29.6	2.01 H	356	31.0	13.4
10	15810.00	32.9 AV	54.0	-21.1	2.01 H	356	19.5	13.4

ANTENNA POLARITY & TEST DISTANCE: VERTICAL AT 3 M

NO.	FREQ. (MHz)	EMISSION LEVEL (dBuV/m)	LIMIT (dBuV/m)	MARGIN (dB)	ANTENNA HEIGHT (m)	TABLE ANGLE (Degree)	RAW VALUE (dBuV)	CORRECTION FACTOR (dB/m)
1	5150.00	55.1 PK	74.0	-18.9	2.81 V	334	51.4	3.7
2	5150.00	43.3 AV	54.0	-10.7	2.81 V	334	39.6	3.7
3	*5270.00	116.2 PK			2.81 V	334	112.2	4.0
4	*5270.00	106.4 AV			2.81 V	334	102.4	4.0
5	5350.00	64.8 PK	74.0	-9.2	2.81 V	334	60.7	4.1
6	5350.00	53.7 AV	54.0	-0.3	2.81 V	334	49.6	4.1
7	#10540.00	47.2 PK	74.0	-26.8	2.15 V	187	33.9	13.3
8	#10540.00	35.7 AV	54.0	-18.3	2.15 V	187	22.4	13.3
9	15810.00	44.2 PK	74.0	-29.8	1.71 V	303	30.8	13.4
10	15810.00	32.6 AV	54.0	-21.4	1.71 V	303	19.2	13.4

REMARKS:

1. Emission Level(dBuV/m) = Raw Value(dBuV) + Correction Factor(dB/m)
2. Correction Factor(dB/m) = Antenna Factor(dB/m) + Cable Factor(dB) – Pre-Amplifier Factor(dB)
3. The other emission levels were very low against the limit.
4. Margin value = Emission Level – Limit value
5. " * ": Fundamental frequency.
6. " # ": The radiated frequency is out of the restricted band.

CHANNEL	TX Channel 62	DETECTOR FUNCTION	Peak (PK)
FREQUENCY RANGE	1GHz ~ 40GHz		Average (AV)

ANTENNA POLARITY & TEST DISTANCE: HORIZONTAL AT 3 M

NO.	FREQ. (MHz)	EMISSION LEVEL (dBuV/m)	LIMIT (dBuV/m)	MARGIN (dB)	ANTENNA HEIGHT (m)	TABLE ANGLE (Degree)	RAW VALUE (dBuV)	CORRECTION FACTOR (dB/m)
1	*5310.00	109.2 PK			1.32 H	169	105.1	4.1
2	*5310.00	100.8 AV			1.32 H	169	96.7	4.1
3	5350.00	61.8 PK	74.0	-12.2	1.32 H	169	57.7	4.1
4	5350.00	50.5 AV	54.0	-3.5	1.32 H	169	46.4	4.1
5	10620.00	45.1 PK	74.0	-28.9	1.87 H	232	31.6	13.5
6	10620.00	33.7 AV	54.0	-20.3	1.87 H	232	20.2	13.5
7	15930.00	44.2 PK	74.0	-29.8	2.03 H	360	31.4	12.8
8	15930.00	32.5 AV	54.0	-21.5	2.03 H	360	19.7	12.8

ANTENNA POLARITY & TEST DISTANCE: VERTICAL AT 3 M

NO.	FREQ. (MHz)	EMISSION LEVEL (dBuV/m)	LIMIT (dBuV/m)	MARGIN (dB)	ANTENNA HEIGHT (m)	TABLE ANGLE (Degree)	RAW VALUE (dBuV)	CORRECTION FACTOR (dB/m)
1	*5310.00	112.9 PK			2.77 V	334	108.8	4.1
2	*5310.00	103.7 AV			2.77 V	334	99.6	4.1
3	5350.00	65.9 PK	74.0	-8.1	2.77 V	334	61.8	4.1
4	5350.00	53.9 AV	54.0	-0.1	2.77 V	334	49.8	4.1
5	10620.00	46.8 PK	74.0	-27.2	2.14 V	189	33.3	13.5
6	10620.00	35.0 AV	54.0	-19.0	2.14 V	189	21.5	13.5
7	15930.00	44.8 PK	74.0	-29.2	1.79 V	290	32.0	12.8
8	15930.00	33.5 AV	54.0	-20.5	1.79 V	290	20.7	12.8

REMARKS:

1. Emission Level(dBuV/m) = Raw Value(dBuV) + Correction Factor(dB/m)
2. Correction Factor(dB/m) = Antenna Factor(dB/m) + Cable Factor(dB) – Pre-Amplifier Factor(dB)
3. The other emission levels were very low against the limit.
4. Margin value = Emission Level – Limit value
5. " * ": Fundamental frequency.

CHANNEL	TX Channel 102	DETECTOR FUNCTION	Peak (PK)
FREQUENCY RANGE	1GHz ~ 40GHz		Average (AV)

ANTENNA POLARITY & TEST DISTANCE: HORIZONTAL AT 3 M

NO.	FREQ. (MHz)	EMISSION LEVEL (dBuV/m)	LIMIT (dBuV/m)	MARGIN (dB)	ANTENNA HEIGHT (m)	TABLE ANGLE (Degree)	RAW VALUE (dBuV)	CORRECTION FACTOR (dB/m)
1	#5470.00	62.2 PK	74.0	-11.8	1.36 H	167	58.0	4.2
2	#5470.00	50.8 AV	54.0	-3.2	1.36 H	167	46.6	4.2
3	*5510.00	107.3 PK			1.36 H	167	103.1	4.2
4	*5510.00	98.0 AV			1.36 H	167	93.8	4.2
5	11020.00	44.2 PK	74.0	-29.8	1.85 H	228	30.2	14.0
6	11020.00	32.1 AV	54.0	-21.9	1.85 H	228	18.1	14.0
7	#16530.00	44.3 PK	74.0	-29.7	2.02 H	360	29.4	14.9
8	#16530.00	32.4 AV	54.0	-21.6	2.02 H	360	17.5	14.9

ANTENNA POLARITY & TEST DISTANCE: VERTICAL AT 3 M

NO.	FREQ. (MHz)	EMISSION LEVEL (dBuV/m)	LIMIT (dBuV/m)	MARGIN (dB)	ANTENNA HEIGHT (m)	TABLE ANGLE (Degree)	RAW VALUE (dBuV)	CORRECTION FACTOR (dB/m)
1	#5470.00	69.7 PK	74.0	-4.3	2.74 V	332	65.5	4.2
2	#5470.00	53.9 AV	54.0	-0.1	2.74 V	332	49.7	4.2
3	*5510.00	110.9 PK			2.74 V	332	106.7	4.2
4	*5510.00	101.3 AV			2.74 V	332	97.1	4.2
5	11020.00	46.1 PK	74.0	-27.9	2.22 V	208	32.1	14.0
6	11020.00	34.2 AV	54.0	-19.8	2.22 V	208	20.2	14.0
7	#16530.00	44.1 PK	74.0	-29.9	1.77 V	294	29.2	14.9
8	#16530.00	32.7 AV	54.0	-21.3	1.77 V	294	17.8	14.9

REMARKS:

1. Emission Level(dBuV/m) = Raw Value(dBuV) + Correction Factor(dB/m)
2. Correction Factor(dB/m) = Antenna Factor(dB/m) + Cable Factor(dB) – Pre-Amplifier Factor(dB)
3. The other emission levels were very low against the limit.
4. Margin value = Emission Level – Limit value
5. " * ": Fundamental frequency.
6. " # ": The radiated frequency is out of the restricted band.

CHANNEL	TX Channel 110	DETECTOR FUNCTION	Peak (PK)
FREQUENCY RANGE	1GHz ~ 40GHz		Average (AV)

ANTENNA POLARITY & TEST DISTANCE: HORIZONTAL AT 3 M

NO.	FREQ. (MHz)	EMISSION LEVEL (dBuV/m)	LIMIT (dBuV/m)	MARGIN (dB)	ANTENNA HEIGHT (m)	TABLE ANGLE (Degree)	RAW VALUE (dBuV)	CORRECTION FACTOR (dB/m)
1	#5470.00	62.4 PK	74.0	-11.6	1.32 H	179	58.2	4.2
2	#5470.00	51.1 AV	54.0	-2.9	1.32 H	179	46.9	4.2
3	*5550.00	111.6 PK			1.32 H	179	107.4	4.2
4	*5550.00	102.2 AV			1.32 H	179	98.0	4.2
5	#5725.00	46.4 PK	74.0	-27.6	1.32 H	179	42.0	4.4
6	#5725.00	35.3 AV	54.0	-18.7	1.32 H	179	30.9	4.4
7	11100.00	45.8 PK	74.0	-28.2	1.80 H	214	32.0	13.8
8	11100.00	33.5 AV	54.0	-20.5	1.80 H	214	19.7	13.8
9	#16650.00	45.0 PK	74.0	-29.0	2.00 H	360	29.4	15.6
10	#16650.00	33.1 AV	54.0	-20.9	2.00 H	360	17.5	15.6

ANTENNA POLARITY & TEST DISTANCE: VERTICAL AT 3 M

NO.	FREQ. (MHz)	EMISSION LEVEL (dBuV/m)	LIMIT (dBuV/m)	MARGIN (dB)	ANTENNA HEIGHT (m)	TABLE ANGLE (Degree)	RAW VALUE (dBuV)	CORRECTION FACTOR (dB/m)
1	#5470.00	68.0 PK	74.0	-6.0	2.72 V	334	63.8	4.2
2	#5470.00	53.6 AV	54.0	-0.4	2.72 V	334	49.4	4.2
3	*5550.00	114.9 PK			2.72 V	334	110.7	4.2
4	*5550.00	105.4 AV			2.72 V	334	101.2	4.2
5	#5725.00	50.5 PK	74.0	-23.5	2.72 V	334	46.1	4.4
6	#5725.00	38.4 AV	54.0	-15.6	2.72 V	334	34.0	4.4
7	11100.00	47.9 PK	74.0	-26.1	2.15 V	199	34.1	13.8
8	11100.00	35.6 AV	54.0	-18.4	2.15 V	199	21.8	13.8
9	#16650.00	44.7 PK	74.0	-29.3	1.82 V	289	29.1	15.6
10	#16650.00	33.4 AV	54.0	-20.6	1.82 V	289	17.8	15.6

REMARKS:

1. Emission Level(dBuV/m) = Raw Value(dBuV) + Correction Factor(dB/m)
2. Correction Factor(dB/m) = Antenna Factor(dB/m) + Cable Factor(dB) – Pre-Amplifier Factor(dB)
3. The other emission levels were very low against the limit.
4. Margin value = Emission Level – Limit value
5. " * ": Fundamental frequency.
6. " # ": The radiated frequency is out of the restricted band.

CHANNEL	TX Channel 134	DETECTOR FUNCTION	Peak (PK)
FREQUENCY RANGE	1GHz ~ 40GHz		Average (AV)

ANTENNA POLARITY & TEST DISTANCE: HORIZONTAL AT 3 M

NO.	FREQ. (MHz)	EMISSION LEVEL (dBuV/m)	LIMIT (dBuV/m)	MARGIN (dB)	ANTENNA HEIGHT (m)	TABLE ANGLE (Degree)	RAW VALUE (dBuV)	CORRECTION FACTOR (dB/m)
1	*5670.00	110.2 PK			1.29 H	193	105.9	4.3
2	*5670.00	100.6 AV			1.29 H	193	96.3	4.3
3	#5725.00	62.9 PK	74.0	-11.1	1.29 H	193	58.5	4.4
4	#5725.00	51.8 AV	54.0	-2.2	1.29 H	193	47.4	4.4
5	11340.00	45.0 PK	74.0	-29.0	1.84 H	237	31.4	13.6
6	11340.00	33.0 AV	54.0	-21.0	1.84 H	237	19.4	13.6
7	#17010.00	44.6 PK	74.0	-29.4	2.08 H	350	27.5	17.1
8	#17010.00	32.6 AV	54.0	-21.4	2.08 H	350	15.5	17.1

ANTENNA POLARITY & TEST DISTANCE: VERTICAL AT 3 M

NO.	FREQ. (MHz)	EMISSION LEVEL (dBuV/m)	LIMIT (dBuV/m)	MARGIN (dB)	ANTENNA HEIGHT (m)	TABLE ANGLE (Degree)	RAW VALUE (dBuV)	CORRECTION FACTOR (dB/m)
1	*5670.00	113.5 PK			2.73 V	335	109.2	4.3
2	*5670.00	104.0 AV			2.73 V	335	99.7	4.3
3	#5725.00	67.9 PK	74.0	-6.1	2.73 V	335	63.5	4.4
4	#5725.00	53.8 AV	54.0	-0.2	2.73 V	335	49.4	4.4
5	11340.00	47.1 PK	74.0	-26.9	2.18 V	199	33.5	13.6
6	11340.00	35.1 AV	54.0	-18.9	2.18 V	199	21.5	13.6
7	#17010.00	44.7 PK	74.0	-29.3	1.81 V	308	27.6	17.1
8	#17010.00	33.0 AV	54.0	-21.0	1.81 V	308	15.9	17.1

REMARKS:

1. Emission Level(dBuV/m) = Raw Value(dBuV) + Correction Factor(dB/m)
2. Correction Factor(dB/m) = Antenna Factor(dB/m) + Cable Factor(dB) – Pre-Amplifier Factor(dB)
3. The other emission levels were very low against the limit.
4. Margin value = Emission Level – Limit value
5. " * ": Fundamental frequency.
6. " # ": The radiated frequency is out of the restricted band.

CHANNEL	TX Channel 142	DETECTOR FUNCTION	Peak (PK)
FREQUENCY RANGE	1GHz ~ 40GHz		Average (AV)

ANTENNA POLARITY & TEST DISTANCE: HORIZONTAL AT 3 M

NO.	FREQ. (MHz)	EMISSION LEVEL (dBuV/m)	LIMIT (dBuV/m)	MARGIN (dB)	ANTENNA HEIGHT (m)	TABLE ANGLE (Degree)	RAW VALUE (dBuV)	CORRECTION FACTOR (dB/m)
1	#5470.00	46.3 PK	74.0	-27.7	1.32 H	168	42.1	4.2
2	#5470.00	35.1 AV	54.0	-18.9	1.32 H	168	30.9	4.2
3	*5710.00	112.1 PK			1.32 H	168	107.6	4.5
4	*5710.00	102.6 AV			1.32 H	168	98.1	4.5
5	#5850.00	51.9 PK	74.0	-22.1	1.32 H	168	47.4	4.5
6	#5850.00	37.6 AV	54.0	-16.4	1.32 H	168	33.1	4.5
7	11420.00	47.3 PK	74.0	-26.7	1.81 H	217	33.7	13.6
8	11420.00	35.2 AV	54.0	-18.8	1.81 H	217	21.6	13.6
9	#17130.00	44.8 PK	74.0	-29.2	2.01 H	348	27.4	17.4
10	#17130.00	33.1 AV	54.0	-20.9	2.01 H	348	15.7	17.4

ANTENNA POLARITY & TEST DISTANCE: VERTICAL AT 3 M

NO.	FREQ. (MHz)	EMISSION LEVEL (dBuV/m)	LIMIT (dBuV/m)	MARGIN (dB)	ANTENNA HEIGHT (m)	TABLE ANGLE (Degree)	RAW VALUE (dBuV)	CORRECTION FACTOR (dB/m)
1	#5470.00	49.2 PK	74.0	-24.8	2.72 V	322	45.0	4.2
2	#5470.00	37.2 AV	54.0	-16.8	2.72 V	322	33.0	4.2
3	*5710.00	115.4 PK			2.72 V	322	110.9	4.5
4	*5710.00	105.8 AV			2.72 V	322	101.3	4.5
5	#5850.00	54.8 PK	74.0	-19.2	2.72 V	322	50.3	4.5
6	#5850.00	40.4 AV	54.0	-13.6	2.72 V	322	35.9	4.5
7	11420.00	48.4 PK	74.0	-25.6	2.18 V	206	34.8	13.6
8	11420.00	36.8 AV	54.0	-17.2	2.18 V	206	23.2	13.6
9	#17130.00	44.3 PK	74.0	-29.7	1.78 V	290	26.9	17.4
10	#17130.00	32.7 AV	54.0	-21.3	1.78 V	290	15.3	17.4

REMARKS:

1. Emission Level(dBuV/m) = Raw Value(dBuV) + Correction Factor(dB/m)
2. Correction Factor(dB/m) = Antenna Factor(dB/m) + Cable Factor(dB) – Pre-Amplifier Factor(dB)
3. The other emission levels were very low against the limit.
4. Margin value = Emission Level – Limit value
5. " * ": Fundamental frequency.
6. " # ": The radiated frequency is out of the restricted band.

802.11ac (VHT80)

CHANNEL	TX Channel 58	DETECTOR FUNCTION	Peak (PK)
FREQUENCY RANGE	1GHz ~ 40GHz		Average (AV)

ANTENNA POLARITY & TEST DISTANCE: HORIZONTAL AT 3 M

NO.	FREQ. (MHz)	EMISSION LEVEL (dBuV/m)	LIMIT (dBuV/m)	MARGIN (dB)	ANTENNA HEIGHT (m)	TABLE ANGLE (Degree)	RAW VALUE (dBuV)	CORRECTION FACTOR (dB/m)
1	5150.00	58.5 PK	74.0	-15.5	1.30 H	189	54.8	3.7
2	5150.00	42.4 AV	54.0	-11.6	1.30 H	189	38.7	3.7
3	*5290.00	104.3 PK			1.30 H	189	100.2	4.1
4	*5290.00	94.2 AV			1.30 H	189	90.1	4.1
5	5350.00	62.8 PK	74.0	-11.2	1.30 H	189	58.7	4.1
6	5350.00	51.3 AV	54.0	-2.7	1.30 H	189	47.2	4.1
7	#10580.00	42.2 PK	74.0	-31.8	1.81 H	212	28.8	13.4
8	#10580.00	30.1 AV	54.0	-23.9	1.81 H	212	16.7	13.4
9	15870.00	44.6 PK	74.0	-29.4	2.09 H	350	31.6	13.0
10	15870.00	33.0 AV	54.0	-21.0	2.09 H	350	20.0	13.0

ANTENNA POLARITY & TEST DISTANCE: VERTICAL AT 3 M

NO.	FREQ. (MHz)	EMISSION LEVEL (dBuV/m)	LIMIT (dBuV/m)	MARGIN (dB)	ANTENNA HEIGHT (m)	TABLE ANGLE (Degree)	RAW VALUE (dBuV)	CORRECTION FACTOR (dB/m)
1	5150.00	59.9 PK	74.0	-14.1	2.68 V	330	56.2	3.7
2	5150.00	47.2 AV	54.0	-6.8	2.68 V	330	43.5	3.7
3	*5290.00	107.6 PK			2.68 V	330	103.5	4.1
4	*5290.00	97.8 AV			2.68 V	330	93.7	4.1
5	5350.00	65.2 PK	74.0	-8.8	2.68 V	330	61.1	4.1
6	5350.00	53.7 AV	54.0	-0.3	2.68 V	330	49.6	4.1
7	#10580.00	43.2 PK	74.0	-30.8	2.19 V	200	29.8	13.4
8	#10580.00	31.1 AV	54.0	-22.9	2.19 V	200	17.7	13.4
9	15870.00	44.1 PK	74.0	-29.9	1.74 V	280	31.1	13.0
10	15870.00	32.8 AV	54.0	-21.2	1.74 V	280	19.8	13.0

REMARKS:

- Emission Level(dBuV/m) = Raw Value(dBuV) + Correction Factor(dB/m)
- Correction Factor(dB/m) = Antenna Factor(dB/m) + Cable Factor(dB) – Pre-Amplifier Factor(dB)
- The other emission levels were very low against the limit.
- Margin value = Emission Level – Limit value
- " * ": Fundamental frequency.
- " # ": The radiated frequency is out of the restricted band.

CHANNEL	TX Channel 106	DETECTOR FUNCTION	Peak (PK)
FREQUENCY RANGE	1GHz ~ 40GHz		Average (AV)

ANTENNA POLARITY & TEST DISTANCE: HORIZONTAL AT 3 M

NO.	FREQ. (MHz)	EMISSION LEVEL (dBuV/m)	LIMIT (dBuV/m)	MARGIN (dB)	ANTENNA HEIGHT (m)	TABLE ANGLE (Degree)	RAW VALUE (dBuV)	CORRECTION FACTOR (dB/m)
1	#5470.00	61.8 PK	74.0	-12.2	1.29 H	164	57.6	4.2
2	#5470.00	50.6 AV	54.0	-3.4	1.29 H	164	46.4	4.2
3	*5530.00	99.1 PK			1.29 H	164	94.9	4.2
4	*5530.00	94.9 AV			1.29 H	164	90.7	4.2
5	#5725.00	45.7 PK	74.0	-28.3	1.29 H	164	41.3	4.4
6	#5725.00	34.8 AV	54.0	-19.2	1.29 H	164	30.4	4.4
7	11060.00	41.1 PK	74.0	-32.9	1.82 H	224	27.2	13.9
8	11060.00	29.2 AV	54.0	-24.8	1.82 H	224	15.3	13.9
9	#16590.00	44.1 PK	74.0	-29.9	1.99 H	360	28.5	15.6
10	#16590.00	32.2 AV	54.0	-21.8	1.99 H	360	16.6	15.6

ANTENNA POLARITY & TEST DISTANCE: VERTICAL AT 3 M

NO.	FREQ. (MHz)	EMISSION LEVEL (dBuV/m)	LIMIT (dBuV/m)	MARGIN (dB)	ANTENNA HEIGHT (m)	TABLE ANGLE (Degree)	RAW VALUE (dBuV)	CORRECTION FACTOR (dB/m)
1	#5470.00	67.8 PK	74.0	-6.2	2.66 V	312	63.6	4.2
2	#5470.00	53.9 AV	54.0	-0.1	2.66 V	312	49.7	4.2
3	*5530.00	102.4 PK			2.66 V	312	98.2	4.2
4	*5530.00	98.3 AV			2.66 V	312	94.1	4.2
5	#5725.00	50.1 PK	74.0	-23.9	2.66 V	312	45.7	4.4
6	#5725.00	39.2 AV	54.0	-14.8	2.66 V	312	34.8	4.4
7	11060.00	41.4 PK	74.0	-32.6	2.13 V	199	27.5	13.9
8	11060.00	29.3 AV	54.0	-24.7	2.13 V	199	15.4	13.9
9	#16590.00	45.0 PK	74.0	-29.0	1.73 V	292	29.4	15.6
10	#16590.00	33.4 AV	54.0	-20.6	1.73 V	292	17.8	15.6

REMARKS:

1. Emission Level(dBuV/m) = Raw Value(dBuV) + Correction Factor(dB/m)
2. Correction Factor(dB/m) = Antenna Factor(dB/m) + Cable Factor(dB) – Pre-Amplifier Factor(dB)
3. The other emission levels were very low against the limit.
4. Margin value = Emission Level – Limit value
5. " * ": Fundamental frequency.
6. " # ": The radiated frequency is out of the restricted band.

CHANNEL	TX Channel 122	DETECTOR FUNCTION	Peak (PK)
FREQUENCY RANGE	1GHz ~ 40GHz		Average (AV)

ANTENNA POLARITY & TEST DISTANCE: HORIZONTAL AT 3 M

NO.	FREQ. (MHz)	EMISSION LEVEL (dBuV/m)	LIMIT (dBuV/m)	MARGIN (dB)	ANTENNA HEIGHT (m)	TABLE ANGLE (Degree)	RAW VALUE (dBuV)	CORRECTION FACTOR (dB/m)
1	*5610.00	103.5 PK			1.28 H	174	99.1	4.4
2	*5610.00	94.9 AV			1.28 H	174	90.5	4.4
3	#5725.00	63.3 PK	74.0	-10.7	1.28 H	174	58.9	4.4
4	#5725.00	51.6 AV	54.0	-2.4	1.28 H	174	47.2	4.4
5	11220.00	50.3 PK	74.0	-23.7	1.84 H	216	36.6	13.7
6	11220.00	38.2 AV	54.0	-15.8	1.84 H	216	24.5	13.7
7	#16830.00	44.2 PK	74.0	-29.8	1.93 H	360	28.3	15.9
8	#16830.00	32.0 AV	54.0	-22.0	1.93 H	360	16.1	15.9

ANTENNA POLARITY & TEST DISTANCE: VERTICAL AT 3 M

NO.	FREQ. (MHz)	EMISSION LEVEL (dBuV/m)	LIMIT (dBuV/m)	MARGIN (dB)	ANTENNA HEIGHT (m)	TABLE ANGLE (Degree)	RAW VALUE (dBuV)	CORRECTION FACTOR (dB/m)
1	*5610.00	106.9 PK			2.72 V	333	102.5	4.4
2	*5610.00	98.3 AV			2.72 V	333	93.9	4.4
3	#5725.00	67.9 PK	74.0	-6.1	2.72 V	333	63.5	4.4
4	#5725.00	53.9 AV	54.0	-0.1	2.72 V	333	49.5	4.4
5	11220.00	43.6 PK	74.0	-30.4	2.19 V	206	29.9	13.7
6	11220.00	31.4 AV	54.0	-22.6	2.19 V	206	17.7	13.7
7	#16830.00	44.1 PK	74.0	-29.9	1.71 V	304	28.2	15.9
8	#16830.00	32.6 AV	54.0	-21.4	1.71 V	304	16.7	15.9

REMARKS:

1. Emission Level(dBuV/m) = Raw Value(dBuV) + Correction Factor(dB/m)
2. Correction Factor(dB/m) = Antenna Factor(dB/m) + Cable Factor(dB) – Pre-Amplifier Factor(dB)
3. The other emission levels were very low against the limit.
4. Margin value = Emission Level – Limit value
5. " * ": Fundamental frequency.
6. " # ": The radiated frequency is out of the restricted band.

CHANNEL	TX Channel 138	DETECTOR FUNCTION	Peak (PK)
FREQUENCY RANGE	1GHz ~ 40GHz		Average (AV)

ANTENNA POLARITY & TEST DISTANCE: HORIZONTAL AT 3 M

NO.	FREQ. (MHz)	EMISSION LEVEL (dBuV/m)	LIMIT (dBuV/m)	MARGIN (dB)	ANTENNA HEIGHT (m)	TABLE ANGLE (Degree)	RAW VALUE (dBuV)	CORRECTION FACTOR (dB/m)
1	#5470.00	59.2 PK	74.0	-14.8	1.34 H	193	55.0	4.2
2	#5470.00	42.9 AV	54.0	-11.1	1.34 H	193	38.7	4.2
3	*5690.00	106.1 PK			1.34 H	193	101.6	4.5
4	*5690.00	97.2 AV			1.34 H	193	92.7	4.5
5	#5850.00	63.5 PK	74.0	-10.5	1.34 H	193	59.0	4.5
6	#5850.00	52.0 AV	54.0	-2.0	1.34 H	193	47.5	4.5
7	11380.00	41.8 PK	74.0	-32.2	1.78 H	211	28.2	13.6
8	11380.00	29.6 AV	54.0	-24.4	1.78 H	211	16.0	13.6
9	#17070.00	44.1 PK	74.0	-29.9	1.96 H	360	26.8	17.3
10	#17070.00	32.0 AV	54.0	-22.0	1.96 H	360	14.7	17.3

ANTENNA POLARITY & TEST DISTANCE: VERTICAL AT 3 M

NO.	FREQ. (MHz)	EMISSION LEVEL (dBuV/m)	LIMIT (dBuV/m)	MARGIN (dB)	ANTENNA HEIGHT (m)	TABLE ANGLE (Degree)	RAW VALUE (dBuV)	CORRECTION FACTOR (dB/m)
1	#5470.00	61.9 PK	74.0	-12.1	2.73 V	336	57.7	4.2
2	#5470.00	45.7 AV	54.0	-8.3	2.73 V	336	41.5	4.2
3	*5690.00	109.3 PK			2.73 V	336	104.8	4.5
4	*5690.00	100.5 AV			2.73 V	336	96.0	4.5
5	#5850.00	68.1 PK	74.0	-5.9	2.73 V	336	63.6	4.5
6	#5850.00	53.9 AV	54.0	-0.1	2.73 V	336	49.4	4.5
7	11380.00	43.8 PK	74.0	-30.2	2.23 V	208	30.2	13.6
8	11380.00	31.4 AV	54.0	-22.6	2.23 V	208	17.8	13.6
9	#17070.00	44.8 PK	74.0	-29.2	1.79 V	300	27.5	17.3
10	#17070.00	33.2 AV	54.0	-20.8	1.79 V	300	15.9	17.3

REMARKS:

- Emission Level(dBuV/m) = Raw Value(dBuV) + Correction Factor(dB/m)
- Correction Factor(dB/m) = Antenna Factor(dB/m) + Cable Factor(dB) – Pre-Amplifier Factor(dB)
- The other emission levels were very low against the limit.
- Margin value = Emission Level – Limit value
- " * ": Fundamental frequency.
- " # ": The radiated frequency is out of the restricted band.

4.1.9 Test Results (Mode 3)

Above 1GHz Data:

802.11a

CHANNEL	TX Channel 52	DETECTOR FUNCTION	Peak (PK)
FREQUENCY RANGE	1GHz ~ 40GHz		Average (AV)

ANTENNA POLARITY & TEST DISTANCE: HORIZONTAL AT 3 M								
NO.	FREQ. (MHz)	EMISSION LEVEL (dBuV/m)	LIMIT (dBuV/m)	MARGIN (dB)	ANTENNA HEIGHT (m)	TABLE ANGLE (Degree)	RAW VALUE (dBuV)	CORRECTION FACTOR (dB/m)
1	5150.00	45.2 PK	74.0	-28.8	1.02 H	149	41.5	3.7
2	5150.00	37.3 AV	54.0	-16.7	1.02 H	149	33.6	3.7
3	*5260.00	112.6 PK			1.02 H	149	108.6	4.0
4	*5260.00	102.8 AV			1.02 H	149	98.8	4.0
5	#10520.00	45.8 PK	74.0	-28.2	1.76 H	287	32.6	13.2
6	#10520.00	33.9 AV	54.0	-20.1	1.76 H	287	20.7	13.2
7	15780.00	45.4 PK	74.0	-28.6	1.64 H	327	31.8	13.6
8	15780.00	33.0 AV	54.0	-21.0	1.64 H	327	19.4	13.6

ANTENNA POLARITY & TEST DISTANCE: VERTICAL AT 3 M								
NO.	FREQ. (MHz)	EMISSION LEVEL (dBuV/m)	LIMIT (dBuV/m)	MARGIN (dB)	ANTENNA HEIGHT (m)	TABLE ANGLE (Degree)	RAW VALUE (dBuV)	CORRECTION FACTOR (dB/m)
1	5150.00	49.1 PK	74.0	-24.9	2.61 V	249	45.4	3.7
2	5150.00	38.8 AV	54.0	-15.2	2.61 V	249	35.1	3.7
3	*5260.00	115.3 PK			2.61 V	249	111.3	4.0
4	*5260.00	104.9 AV			2.61 V	249	100.9	4.0
5	#10520.00	48.7 PK	74.0	-25.3	1.89 V	318	35.5	13.2
6	#10520.00	36.9 AV	54.0	-17.1	1.89 V	318	23.7	13.2
7	15780.00	44.7 PK	74.0	-29.3	1.78 V	209	31.1	13.6
8	15780.00	32.6 AV	54.0	-21.4	1.78 V	209	19.0	13.6

REMARKS:

1. Emission Level(dBuV/m) = Raw Value(dBuV) + Correction Factor(dB/m)
2. Correction Factor(dB/m) = Antenna Factor(dB/m) + Cable Factor(dB) – Pre-Amplifier Factor(dB)
3. The other emission levels were very low against the limit.
4. Margin value = Emission Level – Limit value
5. " * ": Fundamental frequency.
6. " # ": The radiated frequency is out of the restricted band.

CHANNEL	TX Channel 60	DETECTOR FUNCTION	Peak (PK)
FREQUENCY RANGE	1GHz ~ 40GHz		Average (AV)

ANTENNA POLARITY & TEST DISTANCE: HORIZONTAL AT 3 M

NO.	FREQ. (MHz)	EMISSION LEVEL (dBuV/m)	LIMIT (dBuV/m)	MARGIN (dB)	ANTENNA HEIGHT (m)	TABLE ANGLE (Degree)	RAW VALUE (dBuV)	CORRECTION FACTOR (dB/m)
1	5150.00	45.5 PK	74.0	-28.5	1.02 H	163	41.8	3.7
2	5150.00	37.1 AV	54.0	-16.9	1.02 H	163	33.4	3.7
3	*5300.00	113.0 PK			1.02 H	163	108.9	4.1
4	*5300.00	102.8 AV			1.02 H	163	98.7	4.1
5	5350.00	60.4 PK	74.0	-13.6	1.02 H	163	56.3	4.1
6	5350.00	48.7 AV	54.0	-5.3	1.02 H	163	44.6	4.1
7	10600.00	45.1 PK	74.0	-28.9	1.74 H	281	31.6	13.5
8	10600.00	33.3 AV	54.0	-20.7	1.74 H	281	19.8	13.5
9	15900.00	44.3 PK	74.0	-29.7	1.67 H	313	31.4	12.9
10	15900.00	32.0 AV	54.0	-22.0	1.67 H	313	19.1	12.9

ANTENNA POLARITY & TEST DISTANCE: VERTICAL AT 3 M

NO.	FREQ. (MHz)	EMISSION LEVEL (dBuV/m)	LIMIT (dBuV/m)	MARGIN (dB)	ANTENNA HEIGHT (m)	TABLE ANGLE (Degree)	RAW VALUE (dBuV)	CORRECTION FACTOR (dB/m)
1	5150.00	50.1 PK	74.0	-23.9	2.60 V	248	46.4	3.7
2	5150.00	38.8 AV	54.0	-15.2	2.60 V	248	35.1	3.7
3	*5300.00	116.2 PK			2.60 V	248	112.1	4.1
4	*5300.00	105.6 AV			2.60 V	248	101.5	4.1
5	5350.00	63.7 PK	74.0	-10.3	2.60 V	248	59.6	4.1
6	5350.00	49.4 AV	54.0	-4.6	2.60 V	248	45.3	4.1
7	10600.00	49.2 PK	74.0	-24.8	1.94 V	330	35.7	13.5
8	10600.00	37.3 AV	54.0	-16.7	1.94 V	330	23.8	13.5
9	15900.00	44.1 PK	74.0	-29.9	1.75 V	220	31.2	12.9
10	15900.00	32.2 AV	54.0	-21.8	1.75 V	220	19.3	12.9

REMARKS:

1. Emission Level(dBuV/m) = Raw Value(dBuV) + Correction Factor(dB/m)
2. Correction Factor(dB/m) = Antenna Factor(dB/m) + Cable Factor(dB) – Pre-Amplifier Factor(dB)
3. The other emission levels were very low against the limit.
4. Margin value = Emission Level – Limit value
5. " * ": Fundamental frequency.

CHANNEL	TX Channel 64	DETECTOR FUNCTION	Peak (PK)
FREQUENCY RANGE	1GHz ~ 40GHz		Average (AV)

ANTENNA POLARITY & TEST DISTANCE: HORIZONTAL AT 3 M

NO.	FREQ. (MHz)	EMISSION LEVEL (dBuV/m)	LIMIT (dBuV/m)	MARGIN (dB)	ANTENNA HEIGHT (m)	TABLE ANGLE (Degree)	RAW VALUE (dBuV)	CORRECTION FACTOR (dB/m)
1	*5320.00	112.4 PK			1.09 H	145	108.3	4.1
2	*5320.00	101.0 AV			1.09 H	145	96.9	4.1
3	5350.00	59.9 PK	74.0	-14.1	1.09 H	145	55.8	4.1
4	5350.00	53.1 AV	54.0	-0.9	1.09 H	145	49.0	4.1
5	10640.00	45.8 PK	74.0	-28.2	1.76 H	292	32.3	13.5
6	10640.00	33.9 AV	54.0	-20.1	1.76 H	292	20.4	13.5
7	15960.00	45.6 PK	74.0	-28.4	1.66 H	327	32.7	12.9
8	15960.00	33.0 AV	54.0	-21.0	1.66 H	327	20.1	12.9

ANTENNA POLARITY & TEST DISTANCE: VERTICAL AT 3 M

NO.	FREQ. (MHz)	EMISSION LEVEL (dBuV/m)	LIMIT (dBuV/m)	MARGIN (dB)	ANTENNA HEIGHT (m)	TABLE ANGLE (Degree)	RAW VALUE (dBuV)	CORRECTION FACTOR (dB/m)
1	*5320.00	114.9 PK			2.58 V	247	110.8	4.1
2	*5320.00	103.2 AV			2.58 V	247	99.1	4.1
3	5350.00	63.3 PK	74.0	-10.7	2.58 V	247	59.2	4.1
4	5350.00	53.8 AV	54.0	-0.2	2.58 V	247	49.7	4.1
5	10640.00	48.8 PK	74.0	-25.2	1.85 V	318	35.3	13.5
6	10640.00	37.2 AV	54.0	-16.8	1.85 V	318	23.7	13.5
7	15960.00	45.0 PK	74.0	-29.0	1.80 V	207	32.1	12.9
8	15960.00	32.8 AV	54.0	-21.2	1.80 V	207	19.9	12.9

REMARKS:

1. Emission Level(dBuV/m) = Raw Value(dBuV) + Correction Factor(dB/m)
2. Correction Factor(dB/m) = Antenna Factor(dB/m) + Cable Factor(dB) – Pre-Amplifier Factor(dB)
3. The other emission levels were very low against the limit.
4. Margin value = Emission Level – Limit value
5. " * ": Fundamental frequency.

CHANNEL	TX Channel 100	DETECTOR FUNCTION	Peak (PK)
FREQUENCY RANGE	1GHz ~ 40GHz		Average (AV)

ANTENNA POLARITY & TEST DISTANCE: HORIZONTAL AT 3 M

NO.	FREQ. (MHz)	EMISSION LEVEL (dBuV/m)	LIMIT (dBuV/m)	MARGIN (dB)	ANTENNA HEIGHT (m)	TABLE ANGLE (Degree)	RAW VALUE (dBuV)	CORRECTION FACTOR (dB/m)
1	#5470.00	64.8 PK	74.0	-9.2	1.06 H	150	60.6	4.2
2	#5470.00	52.3 AV	54.0	-1.7	1.06 H	150	48.1	4.2
3	*5500.00	112.4 PK			1.06 H	150	108.2	4.2
4	*5500.00	100.6 AV			1.06 H	150	96.4	4.2
5	11000.00	47.0 PK	74.0	-27.0	1.73 H	274	32.9	14.1
6	11000.00	34.8 AV	54.0	-19.2	1.73 H	274	20.7	14.1
7	#16500.00	45.6 PK	74.0	-28.4	1.61 H	342	31.1	14.5
8	#16500.00	33.0 AV	54.0	-21.0	1.61 H	342	18.5	14.5

ANTENNA POLARITY & TEST DISTANCE: VERTICAL AT 3 M

NO.	FREQ. (MHz)	EMISSION LEVEL (dBuV/m)	LIMIT (dBuV/m)	MARGIN (dB)	ANTENNA HEIGHT (m)	TABLE ANGLE (Degree)	RAW VALUE (dBuV)	CORRECTION FACTOR (dB/m)
1	#5470.00	68.7 PK	74.0	-5.3	2.59 V	248	64.5	4.2
2	#5470.00	53.8 AV	54.0	-0.2	2.59 V	248	49.6	4.2
3	*5500.00	114.8 PK			2.59 V	248	110.6	4.2
4	*5500.00	102.6 AV			2.59 V	248	98.4	4.2
5	11000.00	48.7 PK	74.0	-25.3	1.85 V	304	34.6	14.1
6	11000.00	37.1 AV	54.0	-16.9	1.85 V	304	23.0	14.1
7	#16500.00	44.6 PK	74.0	-29.4	1.79 V	212	30.1	14.5
8	#16500.00	32.3 AV	54.0	-21.7	1.79 V	212	17.8	14.5

REMARKS:

1. Emission Level(dBuV/m) = Raw Value(dBuV) + Correction Factor(dB/m)
2. Correction Factor(dB/m) = Antenna Factor(dB/m) + Cable Factor(dB) – Pre-Amplifier Factor(dB)
3. The other emission levels were very low against the limit.
4. Margin value = Emission Level – Limit value
5. " * ": Fundamental frequency.
6. " # ": The radiated frequency is out of the restricted band.

CHANNEL	TX Channel 116	DETECTOR FUNCTION	Peak (PK)
FREQUENCY RANGE	1GHz ~ 40GHz		Average (AV)

ANTENNA POLARITY & TEST DISTANCE: HORIZONTAL AT 3 M

NO.	FREQ. (MHz)	EMISSION LEVEL (dBuV/m)	LIMIT (dBuV/m)	MARGIN (dB)	ANTENNA HEIGHT (m)	TABLE ANGLE (Degree)	RAW VALUE (dBuV)	CORRECTION FACTOR (dB/m)
1	#5470.00	47.4 PK	74.0	-26.6	1.02 H	170	43.2	4.2
2	#5470.00	38.1 AV	54.0	-15.9	1.02 H	170	33.9	4.2
3	*5580.00	112.9 PK			1.02 H	170	108.7	4.2
4	*5580.00	102.9 AV			1.02 H	170	98.7	4.2
5	#5725.00	45.8 PK	74.0	-28.2	1.02 H	170	41.4	4.4
6	#5725.00	37.6 AV	54.0	-16.4	1.02 H	170	33.2	4.4
7	11160.00	44.9 PK	74.0	-29.1	1.71 H	272	31.2	13.7
8	11160.00	33.4 AV	54.0	-20.6	1.71 H	272	19.7	13.7
9	#16740.00	45.4 PK	74.0	-28.6	1.69 H	325	29.7	15.7
10	#16740.00	32.5 AV	54.0	-21.5	1.69 H	325	16.8	15.7

ANTENNA POLARITY & TEST DISTANCE: VERTICAL AT 3 M

NO.	FREQ. (MHz)	EMISSION LEVEL (dBuV/m)	LIMIT (dBuV/m)	MARGIN (dB)	ANTENNA HEIGHT (m)	TABLE ANGLE (Degree)	RAW VALUE (dBuV)	CORRECTION FACTOR (dB/m)
1	#5470.00	51.4 PK	74.0	-22.6	2.61 V	252	47.2	4.2
2	#5470.00	39.3 AV	54.0	-14.7	2.61 V	252	35.1	4.2
3	*5580.00	115.9 PK			2.61 V	252	111.7	4.2
4	*5580.00	105.6 AV			2.61 V	252	101.4	4.2
5	#5725.00	49.3 PK	74.0	-24.7	2.61 V	252	44.9	4.4
6	#5725.00	38.5 AV	54.0	-15.5	2.61 V	252	34.1	4.4
7	11160.00	49.0 PK	74.0	-25.0	1.89 V	304	35.3	13.7
8	11160.00	37.3 AV	54.0	-16.7	1.89 V	304	23.6	13.7
9	#16740.00	44.4 PK	74.0	-29.6	1.78 V	225	28.7	15.7
10	#16740.00	32.2 AV	54.0	-21.8	1.78 V	225	16.5	15.7

REMARKS:

1. Emission Level(dBuV/m) = Raw Value(dBuV) + Correction Factor(dB/m)
2. Correction Factor(dB/m) = Antenna Factor(dB/m) + Cable Factor(dB) – Pre-Amplifier Factor(dB)
3. The other emission levels were very low against the limit.
4. Margin value = Emission Level – Limit value
5. " * ": Fundamental frequency.
6. " # ": The radiated frequency is out of the restricted band.

CHANNEL	TX Channel 140	DETECTOR FUNCTION	Peak (PK)
FREQUENCY RANGE	1GHz ~ 40GHz		Average (AV)

ANTENNA POLARITY & TEST DISTANCE: HORIZONTAL AT 3 M

NO.	FREQ. (MHz)	EMISSION LEVEL (dBuV/m)	LIMIT (dBuV/m)	MARGIN (dB)	ANTENNA HEIGHT (m)	TABLE ANGLE (Degree)	RAW VALUE (dBuV)	CORRECTION FACTOR (dB/m)
1	*5700.00	112.7 PK			1.01 H	146	108.2	4.5
2	*5700.00	103.7 AV			1.01 H	146	99.2	4.5
3	#5725.00	62.5 PK	74.0	-11.5	1.01 H	146	58.1	4.4
4	#5725.00	52.2 AV	54.0	-1.8	1.01 H	146	47.8	4.4
5	11400.00	46.6 PK	74.0	-27.4	1.73 H	286	33.0	13.6
6	11400.00	34.4 AV	54.0	-19.6	1.73 H	286	20.8	13.6
7	#17100.00	45.1 PK	74.0	-28.9	1.61 H	340	27.7	17.4
8	#17100.00	32.8 AV	54.0	-21.2	1.61 H	340	15.4	17.4

ANTENNA POLARITY & TEST DISTANCE: VERTICAL AT 3 M

NO.	FREQ. (MHz)	EMISSION LEVEL (dBuV/m)	LIMIT (dBuV/m)	MARGIN (dB)	ANTENNA HEIGHT (m)	TABLE ANGLE (Degree)	RAW VALUE (dBuV)	CORRECTION FACTOR (dB/m)
1	*5700.00	115.5 PK			2.61 V	254	111.0	4.5
2	*5700.00	105.7 AV			2.61 V	254	101.2	4.5
3	#5725.00	66.7 PK	74.0	-7.3	2.61 V	254	62.3	4.4
4	#5725.00	53.9 AV	54.0	-0.1	2.61 V	254	49.5	4.4
5	11400.00	48.4 PK	74.0	-25.6	1.94 V	314	34.8	13.6
6	11400.00	36.5 AV	54.0	-17.5	1.94 V	314	22.9	13.6
7	#17100.00	45.1 PK	74.0	-28.9	1.83 V	209	27.7	17.4
8	#17100.00	32.7 AV	54.0	-21.3	1.83 V	209	15.3	17.4

REMARKS:

1. Emission Level(dBuV/m) = Raw Value(dBuV) + Correction Factor(dB/m)
2. Correction Factor(dB/m) = Antenna Factor(dB/m) + Cable Factor(dB) – Pre-Amplifier Factor(dB)
3. The other emission levels were very low against the limit.
4. Margin value = Emission Level – Limit value
5. " * ": Fundamental frequency.
6. " # ": The radiated frequency is out of the restricted band.

CHANNEL	TX Channel 144	DETECTOR FUNCTION	Peak (PK)
FREQUENCY RANGE	1GHz ~ 40GHz		Average (AV)

ANTENNA POLARITY & TEST DISTANCE: HORIZONTAL AT 3 M

NO.	FREQ. (MHz)	EMISSION LEVEL (dBuV/m)	LIMIT (dBuV/m)	MARGIN (dB)	ANTENNA HEIGHT (m)	TABLE ANGLE (Degree)	RAW VALUE (dBuV)	CORRECTION FACTOR (dB/m)
1	#5470.00	45.5 PK	74.0	-28.5	1.06 H	146	41.3	4.2
2	#5470.00	36.0 AV	54.0	-18.0	1.06 H	146	31.8	4.2
3	*5720.00	115.6 PK			1.06 H	146	111.2	4.4
4	*5720.00	104.8 AV			1.06 H	146	100.4	4.4
5	#5850.00	46.9 PK	74.0	-27.1	1.06 H	146	42.4	4.5
6	#5850.00	37.3 AV	54.0	-16.7	1.06 H	146	32.8	4.5
7	11440.00	46.7 PK	74.0	-27.3	1.78 H	274	33.2	13.5
8	11440.00	34.7 AV	54.0	-19.3	1.78 H	274	21.2	13.5
9	#17160.00	44.7 PK	74.0	-29.3	1.66 H	317	27.4	17.3
10	#17160.00	32.0 AV	54.0	-22.0	1.66 H	317	14.7	17.3

ANTENNA POLARITY & TEST DISTANCE: VERTICAL AT 3 M

NO.	FREQ. (MHz)	EMISSION LEVEL (dBuV/m)	LIMIT (dBuV/m)	MARGIN (dB)	ANTENNA HEIGHT (m)	TABLE ANGLE (Degree)	RAW VALUE (dBuV)	CORRECTION FACTOR (dB/m)
1	#5470.00	48.9 PK	74.0	-25.1	2.60 V	250	44.7	4.2
2	#5470.00	36.8 AV	54.0	-17.2	2.60 V	250	32.6	4.2
3	*5720.00	118.2 PK			2.60 V	250	113.8	4.4
4	*5720.00	106.7 AV			2.60 V	250	102.3	4.4
5	#5850.00	50.9 PK	74.0	-23.1	2.60 V	250	46.4	4.5
6	#5850.00	38.5 AV	54.0	-15.5	2.60 V	250	34.0	4.5
7	11440.00	49.3 PK	74.0	-24.7	1.86 V	316	35.8	13.5
8	11440.00	37.3 AV	54.0	-16.7	1.86 V	316	23.8	13.5
9	#17160.00	45.2 PK	74.0	-28.8	1.74 V	206	27.9	17.3
10	#17160.00	32.9 AV	54.0	-21.1	1.74 V	206	15.6	17.3

REMARKS:

1. Emission Level(dBuV/m) = Raw Value(dBuV) + Correction Factor(dB/m)
2. Correction Factor(dB/m) = Antenna Factor(dB/m) + Cable Factor(dB) – Pre-Amplifier Factor(dB)
3. The other emission levels were very low against the limit.
4. Margin value = Emission Level – Limit value
5. " * ": Fundamental frequency.
6. " # ": The radiated frequency is out of the restricted band.

802.11ac (VHT20)

CHANNEL	TX Channel 52	DETECTOR FUNCTION	Peak (PK)
FREQUENCY RANGE	1GHz ~ 40GHz		Average (AV)

ANTENNA POLARITY & TEST DISTANCE: HORIZONTAL AT 3 M

NO.	FREQ. (MHz)	EMISSION LEVEL (dBuV/m)	LIMIT (dBuV/m)	MARGIN (dB)	ANTENNA HEIGHT (m)	TABLE ANGLE (Degree)	RAW VALUE (dBuV)	CORRECTION FACTOR (dB/m)
1	5150.00	45.8 PK	74.0	-28.2	1.08 H	131	42.1	3.7
2	5150.00	37.3 AV	54.0	-16.7	1.08 H	131	33.6	3.7
3	*5260.00	113.1 PK			1.08 H	131	109.1	4.0
4	*5260.00	102.6 AV			1.08 H	131	98.6	4.0
5	#10520.00	46.5 PK	74.0	-27.5	1.77 H	300	33.3	13.2
6	#10520.00	34.5 AV	54.0	-19.5	1.77 H	300	21.3	13.2
7	15780.00	44.9 PK	74.0	-29.1	1.61 H	327	31.3	13.6
8	15780.00	32.7 AV	54.0	-21.3	1.61 H	327	19.1	13.6

ANTENNA POLARITY & TEST DISTANCE: VERTICAL AT 3 M

NO.	FREQ. (MHz)	EMISSION LEVEL (dBuV/m)	LIMIT (dBuV/m)	MARGIN (dB)	ANTENNA HEIGHT (m)	TABLE ANGLE (Degree)	RAW VALUE (dBuV)	CORRECTION FACTOR (dB/m)
1	5150.00	48.8 PK	74.0	-25.2	2.61 V	252	45.1	3.7
2	5150.00	38.9 AV	54.0	-15.1	2.61 V	252	35.2	3.7
3	*5260.00	115.8 PK			2.61 V	252	111.8	4.0
4	*5260.00	105.1 AV			2.61 V	252	101.1	4.0
5	#10520.00	49.7 PK	74.0	-24.3	1.86 V	326	36.5	13.2
6	#10520.00	37.7 AV	54.0	-16.3	1.86 V	326	24.5	13.2
7	15780.00	44.9 PK	74.0	-29.1	1.80 V	217	31.3	13.6
8	15780.00	32.5 AV	54.0	-21.5	1.80 V	217	18.9	13.6

REMARKS:

- Emission Level(dBuV/m) = Raw Value(dBuV) + Correction Factor(dB/m)
- Correction Factor(dB/m) = Antenna Factor(dB/m) + Cable Factor(dB) – Pre-Amplifier Factor(dB)
- The other emission levels were very low against the limit.
- Margin value = Emission Level – Limit value
- " * ": Fundamental frequency.
- " # ": The radiated frequency is out of the restricted band.

CHANNEL	TX Channel 60	DETECTOR FUNCTION	Peak (PK)
FREQUENCY RANGE	1GHz ~ 40GHz		Average (AV)

ANTENNA POLARITY & TEST DISTANCE: HORIZONTAL AT 3 M

NO.	FREQ. (MHz)	EMISSION LEVEL (dBuV/m)	LIMIT (dBuV/m)	MARGIN (dB)	ANTENNA HEIGHT (m)	TABLE ANGLE (Degree)	RAW VALUE (dBuV)	CORRECTION FACTOR (dB/m)
1	5150.00	45.4 PK	74.0	-28.6	1.05 H	148	41.7	3.7
2	5150.00	36.8 AV	54.0	-17.2	1.05 H	148	33.1	3.7
3	*5300.00	112.8 PK			1.05 H	148	108.7	4.1
4	*5300.00	102.1 AV			1.05 H	148	98.0	4.1
5	5350.00	60.6 PK	74.0	-13.4	1.05 H	148	56.5	4.1
6	5350.00	48.8 AV	54.0	-5.2	1.05 H	148	44.7	4.1
7	10600.00	45.9 PK	74.0	-28.1	1.78 H	276	32.4	13.5
8	10600.00	34.3 AV	54.0	-19.7	1.78 H	276	20.8	13.5
9	15900.00	45.7 PK	74.0	-28.3	1.60 H	336	32.8	12.9
10	15900.00	33.2 AV	54.0	-20.8	1.60 H	336	20.3	12.9

ANTENNA POLARITY & TEST DISTANCE: VERTICAL AT 3 M

NO.	FREQ. (MHz)	EMISSION LEVEL (dBuV/m)	LIMIT (dBuV/m)	MARGIN (dB)	ANTENNA HEIGHT (m)	TABLE ANGLE (Degree)	RAW VALUE (dBuV)	CORRECTION FACTOR (dB/m)
1	5150.00	49.6 PK	74.0	-24.4	2.61 V	249	45.9	3.7
2	5150.00	39.2 AV	54.0	-14.8	2.61 V	249	35.5	3.7
3	*5300.00	116.2 PK			2.61 V	249	112.1	4.1
4	*5300.00	105.2 AV			2.61 V	249	101.1	4.1
5	5350.00	60.6 PK	74.0	-13.4	2.61 V	249	56.5	4.1
6	5350.00	49.3 AV	54.0	-4.7	2.61 V	249	45.2	4.1
7	10600.00	49.4 PK	74.0	-24.6	1.82 V	325	35.9	13.5
8	10600.00	37.4 AV	54.0	-16.6	1.82 V	325	23.9	13.5
9	15900.00	45.1 PK	74.0	-28.9	1.73 V	190	32.2	12.9
10	15900.00	32.6 AV	54.0	-21.4	1.73 V	190	19.7	12.9

REMARKS:

1. Emission Level(dBuV/m) = Raw Value(dBuV) + Correction Factor(dB/m)
2. Correction Factor(dB/m) = Antenna Factor(dB/m) + Cable Factor(dB) – Pre-Amplifier Factor(dB)
3. The other emission levels were very low against the limit.
4. Margin value = Emission Level – Limit value
5. " * ": Fundamental frequency.

CHANNEL	TX Channel 64	DETECTOR FUNCTION	Peak (PK)
FREQUENCY RANGE	1GHz ~ 40GHz		Average (AV)

ANTENNA POLARITY & TEST DISTANCE: HORIZONTAL AT 3 M

NO.	FREQ. (MHz)	EMISSION LEVEL (dBuV/m)	LIMIT (dBuV/m)	MARGIN (dB)	ANTENNA HEIGHT (m)	TABLE ANGLE (Degree)	RAW VALUE (dBuV)	CORRECTION FACTOR (dB/m)
1	*5320.00	111.2 PK			1.01 H	151	107.1	4.1
2	*5320.00	100.6 AV			1.01 H	151	96.5	4.1
3	5350.00	64.2 PK	74.0	-9.8	1.01 H	151	60.1	4.1
4	5350.00	51.9 AV	54.0	-2.1	1.01 H	151	47.8	4.1
5	10640.00	46.3 PK	74.0	-27.7	1.74 H	277	32.8	13.5
6	10640.00	34.2 AV	54.0	-19.8	1.74 H	277	20.7	13.5
7	15960.00	44.9 PK	74.0	-29.1	1.60 H	336	32.0	12.9
8	15960.00	32.5 AV	54.0	-21.5	1.60 H	336	19.6	12.9

ANTENNA POLARITY & TEST DISTANCE: VERTICAL AT 3 M

NO.	FREQ. (MHz)	EMISSION LEVEL (dBuV/m)	LIMIT (dBuV/m)	MARGIN (dB)	ANTENNA HEIGHT (m)	TABLE ANGLE (Degree)	RAW VALUE (dBuV)	CORRECTION FACTOR (dB/m)
1	*5320.00	114.2 PK			2.57 V	250	110.1	4.1
2	*5320.00	103.2 AV			2.57 V	250	99.1	4.1
3	5350.00	65.2 PK	74.0	-8.8	2.57 V	250	61.1	4.1
4	5350.00	53.8 AV	54.0	-0.2	2.57 V	250	49.7	4.1
5	10640.00	50.0 PK	74.0	-24.0	1.89 V	315	36.5	13.5
6	10640.00	37.7 AV	54.0	-16.3	1.89 V	315	24.2	13.5
7	15960.00	45.6 PK	74.0	-28.4	1.73 V	219	32.7	12.9
8	15960.00	33.4 AV	54.0	-20.6	1.73 V	219	20.5	12.9

REMARKS:

1. Emission Level(dBuV/m) = Raw Value(dBuV) + Correction Factor(dB/m)
2. Correction Factor(dB/m) = Antenna Factor(dB/m) + Cable Factor(dB) – Pre-Amplifier Factor(dB)
3. The other emission levels were very low against the limit.
4. Margin value = Emission Level – Limit value
5. " * ": Fundamental frequency.

CHANNEL	TX Channel 100	DETECTOR FUNCTION	Peak (PK)
FREQUENCY RANGE	1GHz ~ 40GHz		Average (AV)

ANTENNA POLARITY & TEST DISTANCE: HORIZONTAL AT 3 M

NO.	FREQ. (MHz)	EMISSION LEVEL (dBuV/m)	LIMIT (dBuV/m)	MARGIN (dB)	ANTENNA HEIGHT (m)	TABLE ANGLE (Degree)	RAW VALUE (dBuV)	CORRECTION FACTOR (dB/m)
1	#5470.00	64.9 PK	74.0	-9.1	1.11 H	149	60.7	4.2
2	#5470.00	52.5 AV	54.0	-1.5	1.11 H	149	48.3	4.2
3	*5500.00	109.8 PK			1.11 H	149	105.6	4.2
4	*5500.00	99.8 AV			1.11 H	149	95.6	4.2
5	11000.00	45.9 PK	74.0	-28.1	1.76 H	302	31.8	14.1
6	11000.00	34.0 AV	54.0	-20.0	1.76 H	302	19.9	14.1
7	#16500.00	45.3 PK	74.0	-28.7	1.58 H	338	30.8	14.5
8	#16500.00	32.8 AV	54.0	-21.2	1.58 H	338	18.3	14.5

ANTENNA POLARITY & TEST DISTANCE: VERTICAL AT 3 M

NO.	FREQ. (MHz)	EMISSION LEVEL (dBuV/m)	LIMIT (dBuV/m)	MARGIN (dB)	ANTENNA HEIGHT (m)	TABLE ANGLE (Degree)	RAW VALUE (dBuV)	CORRECTION FACTOR (dB/m)
1	#5470.00	68.0 PK	74.0	-6.0	2.55 V	247	63.8	4.2
2	#5470.00	53.9 AV	54.0	-0.1	2.55 V	247	49.7	4.2
3	*5500.00	112.5 PK			2.55 V	247	108.3	4.2
4	*5500.00	102.4 AV			2.55 V	247	98.2	4.2
5	11000.00	49.6 PK	74.0	-24.4	1.91 V	307	35.5	14.1
6	11000.00	37.6 AV	54.0	-16.4	1.91 V	307	23.5	14.1
7	#16500.00	44.9 PK	74.0	-29.1	1.71 V	194	30.4	14.5
8	#16500.00	32.4 AV	54.0	-21.6	1.71 V	194	17.9	14.5

REMARKS:

1. Emission Level(dBuV/m) = Raw Value(dBuV) + Correction Factor(dB/m)
2. Correction Factor(dB/m) = Antenna Factor(dB/m) + Cable Factor(dB) – Pre-Amplifier Factor(dB)
3. The other emission levels were very low against the limit.
4. Margin value = Emission Level – Limit value
5. " * ": Fundamental frequency.
6. " # ": The radiated frequency is out of the restricted band.

CHANNEL	TX Channel 116	DETECTOR FUNCTION	Peak (PK)
FREQUENCY RANGE	1GHz ~ 40GHz		Average (AV)

ANTENNA POLARITY & TEST DISTANCE: HORIZONTAL AT 3 M

NO.	FREQ. (MHz)	EMISSION LEVEL (dBuV/m)	LIMIT (dBuV/m)	MARGIN (dB)	ANTENNA HEIGHT (m)	TABLE ANGLE (Degree)	RAW VALUE (dBuV)	CORRECTION FACTOR (dB/m)
1	#5470.00	45.7 PK	74.0	-28.3	1.11 H	137	41.5	4.2
2	#5470.00	36.1 AV	54.0	-17.9	1.11 H	137	31.9	4.2
3	*5580.00	113.1 PK			1.11 H	137	108.9	4.2
4	*5580.00	102.2 AV			1.11 H	137	98.0	4.2
5	#5759.00	47.4 PK	74.0	-26.6	1.11 H	137	42.9	4.5
6	#5759.00	37.5 AV	54.0	-16.5	1.11 H	137	33.0	4.5
7	11160.00	46.2 PK	74.0	-27.8	1.69 H	276	32.5	13.7
8	11160.00	34.4 AV	54.0	-19.6	1.69 H	276	20.7	13.7
9	#16740.00	45.1 PK	74.0	-28.9	1.60 H	352	29.4	15.7
10	#16740.00	32.9 AV	54.0	-21.1	1.60 H	352	17.2	15.7

ANTENNA POLARITY & TEST DISTANCE: VERTICAL AT 3 M

NO.	FREQ. (MHz)	EMISSION LEVEL (dBuV/m)	LIMIT (dBuV/m)	MARGIN (dB)	ANTENNA HEIGHT (m)	TABLE ANGLE (Degree)	RAW VALUE (dBuV)	CORRECTION FACTOR (dB/m)
1	#5470.00	50.1 PK	74.0	-23.9	2.54 V	247	45.9	4.2
2	#5470.00	38.5 AV	54.0	-15.5	2.54 V	247	34.3	4.2
3	*5580.00	115.5 PK			2.54 V	247	111.3	4.2
4	*5580.00	105.2 AV			2.54 V	247	101.0	4.2
5	#5759.00	50.8 PK	74.0	-23.2	2.54 V	247	46.3	4.5
6	#5759.00	39.2 AV	54.0	-14.8	2.54 V	247	34.7	4.5
7	11160.00	50.0 PK	74.0	-24.0	1.82 V	317	36.3	13.7
8	11160.00	37.7 AV	54.0	-16.3	1.82 V	317	24.0	13.7
9	#16740.00	45.1 PK	74.0	-28.9	1.68 V	217	29.4	15.7
10	#16740.00	32.6 AV	54.0	-21.4	1.68 V	217	16.9	15.7

REMARKS:

1. Emission Level(dBuV/m) = Raw Value(dBuV) + Correction Factor(dB/m)
2. Correction Factor(dB/m) = Antenna Factor(dB/m) + Cable Factor(dB) – Pre-Amplifier Factor(dB)
3. The other emission levels were very low against the limit.
4. Margin value = Emission Level – Limit value
5. " * ": Fundamental frequency.
6. " # ": The radiated frequency is out of the restricted band.

CHANNEL	TX Channel 140	DETECTOR FUNCTION	Peak (PK)
FREQUENCY RANGE	1GHz ~ 40GHz		Average (AV)

ANTENNA POLARITY & TEST DISTANCE: HORIZONTAL AT 3 M

NO.	FREQ. (MHz)	EMISSION LEVEL (dBuV/m)	LIMIT (dBuV/m)	MARGIN (dB)	ANTENNA HEIGHT (m)	TABLE ANGLE (Degree)	RAW VALUE (dBuV)	CORRECTION FACTOR (dB/m)
1	*5700.00	110.5 PK			1.02 H	134	106.0	4.5
2	*5700.00	100.1 AV			1.02 H	134	95.6	4.5
3	#5725.00	64.9 PK	74.0	-9.1	1.02 H	134	60.5	4.4
4	#5725.00	52.3 AV	54.0	-1.7	1.02 H	134	47.9	4.4
5	11400.00	46.7 PK	74.0	-27.3	1.68 H	271	33.1	13.6
6	11400.00	34.8 AV	54.0	-19.2	1.68 H	271	21.2	13.6
7	#17100.00	45.2 PK	74.0	-28.8	1.60 H	341	27.8	17.4
8	#17100.00	33.1 AV	54.0	-20.9	1.60 H	341	15.7	17.4

ANTENNA POLARITY & TEST DISTANCE: VERTICAL AT 3 M

NO.	FREQ. (MHz)	EMISSION LEVEL (dBuV/m)	LIMIT (dBuV/m)	MARGIN (dB)	ANTENNA HEIGHT (m)	TABLE ANGLE (Degree)	RAW VALUE (dBuV)	CORRECTION FACTOR (dB/m)
1	*5700.00	113.6 PK			2.55 V	251	109.1	4.5
2	*5700.00	103.2 AV			2.55 V	251	98.7	4.5
3	#5725.00	67.8 PK	74.0	-6.2	2.55 V	251	63.4	4.4
4	#5725.00	53.9 AV	54.0	-0.1	2.55 V	251	49.5	4.4
5	11400.00	49.1 PK	74.0	-24.9	1.81 V	328	35.5	13.6
6	11400.00	37.2 AV	54.0	-16.8	1.81 V	328	23.6	13.6
7	#17100.00	45.1 PK	74.0	-28.9	1.76 V	217	27.7	17.4
8	#17100.00	32.9 AV	54.0	-21.1	1.76 V	217	15.5	17.4

REMARKS:

1. Emission Level(dBuV/m) = Raw Value(dBuV) + Correction Factor(dB/m)
2. Correction Factor(dB/m) = Antenna Factor(dB/m) + Cable Factor(dB) – Pre-Amplifier Factor(dB)
3. The other emission levels were very low against the limit.
4. Margin value = Emission Level – Limit value
5. " * ": Fundamental frequency.
6. " # ": The radiated frequency is out of the restricted band.

CHANNEL	TX Channel 144	DETECTOR FUNCTION	Peak (PK)
FREQUENCY RANGE	1GHz ~ 40GHz		Average (AV)

ANTENNA POLARITY & TEST DISTANCE: HORIZONTAL AT 3 M

NO.	FREQ. (MHz)	EMISSION LEVEL (dBuV/m)	LIMIT (dBuV/m)	MARGIN (dB)	ANTENNA HEIGHT (m)	TABLE ANGLE (Degree)	RAW VALUE (dBuV)	CORRECTION FACTOR (dB/m)
1	#5470.00	45.1 PK	74.0	-28.9	1.06 H	150	40.9	4.2
2	#5470.00	35.9 AV	54.0	-18.1	1.06 H	150	31.7	4.2
3	*5720.00	114.3 PK			1.06 H	150	109.9	4.4
4	*5720.00	104.4 AV			1.06 H	150	100.0	4.4
5	#5850.00	47.4 PK	74.0	-26.6	1.06 H	150	42.9	4.5
6	#5850.00	37.7 AV	54.0	-16.3	1.06 H	150	33.2	4.5
7	11440.00	46.5 PK	74.0	-27.5	1.75 H	286	33.0	13.5
8	11440.00	34.7 AV	54.0	-19.3	1.75 H	286	21.2	13.5
9	#17160.00	44.9 PK	74.0	-29.1	1.63 H	326	27.6	17.3
10	#17160.00	32.8 AV	54.0	-21.2	1.63 H	326	15.5	17.3

ANTENNA POLARITY & TEST DISTANCE: VERTICAL AT 3 M

NO.	FREQ. (MHz)	EMISSION LEVEL (dBuV/m)	LIMIT (dBuV/m)	MARGIN (dB)	ANTENNA HEIGHT (m)	TABLE ANGLE (Degree)	RAW VALUE (dBuV)	CORRECTION FACTOR (dB/m)
1	#5470.00	48.6 PK	74.0	-25.4	2.55 V	252	44.4	4.2
2	#5470.00	36.8 AV	54.0	-17.2	2.55 V	252	32.6	4.2
3	*5720.00	117.2 PK			2.55 V	252	112.8	4.4
4	*5720.00	107.0 AV			2.55 V	252	102.6	4.4
5	#5850.00	51.5 PK	74.0	-22.5	2.55 V	252	47.0	4.5
6	#5850.00	38.6 AV	54.0	-15.4	2.55 V	252	34.1	4.5
7	11440.00	49.6 PK	74.0	-24.4	1.86 V	320	36.1	13.5
8	11440.00	37.5 AV	54.0	-16.5	1.86 V	320	24.0	13.5
9	#17160.00	45.2 PK	74.0	-28.8	1.68 V	204	27.9	17.3
10	#17160.00	33.0 AV	54.0	-21.0	1.68 V	204	15.7	17.3

REMARKS:

1. Emission Level(dBuV/m) = Raw Value(dBuV) + Correction Factor(dB/m)
2. Correction Factor(dB/m) = Antenna Factor(dB/m) + Cable Factor(dB) – Pre-Amplifier Factor(dB)
3. The other emission levels were very low against the limit.
4. Margin value = Emission Level – Limit value
5. " * ": Fundamental frequency.
6. " # ": The radiated frequency is out of the restricted band.

802.11ac (VHT40)

CHANNEL	TX Channel 54	DETECTOR FUNCTION	Peak (PK)
FREQUENCY RANGE	1GHz ~ 40GHz		Average (AV)

ANTENNA POLARITY & TEST DISTANCE: HORIZONTAL AT 3 M

NO.	FREQ. (MHz)	EMISSION LEVEL (dBuV/m)	LIMIT (dBuV/m)	MARGIN (dB)	ANTENNA HEIGHT (m)	TABLE ANGLE (Degree)	RAW VALUE (dBuV)	CORRECTION FACTOR (dB/m)
1	5150.00	49.7 PK	74.0	-24.3	1.01 H	151	46.0	3.7
2	5150.00	41.1 AV	54.0	-12.9	1.01 H	151	37.4	3.7
3	*5270.00	107.6 PK			1.01 H	151	103.6	4.0
4	*5270.00	98.2 AV			1.01 H	151	94.2	4.0
5	5350.00	64.9 PK	74.0	-9.1	1.01 H	151	60.8	4.1
6	5350.00	52.7 AV	54.0	-1.3	1.01 H	151	48.6	4.1
7	#10540.00	46.3 PK	74.0	-27.7	1.79 H	286	33.0	13.3
8	#10540.00	34.1 AV	54.0	-19.9	1.79 H	286	20.8	13.3
9	15810.00	45.2 PK	74.0	-28.8	1.64 H	330	31.8	13.4
10	15810.00	33.0 AV	54.0	-21.0	1.64 H	330	19.6	13.4

ANTENNA POLARITY & TEST DISTANCE: VERTICAL AT 3 M

NO.	FREQ. (MHz)	EMISSION LEVEL (dBuV/m)	LIMIT (dBuV/m)	MARGIN (dB)	ANTENNA HEIGHT (m)	TABLE ANGLE (Degree)	RAW VALUE (dBuV)	CORRECTION FACTOR (dB/m)
1	5150.00	52.1 PK	74.0	-21.9	2.54 V	189	48.4	3.7
2	5150.00	43.6 AV	54.0	-10.4	2.54 V	189	39.9	3.7
3	*5270.00	110.2 PK			2.54 V	189	106.2	4.0
4	*5270.00	100.7 AV			2.54 V	189	96.7	4.0
5	5350.00	65.3 PK	74.0	-8.7	2.54 V	189	61.2	4.1
6	5350.00	53.9 AV	54.0	-0.1	2.54 V	189	49.8	4.1
7	#10540.00	49.4 PK	74.0	-24.6	1.86 V	321	36.1	13.3
8	#10540.00	37.6 AV	54.0	-16.4	1.86 V	321	24.3	13.3
9	15810.00	45.8 PK	74.0	-28.2	1.74 V	202	32.4	13.4
10	15810.00	33.3 AV	54.0	-20.7	1.74 V	202	19.9	13.4

REMARKS:

1. Emission Level(dBuV/m) = Raw Value(dBuV) + Correction Factor(dB/m)
2. Correction Factor(dB/m) = Antenna Factor(dB/m) + Cable Factor(dB) – Pre-Amplifier Factor(dB)
3. The other emission levels were very low against the limit.
4. Margin value = Emission Level – Limit value
5. " * ": Fundamental frequency.
6. " # ": The radiated frequency is out of the restricted band.

CHANNEL	TX Channel 62	DETECTOR FUNCTION	Peak (PK)
FREQUENCY RANGE	1GHz ~ 40GHz		Average (AV)

ANTENNA POLARITY & TEST DISTANCE: HORIZONTAL AT 3 M

NO.	FREQ. (MHz)	EMISSION LEVEL (dBuV/m)	LIMIT (dBuV/m)	MARGIN (dB)	ANTENNA HEIGHT (m)	TABLE ANGLE (Degree)	RAW VALUE (dBuV)	CORRECTION FACTOR (dB/m)
1	*5310.00	103.7 PK			1.02 H	155	99.6	4.1
2	*5310.00	94.4 AV			1.02 H	155	90.3	4.1
3	5350.00	65.0 PK	74.0	-9.0	1.02 H	155	60.9	4.1
4	5350.00	52.3 AV	54.0	-1.7	1.02 H	155	48.2	4.1
5	10620.00	46.4 PK	74.0	-27.6	1.75 H	277	32.9	13.5
6	10620.00	34.3 AV	54.0	-19.7	1.75 H	277	20.8	13.5
7	15930.00	45.8 PK	74.0	-28.2	1.65 H	352	33.0	12.8
8	15930.00	33.2 AV	54.0	-20.8	1.65 H	352	20.4	12.8

ANTENNA POLARITY & TEST DISTANCE: VERTICAL AT 3 M

NO.	FREQ. (MHz)	EMISSION LEVEL (dBuV/m)	LIMIT (dBuV/m)	MARGIN (dB)	ANTENNA HEIGHT (m)	TABLE ANGLE (Degree)	RAW VALUE (dBuV)	CORRECTION FACTOR (dB/m)
1	*5310.00	106.1 PK			2.56 V	188	102.0	4.1
2	*5310.00	97.1 AV			2.56 V	188	93.0	4.1
3	5350.00	66.6 PK	74.0	-7.4	2.56 V	188	62.5	4.1
4	5350.00	53.7 AV	54.0	-0.3	2.56 V	188	49.6	4.1
5	10620.00	48.8 PK	74.0	-25.2	1.82 V	306	35.3	13.5
6	10620.00	37.1 AV	54.0	-16.9	1.82 V	306	23.6	13.5
7	15930.00	44.7 PK	74.0	-29.3	1.74 V	218	31.9	12.8
8	15930.00	32.4 AV	54.0	-21.6	1.74 V	218	19.6	12.8

REMARKS:

1. Emission Level(dBuV/m) = Raw Value(dBuV) + Correction Factor(dB/m)
2. Correction Factor(dB/m) = Antenna Factor(dB/m) + Cable Factor(dB) – Pre-Amplifier Factor(dB)
3. The other emission levels were very low against the limit.
4. Margin value = Emission Level – Limit value
5. " * ": Fundamental frequency.

CHANNEL	TX Channel 102	DETECTOR FUNCTION	Peak (PK)
FREQUENCY RANGE	1GHz ~ 40GHz		Average (AV)

ANTENNA POLARITY & TEST DISTANCE: HORIZONTAL AT 3 M

NO.	FREQ. (MHz)	EMISSION LEVEL (dBuV/m)	LIMIT (dBuV/m)	MARGIN (dB)	ANTENNA HEIGHT (m)	TABLE ANGLE (Degree)	RAW VALUE (dBuV)	CORRECTION FACTOR (dB/m)
1	#5470.00	65.2 PK	74.0	-8.8	1.03 H	143	61.0	4.2
2	#5470.00	52.6 AV	54.0	-1.4	1.03 H	143	48.4	4.2
3	*5510.00	103.7 PK			1.03 H	143	99.5	4.2
4	*5510.00	94.7 AV			1.03 H	143	90.5	4.2
5	11020.00	46.1 PK	74.0	-27.9	1.69 H	290	32.1	14.0
6	11020.00	34.3 AV	54.0	-19.7	1.69 H	290	20.3	14.0
7	#16530.00	45.2 PK	74.0	-28.8	1.56 H	332	30.3	14.9
8	#16530.00	32.6 AV	54.0	-21.4	1.56 H	332	17.7	14.9

ANTENNA POLARITY & TEST DISTANCE: VERTICAL AT 3 M

NO.	FREQ. (MHz)	EMISSION LEVEL (dBuV/m)	LIMIT (dBuV/m)	MARGIN (dB)	ANTENNA HEIGHT (m)	TABLE ANGLE (Degree)	RAW VALUE (dBuV)	CORRECTION FACTOR (dB/m)
1	#5470.00	67.6 PK	74.0	-6.4	2.59 V	174	63.4	4.2
2	#5470.00	53.5 AV	54.0	-0.5	2.59 V	174	49.3	4.2
3	*5510.00	107.5 PK			2.59 V	174	103.3	4.2
4	*5510.00	97.4 AV			2.59 V	174	93.2	4.2
5	11020.00	49.8 PK	74.0	-24.2	1.85 V	310	35.8	14.0
6	11020.00	37.8 AV	54.0	-16.2	1.85 V	310	23.8	14.0
7	#16530.00	45.2 PK	74.0	-28.8	1.72 V	210	30.3	14.9
8	#16530.00	32.8 AV	54.0	-21.2	1.72 V	210	17.9	14.9

REMARKS:

1. Emission Level(dBuV/m) = Raw Value(dBuV) + Correction Factor(dB/m)
2. Correction Factor(dB/m) = Antenna Factor(dB/m) + Cable Factor(dB) – Pre-Amplifier Factor(dB)
3. The other emission levels were very low against the limit.
4. Margin value = Emission Level – Limit value
5. " * ": Fundamental frequency.
6. " # ": The radiated frequency is out of the restricted band.

CHANNEL	TX Channel 110	DETECTOR FUNCTION	Peak (PK)
FREQUENCY RANGE	1GHz ~ 40GHz		Average (AV)

ANTENNA POLARITY & TEST DISTANCE: HORIZONTAL AT 3 M

NO.	FREQ. (MHz)	EMISSION LEVEL (dBuV/m)	LIMIT (dBuV/m)	MARGIN (dB)	ANTENNA HEIGHT (m)	TABLE ANGLE (Degree)	RAW VALUE (dBuV)	CORRECTION FACTOR (dB/m)
1	#5470.00	64.2 PK	74.0	-9.8	1.08 H	147	60.0	4.2
2	#5470.00	51.8 AV	54.0	-2.2	1.08 H	147	47.6	4.2
3	*5550.00	107.2 PK			1.08 H	147	103.0	4.2
4	*5550.00	97.7 AV			1.08 H	147	93.5	4.2
5	#5725.00	46.5 PK	74.0	-27.5	1.08 H	147	42.1	4.4
6	#5725.00	37.1 AV	54.0	-16.9	1.08 H	147	32.7	4.4
7	11100.00	46.0 PK	74.0	-28.0	1.74 H	279	32.2	13.8
8	11100.00	33.9 AV	54.0	-20.1	1.74 H	279	20.1	13.8
9	#16650.00	45.1 PK	74.0	-28.9	1.60 H	328	29.5	15.6
10	#16650.00	32.6 AV	54.0	-21.4	1.60 H	328	17.0	15.6

ANTENNA POLARITY & TEST DISTANCE: VERTICAL AT 3 M

NO.	FREQ. (MHz)	EMISSION LEVEL (dBuV/m)	LIMIT (dBuV/m)	MARGIN (dB)	ANTENNA HEIGHT (m)	TABLE ANGLE (Degree)	RAW VALUE (dBuV)	CORRECTION FACTOR (dB/m)
1	#5470.00	66.2 PK	74.0	-7.8	2.48 V	179	62.0	4.2
2	#5470.00	53.8 AV	54.0	-0.2	2.48 V	179	49.6	4.2
3	*5550.00	109.6 PK			2.48 V	179	105.4	4.2
4	*5550.00	100.2 AV			2.48 V	179	96.0	4.2
5	#5725.00	50.2 PK	74.0	-23.8	2.48 V	179	45.8	4.4
6	#5725.00	38.4 AV	54.0	-15.6	2.48 V	179	34.0	4.4
7	11100.00	48.9 PK	74.0	-25.1	1.85 V	330	35.1	13.8
8	11100.00	37.0 AV	54.0	-17.0	1.85 V	330	23.2	13.8
9	#16650.00	45.7 PK	74.0	-28.3	1.79 V	217	30.1	15.6
10	#16650.00	33.1 AV	54.0	-20.9	1.79 V	217	17.5	15.6

REMARKS:

1. Emission Level(dBuV/m) = Raw Value(dBuV) + Correction Factor(dB/m)
2. Correction Factor(dB/m) = Antenna Factor(dB/m) + Cable Factor(dB) – Pre-Amplifier Factor(dB)
3. The other emission levels were very low against the limit.
4. Margin value = Emission Level – Limit value
5. " * ": Fundamental frequency.
6. " # ": The radiated frequency is out of the restricted band.

CHANNEL	TX Channel 134	DETECTOR FUNCTION	Peak (PK)
FREQUENCY RANGE	1GHz ~ 40GHz		Average (AV)

ANTENNA POLARITY & TEST DISTANCE: HORIZONTAL AT 3 M

NO.	FREQ. (MHz)	EMISSION LEVEL (dBuV/m)	LIMIT (dBuV/m)	MARGIN (dB)	ANTENNA HEIGHT (m)	TABLE ANGLE (Degree)	RAW VALUE (dBuV)	CORRECTION FACTOR (dB/m)
1	*5670.00	106.5 PK			1.08 H	154	102.2	4.3
2	*5670.00	96.1 AV			1.08 H	154	91.8	4.3
3	#5725.00	65.0 PK	74.0	-9.0	1.08 H	154	60.6	4.4
4	#5725.00	52.3 AV	54.0	-1.7	1.08 H	154	47.9	4.4
5	11340.00	45.8 PK	74.0	-28.2	1.79 H	283	32.2	13.6
6	11340.00	34.2 AV	54.0	-19.8	1.79 H	283	20.6	13.6
7	#17010.00	45.7 PK	74.0	-28.3	1.61 H	334	28.6	17.1
8	#17010.00	33.3 AV	54.0	-20.7	1.61 H	334	16.2	17.1

ANTENNA POLARITY & TEST DISTANCE: VERTICAL AT 3 M

NO.	FREQ. (MHz)	EMISSION LEVEL (dBuV/m)	LIMIT (dBuV/m)	MARGIN (dB)	ANTENNA HEIGHT (m)	TABLE ANGLE (Degree)	RAW VALUE (dBuV)	CORRECTION FACTOR (dB/m)
1	*5670.00	109.3 PK			2.48 V	174	105.0	4.3
2	*5670.00	98.6 AV			2.48 V	174	94.3	4.3
3	#5725.00	67.2 PK	74.0	-6.8	2.48 V	174	62.8	4.4
4	#5725.00	53.9 AV	54.0	-0.1	2.48 V	174	49.5	4.4
5	11340.00	49.6 PK	74.0	-24.4	1.88 V	313	36.0	13.6
6	11340.00	37.8 AV	54.0	-16.2	1.88 V	313	24.2	13.6
7	#17010.00	45.1 PK	74.0	-28.9	1.69 V	203	28.0	17.1
8	#17010.00	32.5 AV	54.0	-21.5	1.69 V	203	15.4	17.1

REMARKS:

1. Emission Level(dBuV/m) = Raw Value(dBuV) + Correction Factor(dB/m)
2. Correction Factor(dB/m) = Antenna Factor(dB/m) + Cable Factor(dB) – Pre-Amplifier Factor(dB)
3. The other emission levels were very low against the limit.
4. Margin value = Emission Level – Limit value
5. " * ": Fundamental frequency.
6. " # ": The radiated frequency is out of the restricted band.

CHANNEL	TX Channel 142	DETECTOR FUNCTION	Peak (PK)
FREQUENCY RANGE	1GHz ~ 40GHz		Average (AV)

ANTENNA POLARITY & TEST DISTANCE: HORIZONTAL AT 3 M

NO.	FREQ. (MHz)	EMISSION LEVEL (dBuV/m)	LIMIT (dBuV/m)	MARGIN (dB)	ANTENNA HEIGHT (m)	TABLE ANGLE (Degree)	RAW VALUE (dBuV)	CORRECTION FACTOR (dB/m)
1	#5470.00	45.6 PK	74.0	-28.4	1.06 H	149	41.4	4.2
2	#5470.00	35.9 AV	54.0	-18.1	1.06 H	149	31.7	4.2
3	*5710.00	108.7 PK			1.06 H	149	104.2	4.5
4	*5710.00	99.1 AV			1.06 H	149	94.6	4.5
5	#5850.00	46.7 PK	74.0	-27.3	1.06 H	149	42.2	4.5
6	#5850.00	37.1 AV	54.0	-16.9	1.06 H	149	32.6	4.5
7	11420.00	46.3 PK	74.0	-27.7	1.70 H	282	32.7	13.6
8	11420.00	34.2 AV	54.0	-19.8	1.70 H	282	20.6	13.6
9	#17130.00	44.7 PK	74.0	-29.3	1.65 H	344	27.3	17.4
10	#17130.00	32.5 AV	54.0	-21.5	1.65 H	344	15.1	17.4

ANTENNA POLARITY & TEST DISTANCE: VERTICAL AT 3 M

NO.	FREQ. (MHz)	EMISSION LEVEL (dBuV/m)	LIMIT (dBuV/m)	MARGIN (dB)	ANTENNA HEIGHT (m)	TABLE ANGLE (Degree)	RAW VALUE (dBuV)	CORRECTION FACTOR (dB/m)
1	#5470.00	48.8 PK	74.0	-25.2	2.48 V	182	44.6	4.2
2	#5470.00	37.2 AV	54.0	-16.8	2.48 V	182	33.0	4.2
3	*5710.00	111.0 PK			2.48 V	182	106.5	4.5
4	*5710.00	101.7 AV			2.48 V	182	97.2	4.5
5	#5850.00	55.5 PK	74.0	-18.5	2.48 V	182	51.0	4.5
6	#5850.00	40.9 AV	54.0	-13.1	2.48 V	182	36.4	4.5
7	11420.00	49.1 PK	74.0	-24.9	1.84 V	326	35.5	13.6
8	11420.00	37.1 AV	54.0	-16.9	1.84 V	326	23.5	13.6
9	#17130.00	45.5 PK	74.0	-28.5	1.73 V	216	28.1	17.4
10	#17130.00	32.9 AV	54.0	-21.1	1.73 V	216	15.5	17.4

REMARKS:

1. Emission Level(dBuV/m) = Raw Value(dBuV) + Correction Factor(dB/m)
2. Correction Factor(dB/m) = Antenna Factor(dB/m) + Cable Factor(dB) – Pre-Amplifier Factor(dB)
3. The other emission levels were very low against the limit.
4. Margin value = Emission Level – Limit value
5. " * ": Fundamental frequency.
6. " # ": The radiated frequency is out of the restricted band.

802.11ac (VHT80)

CHANNEL	TX Channel 58	DETECTOR FUNCTION	Peak (PK)
FREQUENCY RANGE	1GHz ~ 40GHz		Average (AV)

ANTENNA POLARITY & TEST DISTANCE: HORIZONTAL AT 3 M

NO.	FREQ. (MHz)	EMISSION LEVEL (dBuV/m)	LIMIT (dBuV/m)	MARGIN (dB)	ANTENNA HEIGHT (m)	TABLE ANGLE (Degree)	RAW VALUE (dBuV)	CORRECTION FACTOR (dB/m)
1	5150.00	51.8 PK	74.0	-22.2	1.02 H	130	48.1	3.7
2	5150.00	42.6 AV	54.0	-11.4	1.02 H	130	38.9	3.7
3	*5290.00	100.2 PK			1.02 H	130	96.1	4.1
4	*5290.00	91.1 AV			1.02 H	130	87.0	4.1
5	5350.00	65.5 PK	74.0	-8.5	1.02 H	130	61.4	4.1
6	5350.00	52.7 AV	54.0	-1.3	1.02 H	130	48.6	4.1
7	#10580.00	46.0 PK	74.0	-28.0	1.72 H	296	32.6	13.4
8	#10580.00	33.8 AV	54.0	-20.2	1.72 H	296	20.4	13.4
9	15870.00	45.8 PK	74.0	-28.2	1.62 H	351	32.8	13.0
10	15870.00	33.1 AV	54.0	-20.9	1.62 H	351	20.1	13.0

ANTENNA POLARITY & TEST DISTANCE: VERTICAL AT 3 M

NO.	FREQ. (MHz)	EMISSION LEVEL (dBuV/m)	LIMIT (dBuV/m)	MARGIN (dB)	ANTENNA HEIGHT (m)	TABLE ANGLE (Degree)	RAW VALUE (dBuV)	CORRECTION FACTOR (dB/m)
1	5150.00	60.5 PK	74.0	-13.5	2.49 V	172	56.8	3.7
2	5150.00	48.8 AV	54.0	-5.2	2.49 V	172	45.1	3.7
3	*5290.00	103.1 PK			2.49 V	172	99.0	4.1
4	*5290.00	93.7 AV			2.49 V	172	89.6	4.1
5	5350.00	66.6 PK	74.0	-7.4	2.49 V	172	62.5	4.1
6	5350.00	53.7 AV	54.0	-0.3	2.49 V	172	49.6	4.1
7	#10580.00	49.4 PK	74.0	-24.6	1.86 V	310	36.0	13.4
8	#10580.00	37.3 AV	54.0	-16.7	1.86 V	310	23.9	13.4
9	15870.00	45.2 PK	74.0	-28.8	1.74 V	204	32.2	13.0
10	15870.00	32.9 AV	54.0	-21.1	1.74 V	204	19.9	13.0

REMARKS:

1. Emission Level(dBuV/m) = Raw Value(dBuV) + Correction Factor(dB/m)
2. Correction Factor(dB/m) = Antenna Factor(dB/m) + Cable Factor(dB) – Pre-Amplifier Factor(dB)
3. The other emission levels were very low against the limit.
4. Margin value = Emission Level – Limit value
5. " * ": Fundamental frequency.
6. " # ": The radiated frequency is out of the restricted band.

CHANNEL	TX Channel 106	DETECTOR FUNCTION	Peak (PK)
FREQUENCY RANGE	1GHz ~ 40GHz		Average (AV)

ANTENNA POLARITY & TEST DISTANCE: HORIZONTAL AT 3 M

NO.	FREQ. (MHz)	EMISSION LEVEL (dBuV/m)	LIMIT (dBuV/m)	MARGIN (dB)	ANTENNA HEIGHT (m)	TABLE ANGLE (Degree)	RAW VALUE (dBuV)	CORRECTION FACTOR (dB/m)
1	#5470.00	64.3 PK	74.0	-9.7	1.02 H	158	60.1	4.2
2	#5470.00	52.0 AV	54.0	-2.0	1.02 H	158	47.8	4.2
3	*5530.00	96.7 PK			1.02 H	158	92.5	4.2
4	*5530.00	87.6 AV			1.02 H	158	83.4	4.2
5	#5725.00	46.7 PK	74.0	-27.3	1.02 H	158	42.3	4.4
6	#5725.00	37.2 AV	54.0	-16.8	1.02 H	158	32.8	4.4
7	11060.00	46.1 PK	74.0	-27.9	1.78 H	271	32.2	13.9
8	11060.00	34.1 AV	54.0	-19.9	1.78 H	271	20.2	13.9
9	#16590.00	45.2 PK	74.0	-28.8	1.62 H	355	29.6	15.6
10	#16590.00	32.9 AV	54.0	-21.1	1.62 H	355	17.3	15.6

ANTENNA POLARITY & TEST DISTANCE: VERTICAL AT 3 M

NO.	FREQ. (MHz)	EMISSION LEVEL (dBuV/m)	LIMIT (dBuV/m)	MARGIN (dB)	ANTENNA HEIGHT (m)	TABLE ANGLE (Degree)	RAW VALUE (dBuV)	CORRECTION FACTOR (dB/m)
1	#5470.00	67.8 PK	74.0	-6.2	2.47 V	176	63.6	4.2
2	#5470.00	53.7 AV	54.0	-0.3	2.47 V	176	49.5	4.2
3	*5530.00	99.2 PK			2.47 V	176	95.0	4.2
4	*5530.00	89.9 AV			2.47 V	176	85.7	4.2
5	#5725.00	50.2 PK	74.0	-23.8	2.47 V	176	45.8	4.4
6	#5725.00	38.8 AV	54.0	-15.2	2.47 V	176	34.4	4.4
7	11060.00	49.3 PK	74.0	-24.7	1.81 V	331	35.4	13.9
8	11060.00	37.5 AV	54.0	-16.5	1.81 V	331	23.6	13.9
9	#16590.00	45.9 PK	74.0	-28.1	1.75 V	192	30.3	15.6
10	#16590.00	33.4 AV	54.0	-20.6	1.75 V	192	17.8	15.6

REMARKS:

1. Emission Level(dBuV/m) = Raw Value(dBuV) + Correction Factor(dB/m)
2. Correction Factor(dB/m) = Antenna Factor(dB/m) + Cable Factor(dB) – Pre-Amplifier Factor(dB)
3. The other emission levels were very low against the limit.
4. Margin value = Emission Level – Limit value
5. " * ": Fundamental frequency.
6. " # ": The radiated frequency is out of the restricted band.

CHANNEL	TX Channel 122	DETECTOR FUNCTION	Peak (PK)
FREQUENCY RANGE	1GHz ~ 40GHz		Average (AV)

ANTENNA POLARITY & TEST DISTANCE: HORIZONTAL AT 3 M

NO.	FREQ. (MHz)	EMISSION LEVEL (dBuV/m)	LIMIT (dBuV/m)	MARGIN (dB)	ANTENNA HEIGHT (m)	TABLE ANGLE (Degree)	RAW VALUE (dBuV)	CORRECTION FACTOR (dB/m)
1	*5610.00	99.8 PK			1.08 H	146	95.4	4.4
2	*5610.00	90.7 AV			1.08 H	146	86.3	4.4
3	#5725.00	64.8 PK	74.0	-9.2	1.08 H	146	60.4	4.4
4	#5725.00	52.3 AV	54.0	-1.7	1.08 H	146	47.9	4.4
5	11220.00	46.0 PK	74.0	-28.0	1.72 H	284	32.3	13.7
6	11220.00	34.1 AV	54.0	-19.9	1.72 H	284	20.4	13.7
7	#16830.00	45.1 PK	74.0	-28.9	1.66 H	340	29.2	15.9
8	#16830.00	32.8 AV	54.0	-21.2	1.66 H	340	16.9	15.9

ANTENNA POLARITY & TEST DISTANCE: VERTICAL AT 3 M

NO.	FREQ. (MHz)	EMISSION LEVEL (dBuV/m)	LIMIT (dBuV/m)	MARGIN (dB)	ANTENNA HEIGHT (m)	TABLE ANGLE (Degree)	RAW VALUE (dBuV)	CORRECTION FACTOR (dB/m)
1	*5610.00	101.9 PK			2.48 V	176	97.5	4.4
2	*5610.00	93.2 AV			2.48 V	176	88.8	4.4
3	#5725.00	68.2 PK	74.0	-5.8	2.48 V	176	63.8	4.4
4	#5725.00	53.9 AV	54.0	-0.1	2.48 V	176	49.5	4.4
5	11220.00	49.9 PK	74.0	-24.1	1.83 V	327	36.2	13.7
6	11220.00	37.7 AV	54.0	-16.3	1.83 V	327	24.0	13.7
7	#16830.00	44.9 PK	74.0	-29.1	1.74 V	197	29.0	15.9
8	#16830.00	32.6 AV	54.0	-21.4	1.74 V	197	16.7	15.9

REMARKS:

1. Emission Level(dBuV/m) = Raw Value(dBuV) + Correction Factor(dB/m)
2. Correction Factor(dB/m) = Antenna Factor(dB/m) + Cable Factor(dB) – Pre-Amplifier Factor(dB)
3. The other emission levels were very low against the limit.
4. Margin value = Emission Level – Limit value
5. " * ": Fundamental frequency.
6. " # ": The radiated frequency is out of the restricted band.

CHANNEL	TX Channel 138	DETECTOR FUNCTION	Peak (PK)
FREQUENCY RANGE	1GHz ~ 40GHz		Average (AV)

ANTENNA POLARITY & TEST DISTANCE: HORIZONTAL AT 3 M

NO.	FREQ. (MHz)	EMISSION LEVEL (dBuV/m)	LIMIT (dBuV/m)	MARGIN (dB)	ANTENNA HEIGHT (m)	TABLE ANGLE (Degree)	RAW VALUE (dBuV)	CORRECTION FACTOR (dB/m)
1	#5470.00	49.6 PK	74.0	-24.4	1.07 H	139	45.4	4.2
2	#5470.00	40.9 AV	54.0	-13.1	1.07 H	139	36.7	4.2
3	*5690.00	102.1 PK			1.07 H	139	97.6	4.5
4	*5690.00	93.1 AV			1.07 H	139	88.6	4.5
5	#5850.00	64.9 PK	74.0	-9.1	1.07 H	139	60.4	4.5
6	#5850.00	52.7 AV	54.0	-1.3	1.07 H	139	48.2	4.5
7	11380.00	46.3 PK	74.0	-27.7	1.70 H	272	32.7	13.6
8	11380.00	34.2 AV	54.0	-19.8	1.70 H	272	20.6	13.6
9	#17070.00	45.9 PK	74.0	-28.1	1.61 H	350	28.6	17.3
10	#17070.00	33.3 AV	54.0	-20.7	1.61 H	350	16.0	17.3

ANTENNA POLARITY & TEST DISTANCE: VERTICAL AT 3 M

NO.	FREQ. (MHz)	EMISSION LEVEL (dBuV/m)	LIMIT (dBuV/m)	MARGIN (dB)	ANTENNA HEIGHT (m)	TABLE ANGLE (Degree)	RAW VALUE (dBuV)	CORRECTION FACTOR (dB/m)
1	#5470.00	63.3 PK	74.0	-10.7	2.46 V	186	59.1	4.2
2	#5470.00	45.4 AV	54.0	-8.6	2.46 V	186	41.2	4.2
3	*5690.00	104.3 PK			2.46 V	186	99.8	4.5
4	*5690.00	95.5 AV			2.46 V	186	91.0	4.5
5	#5850.00	69.9 PK	74.0	-4.1	2.46 V	186	65.4	4.5
6	#5850.00	53.9 AV	54.0	-0.1	2.46 V	186	49.4	4.5
7	11380.00	49.1 PK	74.0	-24.9	1.88 V	310	35.5	13.6
8	11380.00	37.1 AV	54.0	-16.9	1.88 V	310	23.5	13.6
9	#17070.00	45.4 PK	74.0	-28.6	1.71 V	208	28.1	17.3
10	#17070.00	33.2 AV	54.0	-20.8	1.71 V	208	15.9	17.3

REMARKS:

1. Emission Level(dBuV/m) = Raw Value(dBuV) + Correction Factor(dB/m)
2. Correction Factor(dB/m) = Antenna Factor(dB/m) + Cable Factor(dB) – Pre-Amplifier Factor(dB)
3. The other emission levels were very low against the limit.
4. Margin value = Emission Level – Limit value
5. " * ": Fundamental frequency.
6. " # ": The radiated frequency is out of the restricted band.

4.2 Conducted Emission Measurement

4.2.1 Limits of Conducted Emission Measurement

Frequency (MHz)	Conducted Limit (dBuV)	
	Quasi-peak	Average
0.15 - 0.5	66 - 56	56 - 46
0.50 - 5.0	56	46
5.0 - 30.0	60	50

Note: 1. The lower limit shall apply at the transition frequencies.

2. The limit decreases in line with the logarithm of the frequency in the range of 0.15 to 0.50MHz.

4.2.2 Test Instruments

DESCRIPTION & MANUFACTURER	MODEL NO.	SERIAL NO.	CALIBRATED DATE	CALIBRATED UNTIL
Test Receiver R&S	ESCS 30	847124/029	Oct. 24, 2016	Oct. 23, 2017
Line-Impedance Stabilization Network (for EUT) R&S	ESH3-Z5	848773/004	Oct. 26, 2016	Oct. 25, 2017
Line-Impedance Stabilization Network (for Peripheral) R&S	ENV216	100072	June 03, 2017	June 02, 2018
50 ohms Terminator	N/A	EMC-02	Sep. 29, 2016	Sep. 28, 2017
RF Cable	5D-FB	COCCAB-001	Sep. 30, 2016	Sep. 29, 2017
10 dB PAD Mini-Circuits	HAT-10+	CONATT-004	June 18, 2017	June 17, 2018
Software BVADT	BVADT_Cond_ V7.3.7.4	NA	NA	NA

Note:

1. The calibration interval of the above test instruments are 12 months and the calibrations are traceable to NML/ROC and NIST/USA.
2. The test was performed in Shielded Room No. 1.
- 3 Tested Date: July 18, 2017

4.2.3 Test Procedure

- The EUT was placed 0.4 meters from the conducting wall of the shielded room with EUT being connected to the power mains through a line impedance stabilization network (LISN). Other support units were connected to the power mains through another LISN. The two LISNs provide 50 ohm/ 50uH of coupling impedance for the measuring instrument.
- Both lines of the power mains connected to the EUT were checked for maximum conducted interference.
- The frequency range from 150kHz to 30MHz was searched. Emission levels under (Limit - 20dB) was not recorded.

NOTE: All modes of operation were investigated and the worst-case emissions are reported.

4.2.4 Deviation from Test Standard

No deviation.

4.2.5 Test Setup

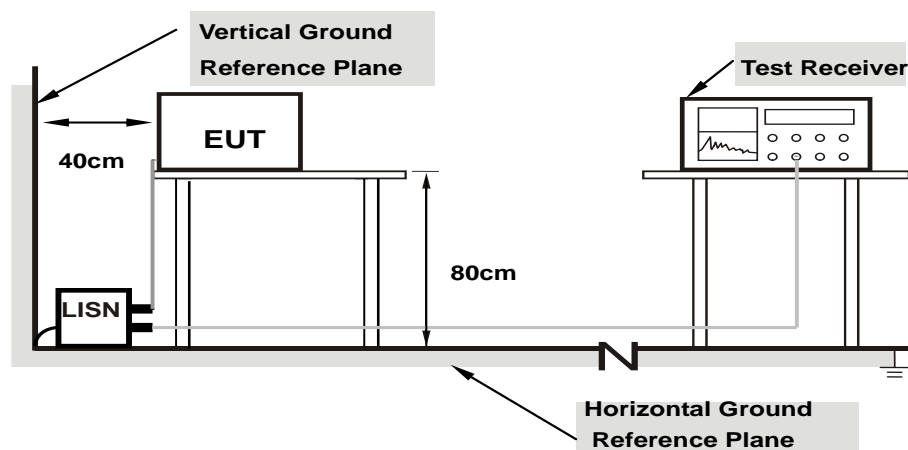

Note: 1.Support units were connected to second LISN.

For the actual test configuration, please refer to the attached file (Test Setup Photo).

4.2.6 EUT Operating Condition

Same as 4.1.6.

4.2.7 Test Results (Mode 1)

Phase	Line (L)	Detector Function	Quasi-Peak (QP) / Average (AV)
-------	----------	-------------------	--------------------------------

No	Freq. [MHz]	Corr.	Reading Value		Emission Level		Limit		Margin	
		Factor (dB)	[dB (uV)]		[dB (uV)]		[dB (uV)]		(dB)	
		Q.P.	AV.	Q.P.	AV.	Q.P.	AV.	Q.P.	AV.	
1	0.15391	10.07	40.36	31.39	50.43	41.46	65.79	55.79	-15.36	-14.33
2	0.18941	10.06	35.45	28.39	45.51	38.45	64.06	54.06	-18.55	-15.61
3	0.22031	10.07	32.29	26.26	42.36	36.33	62.81	52.81	-20.45	-16.48
4	0.40416	10.11	36.33	30.48	46.44	40.59	57.77	47.77	-11.33	-7.18
5	17.08203	11.10	31.56	27.56	42.66	38.66	60.00	50.00	-17.34	-11.34
6	28.70703	11.37	28.76	23.65	40.13	35.02	60.00	50.00	-19.87	-14.98

REMARKS:

1. Q.P. and AV. are abbreviations of quasi-peak and average individually.
2. The emission levels of other frequencies were very low against the limit.
3. Margin value = Emission level - Limit value
4. Correction factor = Insertion loss + Cable loss
5. Emission Level = Correction Factor + Reading Value.

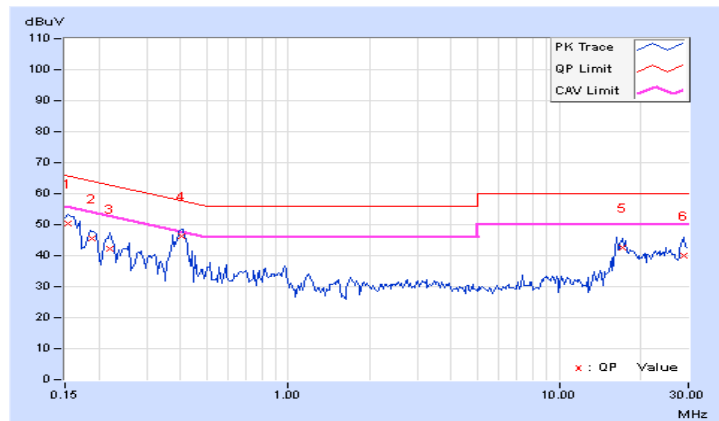

Phase	Neutral (N)	Detector Function	Quasi-Peak (QP) / Average (AV)
-------	-------------	-------------------	--------------------------------

No	Freq. [MHz]	Corr.	Reading Value		Emission Level		Limit		Margin	
		Factor	[dB (uV)]		[dB (uV)]		[dB (uV)]		(dB)	
	(dB)	Q.P.	AV.	Q.P.	AV.	Q.P.	AV.	Q.P.	AV.	
1	0.16172	10.05	39.26	29.57	49.31	39.62	65.38	55.38	-16.07	-15.76
2	0.17344	10.05	33.94	11.60	43.99	21.65	64.79	54.79	-20.80	-33.14
3	0.24766	10.05	28.74	20.14	38.79	30.19	61.84	51.84	-23.05	-21.65
4	0.40391	10.10	34.83	28.57	44.93	38.67	57.77	47.77	-12.84	-9.10
5	17.08594	10.88	30.72	26.35	41.60	37.23	60.00	50.00	-18.40	-12.77
6	28.53125	10.96	28.81	23.80	39.77	34.76	60.00	50.00	-20.23	-15.24

REMARKS:

1. Q.P. and AV. are abbreviations of quasi-peak and average individually.
2. The emission levels of other frequencies were very low against the limit.
3. Margin value = Emission level - Limit value
4. Correction factor = Insertion loss + Cable loss
5. Emission Level = Correction Factor + Reading Value.

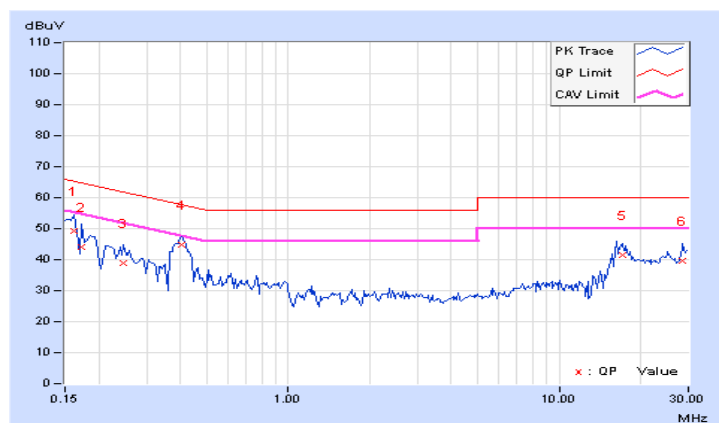

4.3 Transmit Power Measurement

4.3.1 Limits of Transmit Power Measurement

Operation Band	EUT Category		Limit
U-NII-1		Outdoor Access Point	1 Watt (30 dBm) (Max. e.i.r.p \leq 125mW(21 dBm) at any elevation angle above 30 degrees as measured from the horizon)
		Fixed point-to-point Access Point	1 Watt (30 dBm)
		Indoor Access Point	1 Watt (30 dBm)
		Mobile and Portable client device	250mW (24 dBm)
U-NII-2A		√	250mW (24 dBm) or 11 dBm+10 log B*
U-NII-2C		√	250mW (24 dBm) or 11 dBm+10 log B*
U-NII-3		√	1 Watt (30 dBm)

*B is the 26 dB emission bandwidth in megahertz

Per KDB 662911 Method of conducted output power measurement on IEEE 802.11 devices,

Array Gain = 0 dB (i.e., no array gain) for $N_{ANT} \leq 4$;

Array Gain = 0 dB (i.e., no array gain) for channel widths ≥ 40 MHz for any N_{ANT} ;

Array Gain = $5 \log(N_{ANT}/N_{SS})$ dB or 3 dB, whichever is less for 20-MHz channel widths with $N_{ANT} \geq 5$.

For power measurements on all other devices: Array Gain = $10 \log(N_{ANT}/N_{SS})$ dB.

4.3.2 Test Setup

FOR POWER OUTPUT MEASUREMENT

For channel straddling 5725MHz:

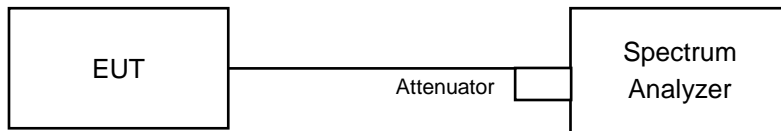

For other channels:

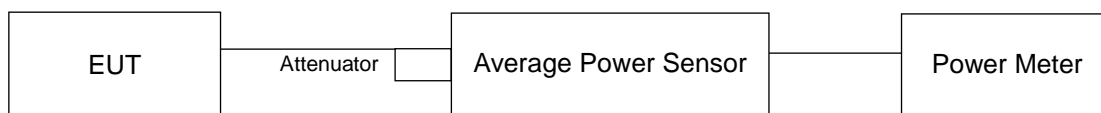

FOR 26dB OCCUPIED BANDWIDTH

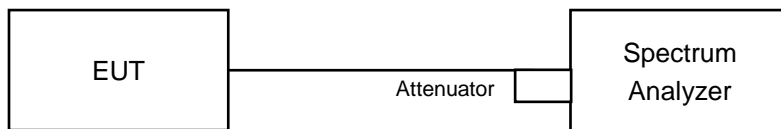

4.3.3 Test Instruments

Refer to section 4.1.2 to get information of above instrument.

4.3.4 Test Procedure

For Average Power Measurement

For channel straddling 5725MHz:

802.11ac (VHT20)

Method SA-1

1. Set span to encompass the entire emission bandwidth (EBW) of the signal.
2. Set RBW =1MHz.
3. Set the VBW $\geq 3 \times$ RBW.
4. Number of points in sweep ≥ 2 Span / RBW.
5. Sweep time = auto.
6. Set trigger to free run (duty cycle ≥ 98 percent)
7. Detector = RMS.
8. Trace average at least 100 traces in power averaging mode
9. Compute power by integrating the spectrum across the 26 dB EBW of the signal.

Other Modulation mode

Method SA-2

1. Set span to encompass the emission bandwidth (EBW) of the signal.
2. Set RBW =1MHz.
3. Set the VBW $\geq 3 \times$ RBW.
4. Number of points in sweep ≥ 2 Span / RBW.
5. Sweep time = auto.
6. Detector = RMS.
7. Trace average at least 100 traces in power averaging mode
8. Compute power by integrating the spectrum across the 26 dB EBW of the signal.
9. Duty factor need added to measured value (duty cycle < 98 percent).

For other channels:

Method PM is used to perform output power measurement, trigger and gating function of wide band power meter is enabled to measure max output power of TX on burst. Duty factor is not added to measured value.

FOR 26dB OCCUPIED BANDWIDTH

1. Set RBW = approximately 1% of the emission bandwidth.
2. Set the VBW $>$ RBW.
3. Detector = Peak.
4. Trace mode = max hold.
5. Measure the maximum width of the emission that is 26 dB down from the peak of the emission. Compare this with the RBW setting of the analyzer. Readjust RBW and repeat measurement as needed until the RBW/EBW ratio is approximately 1%.

4.3.5 Deviation from Test Standard

No deviation.

4.3.6 EUT Operating Condition

The software provided by client to enable the EUT under transmission condition continuously at lowest, middle and highest channel frequencies individually.

4.3.7 Test Result (Mode 1)

CDD Mode

802.11a

Power Output:

Chan.	Chan. Freq. (MHz)	Maximum Conducted Power (dBm)			Total Power (mW)	Total Power (dBm)	Limit (dBm)	Pass / Fail
		Chain 0	Chain 1	Chain 2				
52	5260	14.17	14.32	15.02	84.931	19.29	23.94	Pass
60	5300	14.06	14.20	14.88	82.532	19.17	23.97	Pass
64	5320	14.08	14.25	14.94	83.382	19.21	23.97	Pass
100	5500	14.46	14.06	14.61	82.3	19.15	23.96	Pass
116	5580	14.83	14.41	14.88	88.776	19.48	23.96	Pass
140	5700	14.18	14.11	14.72	81.593	19.12	23.98	Pass
*144 (UNII-2C Band)	5720	10.80	10.65	11.16	37.912	15.79	22.72	Pass
*144 (UNII-3 Band)	5720	4.46	4.51	4.91	9.003	9.54	30.00	Pass

Note: * Test was performed in accordance with Measurement follow FCC KDB 789033 UNII test procedure Method SA-2 and use spectrum analyzer test.

The Total Power for the straddle channel:

Chan.	Chan. Freq. (MHz)	Average Power (mW)	Average Power (dBm)
144	5720	46.915	16.71

Note: The total power was calculated through formula and record the value for reference only.

26dB BANDWIDTH:

Channel	Frequency (MHz)	26dBc Bandwidth (MHz)		
		Chain 0	Chain 1	Chain 2
52	5260	20.11	19.70	19.94
60	5300	19.93	19.83	19.89
64	5320	19.85	19.98	19.91
100	5500	19.97	20.17	19.77
116	5580	19.80	20.12	19.96
140	5700	19.88	20.30	20.10
144 (UNII-2C Band)	5720	15.04	15.02	14.89

Note: For U_NII-2A, U_NII-2C Band output power limitation is determined based on 26dBc bandwidth

Power Limit = 11dBm + 10logB < U_NII-2A, U_NII-2C >			
Channel Number	Freq.(MHz)	Min. B(MHz)	Determined Conducted Limit (dBm)
52	5260	19.70	23.94 < 24
60	5300	19.83	23.97 < 24
64	5320	19.85	23.97 < 24
100	5500	19.77	23.96 < 24
116	5580	19.80	23.96 < 24
140	5700	19.88	23.98 < 24
144 (UNII-2C Band)	5720	14.89	22.72 < 24

802.11ac (VHT20)
POWER OUTPUT:

Chan.	Chan. Freq. (MHz)	Maximum Conducted Power (dBm)			Total Power (mW)	Total Power (dBm)	Limit (dBm)	Pass / Fail
		Chain 0	Chain 1	Chain 2				
52	5260	14.02	14.23	15.02	83.489	19.22	24.00	Pass
60	5300	13.69	13.92	14.97	79.453	19.00	24.00	Pass
64	5320	13.97	14.17	14.92	82.114	19.14	24.00	Pass
100	5500	14.81	14.27	14.83	87.408	19.42	24.00	Pass
116	5580	14.83	14.49	14.82	88.867	19.49	24.00	Pass
140	5700	14.33	14.06	14.77	82.562	19.17	24.00	Pass
*144 (UNII-2C Band)	5720	11.27	11.42	11.79	42.366	16.27	22.85	Pass
*144 (UNII-3 Band)	5720	5.41	5.51	6.07	11.077	10.44	30.00	Pass

Note: * Test was performed in accordance with Measurement follow FCC KDB 789033 UNII test procedure Method SA-1 and use spectrum analyzer test.

The Total Power for the straddle channel:

Chan.	Chan. Freq. (MHz)	Average Power (mW)	Average Power (dBm)
144	5720	53.443	17.28

Note: The total power was calculated through formula and record the value for reference only.

26dB BANDWIDTH:

Channel	Frequency (MHz)	26dBc Bandwidth (MHz)		
		Chain 0	Chain 1	Chain 2
52	5260	20.56	20.82	20.78
60	5300	20.75	20.83	21.01
64	5320	20.74	20.79	20.71
100	5500	20.78	20.91	20.66
116	5580	21.29	20.88	20.84
140	5700	20.97	20.72	20.54
144 (UNII-2C Band)	5720	15.45	15.33	15.46

Note: For FCC output power limitation is determined based on 26dB bandwidth.

Power Limit = 11dBm + 10logB < U_NII-2A, U_NII-2C >			
Channel Number	Freq.(MHz)	Min. B(MHz)	Determined Conducted Limit (dBm)
52	5260	20.56	24.13 > 24
60	5300	20.75	24.17 > 24
64	5320	20.71	24.16 > 24
100	5500	20.66	24.15 > 24
116	5580	20.84	24.18 > 24
140	5700	20.54	24.12 > 24
144 (UNII-2C Band)	5720	15.33	22.85 < 24

802.11ac (VHT40)
POWER OUTPUT:

Chan.	Chan. Freq. (MHz)	Maximum Conducted Power (dBm)			Total Power (mW)	Total Power (dBm)	Limit (dBm)	Pass / Fail
		Chain 0	Chain 1	Chain 2				
54	5270	17.49	17.45	18.16	177.159	22.48	24.00	Pass
62	5310	17.45	17.43	18.11	175.639	22.45	24.00	Pass
102	5510	16.54	16.04	16.71	132.142	21.21	24.00	Pass
110	5550	17.81	17.38	17.89	176.615	22.47	24.00	Pass
134	5670	17.40	17.17	18.03	170.606	22.32	24.00	Pass
*142 (UNII-2C Band)	5710	14.04	14.02	14.63	82.133	19.15	24.00	Pass
*142 (UNII-3 Band)	5710	2.47	2.77	3.25	5.953	7.75	30.00	Pass

Note: * Test was performed in accordance with Measurement follow FCC KDB 789033 UNII test procedure Method SA-2 and use spectrum analyzer test.

The Total Power for the straddle channel:

Chan.	Chan. Freq. (MHz)	Average Power (mW)	Average Power (dBm)
142	5710	88.086	19.45

Note: The total power was calculated through formula and record the value for reference only.

26dB BANDWIDTH:

Channel	Frequency (MHz)	26dBc Bandwidth (MHz)		
		Chain 0	Chain 1	Chain 2
54	5270	40.71	40.83	41.15
62	5310	40.95	40.69	40.94
102	5510	40.99	40.97	41.20
110	5550	41.03	40.92	40.88
134	5670	41.12	40.86	41.03
142 (UNII-2C Band)	5710	35.63	35.60	35.44

Note: For U_NII-2A, U_NII-2C Band output power limitation is determined based on 26dBc bandwidth

Power Limit = 11dBm + 10logB < U_NII-2A, U_NII-2C >			
Channel Number	Freq.(MHz)	Min. B(MHz)	Determined Conducted Limit (dBm)
54	5270	40.71	27.09 > 24
62	5310	40.69	27.09 > 24
102	5510	40.97	27.12 > 24
110	5550	40.88	27.11 > 24
134	5670	40.86	27.11 > 24
142 (UNII-2C Band)	5710	35.44	26.49 > 24

802.11ac (VHT80)
POWER OUTPUT:

Chan.	Chan. Freq. (MHz)	Maximum Conducted Power (dBm)			Total Power (mW)	Total Power (dBm)	Limit (dBm)	Pass / Fail
		Chain 0	Chain 1	Chain 2				
58	5290	15.52	15.63	16.59	117.808	20.71	24.00	Pass
106	5530	12.83	12.42	12.84	55.876	17.47	24.00	Pass
122	5610	16.37	16.02	16.60	129.054	21.11	24.00	Pass
*138 (UNII-2C Band)	5690	14.68	14.77	15.79	102.742	20.12	24.00	Pass
*138 (UNII-3 Band)	5690	0.73	1.49	1.59	4.26	6.29	30.00	Pass

Note: * Test was performed in accordance with Measurement follow FCC KDB 789033 UNII test procedure Method SA-2 and use spectrum analyzer test.

The Total Power for the straddle channel:

Chan.	Chan. Freq. (MHz)	Average Power (mW)	Average Power (dBm)
138	5690	107.002	20.29

Note: The total power was calculated through formula and record the value for reference only.

26dB BANDWIDTH:

Channel	Frequency (MHz)	26dBc Bandwidth (MHz)		
		Chain 0	Chain 1	Chain 2
58	5290	83.55	84.10	84.21
106	5530	83.37	87.64	85.20
122	5610	84.46	84.72	84.52
138 (UNII-2C Band)	5690	111.85	116.84	130.14

Note: For U_NII-2A, U_NII-2C Band output power limitation is determined based on 26dBc bandwidth

Power Limit = 11dBm + 10logB < U_NII-2A, U_NII-2C >			
Channel Number	Freq.(MHz)	Min. B(MHz)	Determined Conducted Limit (dBm)
58	5290	83.55	30.21 > 24
106	5530	83.37	30.21 > 24
122	5610	84.46	30.26 > 24
138 (UNII-2C Band)	5690	111.85	31.48 > 24

Spectrum Plot of Worst Value

802.11a / Chain 1 - CH144 (UNII-2C Band)

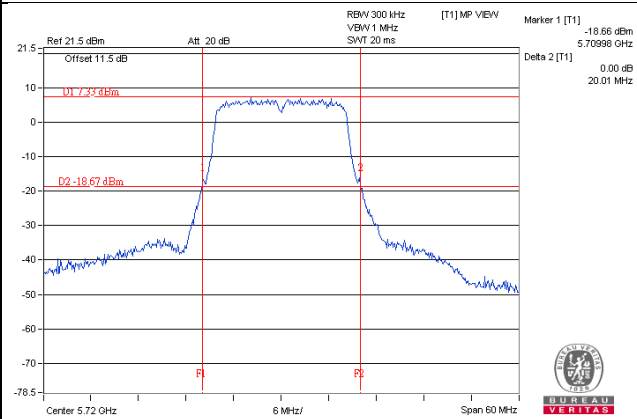

802.11ac (VHT20) / Chain 1 - CH144 (UNII-2C Band)

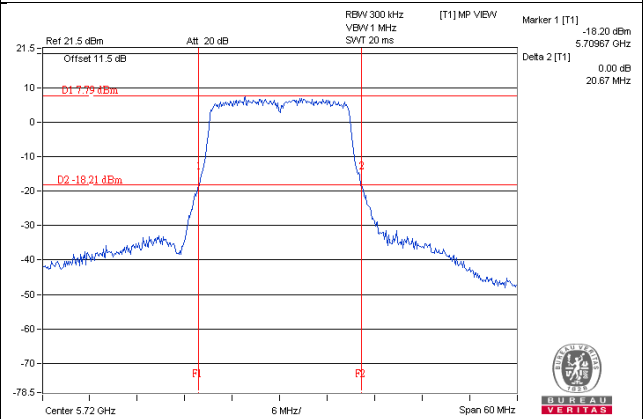

802.11ac (VHT40) / Chain 2 - CH142 (UNII-2C Band)

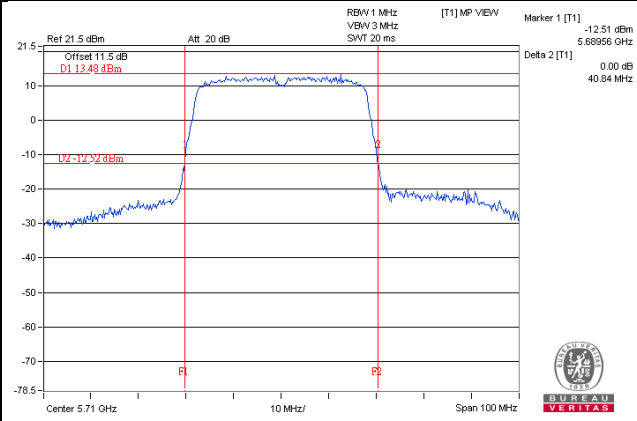

802.11ac (VHT80) / Chain 0 - CH106

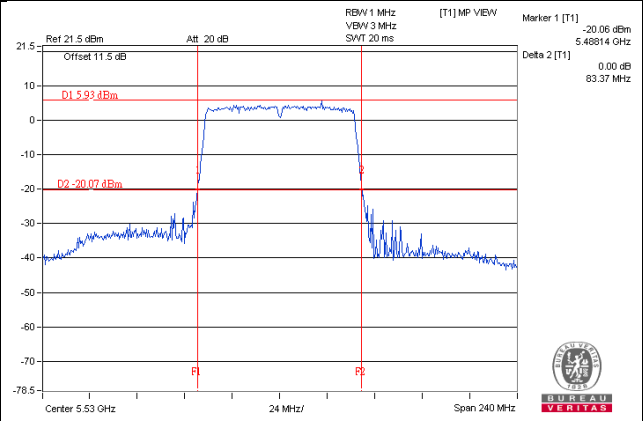

NOTE:

For CH144 (UNII-2C Band) = 5725MHz - Marker 1
 For CH142 (UNII-2C Band) = 5725MHz - Marker 1

Beamforming Mode

802.11ac (VHT20)

POWER OUTPUT:

Chan.	Chan. Freq. (MHz)	Maximum Conducted Power (dBm)			Total Power (mW)	Total Power (dBm)	Limit (dBm)	Pass / Fail
		Chain 0	Chain 1	Chain 2				
52	5260	14.02	14.23	15.02	83.489	19.22	19.50	Pass
60	5300	13.69	13.92	14.97	79.453	19.00	19.50	Pass
64	5320	13.97	14.17	14.92	82.114	19.14	19.50	Pass
100	5500	14.81	14.27	14.83	87.408	19.42	19.50	Pass
116	5580	14.83	14.49	14.82	88.867	19.49	19.50	Pass
140	5700	14.33	14.06	14.77	82.562	19.17	19.50	Pass
*144 (UNII-2C Band)	5720	11.27	11.42	11.79	42.366	16.27	18.35	Pass
*144 (UNII-3 Band)	5720	5.41	5.51	6.07	11.077	10.44	25.50	Pass

Note: 1. * Test was performed in accordance with Measurement follow FCC KDB 789033 UNII test procedure Method SA-1 and use spectrum analyzer test.

2. For UNII-2A & UNII-2C: Directional gain = $10 \log[(10^{G1/20} + 10^{G2/20} + 10^{G3/20})^2 / 3] = 10.53\text{dBi} > 6\text{dBi}$, so the power limit shall be reduced to "Determined Conducted Limit"-(10.5-6).

3. For UNII-3: Directional gain = $10 \log[(10^{G1/20} + 10^{G2/20} + 10^{G3/20})^2 / 3] = 10.5\text{dBi} > 6\text{dBi}$, so the power limit shall be reduced to $30-(10.5-6) = 25.5\text{dBm}$

The Total Power for the straddle channel:

Chan.	Chan. Freq. (MHz)	Average Power (mW)	Average Power (dBm)
144	5720	53.443	17.28

Note: The total power was calculated through formula and record the value for reference only.

26dB BANDWIDTH:

Channel	Frequency (MHz)	26dBc Bandwidth (MHz)		
		Chain 0	Chain 1	Chain 2
52	5260	20.56	20.82	20.78
60	5300	20.75	20.83	21.01
64	5320	20.74	20.79	20.71
100	5500	20.78	20.91	20.66
116	5580	21.29	20.88	20.84
140	5700	20.97	20.72	20.54
144 (UNII-2C Band)	5720	15.45	15.33	15.46

Note: For FCC output power limitation is determined based on 26dB bandwidth.

Power Limit = 11dBm + 10logB < U_NII-2A, U_NII-2C >			
Channel Number	Freq.(MHz)	Min. B(MHz)	Determined Conducted Limit (dBm)
52	5260	20.56	24.13 > 24
60	5300	20.75	24.17 > 24
64	5320	20.71	24.16 > 24
100	5500	20.66	24.15 > 24
116	5580	20.84	24.18 > 24
140	5700	20.54	24.12 > 24
144 (UNII-2C Band)	5720	15.33	22.85 < 24

802.11ac (VHT40)

POWER OUTPUT:

Chan.	Chan. Freq. (MHz)	Maximum Conducted Power (dBm)			Total Power (mW)	Total Power (dBm)	Limit (dBm)	Pass / Fail
		Chain 0	Chain 1	Chain 2				
54	5270	14.21	14.48	15.31	88.38	19.46	19.50	Pass
62	5310	14.23	14.45	15.28	88.075	19.45	19.50	Pass
102	5510	14.57	14.01	14.59	82.593	19.17	19.50	Pass
110	5550	14.45	14.17	14.62	82.956	19.19	19.50	Pass
134	5670	14.35	14.08	14.85	83.362	19.21	19.50	Pass
*142 (UNII-2C Band)	5710	11.10	10.94	11.23	39.787	16.00	19.50	Pass
*142 (UNII-3 Band)	5710	-0.51	-0.53	0.00	2.8616	4.57	25.50	Pass

Note: 1. * Test was performed in accordance with Measurement follow FCC KDB 789033 UNII test procedure Method SA-2 and use spectrum analyzer test.

2. For UNII-2A & UNII-2C: Directional gain = $10 \log[(10^{G1/20} + 10^{G2/20} + 10^{G3/20})^2 / 3] = 10.53\text{dBi} > 6\text{dBi}$, so the power limit shall be reduced to "Determined Conducted Limit"-(10.5-6).

3. For UNII-3: Directional gain = $10 \log[(10^{G1/20} + 10^{G2/20} + 10^{G3/20})^2 / 3] = 10.5\text{dBi} > 6\text{dBi}$, so the power limit shall be reduced to $30-(10.5-6) = 25.5\text{dBm}$

The Total Power for the straddle channel:

Chan.	Chan. Freq. (MHz)	Average Power (mW)	Average Power (dBm)
142	5710	42.6486	16.3

Note: The total power was calculated through formula and record the value for reference only.

26dB BANDWIDTH:

Channel	Frequency (MHz)	26dBc Bandwidth (MHz)		
		Chain 0	Chain 1	Chain 2
54	5270	40.71	40.83	41.15
62	5310	40.95	40.69	40.94
102	5510	40.99	40.97	41.20
110	5550	41.03	40.92	40.88
134	5670	41.12	40.86	41.03
142 (UNII-2C Band)	5710	35.63	35.60	35.44

Note: For U_NII-2A, U_NII-2C Band output power limitation is determined based on 26dBc bandwidth

Power Limit = 11dBm + 10logB < U_NII-2A, U_NII-2C >			
Channel Number	Freq.(MHz)	Min. B(MHz)	Determined Conducted Limit (dBm)
54	5270	40.71	27.09 > 24
62	5310	40.69	27.09 > 24
102	5510	40.97	27.12 > 24
110	5550	40.88	27.11 > 24
134	5670	40.86	27.11 > 24
142 (UNII-2C Band)	5710	35.44	26.49 > 24

802.11ac (VHT80)

POWER OUTPUT:

Chan.	Chan. Freq. (MHz)	Maximum Conducted Power (dBm)			Total Power (mW)	Total Power (dBm)	Limit (dBm)	Pass / Fail
		Chain 0	Chain 1	Chain 2				
58	5290	13.96	14.06	15.01	82.053	19.14	19.50	Pass
106	5530	12.83	12.42	12.84	55.876	17.47	19.50	Pass
122	5610	14.46	13.99	14.53	81.365	19.10	19.50	Pass
*138 (UNII-2C Band)	5690	11.22	10.64	11.09	39.792	16.00	19.50	Pass
*138 (UNII-3 Band)	5690	-3.14	-3.23	-2.49	1.6095	2.07	25.50	Pass

Note: 1. * Test was performed in accordance with Measurement follow FCC KDB 789033 UNII test procedure Method SA-2 and use spectrum analyzer test.

2. For UNII-2A & UNII-2C: Directional gain = $10 \log[(10^{G1/20} + 10^{G2/20} + 10^{G3/20})^2 / 3] = 10.53\text{dBi} > 6\text{dBi}$, so the power limit shall be reduced to "Determined Conducted Limit"-(10.5-6).

3. For UNII-3: Directional gain = $10 \log[(10^{G1/20} + 10^{G2/20} + 10^{G3/20})^2 / 3] = 10.5\text{dBi} > 6\text{dBi}$, so the power limit shall be reduced to $30-(10.5-6) = 25.5\text{dBm}$

The Total Power for the straddle channel:

Chan.	Chan. Freq. (MHz)	Average Power (mW)	Average Power (dBm)
138	5690	41.4015	16.17

Note: The total power was calculated through formula and record the value for reference only.

26dB BANDWIDTH:

Channel	Frequency (MHz)	26dBc Bandwidth (MHz)		
		Chain 0	Chain 1	Chain 2
58	5290	83.55	84.10	84.21
106	5530	83.37	87.64	85.20
122	5610	84.46	84.72	84.52
138 (UNII-2C Band)	5690	111.85	116.84	130.14

Note: For U_NII-2A, U_NII-2C Band output power limitation is determined based on 26dBc bandwidth

Power Limit = 11dBm + 10logB < U_NII-2A, U_NII-2C >			
Channel Number	Freq.(MHz)	Min. B(MHz)	Determined Conducted Limit (dBm)
58	5290	83.55	30.21 > 24
106	5530	83.37	30.21 > 24
122	5610	84.46	30.26 > 24
138 (UNII-2C Band)	5690	111.85	31.48 > 24

Spectrum Plot of Worst Value

802.11ac (VHT20) / Chain 1 - CH144 (UNII-2C Band) 802.11ac (VHT40) / Chain 2 - CH142 (UNII-2C Band)

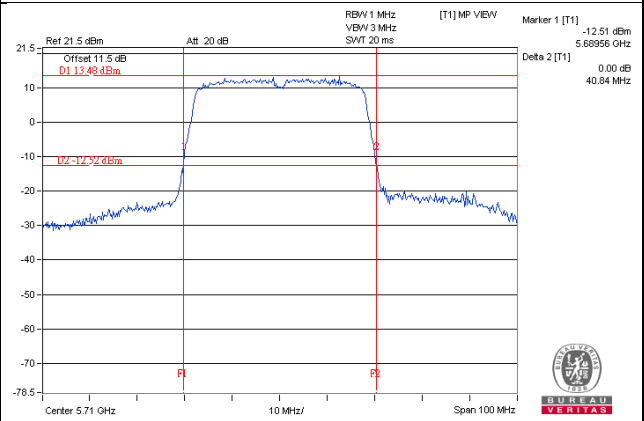
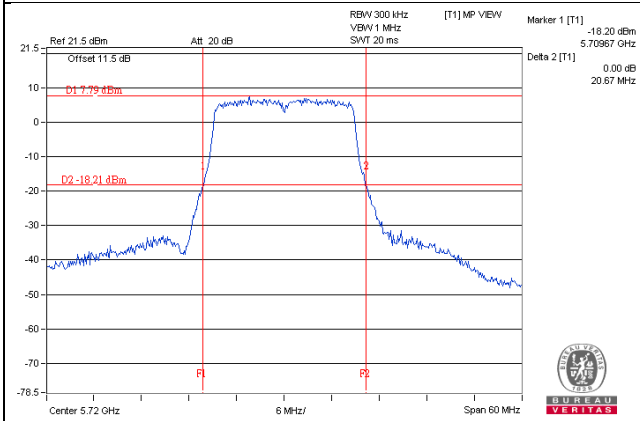

802.11ac (VHT80) / Chain 0 - CH106

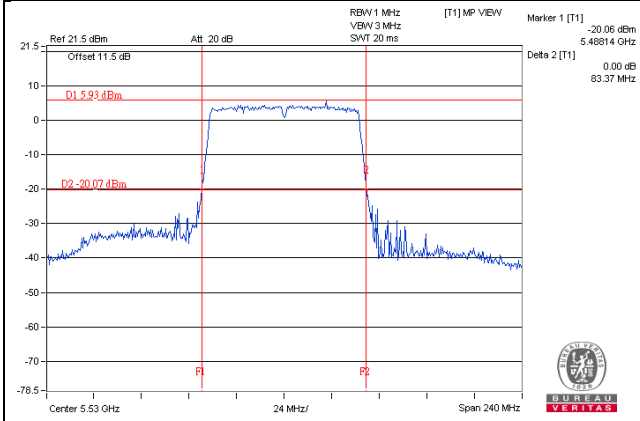

NOTE:

- For CH144 (UNII-2C Band) = 5725MHz - Marker 1
- For CH142 (UNII-2C Band) = 5725MHz - Marker 1
- For CH138 (UNII-2C Band) = 5725MHz - Marker 1

4.3.8 Test Result (Mode 2)

CDD Mode

802.11a

Power Output:

Chan.	Chan. Freq. (MHz)	Maximum Conducted Power (dBm)		Total Power (mW)	Total Power (dBm)	Limit (dBm)	Pass / Fail
		Chain 1	Chain 2				
52	5260	17.76	18.23	126.231	21.01	23.93	Pass
60	5300	17.73	18.32	127.213	21.05	23.96	Pass
64	5320	17.77	18.47	130.148	21.14	24.00	Pass
100	5500	17.61	18.10	122.242	20.87	24.00	Pass
116	5580	17.51	17.76	116.068	20.65	24.00	Pass
140	5700	17.52	18.21	122.716	20.89	24.00	Pass
*144 (UNII-2C Band)	5720	13.89	14.47	54.216	17.34	22.72	Pass
*144 (UNII-3 Band)	5720	7.56	8.29	12.858	11.09	30.00	Pass

Note: * Test was performed in accordance with Measurement follow FCC KDB 789033 UNII test procedure Method SA-2 and use spectrum analyzer test.

The Total Power for the straddle channel:

Chan.	Chan. Freq. (MHz)	Average Power (mW)	Average Power (dBm)
144	5720	67.074	18.27

Note: The total power was calculated through formula and record the value for reference only.

26dB BANDWIDTH:

Channel	Frequency (MHz)	26dBc Bandwidth (MHz)	
		Chain 1	Chain 2
52	5260	19.66	20.15
60	5300	19.83	19.77
64	5320	19.98	20.29
100	5500	20.05	20.04
116	5580	19.97	20.05
140	5700	20.68	20.67
144 (UNII-2C Band)	5720	15.15	14.88

Note: For U_NII-2A, U_NII-2C Band output power limitation is determined based on 26dBc bandwidth

Power Limit = 11dBm + 10logB < U_NII-2A, U_NII-2C >			
Channel Number	Freq.(MHz)	Min. B(MHz)	Determined Conducted Limit (dBm)
52	5260	19.66	23.93 < 24
60	5300	19.77	23.96 < 24
64	5320	19.98	24 = 24
100	5500	20.04	24.01 > 24
116	5580	19.97	24 = 24
140	5700	20.67	24.15 > 24
144 (UNII-2C Band)	5720	14.88	22.72 < 24

802.11ac (VHT20)

POWER OUTPUT:

Chan.	Chan. Freq. (MHz)	Maximum Conducted Power (dBm)		Total Power (mW)	Total Power (dBm)	Limit (dBm)	Pass / Fail
		Chain 1	Chain 2				
52	5260	17.81	18.42	129.897	21.14	24.00	Pass
60	5300	17.79	18.42	129.619	21.13	24.00	Pass
64	5320	17.82	18.41	129.877	21.14	24.00	Pass
100	5500	17.72	18.26	126.144	21.01	24.00	Pass
116	5580	17.56	18.01	120.257	20.80	24.00	Pass
140	5700	17.72	18.29	126.609	21.02	24.00	Pass
*144 (UNII-2C Band)	5720	14.55	14.87	59.2	17.72	22.86	Pass
*144 (UNII-3 Band)	5720	8.66	8.93	15.161	11.81	30.00	Pass

Note: * Test was performed in accordance with Measurement follow FCC KDB 789033 UNII test procedure Method SA-1 and use spectrum analyzer test.

The Total Power for the straddle channel:

Chan.	Chan. Freq. (MHz)	Average Power (mW)	Average Power (dBm)
144	5720	74.361	18.71

Note: The total power was calculated through formula and record the value for reference only.

26dB BANDWIDTH:

Channel	Frequency (MHz)	26dBc Bandwidth (MHz)	
		Chain 1	Chain 2
52	5260	20.63	20.87
60	5300	20.78	20.68
64	5320	20.71	20.91
100	5500	20.66	20.98
116	5580	21.03	20.90
140	5700	20.92	20.70
144 (UNII-2C Band)	5720	15.35	15.42

Note: For FCC output power limitation is determined based on 26dB bandwidth.

Power Limit = 11dBm + 10logB < U_NII-2A, U_NII-2C >			
Channel Number	Freq.(MHz)	Min. B(MHz)	Determined Conducted Limit (dBm)
52	5260	20.63	24.14 > 24
60	5300	20.68	24.15 > 24
64	5320	20.71	24.16 > 24
100	5500	20.66	24.15 > 24
116	5580	20.90	24.2 > 24
140	5700	20.70	24.15 > 24
144 (UNII-2C Band)	5720	15.35	22.86 < 24

802.11ac (VHT40)
POWER OUTPUT:

Chan.	Chan. Freq. (MHz)	Maximum Conducted Power (dBm)		Total Power (mW)	Total Power (dBm)	Limit (dBm)	Pass / Fail
		Chain 1	Chain 2				
54	5270	20.67	21.22	249.115	23.96	24.00	Pass
62	5310	18.01	18.92	141.224	21.50	24.00	Pass
102	5510	16.01	16.67	86.354	19.36	24.00	Pass
110	5550	19.65	20.02	192.719	22.85	24.00	Pass
134	5670	18.01	18.78	138.75	21.42	24.00	Pass
*142 (UNII-2C Band)	5710	16.65	16.62	95.059	19.78	24.00	Pass
*142 (UNII-3 Band)	5710	5.20	5.19	6.823	8.34	30.00	Pass

Note: * Test was performed in accordance with Measurement follow FCC KDB 789033 UNII test procedure Method SA-2 and use spectrum analyzer test.

The Total Power for the straddle channel:

Chan.	Chan. Freq. (MHz)	Average Power (mW)	Average Power (dBm)
142	5710	101.882	20.08

Note: The total power was calculated through formula and record the value for reference only.

26dB BANDWIDTH:

Channel	Frequency (MHz)	26dBc Bandwidth (MHz)	
		Chain 1	Chain 2
54	5270	46.96	62.62
62	5310	41.15	40.99
102	5510	40.97	41.20
110	5550	43.40	54.77
134	5670	40.96	41.36
142 (UNII-2C Band)	5710	50.65	53.44

Note: For U_NII-2A, U_NII-2C Band output power limitation is determined based on 26dBc bandwidth

Power Limit = 11dBm + 10logB < U_NII-2A, U_NII-2C >			
Channel Number	Freq.(MHz)	Min. B(MHz)	Determined Conducted Limit (dBm)
54	5270	46.96	27.71 > 24
62	5310	40.99	27.12 > 24
102	5510	40.97	27.12 > 24
110	5550	43.40	27.37 > 24
134	5670	40.96	27.12 > 24
142 (UNII-2C Band)	5710	50.65	28.04 > 24

802.11ac (VHT80)

POWER OUTPUT:

Chan.	Chan. Freq. (MHz)	Maximum Conducted Power (dBm)		Total Power (mW)	Total Power (dBm)	Limit (dBm)	Pass / Fail
		Chain 1	Chain 2				
58	5290	15.67	16.53	81.876	19.13	24.00	Pass
106	5530	12.43	12.89	36.952	15.68	24.00	Pass
122	5610	15.91	16.47	83.355	19.21	24.00	Pass
*138 (UNII-2C Band)	5690	14.77	15.79	71.723	18.56	24.00	Pass
*138 (UNII-3 Band)	5690	1.49	1.59	3.01	4.79	30.00	Pass

Note: * Test was performed in accordance with Measurement follow FCC KDB 789033 UNII test procedure Method SA-2 and use spectrum analyzer test.

The Total Power for the straddle channel:

Chan.	Chan. Freq. (MHz)	Average Power (mW)	Average Power (dBm)
138	5690	74.733	18.74

Note: The total power was calculated through formula and record the value for reference only.

26dB BANDWIDTH:

Channel	Frequency (MHz)	26dBc Bandwidth (MHz)	
		Chain 1	Chain 2
58	5290	84.10	84.21
106	5530	87.64	85.20
122	5610	84.72	84.52
138 (UNII-2C Band)	5690	116.84	130.14

Note: For U_NII-2A, U_NII-2C Band output power limitation is determined based on 26dBc bandwidth

Power Limit = 11dBm + 10logB < U_NII-2A, U_NII-2C >			
Channel Number	Freq.(MHz)	Min. B(MHz)	Determined Conducted Limit (dBm)
58	5290	84.10	30.24 > 24
106	5530	85.20	30.3 > 24
122	5610	84.52	30.26 > 24
138 (UNII-2C Band)	5690	116.84	31.67 > 24

Spectrum Plot of Worst Value

802.11a / Chain 2 - CH144 (UNII-2C Band)

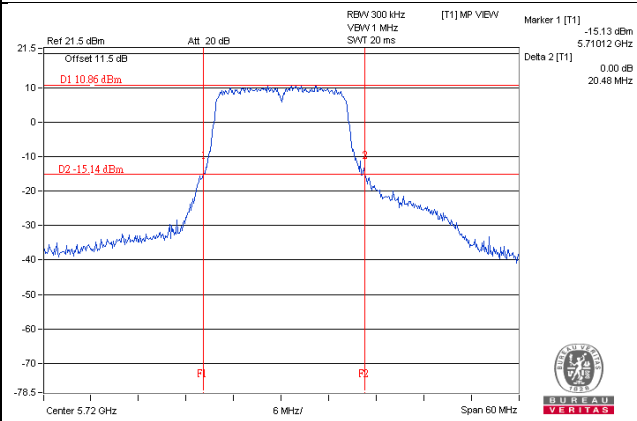

802.11ac (VHT20) / Chain 1 - CH144 (UNII-2C Band)

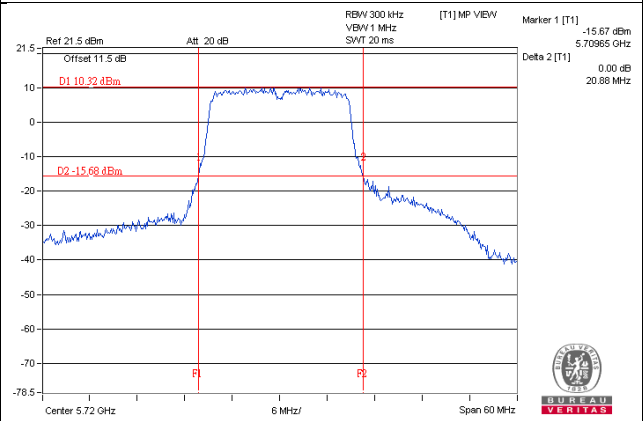

802.11ac (VHT40) / Chain 1 - CH134

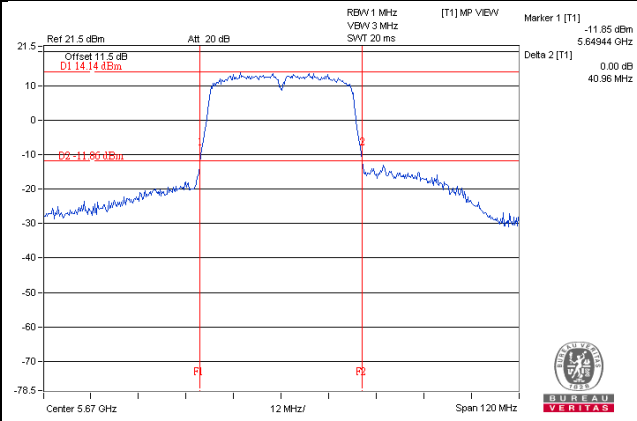

802.11ac (VHT80) / Chain 1 - CH58

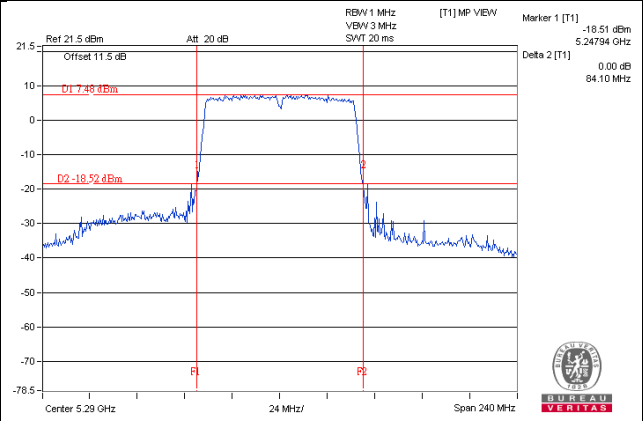

NOTE:

For CH144 (UNII-2C Band) = 5725MHz - Marker 1

Beamforming Mode

802.11ac (VHT20)

POWER OUTPUT:

Chan.	Chan. Freq. (MHz)	Maximum Conducted Power (dBm)		Total Power (mW)	Total Power (dBm)	Limit (dBm)	Pass / Fail
		Chain 1	Chain 2				
52	5260	17.81	18.42	129.897	21.14	21.15	Pass
60	5300	17.79	18.42	129.619	21.13	21.15	Pass
64	5320	17.82	18.41	129.877	21.14	21.15	Pass
100	5500	17.72	18.26	126.144	21.01	21.15	Pass
116	5580	17.56	18.01	120.257	20.80	21.15	Pass
140	5700	17.72	18.29	126.609	21.02	21.15	Pass
*144 (UNII-2C Band)	5720	14.55	14.87	59.2	17.72	20.01	Pass
*144 (UNII-3 Band)	5720	8.66	8.93	15.161	11.81	27.15	Pass

Note: 1. * Test was performed in accordance with Measurement follow FCC KDB 789033 UNII test procedure Method SA-1 and use spectrum analyzer test.

2. For UNII-2A & UNII-2C: Directional gain = $10 \log[(10^{G2/20} + 10^{G3/20})^2 / 2] = 8.85\text{dBi} > 6\text{dBi}$, so the power limit shall be reduced to "Determined Conducted Limit" -(8.85-6).

3. For UNII-3: Directional gain = $10 \log[(10^{G2/20} + 10^{G3/20})^2 / 2] = 8.85\text{dBi} > 6\text{dBi}$, so the power limit shall be reduced to $30-(8.85-6) = 27.15\text{dBm}$.

The Total Power for the straddle channel:

Chan.	Chan. Freq. (MHz)	Average Power (mW)	Average Power (dBm)
144	5720	74.361	18.71

Note: The total power was calculated through formula and record the value for reference only.

26dB BANDWIDTH:

Channel	Frequency (MHz)	26dBc Bandwidth (MHz)	
		Chain 1	Chain 2
52	5260	20.63	20.87
60	5300	20.78	20.68
64	5320	20.71	20.91
100	5500	20.66	20.98
116	5580	21.03	20.90
140	5700	20.92	20.70
144 (UNII-2C Band)	5720	15.35	15.42

Note: For FCC output power limitation is determined based on 26dB bandwidth.

Power Limit = 11dBm + 10logB < U_NII-2A, U_NII-2C >			
Channel Number	Freq.(MHz)	Min. B(MHz)	Determined Conducted Limit (dBm)
52	5260	20.63	24.14 > 24
60	5300	20.68	24.15 > 24
64	5320	20.71	24.16 > 24
100	5500	20.66	24.15 > 24
116	5580	20.90	24.2 > 24
140	5700	20.70	24.15 > 24
144 (UNII-2C Band)	5720	15.35	22.86 < 24

802.11ac (VHT40)
POWER OUTPUT:

Chan.	Chan. Freq. (MHz)	Maximum Conducted Power (dBm)		Total Power (mW)	Total Power (dBm)	Limit (dBm)	Pass / Fail
		Chain 1	Chain 2				
54	5270	17.69	18.28	126.047	21.01	21.15	Pass
62	5310	17.52	18.41	125.837	21.00	21.15	Pass
102	5510	16.01	16.67	86.354	19.36	21.15	Pass
110	5550	17.64	17.93	120.163	20.80	21.15	Pass
134	5670	17.57	18.31	124.912	20.97	21.15	Pass
*142 (UNII-2C Band)	5710	13.89	14.38	53.541	17.29	21.15	Pass
*142 (UNII-3 Band)	5710	2.30	3.17	3.892	5.90	27.15	Pass

Note: 1. * Test was performed in accordance with Measurement follow FCC KDB 789033 UNII test procedure Method SA-2 and use spectrum analyzer test.

2. For UNII-2A & UNII-2C: Directional gain = $10 \log[(10^{G2/20} + 10^{G3/20})^2 / 2] = 8.85\text{dBi} > 6\text{dBi}$, so the power limit shall be reduced to "Determined Conducted Limit" -(8.85-6).

3. For UNII-3: Directional gain = $10 \log[(10^{G2/20} + 10^{G3/20})^2 / 2] = 8.85\text{dBi} > 6\text{dBi}$, so the power limit shall be reduced to $30-(8.85-6) = 27.15\text{dBm}$.

The Total Power for the straddle channel:

Chan.	Chan. Freq. (MHz)	Average Power (mW)	Average Power (dBm)
142	5710	57.433	17.59

Note: The total power was calculated through formula and record the value for reference only.

26dB BANDWIDTH:

Channel	Frequency (MHz)	26dBc Bandwidth (MHz)	
		Chain 1	Chain 2
54	5270	46.96	62.62
62	5310	41.15	40.99
102	5510	40.97	41.20
110	5550	43.40	54.77
134	5670	40.96	41.36
142 (UNII-2C Band)	5710	50.65	53.44

Note: For U_NII-2A, U_NII-2C Band output power limitation is determined based on 26dBc bandwidth

Power Limit = 11dBm + 10logB < U_NII-2A, U_NII-2C >			
Channel Number	Freq.(MHz)	Min. B(MHz)	Determined Conducted Limit (dBm)
54	5270	46.96	27.71 > 24
62	5310	40.99	27.12 > 24
102	5510	40.97	27.12 > 24
110	5550	43.40	27.37 > 24
134	5670	40.96	27.12 > 24
142 (UNII-2C Band)	5710	50.65	28.04 > 24

802.11ac (VHT80)
POWER OUTPUT:

Chan.	Chan. Freq. (MHz)	Maximum Conducted Power (dBm)		Total Power (mW)	Total Power (dBm)	Limit (dBm)	Pass / Fail
		Chain 1	Chain 2				
58	5290	15.67	16.53	81.876	19.13	21.15	Pass
106	5530	12.43	12.89	36.952	15.68	21.15	Pass
122	5610	15.91	16.47	83.355	19.21	21.15	Pass
*138 (UNII-2C Band)	5690	13.55	14.12	51.181	17.09	21.15	Pass
*138 (UNII-3 Band)	5690	-0.70	0.21	2.0069	3.03	27.15	Pass

Note: 1. * Test was performed in accordance with Measurement follow FCC KDB 789033 UNII test procedure Method SA-2 and use spectrum analyzer test.

2. For UNII-2A & UNII-2C: Directional gain = $10 \log[(10^{G2/20} + 10^{G3/20})^2 / 2] = 8.85\text{dBi} > 6\text{dBi}$, so the power limit shall be reduced to "Determined Conducted Limit" -(8.85-6).

3. For UNII-3: Directional gain = $10 \log[(10^{G2/20} + 10^{G3/20})^2 / 2] = 8.85\text{dBi} > 6\text{dBi}$, so the power limit shall be reduced to $30-(8.85-6) = 27.15\text{dBm}$.

The Total Power for the straddle channel:

Chan.	Chan. Freq. (MHz)	Average Power (mW)	Average Power (dBm)
138	5690	53.1879	17.26

Note: The total power was calculated through formula and record the value for reference only.

26dB BANDWIDTH:

Channel	Frequency (MHz)	26dBc Bandwidth (MHz)	
		Chain 1	Chain 2
58	5290	84.10	84.21
106	5530	87.64	85.20
122	5610	84.72	84.52
138 (UNII-2C Band)	5690	116.84	130.14

Note: For U_NII-2A, U_NII-2C Band output power limitation is determined based on 26dBc bandwidth

Power Limit = 11dBm + 10logB < U_NII-2A, U_NII-2C >			
Channel Number	Freq.(MHz)	Min. B(MHz)	Determined Conducted Limit (dBm)
58	5290	84.10	30.24 > 24
106	5530	85.20	30.3 > 24
122	5610	84.52	30.26 > 24
138 (UNII-2C Band)	5690	116.84	31.67 > 24

Spectrum Plot of Worst Value

802.11ac (VHT20) / Chain 1 - CH144 (UNII-2C Band)

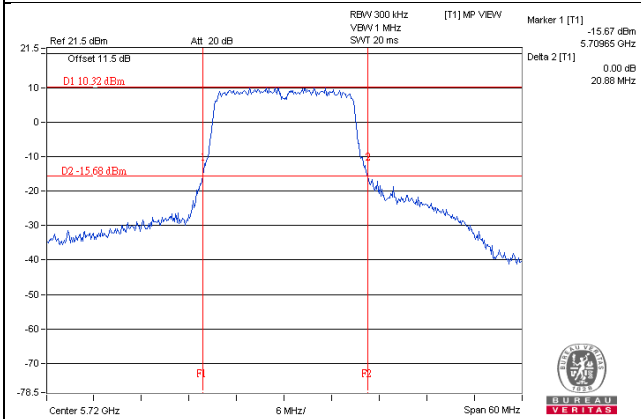

802.11ac (VHT40) / Chain 1 - CH134

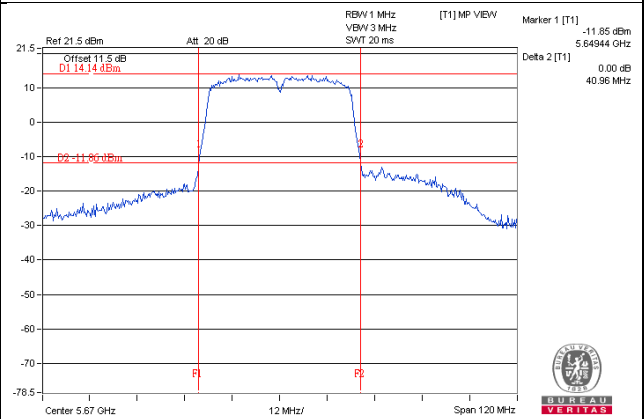

802.11ac (VHT80) / Chain 1 - CH58

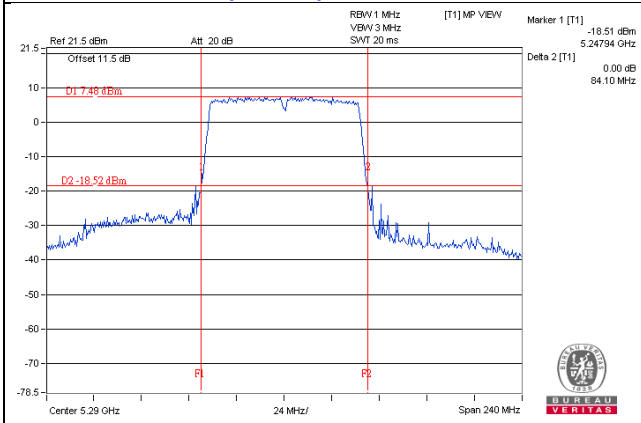

NOTE:

For CH144 (UNII-2C Band) = 5725MHz - Marker 1

4.3.9 Test Result (Mode 3)

802.11a

Power Output:

Channel	Channel Frequency (MHz)	Maximum Conducted Power (mW)	Maximum Conducted Power (dBm)	Power Limit (dBm)	Pass/Fail
52	5260	180.302	22.56	24.00	Pass
60	5300	178.649	22.52	24.00	Pass
64	5320	115.345	20.62	24.00	Pass
100	5500	83.176	19.20	24.00	Pass
116	5580	146.893	21.67	24.00	Pass
140	5700	91.411	19.61	24.00	Pass
*144 (UNII-2C Band)	5720	53.103	17.25	23.73	Pass
*144 (UNII-3 Band)	5720	12.593	11.00	30.00	Pass

Note: 1. * Test was performed in accordance with Measurement follow FCC KDB 789033 UNII test procedure Method SA-2 and use spectrum analyzer test.

The Total Power for the straddle channel:

Chan.	Chan. Freq. (MHz)	Average Power (mW)	Average Power (dBm)
144	5720	65.696	18.18

Note: The total power was calculated through formula and record the value for reference only.

26dB BANDWIDTH:

Channel	Frequency (MHz)	26dBc Bandwidth (MHz)
52	5260	31.92
60	5300	33.88
64	5320	20.48
100	5500	20.09
116	5580	32.02
140	5700	20.25
144 (UNII-2C Band)	5720	18.76

Note: For U-NII-2A, U-NII-2C Band output power limitation is determined based on 26dBc bandwidth

Power Limit = 11dBm + 10logB < U-NII-2A, U-NII-2C >			
Channel Number	Freq.(MHz)	Min. B(MHz)	Determined Conducted Limit (dBm)
52	5260	31.92	26.04 > 24
60	5300	33.88	26.29 > 24
64	5320	20.48	24.11 > 24
100	5500	20.09	24.02 > 24
116	5580	32.02	26.05 > 24
140	5700	20.25	24.06 > 24
144 (UNII-2C Band)	5720	18.76	23.73 < 24

802.11ac (VHT20)

Power Output:

Channel	Channel Frequency (MHz)	Maximum Conducted Power (mW)	Maximum Conducted Power (dBm)	Power Limit (dBm)	Pass/Fail
52	5260	173.38	22.39	24.00	Pass
60	5300	179.061	22.53	24.00	Pass
64	5320	115.08	20.61	24.00	Pass
100	5500	76.56	18.84	24.00	Pass
116	5580	140.281	21.47	24.00	Pass
140	5700	67.764	18.31	24.00	Pass
*144 (UNII-2C Band)	5720	54.828	17.39	23.80	Pass
*144 (UNII-3 Band)	5720	14.521	11.62	30.00	Pass

Note: 1. * Test was performed in accordance with Measurement follow FCC KDB 789033 UNII test procedure Method SA-1 and use spectrum analyzer test.

The Total Power for the straddle channel:

Chan.	Chan. Freq. (MHz)	Average Power (mW)	Average Power (dBm)
144	5720	69.349	18.41

Note: The total power was calculated through formula and record the value for reference only.

26dB BANDWIDTH:

Channel	Frequency (MHz)	26dBc Bandwidth (MHz)
52	5260	32.24
60	5300	34.84
64	5320	20.77
100	5500	20.82
116	5580	30.21
140	5700	20.87
144 (UNII-2C Band)	5720	19.09

Note: For U-NII-2A, U-NII-2C Band output power limitation is determined based on 26dBc bandwidth

Power Limit = 11dBm + 10logB < U-NII-2A, U-NII-2C >			
Channel Number	Freq.(MHz)	Min. B(MHz)	Determined Conducted Limit (dBm)
52	5260	32.24	26.08 > 24
60	5300	34.84	26.42 > 24
64	5320	20.77	24.17 > 24
100	5500	20.82	24.18 > 24
116	5580	30.21	25.8 > 24
140	5700	20.87	24.19 > 24
144 (UNII-2C Band)	5720	19.09	23.8 < 24

802.11ac (VHT40)

Channel	Channel Frequency (MHz)	Maximum Conducted Power (mW)	Maximum Conducted Power (dBm)	Power Limit (dBm)	Pass/Fail
54	5270	153.109	21.85	24.00	Pass
62	5310	78.886	18.97	24.00	Pass
102	5510	71.779	18.56	24.00	Pass
110	5550	127.644	21.06	24.00	Pass
134	5670	93.972	19.73	24.00	Pass
*142 (UNII-2C Band)	5710	66.598	18.23	24.00	Pass
*142 (UNII-3 Band)	5710	4.937	6.93	30.00	Pass

Note: 1. * Test was performed in accordance with Measurement follow FCC KDB 789033 UNII test procedure Method SA-2 and use spectrum analyzer test.

The Total Power for the straddle channel:

Chan.	Chan. Freq. (MHz)	Average Power (mW)	Average Power (dBm)
142	5710	71.535	18.55

Note: The total power was calculated through formula and record the value for reference only.

26dB BANDWIDTH:

Channel	Frequency (MHz)	26dBc Bandwidth (MHz)
54	5270	61.41
62	5310	40.97
102	5510	41.06
110	5550	65.13
134	5670	41.37
142 (UNII-2C Band)	5710	58.46

Note: For U-NII-2A, U-NII-2C Band output power limitation is determined based on 26dBc bandwidth

Power Limit = 11dBm + 10logB < U-NII-2A, U-NII-2C >			
Channel Number	Freq.(MHz)	Min. B(MHz)	Determined Conducted Limit (dBm)
54	5270	61.41	28.88 > 24
62	5310	40.97	27.12 > 24
102	5510	41.06	27.13 > 24
110	5550	65.13	29.13 > 24
134	5670	41.37	27.16 > 24
142 (UNII-2C Band)	5710	58.46	28.66 > 24

802.11ac (VHT80)

Channel	Channel Frequency (MHz)	Maximum Conducted Power (mW)	Maximum Conducted Power (dBm)	Power Limit (dBm)	Pass/Fail
58	5290	48.306	16.84	24.00	Pass
106	5530	24.322	13.86	24.00	Pass
122	5610	55.208	17.42	24.00	Pass
*138 (UNII-2C Band)	5690	40.611	16.09	24.00	Pass
*138 (UNII-3 Band)	5690	1.9	2.79	30.00	Pass

Note: 1. * Test was performed in accordance with Measurement follow FCC KDB 789033 UNII test procedure Method SA-2 and use spectrum analyzer test.

The Total Power for the straddle channel:

Chan.	Chan. Freq. (MHz)	Average Power (mW)	Average Power (dBm)
138	5690	42.511	16.29

Note: The total power was calculated through formula and record the value for reference only.

26dB BANDWIDTH:

Channel	Frequency (MHz)	26dBc Bandwidth (MHz)
58	5290	87.64
106	5530	85.85
122	5610	89.71
138 (UNII-2C Band)	5690	132.62

Note: For U-NII-2A, U-NII-2C Band output power limitation is determined based on 26dBc bandwidth

Power Limit = 11dBm + 10logB < U-NII-2A, U-NII-2C >			
Channel Number	Freq.(MHz)	Min. B(MHz)	Determined Conducted Limit (dBm)
58	5290	87.64	30.42 > 24
106	5530	85.85	30.33 > 24
122	5610	89.71	30.52 > 24
138 (UNII-2C Band)	5690	132.62	32.22 > 24

Spectrum Plot of Worst Value

802.11a / CH144 (UNII-2C Band)

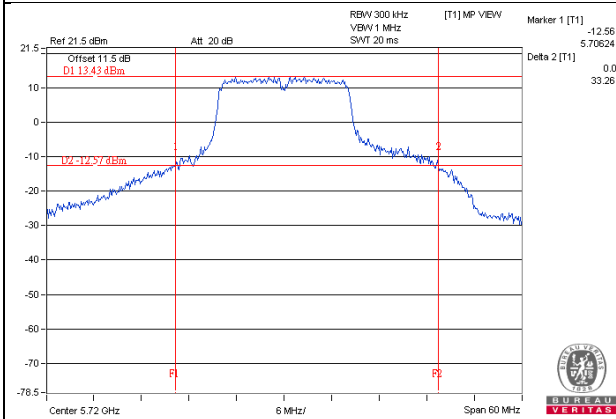

802.11ac (VHT20) / CH144 (UNII-2C Band)

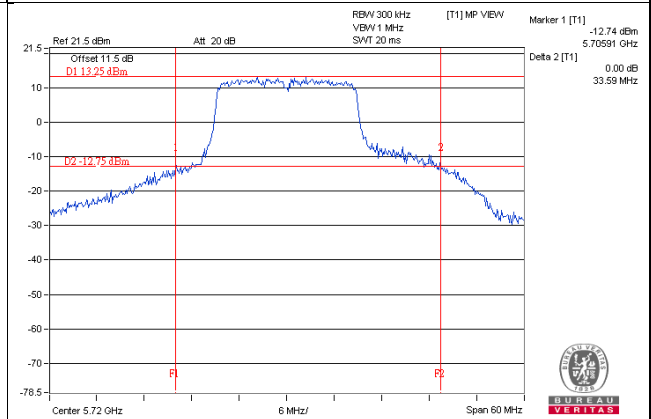

802.11ac (VHT40) / CH62

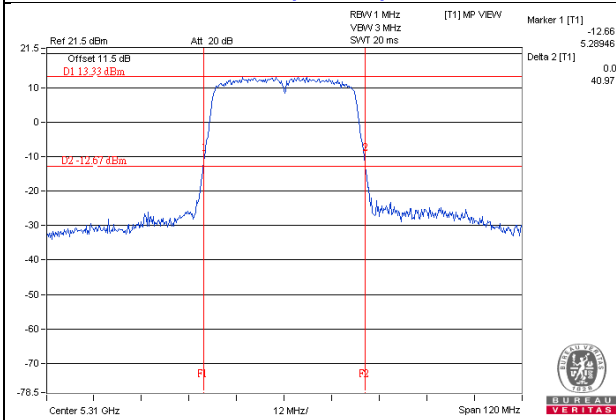

802.11ac (VHT80) / CH106

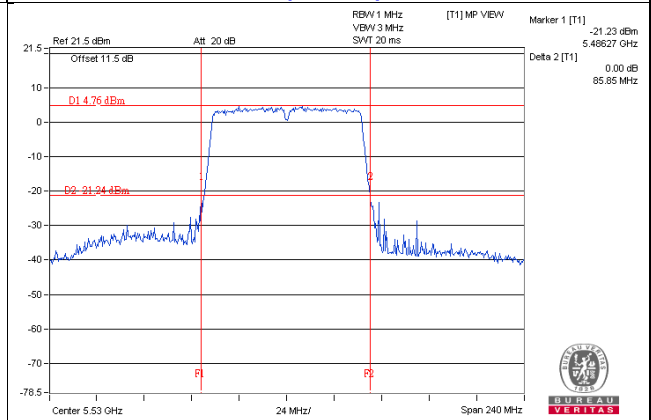

NOTE:

- For CH144 (UNII-2C Band) = 5725MHz - Marker 1
- For CH142 (UNII-2C Band) = 5725MHz - Marker 1
- For CH138 (UNII-2C Band) = 5725MHz - Marker 1

4.4 Occupied Bandwidth Measurement

4.4.1 Test Setup

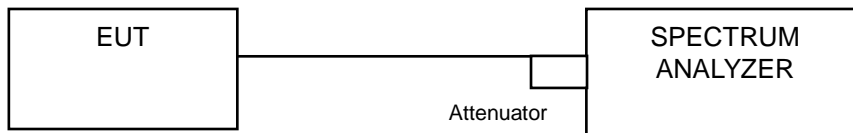

4.4.2 Test Instruments

Refer to section 4.1.2 to get information of above instrument.

4.4.3 Test Procedure

The transmitter output was connected to the spectrum analyzer through an attenuator. The bandwidth of the fundamental frequency was measured by spectrum analyzer with resolution bandwidth in the range of 1% to 5% of the anticipated emission bandwidth, and a video bandwidth at least 3x the resolution bandwidth and set the detector to SAMPLE. The width of a frequency band such that, below the lower and above the upper frequency limits, the mean powers emitted are each equal to a specified percentage 0.5 %of the total mean power of a given emission.

4.4.4 Test Results (Mode 1)

802.11a

Channel	Channel Frequency (MHz)	Occupied Bandwidth (MHz)		
		CHAIN 0	CHAIN 1	CHAIN 2
52	5260	16.56	16.56	16.44
60	5300	16.44	16.44	16.44
64	5320	16.56	16.68	16.44
100	5500	16.44	16.44	16.56
116	5580	16.56	16.56	16.44
140	5700	16.56	16.44	16.44
144 (UNII-2C Band)	5720	13.28	13.40	13.28
144 (UNII-3 Band)	5720	3.16	3.16	3.16

802.11ac (VHT20)

Channel	Channel Frequency (MHz)	Occupied Bandwidth (MHz)		
		CHAIN 0	CHAIN 1	CHAIN 2
52	5260	17.64	17.76	17.64
60	5300	17.64	17.64	17.64
64	5320	17.64	17.76	17.76
100	5500	17.64	17.64	17.64
116	5580	17.64	17.64	17.76
140	5700	17.64	17.76	17.64
144 (UNII-2C Band)	5720	14.00	13.88	13.88
144 (UNII-3 Band)	5720	3.76	3.76	3.88

802.11ac (VHT40)

Channel	Channel Frequency (MHz)	Occupied Bandwidth (MHz)		
		CHAIN 0	CHAIN 1	CHAIN 2
54	5270	36.24	36.24	36.24
62	5310	36.24	36.24	36.24
102	5510	36.24	36.24	36.48
110	5550	36.24	36.24	36.24
134	5670	36.24	36.24	36.24
142 (UNII-2C Band)	5710	33.20	33.20	33.20
142 (UNII-3 Band)	5710	3.00	3.00	3.00

802.11ac (VHT80)

Channel	Channel Frequency (MHz)	Occupied Bandwidth (MHz)		
		CHAIN 0	CHAIN 1	CHAIN 2
58	5290	75.84	76.32	76.32
106	5530	76.32	75.84	76.32
122	5610	76.32	75.84	76.32
138 (UNII-2C Band)	5690	73.40	73.40	73.88
138 (UNII-3 Band)	5690	2.92	2.92	2.92

Spectrum Plot of Worst Value

802.11a_Chain0 / CH52

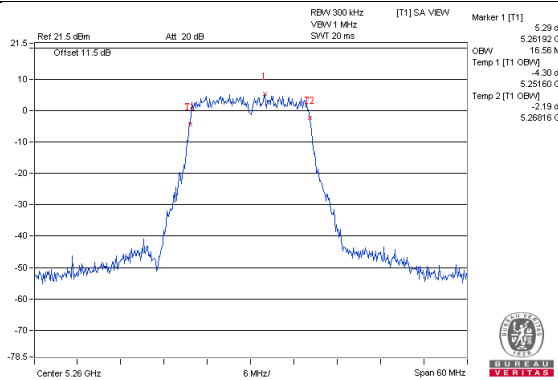

802.11a (VHT20)_Chain1 / CH52

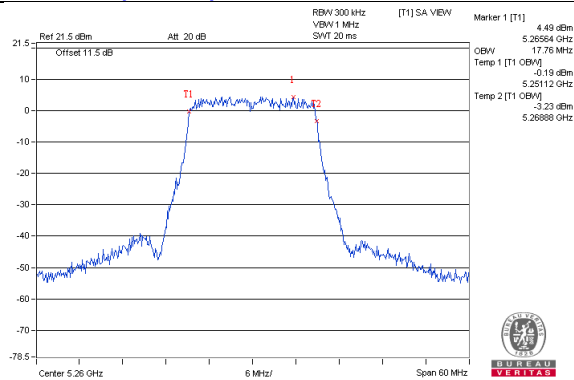

802.11ac (VHT40)_Chain2 / CH102

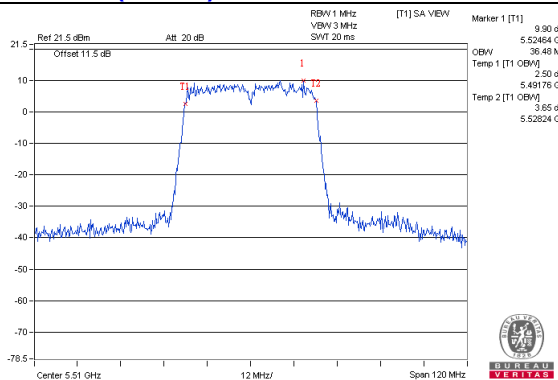

802.11ac (VHT80)_Chain1 / CH58

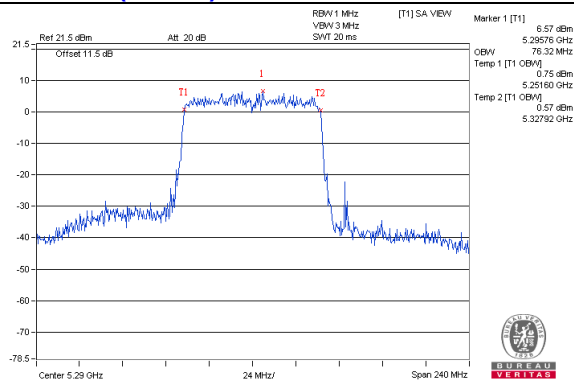

4.4.5 Test Results (Mode 2)

802.11a

Channel	Channel Frequency (MHz)	Occupied Bandwidth (MHz)	
		CHAIN 1	CHAIN 2
52	5260	16.44	16.56
60	5300	16.44	16.44
64	5320	16.44	16.56
100	5500	16.56	16.44
116	5580	16.44	16.56
140	5700	16.56	16.56
144 (UNII-2C Band)	5720	13.40	13.28
144 (UNII-3 Band)	5720	3.16	3.16

802.11ac (VHT20)

Channel	Channel Frequency (MHz)	Occupied Bandwidth (MHz)	
		CHAIN 1	CHAIN 2
52	5260	17.76	17.76
60	5300	17.64	17.64
64	5320	17.76	17.76
100	5500	17.64	17.64
116	5580	17.64	17.76
140	5700	17.64	17.64
144 (UNII-2C Band)	5720	13.88	13.88
144 (UNII-3 Band)	5720	3.76	3.76

802.11ac (VHT40)

Channel	Channel Frequency (MHz)	Occupied Bandwidth (MHz)	
		CHAIN 1	CHAIN 2
54	5270	36.24	36.72
62	5310	36.24	36.24
102	5510	36.24	36.48
110	5550	36.24	36.24
134	5670	36.24	36.24
142 (UNII-2C Band)	5710	33.40	33.60
142 (UNII-3 Band)	5710	3.60	3.80

802.11ac (VHT80)

Channel	Channel Frequency (MHz)	Occupied Bandwidth (MHz)	
		CHAIN 1	CHAIN 2
58	5290	76.32	76.32
106	5530	75.84	76.32
122	5610	75.84	76.32
138 (UNII-2C Band)	5690	73.40	73.88
138 (UNII-3 Band)	5690	2.92	2.92

Spectrum Plot of Worst Value

802.11a_Chain 2 / CH52

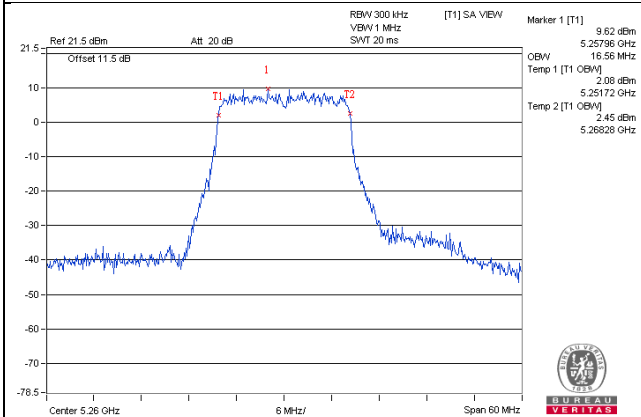

802.11ac (VHT20)_Chain 1 / CH52

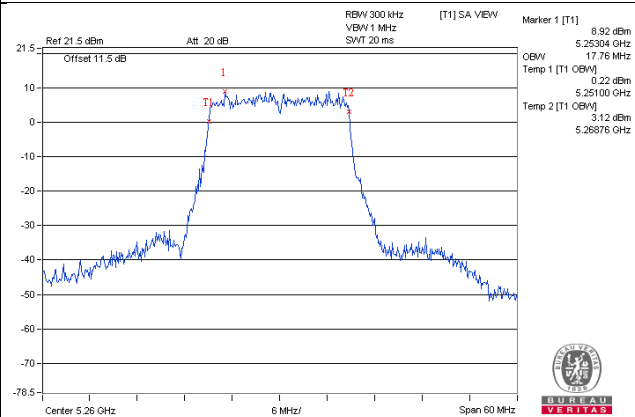

802.11ac (VHT40)_Chain 2 / CH54

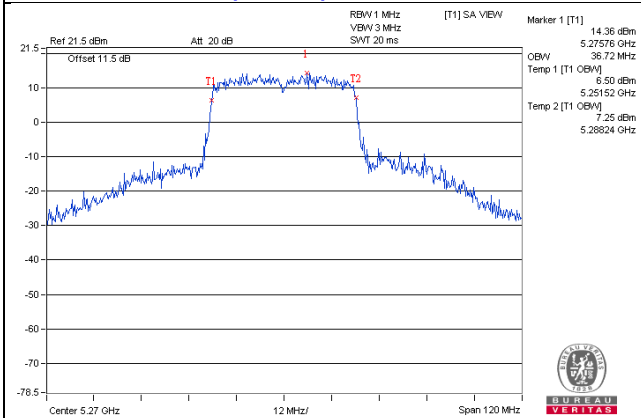

802.11ac (VHT80)_Chain 1 / CH58

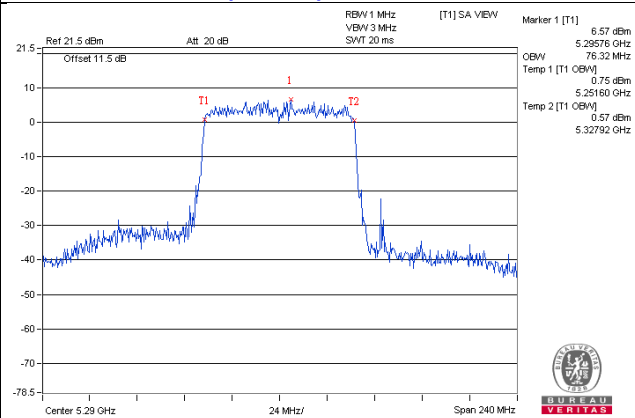

4.4.6 Test Results (Mode 3)

802.11a

Channel	Channel Frequency (MHz)	Occupied Bandwidth (MHz)
52	5260	17.28
60	5300	17.28
64	5320	16.56
100	5500	16.68
116	5580	17.16
140	5700	16.56
144 (UNII-2C Band)	5720	13.52
144 (UNII-3 Band)	5720	4.96

802.11ac (VHT20)

Channel	Channel Frequency (MHz)	Occupied Bandwidth (MHz)
52	5260	17.88
60	5300	18.24
64	5320	17.76
100	5500	17.64
116	5580	18.00
140	5700	17.64
144 (UNII-2C Band)	5720	14.00
144 (UNII-3 Band)	5720	4.36

802.11ac (VHT40)

Channel	Channel Frequency (MHz)	Occupied Bandwidth (MHz)
54	5270	36.72
62	5310	36.24
102	5510	36.48
110	5550	36.72
134	5670	36.24
142 (UNII-2C Band)	5710	33.40
142 (UNII-3 Band)	5710	4.00

802.11ac (VHT80)

Channel	Channel Frequency (MHz)	Occupied Bandwidth (MHz)
58	5290	75.84
106	5530	76.32
122	5610	75.84
138 (UNII-2C Band)	5690	73.40
138 (UNII-3 Band)	5690	2.92

Spectrum Plot of Worst Value

802.11a / CH52

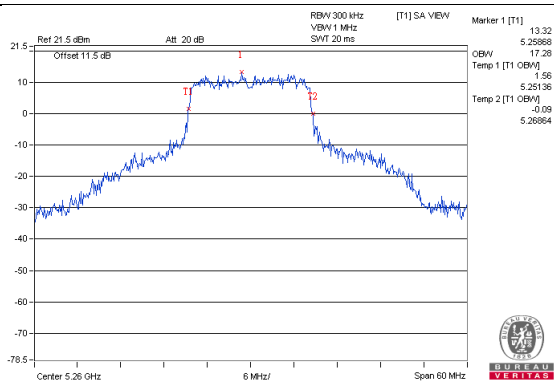

802.11ac(VHT20) / CH60

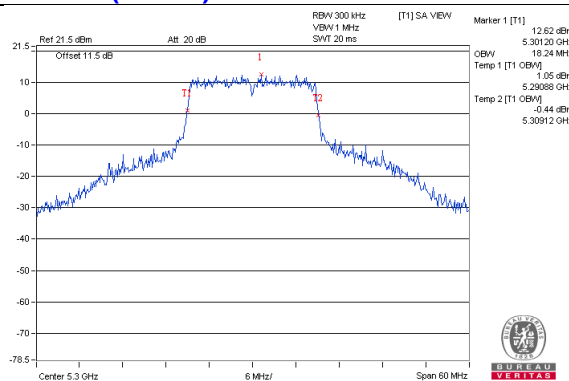

802.11ac(VHT40) / CH54

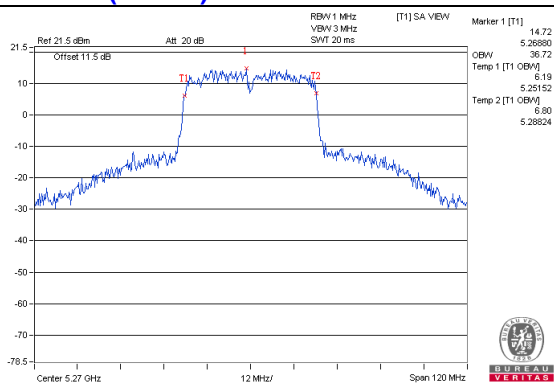

802.11ac (VHT80) / CH106

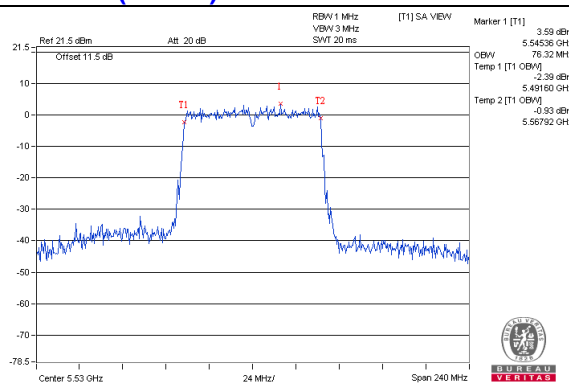

4.5 Peak Power Spectral Density Measurement

4.5.1 Limits of Peak Power Spectral Density Measurement

Operation Band	EUT Category		Limit
U-NII-1		Outdoor Access Point	17dBm/ MHz
		Fixed point-to-point Access Point	
		Indoor Access Point	
		Mobile and Portable client device	11dBm/ MHz
U-NII-2A	√		11dBm/ MHz
U-NII-2C	√		11dBm/ MHz
U-NII-3	√		30dBm/ 500kHz

4.5.2 Test Setup

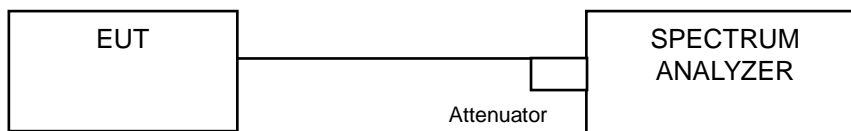

4.5.3 Test Instruments

Refer to section 4.1.2 to get information of above instrument.

4.5.4 Test Procedure

For U_NII-2A, U_NII-2C band:

802.11a, 802.11ac (VHT40), 802.11ac (VHT80)

Using method SA-2

1. Set span to encompass the entire emission bandwidth (EBW) of the signal.
2. Set RBW = 1 MHz, Set VBW \geq 3 MHz, Detector = RMS
3. Sweep time = auto, trigger set to "free run".
4. Trace average at least 100 traces in power averaging mode.
5. Record the max value and add 10 log (1/duty cycle)

802.11ac (VHT20)

Using method SA-1

1. Set span to encompass the entire emission bandwidth (EBW) of the signal.
2. Set RBW = 1 MHz, Set VBW \geq 3 MHz, Detector = RMS
3. Sweep time = auto, trigger set to "free run".
4. Trace average at least 100 traces in power averaging mode.
5. Record the max value

For U_NII-3:

802.11a, 802.11ac (VHT40), 802.11ac (VHT80)

1. Set span to encompass the entire emission bandwidth (EBW) of the signal.
2. Set RBW = 300 kHz, Set VBW \geq 1 MHz, Detector = RMS
3. Use the peak marker function to determine the maximum power level in any 300 kHz band segment within the fundamental EBW.
4. Scale the observed power level to an equivalent value in 500 kHz by adjusting (reducing) the measured power by a bandwidth correction factor (BWCF) where $BWCF = 10\log(500\text{ kHz}/300\text{ kHz})$
5. Sweep time = auto, trigger set to "free run".
6. Trace average at least 100 traces in power averaging mode.
7. Record the max value and add 10 log (1/duty cycle)

802.11ac (VHT20)

1. Set span to encompass the entire emission bandwidth (EBW) of the signal.
2. Set RBW = 300 kHz, Set VBW \geq 1 MHz, Detector = RMS
3. Use the peak marker function to determine the maximum power level in any 300 kHz band segment within the fundamental EBW.
4. Scale the observed power level to an equivalent value in 500 kHz by adjusting (reducing) the measured power by a bandwidth correction factor (BWCF) where $BWCF = 10\log(500\text{ kHz}/300\text{ kHz})$
5. Sweep time = auto, trigger set to "free run".
6. Trace average at least 100 traces in power averaging mode.
7. Record the max value

4.5.5 Deviation from Test Standard

No deviation.

4.5.6 EUT Operating Condition

Same as Item 4.3.6.

4.5.7 Test Results (Mode 1)

802.11a

For UNII-2A, UNII-2C:

Chan.	Chan. Freq. (MHz)	PSD W/O Duty Factor (dBm/MHz)			Duty Factor (dB)	Total PSD With Duty Factor (dBm/MHz)	MAX. Limit (dBm/MHz)	Pass / Fail
		Chain 0	Chain 1	Chain 2				
52	5260	1.01	1.35	1.61	0.14	6.24	6.50	Pass
60	5300	0.92	0.76	1.65	0.14	6.04	6.50	Pass
64	5320	1.00	1.25	1.76	0.14	6.26	6.50	Pass
100	5500	1.46	1.14	1.73	0.14	6.36	6.50	Pass
116	5580	1.20	1.26	1.72	0.14	6.31	6.50	Pass
140	5700	0.90	1.16	1.49	0.14	6.10	6.50	Pass
144 (UNII-2C Band)	5720	1.02	1.08	1.58	0.14	6.15	6.50	Pass

- Note:**
- Method a) of power density measurement of KDB 662911 is using for calculating total power density. Total power density is summing entire spectra across corresponding frequency bins on the various outputs by computer.
 - Directional gain = $10 \log[(10^{G1/20} + 10^{G2/20} + 10^{G3/20})^2 / 3] = 10.5\text{dBi} > 6\text{dBi}$, so the power density limit shall be reduced to $11 - (10.5 - 6) = 6.5\text{dBm}$.
 - Refer to section 3.3 for duty cycle spectrum plot.

For U_NII-3

TX chain	Chan.	Chan. Freq. (MHz)	PSD W/O Duty Factor		10 log (N=3) dB	Duty Factor (dB)	Total PSD With Duty Factor (dBm/500kHz)	Limit (dBm/500kHz)	Pass /Fail
			(dBm/300kHz)	(dBm/500kHz)					
0	144 (UNII-3 Band)	5720	-7.28	-5.06	4.77	0.14	-0.15	25.50	Pass
1	144 (UNII-3 Band)	5720	-7.35	-5.13	4.77	0.14	-0.22	25.50	Pass
2	144 (UNII-3 Band)	5720	-6.93	-4.71	4.77	0.14	0.20	25.50	Pass

- Note:**
- Directional gain = $10 \log[(10^{G1/20} + 10^{G2/20} + 10^{G3/20})^2 / 3] = 10.5\text{dBi} > 6\text{dBi}$, so the power density limit shall be reduced to $30 - (10.5 - 6) = 25.50\text{dBm}$.
 - Refer to section 3.3 for duty cycle spectrum plot.

802.11ac (VHT20)

For UNII-2A, UNII-2C:

Chan.	Chan. Freq. (MHz)	PSD (dBm/MHz)			Total Power Density (dBm/MHz)	MAX. Limit (dBm/MHz)	Pass / Fail
		Chain 0	Chain 1	Chain 2			
52	5260	0.84	0.72	1.61	5.85	6.50	Pass
60	5300	0.95	0.62	1.58	5.84	6.50	Pass
64	5320	1.10	0.76	1.77	6.00	6.50	Pass
100	5500	1.47	1.04	1.78	6.21	6.50	Pass
116	5580	1.84	1.26	1.82	6.42	6.50	Pass
140	5700	1.31	1.28	1.47	6.13	6.50	Pass
144 (UNII-2C Band)	5720	1.07	1.19	1.64	6.08	6.50	Pass

- Note:** 1. Method a) of power density measurement of KDB 662911 is using for calculating total power density. Total power density is summing entire spectra across corresponding frequency bins on the various outputs by computer.
2. Directional gain = $10 \log[(10^{G1/20} + 10^{G2/20} + 10^{G3/20})^2 / 3] = 10.5\text{dBi} > 6\text{dBi}$, so the power density limit shall be reduced to $11 - (10.5 - 6) = 6.5\text{dBm}$.

For U_NII-3

TX chain	Chan.	Chan. Freq. (MHz)	PSD		10 log (N=3) dB	Total PSD (dBm/500kHz)	Limit (dBm/500kHz)	Pass /Fail
			(dBm/300kHz)	(dBm/500kHz)				
0	144 (UNII-3 Band)	5720	-6.81	-4.59	4.77	0.18	25.50	Pass
1	144 (UNII-3 Band)	5720	-7.02	-4.80	4.77	-0.03	25.50	Pass
2	144 (UNII-3 Band)	5720	-6.82	-4.60	4.77	0.17	25.50	Pass

- Note:** 1. Directional gain = $10 \log[(10^{G1/20} + 10^{G2/20} + 10^{G3/20})^2 / 3] = 10.5\text{dBi} > 6\text{dBi}$, so the power density limit shall be reduced to $30 - (10.5 - 6) = 25.5\text{dBm}$.

802.11ac (VHT40)

For UNII-2A, UNII-2C:

Chan.	Chan. Freq. (MHz)	PSD W/O Duty Factor (dBm/MHz)			Duty Factor (dB)	Total PSD With Duty Factor (dBm/MHz)	MAX. Limit (dBm/MHz)	Pass / Fail
		Chain 0	Chain 1	Chain 2				
54	5270	1.24	1.23	1.37	0.13	6.19	6.50	Pass
62	5310	1.64	1.07	1.56	0.13	6.34	6.50	Pass
102	5510	0.31	-0.12	0.11	0.13	5.01	6.50	Pass
110	5550	1.03	1.29	1.83	0.13	6.30	6.50	Pass
134	5670	0.54	1.22	1.42	0.13	5.98	6.50	Pass
142 (UNII-2C Band)	5710	0.69	0.73	1.31	0.13	5.83	6.50	Pass

- Note:**
- Method a) of power density measurement of KDB 662911 is using for calculating total power density. Total power density is summing entire spectra across corresponding frequency bins on the various outputs by computer.
 - Directional gain = $10 \log[(10^{G1/20} + 10^{G2/20} + 10^{G3/20})^2 / 3] = 10.5\text{dBi} > 6\text{dBi}$, so the power density limit shall be reduced to $11 - (10.5 - 6) = 6.5\text{dBm}$.
 - Refer to section 3.3 for duty cycle spectrum plot.

For U_NII-3

TX chain	Chan.	Chan. Freq. (MHz)	PSD W/O Duty Factor		10 log (N=3) dB	Duty Factor (dB)	Total PSD With Duty Factor (dBm/500kHz)	Limit (dBm/500kHz)	Pass /Fail
			(dBm/300kHz)	(dBm/500kHz)					
0	142 (UNII-3 Band)	5710	-8.82	-6.60	4.77	0.13	-1.70	25.50	Pass
1	142 (UNII-3 Band)	5710	-8.90	-6.68	4.77	0.13	-1.78	25.50	Pass
2	142 (UNII-3 Band)	5710	-8.34	-6.12	4.77	0.13	-1.22	25.50	Pass

- Note:**
- Directional gain = $10 \log[(10^{G1/20} + 10^{G2/20} + 10^{G3/20})^2 / 3] = 10.5\text{dBi} > 6\text{dBi}$, so the power density limit shall be reduced to $30 - (10.5 - 6) = 25.5\text{dBm}$.
 - Refer to section 3.3 for duty cycle spectrum plot.

802.11ac (VHT80)

For UNII-2A, UNII-2C:

Chan.	Chan. Freq. (MHz)	PSD W/O Duty Factor (dBm/MHz)			Duty Factor (dB)	Total PSD With Duty Factor (dBm/MHz)	MAX. Limit (dBm/MHz)	Pass / Fail
		Chain 0	Chain 1	Chain 2				
58	5290	-4.11	-3.76	-3.93	0.24	1.08	6.50	Pass
106	5530	-6.46	-7.89	-7.07	0.24	-2.09	6.50	Pass
122	5610	-3.45	-4.52	-2.91	0.24	1.43	6.50	Pass
138 (UNII-2C Band)	5690	-1.97	-2.02	-0.76	0.24	3.46	6.50	Pass

- Note:**
- Method a) of power density measurement of KDB 662911 is using for calculating total power density. Total power density is summing entire spectra across corresponding frequency bins on the various outputs by computer.
 - Directional gain = $10 \log[(10^{G1/20} + 10^{G2/20} + 10^{G3/20})^2 / 3] = 10.5\text{dBi} > 6\text{dBi}$, so the power density limit shall be reduced to $11-(10.5-6) = 6.5\text{dBm}$.
 - Refer to section 3.3 for duty cycle spectrum plot.

For U_NII-3

TX chain	Chan.	Chan. Freq. (MHz)	PSD W/O Duty Factor		10 log (N=3) dB	Duty Factor (dB)	Total PSD With Duty Factor (dBm/500kHz)	Limit (dBm/500kHz)	Pass /Fail
			(dBm/300kHz)	(dBm/500kHz)					
0	138 (UNII-3 Band)	5690	-11.39	-9.17	4.77	0.24	-4.16	25.50	Pass
1	138 (UNII-3 Band)	5690	-11.34	-9.12	4.77	0.24	-4.11	25.50	Pass
2	138 (UNII-3 Band)	5690	-10.18	-7.96	4.77	0.24	-2.95	25.50	Pass

- Note:**
- Directional gain = $10 \log[(10^{G1/20} + 10^{G2/20} + 10^{G3/20})^2 / 3] = 10.5\text{dBi} > 6\text{dBi}$, so the power density limit shall be reduced to $30-(10.5-6) = 25.50\text{dBm}$.
 - Refer to section 3.3 for duty cycle spectrum plot.

For UNII-2A, UNII-2C

Spectrum Plot of Worst Value

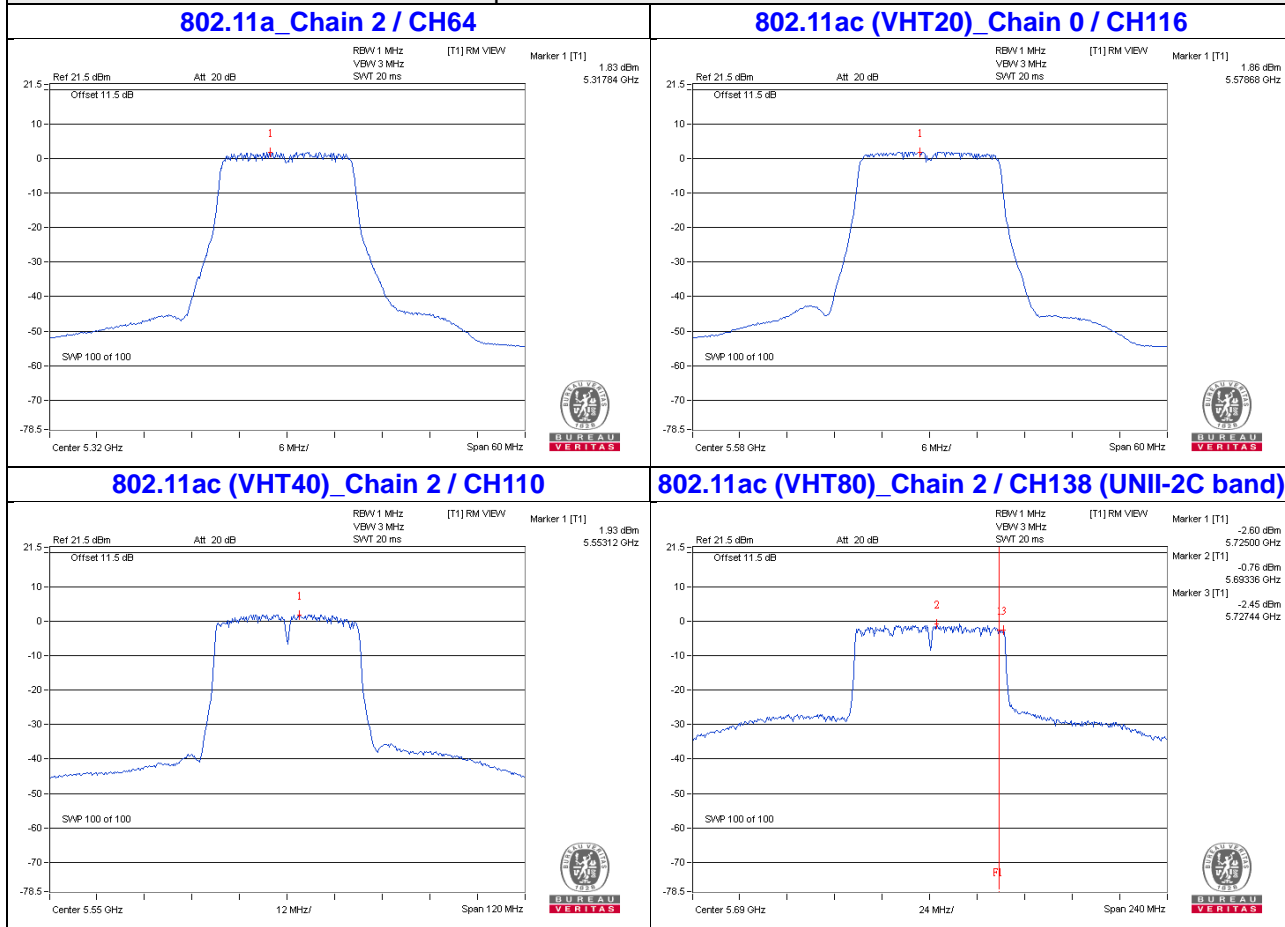

For UNII-3:

Spectrum Plot of Worst Value

802.11a / Chain 2 – CH144(UNII-3 Band)

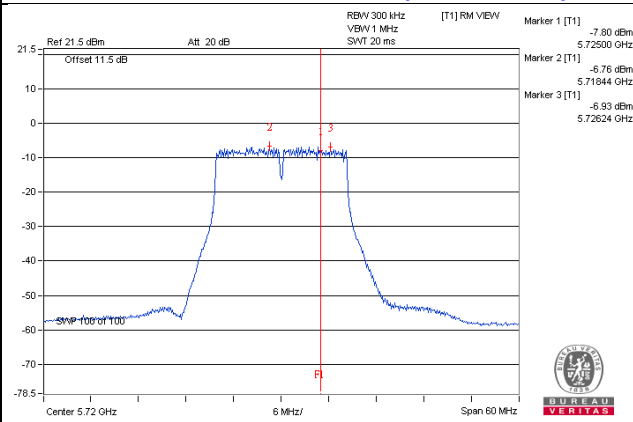

802.11ac (VHT20) / Chain 0 – CH144 (UNII-3 Band)

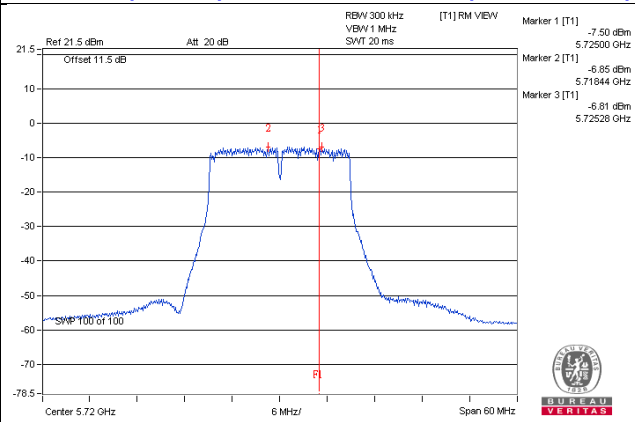

802.11ac (VHT40) / Chain 2– CH142(UNII-3 Band)

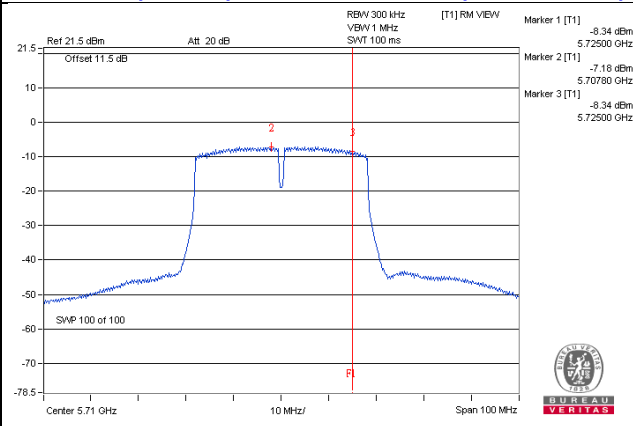

802.11ac (VHT80) / Chain 2 – CH138(UNII-3 Band)

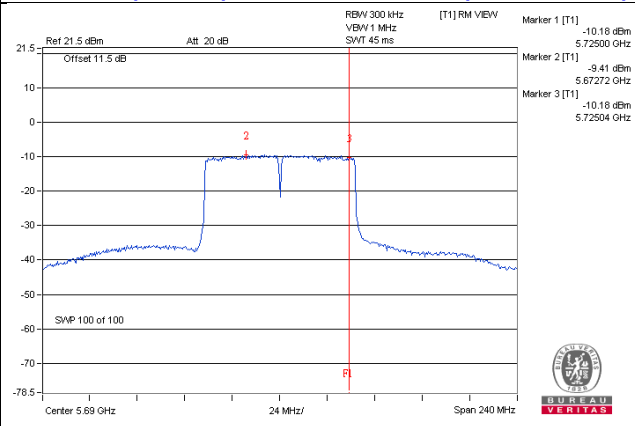

4.5.8 Test Results (Mode 2)

802.11a

For UNII-2A, UNII-2C:

Chan.	Chan. Freq. (MHz)	PSD W/O Duty Factor (dBm/MHz)		Duty Factor (dB)	Total PSD With Duty Factor (dBm/MHz)	MAX. Limit (dBm/MHz)	Pass / Fail
		Chain 1	Chain 2				
52	5260	4.46	5.14	0.14	7.96	8.15	Pass
60	5300	4.38	5.21	0.14	7.97	8.15	Pass
64	5320	4.42	5.43	0.14	8.11	8.15	Pass
100	5500	4.27	4.66	0.14	7.62	8.15	Pass
116	5580	4.33	4.68	0.14	7.66	8.15	Pass
140	5700	4.22	4.75	0.14	7.64	8.15	Pass
144 (UNII-2C Band)	5720	4.41	4.88	0.14	7.80	8.15	Pass

- Note:**
- Method a) of power density measurement of KDB 662911 is using for calculating total power density. Total power density is summing entire spectra across corresponding frequency bins on the various outputs by computer.
 - Directional gain = $10 \log[(10^{G2/20} + 10^{G3/20})^2 / 2] = 8.85\text{dBi} > 6\text{dBi}$, so the power density limit shall be reduced to $11 - (8.85 - 6) = 8.15\text{dBm}$.
 - Refer to section 3.3 for duty cycle spectrum plot.

For U_NII-3

TX chain	Chan.	Chan. Freq. (MHz)	PSD W/O Duty Factor		10 log (N=2) dB	Duty Factor (dB)	Total PSD With Duty Factor (dBm/500kHz)	Limit (dBm/500kHz)	Pass /Fail
			(dBm/300kHz)	(dBm/500kHz)					
1	144 (UNII-3 Band)	5720	-4.47	-2.25	3.01	0.14	0.90	27.15	Pass
2	144 (UNII-3 Band)	5720	-3.51	-1.29	3.01	0.14	1.86	27.15	Pass

- Note:**
- Directional gain = $10 \log[(10^{G2/20} + 10^{G3/20})^2 / 2] = 8.85\text{dBi} > 6\text{dBi}$, so the power density limit shall be reduced to $30 - (8.85 - 6) = 27.15\text{dBm}$.
 - Refer to section 3.3 for duty cycle spectrum plot.

802.11ac (VHT20)

For UNII-2A, UNII-2C:

Chan.	Chan. Freq. (MHz)	PSD (dBm/MHz)		Total Power Density (dBm/MHz)	MAX. Limit (dBm/MHz)	Pass / Fail
		Chain 1	Chain 2			
52	5260	4.39	4.77	7.59	8.15	Pass
60	5300	4.40	4.92	7.68	8.15	Pass
64	5320	4.42	4.86	7.66	8.15	Pass
100	5500	4.82	4.79	7.82	8.15	Pass
116	5580	4.97	5.02	8.01	8.15	Pass
140	5700	4.43	4.88	7.67	8.15	Pass
144 (UNII-2C Band)	5720	4.36	4.86	7.63	8.15	Pass

- Note:** 1. Method a) of power density measurement of KDB 662911 is using for calculating total power density. Total power density is summing entire spectra across corresponding frequency bins on the various outputs by computer.
2. Directional gain = $10 \log[(10^{G2/20} + 10^{G3/20})^2 / 2] = 8.85\text{dBi} > 6\text{dBi}$, so the power density limit shall be reduced to $11 - (8.85 - 6) = 8.15\text{dBm}$.

For U_NII-3

TX chain	Chan.	Chan. Freq. (MHz)	PSD		10 log (N=2) dB	Total PSD (dBm/500kHz)	Limit (dBm/500kHz)	Pass /Fail
			(dBm/300kHz)	(dBm/500kHz)				
1	144 (UNII-3 Band)	5720	-4.13	-1.91	3.01	1.10	27.15	Pass
2	144 (UNII-3 Band)	5720	-3.82	-1.60	3.01	1.41	27.15	Pass

- Note:** 1. Directional gain = $10 \log[(10^{G2/20} + 10^{G3/20})^2 / 2] = 8.85\text{dBi} > 6\text{dBi}$, so the power density limit shall be reduced to $30 - (8.85 - 6) = 27.15\text{dBm}$.

802.11ac (VHT40)

For UNII-2A, UNII-2C:

Chan.	Chan. Freq. (MHz)	PSD W/O Duty Factor (dBm/MHz)		Duty Factor (dB)	Total PSD With Duty Factor (dBm/MHz)	MAX. Limit (dBm/MHz)	Pass / Fail
		Chain 1	Chain 2				
54	5270	4.85	4.55	0.13	7.85	8.15	Pass
62	5310	1.67	2.48	0.13	5.24	8.15	Pass
102	5510	-0.12	0.11	0.13	3.14	8.15	Pass
110	5550	3.55	3.70	0.13	6.77	8.15	Pass
134	5670	1.82	2.47	0.13	5.30	8.15	Pass
142 (UNII-2C Band)	5710	3.32	3.37	0.13	6.49	8.15	Pass

- Note:**
- Method a) of power density measurement of KDB 662911 is using for calculating total power density. Total power density is summing entire spectra across corresponding frequency bins on the various outputs by computer.
 - Directional gain = $10 \log[(10^{G2/20} + 10^{G3/20})^2 / 2] = 8.85\text{dBi} > 6\text{dBi}$, so the power density limit shall be reduced to $11 - (8.85 - 6) = 8.15\text{dBm}$.
 - Refer to section 3.3 for duty cycle spectrum plot.

For U_NII-3

TX chain	Chan.	Chan. Freq. (MHz)	PSD W/O Duty Factor		10 log (N=2) dB	Duty Factor (dB)	Total PSD With Duty Factor (dBm/500kHz)	Limit (dBm/500kHz)	Pass /Fail
			(dBm/300kHz)	(dBm/500kHz)					
1	142 (UNII-3 Band)	5710	-6.51	-4.29	3.01	0.13	-1.15	27.15	Pass
2	142 (UNII-3 Band)	5710	-6.47	-4.25	3.01	0.13	-1.11	27.15	Pass

- Note:**
- Directional gain = $10 \log[(10^{G2/20} + 10^{G3/20})^2 / 2] = 8.85\text{dBi} > 6\text{dBi}$, so the power density limit shall be reduced to $30 - (8.85 - 6) = 27.15\text{dBm}$.
 - Refer to section 3.3 for duty cycle spectrum plot.

802.11ac (VHT80)

For UNII-2A, UNII-2C:

Chan.	Chan. Freq. (MHz)	PSD W/O Duty Factor (dBm/MHz)		Duty Factor (dB)	Total PSD With Duty Factor (dBm/MHz)	MAX. Limit (dBm/MHz)	Pass / Fail
		Chain 1	Chain 2				
58	5290	-3.76	-3.93	0.24	-0.60	8.15	Pass
106	5530	-7.81	-6.81	0.24	-4.04	8.15	Pass
122	5610	-4.52	-2.91	0.24	-0.39	8.15	Pass
138 (UNII-2C Band)	5690	-2.02	-0.76	0.24	1.90	8.15	Pass

- Note:**
- Method a) of power density measurement of KDB 662911 is using for calculating total power density. Total power density is summing entire spectra across corresponding frequency bins on the various outputs by computer.
 - Directional gain = $10 \log[(10^{G2/20} + 10^{G3/20})^2 / 2] = 8.85\text{dBi} > 6\text{dBi}$, so the power density limit shall be reduced to $11 - (8.85 - 6) = 8.15\text{dBm}$.
 - Refer to section 3.3 for duty cycle spectrum plot.

For U_NII-3

TX chain	Chan.	Chan. Freq. (MHz)	PSD W/O Duty Factor		10 log (N=2) dB	Duty Factor (dB)	Total PSD With Duty Factor (dBm/500kHz)	Limit (dBm/500kHz)	Pass /Fail
			(dBm/300kHz)	(dBm/500kHz)					
1	138 (UNII-3 Band)	5690	-11.34	-9.12	3.01	0.24	-5.87	27.15	Pass
2	138 (UNII-3 Band)	5690	-10.18	-7.96	3.01	0.24	-4.71	27.15	Pass

- Note:**
- Directional gain = $10 \log[(10^{G2/20} + 10^{G3/20})^2 / 2] = 8.85\text{dBi} > 6\text{dBi}$, so the power density limit shall be reduced to $30 - (8.85 - 6) = 27.15\text{dBm}$.
 - Refer to section 3.3 for duty cycle spectrum plot.

For UNII-2A, UNII-2C

Spectrum Plot of Worst Value

802.11a_Chain 2 / CH64

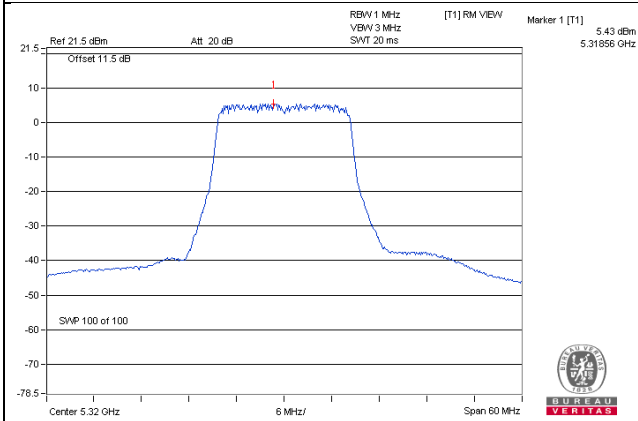

802.11ac (VHT20)_Chain 2 / CH116

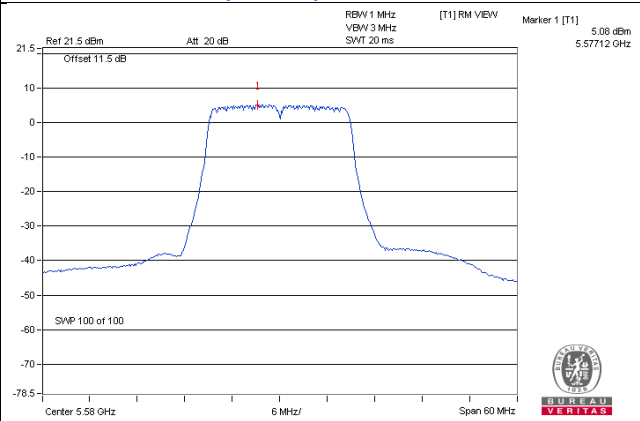

802.11ac (VHT40)_Chain 1 / CH54

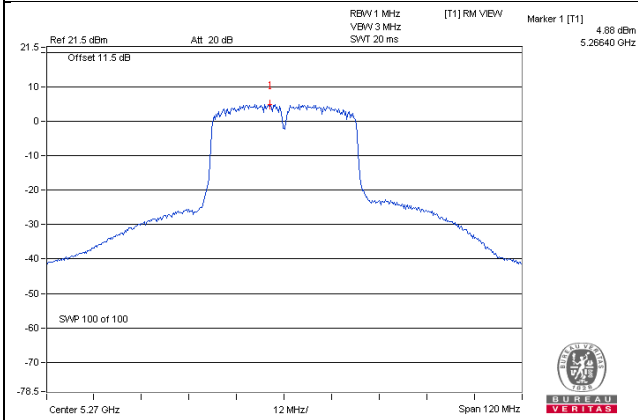

802.11ac (VHT80)_Chain 2 / CH138 (UNII-2C band)

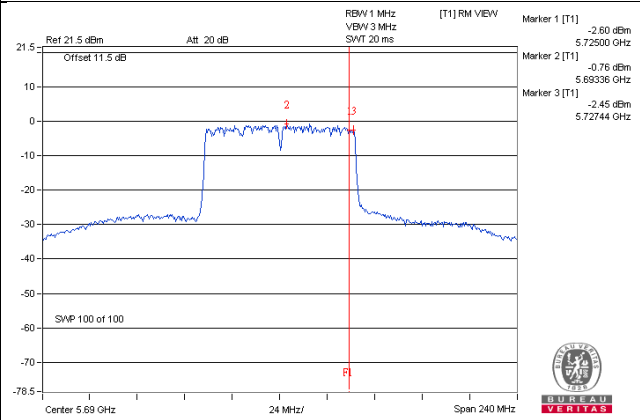

For UNII-3:

Spectrum Plot of Worst Value

802.11a / Chain 2 – CH144(UNII-3 Band)

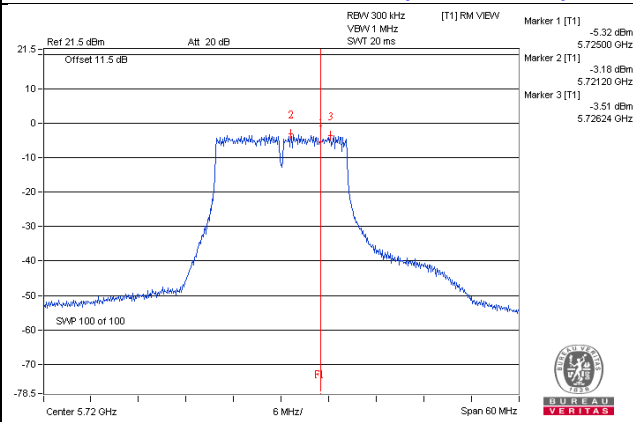

802.11ac (VHT20) / Chain 2 – CH144 (UNII-3 Band)

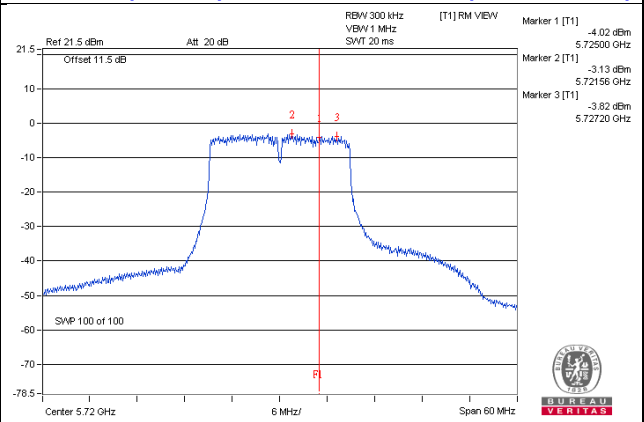

802.11ac (VHT40) / Chain 2 – CH142(UNII-3 Band)

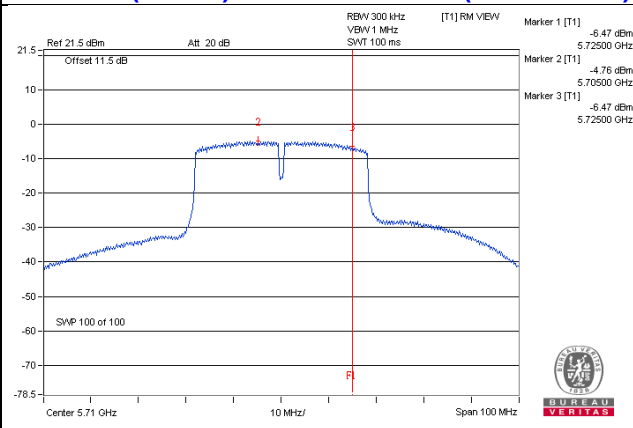

802.11ac (VHT80) / Chain 2 – CH138(UNII-3 Band)

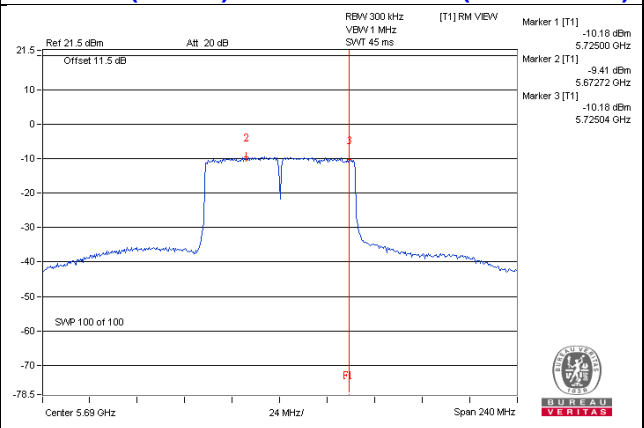

4.5.9 Test Results (Mode 3)

802.11a

For UNII-2A, UNII-2C

Chan.	Chan. Freq. (MHz)	PSD W/O Duty Factor (dBm/MHz)	Duty Factor (dB)	PSD With Duty Factor (dBm/MHz)	MAX. Limit (dBm/MHz)	Pass / Fail
52	5260	8.45	0.14	8.59	11.00	Pass
60	5300	8.59	0.14	8.73	11.00	Pass
64	5320	6.43	0.14	6.57	11.00	Pass
100	5500	5.37	0.14	5.51	11.00	Pass
116	5580	8.33	0.14	8.47	11.00	Pass
140	5700	5.29	0.14	5.43	11.00	Pass
144 (UNII-2C Band)	5720	7.67	0.14	7.81	11.00	Pass

Note: 1. Refer to section 3.3 for duty cycle spectrum plot.

For UNII-3

Chan.	Chan. Freq. (MHz)	PSD W/O Duty Factor		Duty Factor (dB)	Total PSD With Duty Factor (dBm/500kHz)	Limit (dBm/500kHz)	Pass /Fail
		(dBm/300kHz)	(dBm/500kHz)				
144 (U-NII-3 Band)	5720	-1.27	0.95	0.14	1.09	30.00	Pass

Note: 1. Refer to section 3.3 for duty cycle spectrum plot.

802.11ac (VHT20)
For UNII-2A, UNII-2C

Chan.	Chan. Freq. (MHz)	PSD (dBm/MHz)	MAX. Limit (dBm/MHz)	Pass / Fail
52	5260	8.07	11.00	Pass
60	5300	8.15	11.00	Pass
64	5320	5.92	11.00	Pass
100	5500	4.85	11.00	Pass
116	5580	7.89	11.00	Pass
140	5700	3.73	11.00	Pass
144 (UNII-2C Band)	5720	7.34	11.00	Pass

For UNII-3

Chan.	Chan. Freq. (MHz)	PSD (dBm/300kHz)	PSD (dBm/500kHz)	Limit (dBm/500kHz)	Pass /Fail
144 (U-NII-3 Band)	5720	-1.04	1.18	30.00	Pass

802.11ac (VHT40)
For UNII-2A, UNII-2C

Chan.	Chan. Freq. (MHz)	PSD W/O Duty Factor (dBm/MHz)	Duty Factor (dB)	PSD With Duty Factor (dBm/MHz)	MAX. Limit (dBm/MHz)	Pass / Fail
54	5270	4.63	0.13	4.76	11.00	Pass
62	5310	1.70	0.13	1.83	11.00	Pass
102	5510	1.70	0.13	1.83	11.00	Pass
110	5550	4.52	0.13	4.65	11.00	Pass
134	5670	2.50	0.13	2.63	11.00	Pass
142 (UNII-2C Band)	5710	4.88	0.13	5.01	11.00	Pass

Note: 1. Refer to section 3.3 for duty cycle spectrum plot.

For UNII-3

Chan.	Chan. Freq. (MHz)	PSD W/O Duty Factor		Duty Factor (dB)	Total PSD With Duty Factor (dBm/500kHz)	Limit (dBm/500kHz)	Pass /Fail
		(dBm/300kHz)	(dBm/500kHz)				
142 (U-NII-3 Band)	5710	-4.79	-2.57	0.13	-2.44	30.00	Pass

802.11ac (VHT80)
For UNII-2A, UNII-2C

Chan.	Chan. Freq. (MHz)	PSD W/O Duty Factor (dBm/MHz)	Duty Factor (dB)	PSD With Duty Factor (dBm/MHz)	MAX. Limit (dBm/MHz)	Pass / Fail
58	5290	-3.51	0.24	-3.27	11.00	Pass
106	5530	-6.60	0.24	-6.36	11.00	Pass
122	5610	-3.15	0.24	-2.91	11.00	Pass
138 (UNII-2C Band)	5690	-0.64	0.24	-0.40	11.00	Pass

Note: 1. Refer to section 3.3 for duty cycle spectrum plot.

For UNII-3

Chan.	Chan. Freq. (MHz)	PSD W/O Duty Factor		Duty Factor (dB)	Total PSD With Duty Factor (dBm/500kHz)	Limit (dBm/500kHz)	Pass /Fail
		(dBm/300kHz)	(dBm/500kHz)				
138 (U-NII-3 Band)	5690	-10.15	-7.93	0.24	-7.69	30.00	Pass

For UNII-2A, UNII-2C

Spectrum Plot of Worst Value

802.11a / CH60

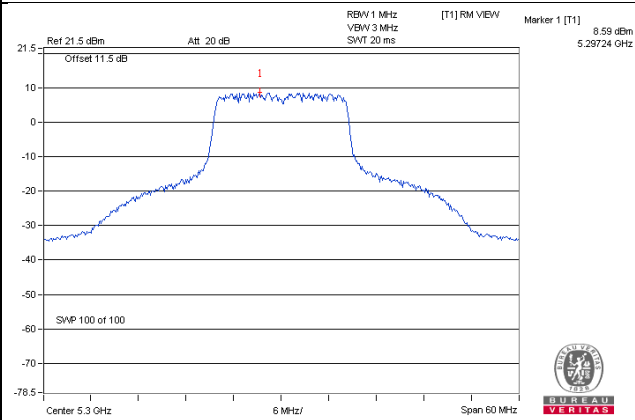

802.11ac (VHT20) / CH60

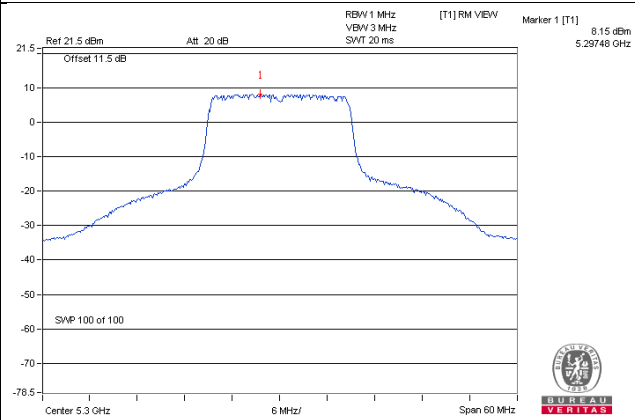

802.11ac (VHT40) / CH54

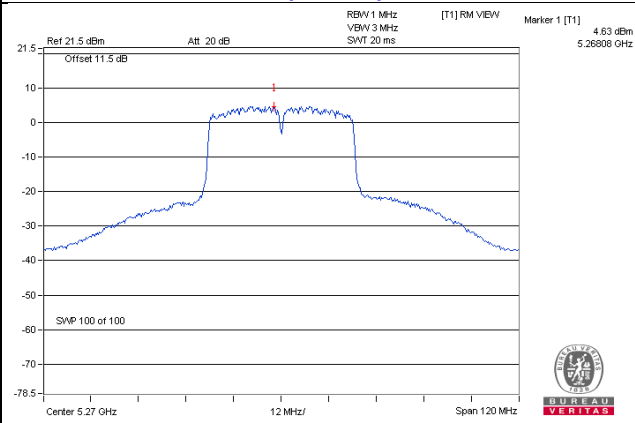

802.11ac (VHT80) / CH138 (UNII-2C band)

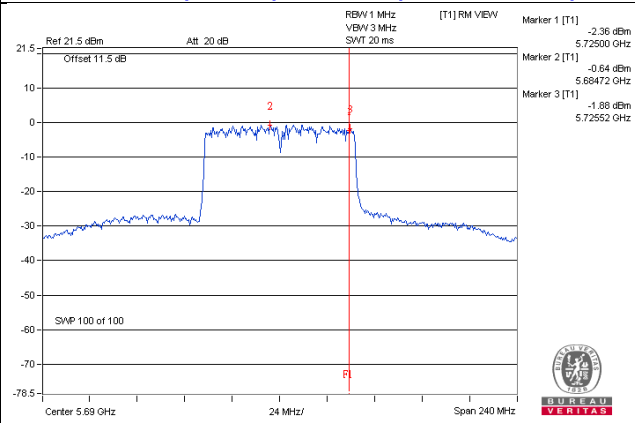

For UNII-3

Spectrum Plot of Worst Value

802.11a: CH 144 (UNII-3)

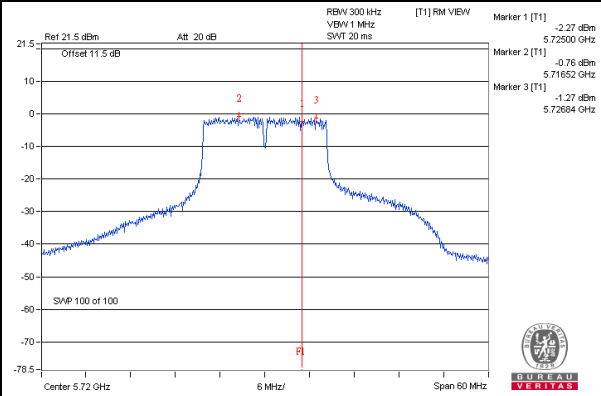

802.11ac (VHT20): CH 144 (UNII-3)

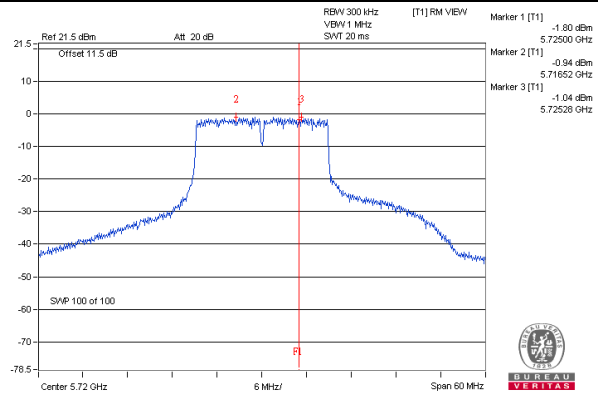

802.11ac (VHT40): CH 142 (UNII-3)

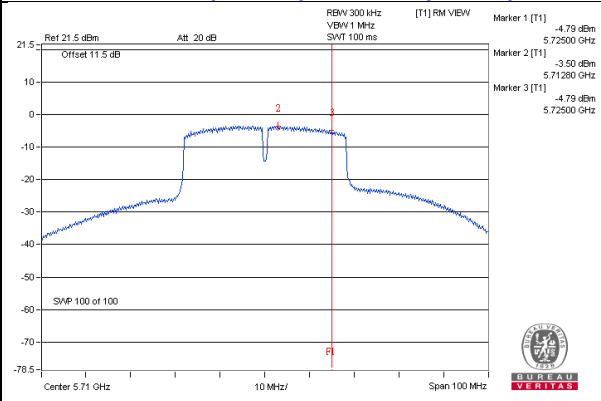

802.11ac (VHT80): CH 138 (UNII-3)

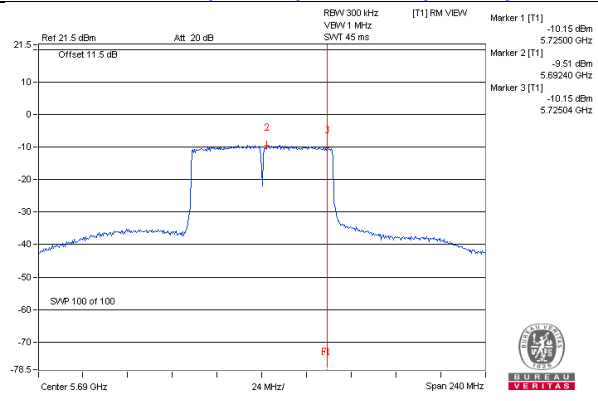

4.6 Frequency Stability Measurement

4.6.1 Limits of Frequency Stability Measurement

The frequency of the carrier signal shall be maintained within band of operation

4.6.2 Test Setup

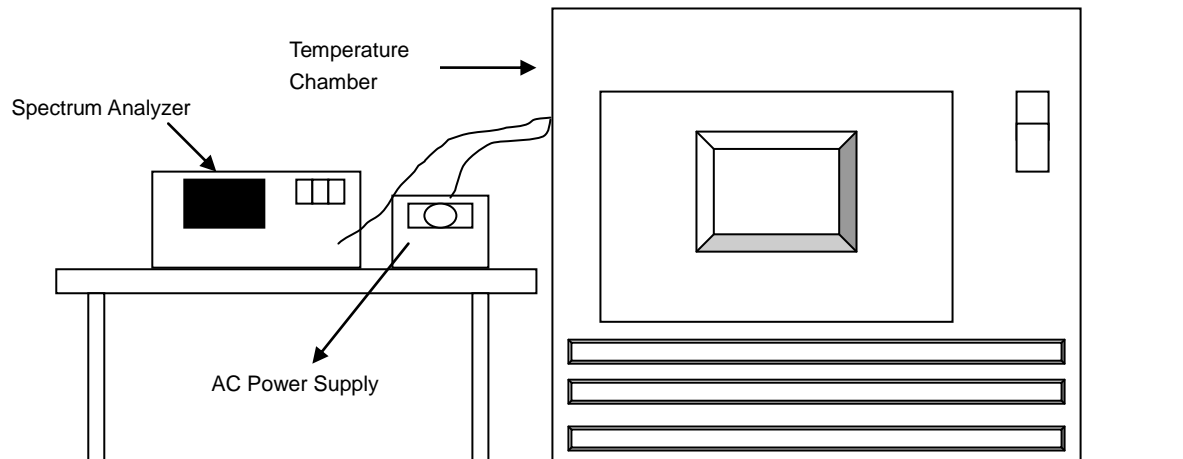

4.6.3 Test Instruments

Refer to section 4.1.2 to get information of above instrument.

4.6.4 Test Procedure

- The EUT was placed inside the environmental test chamber and powered by nominal AC voltage.
- Turn the EUT on and couple its output to a spectrum analyzer.
- Turn the EUT off and set the chamber to the highest temperature specified.
- Allow sufficient time (approximately 30 min) for the temperature of the chamber to stabilize, turn the EUT on and measure the operating frequency after 2, 5, and 10 Minutes.
- Repeat step 2 and 3 with the temperature chamber set to the lowest temperature.
- The test chamber was allowed to stabilize at +20 degree C for a minimum of 30 Minutes. The supply voltage was then adjusted on the EUT from 85% to 115% and the frequency record.

4.6.5 Deviation from Test Standard

No deviation.

4.6.6 EUT Operating Condition

Set the EUT transmit at un-modulation mode to test frequency stability.

4.6.7 Test Results

Frequency Stability Versus Temp.									
Operating Frequency: 5260 MHz									
TEMP. (°C)	Power Supply (Vac)	0 Minute		2 Minute		5 Minute		10 Minute	
		Measured Frequency (MHz)	Pass/Fail	Measured Frequency (MHz)	Pass/Fail	Measured Frequency (MHz)	Pass/Fail	Measured Frequency (MHz)	Pass/Fail
50	120	5260.0181	PASS	5260.0185	PASS	5260.0191	PASS	5260.0207	PASS
40	120	5259.9812	PASS	5259.9787	PASS	5259.9797	PASS	5259.9796	PASS
30	120	5259.9829	PASS	5259.9859	PASS	5259.9811	PASS	5259.9843	PASS
20	120	5260.008	PASS	5260.0082	PASS	5260.0073	PASS	5260.0079	PASS
10	120	5259.9921	PASS	5259.9882	PASS	5259.9888	PASS	5259.9923	PASS
0	120	5260.0106	PASS	5260.0111	PASS	5260.0105	PASS	5260.0143	PASS
-10	120	5260.0173	PASS	5260.0206	PASS	5260.0221	PASS	5260.0209	PASS
-20	120	5259.9741	PASS	5259.974	PASS	5259.9774	PASS	5259.9755	PASS
-30	120	5259.9952	PASS	5259.9937	PASS	5259.9974	PASS	5259.9973	PASS

Frequency Stability Versus Voltage									
Operating Frequency: 5260 MHz									
TEMP. (°C)	Power Supply (Vac)	0 Minute		2 Minute		5 Minute		10 Minute	
		Measured Frequency (MHz)	Pass/Fail	Measured Frequency (MHz)	Pass/Fail	Measured Frequency (MHz)	Pass/Fail	Measured Frequency (MHz)	Pass/Fail
20	138	5260.0082	PASS	5260.0074	PASS	5260.008	PASS	5260.0072	PASS
	120	5260.008	PASS	5260.0082	PASS	5260.0073	PASS	5260.0079	PASS
	102	5260.0079	PASS	5260.0075	PASS	5260.008	PASS	5260.0086	PASS

4.7 6dB Bandwidth Measurement

4.7.1 Limits of 6dB Bandwidth Measurement

The minimum of 6dB Bandwidth Measurement is 0.5MHz.

4.7.2 Test Setup

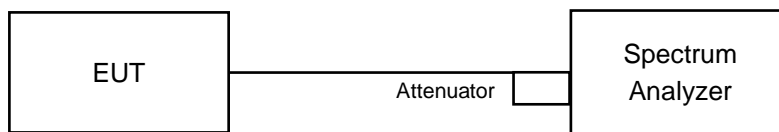

4.7.3 Test Instruments

Refer to section 4.1.2 to get information of above instrument.

4.7.4 Test Procedure

MEASUREMENT PROCEDURE REF

- Set resolution bandwidth (RBW) = 100kHz
- Set the video bandwidth (VBW) $\geq 3 \times$ RBW, Detector = Peak.
- Trace mode = max hold.
- Sweep = auto couple.
- Measure the maximum width of the emission that is constrained by the frequencies associated with the two amplitude points (upper and lower) that are attenuated by 6 dB relative to the maximum level measured in the fundamental emission

4.7.5 Deviation from Test Standard

No deviation.

4.7.6 EUT Operating Condition

The software provided by client to enable the EUT under transmission condition continuously at lowest, middle and highest channel frequencies individually.

4.7.7 Test Results (Mode 1)

802.11a

Channel	Frequency (MHz)	6dB Bandwidth (MHz)			Minimum Limit (MHz)	Pass / Fail
		Chain 0	Chain 1	Chain 2		
144 (UNII-3 Band)	5720	3.13	3.13	3.12	0.5	Pass

802.11ac (VHT20)

Channel	Frequency (MHz)	6dB Bandwidth (MHz)			Minimum Limit (MHz)	Pass / Fail
		Chain 0	Chain 1	Chain 2		
144 (UNII-3 Band)	5720	3.49	3.70	3.75	0.5	Pass

802.11ac (VHT40)

Channel	Frequency (MHz)	6dB Bandwidth (MHz)			Minimum Limit (MHz)	Pass / Fail
		Chain 0	Chain 1	Chain 2		
142 (UNII-3 Band)	5710	2.80	2.55	2.61	0.5	Pass

802.11ac (VHT80)

Channel	Frequency (MHz)	6dB Bandwidth (MHz)			Minimum Limit (MHz)	Pass / Fail
		Chain 0	Chain 1	Chain 2		
138 (UNII-3 Band)	5690	2.78	2.89	3.20	0.5	Pass

Spectrum Plot of Worst Value

802.11a_Chain 2 / CH144 (UNII-3 Band)

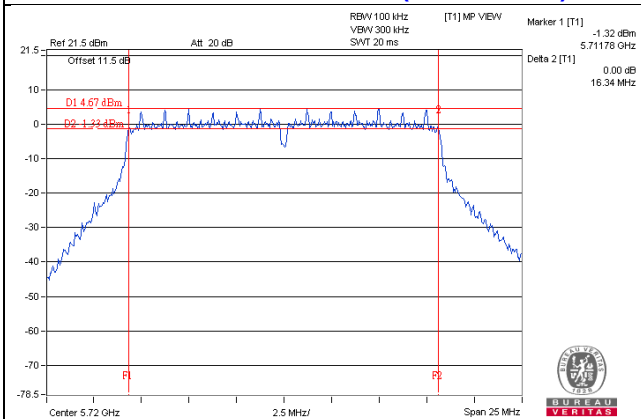

802.11ac (VHT20)_Chain 0 / CH144 (UNII-3 Band)

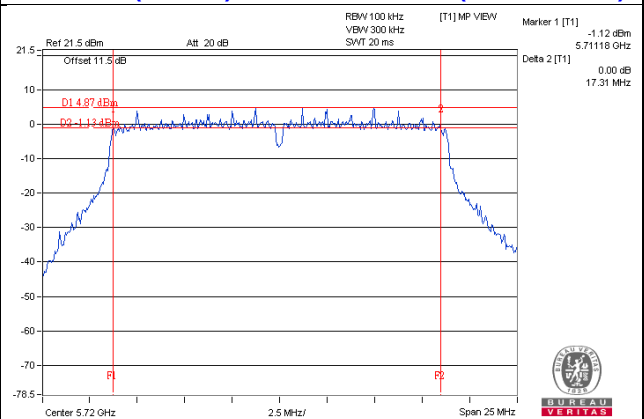

802.11ac (VHT40)_Chain 1 / CH142 (UNII-3 Band)

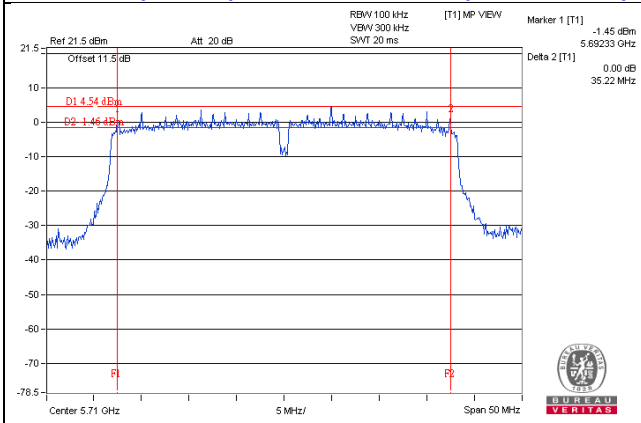

802.11ac (VHT80)_Chain 0 / CH138 (UNII-3 Band)

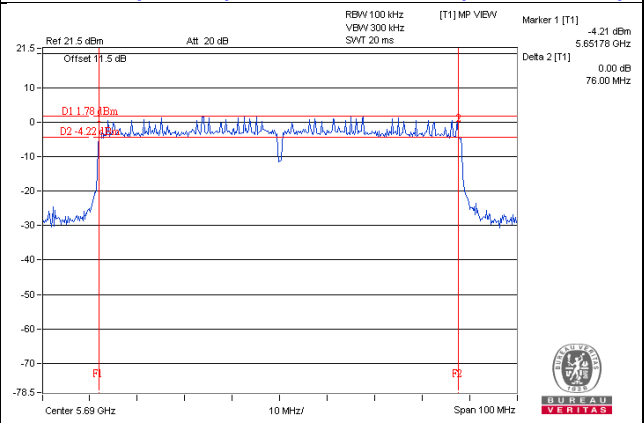

Note: The 6dB bandwidth above 5725MHz = Marker 1 + Delta 2 - 5725MHz

4.7.8 Test Results (Mode 2)

802.11a

Channel	Frequency (MHz)	6dB Bandwidth (MHz)		Minimum Limit (MHz)	Pass / Fail
		Chain 1	Chain 2		
144 (UNII-3 Band)	5720	3.15	3.16	0.5	Pass

802.11ac (VHT20)

Channel	Frequency (MHz)	6dB Bandwidth (MHz)		Minimum Limit (MHz)	Pass / Fail
		Chain 1	Chain 2		
144 (UNII-3 Band)	5720	3.44	3.39	0.5	Pass

802.11ac (VHT40)

Channel	Frequency (MHz)	6dB Bandwidth (MHz)		Minimum Limit (MHz)	Pass / Fail
		Chain 1	Chain 2		
142 (UNII-3 Band)	5710	2.55	2.51	0.5	Pass

802.11ac (VHT80)

Channel	Frequency (MHz)	6dB Bandwidth (MHz)		Minimum Limit (MHz)	Pass / Fail
		Chain 1	Chain 2		
138 (UNII-3 Band)	5690	2.89	3.20	0.5	Pass

Spectrum Plot of Worst Value

802.11a / Chain 1 - CH144 (UNII-3 Band)

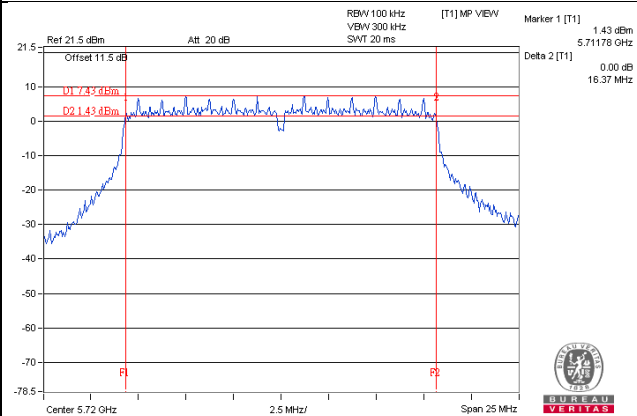

802.11ac (VHT20) / Chain 2 - CH144 (UNII-3 Band)

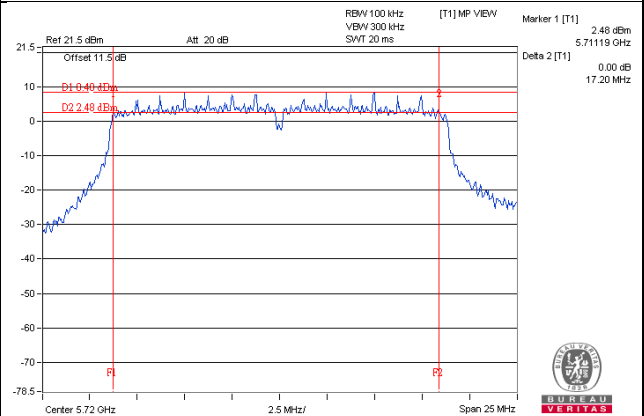

802.11ac (VHT40) / Chain 2 - CH142 (UNII-3 Band)

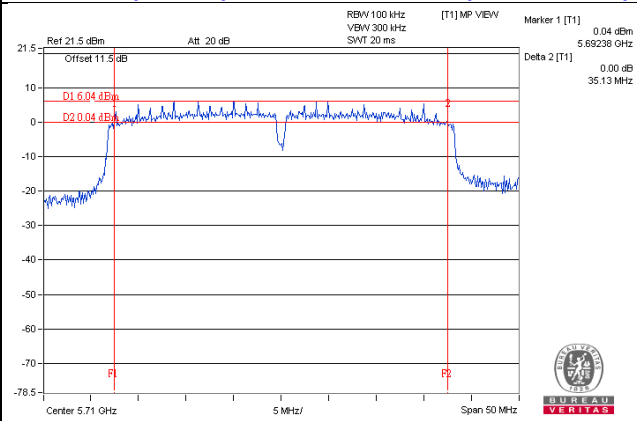

802.11ac (VHT80) / Chain 1 - CH138 (UNII-3 Band)

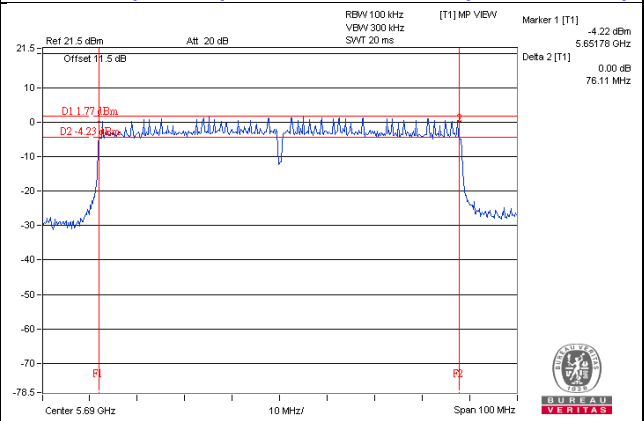

Note: The 6dB bandwidth above 5725MHz = Marker 1 + Delta 2 - 5725MHz

4.7.9 Test Results (Mode 3)

802.11a

Channel	Frequency (MHz)	6dB Bandwidth (MHz)	Minimum Limit (MHz)	Pass / Fail
144 (UNII-3 Band)	5720	3.13	0.5	PASS

802.11ac (VHT20)

Channel	Frequency (MHz)	6dB Bandwidth (MHz)	Minimum Limit (MHz)	Pass / Fail
144 (UNII-3 Band)	5720	3.75	0.5	PASS

802.11ac (VHT40)

Channel	Frequency (MHz)	6dB Bandwidth (MHz)	Minimum Limit (MHz)	Pass / Fail
142 (UNII-3 Band)	5710	1.90	0.5	PASS

802.11ac (VHT80)

Channel	Frequency (MHz)	6dB Bandwidth (MHz)	Minimum Limit (MHz)	Pass / Fail
138 (UNII-3 Band)	5690	3.19	0.5	PASS

Spectrum Plot of Worst Value

802.11a / CH144 (UNII-3 Band)

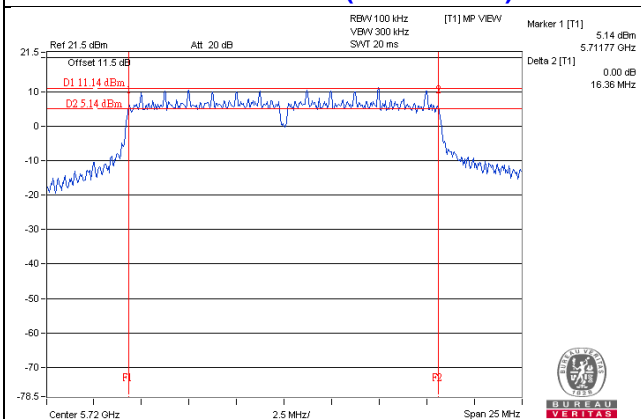

802.11ac (VHT20) / CH144 (UNII-3 Band)

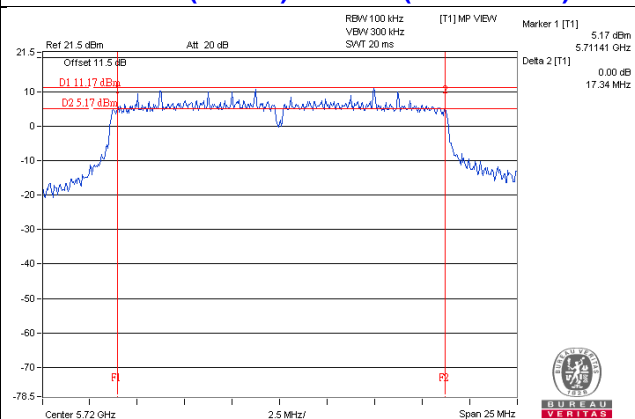

802.11ac (VHT40) / CH142 (UNII-3 Band)

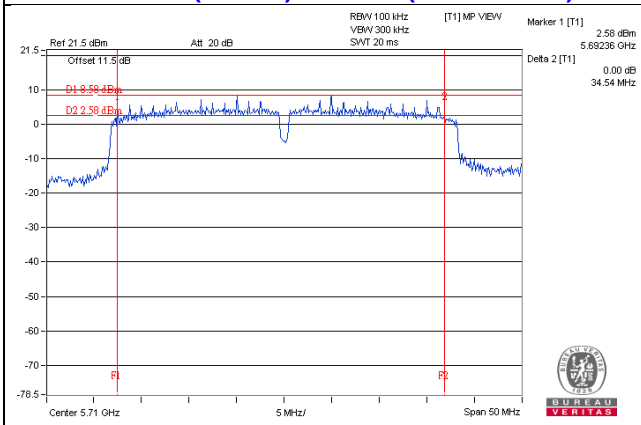

802.11ac (VHT80) / CH138 (UNII-3 Band)

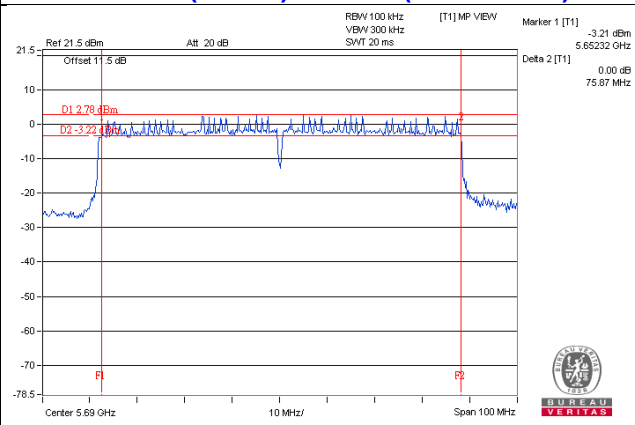

Note: The 6dB bandwidth above 5725MHz = Marker 1 + Delta 2 - 5725MHz

5 Pictures of Test Arrangements

Please refer to the attached file (Test Setup Photo).

Appendix – Information on the Testing Laboratories

We, Bureau Veritas Consumer Products Services (H.K.) Ltd., Taoyuan Branch, were founded in 1988 to provide our best service in EMC, Radio, Telecom and Safety consultation. Our laboratories are accredited and approved according to ISO/IEC 17025.

If you have any comments, please feel free to contact us at the following:

Linko EMC/RF Lab

Tel: 886-2-26052180

Fax: 886-2-26051924

Hsin Chu EMC/RF/Telecom Lab

Tel: 886-3-6668565

Fax: 886-3-6668323

Hwa Ya EMC/RF/Safety Lab

Tel: 886-3-3183232

Fax: 886-3-3270892

Email: service.adt@tw.bureauveritas.com

Web Site: www.bureauveritas-adt.com

The address and road map of all our labs can be found in our web site also.

--- END ---