

## FCC Test Report (WLAN)

**Report No.:** RF170619E02-1

**FCC ID:** 2ACTO-APX530

**Test Model:** APX 530

**Received Date:** June 22, 2017

**Test Date:** June 28 to July 18, 2017

**Issued Date:** Sep. 06, 2017

**Applicant:** Sophos Ltd

**Address:** The Pentagon, Abingdon Science Park, Abingdon, OX14 3YP, United Kingdom

**Issued By:** Bureau Veritas Consumer Products Services (H.K.) Ltd., Taoyuan Branch  
Hsin Chu Laboratory

**Lab Address:** E-2, No.1, Li Hsin 1st Road, Hsinchu Science Park, Hsinchu City 300,  
Taiwan R.O.C.

**Test Location (1):** E-2, No.1, Li Hsin 1st Road, Hsinchu Science Park, Hsinchu City 300,  
Taiwan R.O.C.

**Test Location (2):** No. 49, Ln. 206, Wende Rd., Shangshan Tsuen, Chiung Lin Hsiang, Hsin  
Chu Hsien 307, Taiwan R.O.C.



This report is for your exclusive use. Any copying or replication of this report to or for any other person or entity, or use of our name or trademark, is permitted only with our prior written permission. This report sets forth our findings solely with respect to the test samples identified herein. The results set forth in this report are not indicative or representative of the quality or characteristics of the lot from which a test sample was taken or any similar or identical product unless specifically and expressly noted. Our report includes all of the tests requested by you and the results thereof based upon the information that you provided to us. You have 60 days from date of issuance of this report to notify us of any material error or omission caused by our negligence, provided, however, that such notice shall be in writing and shall specifically address the issue you wish to raise. A failure to raise such issue within the prescribed time shall constitute your unqualified acceptance of the completeness of this report, the tests conducted and the correctness of the report contents. Unless specific mention, the uncertainty of measurement has been explicitly taken into account to declare the compliance or non-compliance to the specification. The report must not be used by the client to claim product certification, approval, or endorsement by TAF or any government agencies.

## Table of Contents

<b>Release Control Record</b> .....	<b>4</b>
<b>1 Certificate of Conformity</b> .....	<b>5</b>
<b>2 Summary of Test Results</b> .....	<b>6</b>
2.1 Measurement Uncertainty .....	6
2.2 Modification Record .....	6
<b>3 General Information</b> .....	<b>7</b>
3.1 General Description of EUT .....	7
3.2 Description of Test Modes .....	10
3.2.1 Test Mode Applicability and Tested Channel Detail .....	11
3.3 Duty Cycle of Test Signal .....	14
3.4 Description of Support Units .....	15
3.4.1 Configuration of System under Test .....	16
3.5 General Description of Applied Standard .....	18
<b>4 Test Types and Results</b> .....	<b>19</b>
4.1 Radiated Emission and Bandedge Measurement .....	19
4.1.1 Limits of Radiated Emission and Bandedge Measurement .....	19
4.1.2 Test Instruments .....	20
4.1.3 Test Procedure .....	22
4.1.4 Deviation from Test Standard .....	22
4.1.5 Test Setup .....	23
4.1.6 EUT Operating Condition .....	24
4.1.7 Test Results (Mode 1) .....	25
4.1.8 Test Results (Mode 2) .....	44
4.1.9 Test Results (Mode 3) .....	62
4.2 Conducted Emission Measurement .....	80
4.2.1 Limits of Conducted Emission Measurement .....	80
4.2.2 Test Instruments .....	80
4.2.3 Test Procedure .....	81
4.2.4 Deviation from Test Standard .....	81
4.2.5 Test Setup .....	81
4.2.6 EUT Operating Condition .....	81
4.2.7 Test Results (Mode 1) .....	82
4.3 Transmit Power Measurement .....	84
4.3.1 Limits of Transmit Power Measurement .....	84
4.3.2 Test Setup .....	84
4.3.3 Test Instruments .....	84
4.3.4 Test Procedure .....	84
4.3.5 Deviation from Test Standard .....	84
4.3.6 EUT Operating Condition .....	84
4.3.7 Test Result (Mode 1) .....	85
4.3.8 Test Result (Mode 2) .....	88
4.3.9 Test Result (Mode 3) .....	90
4.4 Occupied Bandwidth Measurement .....	91
4.4.1 Test Setup .....	91
4.4.2 Test Instruments .....	91
4.4.3 Test Procedure .....	91
4.4.4 Test Results (Mode 1) .....	92
4.4.5 Test Results (Mode 2) .....	98
4.4.6 Test Results (Mode 3) .....	104
4.5 Peak Power Spectral Density Measurement .....	108
4.5.1 Limits of Peak Power Spectral Density Measurement .....	108
4.5.2 Test Setup .....	108
4.5.3 Test Instruments .....	108

4.5.4	Test Procedure .....	109
4.5.5	Deviation from Test Standard .....	109
4.5.6	EUT Operating Condition .....	109
4.5.7	Test Results (Mode 1).....	110
4.5.8	Test Results (Mode 2).....	116
4.5.9	Test Results (Mode 3).....	122
4.6	Frequency Stability Measurement.....	126
4.6.1	Limits of Frequency Stability Measurement .....	126
4.6.2	Test Setup.....	126
4.6.3	Test Instruments .....	126
4.6.4	Test Procedure .....	126
4.6.5	Deviation from Test Standard .....	126
4.6.6	EUT Operating Condition .....	126
4.6.7	Test Results .....	127
4.7	6dB Bandwidth Measurement.....	128
4.7.1	Limits of 6dB Bandwidth Measurement.....	128
4.7.2	Test Setup.....	128
4.7.3	Test Instruments .....	128
4.7.4	Test Procedure .....	128
4.7.5	Deviation from Test Standard .....	128
4.7.6	EUT Operating Condition .....	128
4.7.7	Test Results (Mode 1).....	129
4.7.8	Test Results (Mode 2).....	131
4.7.9	Test Results (Mode 3).....	133
<b>5</b>	<b>Pictures of Test Arrangements.....</b>	<b>135</b>
	<b>Annex A- Radiated Out of Band Emission (OOBE) Measurement (For U-NII-3 band) .....</b>	<b>136</b>
	<b>Appendix – Information on the Testing Laboratories .....</b>	<b>145</b>

### Release Control Record

Issue No.	Description	Date Issued
RF170619E02-1	Original release.	Sep. 06, 2017

## 1 Certificate of Conformity

**Product:** Sophos Access Point

**Brand:** SOPHOS

**Test Model:** APX 530

**Sample Status:** ENGINEERING SAMPLE

**Applicant:** Sophos Ltd

**Test Date:** June 28 to July 18, 2017

**Standard:** 47 CFR FCC Part 15, Subpart E (Section 15.407)  
ANSI C63.10: 2013

The above equipment has been tested by **Bureau Veritas Consumer Products Services (H.K.) Ltd., Taoyuan Branch**, and found compliance with the requirement of the above standards. The test record, data evaluation & Equipment Under Test (EUT) configurations represented herein are true and accurate accounts of the measurements of the sample's EMC characteristics under the conditions specified in this report.

**Prepared by :** Wendy Wu , **Date:** Sep. 06, 2017  
Wendy Wu / Specialist

**Approved by :** May Chen , **Date:** Sep. 06, 2017  
May Chen / Manager

## 2 Summary of Test Results

47 CFR FCC Part 15, Subpart E (Section 15.407)			
FCC Clause	Test Item	Result	Remarks
15.407(b)(6)	AC Power Conducted Emissions	Pass	Meet the requirement of limit. Minimum passing margin is -7.02dB at 0.40781MHz.
15.407(b) (1/2/3/4(i/ii)/6)	Radiated Emissions & Band Edge Measurement*	Pass	Meet the requirement of limit. Minimum passing margin is -0.1dB at 5150.00MHz, 5926.92MHz, 5635.30MHz.
15.407(a)(1/2/3)	Max Average Transmit Power	Pass	Meet the requirement of limit.
---	Occupied Bandwidth Measurement	-	Reference only.
15.407(a)(1/2/3)	Peak Power Spectral Density	Pass	Meet the requirement of limit.
15.407(e)	6dB bandwidth	Pass	Meet the requirement of limit. (U-NII-3 Band only)
15.407(g)	Frequency Stability	Pass	Meet the requirement of limit.
15.203	Antenna Requirement	Pass	Antenna connector is i-pex(MHF) not a standard connector.

\*For U-NII-3 band compliance with rule part 15.407(b)(4)(i), the OOB test plots were recorded in Annex A.

### 2.1 Measurement Uncertainty

Where relevant, the following measurement uncertainty levels have been estimated for tests performed on the EUT as specified in CISPR 16-4-2:

Measurement	Frequency	Expanded Uncertainty (k=2) (±)
Conducted Emissions at mains ports	150kHz ~ 30MHz	1.84 dB
Radiated Emissions up to 1 GHz	30MHz ~ 1GHz	5.32 dB
Radiated Emissions above 1 GHz	1GHz ~ 6GHz	5.14 dB
	6GHz ~ 18GHz	5.04 dB
	18GHz ~ 40GHz	5.25 dB

### 2.2 Modification Record

There were no modifications required for compliance.

### 3 General Information

#### 3.1 General Description of EUT

Product	Sophos Access Point
Brand	SOPHOS
Test Model	APX 530
Status of EUT	ENGINEERING SAMPLE
Power Supply Rating	DC 55V from POE
Modulation Type	CCK, DQPSK, DBPSK for DSSS 64QAM, 16QAM, QPSK, BPSK for OFDM 256QAM for OFDM in 11ac mode only
Modulation Technology	DSSS, OFDM
Transfer Rate	802.11b: up to 11Mbps 802.11a/g: up to 54Mbps 802.11n: up to 450Mbps 802.11ac: up to 1300Mbps
Operating Frequency	<b>2.4GHz:</b> 2.412 ~ 2.462GHz <b>5GHz:</b> 5.18~ 5.24GHz, 5.745 ~ 5.825GHz
Number of Channel	<b>2.4GHz:</b> 802.11b, 802.11g, 802.11n (HT20): 11 802.11n (HT40): 7 <b>5GHz:</b> 802.11a, 802.11n (HT20), 802.11ac (VHT20): 9 802.11n (HT40), 802.11ac (VHT40): 4 802.11ac (VHT80): 2
Output Power	<b>2.4GHz:</b> <b>CDD Mode:</b> <b>3TX:</b> 779.535mW (28.92dBm) <b>2TX:</b> 530.649mW (27.25dBm) <b>1TX:</b> 249.459mW (23.97dBm) <b>Beamforming Mode:</b> <b>3TX:</b> 491.308mW (26.91dBm) <b>2TX:</b> 442.117mW (26.46dBm) <b>5GHz:</b> <b>CDD Mode:</b> <b>5.18 ~ 5.24GHz:</b> <b>3TX:</b> 353.293mW (25.48dBm) <b>2TX:</b> 428.481mW (26.32dBm) <b>1TX:</b> 231.739mW (23.65dBm) <b>5.745 ~ 5.825GHz:</b> <b>3TX:</b> 650.435mW (28.13dBm) <b>2TX:</b> 449.526mW (26.53dBm) <b>1TX:</b> 260.016mW (24.15dBm) <b>Beamforming Mode:</b> <b>5.18 ~ 5.24GHz:</b> <b>3TX:</b> 353.293mW (25.48dBm) <b>2TX:</b> 428.481mW (26.32dBm) <b>5.745 ~ 5.825GHz:</b> <b>3TX:</b> 353.913mW (25.49dBm) <b>2TX:</b> 449.526mW (26.53dBm)
Antenna Type	Refer to Note
Antenna Connector	Refer to Note
Accessory Device	NA
Data Cable Supplied	NA

Note:

1. The EUT has three radio transceivers, radio 1 is WLAN technologies for single band (2.4GHz), radio 2 is WLAN technology for single band (5GHz), and radio 3 is Bluetooth low energy (BT-LE) technology only.
2. Simultaneously transmission condition.

Condition	Technology	
1	WLAN 2.4GHz (Radio 1)	WLAN 5GHz (Radio 2)

**Note:** The emission of the simultaneous operation has been evaluated and no non-compliance was found.

3. The EUT must be supplied with a POE (only for test not for sale) as following table:

Brand	Model No.	Spec.
Microsemi	PD-9001GR/AC	Input: 100-240Vac, 50/60Hz, 0.67A Output: 55Vdc, 0.6A

4. The antennas provided to the EUT, please refer to the following table:

Radio 1								
2.4GHz								
Antenna No.	Transmitter Circuit	Brand	Model No.	Antenna Net Gain (dBi)	Frequency Range (GHz)	Antenna Type	Connector Type	*Cable Length
1	Chain (0)	NA	NA	4.71	2.4~2.4835	PIFA	i-pex(MHF)	48
2	Chain (1)	NA	NA	3.54	2.4~2.4835	PIFA	i-pex(MHF)	138
3	Chain (2)	NA	NA	4.6	2.4~2.4835	PIFA	i-pex(MHF)	145
Radio 2								
5GHz								
Antenna No.	Transmitter Circuit	Brand	Model No.	Antenna Net Gain (dBi)	Frequency Range (GHz)	Antenna Type	Connector Type	*Cable Length
1	Chain (0)	NA	NA	5.5	5.15~5.85	PIFA	i-pex(MHF)	42
2	Chain (1)	NA	NA	5.76	5.15~5.85	PIFA	i-pex(MHF)	140
3	Chain (2)	NA	NA	5.91	5.15~5.85	PIFA	i-pex(MHF)	145
Radio 3								
Bluetooth								
Antenna No.	Transmitter Circuit	Brand	Model No.	Antenna Net Gain (dBi)	Frequency Range (GHz)	Antenna Type	Connector Type	*Cable Length
1	Chain (0)	NA	NA	2.95	2.4~2.4835	PIFA	i-pex(MHF)	74

Note: For 1TX/2TX configuration mode, max gain was selected for the final test.



5. The EUT incorporates a MIMO function:

2.4GHz Band			
MODULATION MODE	DATA RATE (MCS)	TX & RX CONFIGURATION	
802.11b	1 ~ 11Mbps	3TX/2TX/1TX diversity	3RX
802.11g	6 ~ 54Mbps	3TX/2TX/1TX diversity	3RX
802.11n (HT20)	MCS 0~7	3TX/2TX/1TX diversity	3RX
	MCS 8~15	3TX/2TX diversity	3RX
	MCS 16~23	3TX	3RX
802.11n (HT40)	MCS 0~7	3TX/2TX/1TX diversity	3RX
	MCS 8~15	3TX/2TX diversity	3RX
	MCS 16~23	3TX	3RX
5GHz Band			
MODULATION MODE	DATA RATE (MCS)	TX & RX CONFIGURATION	
802.11a	6 ~ 54Mbps	3TX/2TX/1TX diversity	3RX
802.11n (HT20)	MCS 0~7	3TX/2TX/1TX diversity	3RX
	MCS 8~15	3TX/2TX	3RX
	MCS 16~23	3TX	3RX
802.11n (HT40)	MCS 0~7	3TX/2TX/1TX diversity	3RX
	MCS 8~15	3TX/2TX	3RX
	MCS 16~23	3TX	3RX
802.11ac (VHT20)	MCS 0~8, Nss=1	3TX/2TX/1TX diversity	3RX
	MCS 0~8, Nss=2	3TX/2TX	3RX
	MCS 0~9, Nss=3	/3TX	3RX
802.11ac (VHT40)	MCS 0~9, Nss=1	3TX/2TX/1TX diversity	3RX
	MCS 0~9, Nss=2	3TX/2TX	3RX
	MCS 0~9, Nss=3	/3TX	3RX
802.11ac (VHT80)	MCS 0~9, Nss=1	3TX/2TX/1TX diversity	3RX
	MCS 0~9, Nss=2	3TX/2TX	3RX
	MCS 0~9, Nss=3	3TX	3RX

Note:

1. All of modulation mode support beamforming function except 802.11a/b/g modulation mode.
2. The EUT support Beamforming and CDD mode, therefore both mode were investigated and the worst case scenario was identified. The worst case data were presented in test report.
3. The modulation and bandwidth are similar for 802.11n mode for 20MHz (40MHz) and 802.11ac mode for 20MHz (40MHz), therefore investigated worst case to representative mode in test report. (Final test mode refer section 3.2.1)

6. The above EUT information is declared by manufacturer and for more detailed features description, please refer to the manufacturer's specifications or user's manual.

### 3.2 Description of Test Modes

#### FOR 5180 ~ 5240MHz

4 channels are provided for 802.11a, 802.11n (HT20), 802.11ac (VHT20):

Channel	Frequency	Channel	Frequency
36	5180MHz	44	5220MHz
40	5200MHz	48	5240MHz

2 channels are provided for 802.11n (HT40), 802.11ac (VHT40):

Channel	Frequency	Channel	Frequency
38	5190MHz	46	5230MHz

1 channel is provided for 802.11ac (VHT80):

Channel	Frequency
42	5210MHz

#### FOR 5745 ~ 5825MHz:

5 channels are provided for 802.11a, 802.11n (HT20), 802.11ac (VHT20):

Channel	Frequency	Channel	Frequency
149	5745MHz	161	5805MHz
153	5765MHz	165	5825MHz
157	5785MHz		

2 channels are provided for 802.11n (HT40), 802.11ac (VHT40):

Channel	Frequency	Channel	Frequency
151	5755MHz	159	5795MHz

1 channel is provided for 802.11ac (VHT80):

Channel	Frequency
155	5775MHz

### 3.2.1 Test Mode Applicability and Tested Channel Detail

EUT Configure Mode	Applicable To				Description
	RE $\geq$ 1G	RE<1G	PLC	APCM	
1	√	√	√	√	3TX Mode
2	√	-	-	√	2TX Mode
3	√	-	-	√	1TX Mode

Where **RE $\geq$ 1G**: Radiated Emission above 1GHz      **RE<1G**: Radiated Emission below 1GHz  
**PLC**: Power Line Conducted Emission      **APCM**: Antenna Port Conducted Measurement

**NOTE:**

1. The EUT had been pre-tested on the positioned of each 3 axis. The worst case was found when positioned on **X-plane**.
2. "-" means no effect.

#### **Radiated Emission Test (Above 1GHz):**

- Pre-Scan has been conducted to determine the worst-case mode from all possible combinations between available modulations, data rates and antenna ports (if EUT with antenna diversity architecture).
- Following channel(s) was (were) selected for the final test as listed below.

CDD Mode						
Mode	FREQ. Band (MHz)	Available Channel	Tested Channel	Modulation Technology	Modulation Type	Data Rate (Mbps)
802.11a	5180-5240	36 to 48	36, 40, 48	OFDM	BPSK	6
802.11ac (VHT20)		36 to 48	36, 40, 48	OFDM	BPSK	6.5
802.11ac (VHT40)		38 to 46	38, 46	OFDM	BPSK	13.5
802.11ac (VHT80)		42	42	OFDM	BPSK	29.3
802.11a	5745-5825	149 to 165	149, 157, 165	OFDM	BPSK	6
802.11ac (VHT20)		149 to 165	149, 157, 165	OFDM	BPSK	6.5
802.11ac (VHT40)		151 to 159	151, 159	OFDM	BPSK	13.5
802.11ac (VHT80)		155	155	OFDM	BPSK	29.3

#### **Radiated Emission Test (Below 1GHz):**

- Pre-Scan has been conducted to determine the worst-case mode from all possible combinations between available modulations, data rates and antenna ports (if EUT with antenna diversity architecture).
- Following channel(s) was (were) selected for the final test as listed below.

CDD Mode						
Mode	FREQ. Band (MHz)	Available Channel	Tested Channel	Modulation Technology	Modulation Type	Data Rate (Mbps)
802.11ac (VHT20)	5180-5240 5745-5825	36 to 48 149 to 165	149	OFDM	BPSK	6.5

### Power Line Conducted Emission Test:

- Pre-Scan has been conducted to determine the worst-case mode from all possible combinations between available modulations, data rates and antenna ports (if EUT with antenna diversity architecture).
- Following channel(s) was (were) selected for the final test as listed below.

CDD Mode						
Mode	FREQ. Band (MHz)	Available Channel	Tested Channel	Modulation Technology	Modulation Type	Data Rate (Mbps)
802.11ac (VHT20)	5180-5240 5745-5825	36 to 48 149 to 165	149	OFDM	BPSK	6.5

### Antenna Port Conducted Measurement:

- This item includes all test value of each mode, but only includes spectrum plot of worst value of each mode.
- Pre-Scan has been conducted to determine the worst-case mode from all possible combinations between available modulations, data rates and antenna ports (if EUT with antenna diversity architecture).
- Following channel(s) was (were) selected for the final test as listed below.

CDD Mode						
Mode	FREQ. Band (MHz)	Available Channel	Tested Channel	Modulation Technology	Modulation Type	Data Rate (Mbps)
802.11a	5180-5240	36 to 48	36, 40, 48	OFDM	BPSK	6
802.11ac (VHT20)		36 to 48	36, 40, 48	OFDM	BPSK	6.5
802.11ac (VHT40)		38 to 46	38, 46	OFDM	BPSK	13.5
802.11ac (VHT80)		42	42	OFDM	BPSK	29.3
802.11a	5745-5825	149 to 165	149, 157, 165	OFDM	BPSK	6
802.11ac (VHT20)		149 to 165	149, 157, 165	OFDM	BPSK	6.5
802.11ac (VHT40)		151 to 159	151, 159	OFDM	BPSK	13.5
802.11ac (VHT80)		155	155	OFDM	BPSK	29.3
Beamforming Mode (output power only)						
Mode	FREQ. Band (MHz)	Available Channel	Tested Channel	Modulation Technology	Modulation Type	Data Rate (Mbps)
802.11ac (VHT20)	5180-5240	36 to 48	36, 40, 48	OFDM	BPSK	6.5
802.11ac (VHT40)		38 to 46	38, 46	OFDM	BPSK	13.5
802.11ac (VHT80)		42	42	OFDM	BPSK	29.3
802.11ac (VHT20)	5745-5825	149 to 165	149, 157, 165	OFDM	BPSK	6.5
802.11ac (VHT40)		151 to 159	151, 159	OFDM	BPSK	13.5
802.11ac (VHT80)		155	155	OFDM	BPSK	29.3

**Test Condition:**

Applicable To	Environmental Conditions	Input Power (SYSTEM)	Tested By
RE≥1G	21deg. C, 65%RH	120Vac, 60Hz	Rey Chen Weiwei Lo
RE<1G	23deg. C, 69%RH	120Vac, 60Hz	Weiwei Lo
PLC	24deg. C, 75%RH	120Vac, 60Hz	Andy Ho
APCM	25deg. C, 60%RH	120Vac, 60Hz	Robert Cheng

### 3.3 Duty Cycle of Test Signal

If duty cycle of test signal is  $\geq 98\%$ , duty factor is not required.

If duty cycle of test signal is  $< 98\%$ , duty factor shall be considered.

**802.11a:** Duty cycle =  $2.028 \text{ ms} / 2.094 \text{ ms} = 0.968$ , Duty factor =  $10 * \log(1/0.968) = 0.14$

**802.11ac (VHT20):** Duty cycle =  $4.966 \text{ ms} / 5.053 \text{ ms} = 0.983$

**802.11ac (VHT40):** Duty cycle =  $2.41 \text{ ms} / 2.486 \text{ ms} = 0.969$ , Duty factor =  $10 * \log(1/0.969) = 0.13$

**802.11ac (VHT80):** Duty cycle =  $1.135 \text{ ms} / 1.198 \text{ ms} = 0.947$ , Duty factor =  $10 * \log(1/0.947) = 0.23$

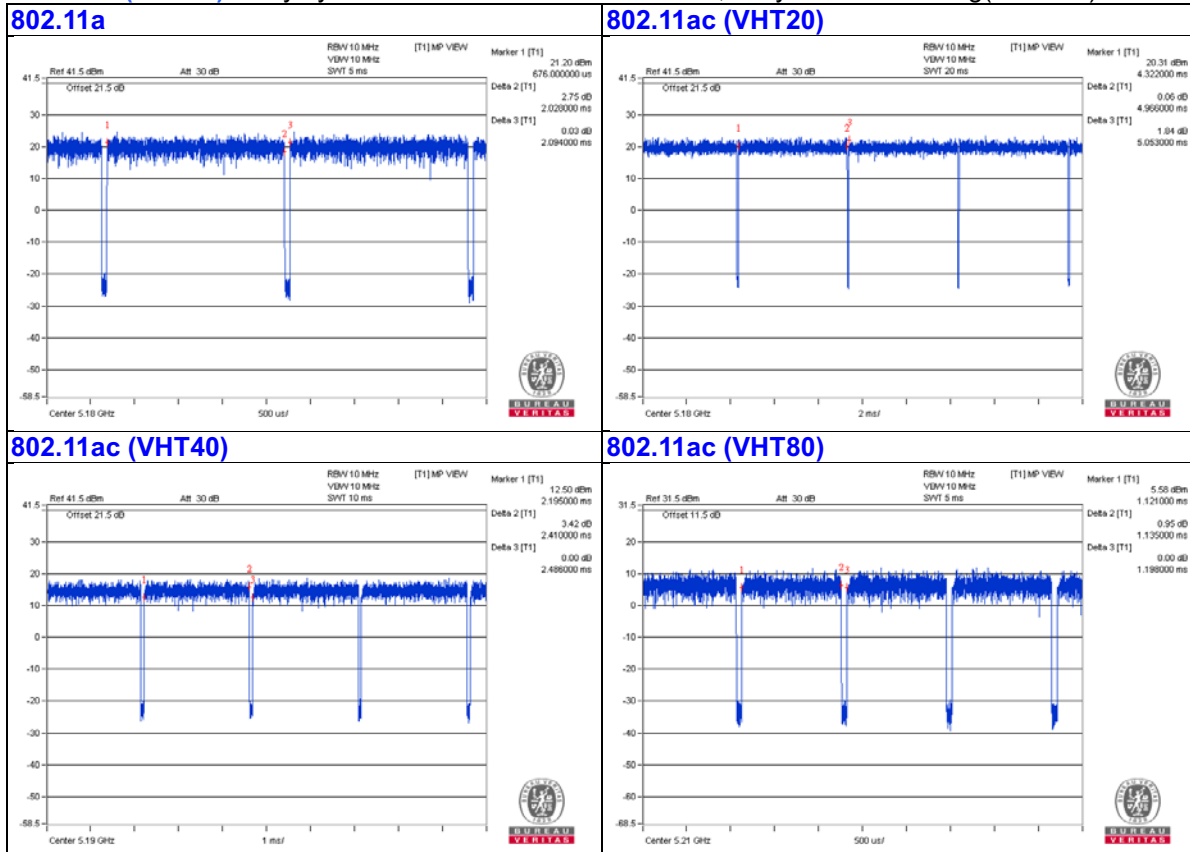

### 3.4 Description of Support Units

The EUT has been tested as an independent unit together with other necessary accessories or support units. The following support units or accessories were used to form a representative test configuration during the tests.

ID	Product	Brand	Model No.	Serial No.	FCC ID	Remarks
A.	Laptop	DELL	E6440	F9LYQ32	FCC DoC	Provided by Lab
B.	PoE	Microsemi	PD-9001GR/AC	NA	NA	Supplied by client
C.	Laptop	DELL	E6420	B92T3R1	FCC DoC	Provided by Lab

Note:

1. All power cords of the above support units are non-shielded (1.8m).

ID	Descriptions	Qty.	Length (m)	Shielding (Yes/No)	Cores (Qty.)	Remarks
1.	RJ-45 Cable	1	10	No	0	Provided by Lab
2.	RJ-45 Cable	1	10	No	0	Provided by Lab
3.	RJ-45 Cable	1	3	No	0	Provided by Lab
4.	Console Cable	1	3	No	0	Provided by Lab

### 3.4.1 Configuration of System under Test

For Conducted Emission:

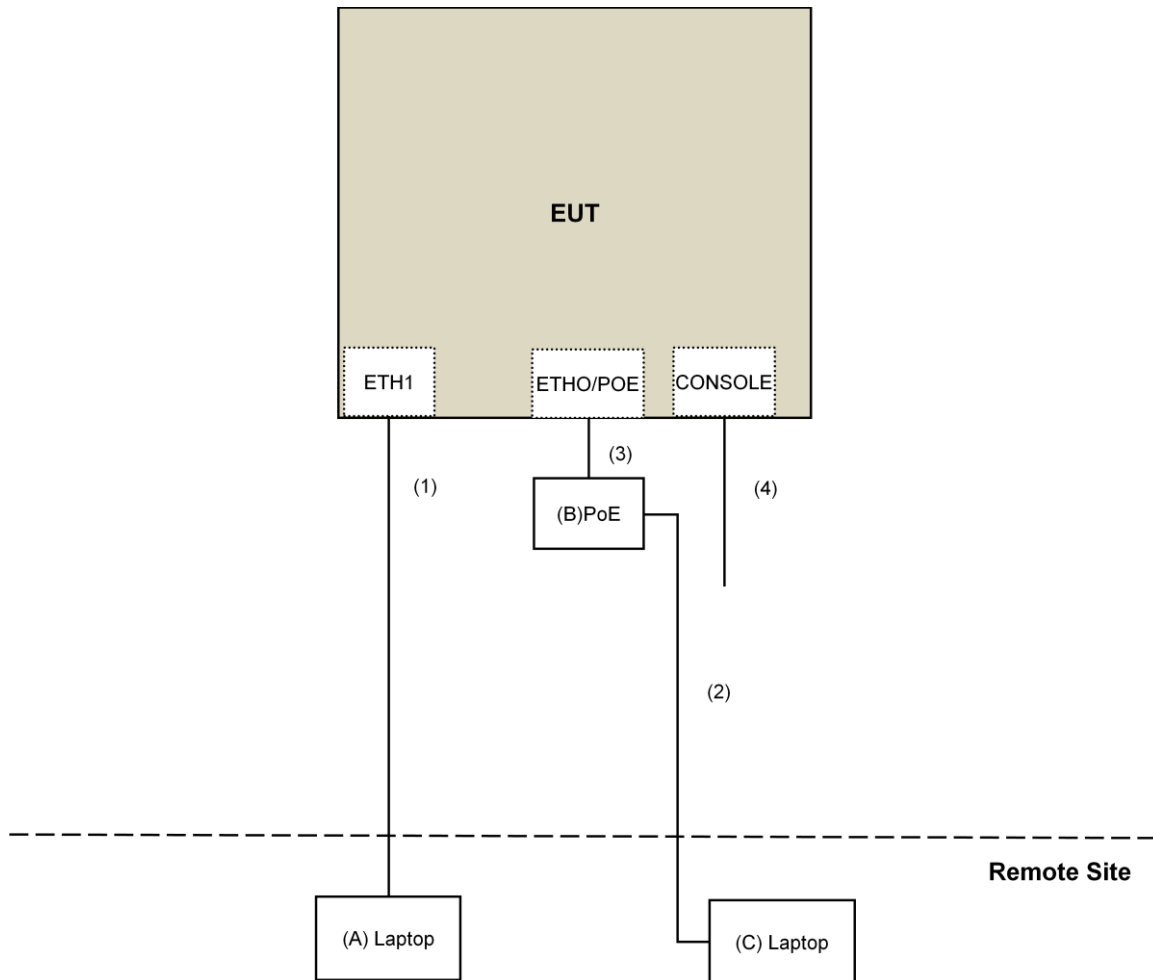



For other test:

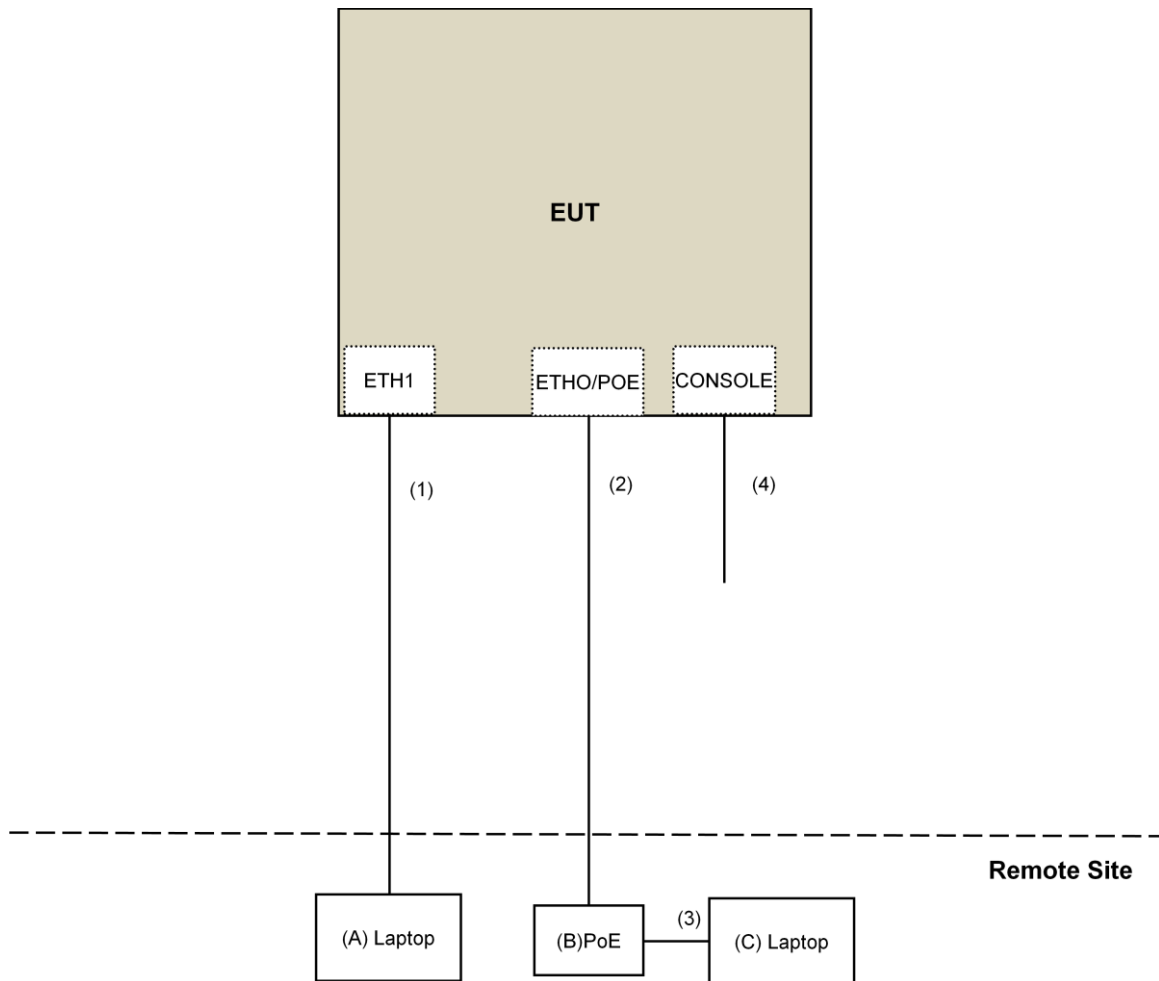

### 3.5 General Description of Applied Standard

The EUT is a RF Product. According to the specifications of the manufacturer, it must comply with the requirements of the following standards:

**FCC Part 15, Subpart E (15.407)**  
**KDB 789033 D02 General UNII Test Procedure New Rules v01r04**  
**KDB 662911 D01 Multiple Transmitter Output v02r01**  
**ANSI C63.10-2013**

All test items have been performed and recorded as per the above standards.

**NOTE:** The EUT has been verified to comply with the requirements of FCC Part 15, Subpart B, Class B (DoC). The test report has been issued separately.

## 4 Test Types and Results

### 4.1 Radiated Emission and Bandedge Measurement

#### 4.1.1 Limits of Radiated Emission and Bandedge Measurement

Radiated emissions which fall in the restricted bands must comply with the radiated emission limits specified as below table.

Frequencies (MHz)	Field Strength (microvolts/meter)	Measurement Distance (meters)
0.009 ~ 0.490	2400/F(kHz)	300
0.490 ~ 1.705	24000/F(kHz)	30
1.705 ~ 30.0	30	30
30 ~ 88	100	3
88 ~ 216	150	3
216 ~ 960	200	3
Above 960	500	3

#### NOTE:

1. The lower limit shall apply at the transition frequencies.
2. Emission level (dBuV/m) = 20 log Emission level (uV/m).
3. For frequencies above 1000MHz, the field strength limits are based on average detector, however, the peak field strength of any emission shall not exceed the maximum permitted average limits, specified above by more than 20dB under any condition of modulation.

Limits of unwanted emission out of the restricted bands

Applicable To		Limit	
789033 D02 General UNII Test Procedure New Rules v01r04		Field Strength at 3m	
		PK:74 (dBuV/m)	AV:54 (dBuV/m)
Frequency Band	Applicable To	EIRP Limit	Equivalent Field Strength at 3m
5150~5250 MHz	15.407(b)(1)	PK:-27 (dBm/MHz)	PK:68.2(dBuV/m)
5250~5350 MHz	15.407(b)(2)		
5470~5725 MHz	15.407(b)(3)		
5725~5850 MHz	<input checked="" type="checkbox"/> 15.407(b)(4)(i)	PK:-27 (dBm/MHz) <sup>*1</sup> PK:10 (dBm/MHz) <sup>*2</sup> PK:15.6 (dBm/MHz) <sup>*3</sup> PK:27 (dBm/MHz) <sup>*4</sup>	PK: 68.2(dBuV/m) <sup>*1</sup> PK:105.2 (dBuV/m) <sup>*2</sup> PK: 110.8(dBuV/m) <sup>*3</sup> PK:122.2 (dBuV/m) <sup>*4</sup>
	<input type="checkbox"/> 15.407(b)(4)(ii)	Emission limits in section 15.247(d)	
<sup>*1</sup> beyond 75 MHz or more above of the band edge.		<sup>*2</sup> below the band edge increasing linearly to 10 dBm/MHz at 25 MHz above.	
<sup>*3</sup> below the band edge increasing linearly to a level of 15.6 dBm/MHz at 5 MHz above.		<sup>*4</sup> from 5 MHz above or below the band edge increasing linearly to a level of 27 dBm/MHz at the band edge.	

#### Note:

The following formula is used to convert the equipment isotropic radiated power (eirp) to field strength:

$$E = \frac{1000000\sqrt{30P}}{3} \mu\text{V/m, where } P \text{ is the eirp (Watts).}$$

#### 4.1.2 Test Instruments

##### For below 1GHz test:

DESCRIPTION & MANUFACTURER	MODEL NO.	SERIAL NO.	CALIBRATED DATE	CALIBRATED UNTIL
Test Receiver Agilent	N9038A	MY50010156	Aug. 18, 2016	Aug. 17, 2017
Pre-Amplifier <sup>(*)</sup> EMCI	EMC001340	980142	Jan. 20, 2016	Jan. 19, 2018
Loop Antenna <sup>(*)</sup> Electro-Metrics	EM-6879	264	Dec. 16, 2016	Dec. 15, 2018
RF Cable	NA	LOOPCAB-001 LOOPCAB-002	Jan. 17, 2017	Jan. 16, 2018
Pre-Amplifier Mini-Circuits	ZFL-1000VH2 B	AMP-ZFL-05	May 06, 2017	May 05, 2018
Trilog Broadband Antenna SCHWARZBECK	VULB 9168	9168-361	Dec. 29, 2016	Dec. 28, 2017
RF Cable	8D	966-3-1 966-3-2 966-3-3	Apr. 01, 2017	Mar. 31, 2018
Fixed attenuator Mini-Circuits	UNAT-5+	PAD-3m-3-01	Oct. 05, 2016	Oct. 04, 2017
Software	ADT_Radiated _V8.7.08	NA	NA	NA
Antenna Tower & Turn Table Max-Full	MF-7802	MF780208406	NA	NA

##### Note:

1. The calibration interval of the above test instruments is 12 months and the calibrations are traceable to NML/ROC and NIST/USA.
2. \*The calibration interval of the above test instruments is 24 months and the calibrations are traceable to NML/ROC and NIST/USA.
3. The test was performed in 966 Chamber No. 3.
4. The FCC Site Registration No. is 147459
5. The CANADA Site Registration No. is 20331-1
6. Loop antenna was used for all emissions below 30 MHz.
7. Tested Date: June 28, 2017

**For other test:**

DESCRIPTION & MANUFACTURER	MODEL NO.	SERIAL NO.	CALIBRATED DATE	CALIBRATED UNTIL
Test Receiver Agilent	N9038A	MY50010156	Aug. 18, 2016	Aug. 17, 2017
Horn_Antenna SCHWARZBECK	BBHA9120-D	9120D-406	Dec. 28, 2016	Dec. 27, 2017
Pre-Amplifier EMCI	EMC12630SE	980384	Feb. 02, 2017	Feb. 01, 2018
RF Cable	EMC104-SM-SM-1200 EMC104-SM-SM-2000 EMC104-SM-SM-5000	160922 150317 150322	Feb. 02, 2017 Mar. 29, 2017 Mar. 29, 2017	Feb. 01, 2018 Mar. 28, 2018 Mar. 28, 2018
Spectrum Analyzer Keysight	N9030A	MY54490520	July 29, 2016	July 28, 2017
Pre-Amplifier EMCI	EMC184045S E	980386	Feb. 02, 2017	Feb. 01, 2018
Horn_Antenna SCHWARZBECK	BBHA 9170	BBHA9170608	Dec. 15, 2016	Dec. 14, 2017
RF Cable	SUCOFLEX 102	36432/2 36433/2	Jan. 15, 2017	Jan. 14, 2018
Software	ADT_Radiated _V8.7.08	NA	NA	NA
Antenna Tower & Turn Table Max-Full	MF-7802	MF780208406	NA	NA
Boresight Antenna Fixture	FBA-01	FBA-SIP01	NA	NA
Spectrum Analyzer R&S	FSV40	100964	July 1, 2017	June 30, 2018
Power meter Anritsu	ML2495A	1014008	May 11, 2017	May 10, 2018
Power sensor Anritsu	MA2411B	0917122	May 11, 2017	May 10, 2018
Temperature & Humidity Chamber Giant Force	GTH-150-40-S P-AR	MAA0812-008	Jan. 11, 2017	Jan. 10, 2018
AC Power Source Extech Electronics	6205	1440452	NA	NA
Digital Multimeter FLUKE	87III	73680266	Nov. 10, 2016	Nov. 09, 2017

**Note:**

1. The calibration interval of the above test instruments is 12 months and the calibrations are traceable to NML/ROC and NIST/USA.
2. The test was performed in 966 Chamber No. 3.
3. The FCC Site Registration No. is 147459
4. The CANADA Site Registration No. is 20331-1
5. Tested Date: July 06 to 14, 2017

#### 4.1.3 Test Procedure

##### **For Radiated emission below 30MHz**

- a. The EUT was placed on the top of a rotating table 0.8 meters above the ground at a 3 meter chamber room. The table was rotated 360 degrees to determine the position of the highest radiation.
- b. The EUT was set 3 meters away from the interference-receiving antenna, which was mounted on the top of a variable-height antenna tower.
- c. Both X and Y axes of the antenna are set to make the measurement.
- d. For each suspected emission, the EUT was arranged to its worst case and the rotatable table was turned from 0 degrees to 360 degrees to find the maximum reading.
- e. The test-receiver system was set to Quasi-Peak Detect Function and Specified Bandwidth with Maximum Hold Mode.

##### **NOTE:**

1. The resolution bandwidth and video bandwidth of test receiver/spectrum analyzer is 9kHz at frequency below 30MHz.

##### **For Radiated emission above 30MHz**

- a. The EUT was placed on the top of a rotating table 0.8 meters (for 30MHz ~ 1GHz) / 1.5 meters (for above 1GHz) above the ground at 3 meter chamber room for test. The table was rotated 360 degrees to determine the position of the highest radiation.
- b. The EUT was set 3 meters away from the interference-receiving antenna, which was mounted on the top of a variable-height antenna tower.
- c. The height of antenna is varied from one meter to four meters above the ground to determine the maximum value of the field strength. Both horizontal and vertical polarizations of the antenna are set to make the measurement.
- d. For each suspected emission, the EUT was arranged to its worst case and then the antenna was tuned to heights from 1 meter to 4 meters and the rotatable table was turned from 0 degrees to 360 degrees to find the maximum reading.
- e. The test-receiver system was set to quasi-peak detect function and specified bandwidth with maximum hold mode when the test frequency is below 1 GHz.
- f. The test-receiver system was set to peak and average detect function and specified bandwidth with maximum hold mode when the test frequency is above 1 GHz. If the peak reading value also meets average limit, measurement with the average detector is unnecessary.

##### **Note:**

1. The resolution bandwidth and video bandwidth of test receiver/spectrum analyzer is 120kHz for Quasi-peak detection (QP) at frequency below 1GHz.
2. The resolution bandwidth of test receiver/spectrum analyzer is 1 MHz and the video bandwidth is 3 MHz for Peak detection (PK) at frequency above 1GHz.
3. The resolution bandwidth of test receiver/spectrum analyzer is 1MHz and the video bandwidth is  $\geq 1/T$  (Duty cycle < 98%) or 10Hz (Duty cycle  $\geq 98\%$ ) for Average detection (AV) at frequency above 1GHz.
4. All modes of operation were investigated and the worst-case emissions are reported.

#### 4.1.4 Deviation from Test Standard

No deviation.

#### 4.1.5 Test Setup

##### For Radiated emission below 30MHz

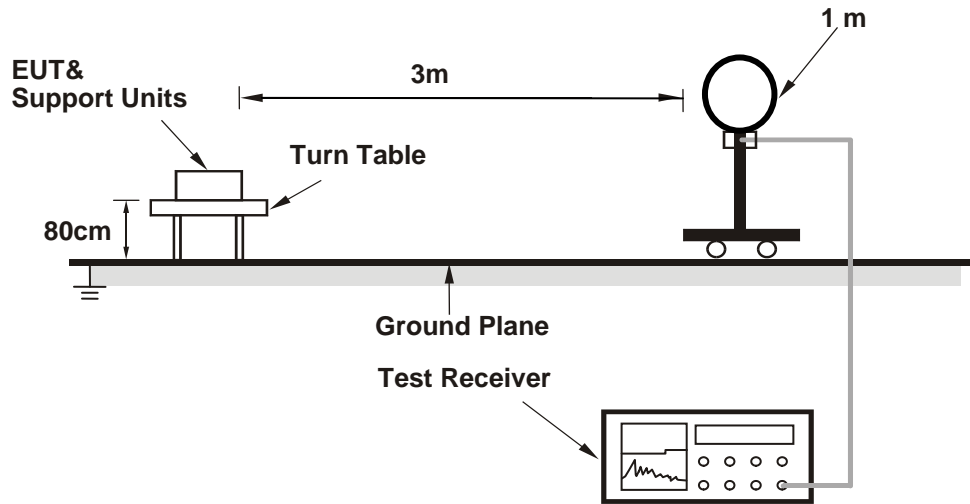

##### For Radiated emission 30MHz to 1GHz

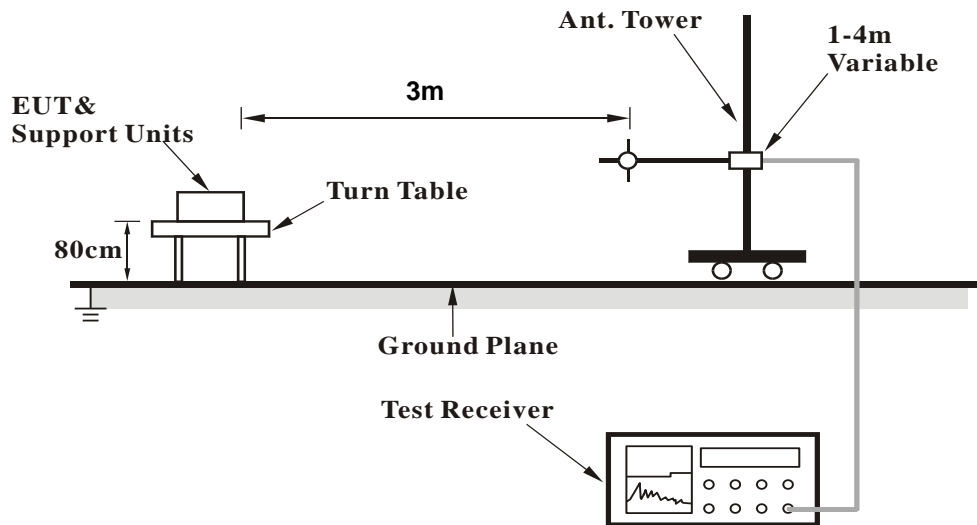

### For Radiated emission above 1GHz

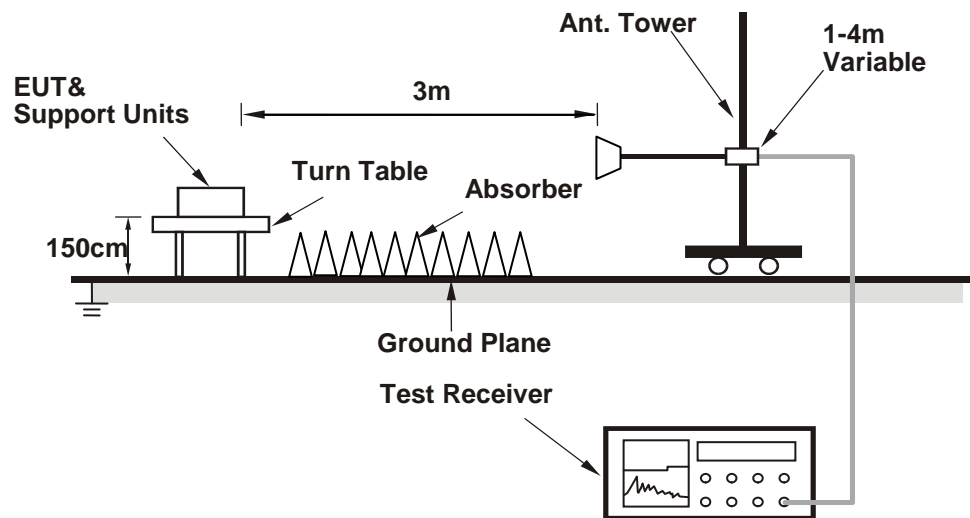

For the actual test configuration, please refer to the attached file (Test Setup Photo).

#### 4.1.6 EUT Operating Condition

- a. Connected the EUT with the Laptop which is placed on remote site.
- b. Controlling software (QDART-Connectivity100039.exe) has been activated to set the EUT on specific status.



4.1.7 Test Results (Mode 1)

Above 1GHz Data:

802.11a

<b>CHANNEL</b>	TX Channel 36	<b>DETECTOR FUNCTION</b>	Peak (PK)
<b>FREQUENCY RANGE</b>	1GHz ~ 40GHz		Average (AV)

**ANTENNA POLARITY & TEST DISTANCE: HORIZONTAL AT 3 M**

NO.	FREQ. (MHz)	EMISSION LEVEL (dBuV/m)	LIMIT (dBuV/m)	MARGIN (dB)	ANTENNA HEIGHT (m)	TABLE ANGLE (Degree)	RAW VALUE (dBuV)	CORRECTION FACTOR (dB/m)
1	5150.00	64.3 PK	74.0	-9.7	2.26 H	125	60.6	3.7
2	5150.00	51.8 AV	54.0	-2.2	2.26 H	125	48.1	3.7
3	*5180.00	112.0 PK			2.26 H	125	108.3	3.7
4	*5180.00	101.4 AV			2.26 H	125	97.7	3.7
5	#10360.00	46.9 PK	74.0	-27.1	1.75 H	302	33.9	13.0
6	#10360.00	34.6 AV	54.0	-19.4	1.75 H	302	21.6	13.0
7	15540.00	45.0 PK	74.0	-29.0	1.65 H	317	31.9	13.1
8	15540.00	32.6 AV	54.0	-21.4	1.65 H	317	19.5	13.1

**ANTENNA POLARITY & TEST DISTANCE: VERTICAL AT 3 M**

NO.	FREQ. (MHz)	EMISSION LEVEL (dBuV/m)	LIMIT (dBuV/m)	MARGIN (dB)	ANTENNA HEIGHT (m)	TABLE ANGLE (Degree)	RAW VALUE (dBuV)	CORRECTION FACTOR (dB/m)
1	5150.00	66.7 PK	74.0	-7.3	2.17 V	330	63.0	3.7
2	5150.00	53.8 AV	54.0	-0.2	2.17 V	330	50.1	3.7
3	*5180.00	118.6 PK			2.17 V	330	114.9	3.7
4	*5180.00	106.5 AV			2.17 V	330	102.8	3.7
5	#10360.00	48.5 PK	74.0	-25.5	1.98 V	319	35.5	13.0
6	#10360.00	36.6 AV	54.0	-17.4	1.98 V	319	23.6	13.0
7	15540.00	45.2 PK	74.0	-28.8	1.68 V	214	32.1	13.1
8	15540.00	32.9 AV	54.0	-21.1	1.68 V	214	19.8	13.1

**REMARKS:**

1. Emission Level(dBuV/m) = Raw Value(dBuV) + Correction Factor(dB/m)
2. Correction Factor(dB/m) = Antenna Factor(dB/m) + Cable Factor(dB) – Pre-Amplifier Factor(dB)
3. The other emission levels were very low against the limit.
4. Margin value = Emission Level – Limit value
5. " \* ": Fundamental frequency.
6. " # ": The radiated frequency is out of the restricted band.

<b>CHANNEL</b>	TX Channel 40	<b>DETECTOR FUNCTION</b>	Peak (PK)
<b>FREQUENCY RANGE</b>	1GHz ~ 40GHz		Average (AV)

**ANTENNA POLARITY & TEST DISTANCE: HORIZONTAL AT 3 M**

NO.	FREQ. (MHz)	EMISSION LEVEL (dBuV/m)	LIMIT (dBuV/m)	MARGIN (dB)	ANTENNA HEIGHT (m)	TABLE ANGLE (Degree)	RAW VALUE (dBuV)	CORRECTION FACTOR (dB/m)
1	5150.00	61.7 PK	74.0	-12.3	2.36 H	122	58.0	3.7
2	5150.00	48.5 AV	54.0	-5.5	2.36 H	122	44.8	3.7
3	*5200.00	112.6 PK			2.36 H	122	108.9	3.7
4	*5200.00	103.0 AV			2.36 H	122	99.3	3.7
5	5350.00	47.2 PK	74.0	-26.8	2.36 H	122	43.1	4.1
6	5350.00	36.6 AV	54.0	-17.4	2.36 H	122	32.5	4.1
7	#10400.00	49.0 PK	74.0	-25.0	1.76 H	301	36.0	13.0
8	#10400.00	36.6 AV	54.0	-17.4	1.76 H	301	23.6	13.0
9	15600.00	46.7 PK	74.0	-27.3	1.63 H	306	33.4	13.3
10	15600.00	34.3 AV	54.0	-19.7	1.63 H	306	21.0	13.3

**ANTENNA POLARITY & TEST DISTANCE: VERTICAL AT 3 M**

NO.	FREQ. (MHz)	EMISSION LEVEL (dBuV/m)	LIMIT (dBuV/m)	MARGIN (dB)	ANTENNA HEIGHT (m)	TABLE ANGLE (Degree)	RAW VALUE (dBuV)	CORRECTION FACTOR (dB/m)
1	5150.00	64.5 PK	74.0	-9.5	2.35 V	331	60.8	3.7
2	5150.00	50.9 AV	54.0	-3.1	2.35 V	331	47.2	3.7
3	*5200.00	119.2 PK			2.35 V	331	115.5	3.7
4	*5200.00	108.0 AV			2.35 V	331	104.3	3.7
5	5350.00	49.8 PK	74.0	-24.2	2.35 V	331	45.7	4.1
6	5350.00	38.5 AV	54.0	-15.5	2.35 V	331	34.4	4.1
7	#10400.00	50.7 PK	74.0	-23.3	2.02 V	324	37.7	13.0
8	#10400.00	38.9 AV	54.0	-15.1	2.02 V	324	25.9	13.0
9	15600.00	47.5 PK	74.0	-26.5	1.70 V	216	34.2	13.3
10	15600.00	35.2 AV	54.0	-18.8	1.70 V	216	21.9	13.3

**REMARKS:**

1. Emission Level(dBuV/m) = Raw Value(dBuV) + Correction Factor(dB/m)
2. Correction Factor(dB/m) = Antenna Factor(dB/m) + Cable Factor(dB) – Pre-Amplifier Factor(dB)
3. The other emission levels were very low against the limit.
4. Margin value = Emission Level – Limit value
5. " \* ": Fundamental frequency.
6. " # ": The radiated frequency is out of the restricted band.

<b>CHANNEL</b>	TX Channel 48	<b>DETECTOR FUNCTION</b>	Peak (PK)
<b>FREQUENCY RANGE</b>	1GHz ~ 40GHz		Average (AV)

**ANTENNA POLARITY & TEST DISTANCE: HORIZONTAL AT 3 M**

NO.	FREQ. (MHz)	EMISSION LEVEL (dBuV/m)	LIMIT (dBuV/m)	MARGIN (dB)	ANTENNA HEIGHT (m)	TABLE ANGLE (Degree)	RAW VALUE (dBuV)	CORRECTION FACTOR (dB/m)
1	*5240.00	112.7 PK			2.31 H	119	108.9	3.8
2	*5240.00	103.1 AV			2.31 H	119	99.3	3.8
3	5350.00	47.5 PK	74.0	-26.5	2.31 H	119	43.4	4.1
4	5350.00	35.7 AV	54.0	-18.3	2.31 H	119	31.6	4.1
5	#10480.00	49.5 PK	74.0	-24.5	1.76 H	290	36.3	13.2
6	#10480.00	36.9 AV	54.0	-17.1	1.76 H	290	23.7	13.2
7	15720.00	46.9 PK	74.0	-27.1	1.62 H	311	33.3	13.6
8	15720.00	34.4 AV	54.0	-19.6	1.62 H	311	20.8	13.6

**ANTENNA POLARITY & TEST DISTANCE: VERTICAL AT 3 M**

NO.	FREQ. (MHz)	EMISSION LEVEL (dBuV/m)	LIMIT (dBuV/m)	MARGIN (dB)	ANTENNA HEIGHT (m)	TABLE ANGLE (Degree)	RAW VALUE (dBuV)	CORRECTION FACTOR (dB/m)
1	*5240.00	119.3 PK			2.26 V	329	115.5	3.8
2	*5240.00	108.1 AV			2.26 V	329	104.3	3.8
3	5350.00	50.5 PK	74.0	-23.5	2.26 V	329	46.4	4.1
4	5350.00	37.9 AV	54.0	-16.1	2.26 V	329	33.8	4.1
5	#10480.00	50.9 PK	74.0	-23.1	2.05 V	317	37.7	13.2
6	#10480.00	38.9 AV	54.0	-15.1	2.05 V	317	25.7	13.2
7	15720.00	47.4 PK	74.0	-26.6	1.66 V	222	33.8	13.6
8	15720.00	35.0 AV	54.0	-19.0	1.66 V	222	21.4	13.6

**REMARKS:**

1. Emission Level(dBuV/m) = Raw Value(dBuV) + Correction Factor(dB/m)
2. Correction Factor(dB/m) = Antenna Factor(dB/m) + Cable Factor(dB) – Pre-Amplifier Factor(dB)
3. The other emission levels were very low against the limit.
4. Margin value = Emission Level – Limit value
5. " \* ": Fundamental frequency.
6. " # ": The radiated frequency is out of the restricted band.

<b>CHANNEL</b>	TX Channel 149	<b>DETECTOR FUNCTION</b>	Peak (PK)
<b>FREQUENCY RANGE</b>	1GHz ~ 40GHz		Average (AV)

**ANTENNA POLARITY & TEST DISTANCE: HORIZONTAL AT 3 M**

NO.	FREQ. (MHz)	EMISSION LEVEL (dBuV/m)	LIMIT (dBuV/m)	MARGIN (dB)	ANTENNA HEIGHT (m)	TABLE ANGLE (Degree)	RAW VALUE (dBuV)	CORRECTION FACTOR (dB/m)
1	#5647.17	56.8 PK	68.2	-11.4	1.25 H	173	52.4	4.4
2	*5745.00	116.6 PK			1.25 H	173	112.2	4.4
3	*5745.00	103.7 AV			1.25 H	173	99.3	4.4
4	#5981.64	52.1 PK	68.2	-16.1	1.25 H	173	47.4	4.7
5	11490.00	52.4 PK	74.0	-21.6	1.72 H	304	38.9	13.5
6	11490.00	42.1 AV	54.0	-11.9	1.72 H	304	28.6	13.5
7	#17235.00	49.2 PK	74.0	-24.8	1.70 H	355	31.9	17.3
8	#17235.00	36.2 AV	54.0	-17.8	1.70 H	355	18.9	17.3

**ANTENNA POLARITY & TEST DISTANCE: VERTICAL AT 3 M**

NO.	FREQ. (MHz)	EMISSION LEVEL (dBuV/m)	LIMIT (dBuV/m)	MARGIN (dB)	ANTENNA HEIGHT (m)	TABLE ANGLE (Degree)	RAW VALUE (dBuV)	CORRECTION FACTOR (dB/m)
1	#5637.15	64.5 PK	68.2	-3.7	2.20 V	360	60.1	4.4
2	*5745.00	121.5 PK			2.20 V	360	117.1	4.4
3	*5745.00	110.1 AV			2.20 V	360	105.7	4.4
4	#5983.69	56.2 PK	68.2	-12.0	2.20 V	360	51.5	4.7
5	11490.00	54.4 PK	74.0	-19.6	1.98 V	326	40.9	13.5
6	11490.00	44.3 AV	54.0	-9.7	1.98 V	326	30.8	13.5
7	#17235.00	50.2 PK	74.0	-23.8	1.65 V	122	32.9	17.3
8	#17235.00	37.7 AV	54.0	-16.3	1.65 V	122	20.4	17.3

**REMARKS:**

1. Emission Level(dBuV/m) = Raw Value(dBuV) + Correction Factor(dB/m)
2. Correction Factor(dB/m) = Antenna Factor(dB/m) + Cable Factor(dB) – Pre-Amplifier Factor(dB)
3. The other emission levels were very low against the limit.
4. Margin value = Emission Level – Limit value
5. " \* ": Fundamental frequency.
6. " # ": The radiated frequency is out of the restricted band.

<b>CHANNEL</b>	TX Channel 157	<b>DETECTOR FUNCTION</b>	Peak (PK)
<b>FREQUENCY RANGE</b>	1GHz ~ 40GHz		Average (AV)

**ANTENNA POLARITY & TEST DISTANCE: HORIZONTAL AT 3 M**

NO.	FREQ. (MHz)	EMISSION LEVEL (dBuV/m)	LIMIT (dBuV/m)	MARGIN (dB)	ANTENNA HEIGHT (m)	TABLE ANGLE (Degree)	RAW VALUE (dBuV)	CORRECTION FACTOR (dB/m)
1	#5660.03	54.7 PK	75.6	-20.9	1.17 H	151	50.4	4.3
2	*5785.00	116.2 PK			1.17 H	151	111.8	4.4
3	*5785.00	103.4 AV			1.17 H	151	99.0	4.4
4	#5950.31	52.3 PK	68.2	-15.9	1.17 H	151	47.6	4.7
5	11570.00	52.5 PK	74.0	-21.5	1.71 H	316	39.0	13.5
6	11570.00	42.4 AV	54.0	-11.6	1.71 H	316	28.9	13.5
7	#17355.00	48.9 PK	74.0	-25.1	1.66 H	341	30.9	18.0
8	#17355.00	35.9 AV	54.0	-18.1	1.66 H	341	17.9	18.0

**ANTENNA POLARITY & TEST DISTANCE: VERTICAL AT 3 M**

NO.	FREQ. (MHz)	EMISSION LEVEL (dBuV/m)	LIMIT (dBuV/m)	MARGIN (dB)	ANTENNA HEIGHT (m)	TABLE ANGLE (Degree)	RAW VALUE (dBuV)	CORRECTION FACTOR (dB/m)
1	#5599.84	57.3 PK	68.2	-10.9	2.27 V	360	52.9	4.4
2	*5785.00	122.6 PK			2.27 V	360	118.2	4.4
3	*5785.00	110.8 AV			2.27 V	360	106.4	4.4
4	#5938.97	56.3 PK	68.2	-11.9	2.27 V	360	51.6	4.7
5	11570.00	54.3 PK	74.0	-19.7	2.03 V	338	40.8	13.5
6	11570.00	44.2 AV	54.0	-9.8	2.03 V	338	30.7	13.5
7	#17355.00	50.4 PK	74.0	-23.6	1.60 V	118	32.4	18.0
8	#17355.00	37.7 AV	54.0	-16.3	1.60 V	118	19.7	18.0

**REMARKS:**

1. Emission Level(dBuV/m) = Raw Value(dBuV) + Correction Factor(dB/m)
2. Correction Factor(dB/m) = Antenna Factor(dB/m) + Cable Factor(dB) – Pre-Amplifier Factor(dB)
3. The other emission levels were very low against the limit.
4. Margin value = Emission Level – Limit value
5. " \* ": Fundamental frequency.
6. " # ": The radiated frequency is out of the restricted band.

<b>CHANNEL</b>	TX Channel 165	<b>DETECTOR FUNCTION</b>	Peak (PK)
<b>FREQUENCY RANGE</b>	1GHz ~ 40GHz		Average (AV)

**ANTENNA POLARITY & TEST DISTANCE: HORIZONTAL AT 3 M**

NO.	FREQ. (MHz)	EMISSION LEVEL (dBuV/m)	LIMIT (dBuV/m)	MARGIN (dB)	ANTENNA HEIGHT (m)	TABLE ANGLE (Degree)	RAW VALUE (dBuV)	CORRECTION FACTOR (dB/m)
1	#5606.34	51.7 PK	68.2	-16.5	1.22 H	162	47.3	4.4
2	*5825.00	116.8 PK			1.22 H	162	112.4	4.4
3	*5825.00	103.9 AV			1.22 H	162	99.5	4.4
4	#5969.86	51.0 PK	68.2	-17.2	1.22 H	162	46.3	4.7
5	11650.00	52.7 PK	74.0	-21.3	1.73 H	317	39.0	13.7
6	11650.00	42.4 AV	54.0	-11.6	1.73 H	317	28.7	13.7
7	#17475.00	49.5 PK	74.0	-24.5	1.67 H	345	30.9	18.6
8	#17475.00	36.3 AV	54.0	-17.7	1.67 H	345	17.7	18.6

**ANTENNA POLARITY & TEST DISTANCE: VERTICAL AT 3 M**

NO.	FREQ. (MHz)	EMISSION LEVEL (dBuV/m)	LIMIT (dBuV/m)	MARGIN (dB)	ANTENNA HEIGHT (m)	TABLE ANGLE (Degree)	RAW VALUE (dBuV)	CORRECTION FACTOR (dB/m)
1	#5651.36	57.3 PK	69.2	-11.9	2.27 V	360	53.0	4.3
2	*5825.00	122.1 PK			2.27 V	360	117.7	4.4
3	*5825.00	110.2 AV			2.27 V	360	105.8	4.4
4	#5927.73	57.3 PK	68.2	-10.9	2.27 V	360	52.6	4.7
5	11650.00	54.7 PK	74.0	-19.3	2.00 V	325	41.0	13.7
6	11650.00	44.6 AV	54.0	-9.4	2.00 V	325	30.9	13.7
7	#17475.00	50.2 PK	74.0	-23.8	1.64 V	131	31.6	18.6
8	#17475.00	37.8 AV	54.0	-16.2	1.64 V	131	19.2	18.6

**REMARKS:**

- Emission Level(dBuV/m) = Raw Value(dBuV) + Correction Factor(dB/m)
- Correction Factor(dB/m) = Antenna Factor(dB/m) + Cable Factor(dB) – Pre-Amplifier Factor(dB)
- The other emission levels were very low against the limit.
- Margin value = Emission Level – Limit value
- " \* ": Fundamental frequency.
- " # ": The radiated frequency is out of the restricted band.

**802.11ac (VHT20)**

<b>CHANNEL</b>	TX Channel 36	<b>DETECTOR FUNCTION</b>	Peak (PK)
<b>FREQUENCY RANGE</b>	1GHz ~ 40GHz		Average (AV)

**ANTENNA POLARITY & TEST DISTANCE: HORIZONTAL AT 3 M**

NO.	FREQ. (MHz)	EMISSION LEVEL (dBuV/m)	LIMIT (dBuV/m)	MARGIN (dB)	ANTENNA HEIGHT (m)	TABLE ANGLE (Degree)	RAW VALUE (dBuV)	CORRECTION FACTOR (dB/m)
1	5150.00	64.5 PK	74.0	-9.5	2.30 H	121	60.8	3.7
2	5150.00	52.0 AV	54.0	-2.0	2.30 H	121	48.3	3.7
3	*5180.00	111.6 PK			2.30 H	121	107.9	3.7
4	*5180.00	101.1 AV			2.30 H	121	97.4	3.7
5	#10360.00	48.4 PK	74.0	-25.6	1.76 H	291	35.4	13.0
6	#10360.00	36.2 AV	54.0	-17.8	1.76 H	291	23.2	13.0
7	15540.00	46.8 PK	74.0	-27.2	1.63 H	296	33.7	13.1
8	15540.00	34.3 AV	54.0	-19.7	1.63 H	296	21.2	13.1

**ANTENNA POLARITY & TEST DISTANCE: VERTICAL AT 3 M**

NO.	FREQ. (MHz)	EMISSION LEVEL (dBuV/m)	LIMIT (dBuV/m)	MARGIN (dB)	ANTENNA HEIGHT (m)	TABLE ANGLE (Degree)	RAW VALUE (dBuV)	CORRECTION FACTOR (dB/m)
1	5150.00	63.4 PK	74.0	-10.6	2.60 V	199	59.7	3.7
2	5150.00	53.5 AV	54.0	-0.5	2.60 V	199	49.8	3.7
3	*5180.00	115.8 PK			2.60 V	199	112.1	3.7
4	*5180.00	105.5 AV			2.60 V	199	101.8	3.7
5	#10360.00	48.3 PK	74.0	-25.7	2.02 V	328	35.3	13.0
6	#10360.00	36.6 AV	54.0	-17.4	2.02 V	328	23.6	13.0
7	15540.00	45.1 PK	74.0	-28.9	1.64 V	211	32.0	13.1
8	15540.00	32.8 AV	54.0	-21.2	1.64 V	211	19.7	13.1

**REMARKS:**

- Emission Level(dBuV/m) = Raw Value(dBuV) + Correction Factor(dB/m)
- Correction Factor(dB/m) = Antenna Factor(dB/m) + Cable Factor(dB) – Pre-Amplifier Factor(dB)
- The other emission levels were very low against the limit.
- Margin value = Emission Level – Limit value
- " \* ": Fundamental frequency.
- " # ": The radiated frequency is out of the restricted band.

<b>CHANNEL</b>	TX Channel 40	<b>DETECTOR FUNCTION</b>	Peak (PK)
<b>FREQUENCY RANGE</b>	1GHz ~ 40GHz		Average (AV)

**ANTENNA POLARITY & TEST DISTANCE: HORIZONTAL AT 3 M**

NO.	FREQ. (MHz)	EMISSION LEVEL (dBuV/m)	LIMIT (dBuV/m)	MARGIN (dB)	ANTENNA HEIGHT (m)	TABLE ANGLE (Degree)	RAW VALUE (dBuV)	CORRECTION FACTOR (dB/m)
1	5150.00	61.9 PK	74.0	-12.1	2.37 H	118	58.2	3.7
2	5150.00	48.6 AV	54.0	-5.4	2.37 H	118	44.9	3.7
3	*5200.00	112.8 PK			2.37 H	118	109.1	3.7
4	*5200.00	103.4 AV			2.37 H	118	99.7	3.7
5	5350.00	47.2 PK	74.0	-26.8	2.37 H	118	43.1	4.1
6	5350.00	36.5 AV	54.0	-17.5	2.37 H	118	32.4	4.1
7	#10400.00	48.7 PK	74.0	-25.3	1.74 H	315	35.7	13.0
8	#10400.00	36.1 AV	54.0	-17.9	1.74 H	315	23.1	13.0
9	15600.00	47.2 PK	74.0	-26.8	1.66 H	301	33.9	13.3
10	15600.00	34.7 AV	54.0	-19.3	1.66 H	301	21.4	13.3

**ANTENNA POLARITY & TEST DISTANCE: VERTICAL AT 3 M**

NO.	FREQ. (MHz)	EMISSION LEVEL (dBuV/m)	LIMIT (dBuV/m)	MARGIN (dB)	ANTENNA HEIGHT (m)	TABLE ANGLE (Degree)	RAW VALUE (dBuV)	CORRECTION FACTOR (dB/m)
1	5150.00	67.6 PK	74.0	-6.4	2.59 V	198	63.9	3.7
2	5150.00	53.6 AV	54.0	-0.4	2.59 V	198	49.9	3.7
3	*5200.00	119.7 PK			2.59 V	198	116.0	3.7
4	*5200.00	108.6 AV			2.59 V	198	104.9	3.7
5	5350.00	50.2 PK	74.0	-23.8	2.59 V	198	46.1	4.1
6	5350.00	37.1 AV	54.0	-16.9	2.59 V	198	33.0	4.1
7	#10400.00	48.9 PK	74.0	-25.1	1.99 V	312	35.9	13.0
8	#10400.00	36.8 AV	54.0	-17.2	1.99 V	312	23.8	13.0
9	15600.00	45.3 PK	74.0	-28.7	1.65 V	200	32.0	13.3
10	15600.00	33.0 AV	54.0	-21.0	1.65 V	200	19.7	13.3

**REMARKS:**

1. Emission Level(dBuV/m) = Raw Value(dBuV) + Correction Factor(dB/m)
2. Correction Factor(dB/m) = Antenna Factor(dB/m) + Cable Factor(dB) – Pre-Amplifier Factor(dB)
3. The other emission levels were very low against the limit.
4. Margin value = Emission Level – Limit value
5. " \* ": Fundamental frequency.
6. " # ": The radiated frequency is out of the restricted band.



<b>CHANNEL</b>	TX Channel 48	<b>DETECTOR FUNCTION</b>	Peak (PK)
<b>FREQUENCY RANGE</b>	1GHz ~ 40GHz		Average (AV)

**ANTENNA POLARITY & TEST DISTANCE: HORIZONTAL AT 3 M**

NO.	FREQ. (MHz)	EMISSION LEVEL (dBuV/m)	LIMIT (dBuV/m)	MARGIN (dB)	ANTENNA HEIGHT (m)	TABLE ANGLE (Degree)	RAW VALUE (dBuV)	CORRECTION FACTOR (dB/m)
1	*5240.00	112.8 PK			2.42 H	123	109.0	3.8
2	*5240.00	103.2 AV			2.42 H	123	99.4	3.8
3	5350.00	47.6 PK	74.0	-26.4	2.42 H	123	43.5	4.1
4	5350.00	35.9 AV	54.0	-18.1	2.42 H	123	31.8	4.1
5	#10480.00	49.2 PK	74.0	-24.8	1.77 H	290	36.0	13.2
6	#10480.00	37.0 AV	54.0	-17.0	1.77 H	290	23.8	13.2
7	15720.00	46.3 PK	74.0	-27.7	1.64 H	305	32.7	13.6
8	15720.00	33.9 AV	54.0	-20.1	1.64 H	305	20.3	13.6

**ANTENNA POLARITY & TEST DISTANCE: VERTICAL AT 3 M**

NO.	FREQ. (MHz)	EMISSION LEVEL (dBuV/m)	LIMIT (dBuV/m)	MARGIN (dB)	ANTENNA HEIGHT (m)	TABLE ANGLE (Degree)	RAW VALUE (dBuV)	CORRECTION FACTOR (dB/m)
1	*5240.00	119.9 PK			2.43 V	197	116.1	3.8
2	*5240.00	108.5 AV			2.43 V	197	104.7	3.8
3	5350.00	50.2 PK	74.0	-23.8	2.43 V	197	46.1	4.1
4	5350.00	37.6 AV	54.0	-16.4	2.43 V	197	33.5	4.1
5	#10480.00	49.0 PK	74.0	-25.0	2.01 V	306	35.8	13.2
6	#10480.00	36.9 AV	54.0	-17.1	2.01 V	306	23.7	13.2
7	15720.00	45.4 PK	74.0	-28.6	1.73 V	223	31.8	13.6
8	15720.00	33.4 AV	54.0	-20.6	1.73 V	223	19.8	13.6

**REMARKS:**

1. Emission Level(dBuV/m) = Raw Value(dBuV) + Correction Factor(dB/m)
2. Correction Factor(dB/m) = Antenna Factor(dB/m) + Cable Factor(dB) – Pre-Amplifier Factor(dB)
3. The other emission levels were very low against the limit.
4. Margin value = Emission Level – Limit value
5. " \* ": Fundamental frequency.
6. " # ": The radiated frequency is out of the restricted band.

<b>CHANNEL</b>	TX Channel 149	<b>DETECTOR FUNCTION</b>	Peak (PK)
<b>FREQUENCY RANGE</b>	1GHz ~ 40GHz		Average (AV)

**ANTENNA POLARITY & TEST DISTANCE: HORIZONTAL AT 3 M**

NO.	FREQ. (MHz)	EMISSION LEVEL (dBuV/m)	LIMIT (dBuV/m)	MARGIN (dB)	ANTENNA HEIGHT (m)	TABLE ANGLE (Degree)	RAW VALUE (dBuV)	CORRECTION FACTOR (dB/m)
1	#5652.05	58.2 PK	69.7	-11.5	1.29 H	164	53.9	4.3
2	*5745.00	113.9 PK			1.29 H	164	109.5	4.4
3	*5745.00	103.4 AV			1.29 H	164	99.0	4.4
4	#5949.07	52.0 PK	68.2	-16.2	1.29 H	164	47.3	4.7
5	11490.00	52.5 PK	74.0	-21.5	1.70 H	292	39.0	13.5
6	11490.00	42.4 AV	54.0	-11.6	1.70 H	292	28.9	13.5
7	#17235.00	48.8 PK	74.0	-25.2	1.73 H	360	31.5	17.3
8	#17235.00	35.8 AV	54.0	-18.2	1.73 H	360	18.5	17.3

**ANTENNA POLARITY & TEST DISTANCE: VERTICAL AT 3 M**

NO.	FREQ. (MHz)	EMISSION LEVEL (dBuV/m)	LIMIT (dBuV/m)	MARGIN (dB)	ANTENNA HEIGHT (m)	TABLE ANGLE (Degree)	RAW VALUE (dBuV)	CORRECTION FACTOR (dB/m)
1	#5648.99	63.5 PK	68.2	-4.7	2.56 V	360	59.1	4.4
2	*5745.00	120.8 PK			2.56 V	360	116.4	4.4
3	*5745.00	110.2 AV			2.56 V	360	105.8	4.4
4	#5939.65	56.2 PK	68.2	-12.0	2.56 V	360	51.5	4.7
5	11490.00	54.2 PK	74.0	-19.8	1.96 V	335	40.7	13.5
6	11490.00	43.9 AV	54.0	-10.1	1.96 V	335	30.4	13.5
7	#17235.00	50.3 PK	74.0	-23.7	1.60 V	107	33.0	17.3
8	#17235.00	37.7 AV	54.0	-16.3	1.60 V	107	20.4	17.3

**REMARKS:**

1. Emission Level(dBuV/m) = Raw Value(dBuV) + Correction Factor(dB/m)
2. Correction Factor(dB/m) = Antenna Factor(dB/m) + Cable Factor(dB) – Pre-Amplifier Factor(dB)
3. The other emission levels were very low against the limit.
4. Margin value = Emission Level – Limit value
5. " \* ": Fundamental frequency.
6. " # ": The radiated frequency is out of the restricted band.

<b>CHANNEL</b>	TX Channel 157	<b>DETECTOR FUNCTION</b>	Peak (PK)
<b>FREQUENCY RANGE</b>	1GHz ~ 40GHz		Average (AV)

**ANTENNA POLARITY & TEST DISTANCE: HORIZONTAL AT 3 M**

NO.	FREQ. (MHz)	EMISSION LEVEL (dBuV/m)	LIMIT (dBuV/m)	MARGIN (dB)	ANTENNA HEIGHT (m)	TABLE ANGLE (Degree)	RAW VALUE (dBuV)	CORRECTION FACTOR (dB/m)
1	#5631.57	52.7 PK	68.2	-15.5	1.30 H	165	48.3	4.4
2	*5785.00	114.3 PK			1.30 H	165	109.9	4.4
3	*5785.00	103.6 AV			1.30 H	165	99.2	4.4
4	#5928.82	52.4 PK	68.2	-15.8	1.30 H	165	47.7	4.7
5	11570.00	52.7 PK	74.0	-21.3	1.75 H	309	39.2	13.5
6	11570.00	42.3 AV	54.0	-11.7	1.75 H	309	28.8	13.5
7	#17355.00	49.1 PK	74.0	-24.9	1.68 H	351	31.1	18.0
8	#17355.00	36.0 AV	54.0	-18.0	1.68 H	351	18.0	18.0

**ANTENNA POLARITY & TEST DISTANCE: VERTICAL AT 3 M**

NO.	FREQ. (MHz)	EMISSION LEVEL (dBuV/m)	LIMIT (dBuV/m)	MARGIN (dB)	ANTENNA HEIGHT (m)	TABLE ANGLE (Degree)	RAW VALUE (dBuV)	CORRECTION FACTOR (dB/m)
1	#5642.71	56.6 PK	68.2	-11.6	2.57 V	360	52.2	4.4
2	*5785.00	121.2 PK			2.57 V	360	116.8	4.4
3	*5785.00	110.6 AV			2.57 V	360	106.2	4.4
4	#6018.55	56.2 PK	68.2	-12.0	2.57 V	360	51.4	4.8
5	11570.00	54.5 PK	74.0	-19.5	2.01 V	323	41.0	13.5
6	11570.00	44.4 AV	54.0	-9.6	2.01 V	323	30.9	13.5
7	#17355.00	50.7 PK	74.0	-23.3	1.71 V	106	32.7	18.0
8	#17355.00	38.0 AV	54.0	-16.0	1.71 V	106	20.0	18.0

**REMARKS:**

1. Emission Level(dBuV/m) = Raw Value(dBuV) + Correction Factor(dB/m)
2. Correction Factor(dB/m) = Antenna Factor(dB/m) + Cable Factor(dB) – Pre-Amplifier Factor(dB)
3. The other emission levels were very low against the limit.
4. Margin value = Emission Level – Limit value
5. " \* ": Fundamental frequency.
6. " # ": The radiated frequency is out of the restricted band.

<b>CHANNEL</b>	TX Channel 165	<b>DETECTOR FUNCTION</b>	Peak (PK)
<b>FREQUENCY RANGE</b>	1GHz ~ 40GHz		Average (AV)

**ANTENNA POLARITY & TEST DISTANCE: HORIZONTAL AT 3 M**

NO.	FREQ. (MHz)	EMISSION LEVEL (dBuV/m)	LIMIT (dBuV/m)	MARGIN (dB)	ANTENNA HEIGHT (m)	TABLE ANGLE (Degree)	RAW VALUE (dBuV)	CORRECTION FACTOR (dB/m)
1	#5599.35	52.8 PK	68.2	-15.4	1.29 H	159	48.4	4.4
2	*5825.00	114.4 PK			1.29 H	159	110.0	4.4
3	*5825.00	103.7 AV			1.29 H	159	99.3	4.4
4	#5958.87	52.6 PK	68.2	-15.6	1.29 H	159	47.9	4.7
5	11650.00	52.3 PK	74.0	-21.7	1.77 H	311	38.6	13.7
6	11650.00	42.2 AV	54.0	-11.8	1.77 H	311	28.5	13.7
7	#17475.00	49.3 PK	74.0	-24.7	1.75 H	350	30.7	18.6
8	#17475.00	36.4 AV	54.0	-17.6	1.75 H	350	17.8	18.6

**ANTENNA POLARITY & TEST DISTANCE: VERTICAL AT 3 M**

NO.	FREQ. (MHz)	EMISSION LEVEL (dBuV/m)	LIMIT (dBuV/m)	MARGIN (dB)	ANTENNA HEIGHT (m)	TABLE ANGLE (Degree)	RAW VALUE (dBuV)	CORRECTION FACTOR (dB/m)
1	#5598.31	57.6 PK	68.2	-10.6	2.51 V	360	53.2	4.4
2	*5825.00	121.1 PK			2.51 V	360	116.7	4.4
3	*5825.00	110.5 AV			2.51 V	360	106.1	4.4
4	#5992.38	57.6 PK	68.2	-10.6	2.51 V	360	52.9	4.7
5	11650.00	54.0 PK	74.0	-20.0	1.96 V	328	40.3	13.7
6	11650.00	43.9 AV	54.0	-10.1	1.96 V	328	30.2	13.7
7	#17475.00	50.1 PK	74.0	-23.9	1.60 V	126	31.5	18.6
8	#17475.00	37.4 AV	54.0	-16.6	1.60 V	126	18.8	18.6

**REMARKS:**

1. Emission Level(dBuV/m) = Raw Value(dBuV) + Correction Factor(dB/m)
2. Correction Factor(dB/m) = Antenna Factor(dB/m) + Cable Factor(dB) – Pre-Amplifier Factor(dB)
3. The other emission levels were very low against the limit.
4. Margin value = Emission Level – Limit value
5. " \* ": Fundamental frequency.
6. " # ": The radiated frequency is out of the restricted band.

802.11ac (VHT40)

<b>CHANNEL</b>	TX Channel 38	<b>DETECTOR FUNCTION</b>	Peak (PK)
<b>FREQUENCY RANGE</b>	1GHz ~ 40GHz		Average (AV)

ANTENNA POLARITY & TEST DISTANCE: HORIZONTAL AT 3 M								
NO.	FREQ. (MHz)	EMISSION LEVEL (dBuV/m)	LIMIT (dBuV/m)	MARGIN (dB)	ANTENNA HEIGHT (m)	TABLE ANGLE (Degree)	RAW VALUE (dBuV)	CORRECTION FACTOR (dB/m)
1	5150.00	61.7 PK	74.0	-12.3	2.37 H	134	58.0	3.7
2	5150.00	48.3 AV	54.0	-5.7	2.37 H	134	44.6	3.7
3	*5190.00	108.0 PK			2.37 H	134	104.3	3.7
4	*5190.00	96.8 AV			2.37 H	134	93.1	3.7
5	5350.00	46.8 PK	74.0	-27.2	2.37 H	134	42.7	4.1
6	5350.00	36.2 AV	54.0	-17.8	2.37 H	134	32.1	4.1
7	#10380.00	49.1 PK	74.0	-24.9	1.80 H	298	36.0	13.1
8	#10380.00	36.4 AV	54.0	-17.6	1.80 H	298	23.3	13.1
9	15570.00	46.9 PK	74.0	-27.1	1.65 H	322	33.6	13.3
10	15570.00	34.3 AV	54.0	-19.7	1.65 H	322	21.0	13.3

ANTENNA POLARITY & TEST DISTANCE: VERTICAL AT 3 M								
NO.	FREQ. (MHz)	EMISSION LEVEL (dBuV/m)	LIMIT (dBuV/m)	MARGIN (dB)	ANTENNA HEIGHT (m)	TABLE ANGLE (Degree)	RAW VALUE (dBuV)	CORRECTION FACTOR (dB/m)
1	5150.00	66.2 PK	74.0	-7.8	2.57 V	331	62.5	3.7
2	5150.00	53.6 AV	54.0	-0.4	2.57 V	331	49.9	3.7
3	*5190.00	114.0 PK			2.57 V	331	110.3	3.7
4	*5190.00	103.9 AV			2.57 V	331	100.2	3.7
5	5350.00	50.4 PK	74.0	-23.6	2.57 V	331	46.3	4.1
6	5350.00	38.2 AV	54.0	-15.8	2.57 V	331	34.1	4.1
7	#10380.00	47.9 PK	74.0	-26.1	2.03 V	322	34.8	13.1
8	#10380.00	36.1 AV	54.0	-17.9	2.03 V	322	23.0	13.1
9	15570.00	45.5 PK	74.0	-28.5	1.65 V	217	32.2	13.3
10	15570.00	33.1 AV	54.0	-20.9	1.65 V	217	19.8	13.3

**REMARKS:**

1. Emission Level(dBuV/m) = Raw Value(dBuV) + Correction Factor(dB/m)
2. Correction Factor(dB/m) = Antenna Factor(dB/m) + Cable Factor(dB) – Pre-Amplifier Factor(dB)
3. The other emission levels were very low against the limit.
4. Margin value = Emission Level – Limit value
5. " \* ": Fundamental frequency.
6. " # ": The radiated frequency is out of the restricted band.

<b>CHANNEL</b>	TX Channel 46	<b>DETECTOR FUNCTION</b>	Peak (PK)
<b>FREQUENCY RANGE</b>	1GHz ~ 40GHz		Average (AV)

**ANTENNA POLARITY & TEST DISTANCE: HORIZONTAL AT 3 M**

NO.	FREQ. (MHz)	EMISSION LEVEL (dBuV/m)	LIMIT (dBuV/m)	MARGIN (dB)	ANTENNA HEIGHT (m)	TABLE ANGLE (Degree)	RAW VALUE (dBuV)	CORRECTION FACTOR (dB/m)
1	5141.00	64.8 PK	74.0	-9.2	2.34 H	114	61.2	3.6
2	5141.00	52.3 AV	54.0	-1.7	2.34 H	114	48.7	3.6
3	*5230.00	112.4 PK			2.34 H	114	108.6	3.8
4	*5230.00	101.2 AV			2.34 H	114	97.4	3.8
5	5350.00	47.0 PK	74.0	-27.0	2.34 H	114	42.9	4.1
6	5350.00	36.3 AV	54.0	-17.7	2.34 H	114	32.2	4.1
7	#10460.00	48.3 PK	74.0	-25.7	1.81 H	292	35.2	13.1
8	#10460.00	36.1 AV	54.0	-17.9	1.81 H	292	23.0	13.1
9	15690.00	46.8 PK	74.0	-27.2	1.66 H	295	33.0	13.8
10	15690.00	34.3 AV	54.0	-19.7	1.66 H	295	20.5	13.8

**ANTENNA POLARITY & TEST DISTANCE: VERTICAL AT 3 M**

NO.	FREQ. (MHz)	EMISSION LEVEL (dBuV/m)	LIMIT (dBuV/m)	MARGIN (dB)	ANTENNA HEIGHT (m)	TABLE ANGLE (Degree)	RAW VALUE (dBuV)	CORRECTION FACTOR (dB/m)
1	5141.00	65.2 PK	74.0	-8.8	2.56 V	325	61.6	3.6
2	5141.00	53.6 AV	54.0	-0.4	2.56 V	325	50.0	3.6
3	*5230.00	117.8 PK			2.56 V	325	114.0	3.8
4	*5230.00	107.6 AV			2.56 V	325	103.8	3.8
5	5350.00	51.9 PK	74.0	-22.1	2.56 V	325	47.8	4.1
6	5350.00	40.2 AV	54.0	-13.8	2.56 V	325	36.1	4.1
7	#10460.00	49.0 PK	74.0	-25.0	1.99 V	317	35.9	13.1
8	#10460.00	37.1 AV	54.0	-16.9	1.99 V	317	24.0	13.1
9	15690.00	44.6 PK	74.0	-29.4	1.69 V	219	30.8	13.8
10	15690.00	32.5 AV	54.0	-21.5	1.69 V	219	18.7	13.8

**REMARKS:**

1. Emission Level(dBuV/m) = Raw Value(dBuV) + Correction Factor(dB/m)
2. Correction Factor(dB/m) = Antenna Factor(dB/m) + Cable Factor(dB) – Pre-Amplifier Factor(dB)
3. The other emission levels were very low against the limit.
4. Margin value = Emission Level – Limit value
5. " \* ": Fundamental frequency.
6. " # ": The radiated frequency is out of the restricted band.

<b>CHANNEL</b>	TX Channel 151	<b>DETECTOR FUNCTION</b>	Peak (PK)
<b>FREQUENCY RANGE</b>	1GHz ~ 40GHz		Average (AV)

**ANTENNA POLARITY & TEST DISTANCE: HORIZONTAL AT 3 M**

NO.	FREQ. (MHz)	EMISSION LEVEL (dBuV/m)	LIMIT (dBuV/m)	MARGIN (dB)	ANTENNA HEIGHT (m)	TABLE ANGLE (Degree)	RAW VALUE (dBuV)	CORRECTION FACTOR (dB/m)
1	#5646.29	62.4 PK	68.2	-5.8	1.02 H	156	58.0	4.4
2	*5755.00	113.4 PK			1.02 H	156	109.0	4.4
3	*5755.00	102.5 AV			1.02 H	156	98.1	4.4
4	#5956.97	57.7 PK	68.2	-10.5	1.02 H	156	53.0	4.7
5	11510.00	52.4 PK	74.0	-21.6	1.71 H	312	38.8	13.6
6	11510.00	42.2 AV	54.0	-11.8	1.71 H	312	28.6	13.6
7	#17265.00	49.1 PK	74.0	-24.9	1.75 H	354	31.5	17.6
8	#17265.00	36.0 AV	54.0	-18.0	1.75 H	354	18.4	17.6

**ANTENNA POLARITY & TEST DISTANCE: VERTICAL AT 3 M**

NO.	FREQ. (MHz)	EMISSION LEVEL (dBuV/m)	LIMIT (dBuV/m)	MARGIN (dB)	ANTENNA HEIGHT (m)	TABLE ANGLE (Degree)	RAW VALUE (dBuV)	CORRECTION FACTOR (dB/m)
1	#5644.30	67.9 PK	68.2	-0.3	2.58 V	351	63.5	4.4
2	*5755.00	119.2 PK			2.58 V	351	114.8	4.4
3	*5755.00	109.3 AV			2.58 V	351	104.9	4.4
4	#5985.62	57.2 PK	68.2	-11.0	2.58 V	351	52.5	4.7
5	11510.00	54.7 PK	74.0	-19.3	2.02 V	335	41.1	13.6
6	11510.00	44.4 AV	54.0	-9.6	2.02 V	335	30.8	13.6
7	#17265.00	50.1 PK	74.0	-23.9	1.56 V	137	32.5	17.6
8	#17265.00	37.3 AV	54.0	-16.7	1.56 V	137	19.7	17.6

**REMARKS:**

1. Emission Level(dBuV/m) = Raw Value(dBuV) + Correction Factor(dB/m)
2. Correction Factor(dB/m) = Antenna Factor(dB/m) + Cable Factor(dB) – Pre-Amplifier Factor(dB)
3. The other emission levels were very low against the limit.
4. Margin value = Emission Level – Limit value
5. " \* ": Fundamental frequency.
6. " # ": The radiated frequency is out of the restricted band.

<b>CHANNEL</b>	TX Channel 159	<b>DETECTOR FUNCTION</b>	Peak (PK)
<b>FREQUENCY RANGE</b>	1GHz ~ 40GHz		Average (AV)

**ANTENNA POLARITY & TEST DISTANCE: HORIZONTAL AT 3 M**

NO.	FREQ. (MHz)	EMISSION LEVEL (dBuV/m)	LIMIT (dBuV/m)	MARGIN (dB)	ANTENNA HEIGHT (m)	TABLE ANGLE (Degree)	RAW VALUE (dBuV)	CORRECTION FACTOR (dB/m)
1	#5648.08	60.5 PK	68.2	-7.7	1.03 H	162	56.1	4.4
2	*5795.00	115.3 PK			1.03 H	162	110.9	4.4
3	*5795.00	103.7 AV			1.03 H	162	99.3	4.4
4	#5929.00	60.3 PK	68.2	-7.9	1.03 H	162	55.6	4.7
5	11590.00	51.8 PK	74.0	-22.2	1.79 H	318	38.3	13.5
6	11590.00	41.8 AV	54.0	-12.2	1.79 H	318	28.3	13.5
7	#17385.00	49.7 PK	74.0	-24.3	1.70 H	357	31.4	18.3
8	#17385.00	36.6 AV	54.0	-17.4	1.70 H	357	18.3	18.3

**ANTENNA POLARITY & TEST DISTANCE: VERTICAL AT 3 M**

NO.	FREQ. (MHz)	EMISSION LEVEL (dBuV/m)	LIMIT (dBuV/m)	MARGIN (dB)	ANTENNA HEIGHT (m)	TABLE ANGLE (Degree)	RAW VALUE (dBuV)	CORRECTION FACTOR (dB/m)
1	#5649.31	67.4 PK	68.2	-0.8	2.36 V	349	63.0	4.4
2	*5795.00	121.5 PK			2.36 V	349	117.1	4.4
3	*5795.00	110.7 AV			2.36 V	349	106.3	4.4
4	#5926.20	68.0 PK	68.2	-0.2	2.36 V	349	63.3	4.7
5	11590.00	54.4 PK	74.0	-19.6	1.94 V	337	40.9	13.5
6	11590.00	44.1 AV	54.0	-9.9	1.94 V	337	30.6	13.5
7	#17385.00	49.8 PK	74.0	-24.2	1.63 V	135	31.5	18.3
8	#17385.00	37.0 AV	54.0	-17.0	1.63 V	135	18.7	18.3

**REMARKS:**

1. Emission Level(dBuV/m) = Raw Value(dBuV) + Correction Factor(dB/m)
2. Correction Factor(dB/m) = Antenna Factor(dB/m) + Cable Factor(dB) – Pre-Amplifier Factor(dB)
3. The other emission levels were very low against the limit.
4. Margin value = Emission Level – Limit value
5. " \* ": Fundamental frequency.
6. " # ": The radiated frequency is out of the restricted band.



**802.11ac (VHT80)**

<b>CHANNEL</b>	TX Channel 42	<b>DETECTOR FUNCTION</b>	Peak (PK)
<b>FREQUENCY RANGE</b>	1GHz ~ 40GHz		Average (AV)

**ANTENNA POLARITY & TEST DISTANCE: HORIZONTAL AT 3 M**

NO.	FREQ. (MHz)	EMISSION LEVEL (dBuV/m)	LIMIT (dBuV/m)	MARGIN (dB)	ANTENNA HEIGHT (m)	TABLE ANGLE (Degree)	RAW VALUE (dBuV)	CORRECTION FACTOR (dB/m)
1	5150.00	64.7 PK	74.0	-9.3	2.37 H	129	61.0	3.7
2	5150.00	52.4 AV	54.0	-1.6	2.37 H	129	48.7	3.7
3	*5210.00	98.7 PK			2.37 H	129	95.0	3.7
4	*5210.00	89.3 AV			2.37 H	129	85.6	3.7
5	5350.00	46.9 PK	74.0	-27.1	2.37 H	129	42.8	4.1
6	5350.00	36.2 AV	54.0	-17.8	2.37 H	129	32.1	4.1
7	#10420.00	49.6 PK	74.0	-24.4	1.81 H	304	36.5	13.1
8	#10420.00	37.0 AV	54.0	-17.0	1.81 H	304	23.9	13.1
9	15630.00	47.3 PK	74.0	-26.7	1.64 H	314	33.7	13.6
10	15630.00	34.6 AV	54.0	-19.4	1.64 H	314	21.0	13.6

**ANTENNA POLARITY & TEST DISTANCE: VERTICAL AT 3 M**

NO.	FREQ. (MHz)	EMISSION LEVEL (dBuV/m)	LIMIT (dBuV/m)	MARGIN (dB)	ANTENNA HEIGHT (m)	TABLE ANGLE (Degree)	RAW VALUE (dBuV)	CORRECTION FACTOR (dB/m)
1	5150.00	66.3 PK	74.0	-7.7	2.38 V	324	62.6	3.7
2	5150.00	53.7 AV	54.0	-0.3	2.38 V	324	50.0	3.7
3	*5210.00	106.4 PK			2.38 V	324	102.7	3.7
4	*5210.00	96.2 AV			2.38 V	324	92.5	3.7
5	5350.00	50.4 PK	74.0	-23.6	2.38 V	324	46.3	4.1
6	5350.00	39.4 AV	54.0	-14.6	2.38 V	324	35.3	4.1
7	#10420.00	48.4 PK	74.0	-25.6	2.00 V	320	35.3	13.1
8	#10420.00	36.6 AV	54.0	-17.4	2.00 V	320	23.5	13.1
9	15630.00	45.4 PK	74.0	-28.6	1.63 V	199	31.8	13.6
10	15630.00	33.3 AV	54.0	-20.7	1.63 V	199	19.7	13.6

**REMARKS:**

- Emission Level(dBuV/m) = Raw Value(dBuV) + Correction Factor(dB/m)
- Correction Factor(dB/m) = Antenna Factor(dB/m) + Cable Factor(dB) – Pre-Amplifier Factor(dB)
- The other emission levels were very low against the limit.
- Margin value = Emission Level – Limit value
- " \* ": Fundamental frequency.
- " # ": The radiated frequency is out of the restricted band.

<b>CHANNEL</b>	TX Channel 155	<b>DETECTOR FUNCTION</b>	Peak (PK)
<b>FREQUENCY RANGE</b>	1GHz ~ 40GHz		Average (AV)

**ANTENNA POLARITY & TEST DISTANCE: HORIZONTAL AT 3 M**

NO.	FREQ. (MHz)	EMISSION LEVEL (dBuV/m)	LIMIT (dBuV/m)	MARGIN (dB)	ANTENNA HEIGHT (m)	TABLE ANGLE (Degree)	RAW VALUE (dBuV)	CORRECTION FACTOR (dB/m)
1	#5632.82	60.5 PK	68.2	-7.7	1.06 H	149	56.1	4.4
2	*5775.00	104.2 PK			1.06 H	149	99.8	4.4
3	*5775.00	93.9 AV			1.06 H	149	89.5	4.4
4	#5981.06	57.8 PK	68.2	-10.4	1.06 H	149	53.1	4.7
5	11550.00	52.6 PK	74.0	-21.4	1.75 H	301	39.1	13.5
6	11550.00	42.2 AV	54.0	-11.8	1.75 H	301	28.7	13.5
7	#17325.00	49.3 PK	74.0	-24.7	1.71 H	360	31.5	17.8
8	#17325.00	36.1 AV	54.0	-17.9	1.71 H	360	18.3	17.8

**ANTENNA POLARITY & TEST DISTANCE: VERTICAL AT 3 M**

NO.	FREQ. (MHz)	EMISSION LEVEL (dBuV/m)	LIMIT (dBuV/m)	MARGIN (dB)	ANTENNA HEIGHT (m)	TABLE ANGLE (Degree)	RAW VALUE (dBuV)	CORRECTION FACTOR (dB/m)
1	#5633.78	67.4 PK	68.2	-0.8	2.52 V	336	63.0	4.4
2	*5775.00	111.5 PK			2.52 V	336	107.1	4.4
3	*5775.00	100.5 AV			2.52 V	336	96.1	4.4
4	#5934.19	61.4 PK	68.2	-6.8	2.52 V	336	56.7	4.7
5	11550.00	53.8 PK	74.0	-20.2	1.95 V	336	40.3	13.5
6	11550.00	44.0 AV	54.0	-10.0	1.95 V	336	30.5	13.5
7	#17325.00	50.7 PK	74.0	-23.3	1.60 V	128	32.9	17.8
8	#17325.00	37.7 AV	54.0	-16.3	1.60 V	128	19.9	17.8

**REMARKS:**

1. Emission Level(dBuV/m) = Raw Value(dBuV) + Correction Factor(dB/m)
2. Correction Factor(dB/m) = Antenna Factor(dB/m) + Cable Factor(dB) – Pre-Amplifier Factor(dB)
3. The other emission levels were very low against the limit.
4. Margin value = Emission Level – Limit value
5. " \* ": Fundamental frequency.
6. " # ": The radiated frequency is out of the restricted band.

**Below 1GHz Data:**

**802.11ac (VHT20)**

<b>CHANNEL</b>	TX Channel 149	<b>DETECTOR FUNCTION</b>	Quasi-Peak (QP)
<b>FREQUENCY RANGE</b>	9kHz ~ 1GHz		

**ANTENNA POLARITY & TEST DISTANCE: HORIZONTAL AT 3 M**

NO.	FREQ. (MHz)	EMISSION LEVEL (dBuV/m)	LIMIT (dBuV/m)	MARGIN (dB)	ANTENNA HEIGHT (m)	TABLE ANGLE (Degree)	RAW VALUE (dBuV)	CORRECTION FACTOR (dB/m)
1	48.99	32.8 QP	40.0	-7.2	2.00 H	283	41.0	-8.2
2	88.22	39.0 QP	43.5	-4.5	2.00 H	266	53.2	-14.2
3	98.46	38.0 QP	43.5	-5.5	3.00 H	287	50.8	-12.8
4	207.32	31.3 QP	43.5	-12.2	1.00 H	269	42.8	-11.5
5	250.00	31.8 QP	46.0	-14.2	1.00 H	279	41.4	-9.6
6	310.33	32.3 QP	46.0	-13.7	1.00 H	308	39.4	-7.1

**ANTENNA POLARITY & TEST DISTANCE: VERTICAL AT 3 M**

NO.	FREQ. (MHz)	EMISSION LEVEL (dBuV/m)	LIMIT (dBuV/m)	MARGIN (dB)	ANTENNA HEIGHT (m)	TABLE ANGLE (Degree)	RAW VALUE (dBuV)	CORRECTION FACTOR (dB/m)
1	88.98	36.8 QP	43.5	-6.7	1.00 V	345	50.9	-14.1
2	146.42	28.2 QP	43.5	-15.3	1.00 V	31	36.4	-8.2
3	205.04	27.5 QP	43.5	-16.0	1.00 V	360	39.0	-11.5
4	250.02	30.2 QP	46.0	-15.8	2.00 V	6	39.8	-9.6
5	307.13	27.2 QP	46.0	-18.8	1.00 V	219	34.5	-7.3
6	644.37	29.3 QP	46.0	-16.7	1.00 V	60	29.5	-0.2

**REMARKS:**

1. Emission Level(dBuV/m) = Raw Value(dBuV) + Correction Factor(dB/m)
2. Correction Factor(dB/m) = Antenna Factor(dB/m) + Cable Factor(dB) – Pre-Amplifier Factor(dB)
3. The other emission levels were very low against the limit.
4. Margin value = Emission Level – Limit value

## 4.1.8 Test Results (Mode 2)

## Above 1GHz Data:

## 802.11a

<b>CHANNEL</b>	TX Channel 36	<b>DETECTOR FUNCTION</b>	Peak (PK)
<b>FREQUENCY RANGE</b>	1GHz ~ 40GHz		Average (AV)

ANTENNA POLARITY & TEST DISTANCE: HORIZONTAL AT 3 M								
NO.	FREQ. (MHz)	EMISSION LEVEL (dBuV/m)	LIMIT (dBuV/m)	MARGIN (dB)	ANTENNA HEIGHT (m)	TABLE ANGLE (Degree)	RAW VALUE (dBuV)	CORRECTION FACTOR (dB/m)
1	5150.00	63.3 PK	74.0	-10.7	1.36 H	164	59.6	3.7
2	5150.00	51.7 AV	54.0	-2.3	1.36 H	164	48.0	3.7
3	*5180.00	114.2 PK			1.36 H	164	110.5	3.7
4	*5180.00	105.2 AV			1.36 H	164	101.5	3.7
5	#10360.00	49.8 PK	74.0	-24.2	1.89 H	203	36.8	13.0
6	#10360.00	38.0 AV	54.0	-16.0	1.89 H	203	25.0	13.0
7	15540.00	44.7 PK	74.0	-29.3	2.14 H	349	31.6	13.1
8	15540.00	32.8 AV	54.0	-21.2	2.14 H	349	19.7	13.1

ANTENNA POLARITY & TEST DISTANCE: VERTICAL AT 3 M								
NO.	FREQ. (MHz)	EMISSION LEVEL (dBuV/m)	LIMIT (dBuV/m)	MARGIN (dB)	ANTENNA HEIGHT (m)	TABLE ANGLE (Degree)	RAW VALUE (dBuV)	CORRECTION FACTOR (dB/m)
1	5150.00	65.8 PK	74.0	-8.2	1.72 V	336	62.1	3.7
2	5150.00	53.5 AV	54.0	-0.5	1.72 V	336	49.8	3.7
3	*5180.00	117.6 PK			1.72 V	336	113.9	3.7
4	*5180.00	107.9 AV			1.72 V	336	104.2	3.7
5	#10360.00	49.8 PK	74.0	-24.2	2.13 V	215	36.8	13.0
6	#10360.00	38.3 AV	54.0	-15.7	2.13 V	215	25.3	13.0
7	15540.00	44.7 PK	74.0	-29.3	1.75 V	302	31.6	13.1
8	15540.00	33.1 AV	54.0	-20.9	1.75 V	302	20.0	13.1

## REMARKS:

- Emission Level(dBuV/m) = Raw Value(dBuV) + Correction Factor(dB/m)
- Correction Factor(dB/m) = Antenna Factor(dB/m) + Cable Factor(dB) – Pre-Amplifier Factor(dB)
- The other emission levels were very low against the limit.
- Margin value = Emission Level – Limit value
- " \* ": Fundamental frequency.
- " # ": The radiated frequency is out of the restricted band.

<b>CHANNEL</b>	TX Channel 40	<b>DETECTOR FUNCTION</b>	Peak (PK)
<b>FREQUENCY RANGE</b>	1GHz ~ 40GHz		Average (AV)

**ANTENNA POLARITY & TEST DISTANCE: HORIZONTAL AT 3 M**

NO.	FREQ. (MHz)	EMISSION LEVEL (dBuV/m)	LIMIT (dBuV/m)	MARGIN (dB)	ANTENNA HEIGHT (m)	TABLE ANGLE (Degree)	RAW VALUE (dBuV)	CORRECTION FACTOR (dB/m)
1	5150.00	63.2 PK	74.0	-10.8	1.38 H	151	59.5	3.7
2	5150.00	51.4 AV	54.0	-2.6	1.38 H	151	47.7	3.7
3	*5200.00	117.4 PK			1.38 H	151	113.7	3.7
4	*5200.00	108.0 AV			1.38 H	151	104.3	3.7
5	5350.00	46.5 PK	74.0	-27.5	1.38 H	151	42.4	4.1
6	5350.00	36.2 AV	54.0	-17.8	1.38 H	151	32.1	4.1
7	#10400.00	50.5 PK	74.0	-23.5	1.86 H	208	37.5	13.0
8	#10400.00	38.8 AV	54.0	-15.2	1.86 H	208	25.8	13.0
9	15600.00	45.4 PK	74.0	-28.6	2.16 H	341	32.1	13.3
10	15600.00	33.5 AV	54.0	-20.5	2.16 H	341	20.2	13.3

**ANTENNA POLARITY & TEST DISTANCE: VERTICAL AT 3 M**

NO.	FREQ. (MHz)	EMISSION LEVEL (dBuV/m)	LIMIT (dBuV/m)	MARGIN (dB)	ANTENNA HEIGHT (m)	TABLE ANGLE (Degree)	RAW VALUE (dBuV)	CORRECTION FACTOR (dB/m)
1	5150.00	66.0 PK	74.0	-8.0	2.23 V	327	62.3	3.7
2	5150.00	53.8 AV	54.0	-0.2	2.23 V	327	50.1	3.7
3	*5200.00	120.3 PK			2.23 V	327	116.6	3.7
4	*5200.00	110.4 AV			2.23 V	327	106.7	3.7
5	5350.00	49.1 PK	74.0	-24.9	2.23 V	327	45.0	4.1
6	5350.00	37.5 AV	54.0	-16.5	2.23 V	327	33.4	4.1
7	#10400.00	50.5 PK	74.0	-23.5	2.10 V	212	37.5	13.0
8	#10400.00	38.7 AV	54.0	-15.3	2.10 V	212	25.7	13.0
9	15600.00	44.6 PK	74.0	-29.4	1.76 V	315	31.3	13.3
10	15600.00	33.2 AV	54.0	-20.8	1.76 V	315	19.9	13.3

**REMARKS:**

1. Emission Level(dBuV/m) = Raw Value(dBuV) + Correction Factor(dB/m)
2. Correction Factor(dB/m) = Antenna Factor(dB/m) + Cable Factor(dB) – Pre-Amplifier Factor(dB)
3. The other emission levels were very low against the limit.
4. Margin value = Emission Level – Limit value
5. " \* ": Fundamental frequency.
6. " # ": The radiated frequency is out of the restricted band.

<b>CHANNEL</b>	TX Channel 48	<b>DETECTOR FUNCTION</b>	Peak (PK)
<b>FREQUENCY RANGE</b>	1GHz ~ 40GHz		Average (AV)

**ANTENNA POLARITY & TEST DISTANCE: HORIZONTAL AT 3 M**

NO.	FREQ. (MHz)	EMISSION LEVEL (dBuV/m)	LIMIT (dBuV/m)	MARGIN (dB)	ANTENNA HEIGHT (m)	TABLE ANGLE (Degree)	RAW VALUE (dBuV)	CORRECTION FACTOR (dB/m)
1	*5240.00	118.0 PK			1.33 H	164	114.2	3.8
2	*5240.00	108.3 AV			1.33 H	164	104.5	3.8
3	5350.00	47.2 PK	74.0	-26.8	1.33 H	164	43.1	4.1
4	5350.00	35.8 AV	54.0	-18.2	1.33 H	164	31.7	4.1
5	#10480.00	49.9 PK	74.0	-24.1	1.90 H	188	36.7	13.2
6	#10480.00	38.5 AV	54.0	-15.5	1.90 H	188	25.3	13.2
7	15720.00	44.3 PK	74.0	-29.7	2.16 H	334	30.7	13.6
8	15720.00	32.4 AV	54.0	-21.6	2.16 H	334	18.8	13.6

**ANTENNA POLARITY & TEST DISTANCE: VERTICAL AT 3 M**

NO.	FREQ. (MHz)	EMISSION LEVEL (dBuV/m)	LIMIT (dBuV/m)	MARGIN (dB)	ANTENNA HEIGHT (m)	TABLE ANGLE (Degree)	RAW VALUE (dBuV)	CORRECTION FACTOR (dB/m)
1	*5240.00	120.7 PK			2.31 V	335	116.9	3.8
2	*5240.00	110.8 AV			2.31 V	335	107.0	3.8
3	5350.00	50.2 PK	74.0	-23.8	2.31 V	335	46.1	4.1
4	5350.00	38.0 AV	54.0	-16.0	2.31 V	335	33.9	4.1
5	#10480.00	49.7 PK	74.0	-24.3	2.07 V	215	36.5	13.2
6	#10480.00	38.3 AV	54.0	-15.7	2.07 V	215	25.1	13.2
7	15720.00	44.9 PK	74.0	-29.1	1.73 V	299	31.3	13.6
8	15720.00	33.1 AV	54.0	-20.9	1.73 V	299	19.5	13.6

**REMARKS:**

1. Emission Level(dBuV/m) = Raw Value(dBuV) + Correction Factor(dB/m)
2. Correction Factor(dB/m) = Antenna Factor(dB/m) + Cable Factor(dB) – Pre-Amplifier Factor(dB)
3. The other emission levels were very low against the limit.
4. Margin value = Emission Level – Limit value
5. " \* ": Fundamental frequency.
6. " # ": The radiated frequency is out of the restricted band.

<b>CHANNEL</b>	TX Channel 149	<b>DETECTOR FUNCTION</b>	Peak (PK)
<b>FREQUENCY RANGE</b>	1GHz ~ 40GHz		Average (AV)

**ANTENNA POLARITY & TEST DISTANCE: HORIZONTAL AT 3 M**

NO.	FREQ. (MHz)	EMISSION LEVEL (dBuV/m)	LIMIT (dBuV/m)	MARGIN (dB)	ANTENNA HEIGHT (m)	TABLE ANGLE (Degree)	RAW VALUE (dBuV)	CORRECTION FACTOR (dB/m)
1	#5637.02	62.1 PK	68.2	-6.1	1.33 H	152	57.7	4.4
2	*5745.00	115.6 PK			1.33 H	152	111.2	4.4
3	*5745.00	105.3 AV			1.33 H	152	100.9	4.4
4	#5932.32	58.3 PK	68.2	-9.9	1.33 H	152	53.6	4.7
5	11490.00	59.7 PK	74.0	-14.3	2.05 H	154	46.2	13.5
6	11490.00	47.7 AV	54.0	-6.3	2.05 H	154	34.2	13.5
7	#17235.00	50.9 PK	74.0	-23.1	1.73 H	299	33.6	17.3
8	#17235.00	39.2 AV	54.0	-14.8	1.73 H	299	21.9	17.3

**ANTENNA POLARITY & TEST DISTANCE: VERTICAL AT 3 M**

NO.	FREQ. (MHz)	EMISSION LEVEL (dBuV/m)	LIMIT (dBuV/m)	MARGIN (dB)	ANTENNA HEIGHT (m)	TABLE ANGLE (Degree)	RAW VALUE (dBuV)	CORRECTION FACTOR (dB/m)
1	#5648.38	66.6 PK	68.2	-1.6	2.39 V	338	62.2	4.4
2	*5745.00	121.0 PK			2.39 V	338	116.6	4.4
3	*5745.00	110.7 AV			2.39 V	338	106.3	4.4
4	#5973.41	58.6 PK	68.2	-9.6	2.39 V	338	53.9	4.7
5	11490.00	60.3 PK	74.0	-13.7	3.35 V	313	46.8	13.5
6	11490.00	50.0 AV	54.0	-4.0	3.35 V	313	36.5	13.5
7	#17235.00	50.1 PK	74.0	-23.9	1.68 V	247	32.8	17.3
8	#17235.00	38.5 AV	54.0	-15.5	1.68 V	247	21.2	17.3

**REMARKS:**

1. Emission Level(dBuV/m) = Raw Value(dBuV) + Correction Factor(dB/m)
2. Correction Factor(dB/m) = Antenna Factor(dB/m) + Cable Factor(dB) – Pre-Amplifier Factor(dB)
3. The other emission levels were very low against the limit.
4. Margin value = Emission Level – Limit value
5. " \* ": Fundamental frequency.
6. " # ": The radiated frequency is out of the restricted band.

<b>CHANNEL</b>	TX Channel 157	<b>DETECTOR FUNCTION</b>	Peak (PK)
<b>FREQUENCY RANGE</b>	1GHz ~ 40GHz		Average (AV)

**ANTENNA POLARITY & TEST DISTANCE: HORIZONTAL AT 3 M**

NO.	FREQ. (MHz)	EMISSION LEVEL (dBuV/m)	LIMIT (dBuV/m)	MARGIN (dB)	ANTENNA HEIGHT (m)	TABLE ANGLE (Degree)	RAW VALUE (dBuV)	CORRECTION FACTOR (dB/m)
1	#5627.60	58.8 PK	68.2	-9.4	1.37 H	150	54.4	4.4
2	*5785.00	115.5 PK			1.37 H	150	111.1	4.4
3	*5785.00	105.1 AV			1.37 H	150	100.7	4.4
4	#5965.58	58.0 PK	68.2	-10.2	1.37 H	150	53.3	4.7
5	11570.00	60.1 PK	74.0	-13.9	2.03 H	157	46.6	13.5
6	11570.00	47.7 AV	54.0	-6.3	2.03 H	157	34.2	13.5
7	#17355.00	50.8 PK	74.0	-23.2	1.80 H	292	32.8	18.0
8	#17355.00	38.8 AV	54.0	-15.2	1.80 H	292	20.8	18.0

**ANTENNA POLARITY & TEST DISTANCE: VERTICAL AT 3 M**

NO.	FREQ. (MHz)	EMISSION LEVEL (dBuV/m)	LIMIT (dBuV/m)	MARGIN (dB)	ANTENNA HEIGHT (m)	TABLE ANGLE (Degree)	RAW VALUE (dBuV)	CORRECTION FACTOR (dB/m)
1	#5620.20	60.2 PK	68.2	-8.0	2.38 V	335	55.8	4.4
2	*5785.00	121.0 PK			2.38 V	335	116.6	4.4
3	*5785.00	110.8 AV			2.38 V	335	106.4	4.4
4	#5943.41	58.6 PK	68.2	-9.6	2.38 V	335	53.9	4.7
5	11570.00	60.2 PK	74.0	-13.8	3.35 V	325	46.7	13.5
6	11570.00	49.4 AV	54.0	-4.6	3.35 V	325	35.9	13.5
7	#17355.00	51.0 PK	74.0	-23.0	1.70 V	258	33.0	18.0
8	#17355.00	39.0 AV	54.0	-15.0	1.70 V	258	21.0	18.0

**REMARKS:**

1. Emission Level(dBuV/m) = Raw Value(dBuV) + Correction Factor(dB/m)
2. Correction Factor(dB/m) = Antenna Factor(dB/m) + Cable Factor(dB) – Pre-Amplifier Factor(dB)
3. The other emission levels were very low against the limit.
4. Margin value = Emission Level – Limit value
5. " \* ": Fundamental frequency.
6. " # ": The radiated frequency is out of the restricted band.



<b>CHANNEL</b>	TX Channel 165	<b>DETECTOR FUNCTION</b>	Peak (PK)
<b>FREQUENCY RANGE</b>	1GHz ~ 40GHz		Average (AV)

**ANTENNA POLARITY & TEST DISTANCE: HORIZONTAL AT 3 M**

NO.	FREQ. (MHz)	EMISSION LEVEL (dBuV/m)	LIMIT (dBuV/m)	MARGIN (dB)	ANTENNA HEIGHT (m)	TABLE ANGLE (Degree)	RAW VALUE (dBuV)	CORRECTION FACTOR (dB/m)
1	#5631.66	59.2 PK	68.2	-9.0	1.33 H	144	54.8	4.4
2	*5825.00	116.1 PK			1.33 H	144	111.7	4.4
3	*5825.00	105.7 AV			1.33 H	144	101.3	4.4
4	#5976.09	58.8 PK	68.2	-9.4	1.33 H	144	54.1	4.7
5	11650.00	59.6 PK	74.0	-14.4	2.06 H	170	45.9	13.7
6	11650.00	47.4 AV	54.0	-6.6	2.06 H	170	33.7	13.7
7	#17475.00	50.6 PK	74.0	-23.4	1.75 H	302	32.0	18.6
8	#17475.00	38.8 AV	54.0	-15.2	1.75 H	302	20.2	18.6

**ANTENNA POLARITY & TEST DISTANCE: VERTICAL AT 3 M**

NO.	FREQ. (MHz)	EMISSION LEVEL (dBuV/m)	LIMIT (dBuV/m)	MARGIN (dB)	ANTENNA HEIGHT (m)	TABLE ANGLE (Degree)	RAW VALUE (dBuV)	CORRECTION FACTOR (dB/m)
1	#5594.22	58.7 PK	68.2	-9.5	2.36 V	335	54.4	4.3
2	*5825.00	120.8 PK			2.36 V	335	116.4	4.4
3	*5825.00	110.4 AV			2.36 V	335	106.0	4.4
4	#5940.55	60.1 PK	68.2	-8.1	2.36 V	335	55.4	4.7
5	11650.00	60.4 PK	74.0	-13.6	3.37 V	321	46.7	13.7
6	11650.00	49.9 AV	54.0	-4.1	3.37 V	321	36.2	13.7
7	#17475.00	50.8 PK	74.0	-23.2	1.68 V	247	32.2	18.6
8	#17475.00	39.0 AV	54.0	-15.0	1.68 V	247	20.4	18.6

**REMARKS:**

1. Emission Level(dBuV/m) = Raw Value(dBuV) + Correction Factor(dB/m)
2. Correction Factor(dB/m) = Antenna Factor(dB/m) + Cable Factor(dB) – Pre-Amplifier Factor(dB)
3. The other emission levels were very low against the limit.
4. Margin value = Emission Level – Limit value
5. " \* ": Fundamental frequency.
6. " # ": The radiated frequency is out of the restricted band.

**802.11ac (VHT20)**

<b>CHANNEL</b>	TX Channel 36	<b>DETECTOR FUNCTION</b>	Peak (PK)
<b>FREQUENCY RANGE</b>	1GHz ~ 40GHz		Average (AV)

**ANTENNA POLARITY & TEST DISTANCE: HORIZONTAL AT 3 M**

NO.	FREQ. (MHz)	EMISSION LEVEL (dBuV/m)	LIMIT (dBuV/m)	MARGIN (dB)	ANTENNA HEIGHT (m)	TABLE ANGLE (Degree)	RAW VALUE (dBuV)	CORRECTION FACTOR (dB/m)
1	5150.00	63.1 PK	74.0	-10.9	1.41 H	179	59.4	3.7
2	5150.00	51.1 AV	54.0	-2.9	1.41 H	179	47.4	3.7
3	*5180.00	115.5 PK			1.41 H	179	111.8	3.7
4	*5180.00	105.2 AV			1.41 H	179	101.5	3.7
5	#10360.00	50.1 PK	74.0	-23.9	1.89 H	217	37.1	13.0
6	#10360.00	38.1 AV	54.0	-15.9	1.89 H	217	25.1	13.0
7	15540.00	44.0 PK	74.0	-30.0	2.09 H	354	30.9	13.1
8	15540.00	32.3 AV	54.0	-21.7	2.09 H	354	19.2	13.1

**ANTENNA POLARITY & TEST DISTANCE: VERTICAL AT 3 M**

NO.	FREQ. (MHz)	EMISSION LEVEL (dBuV/m)	LIMIT (dBuV/m)	MARGIN (dB)	ANTENNA HEIGHT (m)	TABLE ANGLE (Degree)	RAW VALUE (dBuV)	CORRECTION FACTOR (dB/m)
1	5150.00	65.8 PK	74.0	-8.2	2.53 V	318	62.1	3.7
2	5150.00	53.5 AV	54.0	-0.5	2.53 V	318	49.8	3.7
3	*5180.00	119.0 PK			2.53 V	318	115.3	3.7
4	*5180.00	107.9 AV			2.53 V	318	104.2	3.7
5	#10360.00	50.3 PK	74.0	-23.7	2.12 V	222	37.3	13.0
6	#10360.00	38.5 AV	54.0	-15.5	2.12 V	222	25.5	13.0
7	15540.00	44.6 PK	74.0	-29.4	1.79 V	297	31.5	13.1
8	15540.00	32.8 AV	54.0	-21.2	1.79 V	297	19.7	13.1

**REMARKS:**

- Emission Level(dBuV/m) = Raw Value(dBuV) + Correction Factor(dB/m)
- Correction Factor(dB/m) = Antenna Factor(dB/m) + Cable Factor(dB) – Pre-Amplifier Factor(dB)
- The other emission levels were very low against the limit.
- Margin value = Emission Level – Limit value
- " \* ": Fundamental frequency.
- " # ": The radiated frequency is out of the restricted band.

<b>CHANNEL</b>	TX Channel 40	<b>DETECTOR FUNCTION</b>	Peak (PK)
<b>FREQUENCY RANGE</b>	1GHz ~ 40GHz		Average (AV)

**ANTENNA POLARITY & TEST DISTANCE: HORIZONTAL AT 3 M**

NO.	FREQ. (MHz)	EMISSION LEVEL (dBuV/m)	LIMIT (dBuV/m)	MARGIN (dB)	ANTENNA HEIGHT (m)	TABLE ANGLE (Degree)	RAW VALUE (dBuV)	CORRECTION FACTOR (dB/m)
1	5150.00	65.6 PK	74.0	-8.4	1.41 H	162	61.9	3.7
2	5150.00	51.5 AV	54.0	-2.5	1.41 H	162	47.8	3.7
3	*5200.00	117.4 PK			1.41 H	162	113.7	3.7
4	*5200.00	107.4 AV			1.41 H	162	103.7	3.7
5	5350.00	47.6 PK	74.0	-26.4	1.41 H	162	43.5	4.1
6	5350.00	36.7 AV	54.0	-17.3	1.41 H	162	32.6	4.1
7	#10400.00	50.6 PK	74.0	-23.4	1.86 H	205	37.6	13.0
8	#10400.00	38.7 AV	54.0	-15.3	1.86 H	205	25.7	13.0
9	15600.00	44.9 PK	74.0	-29.1	2.14 H	356	31.6	13.3
10	15600.00	33.1 AV	54.0	-20.9	2.14 H	356	19.8	13.3

**ANTENNA POLARITY & TEST DISTANCE: VERTICAL AT 3 M**

NO.	FREQ. (MHz)	EMISSION LEVEL (dBuV/m)	LIMIT (dBuV/m)	MARGIN (dB)	ANTENNA HEIGHT (m)	TABLE ANGLE (Degree)	RAW VALUE (dBuV)	CORRECTION FACTOR (dB/m)
1	5150.00	68.5 PK	74.0	-5.5	2.50 V	321	64.8	3.7
2	5150.00	53.8 AV	54.0	-0.2	2.50 V	321	50.1	3.7
3	*5200.00	120.8 PK			2.50 V	321	117.1	3.7
4	*5200.00	110.2 AV			2.50 V	321	106.5	3.7
5	5350.00	50.2 PK	74.0	-23.8	2.50 V	321	46.1	4.1
6	5350.00	38.0 AV	54.0	-16.0	2.50 V	321	33.9	4.1
7	#10400.00	50.8 PK	74.0	-23.2	2.16 V	211	37.8	13.0
8	#10400.00	38.8 AV	54.0	-15.2	2.16 V	211	25.8	13.0
9	15600.00	44.8 PK	74.0	-29.2	1.73 V	328	31.5	13.3
10	15600.00	33.4 AV	54.0	-20.6	1.73 V	328	20.1	13.3

**REMARKS:**

1. Emission Level(dBuV/m) = Raw Value(dBuV) + Correction Factor(dB/m)
2. Correction Factor(dB/m) = Antenna Factor(dB/m) + Cable Factor(dB) – Pre-Amplifier Factor(dB)
3. The other emission levels were very low against the limit.
4. Margin value = Emission Level – Limit value
5. " \* ": Fundamental frequency.
6. " # ": The radiated frequency is out of the restricted band.

<b>CHANNEL</b>	TX Channel 48	<b>DETECTOR FUNCTION</b>	Peak (PK)
<b>FREQUENCY RANGE</b>	1GHz ~ 40GHz		Average (AV)

**ANTENNA POLARITY & TEST DISTANCE: HORIZONTAL AT 3 M**

NO.	FREQ. (MHz)	EMISSION LEVEL (dBuV/m)	LIMIT (dBuV/m)	MARGIN (dB)	ANTENNA HEIGHT (m)	TABLE ANGLE (Degree)	RAW VALUE (dBuV)	CORRECTION FACTOR (dB/m)
1	*5240.00	116.4 PK			1.41 H	169	112.6	3.8
2	*5240.00	107.5 AV			1.41 H	169	103.7	3.8
3	5350.00	48.4 PK	74.0	-25.6	1.41 H	169	44.3	4.1
4	5350.00	36.8 AV	54.0	-17.2	1.41 H	169	32.7	4.1
5	#10480.00	50.3 PK	74.0	-23.7	1.91 H	181	37.1	13.2
6	#10480.00	38.6 AV	54.0	-15.4	1.91 H	181	25.4	13.2
7	15720.00	44.4 PK	74.0	-29.6	2.15 H	345	30.8	13.6
8	15720.00	32.7 AV	54.0	-21.3	2.15 H	345	19.1	13.6

**ANTENNA POLARITY & TEST DISTANCE: VERTICAL AT 3 M**

NO.	FREQ. (MHz)	EMISSION LEVEL (dBuV/m)	LIMIT (dBuV/m)	MARGIN (dB)	ANTENNA HEIGHT (m)	TABLE ANGLE (Degree)	RAW VALUE (dBuV)	CORRECTION FACTOR (dB/m)
1	*5240.00	119.8 PK			2.45 V	334	116.0	3.8
2	*5240.00	110.2 AV			2.45 V	334	106.4	3.8
3	5350.00	50.9 PK	74.0	-23.1	2.45 V	334	46.8	4.1
4	5350.00	38.1 AV	54.0	-15.9	2.45 V	334	34.0	4.1
5	#10480.00	49.6 PK	74.0	-24.4	2.07 V	227	36.4	13.2
6	#10480.00	38.3 AV	54.0	-15.7	2.07 V	227	25.1	13.2
7	15720.00	44.8 PK	74.0	-29.2	1.75 V	308	31.2	13.6
8	15720.00	33.0 AV	54.0	-21.0	1.75 V	308	19.4	13.6

**REMARKS:**

1. Emission Level(dBuV/m) = Raw Value(dBuV) + Correction Factor(dB/m)
2. Correction Factor(dB/m) = Antenna Factor(dB/m) + Cable Factor(dB) – Pre-Amplifier Factor(dB)
3. The other emission levels were very low against the limit.
4. Margin value = Emission Level – Limit value
5. " \* ": Fundamental frequency.
6. " # ": The radiated frequency is out of the restricted band.

<b>CHANNEL</b>	TX Channel 149	<b>DETECTOR FUNCTION</b>	Peak (PK)
<b>FREQUENCY RANGE</b>	1GHz ~ 40GHz		Average (AV)

**ANTENNA POLARITY & TEST DISTANCE: HORIZONTAL AT 3 M**

NO.	FREQ. (MHz)	EMISSION LEVEL (dBuV/m)	LIMIT (dBuV/m)	MARGIN (dB)	ANTENNA HEIGHT (m)	TABLE ANGLE (Degree)	RAW VALUE (dBuV)	CORRECTION FACTOR (dB/m)
1	#5646.96	63.6 PK	68.2	-4.6	1.03 H	246	59.2	4.4
2	*5745.00	115.9 PK			1.03 H	246	111.5	4.4
3	*5745.00	104.6 AV			1.03 H	246	100.2	4.4
4	#5953.01	57.9 PK	68.2	-10.3	1.03 H	246	53.2	4.7
5	11490.00	59.3 PK	74.0	-14.7	2.03 H	170	45.8	13.5
6	11490.00	46.9 AV	54.0	-7.1	2.03 H	170	33.4	13.5
7	#17235.00	51.0 PK	74.0	-23.0	1.78 H	312	33.7	17.3
8	#17235.00	38.9 AV	54.0	-15.1	1.78 H	312	21.6	17.3

**ANTENNA POLARITY & TEST DISTANCE: VERTICAL AT 3 M**

NO.	FREQ. (MHz)	EMISSION LEVEL (dBuV/m)	LIMIT (dBuV/m)	MARGIN (dB)	ANTENNA HEIGHT (m)	TABLE ANGLE (Degree)	RAW VALUE (dBuV)	CORRECTION FACTOR (dB/m)
1	#5645.84	67.4 PK	68.2	-0.8	2.35 V	256	63.0	4.4
2	*5745.00	123.6 PK			2.35 V	256	119.2	4.4
3	*5745.00	112.5 AV			2.35 V	256	108.1	4.4
4	#5949.12	58.0 PK	68.2	-10.2	2.35 V	256	53.3	4.7
5	11490.00	60.0 PK	74.0	-14.0	3.41 V	305	46.5	13.5
6	11490.00	49.5 AV	54.0	-4.5	3.41 V	305	36.0	13.5
7	#17235.00	50.2 PK	74.0	-23.8	1.66 V	259	32.9	17.3
8	#17235.00	38.5 AV	54.0	-15.5	1.66 V	259	21.2	17.3

**REMARKS:**

1. Emission Level(dBuV/m) = Raw Value(dBuV) + Correction Factor(dB/m)
2. Correction Factor(dB/m) = Antenna Factor(dB/m) + Cable Factor(dB) – Pre-Amplifier Factor(dB)
3. The other emission levels were very low against the limit.
4. Margin value = Emission Level – Limit value
5. " \* ": Fundamental frequency.
6. " # ": The radiated frequency is out of the restricted band.

<b>CHANNEL</b>	TX Channel 157	<b>DETECTOR FUNCTION</b>	Peak (PK)
<b>FREQUENCY RANGE</b>	1GHz ~ 40GHz		Average (AV)

**ANTENNA POLARITY & TEST DISTANCE: HORIZONTAL AT 3 M**

NO.	FREQ. (MHz)	EMISSION LEVEL (dBuV/m)	LIMIT (dBuV/m)	MARGIN (dB)	ANTENNA HEIGHT (m)	TABLE ANGLE (Degree)	RAW VALUE (dBuV)	CORRECTION FACTOR (dB/m)
1	#5648.82	59.5 PK	68.2	-8.7	1.05 H	246	55.1	4.4
2	*5785.00	115.2 PK			1.05 H	246	110.8	4.4
3	*5785.00	104.1 AV			1.05 H	246	99.7	4.4
4	#5974.61	57.2 PK	68.2	-11.0	1.05 H	246	52.5	4.7
5	11570.00	59.5 PK	74.0	-14.5	2.04 H	180	46.0	13.5
6	11570.00	47.3 AV	54.0	-6.7	2.04 H	180	33.8	13.5
7	#17355.00	50.8 PK	74.0	-23.2	1.69 H	303	32.8	18.0
8	#17355.00	38.7 AV	54.0	-15.3	1.69 H	303	20.7	18.0

**ANTENNA POLARITY & TEST DISTANCE: VERTICAL AT 3 M**

NO.	FREQ. (MHz)	EMISSION LEVEL (dBuV/m)	LIMIT (dBuV/m)	MARGIN (dB)	ANTENNA HEIGHT (m)	TABLE ANGLE (Degree)	RAW VALUE (dBuV)	CORRECTION FACTOR (dB/m)
1	#5607.83	60.1 PK	68.2	-8.1	2.33 V	253	55.7	4.4
2	*5785.00	123.4 PK			2.33 V	253	119.0	4.4
3	*5785.00	112.3 AV			2.33 V	253	107.9	4.4
4	#5937.05	57.9 PK	68.2	-10.3	2.33 V	253	53.2	4.7
5	11570.00	60.6 PK	74.0	-13.4	3.42 V	333	47.1	13.5
6	11570.00	50.2 AV	54.0	-3.8	3.42 V	333	36.7	13.5
7	#17355.00	51.0 PK	74.0	-23.0	1.69 V	249	33.0	18.0
8	#17355.00	38.7 AV	54.0	-15.3	1.69 V	249	20.7	18.0

**REMARKS:**

1. Emission Level(dBuV/m) = Raw Value(dBuV) + Correction Factor(dB/m)
2. Correction Factor(dB/m) = Antenna Factor(dB/m) + Cable Factor(dB) – Pre-Amplifier Factor(dB)
3. The other emission levels were very low against the limit.
4. Margin value = Emission Level – Limit value
5. " \* ": Fundamental frequency.
6. " # ": The radiated frequency is out of the restricted band.

<b>CHANNEL</b>	TX Channel 165	<b>DETECTOR FUNCTION</b>	Peak (PK)
<b>FREQUENCY RANGE</b>	1GHz ~ 40GHz		Average (AV)

**ANTENNA POLARITY & TEST DISTANCE: HORIZONTAL AT 3 M**

NO.	FREQ. (MHz)	EMISSION LEVEL (dBuV/m)	LIMIT (dBuV/m)	MARGIN (dB)	ANTENNA HEIGHT (m)	TABLE ANGLE (Degree)	RAW VALUE (dBuV)	CORRECTION FACTOR (dB/m)
1	#5647.68	58.9 PK	68.2	-9.3	1.26 H	254	54.5	4.4
2	*5825.00	113.6 PK			1.26 H	254	109.2	4.4
3	*5825.00	103.1 AV			1.26 H	254	98.7	4.4
4	#5977.62	58.3 PK	68.2	-9.9	1.26 H	254	53.6	4.7
5	11650.00	59.9 PK	74.0	-14.1	2.01 H	183	46.2	13.7
6	11650.00	47.8 AV	54.0	-6.2	2.01 H	183	34.1	13.7
7	#17475.00	50.6 PK	74.0	-23.4	1.72 H	294	32.0	18.6
8	#17475.00	38.8 AV	54.0	-15.2	1.72 H	294	20.2	18.6

**ANTENNA POLARITY & TEST DISTANCE: VERTICAL AT 3 M**

NO.	FREQ. (MHz)	EMISSION LEVEL (dBuV/m)	LIMIT (dBuV/m)	MARGIN (dB)	ANTENNA HEIGHT (m)	TABLE ANGLE (Degree)	RAW VALUE (dBuV)	CORRECTION FACTOR (dB/m)
1	#5635.93	58.4 PK	68.2	-9.8	2.30 V	254	54.0	4.4
2	*5825.00	123.0 PK			2.30 V	254	118.6	4.4
3	*5825.00	110.0 AV			2.30 V	254	105.6	4.4
4	#5930.95	60.5 PK	68.2	-7.7	2.30 V	254	55.8	4.7
5	11650.00	60.1 PK	74.0	-13.9	3.41 V	320	46.4	13.7
6	11650.00	49.8 AV	54.0	-4.2	3.41 V	320	36.1	13.7
7	#17475.00	50.9 PK	74.0	-23.1	1.69 V	250	32.3	18.6
8	#17475.00	38.9 AV	54.0	-15.1	1.69 V	250	20.3	18.6

**REMARKS:**

1. Emission Level(dBuV/m) = Raw Value(dBuV) + Correction Factor(dB/m)
2. Correction Factor(dB/m) = Antenna Factor(dB/m) + Cable Factor(dB) – Pre-Amplifier Factor(dB)
3. The other emission levels were very low against the limit.
4. Margin value = Emission Level – Limit value
5. " \* ": Fundamental frequency.
6. " # ": The radiated frequency is out of the restricted band.

**802.11ac (VHT40)**

<b>CHANNEL</b>	TX Channel 38	<b>DETECTOR FUNCTION</b>	Peak (PK)
<b>FREQUENCY RANGE</b>	1GHz ~ 40GHz		Average (AV)

**ANTENNA POLARITY & TEST DISTANCE: HORIZONTAL AT 3 M**

NO.	FREQ. (MHz)	EMISSION LEVEL (dBuV/m)	LIMIT (dBuV/m)	MARGIN (dB)	ANTENNA HEIGHT (m)	TABLE ANGLE (Degree)	RAW VALUE (dBuV)	CORRECTION FACTOR (dB/m)
1	5150.00	61.7 PK	74.0	-12.3	1.35 H	181	58.0	3.7
2	5150.00	51.7 AV	54.0	-2.3	1.35 H	181	48.0	3.7
3	*5190.00	106.9 PK			1.35 H	181	103.2	3.7
4	*5190.00	98.4 AV			1.35 H	181	94.7	3.7
5	5350.00	46.6 PK	74.0	-27.4	1.35 H	181	42.5	4.1
6	5350.00	36.0 AV	54.0	-18.0	1.35 H	181	31.9	4.1
7	#10380.00	50.8 PK	74.0	-23.2	1.85 H	215	37.7	13.1
8	#10380.00	39.1 AV	54.0	-14.9	1.85 H	215	26.0	13.1
9	15570.00	44.9 PK	74.0	-29.1	2.16 H	349	31.6	13.3
10	15570.00	32.8 AV	54.0	-21.2	2.16 H	349	19.5	13.3

**ANTENNA POLARITY & TEST DISTANCE: VERTICAL AT 3 M**

NO.	FREQ. (MHz)	EMISSION LEVEL (dBuV/m)	LIMIT (dBuV/m)	MARGIN (dB)	ANTENNA HEIGHT (m)	TABLE ANGLE (Degree)	RAW VALUE (dBuV)	CORRECTION FACTOR (dB/m)
1	5150.00	64.5 PK	74.0	-9.5	2.17 V	193	60.8	3.7
2	<b>5150.00</b>	<b>53.9 AV</b>	<b>54.0</b>	<b>-0.1</b>	<b>2.17 V</b>	<b>193</b>	<b>50.2</b>	<b>3.7</b>
3	*5190.00	110.3 PK			2.17 V	193	106.6	3.7
4	*5190.00	101.1 AV			2.17 V	193	97.4	3.7
5	5350.00	49.2 PK	74.0	-24.8	2.17 V	193	45.1	4.1
6	5350.00	37.2 AV	54.0	-16.8	2.17 V	193	33.1	4.1
7	#10380.00	50.5 PK	74.0	-23.5	2.17 V	231	37.4	13.1
8	#10380.00	38.8 AV	54.0	-15.2	2.17 V	231	25.7	13.1
9	15570.00	44.7 PK	74.0	-29.3	1.76 V	308	31.4	13.3
10	15570.00	32.9 AV	54.0	-21.1	1.76 V	308	19.6	13.3

**REMARKS:**

- Emission Level(dBuV/m) = Raw Value(dBuV) + Correction Factor(dB/m)
- Correction Factor(dB/m) = Antenna Factor(dB/m) + Cable Factor(dB) – Pre-Amplifier Factor(dB)
- The other emission levels were very low against the limit.
- Margin value = Emission Level – Limit value
- " \* ": Fundamental frequency.
- " # ": The radiated frequency is out of the restricted band.



<b>CHANNEL</b>	TX Channel 46	<b>DETECTOR FUNCTION</b>	Peak (PK)
<b>FREQUENCY RANGE</b>	1GHz ~ 40GHz		Average (AV)

**ANTENNA POLARITY & TEST DISTANCE: HORIZONTAL AT 3 M**

NO.	FREQ. (MHz)	EMISSION LEVEL (dBuV/m)	LIMIT (dBuV/m)	MARGIN (dB)	ANTENNA HEIGHT (m)	TABLE ANGLE (Degree)	RAW VALUE (dBuV)	CORRECTION FACTOR (dB/m)
1	5150.00	60.9 PK	74.0	-13.1	1.38 H	183	57.2	3.7
2	5150.00	51.4 AV	54.0	-2.6	1.38 H	183	47.7	3.7
3	*5230.00	119.4 PK			1.38 H	183	115.6	3.8
4	*5230.00	100.4 AV			1.38 H	183	96.6	3.8
5	5350.00	50.1 PK	74.0	-23.9	1.38 H	183	46.0	4.1
6	5350.00	38.9 AV	54.0	-15.1	1.38 H	183	34.8	4.1
7	#10460.00	50.9 PK	74.0	-23.1	1.86 H	204	37.8	13.1
8	#10460.00	39.1 AV	54.0	-14.9	1.86 H	204	26.0	13.1
9	15690.00	44.7 PK	74.0	-29.3	2.20 H	345	30.9	13.8
10	15690.00	32.6 AV	54.0	-21.4	2.20 H	345	18.8	13.8

**ANTENNA POLARITY & TEST DISTANCE: VERTICAL AT 3 M**

NO.	FREQ. (MHz)	EMISSION LEVEL (dBuV/m)	LIMIT (dBuV/m)	MARGIN (dB)	ANTENNA HEIGHT (m)	TABLE ANGLE (Degree)	RAW VALUE (dBuV)	CORRECTION FACTOR (dB/m)
1	5150.00	63.6 PK	74.0	-10.4	2.20 V	179	59.9	3.7
2	5150.00	53.7 AV	54.0	-0.3	2.20 V	179	50.0	3.7
3	*5230.00	112.8 PK			2.20 V	179	109.0	3.8
4	*5230.00	103.1 AV			2.20 V	179	99.3	3.8
5	5350.00	52.7 PK	74.0	-21.3	2.20 V	179	48.6	4.1
6	5350.00	40.2 AV	54.0	-13.8	2.20 V	179	36.1	4.1
7	#10460.00	50.8 PK	74.0	-23.2	2.17 V	220	37.7	13.1
8	#10460.00	38.9 AV	54.0	-15.1	2.17 V	220	25.8	13.1
9	15690.00	44.6 PK	74.0	-29.4	1.82 V	303	30.8	13.8
10	15690.00	33.0 AV	54.0	-21.0	1.82 V	303	19.2	13.8

**REMARKS:**

- Emission Level(dBuV/m) = Raw Value(dBuV) + Correction Factor(dB/m)
- Correction Factor(dB/m) = Antenna Factor(dB/m) + Cable Factor(dB) – Pre-Amplifier Factor(dB)
- The other emission levels were very low against the limit.
- Margin value = Emission Level – Limit value
- " \* ": Fundamental frequency.
- " # ": The radiated frequency is out of the restricted band.

<b>CHANNEL</b>	TX Channel 151	<b>DETECTOR FUNCTION</b>	Peak (PK)
<b>FREQUENCY RANGE</b>	1GHz ~ 40GHz		Average (AV)

**ANTENNA POLARITY & TEST DISTANCE: HORIZONTAL AT 3 M**

NO.	FREQ. (MHz)	EMISSION LEVEL (dBuV/m)	LIMIT (dBuV/m)	MARGIN (dB)	ANTENNA HEIGHT (m)	TABLE ANGLE (Degree)	RAW VALUE (dBuV)	CORRECTION FACTOR (dB/m)
1	#5640.83	61.0 PK	68.2	-7.2	1.37 H	156	56.6	4.4
2	*5755.00	109.6 PK			1.37 H	156	105.2	4.4
3	*5755.00	100.0 AV			1.37 H	156	95.6	4.4
4	#5965.29	56.9 PK	68.2	-11.3	1.37 H	156	52.2	4.7
5	11510.00	54.0 PK	74.0	-20.0	1.73 H	309	40.4	13.6
6	11510.00	43.8 AV	54.0	-10.2	1.73 H	309	30.2	13.6
7	#17265.00	49.5 PK	74.0	-24.5	1.70 H	339	31.9	17.6
8	#17265.00	36.2 AV	54.0	-17.8	1.70 H	339	18.6	17.6

**ANTENNA POLARITY & TEST DISTANCE: VERTICAL AT 3 M**

NO.	FREQ. (MHz)	EMISSION LEVEL (dBuV/m)	LIMIT (dBuV/m)	MARGIN (dB)	ANTENNA HEIGHT (m)	TABLE ANGLE (Degree)	RAW VALUE (dBuV)	CORRECTION FACTOR (dB/m)
1	#5650.11	67.6 PK	68.3	-0.7	2.49 V	254	63.3	4.3
2	*5755.00	118.8 PK			2.49 V	254	114.4	4.4
3	*5755.00	108.6 AV			2.49 V	254	104.2	4.4
4	#5927.72	58.2 PK	68.2	-10.0	2.49 V	254	53.5	4.7
5	11510.00	56.8 PK	74.0	-17.2	2.04 V	327	43.2	13.6
6	11510.00	46.6 AV	54.0	-7.4	2.04 V	327	33.0	13.6
7	#17265.00	49.9 PK	74.0	-24.1	1.51 V	149	32.3	17.6
8	#17265.00	37.3 AV	54.0	-16.7	1.51 V	149	19.7	17.6

**REMARKS:**

- Emission Level(dBuV/m) = Raw Value(dBuV) + Correction Factor(dB/m)
- Correction Factor(dB/m) = Antenna Factor(dB/m) + Cable Factor(dB) – Pre-Amplifier Factor(dB)
- The other emission levels were very low against the limit.
- Margin value = Emission Level – Limit value
- " \* ": Fundamental frequency.
- " # ": The radiated frequency is out of the restricted band.

<b>CHANNEL</b>	TX Channel 159	<b>DETECTOR FUNCTION</b>	Peak (PK)
<b>FREQUENCY RANGE</b>	1GHz ~ 40GHz		Average (AV)

**ANTENNA POLARITY & TEST DISTANCE: HORIZONTAL AT 3 M**

NO.	FREQ. (MHz)	EMISSION LEVEL (dBuV/m)	LIMIT (dBuV/m)	MARGIN (dB)	ANTENNA HEIGHT (m)	TABLE ANGLE (Degree)	RAW VALUE (dBuV)	CORRECTION FACTOR (dB/m)
1	#5622.38	62.1 PK	68.2	-6.1	1.39 H	152	57.7	4.4
2	*5795.00	112.2 PK			1.39 H	152	107.8	4.4
3	*5795.00	101.6 AV			1.39 H	152	97.2	4.4
4	#5928.95	63.0 PK	68.2	-5.2	1.39 H	152	58.3	4.7
5	11590.00	54.3 PK	74.0	-19.7	1.69 H	299	40.8	13.5
6	11590.00	43.9 AV	54.0	-10.1	1.69 H	299	30.4	13.5
7	#17385.00	50.0 PK	74.0	-24.0	1.75 H	338	31.7	18.3
8	#17385.00	36.4 AV	54.0	-17.6	1.75 H	338	18.1	18.3

**ANTENNA POLARITY & TEST DISTANCE: VERTICAL AT 3 M**

NO.	FREQ. (MHz)	EMISSION LEVEL (dBuV/m)	LIMIT (dBuV/m)	MARGIN (dB)	ANTENNA HEIGHT (m)	TABLE ANGLE (Degree)	RAW VALUE (dBuV)	CORRECTION FACTOR (dB/m)
1	#5648.00	64.8 PK	68.2	-3.4	2.58 V	256	60.4	4.4
2	*5795.00	119.1 PK			2.58 V	256	114.7	4.4
3	*5795.00	109.2 AV			2.58 V	256	104.8	4.4
4	#5926.92	68.1 PK	68.2	-0.1	2.58 V	256	63.4	4.7
5	11590.00	56.6 PK	74.0	-17.4	2.05 V	329	43.1	13.5
6	11590.00	46.6 AV	54.0	-7.4	2.05 V	329	33.1	13.5
7	#17385.00	50.0 PK	74.0	-24.0	1.48 V	149	31.7	18.3
8	#17385.00	37.3 AV	54.0	-16.7	1.48 V	149	19.0	18.3

**REMARKS:**

1. Emission Level(dBuV/m) = Raw Value(dBuV) + Correction Factor(dB/m)
2. Correction Factor(dB/m) = Antenna Factor(dB/m) + Cable Factor(dB) – Pre-Amplifier Factor(dB)
3. The other emission levels were very low against the limit.
4. Margin value = Emission Level – Limit value
5. " \* ": Fundamental frequency.
6. " # ": The radiated frequency is out of the restricted band.

**802.11ac (VHT80)**

<b>CHANNEL</b>	TX Channel 42	<b>DETECTOR FUNCTION</b>	Peak (PK)
<b>FREQUENCY RANGE</b>	1GHz ~ 40GHz		Average (AV)

**ANTENNA POLARITY & TEST DISTANCE: HORIZONTAL AT 3 M**

NO.	FREQ. (MHz)	EMISSION LEVEL (dBuV/m)	LIMIT (dBuV/m)	MARGIN (dB)	ANTENNA HEIGHT (m)	TABLE ANGLE (Degree)	RAW VALUE (dBuV)	CORRECTION FACTOR (dB/m)
1	5150.00	61.0 PK	74.0	-13.0	1.39 H	170	57.3	3.7
2	5150.00	51.4 AV	54.0	-2.6	1.39 H	170	47.7	3.7
3	*5210.00	100.5 PK			1.39 H	170	96.8	3.7
4	*5210.00	92.8 AV			1.39 H	170	89.1	3.7
5	5350.00	47.8 PK	74.0	-26.2	1.39 H	170	43.7	4.1
6	5350.00	39.3 AV	54.0	-14.7	1.39 H	170	35.2	4.1
7	#10420.00	50.1 PK	74.0	-23.9	1.90 H	214	37.0	13.1
8	#10420.00	38.4 AV	54.0	-15.6	1.90 H	214	25.3	13.1
9	15630.00	44.6 PK	74.0	-29.4	2.19 H	360	31.0	13.6
10	15630.00	32.9 AV	54.0	-21.1	2.19 H	360	19.3	13.6

**ANTENNA POLARITY & TEST DISTANCE: VERTICAL AT 3 M**

NO.	FREQ. (MHz)	EMISSION LEVEL (dBuV/m)	LIMIT (dBuV/m)	MARGIN (dB)	ANTENNA HEIGHT (m)	TABLE ANGLE (Degree)	RAW VALUE (dBuV)	CORRECTION FACTOR (dB/m)
1	5150.00	63.7 PK	74.0	-10.3	2.82 V	255	60.0	3.7
2	5150.00	53.8 AV	54.0	-0.2	2.82 V	255	50.1	3.7
3	*5210.00	103.9 PK			2.82 V	255	100.2	3.7
4	*5210.00	95.5 AV			2.82 V	255	91.8	3.7
5	5350.00	50.4 PK	74.0	-23.6	2.82 V	255	46.3	4.1
6	5350.00	40.5 AV	54.0	-13.5	2.82 V	255	36.4	4.1
7	#10420.00	56.4 PK	74.0	-17.6	2.04 V	349	43.3	13.1
8	#10420.00	46.4 AV	54.0	-7.6	2.04 V	349	33.3	13.1
9	15630.00	49.8 PK	74.0	-24.2	1.49 V	142	36.2	13.6
10	15630.00	37.2 AV	54.0	-16.8	1.49 V	142	23.6	13.6

**REMARKS:**

1. Emission Level(dBuV/m) = Raw Value(dBuV) + Correction Factor(dB/m)
2. Correction Factor(dB/m) = Antenna Factor(dB/m) + Cable Factor(dB) – Pre-Amplifier Factor(dB)
3. The other emission levels were very low against the limit.
4. Margin value = Emission Level – Limit value
5. " \* ": Fundamental frequency.
6. " # ": The radiated frequency is out of the restricted band.

<b>CHANNEL</b>	TX Channel 155	<b>DETECTOR FUNCTION</b>	Peak (PK)
<b>FREQUENCY RANGE</b>	1GHz ~ 40GHz		Average (AV)

**ANTENNA POLARITY & TEST DISTANCE: HORIZONTAL AT 3 M**

NO.	FREQ. (MHz)	EMISSION LEVEL (dBuV/m)	LIMIT (dBuV/m)	MARGIN (dB)	ANTENNA HEIGHT (m)	TABLE ANGLE (Degree)	RAW VALUE (dBuV)	CORRECTION FACTOR (dB/m)
1	#5639.89	62.1 PK	68.2	-6.1	1.40 H	154	57.7	4.4
2	*5775.00	101.6 PK			1.40 H	154	97.2	4.4
3	*5775.00	92.6 AV			1.40 H	154	88.2	4.4
4	#5948.09	57.6 PK	68.2	-10.6	1.40 H	154	52.9	4.7
5	11550.00	53.7 PK	74.0	-20.3	1.77 H	312	40.2	13.5
6	11550.00	43.4 AV	54.0	-10.6	1.77 H	312	29.9	13.5
7	#17325.00	49.9 PK	74.0	-24.1	1.72 H	328	32.1	17.8
8	#17325.00	36.4 AV	54.0	-17.6	1.72 H	328	18.6	17.8

**ANTENNA POLARITY & TEST DISTANCE: VERTICAL AT 3 M**

NO.	FREQ. (MHz)	EMISSION LEVEL (dBuV/m)	LIMIT (dBuV/m)	MARGIN (dB)	ANTENNA HEIGHT (m)	TABLE ANGLE (Degree)	RAW VALUE (dBuV)	CORRECTION FACTOR (dB/m)
1	#5635.30	68.1 PK	68.2	-0.1	2.90 V	256	63.7	4.4
2	*5775.00	109.5 PK			2.90 V	256	105.1	4.4
3	*5775.00	101.3 AV			2.90 V	256	96.9	4.4
4	#5941.79	62.4 PK	68.2	-5.8	2.90 V	256	57.7	4.7
5	11550.00	56.7 PK	74.0	-17.3	2.03 V	340	43.2	13.5
6	11550.00	46.7 AV	54.0	-7.3	2.03 V	340	33.2	13.5
7	#17325.00	50.1 PK	74.0	-23.9	1.46 V	143	32.3	17.8
8	#17325.00	37.4 AV	54.0	-16.6	1.46 V	143	19.6	17.8

**REMARKS:**

1. Emission Level(dBuV/m) = Raw Value(dBuV) + Correction Factor(dB/m)
2. Correction Factor(dB/m) = Antenna Factor(dB/m) + Cable Factor(dB) – Pre-Amplifier Factor(dB)
3. The other emission levels were very low against the limit.
4. Margin value = Emission Level – Limit value
5. " \* ": Fundamental frequency.
6. " # ": The radiated frequency is out of the restricted band.

## 4.1.9 Test Results (Mode 3)

## Above 1GHz Data:

## 802.11a

<b>CHANNEL</b>	TX Channel 36	<b>DETECTOR FUNCTION</b>	Peak (PK)
<b>FREQUENCY RANGE</b>	1GHz ~ 40GHz		Average (AV)

ANTENNA POLARITY & TEST DISTANCE: HORIZONTAL AT 3 M								
NO.	FREQ. (MHz)	EMISSION LEVEL (dBuV/m)	LIMIT (dBuV/m)	MARGIN (dB)	ANTENNA HEIGHT (m)	TABLE ANGLE (Degree)	RAW VALUE (dBuV)	CORRECTION FACTOR (dB/m)
1	5150.00	63.9 PK	74.0	-10.1	1.03 H	155	60.2	3.7
2	5150.00	52.6 AV	54.0	-1.4	1.03 H	155	48.9	3.7
3	*5180.00	110.9 PK			1.03 H	155	107.2	3.7
4	*5180.00	100.2 AV			1.03 H	155	96.5	3.7
5	#10360.00	46.4 PK	74.0	-27.6	1.70 H	294	33.4	13.0
6	#10360.00	34.2 AV	54.0	-19.8	1.70 H	294	21.2	13.0
7	15540.00	45.5 PK	74.0	-28.5	1.70 H	314	32.4	13.1
8	15540.00	32.9 AV	54.0	-21.1	1.70 H	314	19.8	13.1

ANTENNA POLARITY & TEST DISTANCE: VERTICAL AT 3 M								
NO.	FREQ. (MHz)	EMISSION LEVEL (dBuV/m)	LIMIT (dBuV/m)	MARGIN (dB)	ANTENNA HEIGHT (m)	TABLE ANGLE (Degree)	RAW VALUE (dBuV)	CORRECTION FACTOR (dB/m)
1	5150.00	67.7 PK	74.0	-6.3	2.39 V	198	64.0	3.7
2	5150.00	53.8 AV	54.0	-0.2	2.39 V	198	50.1	3.7
3	*5180.00	113.8 PK			2.39 V	198	110.1	3.7
4	*5180.00	102.6 AV			2.39 V	198	98.9	3.7
5	#10360.00	48.4 PK	74.0	-25.6	1.92 V	321	35.4	13.0
6	#10360.00	36.7 AV	54.0	-17.3	1.92 V	321	23.7	13.0
7	15540.00	45.3 PK	74.0	-28.7	1.73 V	210	32.2	13.1
8	15540.00	33.0 AV	54.0	-21.0	1.73 V	210	19.9	13.1

## REMARKS:

- Emission Level(dBuV/m) = Raw Value(dBuV) + Correction Factor(dB/m)
- Correction Factor(dB/m) = Antenna Factor(dB/m) + Cable Factor(dB) – Pre-Amplifier Factor(dB)
- The other emission levels were very low against the limit.
- Margin value = Emission Level – Limit value
- " \* ": Fundamental frequency.
- " # ": The radiated frequency is out of the restricted band.

<b>CHANNEL</b>	TX Channel 40	<b>DETECTOR FUNCTION</b>	Peak (PK)
<b>FREQUENCY RANGE</b>	1GHz ~ 40GHz		Average (AV)

**ANTENNA POLARITY & TEST DISTANCE: HORIZONTAL AT 3 M**

NO.	FREQ. (MHz)	EMISSION LEVEL (dBuV/m)	LIMIT (dBuV/m)	MARGIN (dB)	ANTENNA HEIGHT (m)	TABLE ANGLE (Degree)	RAW VALUE (dBuV)	CORRECTION FACTOR (dB/m)
1	5150.00	62.7 PK	74.0	-11.3	1.08 H	145	59.0	3.7
2	5150.00	53.0 AV	54.0	-1.0	1.08 H	145	49.3	3.7
3	*5200.00	114.6 PK			1.08 H	145	110.9	3.7
4	*5200.00	103.5 AV			1.08 H	145	99.8	3.7
5	5350.00	45.5 PK	74.0	-28.5	1.08 H	145	41.4	4.1
6	5350.00	35.3 AV	54.0	-18.7	1.08 H	145	31.2	4.1
7	#10400.00	47.1 PK	74.0	-26.9	1.73 H	289	34.1	13.0
8	#10400.00	34.7 AV	54.0	-19.3	1.73 H	289	21.7	13.0
9	15600.00	45.9 PK	74.0	-28.1	1.66 H	312	32.6	13.3
10	15600.00	33.4 AV	54.0	-20.6	1.66 H	312	20.1	13.3

**ANTENNA POLARITY & TEST DISTANCE: VERTICAL AT 3 M**

NO.	FREQ. (MHz)	EMISSION LEVEL (dBuV/m)	LIMIT (dBuV/m)	MARGIN (dB)	ANTENNA HEIGHT (m)	TABLE ANGLE (Degree)	RAW VALUE (dBuV)	CORRECTION FACTOR (dB/m)
1	5150.00	66.5 PK	74.0	-7.5	2.51 V	252	62.8	3.7
2	5150.00	53.9 AV	54.0	-0.1	2.51 V	252	50.2	3.7
3	*5200.00	117.4 PK			2.51 V	252	113.7	3.7
4	*5200.00	106.1 AV			2.51 V	252	102.4	3.7
5	5350.00	48.9 PK	74.0	-25.1	2.51 V	252	44.8	4.1
6	5350.00	36.4 AV	54.0	-17.6	2.51 V	252	32.3	4.1
7	#10400.00	48.1 PK	74.0	-25.9	1.89 V	306	35.1	13.0
8	#10400.00	36.6 AV	54.0	-17.4	1.89 V	306	23.6	13.0
9	15600.00	45.9 PK	74.0	-28.1	1.70 V	218	32.6	13.3
10	15600.00	33.5 AV	54.0	-20.5	1.70 V	218	20.2	13.3

**REMARKS:**

- Emission Level(dBuV/m) = Raw Value(dBuV) + Correction Factor(dB/m)
- Correction Factor(dB/m) = Antenna Factor(dB/m) + Cable Factor(dB) – Pre-Amplifier Factor(dB)
- The other emission levels were very low against the limit.
- Margin value = Emission Level – Limit value
- " \* ": Fundamental frequency.
- " # ": The radiated frequency is out of the restricted band.

<b>CHANNEL</b>	TX Channel 48	<b>DETECTOR FUNCTION</b>	Peak (PK)
<b>FREQUENCY RANGE</b>	1GHz ~ 40GHz		Average (AV)

**ANTENNA POLARITY & TEST DISTANCE: HORIZONTAL AT 3 M**

NO.	FREQ. (MHz)	EMISSION LEVEL (dBuV/m)	LIMIT (dBuV/m)	MARGIN (dB)	ANTENNA HEIGHT (m)	TABLE ANGLE (Degree)	RAW VALUE (dBuV)	CORRECTION FACTOR (dB/m)
1	5146.00	48.4 PK	74.0	-25.6	1.06 H	152	44.8	3.6
2	5146.00	39.4 AV	54.0	-14.6	1.06 H	152	35.8	3.6
3	*5240.00	113.2 PK			1.06 H	152	109.4	3.8
4	*5240.00	102.8 AV			1.06 H	152	99.0	3.8
5	5350.00	46.0 PK	74.0	-28.0	1.06 H	152	41.9	4.1
6	5350.00	36.9 AV	54.0	-17.1	1.06 H	152	32.8	4.1
7	#10480.00	46.8 PK	74.0	-27.2	1.68 H	288	33.6	13.2
8	#10480.00	34.5 AV	54.0	-19.5	1.68 H	288	21.3	13.2
9	15720.00	45.4 PK	74.0	-28.6	1.75 H	306	31.8	13.6
10	15720.00	32.7 AV	54.0	-21.3	1.75 H	306	19.1	13.6

**ANTENNA POLARITY & TEST DISTANCE: VERTICAL AT 3 M**

NO.	FREQ. (MHz)	EMISSION LEVEL (dBuV/m)	LIMIT (dBuV/m)	MARGIN (dB)	ANTENNA HEIGHT (m)	TABLE ANGLE (Degree)	RAW VALUE (dBuV)	CORRECTION FACTOR (dB/m)
1	5146.00	52.6 PK	74.0	-21.4	2.52 V	249	49.0	3.6
2	5146.00	40.9 AV	54.0	-13.1	2.52 V	249	37.3	3.6
3	*5240.00	116.5 PK			2.52 V	249	112.7	3.8
4	*5240.00	105.5 AV			2.52 V	249	101.7	3.8
5	5350.00	49.8 PK	74.0	-24.2	2.52 V	249	45.7	4.1
6	5350.00	38.2 AV	54.0	-15.8	2.52 V	249	34.1	4.1
7	#10480.00	48.3 PK	74.0	-25.7	1.94 V	322	35.1	13.2
8	#10480.00	36.7 AV	54.0	-17.3	1.94 V	322	23.5	13.2
9	15720.00	45.6 PK	74.0	-28.4	1.78 V	200	32.0	13.6
10	15720.00	33.5 AV	54.0	-20.5	1.78 V	200	19.9	13.6

**REMARKS:**

- Emission Level(dBuV/m) = Raw Value(dBuV) + Correction Factor(dB/m)
- Correction Factor(dB/m) = Antenna Factor(dB/m) + Cable Factor(dB) – Pre-Amplifier Factor(dB)
- The other emission levels were very low against the limit.
- Margin value = Emission Level – Limit value
- " \* ": Fundamental frequency.
- " # ": The radiated frequency is out of the restricted band.



<b>CHANNEL</b>	TX Channel 149	<b>DETECTOR FUNCTION</b>	Peak (PK)
<b>FREQUENCY RANGE</b>	1GHz ~ 40GHz		Average (AV)

**ANTENNA POLARITY & TEST DISTANCE: HORIZONTAL AT 3 M**

NO.	FREQ. (MHz)	EMISSION LEVEL (dBuV/m)	LIMIT (dBuV/m)	MARGIN (dB)	ANTENNA HEIGHT (m)	TABLE ANGLE (Degree)	RAW VALUE (dBuV)	CORRECTION FACTOR (dB/m)
1	#5653.70	62.8 PK	70.9	-8.1	1.22 H	154	58.5	4.3
2	*5745.00	114.0 PK			1.22 H	154	109.6	4.4
3	*5745.00	101.5 AV			1.22 H	154	97.1	4.4
4	#5971.99	59.0 PK	68.2	-9.2	1.22 H	154	54.3	4.7
5	11490.00	52.4 PK	74.0	-21.6	1.69 H	300	38.9	13.5
6	11490.00	42.3 AV	54.0	-11.7	1.69 H	300	28.8	13.5
7	#17235.00	49.5 PK	74.0	-24.5	1.76 H	360	32.2	17.3
8	#17235.00	36.5 AV	54.0	-17.5	1.76 H	360	19.2	17.3

**ANTENNA POLARITY & TEST DISTANCE: VERTICAL AT 3 M**

NO.	FREQ. (MHz)	EMISSION LEVEL (dBuV/m)	LIMIT (dBuV/m)	MARGIN (dB)	ANTENNA HEIGHT (m)	TABLE ANGLE (Degree)	RAW VALUE (dBuV)	CORRECTION FACTOR (dB/m)
1	#5646.38	63.9 PK	68.2	-4.3	2.54 V	254	59.5	4.4
2	*5745.00	120.7 PK			2.54 V	254	116.3	4.4
3	*5745.00	108.8 AV			2.54 V	254	104.4	4.4
4	#5988.43	57.5 PK	68.2	-10.7	2.54 V	254	52.8	4.7
5	11490.00	54.7 PK	74.0	-19.3	2.01 V	335	41.2	13.5
6	11490.00	44.5 AV	54.0	-9.5	2.01 V	335	31.0	13.5
7	#17235.00	50.2 PK	74.0	-23.8	1.69 V	120	32.9	17.3
8	#17235.00	37.6 AV	54.0	-16.4	1.69 V	120	20.3	17.3

**REMARKS:**

- Emission Level(dBuV/m) = Raw Value(dBuV) + Correction Factor(dB/m)
- Correction Factor(dB/m) = Antenna Factor(dB/m) + Cable Factor(dB) – Pre-Amplifier Factor(dB)
- The other emission levels were very low against the limit.
- Margin value = Emission Level – Limit value
- " \* ": Fundamental frequency.
- " # ": The radiated frequency is out of the restricted band.

<b>CHANNEL</b>	TX Channel 157	<b>DETECTOR FUNCTION</b>	Peak (PK)
<b>FREQUENCY RANGE</b>	1GHz ~ 40GHz		Average (AV)

**ANTENNA POLARITY & TEST DISTANCE: HORIZONTAL AT 3 M**

NO.	FREQ. (MHz)	EMISSION LEVEL (dBuV/m)	LIMIT (dBuV/m)	MARGIN (dB)	ANTENNA HEIGHT (m)	TABLE ANGLE (Degree)	RAW VALUE (dBuV)	CORRECTION FACTOR (dB/m)
1	#5676.42	61.0 PK	87.8	-26.8	1.24 H	152	56.7	4.3
2	*5785.00	114.3 PK			1.24 H	152	109.9	4.4
3	*5785.00	101.8 AV			1.24 H	152	97.4	4.4
4	#5983.14	58.3 PK	68.2	-9.9	1.24 H	152	53.6	4.7
5	11570.00	52.0 PK	74.0	-22.0	1.70 H	303	38.5	13.5
6	11570.00	41.9 AV	54.0	-12.1	1.70 H	303	28.4	13.5
7	#17355.00	49.5 PK	74.0	-24.5	1.77 H	355	31.5	18.0
8	#17355.00	36.2 AV	54.0	-17.8	1.77 H	355	18.2	18.0

**ANTENNA POLARITY & TEST DISTANCE: VERTICAL AT 3 M**

NO.	FREQ. (MHz)	EMISSION LEVEL (dBuV/m)	LIMIT (dBuV/m)	MARGIN (dB)	ANTENNA HEIGHT (m)	TABLE ANGLE (Degree)	RAW VALUE (dBuV)	CORRECTION FACTOR (dB/m)
1	#5626.05	58.6 PK	68.2	-9.6	2.49 V	255	54.2	4.4
2	*5785.00	121.4 PK			2.49 V	255	117.0	4.4
3	*5785.00	108.9 AV			2.49 V	255	104.5	4.4
4	#5954.98	58.9 PK	68.2	-9.3	2.49 V	255	54.2	4.7
5	11570.00	55.0 PK	74.0	-19.0	2.04 V	343	41.5	13.5
6	11570.00	44.8 AV	54.0	-9.2	2.04 V	343	31.3	13.5
7	#17355.00	50.0 PK	74.0	-24.0	1.65 V	105	32.0	18.0
8	#17355.00	37.4 AV	54.0	-16.6	1.65 V	105	19.4	18.0

**REMARKS:**

1. Emission Level(dBuV/m) = Raw Value(dBuV) + Correction Factor(dB/m)
2. Correction Factor(dB/m) = Antenna Factor(dB/m) + Cable Factor(dB) – Pre-Amplifier Factor(dB)
3. The other emission levels were very low against the limit.
4. Margin value = Emission Level – Limit value
5. " \* ": Fundamental frequency.
6. " # ": The radiated frequency is out of the restricted band.

<b>CHANNEL</b>	TX Channel 165	<b>DETECTOR FUNCTION</b>	Peak (PK)
<b>FREQUENCY RANGE</b>	1GHz ~ 40GHz		Average (AV)

**ANTENNA POLARITY & TEST DISTANCE: HORIZONTAL AT 3 M**

NO.	FREQ. (MHz)	EMISSION LEVEL (dBuV/m)	LIMIT (dBuV/m)	MARGIN (dB)	ANTENNA HEIGHT (m)	TABLE ANGLE (Degree)	RAW VALUE (dBuV)	CORRECTION FACTOR (dB/m)
1	#5625.06	58.9 PK	68.2	-9.3	1.18 H	152	54.5	4.4
2	*5825.00	113.9 PK			1.18 H	152	109.5	4.4
3	*5825.00	101.4 AV			1.18 H	152	97.0	4.4
4	#5939.54	59.1 PK	68.2	-9.1	1.18 H	152	54.4	4.7
5	11650.00	51.9 PK	74.0	-22.1	1.66 H	310	38.2	13.7
6	11650.00	41.9 AV	54.0	-12.1	1.66 H	310	28.2	13.7
7	#17475.00	49.3 PK	74.0	-24.7	1.77 H	355	30.7	18.6
8	#17475.00	36.2 AV	54.0	-17.8	1.77 H	355	17.6	18.6

**ANTENNA POLARITY & TEST DISTANCE: VERTICAL AT 3 M**

NO.	FREQ. (MHz)	EMISSION LEVEL (dBuV/m)	LIMIT (dBuV/m)	MARGIN (dB)	ANTENNA HEIGHT (m)	TABLE ANGLE (Degree)	RAW VALUE (dBuV)	CORRECTION FACTOR (dB/m)
1	#5612.06	58.4 PK	68.2	-9.8	2.49 V	257	54.0	4.4
2	*5825.00	120.6 PK			2.49 V	257	116.2	4.4
3	*5825.00	108.7 AV			2.49 V	257	104.3	4.4
4	#5934.42	61.7 PK	68.2	-6.5	2.49 V	257	57.0	4.7
5	11650.00	55.0 PK	74.0	-19.0	1.96 V	325	41.3	13.7
6	11650.00	44.9 AV	54.0	-9.1	1.96 V	325	31.2	13.7
7	#17475.00	50.0 PK	74.0	-24.0	1.74 V	107	31.4	18.6
8	#17475.00	37.4 AV	54.0	-16.6	1.74 V	107	18.8	18.6

**REMARKS:**

1. Emission Level(dBuV/m) = Raw Value(dBuV) + Correction Factor(dB/m)
2. Correction Factor(dB/m) = Antenna Factor(dB/m) + Cable Factor(dB) – Pre-Amplifier Factor(dB)
3. The other emission levels were very low against the limit.
4. Margin value = Emission Level – Limit value
5. " \* ": Fundamental frequency.
6. " # ": The radiated frequency is out of the restricted band.

**802.11ac (VHT20)**

<b>CHANNEL</b>	TX Channel 36	<b>DETECTOR FUNCTION</b>	Peak (PK)
<b>FREQUENCY RANGE</b>	1GHz ~ 40GHz		Average (AV)

**ANTENNA POLARITY & TEST DISTANCE: HORIZONTAL AT 3 M**

NO.	FREQ. (MHz)	EMISSION LEVEL (dBuV/m)	LIMIT (dBuV/m)	MARGIN (dB)	ANTENNA HEIGHT (m)	TABLE ANGLE (Degree)	RAW VALUE (dBuV)	CORRECTION FACTOR (dB/m)
1	5150.00	62.1 PK	74.0	-11.9	1.02 H	166	58.4	3.7
2	5150.00	52.4 AV	54.0	-1.6	1.02 H	166	48.7	3.7
3	*5180.00	111.4 PK			1.02 H	166	107.7	3.7
4	*5180.00	100.4 AV			1.02 H	166	96.7	3.7
5	#10360.00	47.3 PK	74.0	-26.7	1.67 H	278	34.3	13.0
6	#10360.00	34.7 AV	54.0	-19.3	1.67 H	278	21.7	13.0
7	15540.00	45.5 PK	74.0	-28.5	1.65 H	317	32.4	13.1
8	15540.00	33.1 AV	54.0	-20.9	1.65 H	317	20.0	13.1

**ANTENNA POLARITY & TEST DISTANCE: VERTICAL AT 3 M**

NO.	FREQ. (MHz)	EMISSION LEVEL (dBuV/m)	LIMIT (dBuV/m)	MARGIN (dB)	ANTENNA HEIGHT (m)	TABLE ANGLE (Degree)	RAW VALUE (dBuV)	CORRECTION FACTOR (dB/m)
1	5150.00	66.4 PK	74.0	-7.6	2.32 V	201	62.7	3.7
2	<b>5150.00</b>	<b>53.9 AV</b>	<b>54.0</b>	<b>-0.1</b>	<b>2.32 V</b>	<b>201</b>	<b>50.2</b>	<b>3.7</b>
3	*5180.00	113.7 PK			2.32 V	201	110.0	3.7
4	*5180.00	102.5 AV			2.32 V	201	98.8	3.7
5	#10360.00	48.7 PK	74.0	-25.3	1.96 V	308	35.7	13.0
6	#10360.00	36.7 AV	54.0	-17.3	1.96 V	308	23.7	13.0
7	15540.00	44.8 PK	74.0	-29.2	1.73 V	222	31.7	13.1
8	15540.00	32.5 AV	54.0	-21.5	1.73 V	222	19.4	13.1

**REMARKS:**

- Emission Level(dBuV/m) = Raw Value(dBuV) + Correction Factor(dB/m)
- Correction Factor(dB/m) = Antenna Factor(dB/m) + Cable Factor(dB) – Pre-Amplifier Factor(dB)
- The other emission levels were very low against the limit.
- Margin value = Emission Level – Limit value
- " \* ": Fundamental frequency.
- " # ": The radiated frequency is out of the restricted band.

<b>CHANNEL</b>	TX Channel 40	<b>DETECTOR FUNCTION</b>	Peak (PK)
<b>FREQUENCY RANGE</b>	1GHz ~ 40GHz		Average (AV)

**ANTENNA POLARITY & TEST DISTANCE: HORIZONTAL AT 3 M**

NO.	FREQ. (MHz)	EMISSION LEVEL (dBuV/m)	LIMIT (dBuV/m)	MARGIN (dB)	ANTENNA HEIGHT (m)	TABLE ANGLE (Degree)	RAW VALUE (dBuV)	CORRECTION FACTOR (dB/m)
1	5150.00	61.6 PK	74.0	-12.4	1.04 H	147	57.9	3.7
2	5150.00	52.7 AV	54.0	-1.3	1.04 H	147	49.0	3.7
3	*5200.00	113.8 PK			1.04 H	147	110.1	3.7
4	*5200.00	102.8 AV			1.04 H	147	99.1	3.7
5	5350.00	45.3 PK	74.0	-28.7	1.04 H	147	41.2	4.1
6	5350.00	35.1 AV	54.0	-18.9	1.04 H	147	31.0	4.1
7	#10400.00	47.5 PK	74.0	-26.5	1.69 H	293	34.5	13.0
8	#10400.00	34.9 AV	54.0	-19.1	1.69 H	293	21.9	13.0
9	15600.00	46.5 PK	74.0	-27.5	1.61 H	301	33.2	13.3
10	15600.00	33.9 AV	54.0	-20.1	1.61 H	301	20.6	13.3

**ANTENNA POLARITY & TEST DISTANCE: VERTICAL AT 3 M**

NO.	FREQ. (MHz)	EMISSION LEVEL (dBuV/m)	LIMIT (dBuV/m)	MARGIN (dB)	ANTENNA HEIGHT (m)	TABLE ANGLE (Degree)	RAW VALUE (dBuV)	CORRECTION FACTOR (dB/m)
1	5150.00	65.6 PK	74.0	-8.4	2.35 V	199	61.9	3.7
2	5150.00	53.9 AV	54.0	-0.1	2.35 V	199	50.2	3.7
3	*5200.00	116.8 PK			2.35 V	199	113.1	3.7
4	*5200.00	105.3 AV			2.35 V	199	101.6	3.7
5	5350.00	49.5 PK	74.0	-24.5	2.35 V	199	45.4	4.1
6	5350.00	36.6 AV	54.0	-17.4	2.35 V	199	32.5	4.1
7	#10400.00	48.8 PK	74.0	-25.2	1.93 V	321	35.8	13.0
8	#10400.00	36.9 AV	54.0	-17.1	1.93 V	321	23.9	13.0
9	15600.00	45.6 PK	74.0	-28.4	1.78 V	219	32.3	13.3
10	15600.00	33.5 AV	54.0	-20.5	1.78 V	219	20.2	13.3

**REMARKS:**

1. Emission Level(dBuV/m) = Raw Value(dBuV) + Correction Factor(dB/m)
2. Correction Factor(dB/m) = Antenna Factor(dB/m) + Cable Factor(dB) – Pre-Amplifier Factor(dB)
3. The other emission levels were very low against the limit.
4. Margin value = Emission Level – Limit value
5. " \* ": Fundamental frequency.
6. " # ": The radiated frequency is out of the restricted band.

<b>CHANNEL</b>	TX Channel 48	<b>DETECTOR FUNCTION</b>	Peak (PK)
<b>FREQUENCY RANGE</b>	1GHz ~ 40GHz		Average (AV)

**ANTENNA POLARITY & TEST DISTANCE: HORIZONTAL AT 3 M**

NO.	FREQ. (MHz)	EMISSION LEVEL (dBuV/m)	LIMIT (dBuV/m)	MARGIN (dB)	ANTENNA HEIGHT (m)	TABLE ANGLE (Degree)	RAW VALUE (dBuV)	CORRECTION FACTOR (dB/m)
1	*5240.00	112.5 PK			1.00 H	164	108.7	3.8
2	*5240.00	101.3 AV			1.00 H	164	97.5	3.8
3	5350.00	45.4 PK	74.0	-28.6	1.00 H	164	41.3	4.1
4	5350.00	36.1 AV	54.0	-17.9	1.00 H	164	32.0	4.1
5	#10480.00	46.8 PK	74.0	-27.2	1.78 H	277	33.6	13.2
6	#10480.00	34.5 AV	54.0	-19.5	1.78 H	277	21.3	13.2
7	15720.00	46.1 PK	74.0	-27.9	1.61 H	297	32.5	13.6
8	15720.00	33.6 AV	54.0	-20.4	1.61 H	297	20.0	13.6

**ANTENNA POLARITY & TEST DISTANCE: VERTICAL AT 3 M**

NO.	FREQ. (MHz)	EMISSION LEVEL (dBuV/m)	LIMIT (dBuV/m)	MARGIN (dB)	ANTENNA HEIGHT (m)	TABLE ANGLE (Degree)	RAW VALUE (dBuV)	CORRECTION FACTOR (dB/m)
1	*5240.00	115.8 PK			2.29 V	202	112.0	3.8
2	*5240.00	104.1 AV			2.29 V	202	100.3	3.8
3	5350.00	49.1 PK	74.0	-24.9	2.29 V	202	45.0	4.1
4	5350.00	37.1 AV	54.0	-16.9	2.29 V	202	33.0	4.1
5	#10480.00	49.0 PK	74.0	-25.0	1.94 V	326	35.8	13.2
6	#10480.00	37.0 AV	54.0	-17.0	1.94 V	326	23.8	13.2
7	15720.00	44.9 PK	74.0	-29.1	1.76 V	205	31.3	13.6
8	15720.00	32.6 AV	54.0	-21.4	1.76 V	205	19.0	13.6

**REMARKS:**

1. Emission Level(dBuV/m) = Raw Value(dBuV) + Correction Factor(dB/m)
2. Correction Factor(dB/m) = Antenna Factor(dB/m) + Cable Factor(dB) – Pre-Amplifier Factor(dB)
3. The other emission levels were very low against the limit.
4. Margin value = Emission Level – Limit value
5. " \* ": Fundamental frequency.
6. " # ": The radiated frequency is out of the restricted band.

<b>CHANNEL</b>	TX Channel 149	<b>DETECTOR FUNCTION</b>	Peak (PK)
<b>FREQUENCY RANGE</b>	1GHz ~ 40GHz		Average (AV)

**ANTENNA POLARITY & TEST DISTANCE: HORIZONTAL AT 3 M**

NO.	FREQ. (MHz)	EMISSION LEVEL (dBuV/m)	LIMIT (dBuV/m)	MARGIN (dB)	ANTENNA HEIGHT (m)	TABLE ANGLE (Degree)	RAW VALUE (dBuV)	CORRECTION FACTOR (dB/m)
1	#5646.09	60.1 PK	68.2	-8.1	1.02 H	164	55.7	4.4
2	*5745.00	113.3 PK			1.02 H	164	108.9	4.4
3	*5745.00	101.2 AV			1.02 H	164	96.8	4.4
4	#5932.56	58.9 PK	68.2	-9.3	1.02 H	164	54.2	4.7
5	11490.00	52.6 PK	74.0	-21.4	1.75 H	288	39.1	13.5
6	11490.00	42.3 AV	54.0	-11.7	1.75 H	288	28.8	13.5
7	#17235.00	49.3 PK	74.0	-24.7	1.78 H	360	32.0	17.3
8	#17235.00	35.7 AV	54.0	-18.3	1.78 H	360	18.4	17.3

**ANTENNA POLARITY & TEST DISTANCE: VERTICAL AT 3 M**

NO.	FREQ. (MHz)	EMISSION LEVEL (dBuV/m)	LIMIT (dBuV/m)	MARGIN (dB)	ANTENNA HEIGHT (m)	TABLE ANGLE (Degree)	RAW VALUE (dBuV)	CORRECTION FACTOR (dB/m)
1	#5644.98	66.6 PK	68.2	-1.6	2.64 V	255	62.2	4.4
2	*5745.00	120.0 PK			2.64 V	255	115.6	4.4
3	*5745.00	108.9 AV			2.64 V	255	104.5	4.4
4	#5986.61	57.8 PK	68.2	-10.4	2.64 V	255	53.1	4.7
5	11490.00	54.7 PK	74.0	-19.3	2.02 V	332	41.2	13.5
6	11490.00	44.7 AV	54.0	-9.3	2.02 V	332	31.2	13.5
7	#17235.00	50.4 PK	74.0	-23.6	1.77 V	118	33.1	17.3
8	#17235.00	37.7 AV	54.0	-16.3	1.77 V	118	20.4	17.3

**REMARKS:**

- Emission Level(dBuV/m) = Raw Value(dBuV) + Correction Factor(dB/m)
- Correction Factor(dB/m) = Antenna Factor(dB/m) + Cable Factor(dB) – Pre-Amplifier Factor(dB)
- The other emission levels were very low against the limit.
- Margin value = Emission Level – Limit value
- " \* ": Fundamental frequency.
- " # ": The radiated frequency is out of the restricted band.

<b>CHANNEL</b>	TX Channel 157	<b>DETECTOR FUNCTION</b>	Peak (PK)
<b>FREQUENCY RANGE</b>	1GHz ~ 40GHz		Average (AV)

**ANTENNA POLARITY & TEST DISTANCE: HORIZONTAL AT 3 M**

NO.	FREQ. (MHz)	EMISSION LEVEL (dBuV/m)	LIMIT (dBuV/m)	MARGIN (dB)	ANTENNA HEIGHT (m)	TABLE ANGLE (Degree)	RAW VALUE (dBuV)	CORRECTION FACTOR (dB/m)
1	#5579.13	58.7 PK	68.2	-9.5	1.01 H	154	54.5	4.2
2	*5785.00	113.5 PK			1.01 H	154	109.1	4.4
3	*5785.00	101.6 AV			1.01 H	154	97.2	4.4
4	#5937.45	58.8 PK	68.2	-9.4	1.01 H	154	54.1	4.7
5	11570.00	51.6 PK	74.0	-22.4	1.70 H	316	38.1	13.5
6	11570.00	41.4 AV	54.0	-12.6	1.70 H	316	27.9	13.5
7	#17355.00	49.5 PK	74.0	-24.5	1.72 H	354	31.5	18.0
8	#17355.00	36.3 AV	54.0	-17.7	1.72 H	354	18.3	18.0

**ANTENNA POLARITY & TEST DISTANCE: VERTICAL AT 3 M**

NO.	FREQ. (MHz)	EMISSION LEVEL (dBuV/m)	LIMIT (dBuV/m)	MARGIN (dB)	ANTENNA HEIGHT (m)	TABLE ANGLE (Degree)	RAW VALUE (dBuV)	CORRECTION FACTOR (dB/m)
1	#5640.52	59.6 PK	68.2	-8.6	2.64 V	255	55.2	4.4
2	*5785.00	120.0 PK			2.65 V	258	115.6	4.4
3	*5785.00	109.1 AV			2.65 V	258	104.7	4.4
4	#6010.11	58.9 PK	68.2	-9.3	2.64 V	255	54.1	4.8
5	11570.00	54.7 PK	74.0	-19.3	1.94 V	329	41.2	13.5
6	11570.00	44.4 AV	54.0	-9.6	1.94 V	329	30.9	13.5
7	#17355.00	49.6 PK	74.0	-24.4	1.69 V	113	31.6	18.0
8	#17355.00	37.2 AV	54.0	-16.8	1.69 V	113	19.2	18.0

**REMARKS:**

1. Emission Level(dBuV/m) = Raw Value(dBuV) + Correction Factor(dB/m)
2. Correction Factor(dB/m) = Antenna Factor(dB/m) + Cable Factor(dB) – Pre-Amplifier Factor(dB)
3. The other emission levels were very low against the limit.
4. Margin value = Emission Level – Limit value
5. " \* ": Fundamental frequency.
6. " # ": The radiated frequency is out of the restricted band.



<b>CHANNEL</b>	TX Channel 165	<b>DETECTOR FUNCTION</b>	Peak (PK)
<b>FREQUENCY RANGE</b>	1GHz ~ 40GHz		Average (AV)

**ANTENNA POLARITY & TEST DISTANCE: HORIZONTAL AT 3 M**

NO.	FREQ. (MHz)	EMISSION LEVEL (dBuV/m)	LIMIT (dBuV/m)	MARGIN (dB)	ANTENNA HEIGHT (m)	TABLE ANGLE (Degree)	RAW VALUE (dBuV)	CORRECTION FACTOR (dB/m)
1	#5572.19	58.4 PK	68.2	-9.8	1.03 H	161	54.2	4.2
2	*5825.00	113.0 PK			1.03 H	161	108.6	4.4
3	*5825.00	101.1 AV			1.03 H	161	96.7	4.4
4	#6002.96	58.1 PK	68.2	-10.1	1.03 H	161	53.3	4.8
5	11650.00	52.5 PK	74.0	-21.5	1.66 H	317	38.8	13.7
6	11650.00	42.3 AV	54.0	-11.7	1.66 H	317	28.6	13.7
7	#17475.00	49.4 PK	74.0	-24.6	1.80 H	339	30.8	18.6
8	#17475.00	36.1 AV	54.0	-17.9	1.80 H	339	17.5	18.6

**ANTENNA POLARITY & TEST DISTANCE: VERTICAL AT 3 M**

NO.	FREQ. (MHz)	EMISSION LEVEL (dBuV/m)	LIMIT (dBuV/m)	MARGIN (dB)	ANTENNA HEIGHT (m)	TABLE ANGLE (Degree)	RAW VALUE (dBuV)	CORRECTION FACTOR (dB/m)
1	#5591.54	58.7 PK	68.2	-9.5	2.69 V	259	54.4	4.3
2	*5825.00	119.5 PK			2.69 V	259	115.1	4.4
3	*5825.00	108.6 AV			2.69 V	259	104.2	4.4
4	#5926.88	60.7 PK	68.2	-7.5	2.69 V	259	56.0	4.7
5	11650.00	55.1 PK	74.0	-18.9	1.97 V	337	41.4	13.7
6	11650.00	44.9 AV	54.0	-9.1	1.97 V	337	31.2	13.7
7	#17475.00	49.8 PK	74.0	-24.2	1.76 V	112	31.2	18.6
8	#17475.00	37.0 AV	54.0	-17.0	1.76 V	112	18.4	18.6

**REMARKS:**

1. Emission Level(dBuV/m) = Raw Value(dBuV) + Correction Factor(dB/m)
2. Correction Factor(dB/m) = Antenna Factor(dB/m) + Cable Factor(dB) – Pre-Amplifier Factor(dB)
3. The other emission levels were very low against the limit.
4. Margin value = Emission Level – Limit value
5. " \* ": Fundamental frequency.
6. " # ": The radiated frequency is out of the restricted band.

802.11ac (VHT40)

<b>CHANNEL</b>	TX Channel 38	<b>DETECTOR FUNCTION</b>	Peak (PK)
<b>FREQUENCY RANGE</b>	1GHz ~ 40GHz		Average (AV)

**ANTENNA POLARITY & TEST DISTANCE: HORIZONTAL AT 3 M**

NO.	FREQ. (MHz)	EMISSION LEVEL (dBuV/m)	LIMIT (dBuV/m)	MARGIN (dB)	ANTENNA HEIGHT (m)	TABLE ANGLE (Degree)	RAW VALUE (dBuV)	CORRECTION FACTOR (dB/m)
1	5150.00	60.9 PK	74.0	-13.1	1.02 H	142	57.2	3.7
2	5150.00	51.4 AV	54.0	-2.6	1.02 H	142	47.7	3.7
3	*5190.00	104.8 PK			1.02 H	142	101.1	3.7
4	*5190.00	95.9 AV			1.02 H	142	92.2	3.7
5	5350.00	43.5 PK	74.0	-30.5	1.02 H	142	39.4	4.1
6	5350.00	34.5 AV	54.0	-19.5	1.02 H	142	30.4	4.1
7	#10380.00	47.6 PK	74.0	-26.4	1.63 H	308	34.5	13.1
8	#10380.00	35.0 AV	54.0	-19.0	1.63 H	308	21.9	13.1
9	15570.00	46.8 PK	74.0	-27.2	1.65 H	312	33.5	13.3
10	15570.00	34.0 AV	54.0	-20.0	1.65 H	312	20.7	13.3

**ANTENNA POLARITY & TEST DISTANCE: VERTICAL AT 3 M**

NO.	FREQ. (MHz)	EMISSION LEVEL (dBuV/m)	LIMIT (dBuV/m)	MARGIN (dB)	ANTENNA HEIGHT (m)	TABLE ANGLE (Degree)	RAW VALUE (dBuV)	CORRECTION FACTOR (dB/m)
1	5150.00	64.4 PK	74.0	-9.6	2.25 V	197	60.7	3.7
2	5150.00	53.1 AV	54.0	-0.9	2.25 V	197	49.4	3.7
3	*5190.00	108.5 PK			2.25 V	197	104.8	3.7
4	*5190.00	98.8 AV			2.25 V	197	95.1	3.7
5	5350.00	48.9 PK	74.0	-25.1	2.25 V	197	44.8	4.1
6	5350.00	37.1 AV	54.0	-16.9	2.25 V	197	33.0	4.1
7	#10380.00	48.9 PK	74.0	-25.1	1.88 V	323	35.8	13.1
8	#10380.00	37.2 AV	54.0	-16.8	1.88 V	323	24.1	13.1
9	15570.00	45.6 PK	74.0	-28.4	1.77 V	211	32.3	13.3
10	15570.00	33.5 AV	54.0	-20.5	1.77 V	211	20.2	13.3

**REMARKS:**

1. Emission Level(dBuV/m) = Raw Value(dBuV) + Correction Factor(dB/m)
2. Correction Factor(dB/m) = Antenna Factor(dB/m) + Cable Factor(dB) – Pre-Amplifier Factor(dB)
3. The other emission levels were very low against the limit.
4. Margin value = Emission Level – Limit value
5. " \* ": Fundamental frequency.
6. " # ": The radiated frequency is out of the restricted band.

<b>CHANNEL</b>	TX Channel 46	<b>DETECTOR FUNCTION</b>	Peak (PK)
<b>FREQUENCY RANGE</b>	1GHz ~ 40GHz		Average (AV)

**ANTENNA POLARITY & TEST DISTANCE: HORIZONTAL AT 3 M**

NO.	FREQ. (MHz)	EMISSION LEVEL (dBuV/m)	LIMIT (dBuV/m)	MARGIN (dB)	ANTENNA HEIGHT (m)	TABLE ANGLE (Degree)	RAW VALUE (dBuV)	CORRECTION FACTOR (dB/m)
1	5150.00	61.4 PK	74.0	-12.6	1.06 H	136	57.7	3.7
2	5150.00	51.9 AV	54.0	-2.1	1.06 H	136	48.2	3.7
3	*5230.00	106.8 PK			1.06 H	136	103.0	3.8
4	*5230.00	98.0 AV			1.06 H	136	94.2	3.8
5	5350.00	46.4 PK	74.0	-27.6	1.06 H	136	42.3	4.1
6	5350.00	34.8 AV	54.0	-19.2	1.06 H	136	30.7	4.1
7	#10460.00	47.0 PK	74.0	-27.0	1.74 H	285	33.9	13.1
8	#10460.00	34.6 AV	54.0	-19.4	1.74 H	285	21.5	13.1
9	15690.00	46.1 PK	74.0	-27.9	1.56 H	287	32.3	13.8
10	15690.00	33.7 AV	54.0	-20.3	1.56 H	287	19.9	13.8

**ANTENNA POLARITY & TEST DISTANCE: VERTICAL AT 3 M**

NO.	FREQ. (MHz)	EMISSION LEVEL (dBuV/m)	LIMIT (dBuV/m)	MARGIN (dB)	ANTENNA HEIGHT (m)	TABLE ANGLE (Degree)	RAW VALUE (dBuV)	CORRECTION FACTOR (dB/m)
1	5150.00	66.0 PK	74.0	-8.0	2.34 V	202	62.3	3.7
2	5150.00	53.6 AV	54.0	-0.4	2.34 V	202	49.9	3.7
3	*5230.00	110.8 PK			2.34 V	202	107.0	3.8
4	*5230.00	101.2 AV			2.34 V	202	97.4	3.8
5	5350.00	51.7 PK	74.0	-22.3	2.34 V	202	47.6	4.1
6	5350.00	40.0 AV	54.0	-14.0	2.34 V	202	35.9	4.1
7	#10460.00	48.6 PK	74.0	-25.4	1.90 V	320	35.5	13.1
8	#10460.00	36.7 AV	54.0	-17.3	1.90 V	320	23.6	13.1
9	15690.00	45.7 PK	74.0	-28.3	1.72 V	210	31.9	13.8
10	15690.00	33.8 AV	54.0	-20.2	1.72 V	210	20.0	13.8

**REMARKS:**

1. Emission Level(dBuV/m) = Raw Value(dBuV) + Correction Factor(dB/m)
2. Correction Factor(dB/m) = Antenna Factor(dB/m) + Cable Factor(dB) – Pre-Amplifier Factor(dB)
3. The other emission levels were very low against the limit.
4. Margin value = Emission Level – Limit value
5. " \* ": Fundamental frequency.
6. " # ": The radiated frequency is out of the restricted band.

<b>CHANNEL</b>	TX Channel 151	<b>DETECTOR FUNCTION</b>	Peak (PK)
<b>FREQUENCY RANGE</b>	1GHz ~ 40GHz		Average (AV)

**ANTENNA POLARITY & TEST DISTANCE: HORIZONTAL AT 3 M**

NO.	FREQ. (MHz)	EMISSION LEVEL (dBuV/m)	LIMIT (dBuV/m)	MARGIN (dB)	ANTENNA HEIGHT (m)	TABLE ANGLE (Degree)	RAW VALUE (dBuV)	CORRECTION FACTOR (dB/m)
1	#5638.60	60.7 PK	68.2	-7.5	2.46 H	158	56.3	4.4
2	*5755.00	107.8 PK			2.46 H	158	103.4	4.4
3	*5755.00	98.1 AV			2.46 H	158	93.7	4.4
4	#5989.47	57.8 PK	68.2	-10.4	2.46 H	158	53.1	4.7
5	11510.00	52.5 PK	74.0	-21.5	1.67 H	329	38.9	13.6
6	11510.00	42.0 AV	54.0	-12.0	1.67 H	329	28.4	13.6
7	#17265.00	49.3 PK	74.0	-24.7	1.78 H	338	31.7	17.6
8	#17265.00	36.2 AV	54.0	-17.8	1.78 H	338	18.6	17.6

**ANTENNA POLARITY & TEST DISTANCE: VERTICAL AT 3 M**

NO.	FREQ. (MHz)	EMISSION LEVEL (dBuV/m)	LIMIT (dBuV/m)	MARGIN (dB)	ANTENNA HEIGHT (m)	TABLE ANGLE (Degree)	RAW VALUE (dBuV)	CORRECTION FACTOR (dB/m)
1	#5649.43	67.1 PK	68.2	-1.1	2.58 V	255	62.7	4.4
2	*5755.00	107.9 PK			2.58 V	255	103.5	4.4
3	*5755.00	105.3 AV			2.58 V	255	100.9	4.4
4	#5986.20	59.6 PK	68.2	-8.6	2.58 V	255	54.9	4.7
5	11510.00	54.7 PK	74.0	-19.3	1.97 V	322	41.1	13.6
6	11510.00	44.8 AV	54.0	-9.2	1.97 V	322	31.2	13.6
7	#17265.00	49.9 PK	74.0	-24.1	1.78 V	104	32.3	17.6
8	#17265.00	36.9 AV	54.0	-17.1	1.78 V	104	19.3	17.6

**REMARKS:**

1. Emission Level(dBuV/m) = Raw Value(dBuV) + Correction Factor(dB/m)
2. Correction Factor(dB/m) = Antenna Factor(dB/m) + Cable Factor(dB) – Pre-Amplifier Factor(dB)
3. The other emission levels were very low against the limit.
4. Margin value = Emission Level – Limit value
5. " \* ": Fundamental frequency.
6. " # ": The radiated frequency is out of the restricted band.

<b>CHANNEL</b>	TX Channel 159	<b>DETECTOR FUNCTION</b>	Peak (PK)
<b>FREQUENCY RANGE</b>	1GHz ~ 40GHz		Average (AV)

**ANTENNA POLARITY & TEST DISTANCE: HORIZONTAL AT 3 M**

NO.	FREQ. (MHz)	EMISSION LEVEL (dBuV/m)	LIMIT (dBuV/m)	MARGIN (dB)	ANTENNA HEIGHT (m)	TABLE ANGLE (Degree)	RAW VALUE (dBuV)	CORRECTION FACTOR (dB/m)
1	#5647.17	61.3 PK	68.2	-6.9	2.30 H	157	56.9	4.4
2	*5795.00	109.4 PK			2.30 H	157	105.0	4.4
3	*5795.00	99.4 AV			2.30 H	157	95.0	4.4
4	#5927.39	62.9 PK	68.2	-5.3	2.30 H	157	58.2	4.7
5	11590.00	52.5 PK	74.0	-21.5	1.65 H	308	39.0	13.5
6	11590.00	42.2 AV	54.0	-11.8	1.65 H	308	28.7	13.5
7	#17385.00	49.3 PK	74.0	-24.7	1.83 H	340	31.0	18.3
8	#17385.00	36.1 AV	54.0	-17.9	1.83 H	340	17.8	18.3

**ANTENNA POLARITY & TEST DISTANCE: VERTICAL AT 3 M**

NO.	FREQ. (MHz)	EMISSION LEVEL (dBuV/m)	LIMIT (dBuV/m)	MARGIN (dB)	ANTENNA HEIGHT (m)	TABLE ANGLE (Degree)	RAW VALUE (dBuV)	CORRECTION FACTOR (dB/m)
1	#5642.57	67.9 PK	68.2	-0.3	2.47 V	256	63.5	4.4
2	*5795.00	116.6 PK			2.47 V	256	112.2	4.4
3	*5795.00	106.3 AV			2.47 V	256	101.9	4.4
4	#5926.54	67.6 PK	68.2	-0.6	2.47 V	256	62.9	4.7
5	11590.00	55.4 PK	74.0	-18.6	2.00 V	343	41.9	13.5
6	11590.00	45.2 AV	54.0	-8.8	2.00 V	343	31.7	13.5
7	#17385.00	49.6 PK	74.0	-24.4	1.75 V	128	31.3	18.3
8	#17385.00	36.7 AV	54.0	-17.3	1.75 V	128	18.4	18.3

**REMARKS:**

1. Emission Level(dBuV/m) = Raw Value(dBuV) + Correction Factor(dB/m)
2. Correction Factor(dB/m) = Antenna Factor(dB/m) + Cable Factor(dB) – Pre-Amplifier Factor(dB)
3. The other emission levels were very low against the limit.
4. Margin value = Emission Level – Limit value
5. " \* ": Fundamental frequency.
6. " # ": The radiated frequency is out of the restricted band.

**802.11ac (VHT80)**

<b>CHANNEL</b>	TX Channel 42	<b>DETECTOR FUNCTION</b>	Peak (PK)
<b>FREQUENCY RANGE</b>	1GHz ~ 40GHz		Average (AV)

**ANTENNA POLARITY & TEST DISTANCE: HORIZONTAL AT 3 M**

NO.	FREQ. (MHz)	EMISSION LEVEL (dBuV/m)	LIMIT (dBuV/m)	MARGIN (dB)	ANTENNA HEIGHT (m)	TABLE ANGLE (Degree)	RAW VALUE (dBuV)	CORRECTION FACTOR (dB/m)
1	5150.00	65.9 PK	74.0	-8.1	1.18 H	157	62.2	3.7
2	5150.00	53.8 AV	54.0	-0.2	1.18 H	157	50.1	3.7
3	*5210.00	99.2 PK			1.18 H	157	95.5	3.7
4	*5210.00	89.6 AV			1.18 H	157	85.9	3.7
5	5350.00	51.7 PK	74.0	-22.3	1.18 H	157	47.6	4.1
6	5350.00	40.8 AV	54.0	-13.2	1.18 H	157	36.7	4.1
7	#10420.00	48.2 PK	74.0	-25.8	1.68 H	297	35.1	13.1
8	#10420.00	35.3 AV	54.0	-18.7	1.68 H	297	22.2	13.1
9	15630.00	46.7 PK	74.0	-27.3	1.60 H	322	33.1	13.6
10	15630.00	33.8 AV	54.0	-20.2	1.60 H	322	20.2	13.6

**ANTENNA POLARITY & TEST DISTANCE: VERTICAL AT 3 M**

NO.	FREQ. (MHz)	EMISSION LEVEL (dBuV/m)	LIMIT (dBuV/m)	MARGIN (dB)	ANTENNA HEIGHT (m)	TABLE ANGLE (Degree)	RAW VALUE (dBuV)	CORRECTION FACTOR (dB/m)
1	5150.00	63.8 PK	74.0	-10.2	2.69 V	239	60.1	3.7
2	5150.00	53.8 AV	54.0	-0.2	2.69 V	239	50.1	3.7
3	*5210.00	103.3 PK			2.69 V	239	99.6	3.7
4	*5210.00	93.7 AV			2.69 V	239	90.0	3.7
5	5350.00	50.1 PK	74.0	-23.9	2.69 V	239	46.0	4.1
6	5350.00	40.2 AV	54.0	-13.8	2.69 V	239	36.1	4.1
7	#10420.00	49.0 PK	74.0	-25.0	1.83 V	332	35.9	13.1
8	#10420.00	37.2 AV	54.0	-16.8	1.83 V	332	24.1	13.1
9	15630.00	45.3 PK	74.0	-28.7	1.73 V	202	31.7	13.6
10	15630.00	33.4 AV	54.0	-20.6	1.73 V	202	19.8	13.6

**REMARKS:**

- Emission Level(dBuV/m) = Raw Value(dBuV) + Correction Factor(dB/m)
- Correction Factor(dB/m) = Antenna Factor(dB/m) + Cable Factor(dB) – Pre-Amplifier Factor(dB)
- The other emission levels were very low against the limit.
- Margin value = Emission Level – Limit value
- " \* ": Fundamental frequency.
- " # ": The radiated frequency is out of the restricted band.

<b>CHANNEL</b>	TX Channel 155	<b>DETECTOR FUNCTION</b>	Peak (PK)
<b>FREQUENCY RANGE</b>	1GHz ~ 40GHz		Average (AV)

**ANTENNA POLARITY & TEST DISTANCE: HORIZONTAL AT 3 M**

NO.	FREQ. (MHz)	EMISSION LEVEL (dBuV/m)	LIMIT (dBuV/m)	MARGIN (dB)	ANTENNA HEIGHT (m)	TABLE ANGLE (Degree)	RAW VALUE (dBuV)	CORRECTION FACTOR (dB/m)
1	#5649.73	64.3 PK	68.2	-3.9	1.21 H	153	59.9	4.4
2	*5775.00	99.8 PK			1.21 H	153	95.4	4.4
3	*5775.00	91.5 AV			1.21 H	153	87.1	4.4
4	#5927.61	57.0 PK	68.2	-11.2	1.21 H	153	52.3	4.7
5	11550.00	52.4 PK	74.0	-21.6	1.66 H	314	38.9	13.5
6	11550.00	42.1 AV	54.0	-11.9	1.66 H	314	28.6	13.5
7	#17325.00	48.5 PK	74.0	-25.5	1.85 H	329	30.7	17.8
8	#17325.00	35.6 AV	54.0	-18.4	1.85 H	329	17.8	17.8

**ANTENNA POLARITY & TEST DISTANCE: VERTICAL AT 3 M**

NO.	FREQ. (MHz)	EMISSION LEVEL (dBuV/m)	LIMIT (dBuV/m)	MARGIN (dB)	ANTENNA HEIGHT (m)	TABLE ANGLE (Degree)	RAW VALUE (dBuV)	CORRECTION FACTOR (dB/m)
1	#5637.98	67.9 PK	68.2	-0.3	2.69 V	225	63.5	4.4
2	*5775.00	107.2 PK			2.69 V	255	102.8	4.4
3	*5775.00	97.4 AV			2.69 V	255	93.0	4.4
4	#5926.85	65.7 PK	68.2	-2.5	2.69 V	255	61.0	4.7
5	11550.00	55.2 PK	74.0	-18.8	1.98 V	351	41.7	13.5
6	11550.00	45.2 AV	54.0	-8.8	1.98 V	351	31.7	13.5
7	#17325.00	49.6 PK	74.0	-24.4	1.77 V	144	31.8	17.8
8	#17325.00	36.5 AV	54.0	-17.5	1.77 V	144	18.7	17.8

**REMARKS:**

1. Emission Level(dBuV/m) = Raw Value(dBuV) + Correction Factor(dB/m)
2. Correction Factor(dB/m) = Antenna Factor(dB/m) + Cable Factor(dB) – Pre-Amplifier Factor(dB)
3. The other emission levels were very low against the limit.
4. Margin value = Emission Level – Limit value
5. " \* ": Fundamental frequency.
6. " # ": The radiated frequency is out of the restricted band.

## 4.2 Conducted Emission Measurement

### 4.2.1 Limits of Conducted Emission Measurement

Frequency (MHz)	Conducted Limit (dBuV)	
	Quasi-peak	Average
0.15 - 0.5	66 - 56	56 - 46
0.50 - 5.0	56	46
5.0 - 30.0	60	50

Note: 1. The lower limit shall apply at the transition frequencies.

2. The limit decreases in line with the logarithm of the frequency in the range of 0.15 to 0.50MHz.

### 4.2.2 Test Instruments

DESCRIPTION & MANUFACTURER	MODEL NO.	SERIAL NO.	CALIBRATED DATE	CALIBRATED UNTIL
Test Receiver R&S	ESCS 30	847124/029	Oct. 24, 2016	Oct. 23, 2017
Line-Impedance Stabilization Network (for EUT) R&S	ESH3-Z5	848773/004	Oct. 26, 2016	Oct. 25, 2017
Line-Impedance Stabilization Network (for Peripheral) R&S	ENV216	100072	June 03, 2017	June 02, 2018
50 ohms Terminator	N/A	EMC-02	Sep. 29, 2016	Sep. 28, 2017
RF Cable	5D-FB	COCCAB-001	Sep. 30, 2016	Sep. 29, 2017
10 dB PAD Mini-Circuits	HAT-10+	CONATT-004	June 18, 2017	June 17, 2018
Software BVADT	BVADT_Cond_ V7.3.7.4	NA	NA	NA

**Note:**

1. The calibration interval of the above test instruments are 12 months and the calibrations are traceable to NML/ROC and NIST/USA.
2. The test was performed in Shielded Room No. 1.
3. Tested Date: July 18, 2017



#### 4.2.3 Test Procedure

- The EUT was placed 0.4 meters from the conducting wall of the shielded room with EUT being connected to the power mains through a line impedance stabilization network (LISN). Other support units were connected to the power mains through another LISN. The two LISNs provide 50 ohm/ 50uH of coupling impedance for the measuring instrument.
- Both lines of the power mains connected to the EUT were checked for maximum conducted interference.
- The frequency range from 150kHz to 30MHz was searched. Emission levels under (Limit - 20dB) was not recorded.

**NOTE:** All modes of operation were investigated and the worst-case emissions are reported.

#### 4.2.4 Deviation from Test Standard

No deviation.

#### 4.2.5 Test Setup

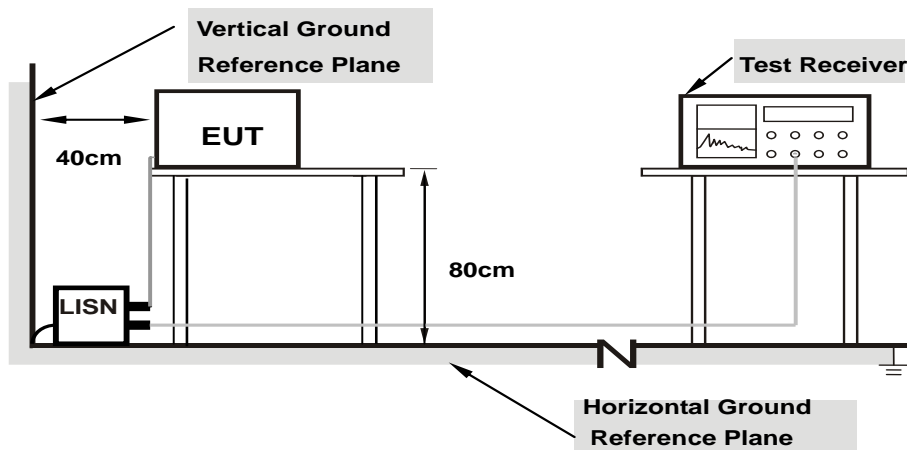

**Note: 1.Support units were connected to second LISN.**

For the actual test configuration, please refer to the attached file (Test Setup Photo).

#### 4.2.6 EUT Operating Condition

Same as 4.1.6.

#### 4.2.7 Test Results (Mode 1)

Phase	Line (L)	Detector Function	Quasi-Peak (QP) / Average (AV)
-------	----------	-------------------	--------------------------------

No	Freq. [MHz]	Corr.	Reading Value		Emission Level		Limit		Margin	
		Factor (dB)	[dB (uV)]		[dB (uV)]		[dB (uV)]		(dB)	
			Q.P.	AV.	Q.P.	AV.	Q.P.	AV.	Q.P.	AV.
1	0.15700	10.07	41.94	34.41	52.01	44.48	65.62	55.62	-13.61	-11.14
2	0.18516	10.06	36.69	27.10	46.75	37.16	64.25	54.25	-17.50	-17.09
3	0.22031	10.07	32.99	26.28	43.06	36.35	62.81	52.81	-19.75	-16.46
<b>4</b>	<b>0.40781</b>	<b>10.11</b>	<b>35.37</b>	<b>30.56</b>	<b>45.48</b>	<b>40.67</b>	<b>57.69</b>	<b>47.69</b>	<b>-12.21</b>	<b>-7.02</b>
5	16.22819	11.04	34.12	31.23	45.16	42.27	60.00	50.00	-14.84	-7.73
6	28.41797	11.36	29.16	24.13	40.52	35.49	60.00	50.00	-19.48	-14.51

#### REMARKS:

1. Q.P. and AV. are abbreviations of quasi-peak and average individually.
2. The emission levels of other frequencies were very low against the limit.
3. Margin value = Emission level - Limit value
4. Correction factor = Insertion loss + Cable loss
5. Emission Level = Correction Factor + Reading Value.

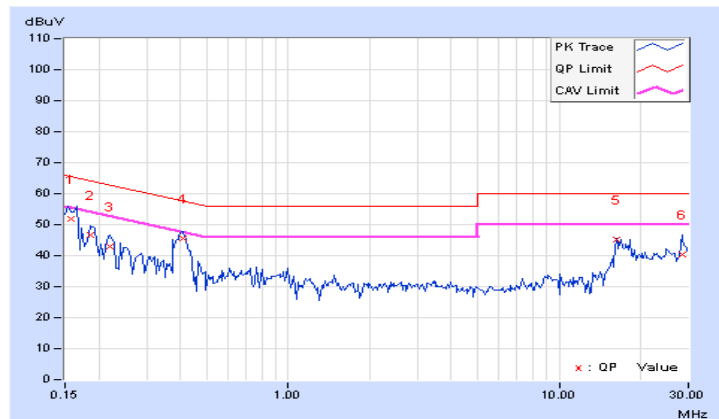

Phase	Neutral (N)	Detector Function	Quasi-Peak (QP) / Average (AV)
-------	-------------	-------------------	--------------------------------

No	Freq. [MHz]	Corr. Factor	Reading Value [dB (uV)]		Emission Level [dB (uV)]		Limit [dB (uV)]		Margin (dB)	
		(dB)	Q.P.	AV.	Q.P.	AV.	Q.P.	AV.	Q.P.	AV.
	1	0.16562	10.05	36.48	21.35	46.53	31.40	65.18	55.18	-18.65
2	0.18516	10.04	36.67	26.42	46.71	36.46	64.25	54.25	-17.54	-17.79
3	0.40781	10.10	33.77	28.96	43.87	39.06	57.69	47.69	-13.82	-8.63
4	0.51328	10.10	17.79	10.63	27.89	20.73	56.00	46.00	-28.11	-25.27
5	17.69141	10.91	31.57	27.81	42.48	38.72	60.00	50.00	-17.52	-11.28
6	28.52734	10.96	28.79	23.72	39.75	34.68	60.00	50.00	-20.25	-15.32

**REMARKS:**

1. Q.P. and AV. are abbreviations of quasi-peak and average individually.
2. The emission levels of other frequencies were very low against the limit.
3. Margin value = Emission level - Limit value
4. Correction factor = Insertion loss + Cable loss
5. Emission Level = Correction Factor + Reading Value.

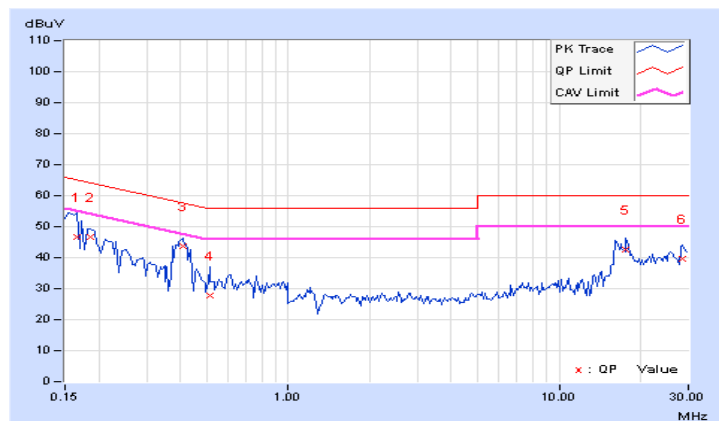

### 4.3 Transmit Power Measurement

#### 4.3.1 Limits of Transmit Power Measurement

Operation Band	EUT Category		Limit
U-NII-1		Outdoor Access Point	1 Watt (30 dBm) (Max. e.i.r.p $\leq$ 125mW(21 dBm) at any elevation angle above 30 degrees as measured from the horizon)
		Fixed point-to-point Access Point	1 Watt (30 dBm)
	√	Indoor Access Point	1 Watt (30 dBm)
		Mobile and Portable client device	250mW (24 dBm)
U-NII-2A			250mW (24 dBm) or 11 dBm+10 log B*
U-NII-2C			250mW (24 dBm) or 11 dBm+10 log B*
U-NII-3	√		1 Watt (30 dBm)

\*B is the 26 dB emission bandwidth in megahertz

Per KDB 662911 Method of conducted output power measurement on IEEE 802.11 devices,

Array Gain = 0 dB (i.e., no array gain) for  $N_{ANT} \leq 4$ ;

Array Gain = 0 dB (i.e., no array gain) for channel widths  $\geq 40$  MHz for any  $N_{ANT}$ ;

Array Gain =  $5 \log(N_{ANT}/N_{SS})$  dB or 3 dB, whichever is less for 20-MHz channel widths with  $N_{ANT} \geq 5$ .

For power measurements on all other devices: Array Gain =  $10 \log(N_{ANT}/N_{SS})$  dB.

#### 4.3.2 Test Setup

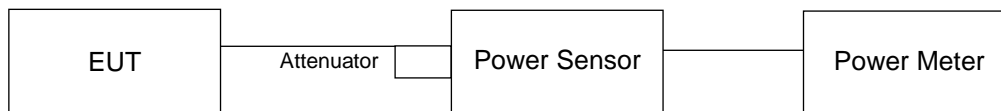

#### 4.3.3 Test Instruments

Refer to section 4.1.2 to get information of above instrument.

#### 4.3.4 Test Procedure

Method PM is used to perform output power measurement, trigger and gating function of wide band power meter is enabled to measure max output power of TX on burst. Duty factor is not added to measured value.

#### 4.3.5 Deviation from Test Standard

No deviation.

#### 4.3.6 EUT Operating Condition

The software provided by client to enable the EUT under transmission condition continuously at lowest, middle and highest channel frequencies individually.

#### 4.3.7 Test Result (Mode 1)

##### CDD Mode

##### 802.11a

Chan.	Chan. Freq. (MHz)	Maximum Conducted Power (dBm)			Total Power (mW)	Total Power (dBm)	Limit (dBm)	Pass / Fail
		Chain 0	Chain 1	Chain 2				
36	5180	19.69	19.53	19.81	278.573	24.45	30.00	Pass
40	5200	20.37	20.33	20.88	339.25	25.31	30.00	Pass
48	5240	20.33	20.41	20.94	341.961	25.34	30.00	Pass
149	5745	23.13	22.65	24.07	644.936	28.10	30.00	Pass
157	5785	22.56	22.16	23.14	550.802	27.41	30.00	Pass
165	5825	22.67	22.15	23.71	583.949	27.66	30.00	Pass

##### 802.11ac (VHT20)

Chan.	Chan. Freq. (MHz)	Maximum Conducted Power (dBm)			Total Power (mW)	Total Power (dBm)	Limit (dBm)	Pass / Fail
		Chain 0	Chain 1	Chain 2				
36	5180	18.22	18.16	18.52	202.959	23.07	30.00	Pass
40	5200	20.32	20.59	21.02	348.672	25.42	30.00	Pass
48	5240	20.43	20.56	21.11	353.293	25.48	30.00	Pass
149	5745	23.03	22.79	24.14	650.435	28.13	30.00	Pass
157	5785	23.02	22.51	24.15	638.701	28.05	30.00	Pass
165	5825	23.01	22.42	23.88	618.911	27.92	30.00	Pass

##### 802.11ac (VHT40)

Chan.	Chan. Freq. (MHz)	Maximum Conducted Power (dBm)			Total Power (mW)	Total Power (dBm)	Limit (dBm)	Pass / Fail
		Chain 0	Chain 1	Chain 2				
38	5190	16.92	16.97	17.47	154.825	21.90	30.00	Pass
46	5230	20.31	20.46	20.93	342.452	25.35	30.00	Pass
151	5755	21.21	20.57	21.47	386.436	25.87	30.00	Pass
159	5795	22.80	21.92	23.03	547.052	27.38	30.00	Pass

**802.11ac (VHT80)**

Chan.	Chan. Freq. (MHz)	Maximum Conducted Power (dBm)			Total Power (mW)	Total Power (dBm)	Limit (dBm)	Pass / Fail
		Chain 0	Chain 1	Chain 2				
42	5210	12.25	12.40	12.79	53.177	17.26	30.00	Pass
155	5775	16.25	15.79	15.95	119.456	20.77	30.00	Pass

## Beamforming Mode

### 802.11ac (VHT20)

Chan.	Chan. Freq. (MHz)	Maximum Conducted Power (dBm)			Total Power (mW)	Total Power (dBm)	Limit (dBm)	Pass / Fail
		Chain 0	Chain 1	Chain 2				
36	5180	18.22	18.16	18.52	202.959	23.07	25.50	Pass
40	5200	20.32	20.59	21.02	348.672	25.42	25.50	Pass
48	5240	20.43	20.56	21.11	353.293	25.48	25.50	Pass
149	5745	20.65	20.23	21.08	349.817	25.44	25.50	Pass
157	5785	20.76	20.19	21.15	353.913	25.49	25.50	Pass
165	5825	20.95	20.02	20.69	342.133	25.34	25.50	Pass

**Note:** 1. Directional gain =  $10 \log[(10^{G1/20} + 10^{G2/20} + 10^{G3/20})^2 / 3] = 10.5\text{dBi} > 6\text{dBi}$ , so the power limit shall be reduced to  $30 - (10.5 - 6) = 25.5\text{dBm}$ .

### 802.11ac (VHT40)

Chan.	Chan. Freq. (MHz)	Maximum Conducted Power (dBm)			Total Power (mW)	Total Power (dBm)	Limit (dBm)	Pass / Fail
		Chain 0	Chain 1	Chain 2				
38	5190	16.92	16.97	17.47	154.825	21.90	25.50	Pass
46	5230	20.31	20.46	20.93	342.452	25.35	25.50	Pass
151	5755	20.69	20.10	21.04	346.606	25.40	25.50	Pass
159	5795	20.48	19.66	20.81	324.66	25.11	25.50	Pass

**Note:** 1. Directional gain =  $10 \log[(10^{G1/20} + 10^{G2/20} + 10^{G3/20})^2 / 3] = 10.5\text{dBi} > 6\text{dBi}$ , so the power limit shall be reduced to  $30 - (10.5 - 6) = 25.5\text{dBm}$ .

### 802.11ac (VHT80)

Chan.	Chan. Freq. (MHz)	Maximum Conducted Power (dBm)			Total Power (mW)	Total Power (dBm)	Limit (dBm)	Pass / Fail
		Chain 0	Chain 1	Chain 2				
42	5210	12.25	12.40	12.79	53.177	17.26	25.50	Pass
155	5775	16.25	15.79	15.95	119.456	20.77	25.50	Pass

**Note:** 1. Directional gain =  $10 \log[(10^{G1/20} + 10^{G2/20} + 10^{G3/20})^2 / 3] = 10.5\text{dBi} > 6\text{dBi}$ , so the power limit shall be reduced to  $30 - (10.5 - 6) = 25.5\text{dBm}$ .

## 4.3.8 Test Result (Mode 2)

**CDD Mode**
**802.11a**

Chan.	Chan. Freq. (MHz)	Maximum Conducted Power (dBm)		Total Power (mW)	Total Power (dBm)	Limit (dBm)	Pass / Fail
		Chain 1	Chain 2				
36	5180	20.01	20.42	210.385	23.23	30.00	Pass
40	5200	22.80	23.18	398.516	26.00	30.00	Pass
48	5240	23.00	23.23	409.904	26.13	30.00	Pass
149	5745	22.65	24.07	439.347	26.43	30.00	Pass
157	5785	22.16	23.14	370.5	25.69	30.00	Pass
165	5825	22.15	23.71	399.022	26.01	30.00	Pass

**802.11ac (VHT20)**

Chan.	Chan. Freq. (MHz)	Maximum Conducted Power (dBm)		Total Power (mW)	Total Power (dBm)	Limit (dBm)	Pass / Fail
		Chain 1	Chain 2				
36	5180	20.75	21.04	245.907	23.91	30.00	Pass
40	5200	23.02	23.58	428.481	26.32	30.00	Pass
48	5240	22.68	23.03	386.262	25.87	30.00	Pass
149	5745	22.79	24.14	449.526	26.53	30.00	Pass
157	5785	22.51	24.15	438.254	26.42	30.00	Pass
165	5825	22.42	23.88	418.925	26.22	30.00	Pass

**802.11ac (VHT40)**

Chan.	Chan. Freq. (MHz)	Maximum Conducted Power (dBm)		Total Power (mW)	Total Power (dBm)	Limit (dBm)	Pass / Fail
		Chain 1	Chain 2				
38	5190	17.45	17.92	117.534	20.70	30.00	Pass
46	5230	20.92	21.42	262.271	24.19	30.00	Pass
151	5755	21.02	21.92	282.071	24.50	30.00	Pass
159	5795	22.62	23.71	417.773	26.21	30.00	Pass

**802.11ac (VHT80)**

Chan.	Chan. Freq. (MHz)	Maximum Conducted Power (dBm)		Total Power (mW)	Total Power (dBm)	Limit (dBm)	Pass / Fail
		Chain 1	Chain 2				
42	5210	12.93	13.27	40.866	16.11	30.00	Pass
155	5775	16.51	17.46	100.49	20.02	30.00	Pass



## Beamforming Mode

### 802.11ac (VHT20)

Chan.	Chan. Freq. (MHz)	Maximum Conducted Power (dBm)		Total Power (mW)	Total Power (dBm)	Limit (dBm)	Pass / Fail
		Chain 1	Chain 2				
36	5180	20.75	21.04	245.907	23.91	27.15	Pass
40	5200	23.02	23.58	428.481	26.32	27.15	Pass
48	5240	22.68	23.03	386.262	25.87	27.15	Pass
149	5745	22.79	24.14	449.526	26.53	27.15	Pass
157	5785	22.51	24.15	438.254	26.42	27.15	Pass
165	5825	22.42	23.88	418.925	26.22	27.15	Pass

**Note:** 1. Directional gain =  $10 \log[(10^{G2/20} + 10^{G3/20})^2 / 2] = 8.85\text{dBi} > 6\text{dBi}$ , so the power limit shall be reduced to  $30 - (8.85 - 6) = 27.15\text{dBm}$ .

### 802.11ac (VHT40)

Chan.	Chan. Freq. (MHz)	Maximum Conducted Power (dBm)		Total Power (mW)	Total Power (dBm)	Limit (dBm)	Pass / Fail
		Chain 1	Chain 2				
38	5190	17.45	17.92	117.534	20.70	27.15	Pass
46	5230	20.92	21.42	262.271	24.19	27.15	Pass
151	5755	21.02	21.92	282.071	24.50	27.15	Pass
159	5795	22.62	23.71	417.773	26.21	27.15	Pass

**Note:** 1. Directional gain =  $10 \log[(10^{G2/20} + 10^{G3/20})^2 / 2] = 8.85\text{dBi} > 6\text{dBi}$ , so the power limit shall be reduced to  $30 - (8.85 - 6) = 27.15\text{dBm}$ .

### 802.11ac (VHT80)

Chan.	Chan. Freq. (MHz)	Maximum Conducted Power (dBm)		Total Power (mW)	Total Power (dBm)	Limit (dBm)	Pass / Fail
		Chain 1	Chain 2				
42	5210	12.93	13.27	40.866	16.11	27.15	Pass
155	5775	16.51	17.46	100.49	20.02	27.15	Pass

**Note:** 1. Directional gain =  $10 \log[(10^{G2/20} + 10^{G3/20})^2 / 2] = 8.85\text{dBi} > 6\text{dBi}$ , so the power limit shall be reduced to  $30 - (8.85 - 6) = 27.15\text{dBm}$ .

#### 4.3.9 Test Result (Mode 3)

##### CDD Mode

##### 802.11a

Channel	Channel Frequency (MHz)	Maximum Conducted Power (mW)	Maximum Conducted Power (dBm)	Power Limit (dBm)	Pass/Fail
36	5180	123.027	20.90	30.00	Pass
40	5200	231.739	23.65	30.00	Pass
48	5240	210.378	23.23	30.00	Pass
149	5745	255.27	24.07	30.00	Pass
157	5785	206.063	23.14	30.00	Pass
165	5825	234.963	23.71	30.00	Pass

##### 802.11ac (VHT20)

Channel	Channel Frequency (MHz)	Maximum Conducted Power (mW)	Maximum Conducted Power (dBm)	Power Limit (dBm)	Pass/Fail
36	5180	127.057	21.04	30.00	Pass
40	5200	228.034	23.58	30.00	Pass
48	5240	200.909	23.03	30.00	Pass
149	5745	259.418	24.14	30.00	Pass
157	5785	260.016	24.15	30.00	Pass
165	5825	244.343	23.88	30.00	Pass

##### 802.11ac (VHT40)

Channel	Channel Frequency (MHz)	Maximum Conducted Power (mW)	Maximum Conducted Power (dBm)	Power Limit (dBm)	Pass/Fail
38	5190	81.658	19.12	30.00	Pass
46	5230	137.721	21.39	30.00	Pass
151	5755	155.597	21.92	30.00	Pass
159	5795	208.449	23.19	30.00	Pass

##### 802.11ac (VHT80)

Channel	Channel Frequency (MHz)	Maximum Conducted Power (mW)	Maximum Conducted Power (dBm)	Power Limit (dBm)	Pass/Fail
42	5210	23.878	13.78	30.00	Pass
155	5775	62.517	17.96	30.00	Pass

## 4.4 Occupied Bandwidth Measurement

### 4.4.1 Test Setup

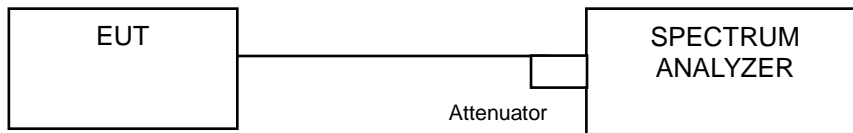

### 4.4.2 Test Instruments

Refer to section 4.1.2 to get information of above instrument.

### 4.4.3 Test Procedure

The transmitter output was connected to the spectrum analyzer through an attenuator. The bandwidth of the fundamental frequency was measured by spectrum analyzer with resolution bandwidth in the range of 1% to 5% of the anticipated emission bandwidth, and a video bandwidth at least 3x the resolution bandwidth and set the detector to SAMPLE. The width of a frequency band such that, below the lower and above the upper frequency limits, the mean powers emitted are each equal to a specified percentage 0.5 %of the total mean power of a given emission.

#### 4.4.4 Test Results (Mode 1)

##### 802.11a

Channel	Channel Frequency (MHz)	Occupied Bandwidth (MHz)		
		Chain 0	Chain 1	Chain 2
36	5180	16.44	16.44	16.44
40	5200	16.44	16.68	16.68
48	5240	16.44	16.44	16.68
149	5745	41.64	42.00	40.68
157	5785	42.72	43.32	41.52
165	5825	41.52	42.00	35.16

##### 802.11ac (VHT20)

Channel	Channel Frequency (MHz)	Occupied Bandwidth (MHz)		
		Chain 0	Chain 1	Chain 2
36	5180	17.88	17.64	17.76
40	5200	17.76	17.64	17.64
48	5240	17.64	17.64	17.76
149	5745	42.24	41.28	40.20
157	5785	42.36	44.40	42.12
165	5825	41.64	42.24	36.60

##### 802.11ac (VHT40)

Channel	Channel Frequency (MHz)	Occupied Bandwidth (MHz)		
		Chain 0	Chain 1	Chain 2
38	5190	36.24	36.24	36.24
46	5230	36.24	36.24	36.24
151	5755	39.84	37.92	36.96
159	5795	64.08	58.32	53.76

##### 802.11ac (VHT80)

Channel	Channel Frequency (MHz)	Occupied Bandwidth (MHz)		
		Chain 0	Chain 1	Chain 2
42	5210	75.84	75.84	76.32
155	5775	76.32	76.32	76.32

### Spectrum Plot of Worst Value

**802.11a\_Chain1 / CH157**

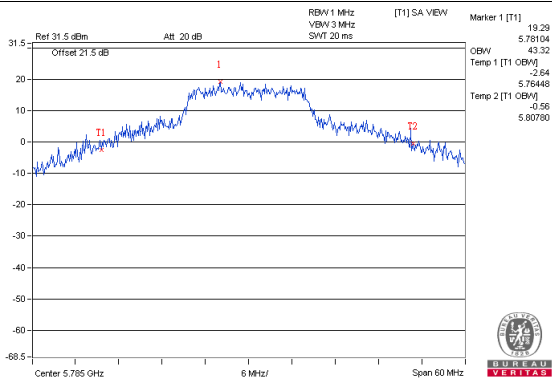

**802.11ac (VHT20)\_Chain1 / CH157**

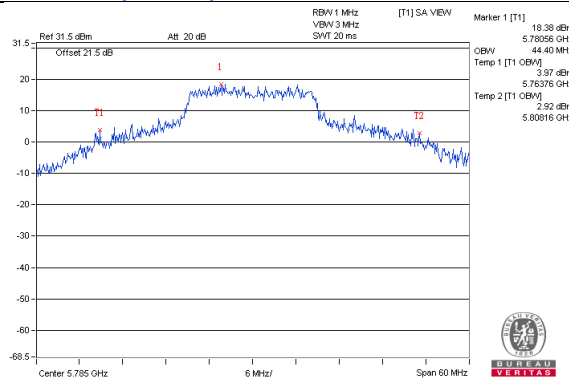

**802.11ac (VHT40)\_Chain0 / CH159**

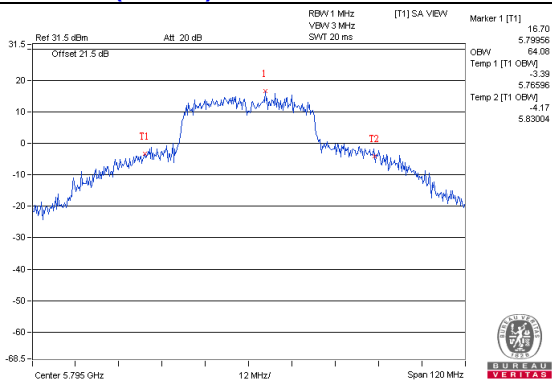

**802.11ac (VHT80)\_Chain0 / CH155**

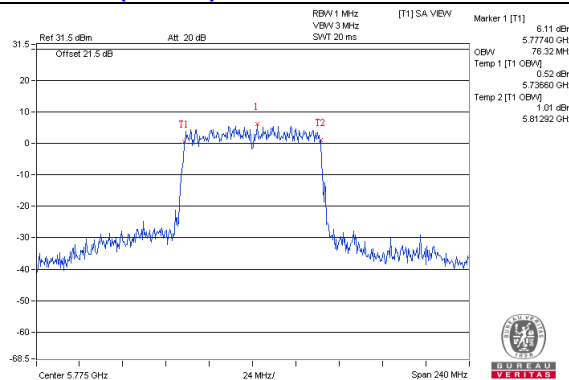

### Spectrum Plot for near by DFS band (DFS is required, if 99% OCP straddle into U-NII-2A band)

**802.11a\_Chain0 / CH48**

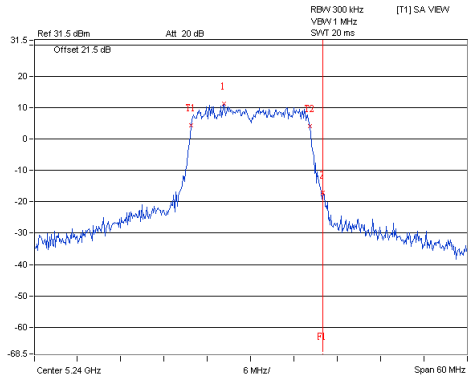

**802.11a\_Chain1 / CH48**

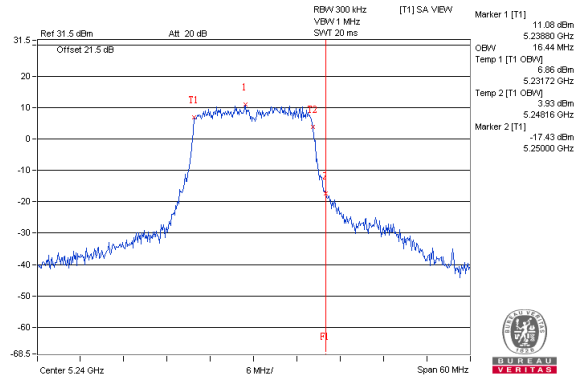

**802.11a\_Chain2 / CH48**

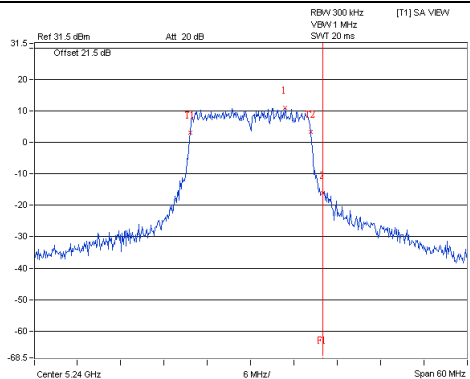

**802.11ac(VHT20)\_Chain0 / CH48**

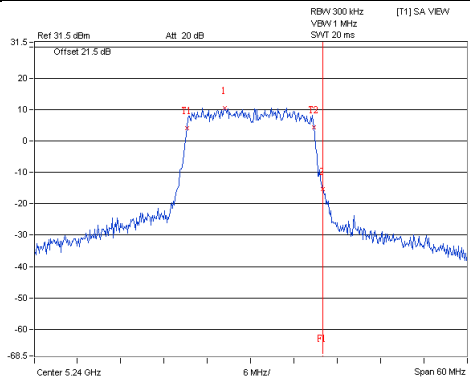

**802.11ac(VHT20)\_Chain1 / CH48**

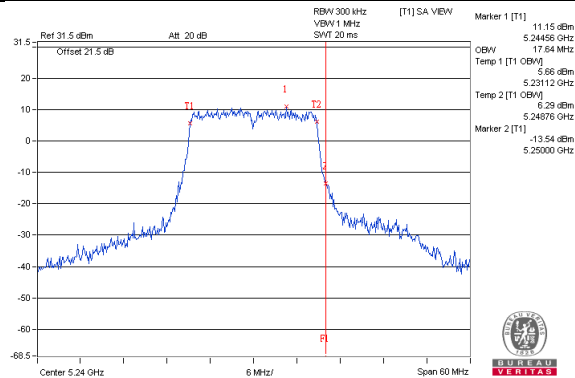

**802.11ac(VHT20)\_Chain2 / CH48**

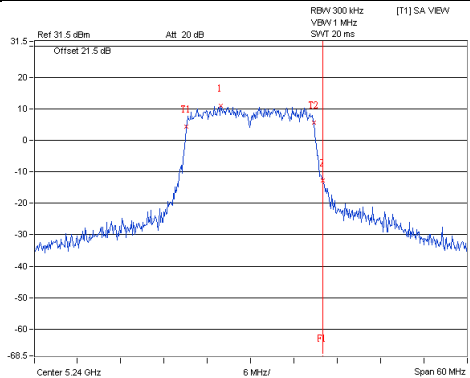

### Spectrum Plot for near by DFS band (DFS is required, if 99% OCP straddle into U-NII-2A band)

**802.11ac(VHT40)\_Chain0 / CH46**

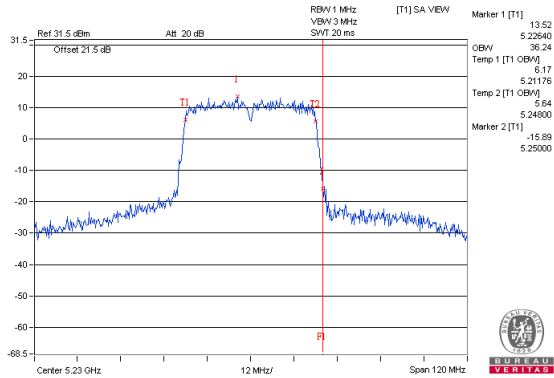

**802.11ac(VHT40)\_Chain1 / CH46**

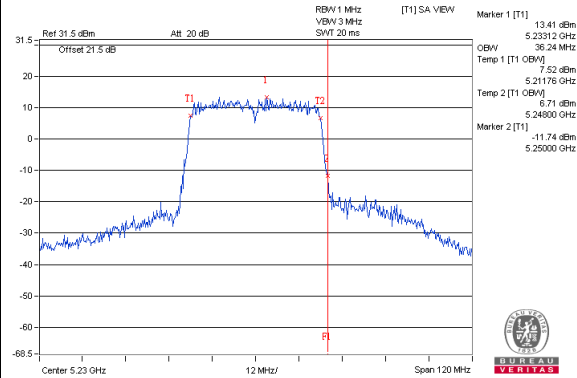

**802.11ac(VHT40)\_Chain2 / CH46**

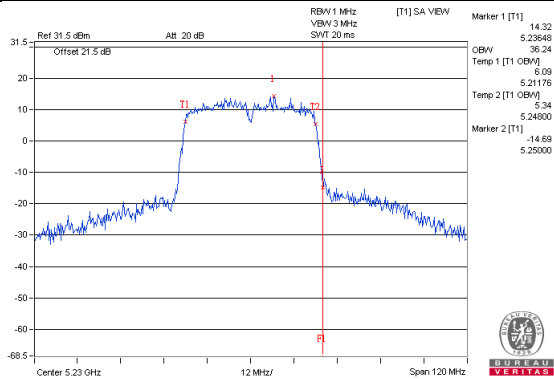

**802.11ac(VHT80)\_Chain0 / CH42**

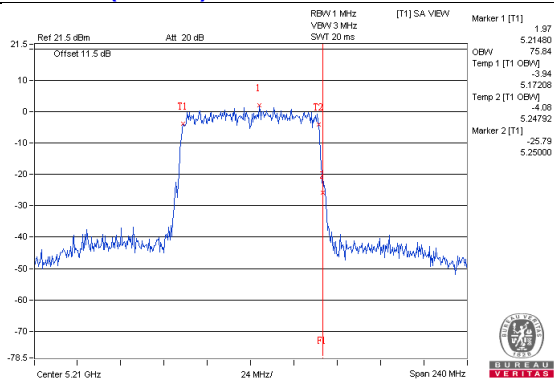

**802.11ac(VHT80)\_Chain1 / CH42**

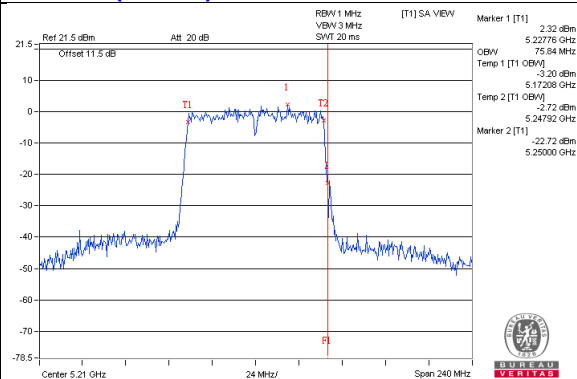

**802.11ac(VHT80)\_Chain2 / CH42**

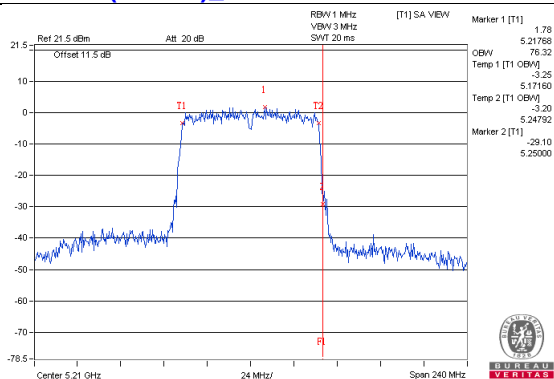

### Spectrum Plot for near by DFS band (DFS is required, if 99% OCP straddle into U-NII-2C band)

**802.11a\_Chain0 / CH149**

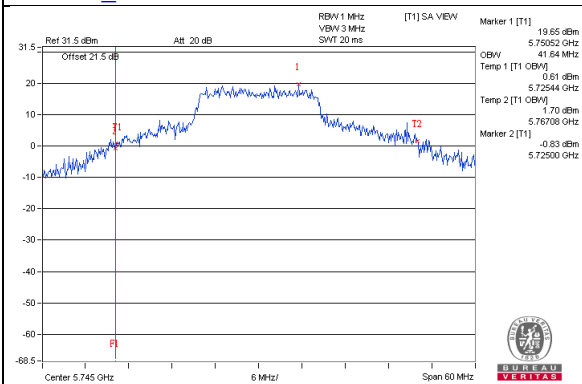

**802.11a\_Chain1 / CH149**

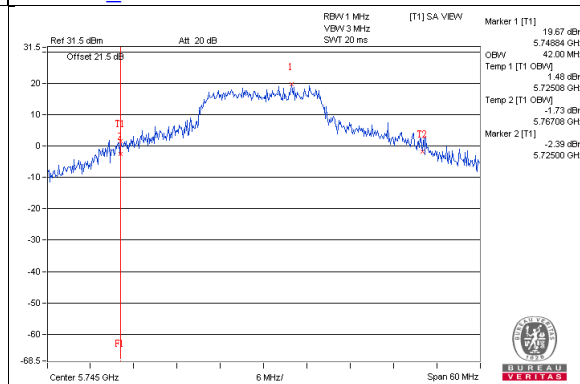

**802.11a\_Chain2 / CH149**

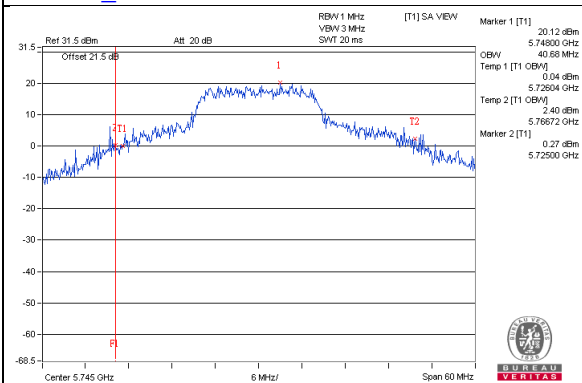

**802.11ac(VHT20)\_Chain0 / CH149**

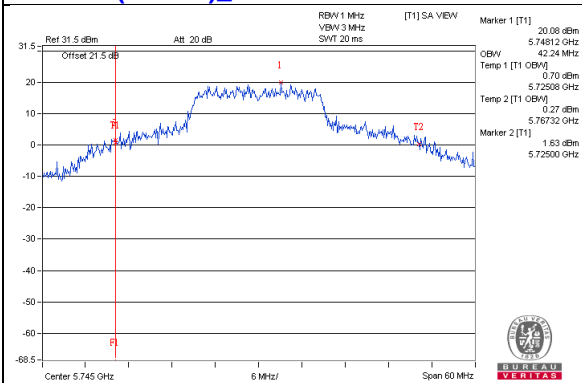

**802.11ac(VHT20)\_Chain1 / CH149**

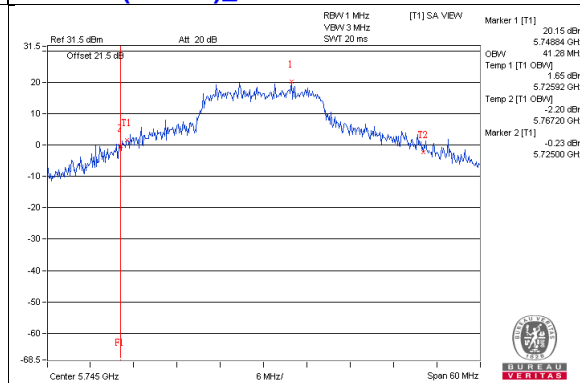

**802.11ac(VHT20)\_Chain2 / CH149**

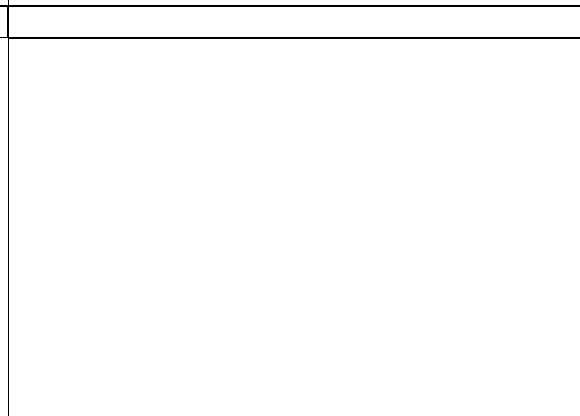
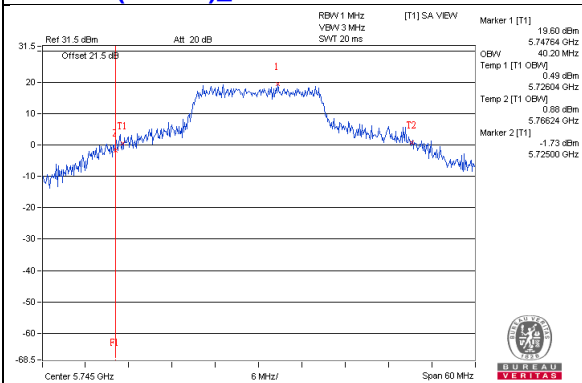



### Spectrum Plot for near by DFS band (DFS is required, if 99% OCP straddle into U-NII-2C band)

**802.11ac(VHT40)\_Chain0 / CH151**

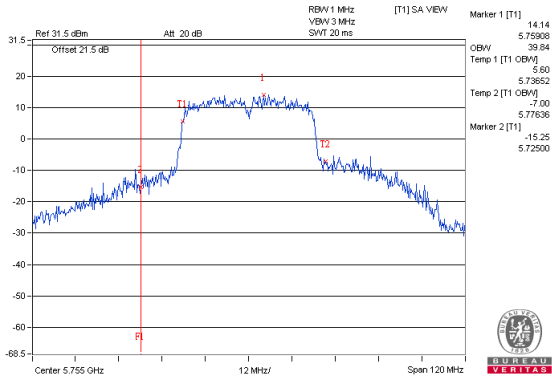

**802.11ac(VHT40)\_Chain1 / CH151**

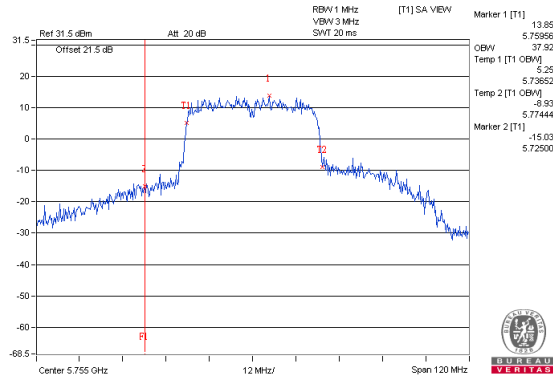

**802.11ac(VHT40)\_Chain2 / CH151**

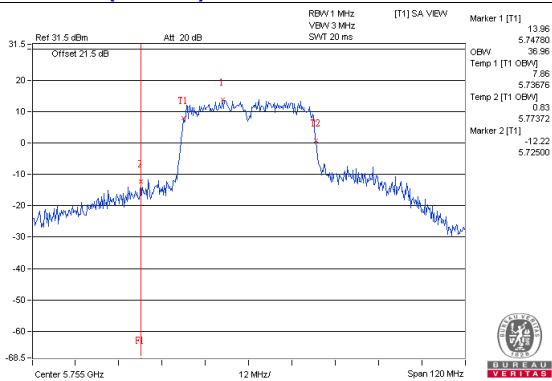

**802.11ac(VHT80)\_Chain0 / CH155**

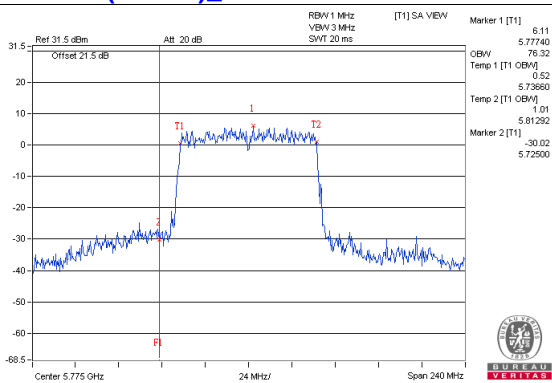

**802.11ac(VHT80)\_Chain1 / CH155**

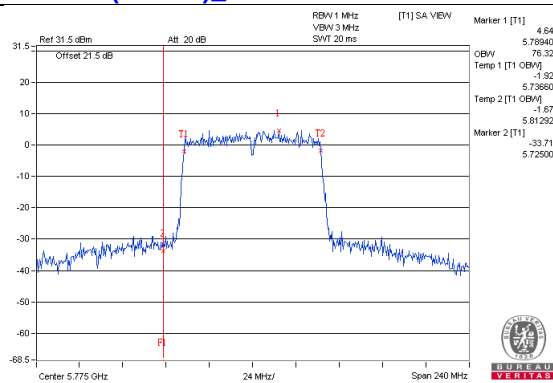

**802.11ac(VHT80)\_Chain2 / CH155**

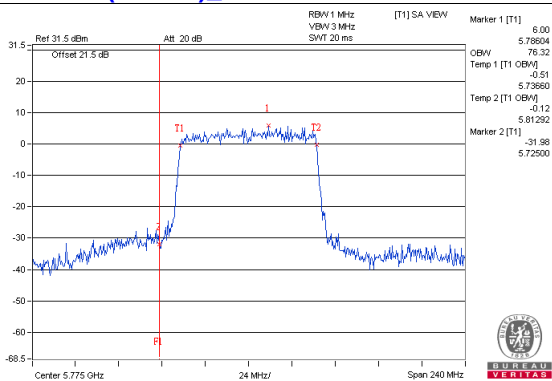

## 4.4.5 Test Results (Mode 2)

## 802.11a

Channel	Channel Frequency (MHz)	Occupied Bandwidth (MHz)	
		CHAIN 1	CHAIN 2
36	5180	16.44	16.56
40	5200	16.80	19.92
48	5240	17.16	17.88
149	5745	42.00	40.68
157	5785	43.32	41.52
165	5825	42.00	35.16

## 802.11ac (VHT20)

Channel	Channel Frequency (MHz)	Occupied Bandwidth (MHz)	
		CHAIN 1	CHAIN 2
36	5180	17.64	17.76
40	5200	18.12	22.68
48	5240	18.12	18.12
149	5745	41.28	40.20
157	5785	44.40	42.12
165	5825	42.24	36.60

## 802.11ac (VHT40)

Channel	Channel Frequency (MHz)	Occupied Bandwidth (MHz)	
		CHAIN 1	CHAIN 2
38	5190	36.24	36.24
46	5230	36.24	36.48
151	5755	45.12	43.20
159	5795	81.36	71.04

## 802.11ac (VHT80)

Channel	Channel Frequency (MHz)	Occupied Bandwidth (MHz)	
		CHAIN 1	CHAIN 2
42	5210	75.84	75.84
155	5775	76.32	75.84

### Spectrum Plot of Worst Value

802.11a\_Chain1 / CH157

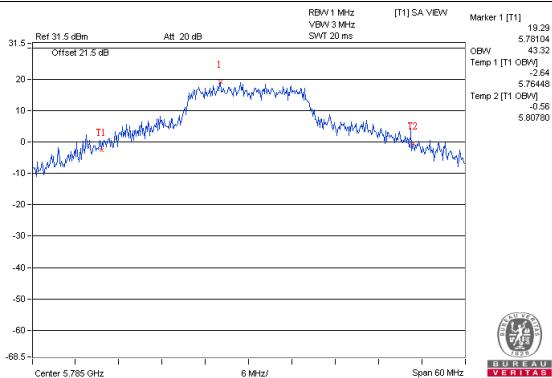

802.11ac (VHT20)\_Chain1 / CH157

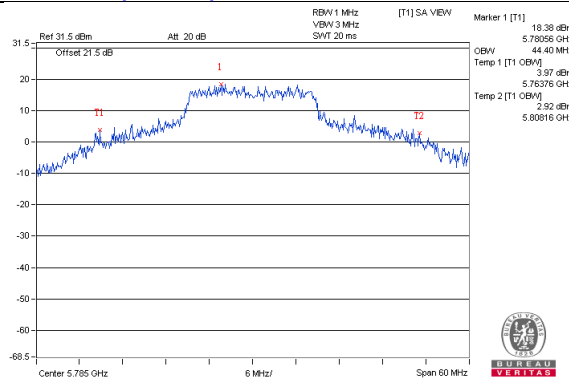

802.11ac (VHT40)\_Chain1 / CH159

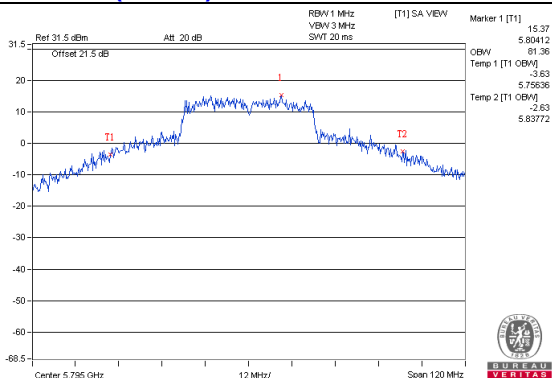

802.11ac (VHT80)\_Chain1 / CH155

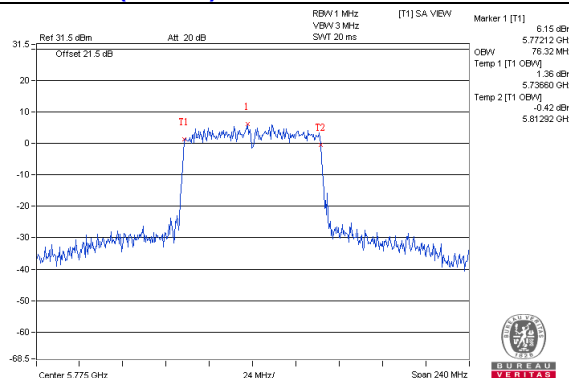

### Spectrum Plot for near by DFS band (DFS is required, if 99% OCP straddle into U-NII-2A band)

**802.11a\_Chain1 / CH48**

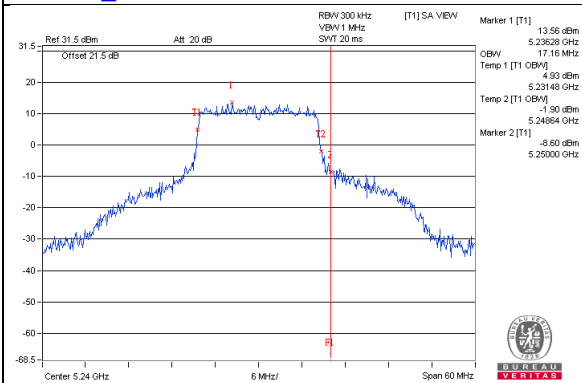

**802.11a\_Chain2 / CH48**

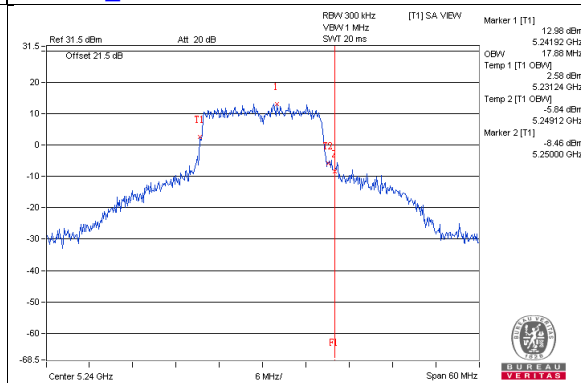

**802.11ac(VHT20)\_Chain1 / CH48**

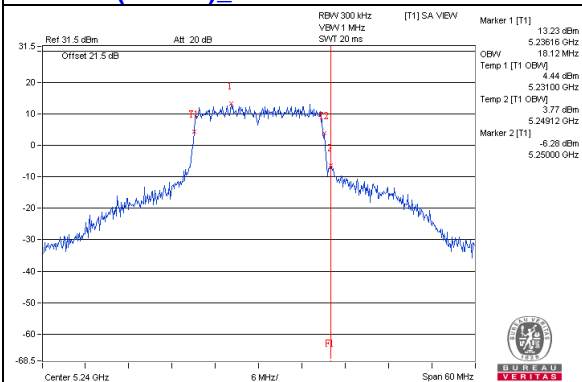

**802.11ac(VHT20)\_Chain2 / CH48**

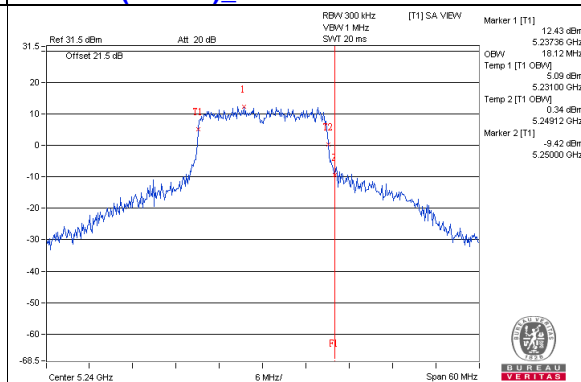

### Spectrum Plot for near by DFS band (DFS is required, if 99% OCP straddle into U-NII-2A band)

**802.11ac(VHT40)\_Chain1 / CH46**

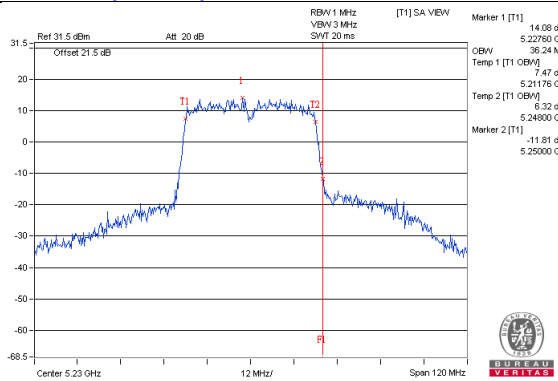

**802.11ac(VHT46)\_Chain2 / CH42**

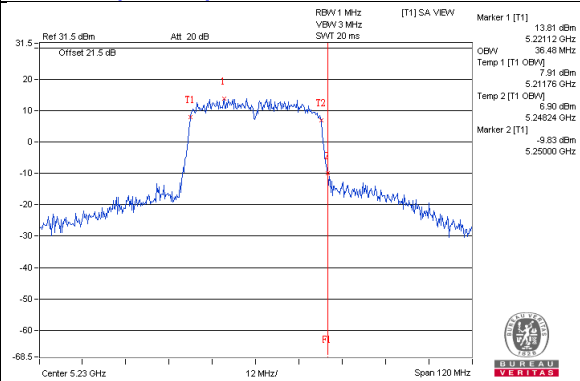

**802.11ac(VHT80)\_Chain1 / CH42**

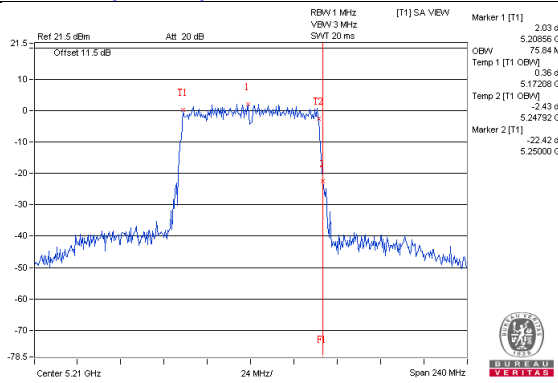

**802.11ac(VHT80)\_Chain2 / CH42**

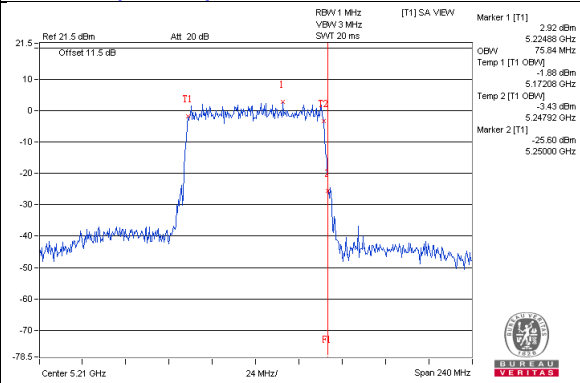

### Spectrum Plot for near by DFS band (DFS is required, if 99% OCP straddle into U-NII-2C band)

**802.11a\_Chain1 / CH149**

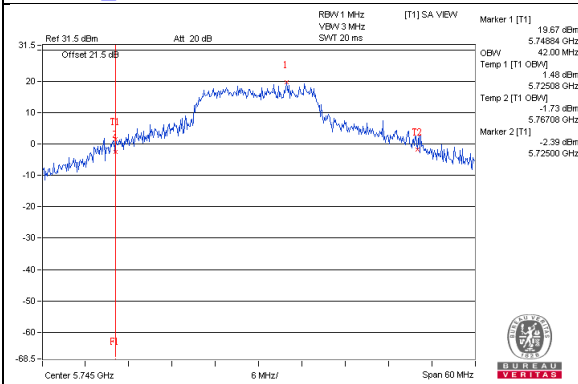

**802.11a\_Chain2 / CH149**

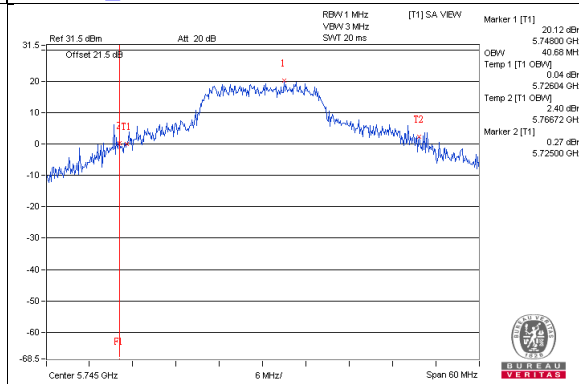

**802.11ac(VHT20)\_Chain1 / CH149**

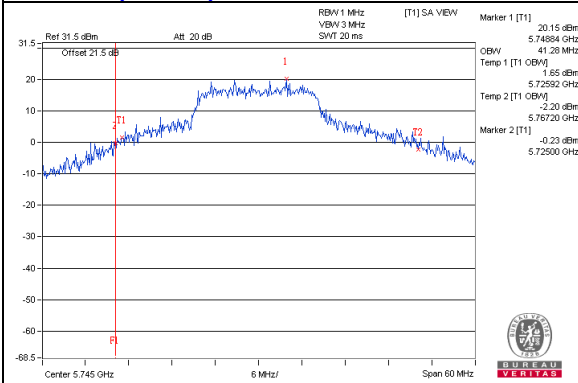

**802.11ac(VHT20)\_Chain2 / CH149**

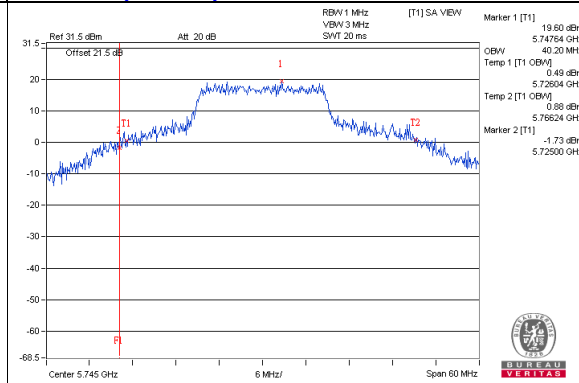

### Spectrum Plot for near by DFS band (DFS is required, if 99% OCP straddle into U-NII-2C band)

**802.11ac(VHT40)\_Chain1 / CH151**

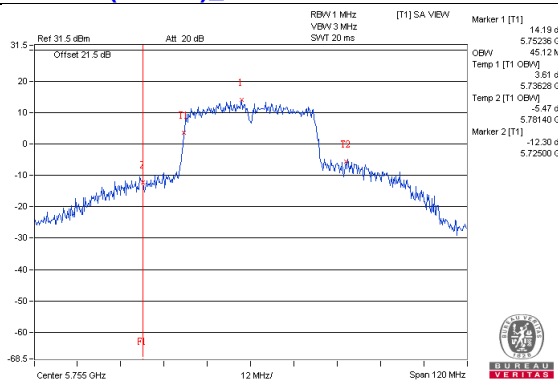

**802.11ac(VHT40)\_Chain2 / CH151**

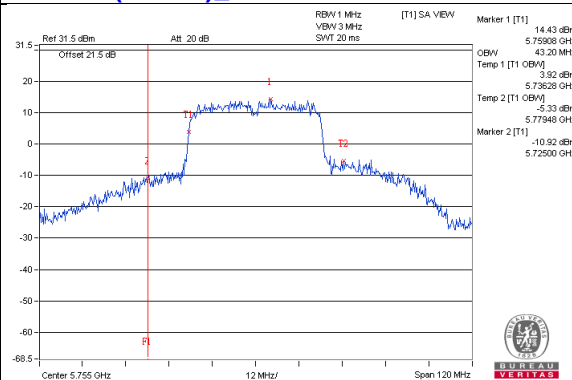

**802.11ac(VHT80)\_Chain1 / CH155**

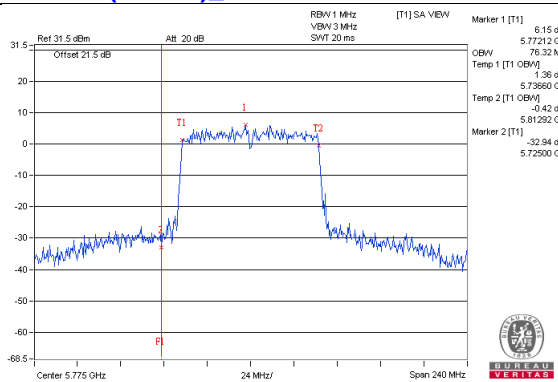

**802.11ac(VHT80)\_Chain2 / CH155**

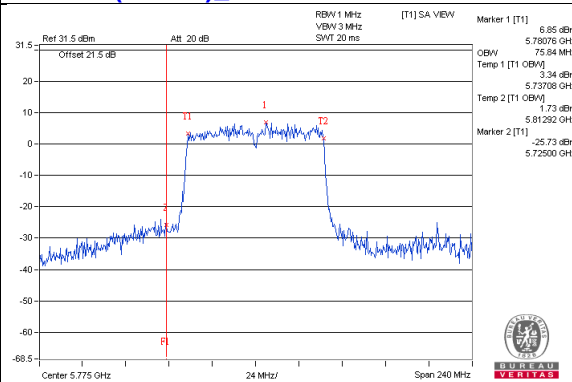

#### 4.4.6 Test Results (Mode 3)

##### 802.11a

Channel	Channel Frequency (MHz)	Occupied Bandwidth (MHz)
36	5180	16.56
40	5200	24.60
48	5240	17.88
149	5745	40.68
157	5785	41.52
165	5825	35.16

##### 802.11ac (VHT20)

Channel	Channel Frequency (MHz)	Occupied Bandwidth (MHz)
36	5180	17.76
40	5200	22.68
48	5240	18.12
149	5745	40.20
157	5785	42.12
165	5825	36.60

##### 802.11ac (VHT40)

Channel	Channel Frequency (MHz)	Occupied Bandwidth (MHz)
38	5190	36.24
46	5230	36.48
151	5755	43.20
159	5795	66.48

##### 802.11ac (VHT80)

Channel	Channel Frequency (MHz)	Occupied Bandwidth (MHz)
42	5210	76.32
155	5775	76.32



### Spectrum Plot of Worst Value

**802.11a / CH157**

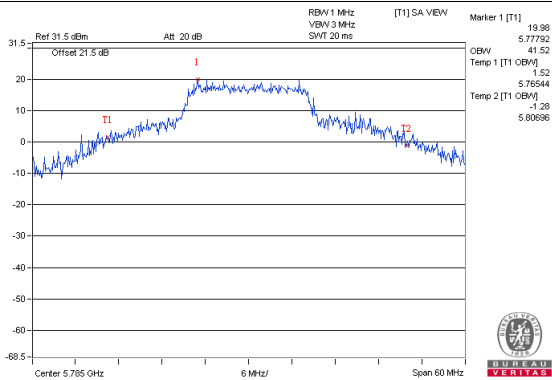

**802.11ac (VHT20) / CH157**

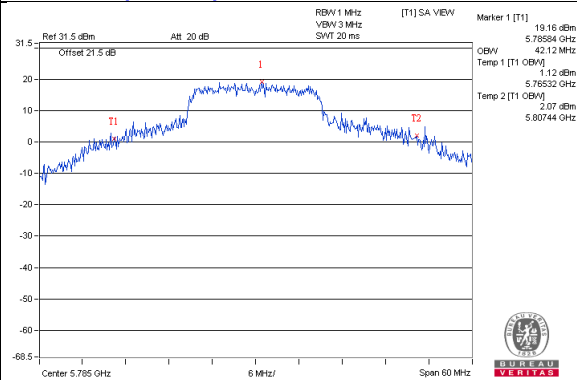

**802.11ac (VHT40) / CH159**

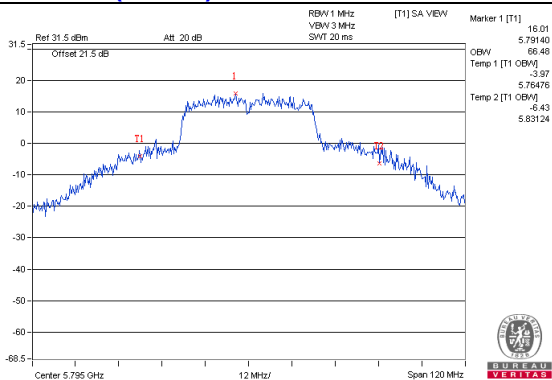

**802.11ac (VHT80) / CH42**

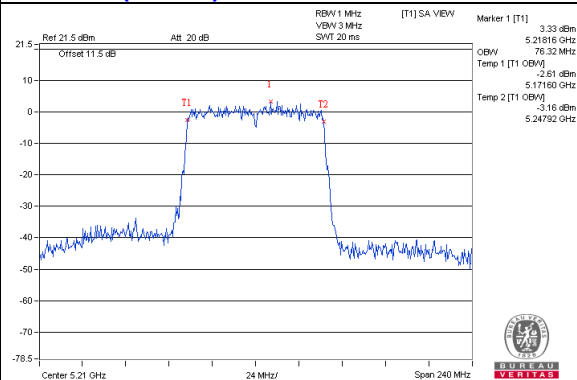

## Spectrum Plot for near by DFS band (DFS is required, if 99% OCP straddle into U-NII-2A band)

**802.11a / CH48**

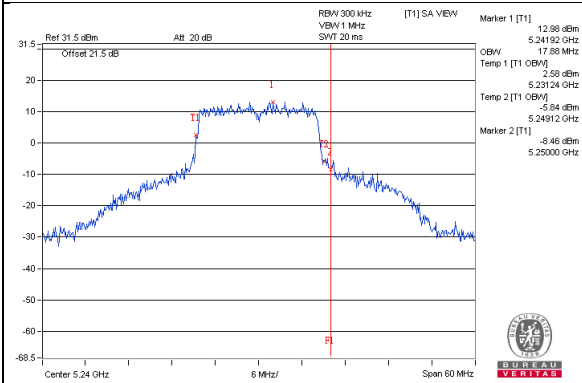

**802.11ac(VHT20) / CH48**

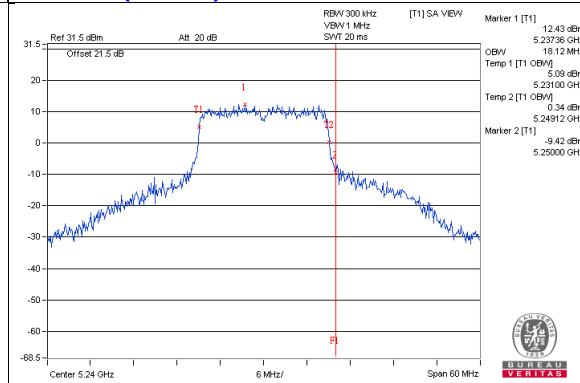

**802.11ac(VHT40) / CH46**

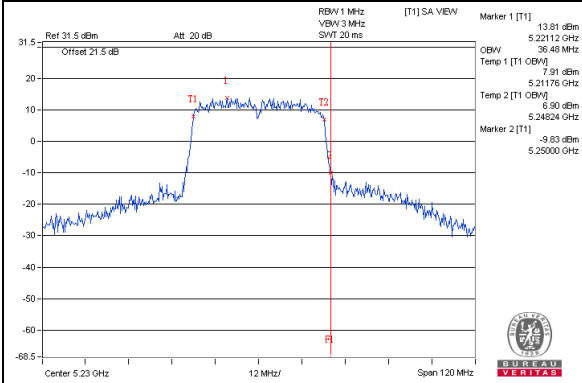

**802.11ac(VHT80) / CH42**

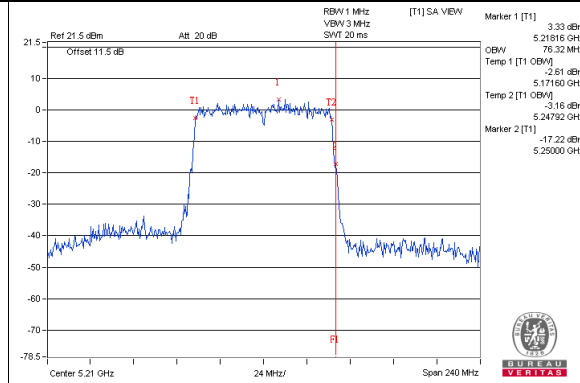

### Spectrum Plot for near by DFS band (DFS is required, if 99% OCP straddle into U-NII-2C band)

**802.11a / CH149**

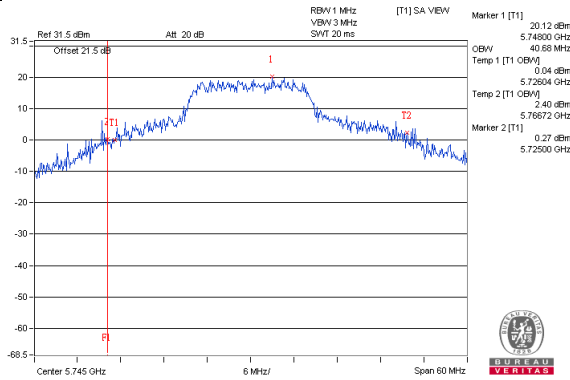

**802.11ac(VHT20) / CH149**

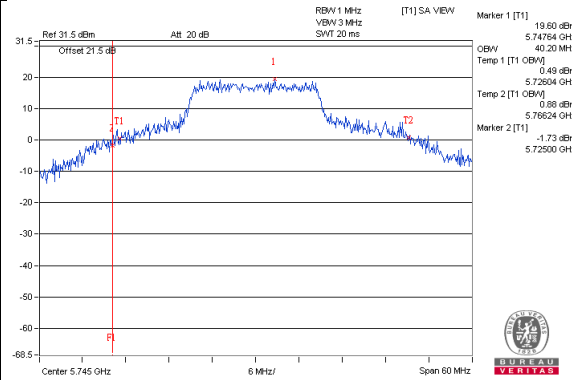

**802.11ac(VHT40) / CH151**

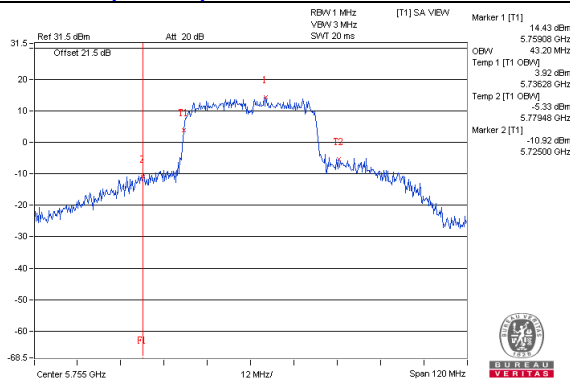

**802.11ac(VHT80) / CH155**

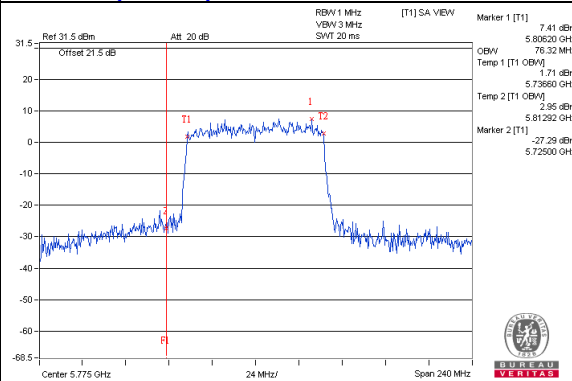

## 4.5 Peak Power Spectral Density Measurement

### 4.5.1 Limits of Peak Power Spectral Density Measurement

Operation Band	EUT Category		Limit
U-NII-1		Outdoor Access Point	17dBm/ MHz
		Fixed point-to-point Access Point	
	√	Indoor Access Point	
		Mobile and Portable client device	11dBm/ MHz
U-NII-2A			11dBm/ MHz
U-NII-2C			11dBm/ MHz
U-NII-3	√		30dBm/ 500kHz

### 4.5.2 Test Setup

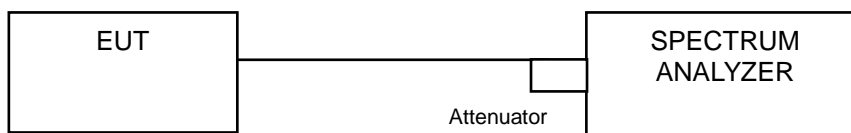

### 4.5.3 Test Instruments

Refer to section 4.1.2 to get information of above instrument.

#### 4.5.4 Test Procedure

##### **802.11ac (VHT20)**

###### **For U-NII-1:**

Using method SA-1

1. Set span to encompass the entire emission bandwidth (EBW) of the signal.
2. Set RBW = 1 MHz, Set VBW  $\geq$  3 MHz, Detector = RMS
3. Sweep time = auto, trigger set to "free run".
4. Trace average at least 100 traces in power averaging mode.
5. Record the max value

###### **For U-NII-3:**

1. Set span to encompass the entire emission bandwidth (EBW) of the signal.
2. Set RBW = 300 kHz, Set VBW  $\geq$  1 MHz, Detector = RMS
3. Use the peak marker function to determine the maximum power level in any 300 kHz band segment within the fundamental EBW.
4. Scale the observed power level to an equivalent value in 500 kHz by adjusting (reducing) the measured power by a bandwidth correction factor (BWCF) where  $BWCF = 10\log(500 \text{ kHz}/300\text{kHz})$
5. Sweep time = auto, trigger set to "free run".
6. Trace average at least 100 traces in power averaging mode.
7. Record the max value

##### **802.11a, 802.11ac (VHT40), 802.11ac (VHT80)**

###### **For U-NII-1:**

Using method SA-2

1. Set span to encompass the entire emission bandwidth (EBW) of the signal.
2. Set RBW = 1 MHz, Set VBW  $\geq$  3 MHz, Detector = RMS
3. Sweep time = auto, trigger set to "free run".
4. Trace average at least 100 traces in power averaging mode.
5. Record the max value and add  $10 \log (1/\text{duty cycle})$

###### **For U-NII-3:**

1. Set span to encompass the entire emission bandwidth (EBW) of the signal.
2. Set RBW = 300 kHz, Set VBW  $\geq$  1 MHz, Detector = RMS
3. Use the peak marker function to determine the maximum power level in any 300 kHz band segment within the fundamental EBW.
4. Scale the observed power level to an equivalent value in 500 kHz by adjusting (reducing) the measured power by a bandwidth correction factor (BWCF) where  $BWCF = 10\log(500 \text{ kHz}/300\text{kHz})$
5. Sweep time = auto, trigger set to "free run".
6. Trace average at least 100 traces in power averaging mode.
7. Record the max value and add  $10 \log (1/\text{duty cycle})$

#### 4.5.5 Deviation from Test Standard

No deviation.

#### 4.5.6 EUT Operating Condition

Same as Item 4.3.6.

#### 4.5.7 Test Results (Mode 1)

##### For U-NII-1:

##### 802.11a

Chan.	Chan. Freq. (MHz)	PSD W/O Duty Factor (dBm/MHz)			Duty Factor (dB)	Total PSD With Duty Factor (dBm/MHz)	MAX. Limit (dBm/MHz)	Pass / Fail
		Chain 0	Chain 1	Chain 2				
36	5180	5.15	4.96	5.23	0.14	10.03	12.50	Pass
40	5200	6.14	6.03	6.37	0.14	11.09	12.50	Pass
48	5240	5.99	6.71	6.75	0.14	11.41	12.50	Pass

- Note:**
- Method a) of power density measurement of KDB 662911 is using for calculating total power density. Total power density is summing entire spectra across corresponding frequency bins on the various outputs by computer.
  - Directional gain =  $10 \log[(10^{G1/20} + 10^{G2/20} + 10^{G3/20})^2 / 3] = 10.5\text{dBi} > 6\text{dBi}$ , so the power density limit shall be reduced to  $17 - (10.5 - 6) = 12.5\text{dBm}$ .
  - Refer to section 3.3 for duty cycle spectrum plot.

##### 802.11ac (VHT20)

Chan.	Chan. Freq. (MHz)	PSD (dBm/MHz)			Total Power Density (dBm/MHz)	MAX. Limit (dBm/MHz)	Pass / Fail
		Chain 0	Chain 1	Chain 2			
36	5180	3.33	3.53	3.50	8.23	12.50	Pass
40	5200	6.02	6.24	6.25	10.94	12.50	Pass
48	5240	6.46	6.57	6.69	11.35	12.50	Pass

- Note:**
- Method a) of power density measurement of KDB 662911 is using for calculating total power density. Total power density is summing entire spectra across corresponding frequency bins on the various outputs by computer.
  - Directional gain =  $10 \log[(10^{G1/20} + 10^{G2/20} + 10^{G3/20})^2 / 3] = 10.5\text{dBi} > 6\text{dBi}$ , so the power density limit shall be reduced to  $17 - (10.5 - 6) = 12.5\text{dBm}$ .

### 802.11ac (VHT40)

Chan.	Chan. Freq. (MHz)	PSD W/O Duty Factor (dBm/MHz)			Duty Factor (dB)	Total PSD With Duty Factor (dBm/MHz)	MAX. Limit (dBm/MHz)	Pass / Fail
		Chain 0	Chain 1	Chain 2				
38	5190	-0.46	-0.38	-0.27	0.13	4.54	12.50	Pass
46	5230	3.08	3.53	3.66	0.13	8.34	12.50	Pass

- Note:**
- Method a) of power density measurement of KDB 662911 is using for calculating total power density. Total power density is summing entire spectra across corresponding frequency bins on the various outputs by computer.
  - Directional gain =  $10 \log[(10^{G1/20} + 10^{G2/20} + 10^{G3/20})^2 / 3] = 10.5\text{dBi} > 6\text{dBi}$ , so the power density limit shall be reduced to  $17 - (10.5 - 6) = 12.5\text{dBm}$ .
  - Refer to section 3.3 for duty cycle spectrum plot.

### 802.11ac (VHT80)

Chan.	Chan. Freq. (MHz)	PSD W/O Duty Factor (dBm/MHz)			Duty Factor (dB)	Total PSD With Duty Factor (dBm/MHz)	MAX. Limit (dBm/MHz)	Pass / Fail
		Chain 0	Chain 1	Chain 2				
42	5210	-9.45	-9.29	-8.17	0.23	-3.93	12.50	Pass

- Note:**
- Method a) of power density measurement of KDB 662911 is using for calculating total power density. Total power density is summing entire spectra across corresponding frequency bins on the various outputs by computer.
  - Directional gain =  $10 \log[(10^{G1/20} + 10^{G2/20} + 10^{G3/20})^2 / 3] = 10.5\text{dBi} > 6\text{dBi}$ , so the power density limit shall be reduced to  $17 - (10.5 - 6) = 12.5\text{dBm}$ .
  - Refer to section 3.3 for duty cycle spectrum plot.

Spectrum Plot of Worst Value

802.11a\_Chain 2 / CH48

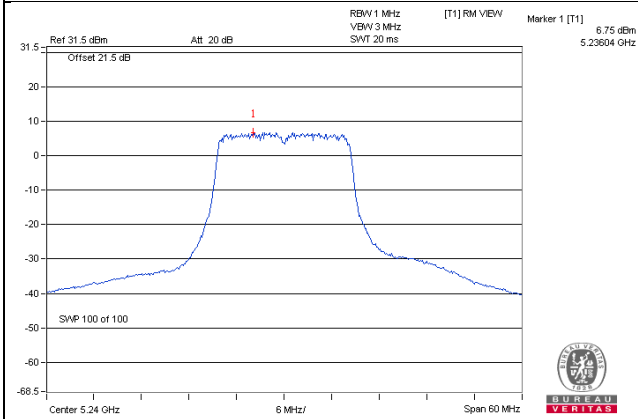

802.11ac (VHT20)\_Chain 2 / CH48

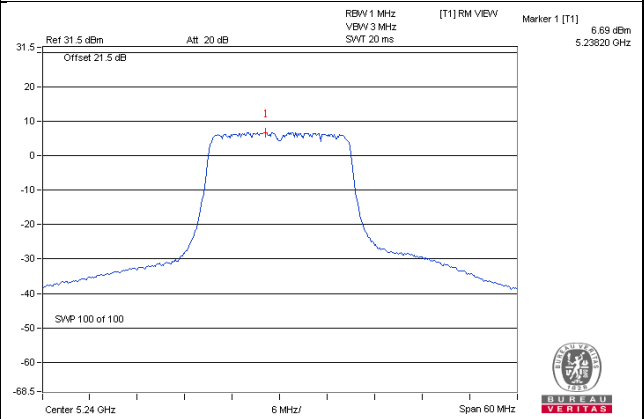

802.11ac (VHT40)\_Chain 2 / CH46

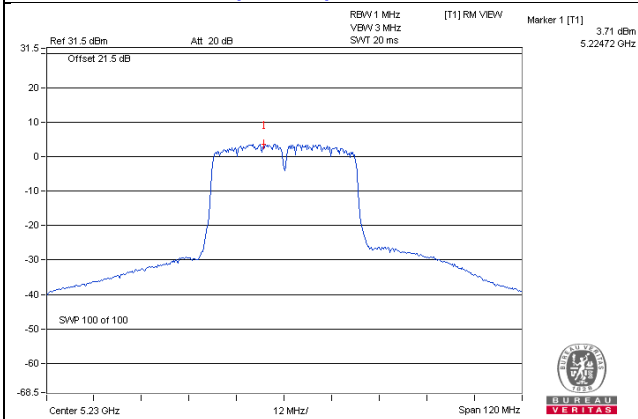

802.11ac (VHT80)\_Chain 2 / CH42

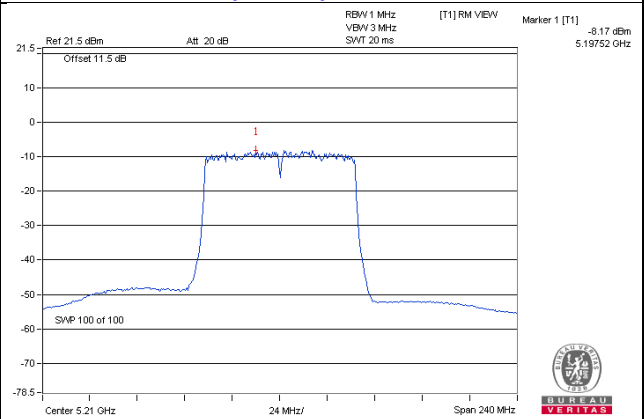



**For U-NII-3:**  
**802.11a**

TX chain	Chan.	Chan. Freq. (MHz)	PSD W/O Duty Factor		10 log (N=3) dB	Duty Factor (dB)	Total PSD With Duty Factor (dBm/500kHz)	Limit (dBm/500kHz)	Pass /Fail
			(dBm/300kHz)	(dBm/500kHz)					
0	149	5745	1.30	3.52	4.77	0.14	8.43	25.50	Pass
	157	5785	1.08	3.30	4.77	0.14	8.21	25.50	Pass
	165	5825	1.00	3.22	4.77	0.14	8.13	25.50	Pass
1	149	5745	0.33	2.55	4.77	0.14	7.46	25.50	Pass
	157	5785	0.37	2.59	4.77	0.14	7.50	25.50	Pass
	165	5825	0.21	2.43	4.77	0.14	7.34	25.50	Pass
2	149	5745	1.20	3.42	4.77	0.14	8.33	25.50	Pass
	157	5785	1.17	3.39	4.77	0.14	8.30	25.50	Pass
	165	5825	1.71	3.93	4.77	0.14	8.84	25.50	Pass

- Note: 1. Directional gain =  $10 \log[(10^{G1/20} + 10^{G2/20} + 10^{G3/20})^2 / 3] = 10.5\text{dBi} > 6\text{dBi}$  , so the power density limit shall be reduced to  $30-(10.5-6) = 25.5\text{dBm}$ .  
 2. Refer to section 3.3 for duty cycle spectrum plot.

**802.11ac (VHT20)**

TX chain	Channel	Freq. (MHz)	PSD (dBm/300kHz)	PSD (dBm/500kHz)	10 log (N=3) dB	Total PSD (dBm/500kHz)	Limit (dBm/500kHz)	Pass /Fail
0	149	5745	0.58	2.80	4.77	7.57	25.50	Pass
	157	5785	0.51	2.73	4.77	7.50	25.50	Pass
	165	5825	0.58	2.80	4.77	7.57	25.50	Pass
1	149	5745	0.16	2.38	4.77	7.15	25.50	Pass
	157	5785	0.10	2.32	4.77	7.09	25.50	Pass
	165	5825	0.03	2.25	4.77	7.02	25.50	Pass
2	149	5745	0.98	3.20	4.77	7.97	25.50	Pass
	157	5785	1.07	3.29	4.77	8.06	25.50	Pass
	165	5825	1.06	3.28	4.77	8.05	25.50	Pass

- Note: 1. Directional gain =  $10 \log[(10^{G1/20} + 10^{G2/20} + 10^{G3/20})^2 / 3] = 10.5\text{dBi} > 6\text{dBi}$  , so the power density limit shall be reduced to  $30-(10.5-6) = 25.5\text{dBm}$ .  
 2. Refer to section 3.3 for duty cycle spectrum plot.

### 802.11ac (VHT40)

TX chain	Chan.	Chan. Freq. (MHz)	PSD W/O Duty Factor		10 log (N=3) dB	Duty Factor (dB)	Total PSD With Duty Factor (dBm/500kHz)	Limit (dBm/500kHz)	Pass /Fail
			(dBm/300kHz)	(dBm/500kHz)					
0	151	5755	-4.20	-1.98	4.77	0.13	2.92	25.50	Pass
	159	5795	-3.25	-1.03	4.77	0.13	3.87	25.50	Pass
1	151	5755	-5.09	-2.87	4.77	0.13	2.03	25.50	Pass
	159	5795	-4.00	-1.78	4.77	0.13	3.12	25.50	Pass
2	151	5755	-4.33	-2.11	4.77	0.13	2.79	25.50	Pass
	159	5795	-3.15	-0.93	4.77	0.13	3.97	25.50	Pass

Note: 1. Directional gain =  $10 \log[(10^{G1/20} + 10^{G2/20} + 10^{G3/20})^2 / 3] = 10.5\text{dBi} > 6\text{dBi}$  , so the power density limit shall be reduced to  $30-(10.5-6) = 25.5\text{dBm}$ .

2. Refer to section 3.3 for duty cycle spectrum plot.

### 802.11ac (VHT80)

TX chain	Chan.	Chan. Freq. (MHz)	PSD W/O Duty Factor		10 log (N=3) dB	Duty Factor (dB)	Total PSD With Duty Factor (dBm/500kHz)	Limit (dBm/500kHz)	Pass /Fail
			(dBm/300kHz)	(dBm/500kHz)					
0	155	5775	-13.14	-10.92	4.77	0.23	-5.92	25.50	Pass
1	155	5775	-13.68	-11.46	4.77	0.23	-6.46	25.50	Pass
2	155	5775	-12.94	-10.72	4.77	0.23	-5.72	25.50	Pass

Note: 1. Directional gain =  $10 \log[(10^{G1/20} + 10^{G2/20} + 10^{G3/20})^2 / 3] = 10.5\text{dBi} > 6\text{dBi}$  , so the power density limit shall be reduced to  $30-(10.5-6) = 25.5\text{dBm}$ .

2. Refer to section 3.3 for duty cycle spectrum plot.

Spectrum Plot of Worst Value

802.11a – Chain 0: CH 149

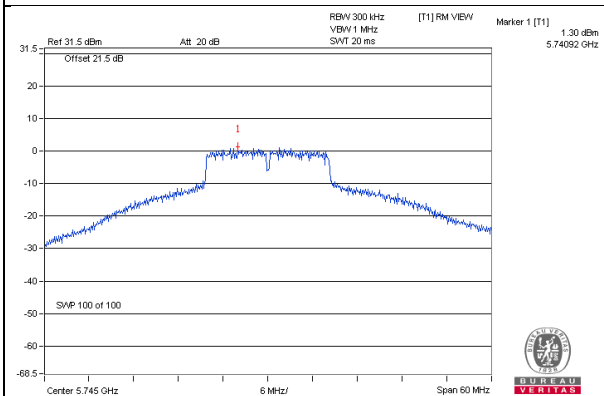

802.11a (VHT20) – Chain 2: CH 157

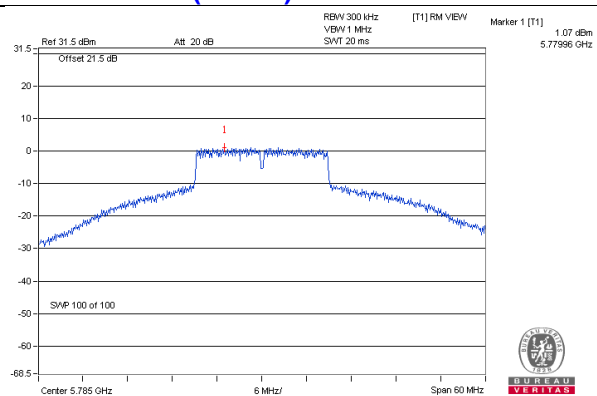

802.11ac (VHT40) – Chain 2: CH 159

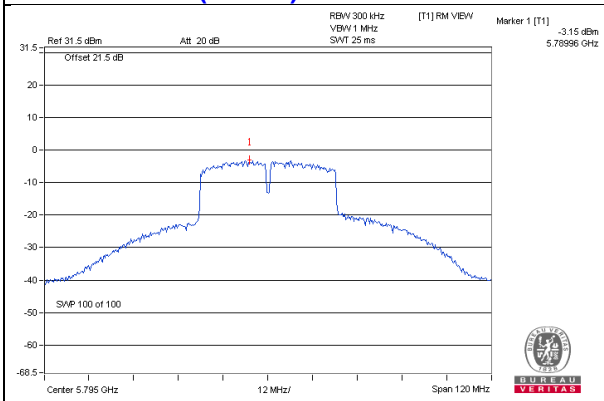

802.11ac (VHT80) – Chain 2: CH 155

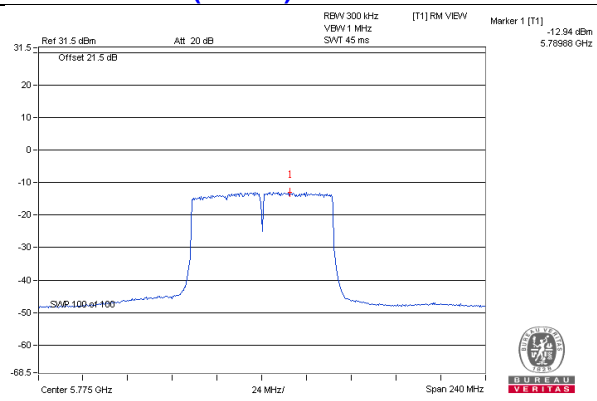

#### 4.5.8 Test Results (Mode 2)

##### For U-NII-1:

##### 802.11a

Chan.	Chan. Freq. (MHz)	PSD W/O Duty Factor (dBm)		Duty Factor (dB)	Total PSD With Duty Factor (dBm)	MAX. Limit (dBm)	Pass / Fail
		Chain 1	Chain 2				
36	5180	5.66	5.75	0.14	8.85	14.15	Pass
40	5200	8.65	8.67	0.14	11.81	14.15	Pass
48	5240	8.86	8.33	0.14	11.75	14.15	Pass

- Note:**
- Method a) of power density measurement of KDB 662911 is using for calculating total power density. Total power density is summing entire spectra across corresponding frequency bins on the various outputs by computer.
  - Directional gain =  $10 \log[(10^{G2/20} + 10^{G3/20})^2 / 2] = 8.85\text{dBi} > 6\text{dBi}$ , so the power density limit shall be reduced to  $17 - (8.85 - 6) = 14.15\text{dBm}$ .
  - Refer to section 3.3 for duty cycle spectrum plot.

##### 802.11ac (VHT20)

Chan.	Chan. Freq. (MHz)	PSD (dBm/MHz)		Total Power Density (dBm/MHz)	MAX. Limit (dBm/MHz)	Pass / Fail
		Chain 1	Chain 2			
36	5180	6.11	6.12	9.13	14.15	Pass
40	5200	8.54	8.71	11.64	14.15	Pass
48	5240	8.52	8.08	11.32	14.15	Pass

- Note:**
- Method a) of power density measurement of KDB 662911 is using for calculating total power density. Total power density is summing entire spectra across corresponding frequency bins on the various outputs by computer.
  - Directional gain =  $10 \log[(10^{G2/20} + 10^{G3/20})^2 / 2] = 8.85\text{dBi} > 6\text{dBi}$ , so the power density limit shall be reduced to  $17 - (8.85 - 6) = 14.15\text{dBm}$ .

### 802.11ac (VHT40)

Chan.	Chan. Freq. (MHz)	PSD W/O Duty Factor (dBm)		Duty Factor (dB)	Total PSD With Duty Factor (dBm)	MAX. Limit (dBm)	Pass / Fail
		Chain 1	Chain 2				
38	5190	0.02	0.27	0.13	3.29	14.15	Pass
46	5230	3.77	4.23	0.13	7.15	14.15	Pass

- Note:**
- Method a) of power density measurement of KDB 662911 is using for calculating total power density. Total power density is summing entire spectra across corresponding frequency bins on the various outputs by computer.
  - Directional gain =  $10 \log[(10^{G2/20} + 10^{G3/20})^2 / 2] = 8.85\text{dBi} > 6\text{dBi}$ , so the power density limit shall be reduced to  $17 - (8.85 - 6) = 14.15\text{dBm}$ .
  - Refer to section 3.3 for duty cycle spectrum plot.

### 802.11ac (VHT80)

Chan.	Chan. Freq. (MHz)	PSD W/O Duty Factor (dBm)		Duty Factor (dB)	Total PSD With Duty Factor (dBm)	MAX. Limit (dBm)	Pass / Fail
		Chain 1	Chain 2				
42	5210	-7.81	-7.72	0.23	-4.52	14.15	Pass

- Note:**
- Method a) of power density measurement of KDB 662911 is using for calculating total power density. Total power density is summing entire spectra across corresponding frequency bins on the various outputs by computer.
  - Directional gain =  $10 \log[(10^{G2/20} + 10^{G3/20})^2 / 2] = 8.85\text{dBi} > 6\text{dBi}$ , so the power density limit shall be reduced to  $17 - (8.85 - 6) = 14.15\text{dBm}$ .
  - Refer to section 3.3 for duty cycle spectrum plot.

Spectrum Plot of Worst Value

802.11a\_Chain 1 / CH40

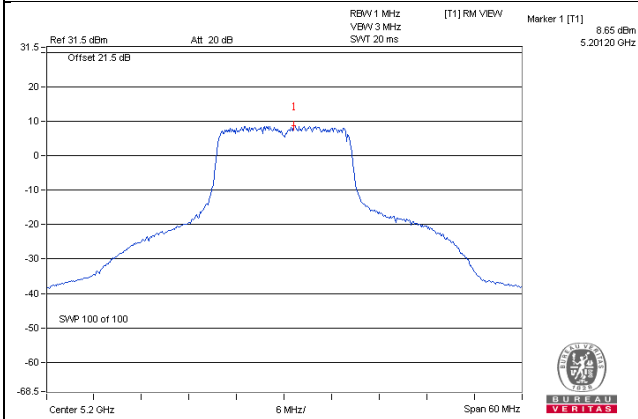

802.11ac (VHT20)\_Chain 1 / CH40

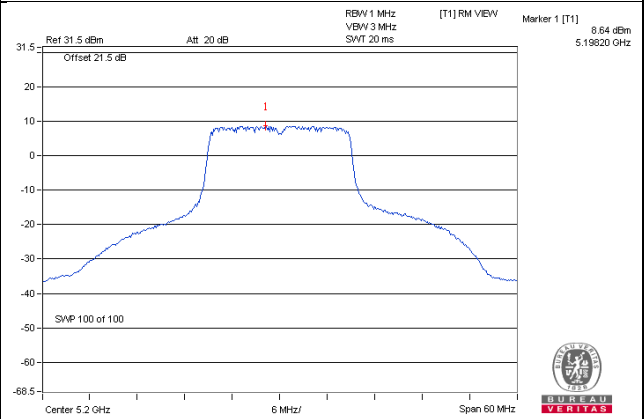

802.11ac (VHT40)\_Chain 2 / CH46

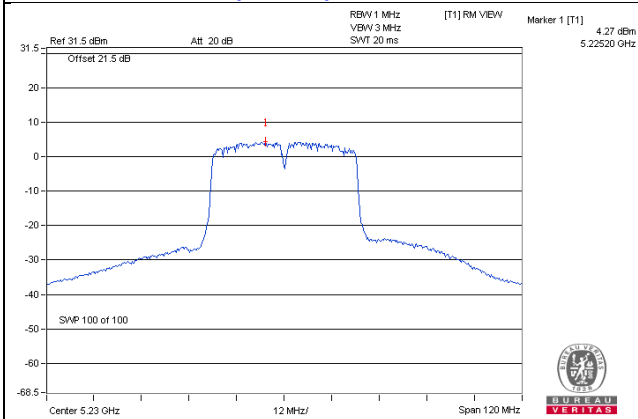

802.11ac (VHT80)\_Chain 2 / CH42

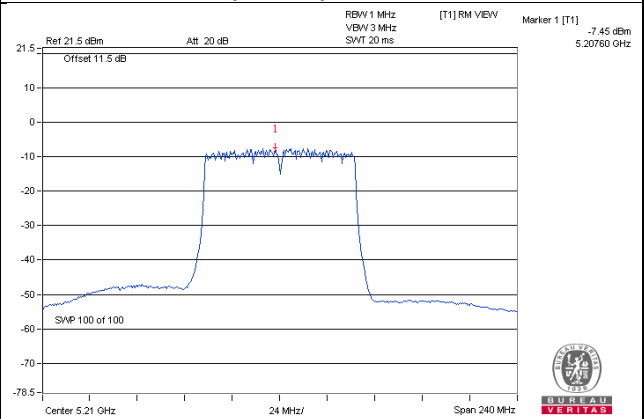

**For U-NII-3:**
**802.11a**

TX chain	Chan.	Chan. Freq. (MHz)	PSD W/O Duty Factor		10 log (N=2) dB	Duty Factor (dB)	Total PSD With Duty Factor (dBm/500kHz)	Limit (dBm/500kHz)	Pass /Fail
			(dBm/300kHz)	(dBm/500kHz)					
1	149	5745	0.33	2.55	3.01	0.14	5.70	27.15	Pass
	157	5785	0.37	2.59	3.01	0.14	5.74	27.15	Pass
	165	5825	0.21	2.43	3.01	0.14	5.58	27.15	Pass
2	149	5745	1.20	3.42	3.01	0.14	6.57	27.15	Pass
	157	5785	1.17	3.39	3.01	0.14	6.54	27.15	Pass
	165	5825	1.71	3.93	3.01	0.14	7.08	27.15	Pass

Note: 1. Directional gain =  $10 \log[(10^{G2/20} + 10^{G3/20})^2 / 2] = 8.85\text{dBi} > 6\text{dBi}$  , so the power density limit shall be reduced to  $30-(8.85-6) = 27.15\text{dBm}$ .

2. Refer to section 3.3 for duty cycle spectrum plot.

**802.11ac (VHT20)**

TX chain	Channel	Freq. (MHz)	PSD (dBm/300kHz)	PSD (dBm/500kHz)	10 log (N=2) dB	Total PSD (dBm/500kHz)	Limit (dBm/500kHz)	Pass /Fail
1	149	5745	0.16	2.38	3.01	5.39	27.15	Pass
	157	5785	0.10	2.32	3.01	5.33	27.15	Pass
	165	5825	0.03	2.25	3.01	5.26	27.15	Pass
2	149	5745	0.98	3.20	3.01	6.21	27.15	Pass
	157	5785	1.07	3.29	3.01	6.30	27.15	Pass
	165	5825	1.06	3.28	3.01	6.29	27.15	Pass

Note: 1. Directional gain =  $10 \log[(10^{G2/20} + 10^{G3/20})^2 / 2] = 8.85\text{dBi} > 6\text{dBi}$  , so the power density limit shall be reduced to  $30-(8.85-6) = 27.15\text{dBm}$ .

### 802.11ac (VHT40)

TX chain	Chan.	Chan. Freq. (MHz)	PSD W/O Duty Factor		10 log (N=2) dB	Duty Factor (dB)	Total PSD With Duty Factor (dBm/500kHz)	Limit (dBm/500kHz)	Pass /Fail
			(dBm/300kHz)	(dBm/500kHz)					
1	151	5755	-4.71	-2.49	3.01	0.13	0.65	27.15	Pass
	159	5795	-3.26	-1.04	3.01	0.13	2.10	27.15	Pass
2	151	5755	-3.93	-1.71	3.01	0.13	1.43	27.15	Pass
	159	5795	-2.25	-0.03	3.01	0.13	3.11	27.15	Pass

Note: 1. Directional gain =  $10 \log[(10^{G2/20} + 10^{G3/20})^2 / 2] = 8.85\text{dBi} > 6\text{dBi}$  , so the power density limit shall be reduced to  $30-(8.85-6) = 27.15\text{dBm}$ .

2. Refer to section 3.3 for duty cycle spectrum plot.

### 802.11ac (VHT80)

TX chain	Chan.	Chan. Freq. (MHz)	PSD W/O Duty Factor		10 log (N=2) dB	Duty Factor (dB)	Total PSD With Duty Factor (dBm/500kHz)	Limit (dBm/500kHz)	Pass /Fail
			(dBm/300kHz)	(dBm/500kHz)					
1	155	5775	-12.76	-10.54	3.01	0.23	-7.30	27.15	Pass
2	155	5775	-11.98	-9.76	3.01	0.23	-6.52	27.15	Pass

Note: 1. Directional gain =  $10 \log[(10^{G2/20} + 10^{G3/20})^2 / 2] = 8.85\text{dBi} > 6\text{dBi}$  , so the power density limit shall be reduced to  $30-(8.85-6) = 27.15\text{dBm}$ .

2. Refer to section 3.3 for duty cycle spectrum plot.



### Spectrum Plot of Worst Value

**802.11a – Chain 2: CH 165**

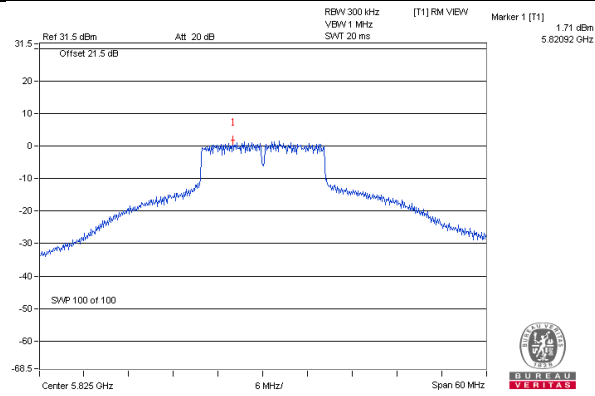

**802.11a (VHT20) – Chain 2: CH 157**

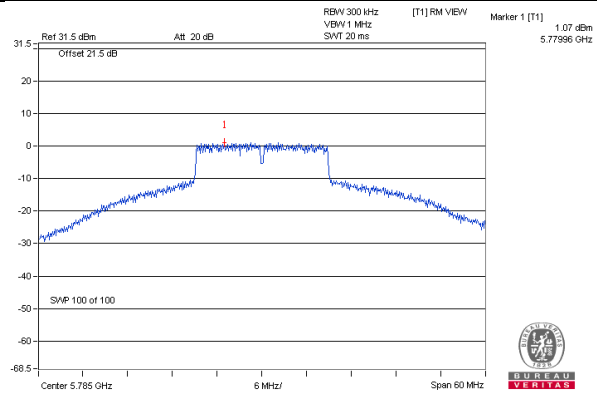

**802.11ac (VHT40) – Chain 2: CH 159**

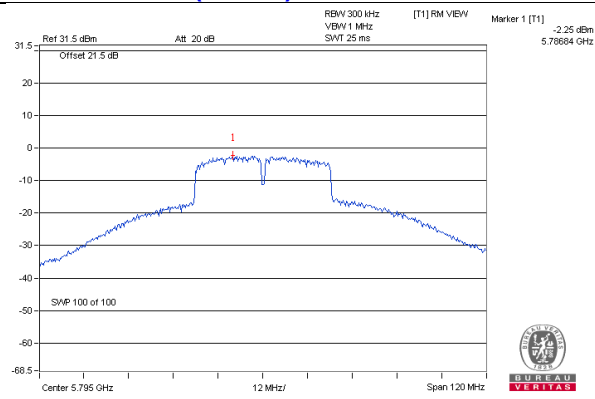

**802.11ac (VHT80) – Chain 2: CH 155**

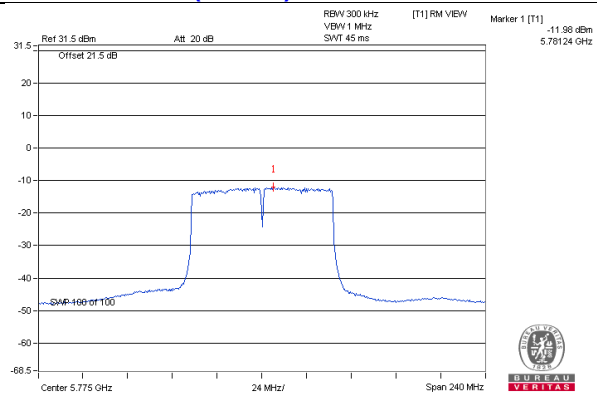

#### 4.5.9 Test Results (Mode 3)

##### For U-NII-1:

##### 802.11a

Chan.	Chan. Freq. (MHz)	PSD W/O Duty Factor (dBm/MHz)	Duty Factor (dB)	PSD With Duty Factor (dBm/MHz)	MAX. Limit (dBm/MHz)	Pass / Fail
36	5180	6.38	0.14	6.52	17.00	Pass
40	5200	9.04	0.14	9.18	17.00	Pass
48	5240	8.49	0.14	8.63	17.00	Pass

**Note:** 1. Refer to section 3.3 for duty cycle spectrum plot.

##### 802.11ac (VHT20)

Chan.	Chan. Freq. (MHz)	PSD (dBm/MHz)	MAX. Limit (dBm/MHz)	Pass / Fail
36	5180	6.17	17.00	Pass
40	5200	8.71	17.00	Pass
48	5240	8.08	17.00	Pass

##### 802.11ac (VHT40)

Chan.	Chan. Freq. (MHz)	PSD W/O Duty Factor (dBm/MHz)	Duty Factor (dB)	PSD With Duty Factor (dBm/MHz)	MAX. Limit (dBm/MHz)	Pass / Fail
38	5190	1.68	0.13	1.81	17.00	Pass
46	5230	4.27	0.13	4.40	17.00	Pass

**Note:** 1. Refer to section 3.3 for duty cycle spectrum plot.

##### 802.11ac (VHT80)

Chan.	Chan. Freq. (MHz)	PSD W/O Duty Factor (dBm/MHz)	Duty Factor (dB)	PSD With Duty Factor (dBm/MHz)	MAX. Limit (dBm/MHz)	Pass / Fail
42	5210	-7.15	0.23	-6.91	17.00	Pass

**Note:** 1. Refer to section 3.3 for duty cycle spectrum plot.

Spectrum Plot of Worst Value

802.11a / CH40

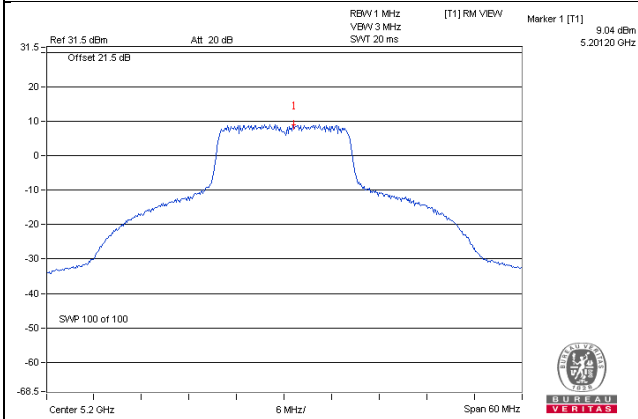

802.11ac (VHT20) / CH40

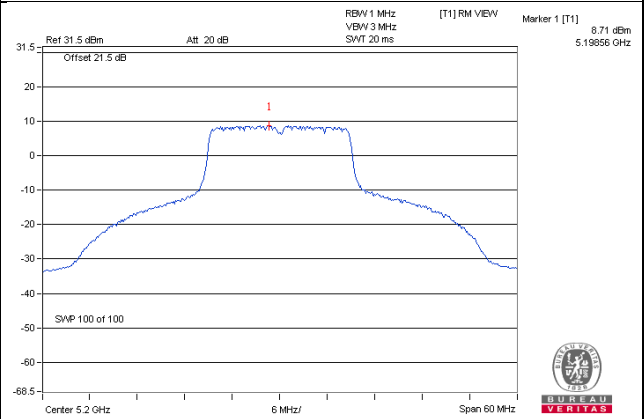

802.11ac (VHT40) / CH46

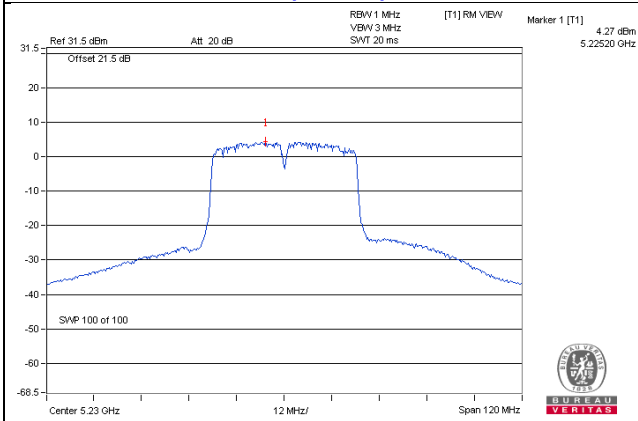

802.11ac (VHT80) / CH42

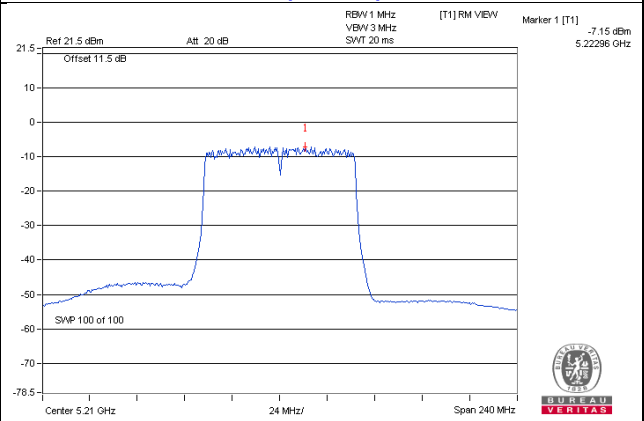

**For U-NII-3:**
**802.11a**

Chan.	Chan. Freq. (MHz)	PSD W/O Duty Factor		Duty Factor (dB)	Total PSD With Duty Factor (dBm/500kHz)	Limit (dBm/500kHz)	Pass /Fail
		(dBm/300kHz)	(dBm/500kHz)				
149	5745	1.20	3.42	0.14	3.56	30.00	Pass
157	5785	1.17	3.39	0.14	3.53	30.00	Pass
165	5825	1.71	3.93	0.14	4.07	30.00	Pass

**Note:** 1. Refer to section 3.3 for duty cycle spectrum plot.

**802.11ac (VHT20)**

Chan.	Chan. Freq. (MHz)	PSD (dBm/300kHz)	PSD (dBm/500kHz)	Limit (dBm/500kHz)	Pass /Fail
149	5745	0.98	3.20	30.00	Pass
157	5785	1.07	3.29	30.00	Pass
165	5825	1.06	3.28	30.00	Pass

**802.11ac (VHT40)**

Chan.	Chan. Freq. (MHz)	PSD W/O Duty Factor		Duty Factor (dB)	Total PSD With Duty Factor (dBm/500kHz)	Limit (dBm/500kHz)	Pass /Fail
		(dBm/300kHz)	(dBm/500kHz)				
151	5755	-3.93	-1.71	0.13	-1.58	30.00	Pass
159	5795	-2.44	-0.22	0.13	-0.09	30.00	Pass

**Note:** 1. Refer to section 3.3 for duty cycle spectrum plot.

**802.11ac (VHT80)**

Chan.	Chan. Freq. (MHz)	PSD W/O Duty Factor		Duty Factor (dB)	Total PSD With Duty Factor (dBm/500kHz)	Limit (dBm/500kHz)	Pass /Fail
		(dBm/300kHz)	(dBm/500kHz)				
155	5775	-11.50	-9.28	0.23	-9.05	30.00	Pass

**Note:** 1. Refer to section 3.3 for duty cycle spectrum plot.

Spectrum Plot of Worst Value

802.11a: CH 165

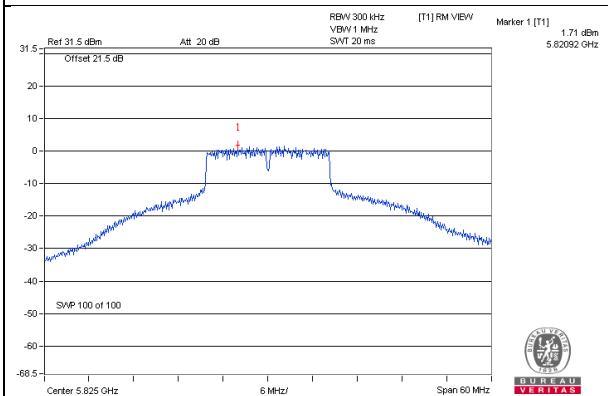

802.11ac (VHT20): CH 157

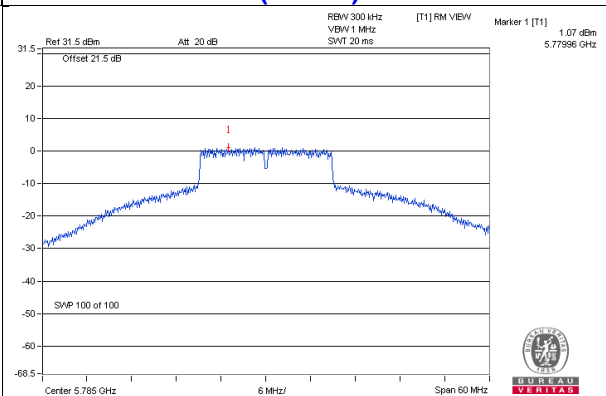

802.11ac (VHT40): CH 159

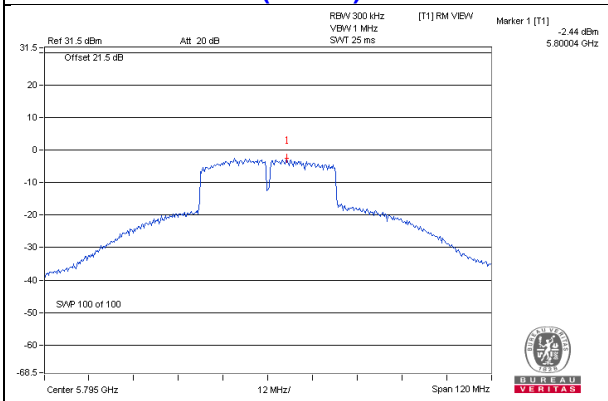

802.11ac (VHT80): CH 155

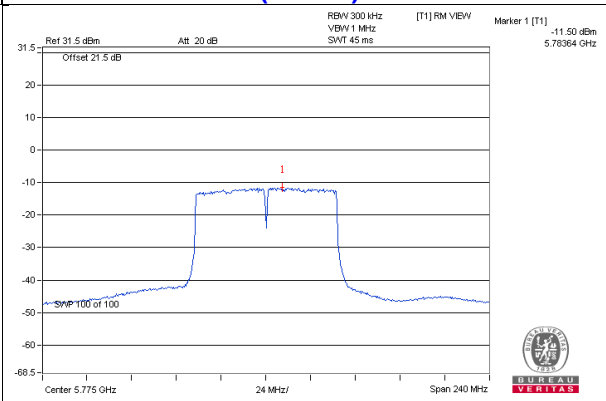

## 4.6 Frequency Stability Measurement

### 4.6.1 Limits of Frequency Stability Measurement

The frequency of the carrier signal shall be maintained within band of operation

### 4.6.2 Test Setup

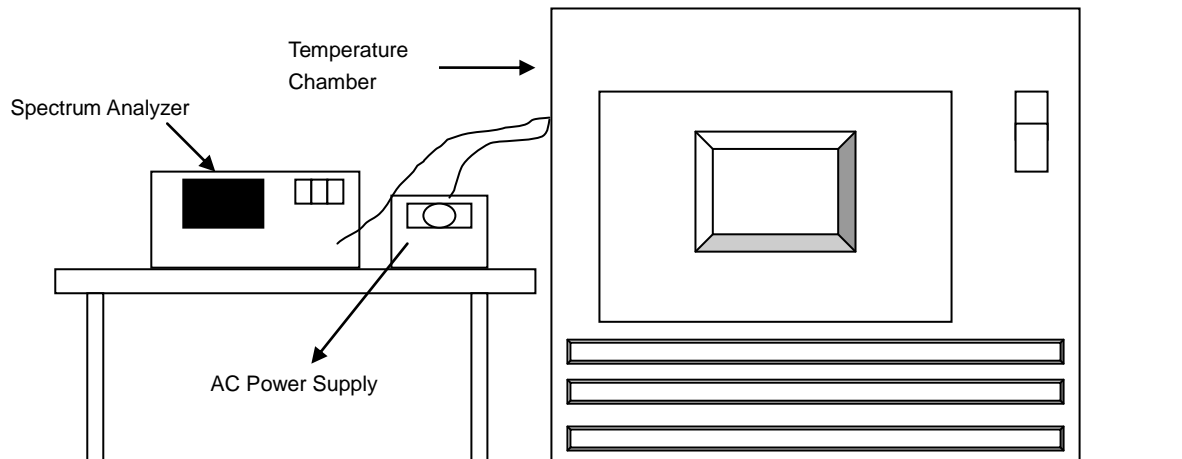

### 4.6.3 Test Instruments

Refer to section 4.1.2 to get information of above instrument.

### 4.6.4 Test Procedure

- The EUT was placed inside the environmental test chamber and powered by nominal AC voltage.
- Turn the EUT on and couple its output to a spectrum analyzer.
- Turn the EUT off and set the chamber to the highest temperature specified.
- Allow sufficient time (approximately 30 min) for the temperature of the chamber to stabilize, turn the EUT on and measure the operating frequency after 2, 5, and 10 Minutes.
- Repeat step 2 and 3 with the temperature chamber set to the lowest temperature.
- The test chamber was allowed to stabilize at +20 degree C for a minimum of 30 Minutes. The supply voltage was then adjusted on the EUT from 85% to 115% and the frequency record.

### 4.6.5 Deviation from Test Standard

No deviation.

### 4.6.6 EUT Operating Condition

Set the EUT transmit at un-modulation mode to test frequency stability.

## 4.6.7 Test Results

Frequency Stability Versus Temp.									
Operating Frequency: 5180 MHz									
TEMP. (°C)	Power Supply (Vac)	0 Minute		2 Minute		5 Minute		10 Minute	
		Measured Frequency (MHz)	Pass/Fail	Measured Frequency (MHz)	Pass/Fail	Measured Frequency (MHz)	Pass/Fail	Measured Frequency (MHz)	Pass/Fail
50	120	5180.0199	PASS	5180.0189	PASS	5180.0187	PASS	5180.0225	PASS
40	120	5180.0057	PASS	5180.0048	PASS	5180.0064	PASS	5180.0044	PASS
30	120	5180.0141	PASS	5180.0108	PASS	5180.0143	PASS	5180.0137	PASS
20	120	5180.0124	PASS	5180.0153	PASS	5180.0117	PASS	5180.0153	PASS
10	120	5180.0114	PASS	5180.011	PASS	5180.0118	PASS	5180.0094	PASS
0	120	5180.0028	PASS	5180.0006	PASS	5180.0029	PASS	5180.0031	PASS
-10	120	5180.0178	PASS	5180.0224	PASS	5180.02	PASS	5180.0199	PASS
-20	120	5179.975	PASS	5179.976	PASS	5179.9763	PASS	5179.9785	PASS
-30	120	5179.994	PASS	5179.9956	PASS	5179.9953	PASS	5179.9916	PASS

Frequency Stability Versus Voltage									
Operating Frequency: 5180 MHz									
TEMP. (°C)	Power Supply (Vac)	0 Minute		2 Minute		5 Minute		10 Minute	
		Measured Frequency (MHz)	Pass/Fail	Measured Frequency (MHz)	Pass/Fail	Measured Frequency (MHz)	Pass/Fail	Measured Frequency (MHz)	Pass/Fail
20	138	5180.0133	PASS	5180.0161	PASS	5180.0119	PASS	5180.0163	PASS
	120	5180.0124	PASS	5180.0153	PASS	5180.0117	PASS	5180.0153	PASS
	102	5180.0125	PASS	5180.0161	PASS	5180.0118	PASS	5180.015	PASS

## 4.7 6dB Bandwidth Measurement

### 4.7.1 Limits of 6dB Bandwidth Measurement

The minimum of 6dB Bandwidth Measurement is 0.5MHz.

### 4.7.2 Test Setup

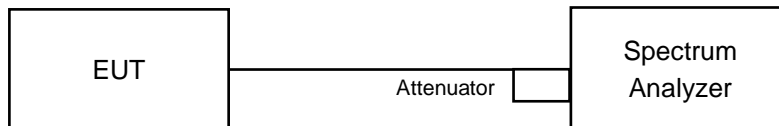

### 4.7.3 Test Instruments

Refer to section 4.1.2 to get information of above instrument.

### 4.7.4 Test Procedure

#### MEASUREMENT PROCEDURE REF

- a. Set resolution bandwidth (RBW) = 100kHz
- b. Set the video bandwidth (VBW)  $\geq 3 \times$  RBW, Detector = Peak.
- c. Trace mode = max hold.
- d. Sweep = auto couple.
- e. Measure the maximum width of the emission that is constrained by the frequencies associated with the two amplitude points (upper and lower) that are attenuated by 6 dB relative to the maximum level measured in the fundamental emission

### 4.7.5 Deviation from Test Standard

No deviation.

### 4.7.6 EUT Operating Condition

The software provided by client to enable the EUT under transmission condition continuously at lowest, middle and highest channel frequencies individually.



#### 4.7.7 Test Results (Mode 1)

##### 802.11a

Channel	Frequency (MHz)	6dB Bandwidth (MHz)			Minimum Limit (MHz)	Pass / Fail
		Chain 0	Chain 1	Chain 2		
149	5745	16.40	16.44	16.39	0.5	PASS
157	5785	16.35	16.41	16.40	0.5	PASS
165	5825	16.41	16.40	16.40	0.5	PASS

##### 802.11ac (VHT20)

Channel	Frequency (MHz)	6dB Bandwidth (MHz)			Minimum Limit (MHz)	Pass / Fail
		Chain 0	Chain 1	Chain 2		
149	5745	17.61	16.40	17.66	0.5	PASS
157	5785	17.64	17.64	17.63	0.5	PASS
165	5825	17.73	17.63	17.63	0.5	PASS

##### 802.11ac (VHT40)

Channel	Frequency (MHz)	6dB Bandwidth (MHz)			Minimum Limit (MHz)	Pass / Fail
		Chain 0	Chain 1	Chain 2		
151	5755	33.97	33.89	33.91	0.5	PASS
159	5795	36.39	35.02	34.54	0.5	PASS

##### 802.11ac (VHT80)

Channel	Frequency (MHz)	6dB Bandwidth (MHz)			Minimum Limit (MHz)	Pass / Fail
		Chain 0	Chain 1	Chain 2		
155	5775	76.41	76.02	75.99	0.5	PASS

### Spectrum Plot of Worst Value

#### 802.11a\_Chain 0 / CH157

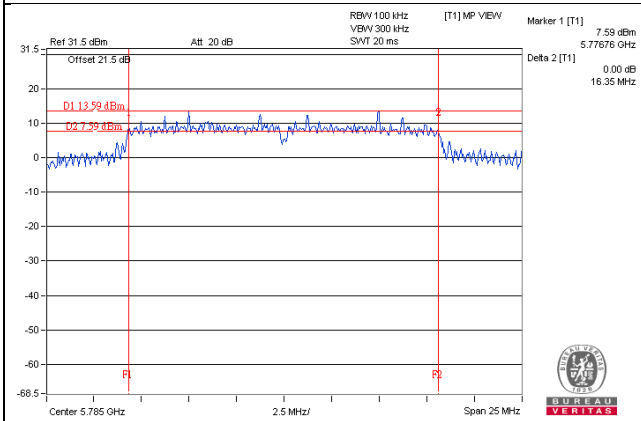

#### 802.11ac (VHT20)\_Chain 1 / CH149

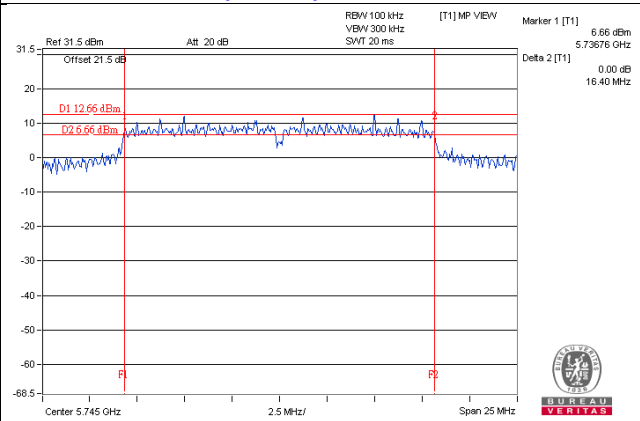

#### 802.11ac (VHT40)\_Chain 1 / CH151

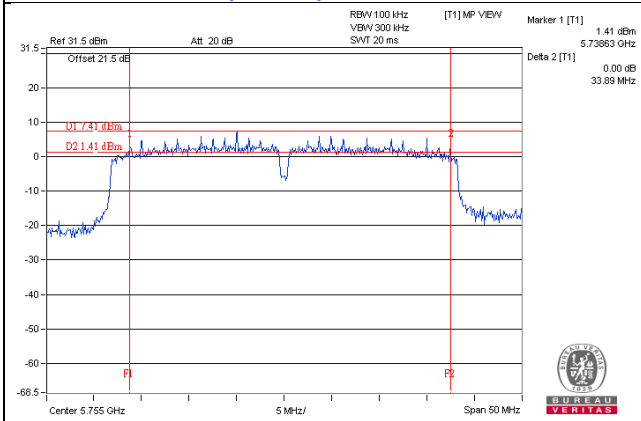

#### 802.11ac (VHT80)\_Chain 2 / CH155

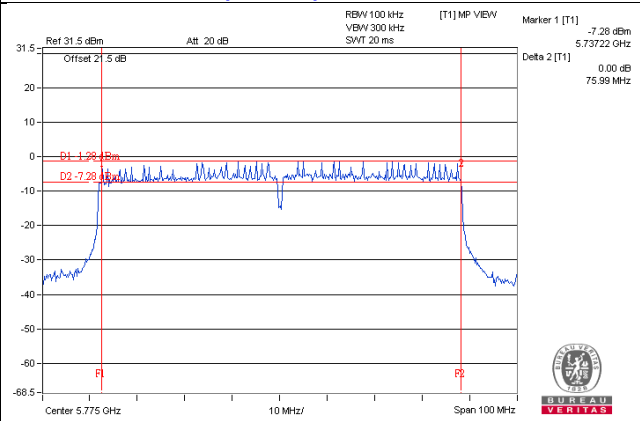

#### 4.7.8 Test Results (Mode 2)

##### 802.11a

Channel	Frequency (MHz)	6dB Bandwidth (MHz)		Minimum Limit (MHz)	Pass / Fail
		Chain 1	Chain 2		
149	5745	16.44	16.39	0.5	PASS
157	5785	16.41	16.40	0.5	PASS
165	5825	16.40	16.40	0.5	PASS

##### 802.11ac (VHT20)

Channel	Frequency (MHz)	6dB Bandwidth (MHz)		Minimum Limit (MHz)	Pass / Fail
		Chain 1	Chain 2		
149	5745	16.40	17.66	0.5	PASS
157	5785	17.64	17.63	0.5	PASS
165	5825	17.63	17.63	0.5	PASS

##### 802.11ac (VHT40)

Channel	Frequency (MHz)	6dB Bandwidth (MHz)		Minimum Limit (MHz)	Pass / Fail
		Chain 1	Chain 2		
151	5755	33.84	35.10	0.5	PASS
159	5795	33.83	33.24	0.5	PASS

##### 802.11ac (VHT80)

Channel	Frequency (MHz)	6dB Bandwidth (MHz)		Minimum Limit (MHz)	Pass / Fail
		Chain 1	Chain 2		
155	5775	75.82	75.96	0.5	PASS

### Spectrum Plot of Worst Value

#### 802.11a\_Chain 2 / CH149

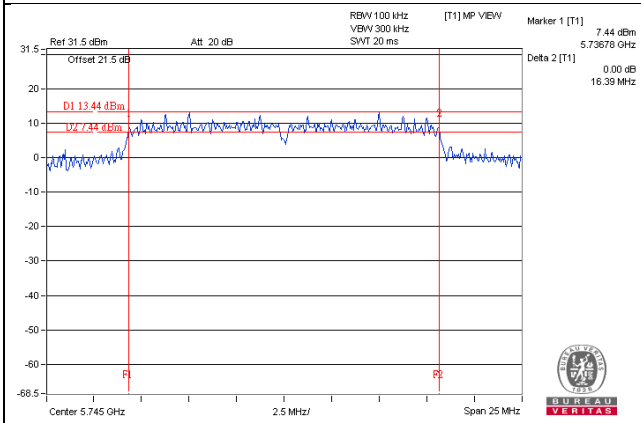

#### 802.11ac (VHT20)\_Chain 1 / CH149

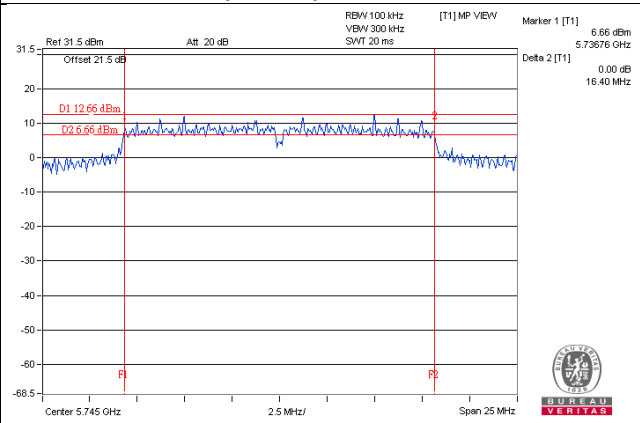

#### 802.11ac (VHT40)\_Chain 2 / CH159

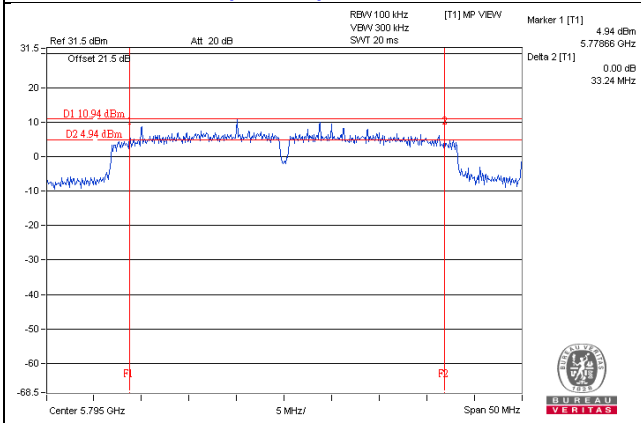

#### 802.11ac (VHT80)\_Chain 1 / CH155

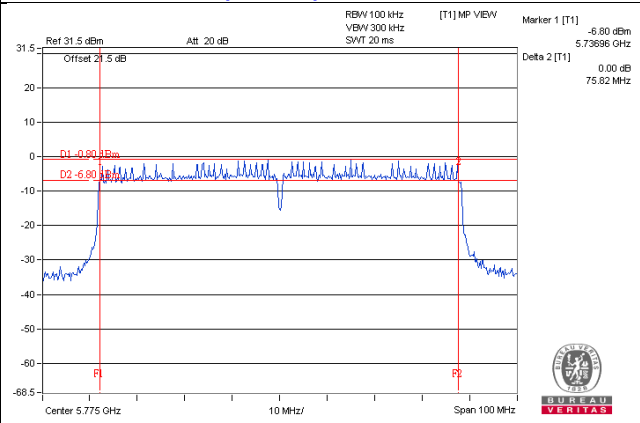

#### 4.7.9 Test Results (Mode 3)

##### 802.11a

Channel	Frequency (MHz)	6dB Bandwidth (MHz)	Minimum Limit (MHz)	Pass / Fail
149	5745	16.39	0.5	PASS
157	5785	16.40	0.5	PASS
165	5825	16.40	0.5	PASS

##### 802.11ac (VHT20)

Channel	Frequency (MHz)	6dB Bandwidth (MHz)	Minimum Limit (MHz)	Pass / Fail
149	5745	17.66	0.5	PASS
157	5785	17.63	0.5	PASS
165	5825	17.63	0.5	PASS

##### 802.11ac (VHT40)

Channel	Frequency (MHz)	6dB Bandwidth (MHz)	Minimum Limit (MHz)	Pass / Fail
151	5755	35.10	0.5	PASS
159	5795	32.66	0.5	PASS

##### 802.11ac (VHT80)

Channel	Frequency (MHz)	6dB Bandwidth (MHz)	Minimum Limit (MHz)	Pass / Fail
155	5775	75.97	0.5	PASS

Spectrum Plot of Worst Value

802.11a / CH149

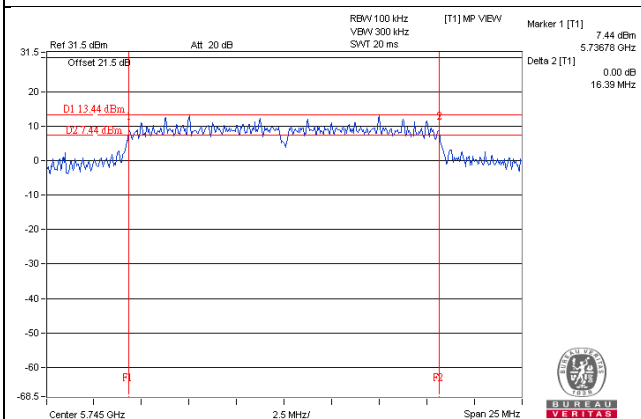

802.11ac (VHT20) / CH157

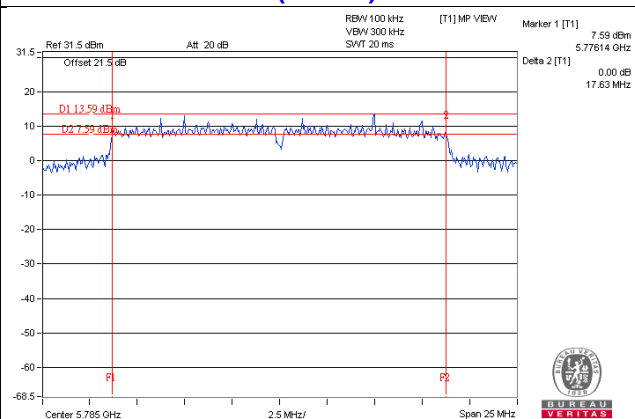

802.11ac (VHT40) / CH159

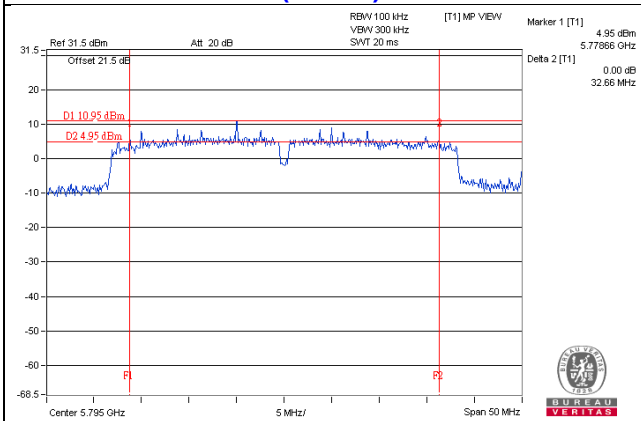

802.11ac (VHT80) / CH155

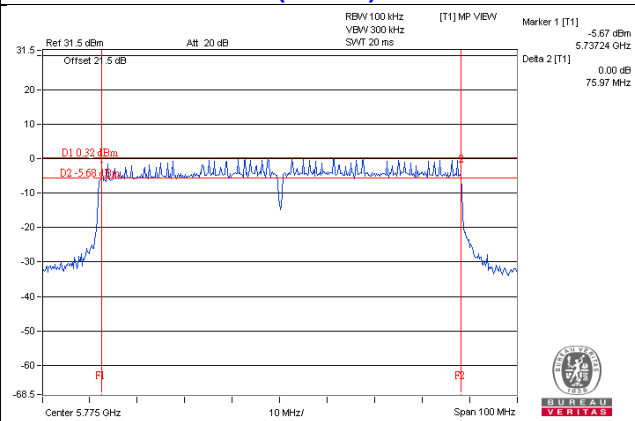

## 5 Pictures of Test Arrangements

Please refer to the attached file (Test Setup Photo).

# Annex A- Radiated Out of Band Emission (OOBE) Measurement (For U-NII-3 band)

3TX Mode

802.11a

**CH 149 5745 MHz**

**Horizontal**

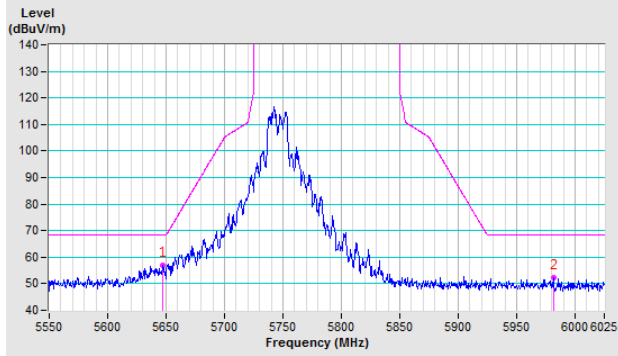

**Vertical**

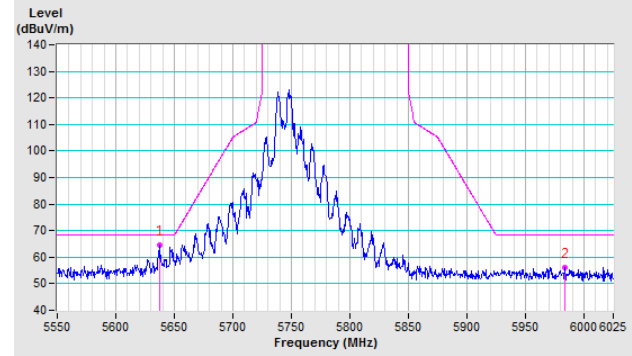

**CH 157 5785 MHz**

**Horizontal**

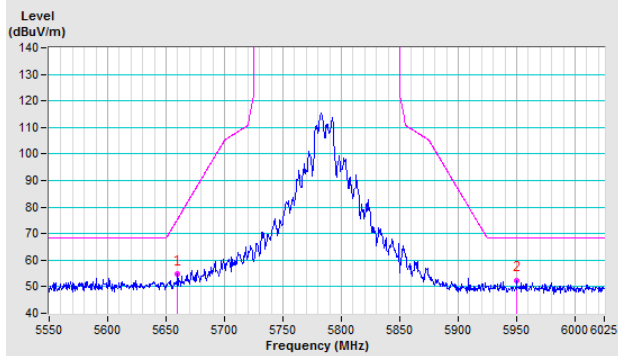

**Vertical**

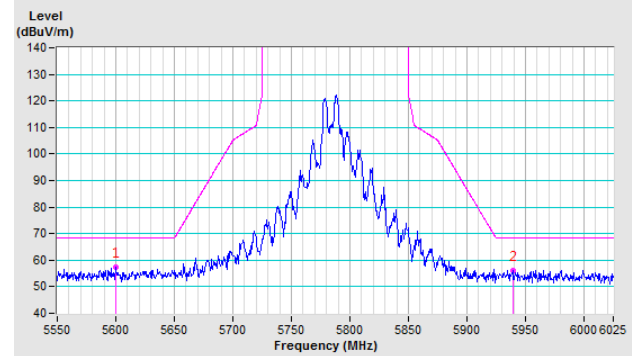

**CH 165 5825 MHz**

**Horizontal**

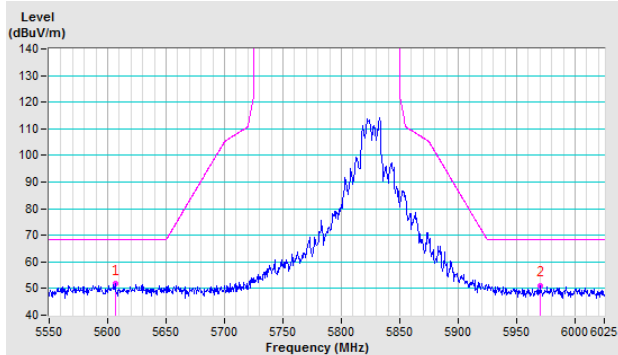

**Vertical**

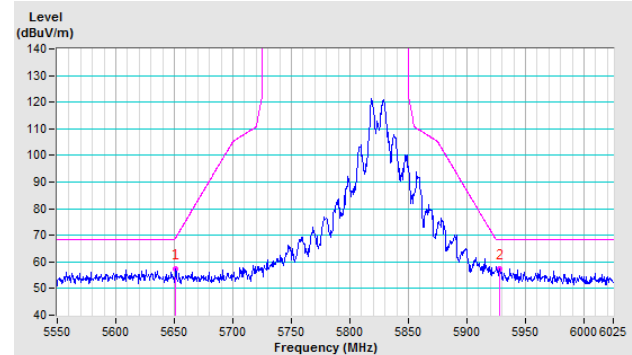



802.11ac (VHT20)

CH 149 5745 MHz

Horizontal

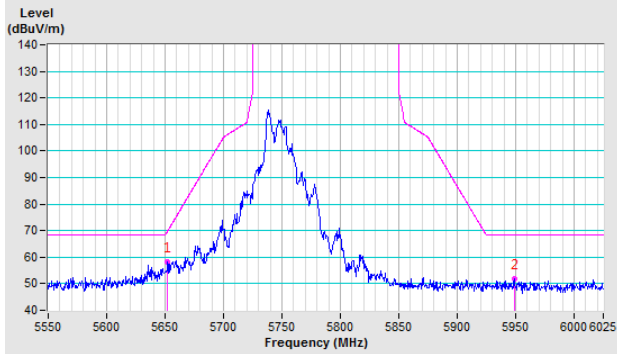

Vertical

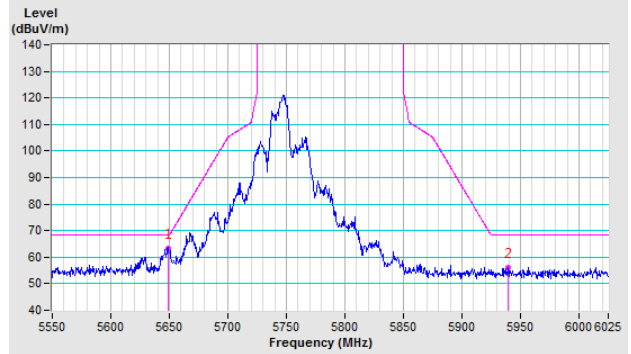

CH 157 5785 MHz

Horizontal

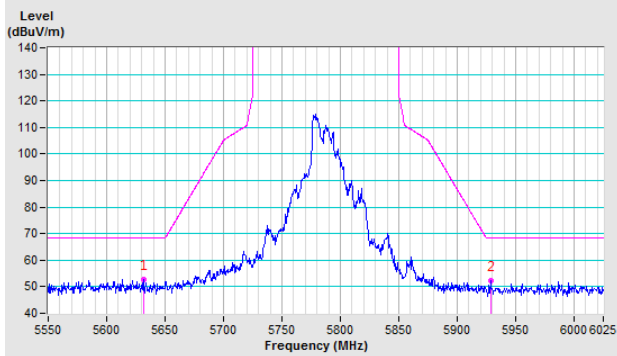

Vertical

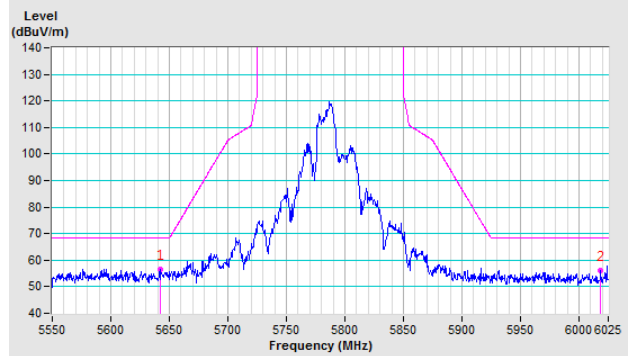

CH 165 5825 MHz

Horizontal

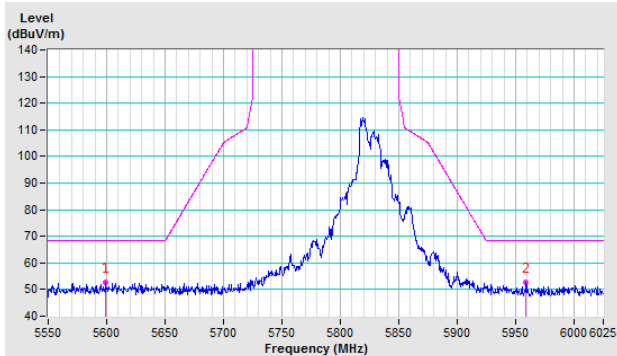

Vertical

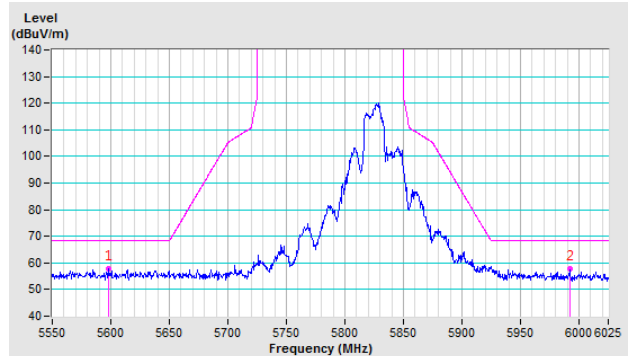

### 802.11ac (VHT40)

**CH 151 5755 MHz**

**Horizontal**

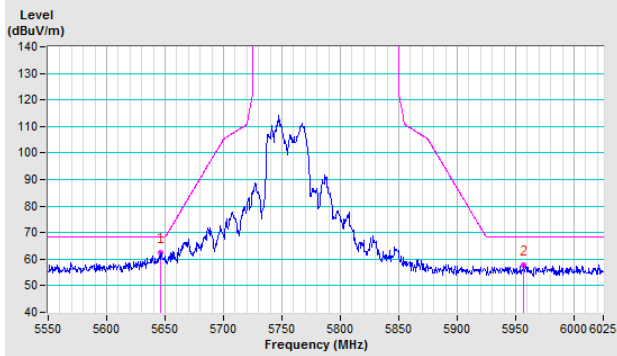

**Vertical**

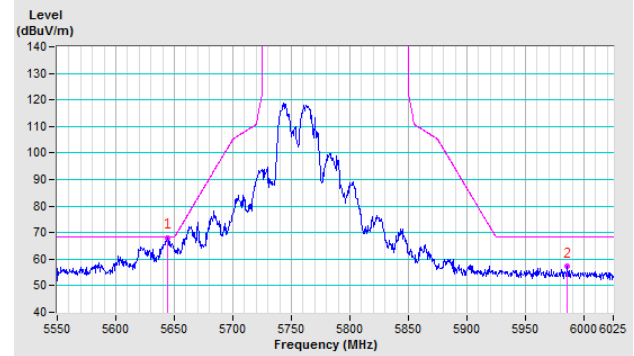

**CH 159 5795 MHz**

**Horizontal**

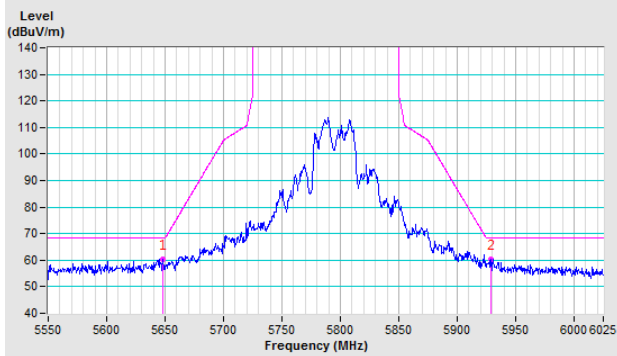

**Vertical**

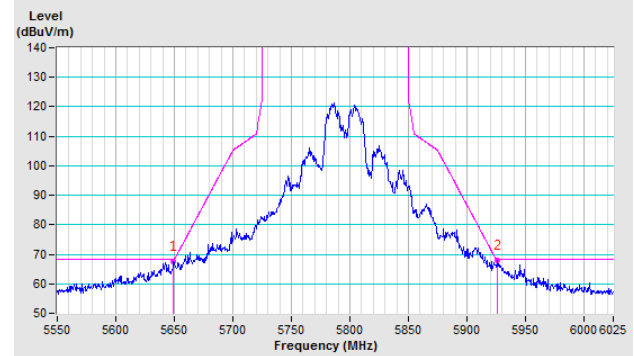

### 802.11ac (VHT80)

**CH 155 5775 MHz**

**Horizontal**

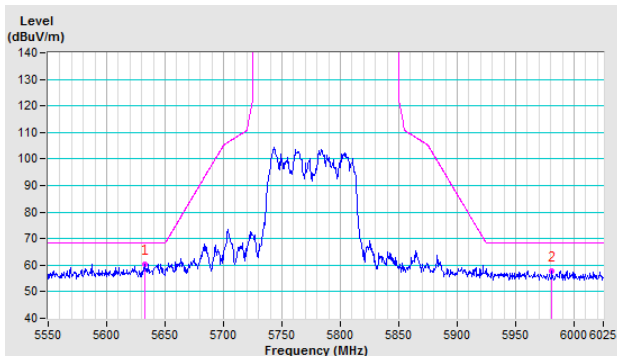

**Vertical**

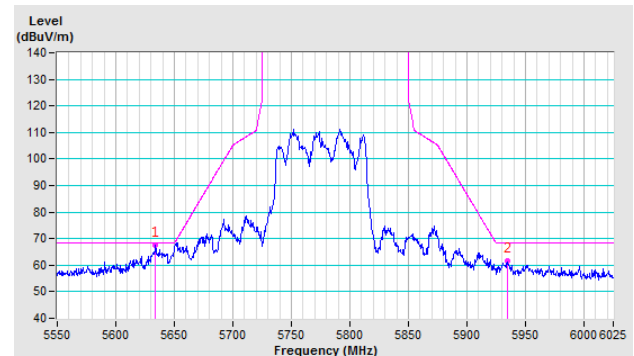

2TX Mode

802.11a

CH 149 5745 MHz

Horizontal

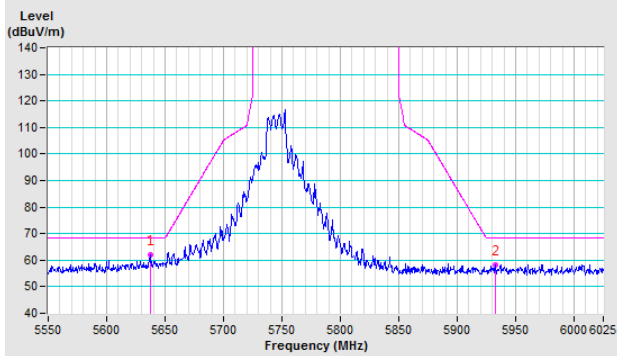

Vertical

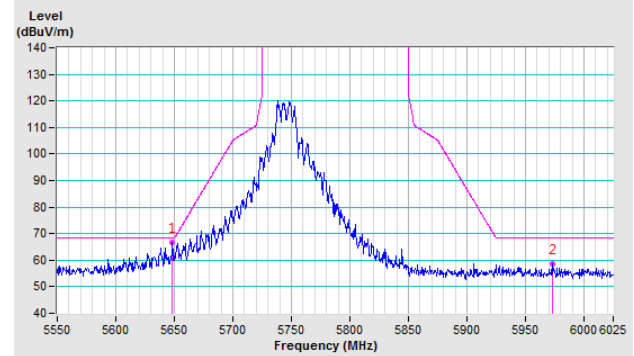

CH 157 5785 MHz

Horizontal

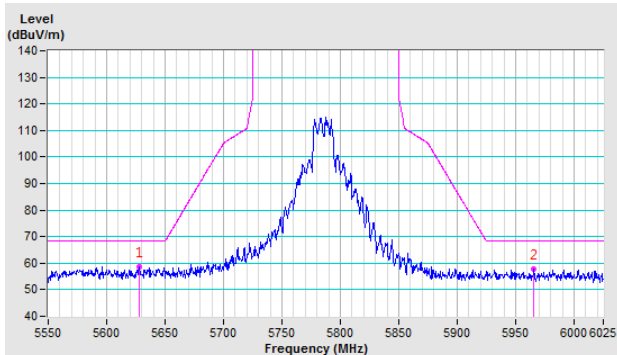

Vertical

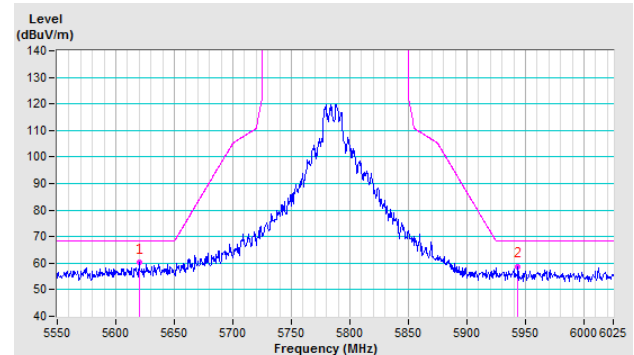

CH 165 5825 MHz

Horizontal

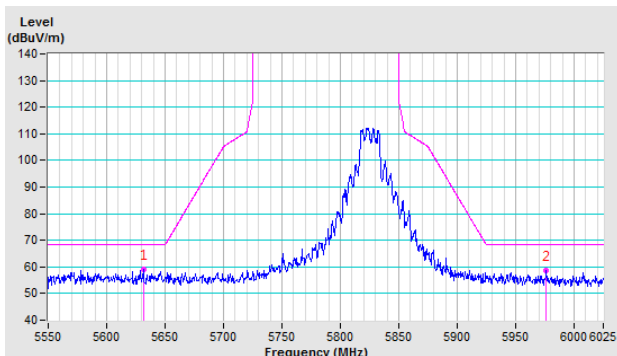

Vertical

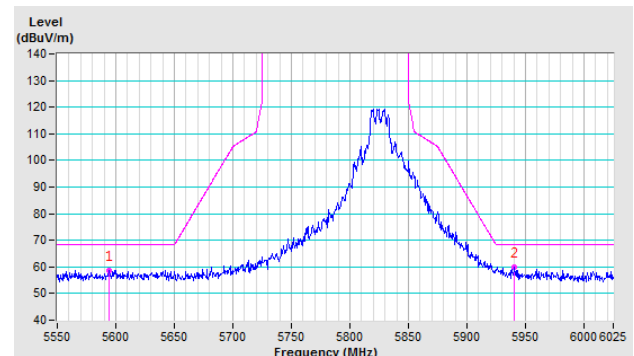

### 802.11ac (VHT20)

#### CH 149 5745 MHz

**Horizontal**

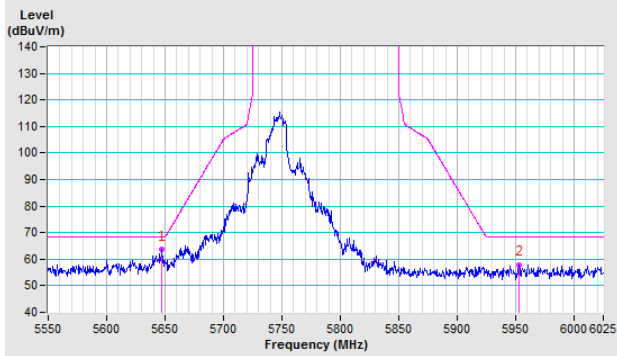

**Vertical**

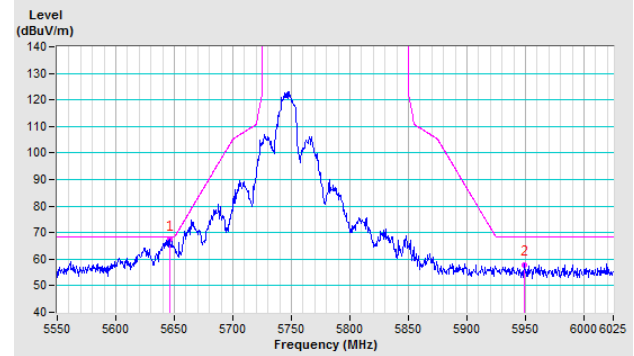

#### CH 157 5785 MHz

**Horizontal**

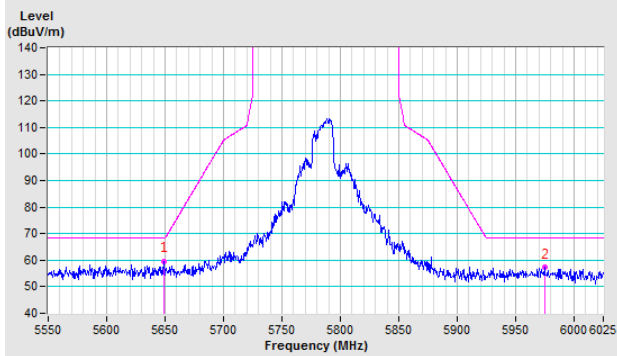

**Vertical**

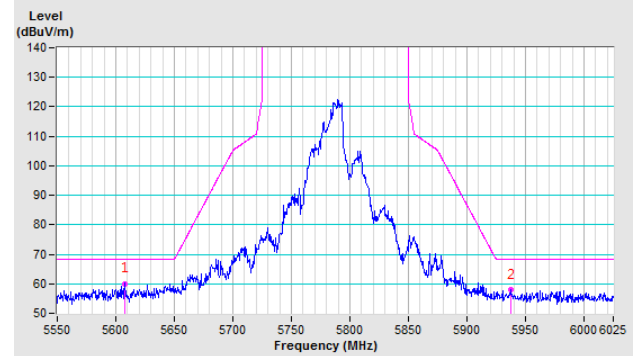

#### CH 165 5825 MHz

**Horizontal**

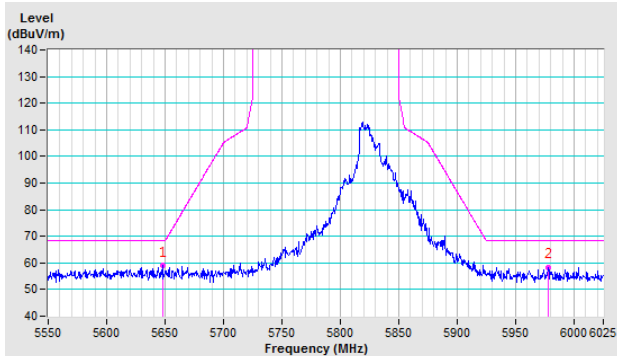

**Vertical**

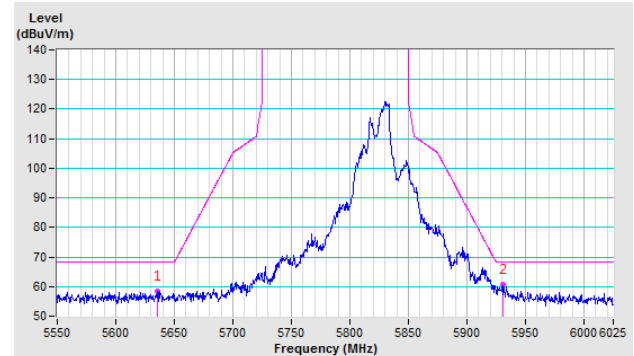

### 802.11ac (VHT40)

CH 151 5755 MHz

Horizontal

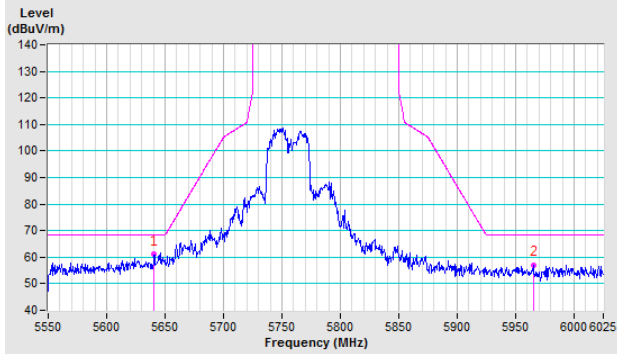

Vertical

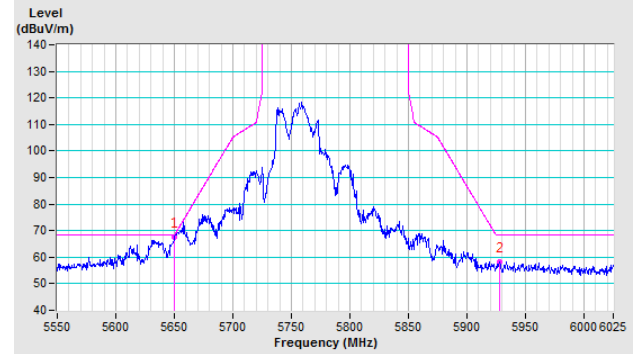

CH 159 5795 MHz

Horizontal

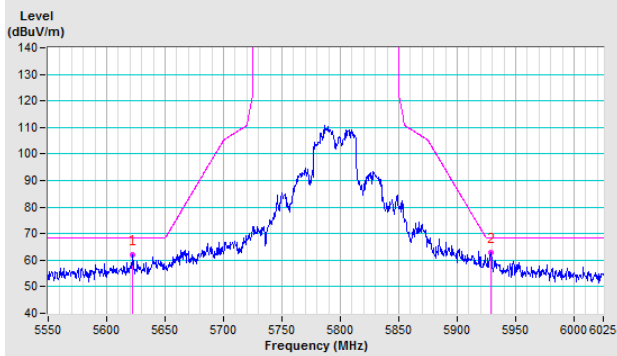

Vertical

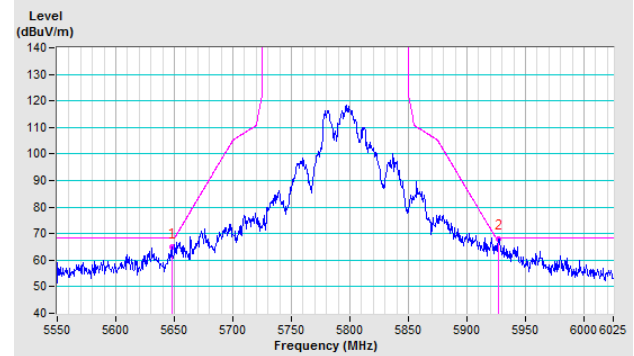

### 802.11ac (VHT80)

CH 155 5775 MHz

Horizontal

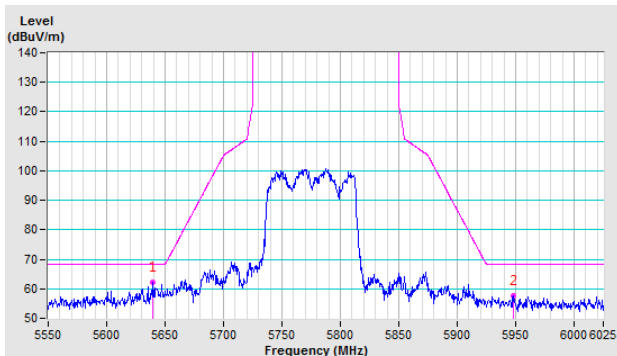

Vertical

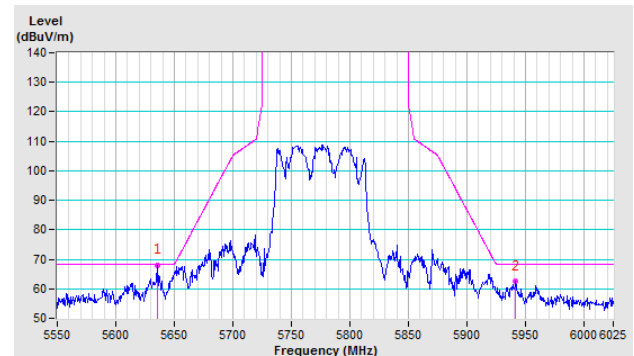

**1TX Mode**

802.11a

**CH 149 5745 MHz**

**Horizontal**

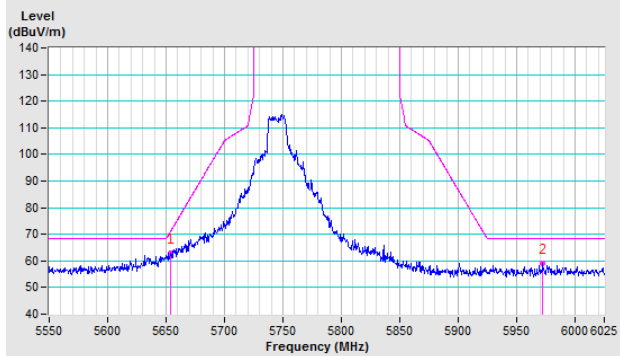

**Vertical**

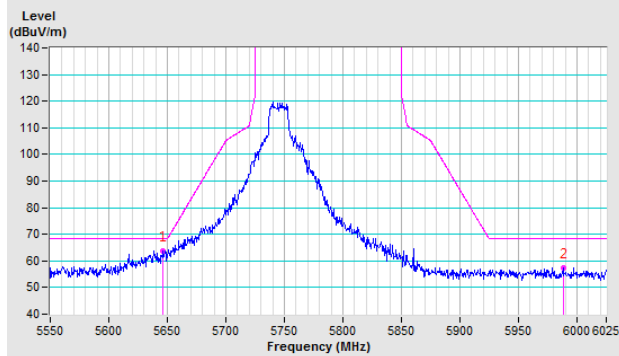

**CH 157 5785 MHz**

**Horizontal**

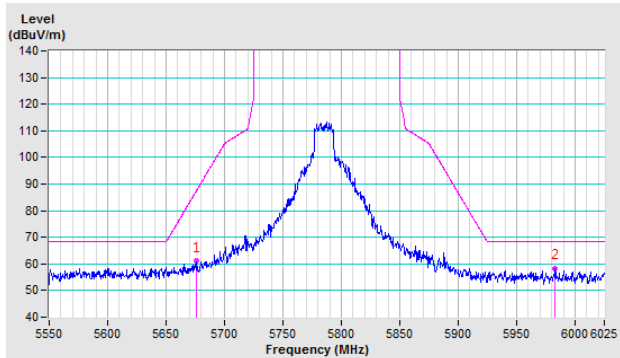

**Vertical**

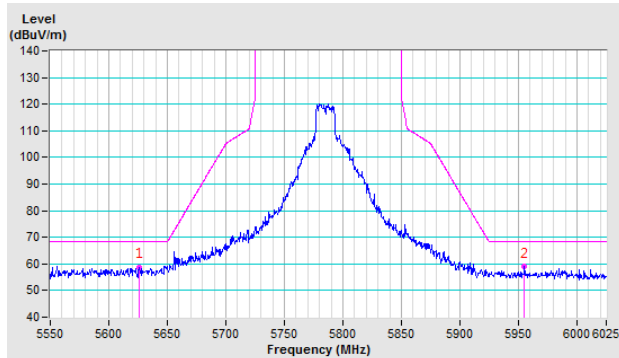

**CH 165 5825 MHz**

**Horizontal**

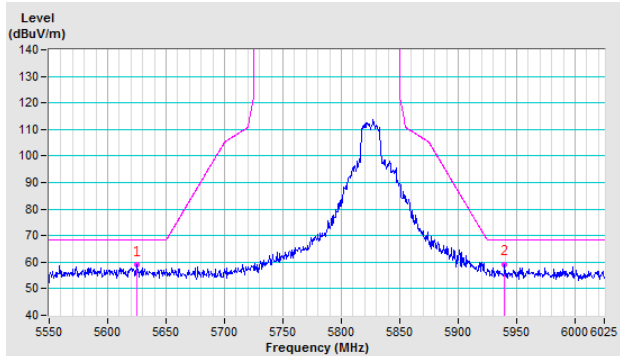

**Vertical**

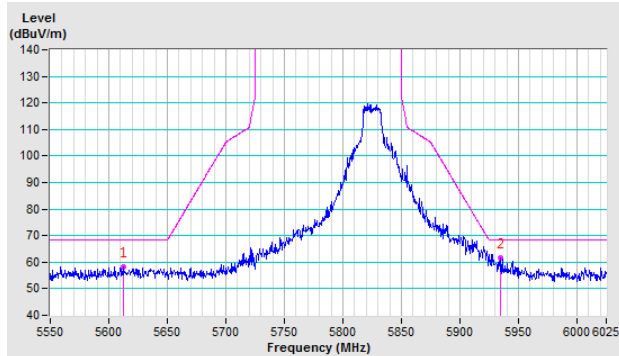

### 802.11ac (VHT20)

**CH 149 5745 MHz**

**Horizontal**

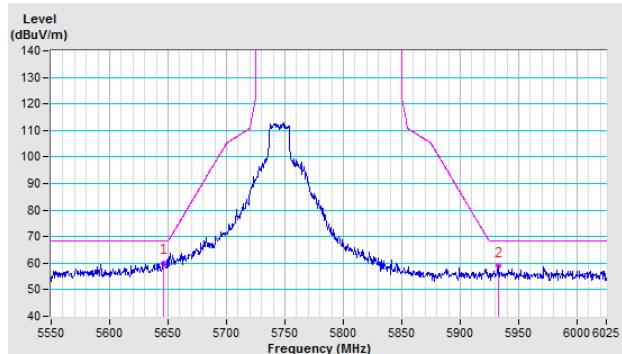

**Vertical**

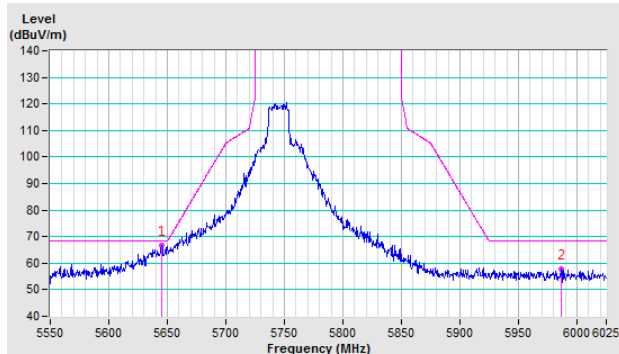

**CH 157 5785 MHz**

**Horizontal**

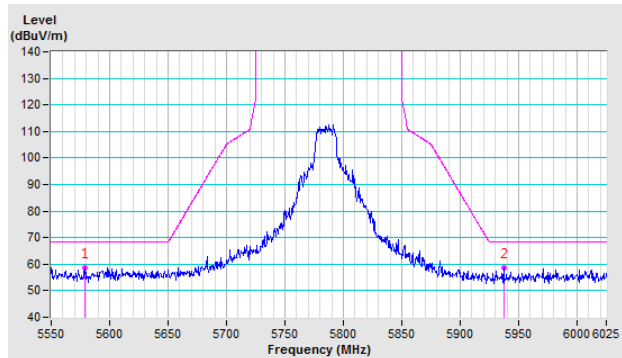

**Vertical**

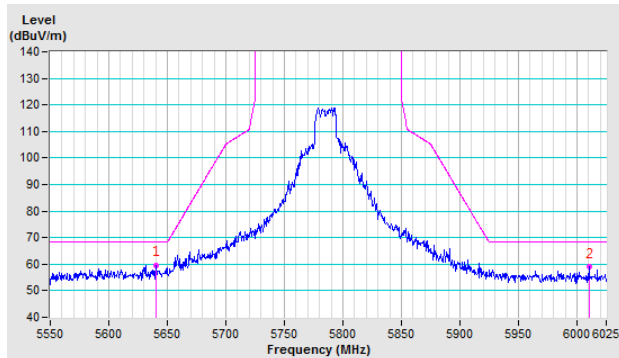

**CH 165 5825 MHz**

**Horizontal**

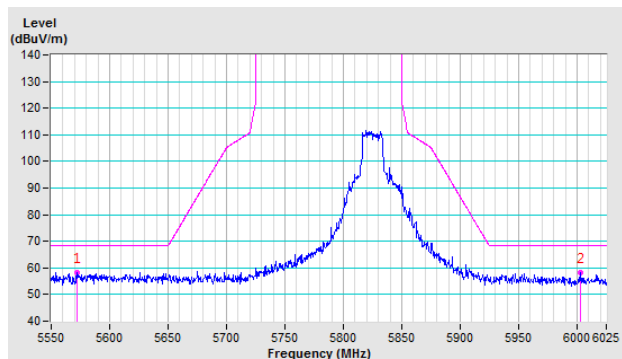

**Vertical**

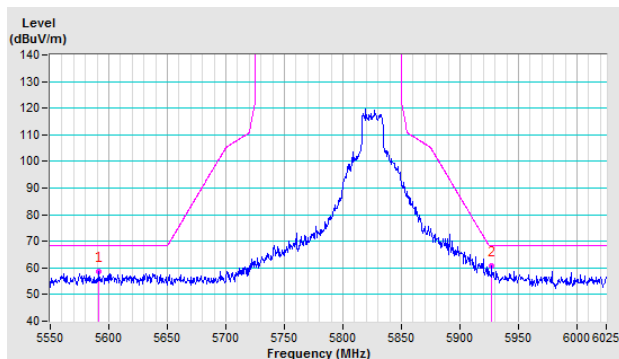

### 802.11ac (VHT40)

CH 151 5755 MHz

Horizontal

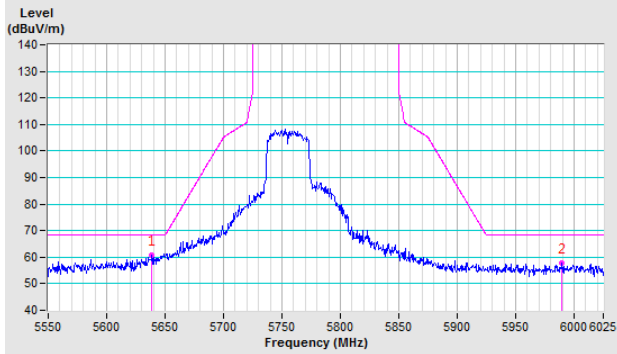

Vertical

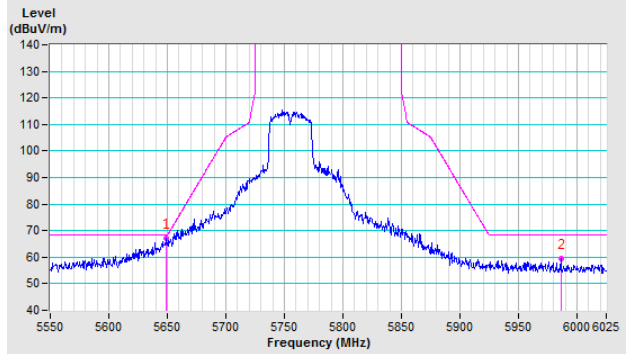

CH 159 5795 MHz

Horizontal

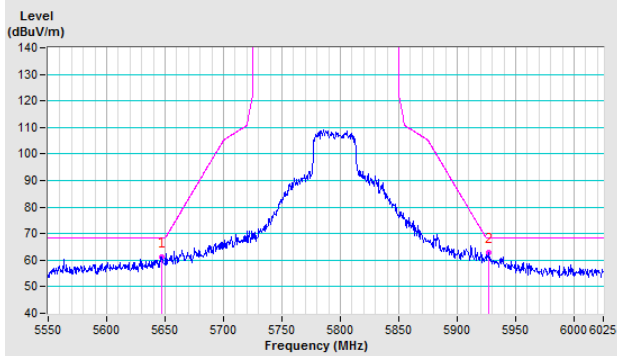

Vertical

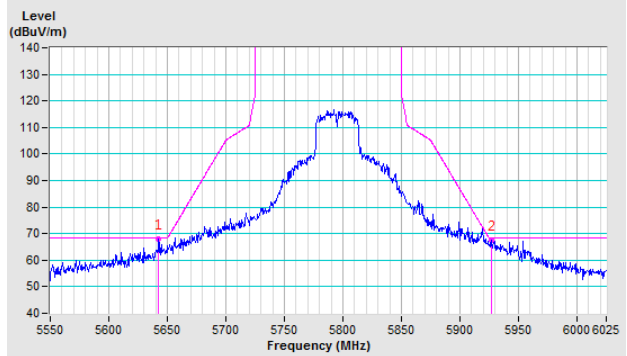

### 802.11ac (VHT80)

CH 155 5775 MHz

Horizontal

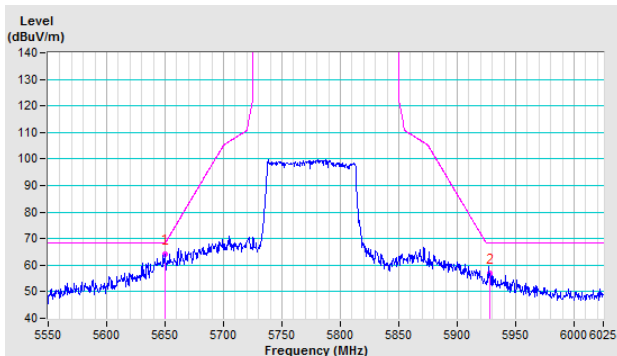

Vertical

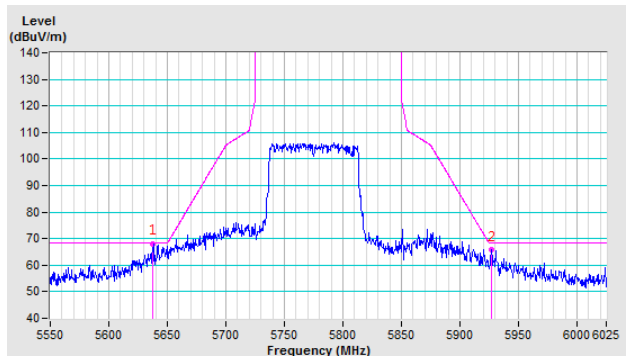



## Appendix – Information on the Testing Laboratories

We, Bureau Veritas Consumer Products Services (H.K.) Ltd., Taoyuan Branch, were founded in 1988 to provide our best service in EMC, Radio, Telecom and Safety consultation. Our laboratories are accredited and approved according to ISO/IEC 17025.

If you have any comments, please feel free to contact us at the following:

**Linko EMC/RF Lab**

Tel: 886-2-26052180

Fax: 886-2-26051924

**Hsin Chu EMC/RF/Telecom Lab**

Tel: 886-3-6668565

Fax: 886-3-6668323

**Hwa Ya EMC/RF/Safety Lab**

Tel: 886-3-3183232

Fax: 886-3-3270892

**Email:** [service.adt@tw.bureauveritas.com](mailto:service.adt@tw.bureauveritas.com)

**Web Site:** [www.bureauveritas-adt.com](http://www.bureauveritas-adt.com)

The address and road map of all our labs can be found in our web site also.

--- END ---