

FCC Test Report

Report No.: RFBDQY-WTW-P21030412B

FCC ID: 2ACTO-APX120

Test Model: APX 120

Received Date: Apr. 22, 2022

Test Date: May 10 ~ Jul. 01, 2022

Issued Date: Oct. 05, 2022

Applicant: Sophos Ltd

Address: The Pentagon, Abingdon Science Park, Abingdon, OX14 3YP, United Kingdom

Issued By: Bureau Veritas Consumer Products Services (H.K.) Ltd., Taoyuan Branch
Lin Kou Laboratories

Lab Address: No. 47-2, 14th Ling, Chia Pau Vil., Lin Kou Dist., New Taipei City, Taiwan

Test Location (1): No. 19, Hwa Ya 2nd Rd., Wen Hwa Vil., Kwei Shan Dist., Taoyuan City
33383, TAIWAN

**FCC Registration /
Designation Number:** 788550 / TW0003

Test Location (2): No. 70, Wenming Rd., Guishan Dist., Taoyuan City 333, Taiwan (R.O.C.)

**FCC Registration /
Designation Number:** 281270 / TW0032



This report is governed by, and incorporates by reference, the Conditions of Testing as posted at the date of issuance of this report at <http://www.bureauveritas.com/home/about-us/our-business/cps/about-us/terms-conditions/> and is intended for your exclusive use. Any copying or replication of this report to or for any other person or entity, or use of our name or trademark, is permitted only with our prior written permission. This report sets forth our findings solely with respect to the test samples identified herein. The results set forth in this report are not indicative or representative of the quality or characteristics of the lot from which a test sample was taken or any similar or identical product unless specifically and expressly noted. Our report includes all of the tests requested by you and the results thereof based upon the information that you provided to us. Measurement uncertainty is only provided upon request for accredited tests. Statements of conformity are based on simple acceptance criteria without taking measurement uncertainty into account, unless otherwise requested in writing. You have 60 days from date of issuance of this report to notify us of any material error or omission caused by our negligence or if you require measurement uncertainty; provided, however, that such notice shall be in writing and shall specifically address the issue you wish to raise. A failure to raise such issue within the prescribed time shall constitute your unqualified acceptance of the completeness of this report, the tests conducted and the correctness of the report contents.

Table of Contents

Release Control Record	3
1 Certificate of Conformity	4
2 Summary of Test Results	5
2.1 Measurement Uncertainty.....	5
2.2 Modification Record.....	5
3 General Information	6
3.1 General Description of EUT.....	6
3.2 Description of Test Modes.....	7
3.2.1 Test Mode Applicability and Tested Channel Detail.....	8
3.3 Description of Support Units.....	9
3.3.1 Configuration of System under Test.....	9
3.4 General Description of Applied Standards and References.....	10
4 Test Types and Results	11
4.1 Radiated Emission and Bandedge Measurement.....	11
4.1.1 Limits of Radiated Emission and Bandedge Measurement.....	11
4.1.2 Test Instruments.....	12
4.1.3 Test Procedures.....	13
4.1.4 Deviation from Test Standard.....	13
4.1.5 Test Setup.....	14
4.1.6 EUT Operating Conditions.....	14
4.1.7 Test Results.....	15
4.2 Conducted Emission Measurement.....	19
4.2.1 Limits of Conducted Emission Measurement.....	19
4.2.2 Test Instruments.....	19
4.2.3 Test Procedures.....	20
4.2.4 Deviation from Test Standard.....	20
4.2.5 Test Setup.....	20
4.2.6 EUT Operating Conditions.....	20
4.2.7 Test Results.....	21
5 Pictures of Test Arrangements	25
Appendix – Information of the Testing Laboratories	26

Release Control Record

Issue No.	Description	Date Issued
RFBDQY-WTW-P21030412B	Original release	Oct. 05, 2022

1 Certificate of Conformity

Product: Sophos Access Point
Brand: Sophos
Test Model: APX 120
Sample Status: Engineering sample
Applicant: Sophos Ltd
Test Date: May 10 ~ Jul. 01, 2022
Standards: 47 CFR FCC Part 15, Subpart C (Section 15.247)
ANSI C63.10:2013

This report is issued as a supplementary report of RF180717C32. This report shall be used combined together with its original report.

Prepared by : Celine Chou , **Date:** Oct. 05, 2022
Celine Chou / Senior Specialist

Approved by : Jeremy Lin , **Date:** Oct. 05, 2022
Jeremy Lin / Project Engineer

Note: Radiated emission below 1GHz and conducted emission are performed for the addendum. Refer to original report for the other test data.

2 Summary of Test Results

47 CFR FCC Part 15, Subpart C (Section 15.247)			
FCC Clause	Test Item	Result	Remarks
15.207	AC Power Conducted Emission	Pass	Meet the requirement of limit. Minimum passing margin is -13.03dB at 22.97658MHz.
15.205 / 15.209 / 15.247(d)	Radiated Emissions and Band Edge Measurement	Pass	Meet the requirement of limit. Minimum passing margin is -5.5dB at 38.43MHz.
15.247(d)	Antenna Port Emission	N/A	Refer to Note 1
15.247(a)(2)	6dB bandwidth	N/A	Refer to Note 1
15.247(b)	Conducted power	N/A	Refer to Note 1
15.247(e)	Power Spectral Density	N/A	Refer to Note 1
15.203	Antenna Requirement	Pass	Antenna connector are IPEX not a standard connector.

Note:

1. Radiated emission below 1GHz and conducted emission are performed for the addendum. Refer to original report for the other test data.
2. Determining compliance based on the results of the compliance measurement, not taking into account measurement instrumentation uncertainty.

2.1 Measurement Uncertainty

Where relevant, the following measurement uncertainty levels have been estimated for tests performed on the EUT as specified in CISPR 16-4-2:

Measurement	Frequency	Expanded Uncertainty (k=2) (±)
Conducted Emissions at mains ports	150kHz ~ 30MHz	2.79 dB
Radiated Emissions up to 1 GHz	9kHz ~ 30MHz	3.00 dB
	30MHz ~ 200MHz	2.91 dB
	200MHz ~ 1000MHz	2.93 dB

2.2 Modification Record

There were no modifications required for compliance.

3 General Information

3.1 General Description of EUT

Product	Sophos Access Point
Brand	Sophos
Test Model	APX 120
Sample Status	Engineering sample
Power Supply Rating	12Vdc from adapter 55Vdc from POE
Modulation Type	CCK, DQPSK, DBPSK for DSSS 64QAM, 16QAM, QPSK, BPSK for OFDM
Modulation Technology	DSSS, OFDM
Transfer Rate	802.11b: 11/5.5/2/1Mbps 802.11g: 54/48/36/24/18/12/9/6Mbps 802.11n: up to 300Mbps
Operating Frequency	2412 ~ 2462MHz
Number of Channel	802.11b, 802.11g, 802.11n (HT20): 11 802.11n (HT40): 7
Output Power	CDD Mode: 329.280mW Beamforming Mode: 327.122mW
Antenna Type	Refer to note
Antenna Connector	Refer to note
Accessory Device	Adapter
Cable Supplied	N/A

Note:

1. This report is prepared for FCC class II permissive change. The difference compared with the original report (BV CPS report no.: RF180717C32) are removing TPM IC and changing software, these changes don't affect the RF characteristics. Therefore, radiated emission below 1GHz and conducted emission are performed for the addendum. Refer to original report for the other test data.
2. The EUT incorporates a MIMO function. Physically, the EUT provides 2 completed transmitters and 2 receivers.

Modulation Mode	Beamforming Mode	TX Function
802.11b	Not Support	2TX
802.11g	Not Support	2TX
802.11n (HT20)	Support	2TX
802.11n (HT40)	Support	2TX

3. The EUT consumes power from the following adapter and POE.

Adapter	
Brand	Asian Power Devices Inc.
Model	WA-12M12R
Input Power	100-240Vac, 50-60Hz, 0.5A Max.
Output Power	12Vdc, 1A
Power Line	1.5m power cable without core attached on adapter

POE (Support unit only)	
Brand	Power Desine
Model	PD-9001GR/AC
Input Power	100-240Vac, 50-60Hz, 0.67A
Output Power	55Vdc, 0.6A

4. The following antennas were provided to the EUT.

No.	Brand	Model	Type	Connector	Gain (dBi)	
					2.4G	5G
1	LYNwave	ALX18P-222AA3-00	PCB	IPEX	3.7	3.6
2	LYNwave	ALX18P-222AA3-01	PCB	IPEX	3.7	4.2

* Detail antenna specification please refer to antenna datasheet and/or antenna measurement report.

3.2 Description of Test Modes

11 channels are provided for 802.11b, 802.11g and 802.11n (HT20):

Channel	Frequency	Channel	Frequency
1	2412MHz	7	2442MHz
2	2417MHz	8	2447MHz
3	2422MHz	9	2452MHz
4	2427MHz	10	2457MHz
5	2432MHz	11	2462MHz
6	2437MHz		

7 channels are provided for 802.11n (HT40):

Channel	Frequency	Channel	Frequency
3	2422MHz	7	2442MHz
4	2427MHz	8	2447MHz
5	2432MHz	9	2452MHz
6	2437MHz		

3.2.1 Test Mode Applicability and Tested Channel Detail

EUT Configure Mode	Applicable to		Description
	RE<1G	PLC	
A	√	√	Powered by adapter
B	√	√	Powered by POE

Where RE \geq 1G: Radiated Emission above 1GHz & Bandedge Measurement
 RE<1G: Radiated Emission below 1GHz
 PLC: Power Line Conducted Emission
 APCM: Antenna Port Conducted Measurement

Note:

1. The EUT had been pre-tested on the positioned of each 3 axis. The worst case was found when positioned on **X-plane**.
2. Radiated emission test (below 1GHz) and power line conducted emission test items chosen the worst maximum power according to original test report.

Radiated Emission Test (Below 1GHz):

- Pre-Scan has been conducted to determine the worst-case mode from all possible combinations between available modulations, data rates and antenna ports (if EUT with antenna diversity architecture).
- Following channel(s) was (were) selected for the final test as listed below.

EUT Configure Mode	Mode	Available Channel	Tested Channel	Modulation Technology	Modulation Type	Data Rate (Mbps)
A, B	802.11g	1 to 11	6	OFDM	BPSK	6.0

Power Line Conducted Emission Test:

- Pre-Scan has been conducted to determine the worst-case mode from all possible combinations between available modulations, data rates and antenna ports (if EUT with antenna diversity architecture).
- Following channel(s) was (were) selected for the final test as listed below.

EUT Configure Mode	Mode	Available Channel	Tested Channel	Modulation Technology	Modulation Type	Data Rate (Mbps)
A, B	802.11g	1 to 11	6	OFDM	BPSK	6.0

Test Condition:

Applicable to	Environmental Conditions	Input Power	Tested by
RE<1G	23 deg. C, 69% RH	120Vac, 60Hz 55Vdc	Greg Lin Noah Chang
PLC	23 deg. C, 71% RH	120Vac, 60Hz 55Vdc	Greg Lin

3.3 Description of Support Units

The EUT has been tested as an independent unit together with other necessary accessories or support units. The following support units or accessories were used to form a representative test configuration during the tests.

ID	Product	Brand	Model No.	Serial No.	FCC ID	Remarks
A.	Notebook	DELL	E5420	33MJMQ1	FCC DoC Approved	-
B.	POE	Power Desine	PD-9001GR/AC	NA	NA	Provided by client

Note:

1. All power cords of the above support units are non-shielded (1.8m).
2. Item A acted as a communication partner to transfer data.

ID	Descriptions	Qty.	Length (m)	Shielding (Yes/No)	Cores (Qty.)	Remarks
1.	RJ45, Cat5e	1	3	N	0	-
2.	RJ45, Cat5e	1	1.8	N	0	-

3.3.1 Configuration of System under Test

Test Mode A

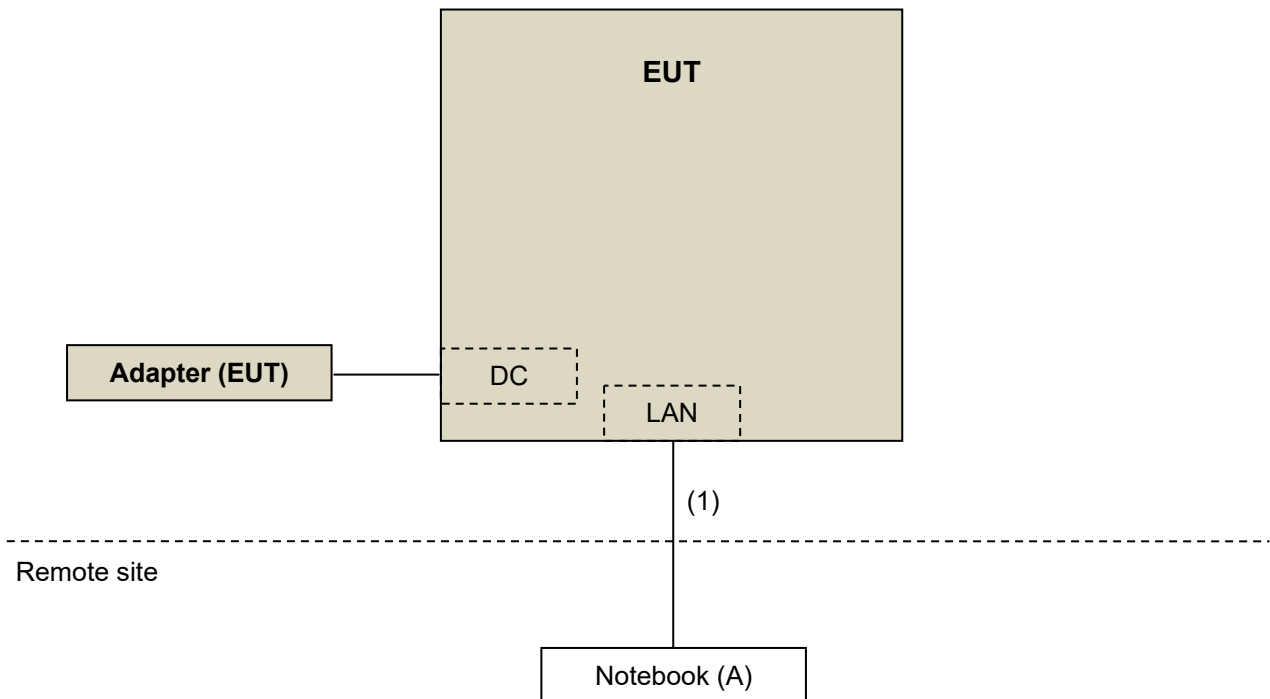

Test Mode B

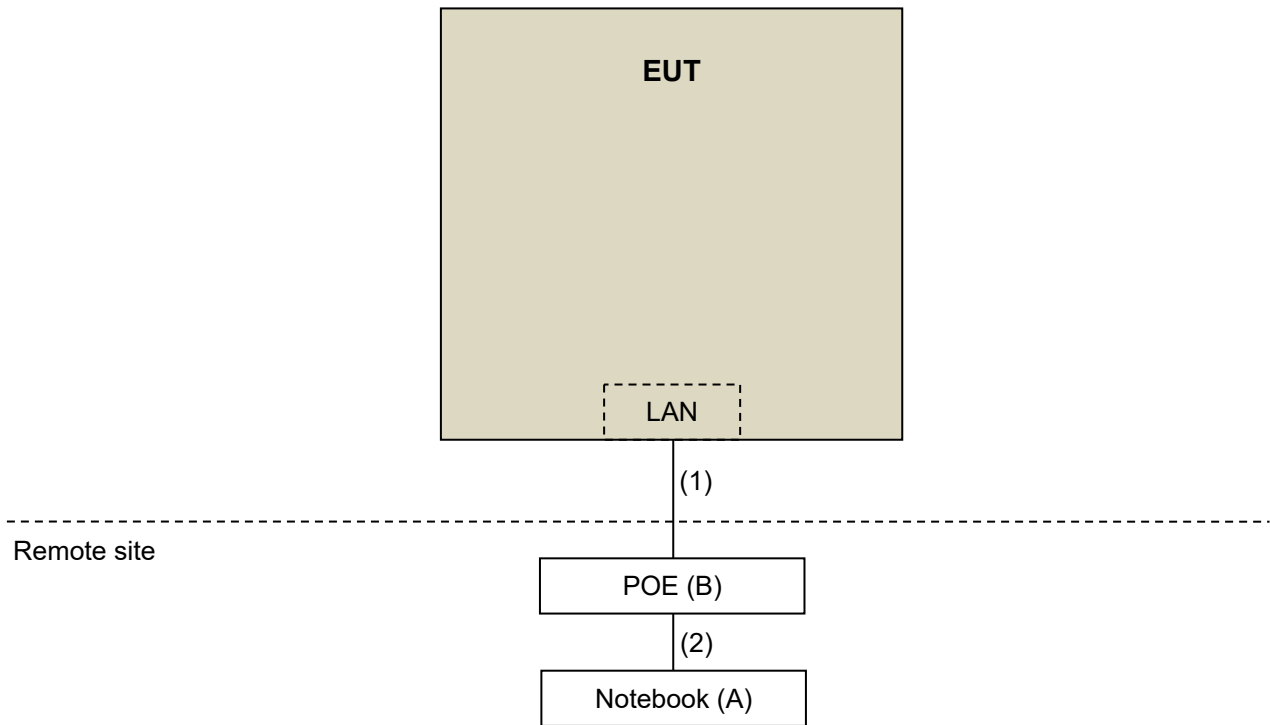

3.4 General Description of Applied Standards and References

The EUT is a RF Product. According to the specifications of the manufacturer, it must comply with the requirements of the following standards and references:

Test standard:

FCC Part 15, Subpart C (15.247)

ANSI C63.10:2013

All test items have been performed and recorded as per the above standards.

References Test Guidance:

KDB 558074 D01 15.247 Meas Guidance v05r02

KDB 662911 D01 Multiple Transmitter Output v02r01

All test items have been performed as a reference to the above KDB test guidance.

4 Test Types and Results

4.1 Radiated Emission and Bandedge Measurement

4.1.1 Limits of Radiated Emission and Bandedge Measurement

Radiated emissions which fall in the restricted bands must comply with the radiated emission limits specified as below table. Other emissions shall be at least 30dB below the highest level of the desired power:

Frequencies (MHz)	Field Strength (microvolts/meter)	Measurement Distance (meters)
0.009 ~ 0.490	2400/F(kHz)	300
0.490 ~ 1.705	24000/F(kHz)	30
1.705 ~ 30.0	30	30
30 ~ 88	100	3
88 ~ 216	150	3
216 ~ 960	200	3
Above 960	500	3

Note:

1. The lower limit shall apply at the transition frequencies.
2. Emission level (dBuV/m) = 20 log Emission level (uV/m).
3. For frequencies above 1000MHz, the field strength limits are based on average detector, however, the peak field strength of any emission shall not exceed the maximum permitted average limits, specified above by more than 20dB under any condition of modulation.

4.1.2 Test Instruments

Description & Manufacturer	Model No.	Serial No.	Cal. Date	Cal. Due
Test Receiver ROHDE & SCHWARZ	ESR3	102782	Dec. 10, 2021	Dec. 09, 2022
Spectrum Analyzer ROHDE & SCHWARZ	FSW43	101582	Apr. 13, 2022	Apr. 12, 2023
BILOG Antenna SCHWARZBECK	VULB9168	9168-1213	Oct. 27, 2021	Oct. 26, 2022
HORN Antenna RF SPIN	DRH18-E	210103A18E	Nov. 14, 2021	Nov. 13, 2022
HORN Antenna SCHWARZBECK	BBHA 9170	9170-1048	Nov. 14, 2021	Nov. 13, 2022
Loop Antenna TESEQ	HLA 6121	45745	Jul. 21, 2021	Jul. 20, 2022
Preamplifier EMCI (Below 1GHz)	EMC330N	980782	Jan. 17, 2022	Jan. 16, 2023
Preamplifier EMCI (Above 1GHz)	EMC118A45SE	980808	Dec. 30, 2021	Dec. 29, 2022
Preamplifier EMCI (18GHz~40GHz)	EMC184045SE	980788	Jan. 17, 2022	Jan. 16, 2023
RF signal cable EMCI	EMC104-SM-SM-(9 000+2000+1000)	201243+ 201231+ 210102	Jan. 17, 2022	Jan. 16, 2023
RF signal cable EMCI	EMCCFD400-NM-N M-(9000+300+500)	201236+ 201235+ 201233	Jan. 17, 2022	Jan. 16, 2023
RF signal cable EMCI	EMC101G-KM-KM- (5000+3000+2000)	201260+201257+20125 4	Jan. 17, 2022	Jan. 16, 2023
Software BV ADT	ADT_Radiated_ V7.6.15.9.5	NA	NA	NA
Antenna Tower & Turn Max-Full	MFT-151SS-0.5T	NA	NA	NA
Turn Table Max-Full	MF-7802BS	NA	NA	NA
Turn Table Controller Max-Full	MF-7802BS	MF780208674	NA	NA
Turn Table Controller Max-Full	MF-7802BS	MF780208674	NA	NA
Peak Power Analyzer KEYSIGHT	8990B	MY51000485	Jan. 18, 2022	Jan. 17, 2023
Wideband Power Sensor KEYSIGHT	N1923A	MY58020002	Jan. 17, 2022	Jan. 16, 2023

- Note: 1. The calibration interval of the above test instruments is 12 months and the calibrations are traceable to NML/ROC and NIST/USA.
 2. The test was performed in WM Chamber 8.

4.1.3 Test Procedures

For Radiated emission below 30MHz

- a. The EUT was placed on the top of a rotating table 0.8 meters above the ground at a 3 meter chamber room. The table was rotated 360 degrees to determine the position of the highest radiation.
- b. The EUT was set 3 meters away from the interference-receiving antenna, which was mounted on the top of a variable-height antenna tower.
- c. Parallel, perpendicular, and ground-parallel orientations of the antenna are set to make the measurement.
- d. For each suspected emission, the EUT was arranged to its worst case and the rotatable table was turned from 0 degrees to 360 degrees to find the maximum reading.
- e. The test-receiver system was set to Quasi-Peak Detect Function and Specified Bandwidth with Maximum Hold Mode.

Note:

1. The resolution bandwidth and video bandwidth of test receiver/spectrum analyzer is 9kHz at frequency below 30MHz.

For Radiated emission above 30MHz

- a. The EUT was placed on the top of a rotating table 0.8 meters above the ground at 3 meter chamber room for test. The table was rotated 360 degrees to determine the position of the highest radiation.
- b. The EUT was set 3 meters away from the interference-receiving antenna, which was mounted on the top of a variable-height antenna tower.
- c. The height of antenna is varied from one meter to four meters above the ground to determine the maximum value of the field strength. Both horizontal and vertical polarizations of the antenna are set to make the measurement.
- d. For each suspected emission, the EUT was arranged to its worst case and then the antenna was tuned to heights from 1 meter to 4 meters and the rotatable table was turned from 0 degrees to 360 degrees to find the maximum reading.
- e. The test-receiver system was set to quasi-peak detect function and specified bandwidth with maximum hold mode when the test frequency is below 1 GHz.

Note:

1. The resolution bandwidth and video bandwidth of test receiver/spectrum analyzer is 120kHz for Quasi-peak detection (QP) at frequency below 1GHz.
2. All modes of operation were investigated and the worst-case emissions are reported.

4.1.4 Deviation from Test Standard

No deviation.

4.1.5 Test Setup

For Radiated emission below 30MHz

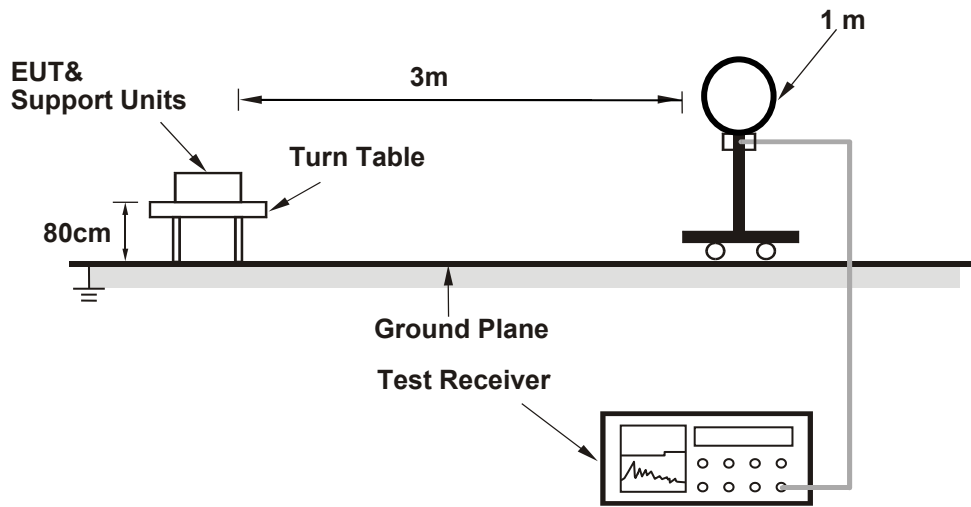

For Radiated emission 30MHz to 1GHz

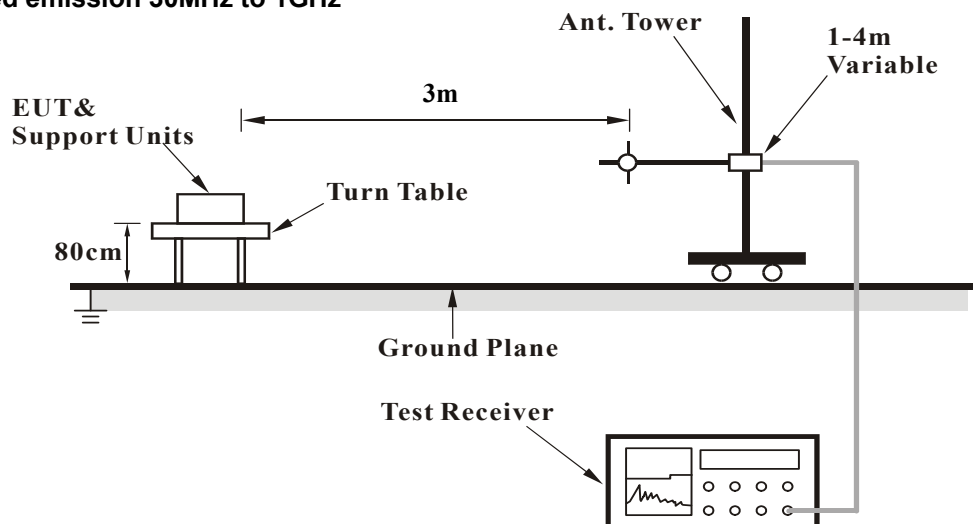

For the actual test configuration, please refer to the attached file (Test Setup Photo).

4.1.6 EUT Operating Conditions

- Placed the EUT on the testing table.
- Prepared a notebook to act as a communication partner and placed it outside of testing area.
- The communication partner connected with EUT via a RJ45 cable and ran a test program (provided by manufacturer) to enable EUT under transmission condition continuously at specific channel frequency.
- The communication partner sent data to EUT by command "PING".

4.1.7 Test Results

Below 1GHz worst-case data:

RF Mode	TX 802.11g	Channel	CH 6 : 2437 MHz
Frequency Range	30MHz ~ 1GHz	Detector Function	Quasi-Peak (QP)
Test Mode	A		

Antenna Polarity & Test Distance : Horizontal at 3 m								
No	Frequency (MHz)	Emission Level (dBuV/m)	Limit (dBuV/m)	Margin (dB)	Antenna Height (m)	Table Angle (Degree)	Raw Value (dBuV)	Correction Factor (dB/m)
1	131.22	18.9 QP	43.5	-24.6	1.00 H	279	33.3	-14.4
2	198.70	23.9 QP	43.5	-19.6	1.00 H	262	40.7	-16.8
3	384.26	22.4 QP	46.0	-23.6	1.00 H	153	32.9	-10.5
4	479.86	23.2 QP	46.0	-22.8	1.00 H	319	31.3	-8.1
5	610.59	25.6 QP	46.0	-20.4	1.00 H	227	30.7	-5.1
6	822.87	29.7 QP	46.0	-16.3	1.00 H	221	31.8	-2.1

Remarks:

1. Emission Level(dBuV/m) = Raw Value(dBuV) + Correction Factor(dB/m).
2. Correction Factor(dB/m) = Antenna Factor(dB/m) + Cable Factor(dB) – Pre-Amplifier Factor(dB).
3. The other emission levels were very low against the limit of frequency range 30MHz ~ 1000MHz.
4. Margin value = Emission Level – Limit value.
5. The emission levels were very low against the limit of frequency range 9kHz ~ 30MHz: the amplitude of spurious emissions attenuated more than 20 dB below the permissible value to be report.

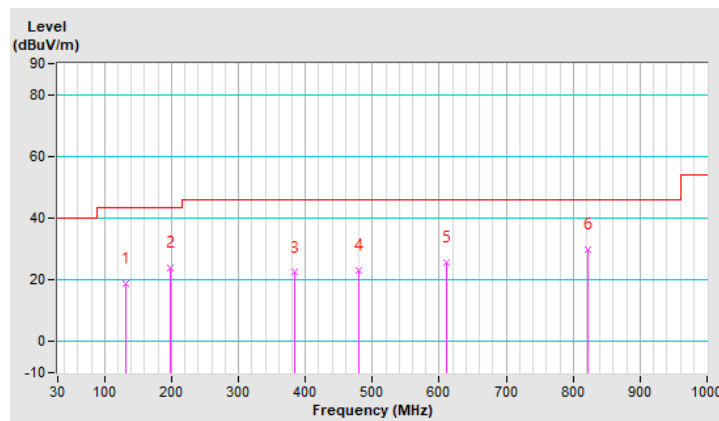

RF Mode	TX 802.11g	Channel	CH 6 : 2437 MHz
Frequency Range	30MHz ~ 1GHz	Detector Function	Quasi-Peak (QP)
Test Mode	A		

Antenna Polarity & Test Distance : Vertical at 3 m								
No	Frequency (MHz)	Emission Level (dBuV/m)	Limit (dBuV/m)	Margin (dB)	Antenna Height (m)	Table Angle (Degree)	Raw Value (dBuV)	Correction Factor (dB/m)
1	45.46	32.6 QP	40.0	-7.4	1.00 V	224	45.7	-13.1
2	125.59	20.5 QP	43.5	-23.0	1.00 V	218	35.4	-14.9
3	183.23	24.7 QP	43.5	-18.8	1.00 V	127	39.8	-15.1
4	519.22	24.9 QP	46.0	-21.1	1.00 V	332	32.4	-7.5
5	635.90	25.8 QP	46.0	-20.2	1.00 V	94	30.7	-4.9
6	860.83	29.1 QP	46.0	-16.9	1.00 V	27	30.8	-1.7

Remarks:

1. Emission Level(dBuV/m) = Raw Value(dBuV) + Correction Factor(dB/m).
2. Correction Factor(dB/m) = Antenna Factor(dB/m) + Cable Factor(dB) – Pre-Amplifier Factor(dB).
3. The other emission levels were very low against the limit of frequency range 30MHz ~ 1000MHz.
4. Margin value = Emission Level – Limit value.
5. The emission levels were very low against the limit of frequency range 9kHz ~ 30MHz: the amplitude of spurious emissions attenuated more than 20 dB below the permissible value to be report.

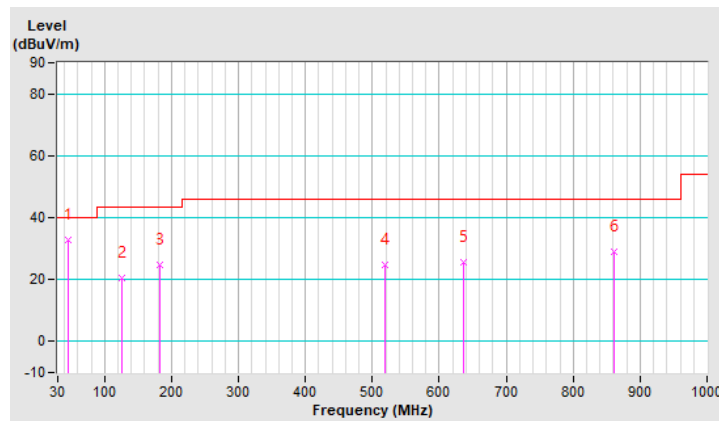

RF Mode	TX 802.11g	Channel	CH 6 : 2437 MHz
Frequency Range	30MHz ~ 1GHz	Detector Function	Quasi-Peak (QP)
Test Mode	B		

Antenna Polarity & Test Distance : Horizontal at 3 m								
No	Frequency (MHz)	Emission Level (dBuV/m)	Limit (dBuV/m)	Margin (dB)	Antenna Height (m)	Table Angle (Degree)	Raw Value (dBuV)	Correction Factor (dB/m)
1	41.25	26.6 QP	40.0	-13.4	1.00 H	234	40.0	-13.4
2	191.67	25.2 QP	43.5	-18.3	1.00 H	275	41.4	-16.2
3	268.99	23.4 QP	46.0	-22.6	1.25 H	332	37.0	-13.6
4	506.57	24.0 QP	46.0	-22.0	1.50 H	146	31.7	-7.7
5	711.81	27.2 QP	46.0	-18.8	1.50 H	211	31.1	-3.9
6	955.01	38.1 QP	46.0	-7.9	1.25 H	290	38.6	-0.5

Remarks:

1. Emission Level(dBuV/m) = Raw Value(dBuV) + Correction Factor(dB/m).
2. Correction Factor(dB/m) = Antenna Factor(dB/m) + Cable Factor(dB) – Pre-Amplifier Factor(dB).
3. The other emission levels were very low against the limit of frequency range 30MHz ~ 1000MHz.
4. Margin value = Emission Level – Limit value.
5. The emission levels were very low against the limit of frequency range 9kHz ~ 30MHz: the amplitude of spurious emissions attenuated more than 20 dB below the permissible value to be report.

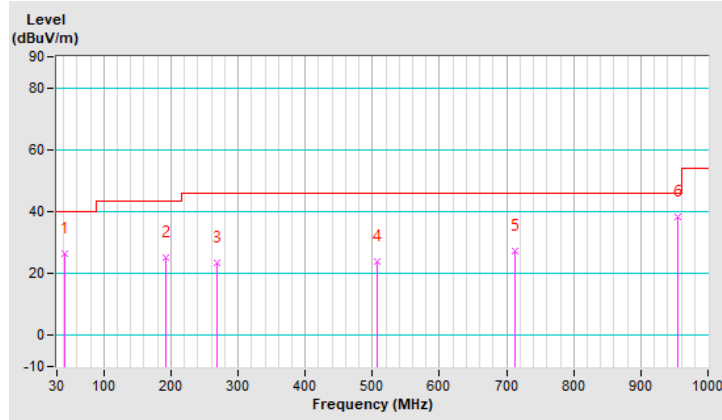

RF Mode	TX 802.11g	Channel	CH 6 : 2437 MHz
Frequency Range	30MHz ~ 1GHz	Detector Function	Quasi-Peak (QP)
Test Mode	B		

Antenna Polarity & Test Distance : Vertical at 3 m								
No	Frequency (MHz)	Emission Level (dBuV/m)	Limit (dBuV/m)	Margin (dB)	Antenna Height (m)	Table Angle (Degree)	Raw Value (dBuV)	Correction Factor (dB/m)
1	38.43	34.5 QP	40.0	-5.5	1.00 V	88	48.2	-13.7
2	93.26	26.0 QP	43.5	-17.5	1.25 V	119	44.7	-18.7
3	157.93	25.5 QP	43.5	-18.0	1.50 V	260	38.4	-12.9
4	256.33	23.0 QP	46.0	-23.0	1.00 V	272	37.2	-14.2
5	446.12	27.6 QP	46.0	-18.4	1.50 V	260	36.3	-8.7
6	955.01	36.0 QP	46.0	-10.0	1.25 V	296	36.5	-0.5

Remarks:

1. Emission Level(dBuV/m) = Raw Value(dBuV) + Correction Factor(dB/m).
2. Correction Factor(dB/m) = Antenna Factor(dB/m) + Cable Factor(dB) – Pre-Amplifier Factor(dB).
3. The other emission levels were very low against the limit of frequency range 30MHz ~ 1000MHz.
4. Margin value = Emission Level – Limit value.
5. The emission levels were very low against the limit of frequency range 9kHz ~ 30MHz: the amplitude of spurious emissions attenuated more than 20 dB below the permissible value to be report.

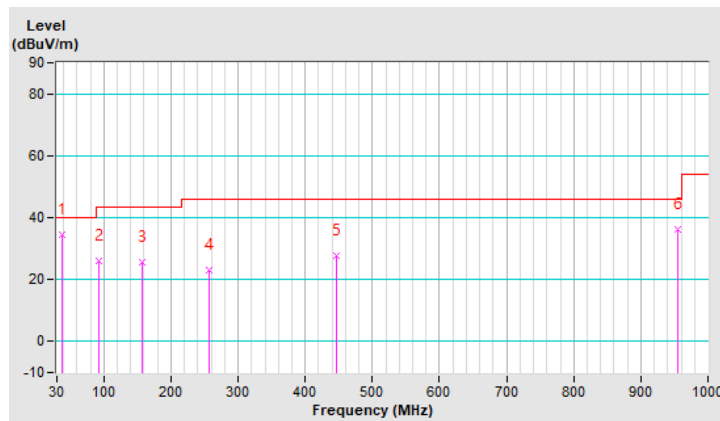

4.2 Conducted Emission Measurement

4.2.1 Limits of Conducted Emission Measurement

Frequency (MHz)	Conducted Limit (dBuV)	
	Quasi-peak	Average
0.15 - 0.5	66 - 56	56 - 46
0.50 - 5.0	56	46
5.0 - 30.0	60	50

- Note: 1. The lower limit shall apply at the transition frequencies.
 2. The limit decreases in line with the logarithm of the frequency in the range of 0.15 to 0.50MHz.

4.2.2 Test Instruments

Description & Manufacturer	Model No.	Serial No.	Cal. Date	Cal. Due
Test Receiver ROHDE & SCHWARZ	ESCI	100613	Dec. 03, 2021	Dec. 02, 2022
RF signal cable (with 10dB PAD) Woken	5D-FB	Cable-cond1-01	Jan. 15, 2022	Jan. 14, 2023
LISN ROHDE & SCHWARZ (EUT)	ENV216	101826	Mar. 14, 2022	Mar. 13, 2023
LISN ROHDE & SCHWARZ (Peripheral)	ESH3-Z5	100311	Sep. 07, 2021	Sep. 06, 2022
Software ADT	BV ADT_Cond_ V7.3.7.4	NA	NA	NA

- Note: 1. The calibration interval of the above test instruments is 12 months and the calibrations are traceable to NML/ROC and NIST/USA.
 2. The test was performed in HwaYa Shielded Room 1.
 3. The VCCI Site Registration No. is C-12040.

4.2.3 Test Procedures

- The EUT was placed 0.4 meters from the conducting wall of the shielded room with EUT being connected to the power mains through a line impedance stabilization network (LISN). Other support units were connected to the power mains through another LISN. The two LISNs provide 50 ohm/ 50uH of coupling impedance for the measuring instrument.
- Both lines of the power mains connected to the EUT were checked for maximum conducted interference.
- The frequency range from 150kHz to 30MHz was searched. Emission levels under (Limit - 20dB) was not recorded.

Note: The resolution bandwidth and video bandwidth of test receiver is 9kHz for quasi-peak detection (QP) and average detection (AV) at frequency 0.15MHz-30MHz.

4.2.4 Deviation from Test Standard

No deviation.

4.2.5 Test Setup

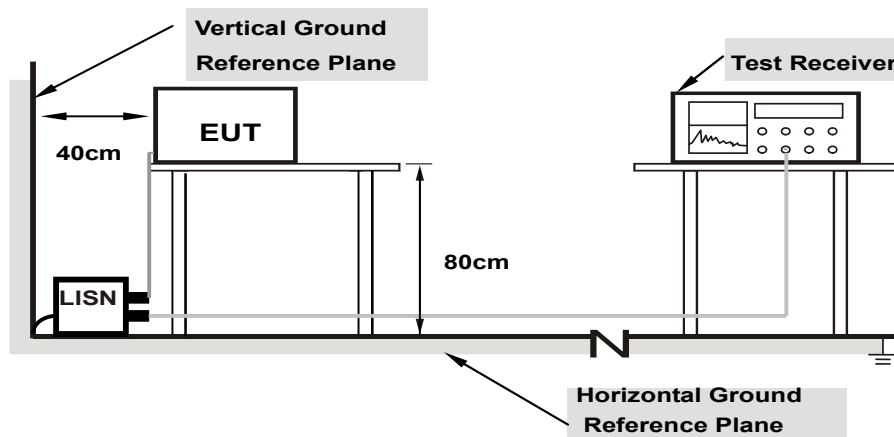

Note: 1.Support units were connected to second LISN.

For the actual test configuration, please refer to the attached file (Test Setup Photo).

4.2.6 EUT Operating Conditions

Same as 4.1.6.

4.2.7 Test Results

Worst-case data:

802.11g

Phase	Line (L)	Detector Function	Quasi-Peak (QP) / Average (AV)
Test Mode	A		

No	Freq. [MHz]	Corr. Factor (dB)	Reading Value [dB (uV)]		Emission Level [dB (uV)]		Limit [dB (uV)]		Margin (dB)	
			Q.P.	AV.	Q.P.	AV.	Q.P.	AV.	Q.P.	AV.
			1	0.15400	9.62	33.07	20.45	42.69	30.07	65.78
2	0.17384	9.63	33.65	18.92	43.28	28.55	64.77	54.77	-21.49	-26.22
3	0.19400	9.64	31.00	15.95	40.64	25.59	63.86	53.86	-23.22	-28.27
4	0.33325	9.67	33.11	25.65	42.78	35.32	59.37	49.37	-16.59	-14.05
5	4.92600	9.76	17.07	8.27	26.83	18.03	56.00	46.00	-29.17	-27.97
6	7.14200	9.78	20.00	12.62	29.78	22.40	60.00	50.00	-30.22	-27.60

Remarks:

1. Q.P. and AV. are abbreviations of quasi-peak and average individually.
2. The emission levels of other frequencies were very low against the limit.
3. Margin value = Emission level - Limit value
4. Correction factor = Insertion loss + Cable loss
5. Emission Level = Correction Factor + Reading Value.

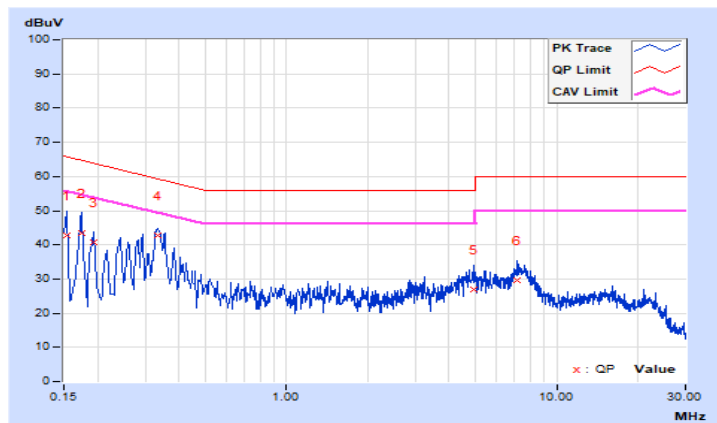

Phase	Neutral (N)	Detector Function	Quasi-Peak (QP) / Average (AV)
Test Mode	A		

No	Freq. [MHz]	Corr. Factor (dB)	Reading Value [dB (uV)]		Emission Level [dB (uV)]		Limit [dB (uV)]		Margin (dB)	
			Q.P.	AV.	Q.P.	AV.	Q.P.	AV.	Q.P.	AV.
			1	0.15400	9.62	32.42	17.73	42.04	27.35	65.78
2	0.17800	9.63	34.01	16.62	43.64	26.25	64.58	54.58	-20.94	-28.33
3	0.20200	9.64	28.94	14.40	38.58	24.04	63.53	53.53	-24.95	-29.49
4	0.30600	9.67	26.25	16.94	35.92	26.61	60.08	50.08	-24.16	-23.47
5	0.39800	9.69	19.93	8.87	29.62	18.56	57.90	47.90	-28.28	-29.34
6	2.79400	9.74	10.79	1.12	20.53	10.86	56.00	46.00	-35.47	-35.14

Remarks:

1. Q.P. and AV. are abbreviations of quasi-peak and average individually.
2. The emission levels of other frequencies were very low against the limit.
3. Margin value = Emission level - Limit value
4. Correction factor = Insertion loss + Cable loss
5. Emission Level = Correction Factor + Reading Value.

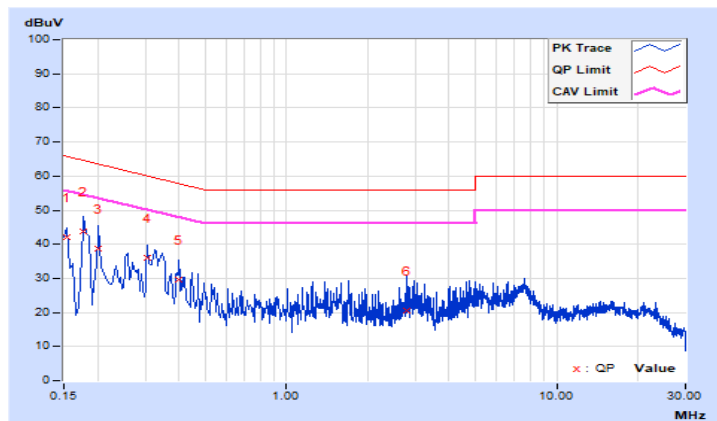

Phase	Line (L)	Detector Function	Quasi-Peak (QP) / Average (AV)
Test Mode	B		

No	Freq. [MHz]	Corr. Factor (dB)	Reading Value [dB (uV)]		Emission Level [dB (uV)]		Limit [dB (uV)]		Margin (dB)	
			Q.P.	AV.	Q.P.	AV.	Q.P.	AV.	Q.P.	AV.
			1	0.15000	9.62	39.81	28.96	49.43	38.58	66.00
2	0.17346	9.63	31.66	17.75	41.29	27.38	64.79	54.79	-23.50	-27.41
3	0.21647	9.64	28.16	19.55	37.80	29.19	62.95	52.95	-25.15	-23.76
4	0.42761	9.69	31.53	23.19	41.22	32.88	57.30	47.30	-16.08	-14.42
5	19.37156	9.87	27.38	26.32	37.25	36.19	60.00	50.00	-22.75	-13.81
6	22.97658	9.87	28.26	27.10	38.13	36.97	60.00	50.00	-21.87	-13.03

Remarks:

1. Q.P. and AV. are abbreviations of quasi-peak and average individually.
2. The emission levels of other frequencies were very low against the limit.
3. Margin value = Emission level - Limit value
4. Correction factor = Insertion loss + Cable loss
5. Emission Level = Correction Factor + Reading Value.

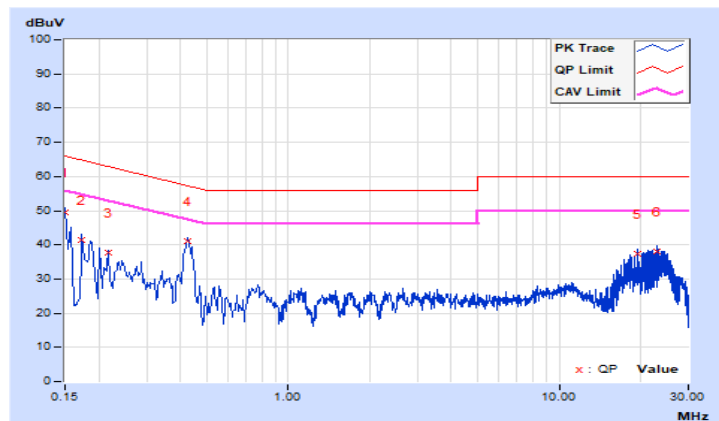

Phase	Neutral (N)	Detector Function	Quasi-Peak (QP) / Average (AV)
Test Mode	B		

No	Freq. [MHz]	Corr. Factor (dB)	Reading Value [dB (uV)]		Emission Level [dB (uV)]		Limit [dB (uV)]		Margin (dB)	
			Q.P.	AV.	Q.P.	AV.	Q.P.	AV.	Q.P.	AV.
			1	0.15391	9.62	38.85	28.18	48.47	37.80	65.79
2	0.17346	9.63	30.24	15.64	39.87	25.27	64.79	54.79	-24.92	-29.52
3	0.21256	9.64	29.59	19.48	39.23	29.12	63.10	53.10	-23.87	-23.98
4	0.42445	9.69	30.53	22.17	40.22	31.86	57.36	47.36	-17.14	-15.50
5	10.91032	9.82	16.11	8.09	25.93	17.91	60.00	50.00	-34.07	-32.09
6	21.92870	9.89	26.97	26.06	36.86	35.95	60.00	50.00	-23.14	-14.05

Remarks:

1. Q.P. and AV. are abbreviations of quasi-peak and average individually.
2. The emission levels of other frequencies were very low against the limit.
3. Margin value = Emission level - Limit value
4. Correction factor = Insertion loss + Cable loss
5. Emission Level = Correction Factor + Reading Value.

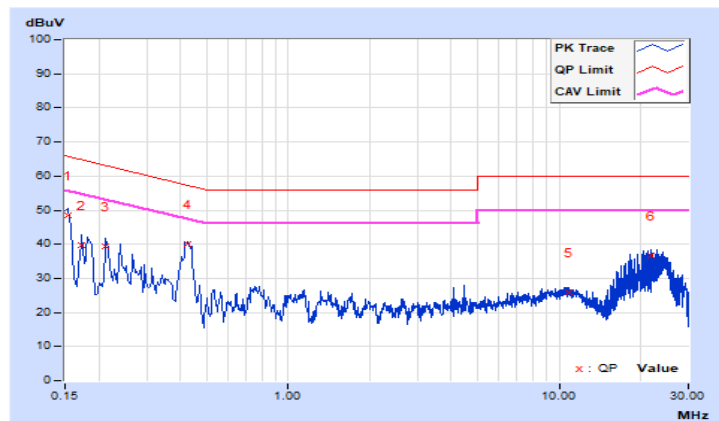

5 Pictures of Test Arrangements

Please refer to the attached file (Test Setup Photo).

Appendix – Information of the Testing Laboratories

We, Bureau Veritas Consumer Products Services (H.K.) Ltd., Taoyuan Branch, were founded in 1988 to provide our best service in EMC, Radio, Telecom and Safety consultation. Our laboratories are FCC recognized accredited test firms and accredited and approved according to ISO/IEC 17025.

If you have any comments, please feel free to contact us at the following:

Lin Kou EMC/RF Lab

Tel: 886-2-26052180

Fax: 886-2-26051924

Hsin Chu EMC/RF/Telecom Lab

Tel: 886-3-6668565

Fax: 886-3-6668323

Hwa Ya EMC/RF/Safety Lab

Tel: 886-3-3183232

Fax: 886-3-3270892

Email: service.adt@tw.bureauveritas.com

Web Site: www.bureauveritas-adt.com

The address and road map of all our labs can be found in our web site also.

--- END ---