

DFS Test Report

Report No.: RF150127C37A-1

FCC ID: 2ACTO-AP55C

Test Model: AP 55C

Received Date: Dec. 27, 2014

Test Date: May 23 ~ May 27, 2015

Issued Date: May 28, 2015

Applicant: Sophos Ltd

Address: The Pentagon, Abingdon, OX14 3YP, United Kingdom

Issued By: Bureau Veritas Consumer Products Services (H.K.) Ltd., Taoyuan Branch

Lab Address: No. 47-2, 14th Ling, Chia Pau Vil., Lin Kou Dist., New Taipei City, Taiwan, R.O.C.

Test Location: No. 19, Hwa Ya 2nd Rd., Wen Hwa Vil., Kwei Shan Dist., Taoyuan City 33383, TAIWAN (R.O.C.)



This report is for your exclusive use. Any copying or replication of this report to or for any other person or entity, or use of our name or trademark, is permitted only with our prior written permission. This report sets forth our findings solely with respect to the test samples identified herein. The results set forth in this report are not indicative or representative of the quality or characteristics of the lot from which a test sample was taken or any similar or identical product unless specifically and expressly noted. Our report includes all of the tests requested by you and the results thereof based upon the information that you provided to us. You have 60 days from date of issuance of this report to notify us of any material error or omission caused by our negligence, provided, however, that such notice shall be in writing and shall specifically address the issue you wish to raise. A failure to raise such issue within the prescribed time shall constitute your unqualified acceptance of the completeness of this report, the tests conducted and the correctness of the report contents. Unless specific mention, the uncertainty of measurement has been explicitly taken into account to declare the compliance or non-compliance to the specification. The report must not be used by the client to claim product certification, approval, or endorsement by TAF or any government agencies.



Table of Contents

Release Control Record	3
1 Certificate of Conformity	4
2 EUT Information	5
2.1 Operating Frequency Bands and Mode of EUT.....	5
2.2 EUT Software and Firmware Version.....	5
2.3 Description Of Available Antennas to The EUT	5
2.4 EUT Maximum Conducted Power.....	6
2.5 EUT Maximum E.I.R.P. Power	7
2.6 Transmit Power Control (TPC).....	8
2.7 Statement of Manufacturer.....	8
3. U-NII DFS Rule Requirements	9
3.1 Working Modes and Required Test Items	9
3.2 Test Limits And Radar Signal Parameters	10
4. Test & Support Equipment List	12
4.1 Test Instruments.....	12
4.2 Description of Support Units	12
5. Test Procedure	13
5.1 ADT DFS Measurement System.....	13
5.2 Calibration of DFS Detection Threshold Level.....	14
5.3 Deviation From Test Standard.....	14
5.4 Radiated Test Setup Configuration	15
5.4.1 Master Mode.....	15
6. Test Results	16
6.1 Summary of Test Results	16
6.2 Test Results.....	17
6.2.1 Test Mode	17
6.2.2 U-NII Detection Bandwidth	22
6.2.3 Channel Availability Check Time	28
6.2.4 Channel Closing Transmission and Channel Move Time.....	30
6.2.5 Non- Occupancy Period	39
6.2.6 Uniform Spreading.....	42
6.2.7 Transmit Power Control (TPC).....	42
7. Information on The Testing Laboratories	43



A D T

Release Control Record

Issue No.	Description	Date Issued
RF150127C37A-1	Original release.	May 28, 2015

1 Certificate of Conformity

Product: Sophos wireless Access Point AP 55C

Brand: Sophos

Test Model: AP 55C

Sample Status: Engineering sample

Applicant: Sophos Ltd

Test Date: May 23 ~ May 27, 2015

Standards: FCC Part 15, Subpart E (Section 15.407)

KDB 905462 D02

The above equipment has been tested by **Bureau Veritas Consumer Products Services (H.K.) Ltd., Taoyuan Branch**, and found compliance with the requirement of the above standards. The test record, data evaluation & Equipment Under Test (EUT) configurations represented herein are true and accurate accounts of the measurements of the sample's EMC characteristics under the conditions specified in this report.

Prepared by :  , **Date:** May 28, 2015
Pettie Chen / Senior Specialist

Approved by :  , **Date:** May 28, 2015
Ken Liu / Senior Manager

2 EUT Information

2.1 Operating Frequency Bands and Mode of EUT

Table 1: Operating Frequency Bands and Mode of EUT

Operational Mode	Operating Frequency Range	
	5250~5350MHz	5470~5725MHz
Master	✓	✓

2.2 EUT Software and Firmware Version

Table 2: The Eut Software/Firmware Version

No.	Product	Model No.	Software/Firmware Version
1	Sophos wireless Access Point AP 55C	AP 55C	Firmware Version: 9300-7fce551-091e663-180 UTM Firmware Version: 9.203-3

2.3 Description Of Available Antennas to The EUT

Table 3: Antenna List

ANT No.	Antenna Type	Operation Frequency Range (MHz)	Gain (dBi)
1.	PIFA	5250-5725	6.13
2.	PIFA	5250-5725	5.96

2.4 EUT Maximum Conducted Power

Table 4: The Measured Conducted Output Power

802.11a

ANT No.	Frequency Band (MHz)	MAX. Power	
		Output Power(dBm)	Output Power(mW)
1	5250~5350	23.77	238.232
1	5470~5725	21.19	131.522

802.11n HT20

ANT No.	Frequency Band (MHz)	MAX. Power	
		Output Power(dBm)	Output Power(mW)
1	5250~5350	23.65	231.677
1	5470~5725	23.72	235.271

802.11n HT40

ANT No.	Frequency Band (MHz)	MAX. Power	
		Output Power(dBm)	Output Power(mW)
1	5250~5350	23.02	200.234
1	5470~5725	23.31	214.161

802.11ac VHT20

ANT No.	Frequency Band (MHz)	MAX. Power	
		Output Power(dBm)	Output Power(mW)
1	5250~5350	23.60	229.147
1	5470~5725	23.80	239.777

802.11ac VHT40

ANT No.	Frequency Band (MHz)	MAX. Power	
		Output Power(dBm)	Output Power(mW)
1	5250~5350	23.02	200.237
1	5470~5725	23.33	215.108

802.11ac VHT80

ANT No.	Frequency Band (MHz)	MAX. Power	
		Output Power(dBm)	Output Power(mW)
1	5250~5350	21.11	128.982
1	5470~5725	18.85	76.715

2.5 EUT Maximum E.I.R.P. Power

Table 5: The EIRP Output Power List

802.11a

ANT No.	Frequency Band (MHz)	MAX. Power	
		Output Power(dBm)	Output Power(mW)
1	5250~5350	29.90	977.237
1	5470~5725	27.32	539.511

802.11n HT20

ANT No.	Frequency Band (MHz)	MAX. Power	
		Output Power(dBm)	Output Power(mW)
1	5250~5350	29.78	950.605
1	5470~5725	29.85	966.051

802.11n HT40

ANT No.	Frequency Band (MHz)	MAX. Power	
		Output Power(dBm)	Output Power(mW)
1	5250~5350	29.15	822.243
1	5470~5725	29.44	879.023

802.11ac VHT20

ANT No.	Frequency Band (MHz)	MAX. Power	
		Output Power(dBm)	Output Power(mW)
1	5250~5350	29.73	939.723
1	5470~5725	29.93	984.011

802.11ac VHT40

ANT No.	Frequency Band (MHz)	MAX. Power	
		Output Power(dBm)	Output Power(mW)
1	5250~5350	29.15	822.243
1	5470~5725	29.46	883.080

802.11ac VHT80

ANT No.	Frequency Band (MHz)	MAX. Power	
		Output Power(dBm)	Output Power(mW)
1	5250~5350	27.24	529.663
1	5470~5725	24.98	314.775

2.6 Transmit Power Control (TPC)

U-NII devices operating in the 5.25-5.35 GHz band and the 5.47-5.725 GHz band shall employ a TPC mechanism. The U-NII device is required to have the capability to operate at least 6 dB below the mean EIRP value of 30 dBm. A TPC mechanism is not required for systems with an e.i.r.p. of less than 500 mW.

Maximum EIRP of this device is 984,011 mW, which is higher than 500mW. Therefore, TPC functionality is required. The firmware of this device supports TPC according to the international standard IEEE 802.11h and automatically reduces the power level to below 24dBm (EIRP) in applicable frequency bands as given in the following table:

5250~5350MHz		5470~5725MHz	
Operation mode	TPC (EIRP)	Operation mode	TPC (EIRP)
802.11a	24dBm	802.11a	24dBm
802.11n(HT20)		802.11n(HT20)	
802.11n(HT40)		802.11n(HT40)	
802.11ac (VHT80)		802.11ac (VHT80)	

The TPC functionality provided by the manufacturer cannot be modified by the end-user.

2.7 Statement of Manufacturer

Manufacturer statement confirming that information regarding the parameters of the detected Radar Waveforms is not available to the end user.

3. U-NII DFS Rule Requirements

3.1 Working Modes and Required Test Items

The manufacturer shall state whether the UUT is capable of operating as a Master and/or a Client. If the UUT is capable of operating in more than one operating mode then each operating mode shall be tested separately. See tables 6 and 7 for the applicability of DFS requirements for each of the operational modes.

Table 6: Applicability of DFS Requirements Prior To Use a Channel

Requirement	Operational Mode		
	Master	Client without radar detection	Client with radar detection
Non-Occupancy Period	✓	Not required	✓
DFS Detection Threshold	✓	Not required	✓
Channel Availability Check Time	✓	Not required	Not required
U-NII Detection Bandwidth	✓	Not required	✓

Table 7: Applicability of DFS Requirements During Normal Operation.

Requirement	Operational Mode	
	Master or Client with radar detection	Client without radar detection
DFS Detection Threshold	✓	Not required
Channel Closing Transmission Time	✓	✓
Channel Move Time	✓	✓
U-NII Detection Bandwidth	✓	Not required

Additional requirements for devices with multiple bandwidth modes	Master or Client with radar detection	Client without radar detection
U-NII Detection Bandwidth and Statistical Performance Check	All BW modes must be tested	Not required
Channel Move Time and Channel Closing Transmission Time	Test using widest BW mode available	Test using the widest BW mode available for the link
All other tests	Any single BW mode	Not required

Note: Frequencies selected for statistical performance check (Section 7.8.4) should include several frequencies within the radar detection bandwidth and frequencies near the edge of the radar detection bandwidth. For 802.11 devices it is suggested to select frequencies in all 20 MHz channel blocks and a null frequencies between the bonded 20 MHz channel blocks.

3.2 Test Limits And Radar Signal Parameters

Detection Threshold Values

Table 8: DFS Detection Thresholds For Master Devices And Client Devices With Radar Detection

Maximum Transmit Power	Value (See Notes 1, 2, and 3)
EIRP \geq 200 milliwatt	-64 dBm
EIRP < 200 milliwatt and power spectral density < 10 dBm/MHz	-62 dBm
EIRP < 200 milliwatt that do not meet the power spectral density requirement	-64 dBm

Note 1: This is the level at the input of the receiver assuming a 0 dBi receive antenna.
 Note 2: Throughout these test procedures an additional 1 dB has been added to the amplitude of the test transmission waveforms to account for variations in measurement equipment. This will ensure that the test signal is at or above the detection threshold level to trigger a DFS response.
 Note3: EIRP is based on the highest antenna gain. For MIMO devices refer to KDB Publication 662911 D01.

Table 9: DFS Response Requirement Values

Parameter	Value
Non-occupancy period	Minimum 30 minutes
Channel Availability Check Time	60 seconds
Channel Move Time	10 seconds See Note 1.
Channel Closing Transmission Time	200 milliseconds + an aggregate of 60 milliseconds over remaining 10 second period. See Notes 1 and 2.
U-NII Detection Bandwidth	Minimum 100% of the U-NII 99% transmission power bandwidth. See Note 3

Note 1: Channel Move Time and the Channel Closing Transmission Time should be performed with Radar Type 0. The measurement timing begins at the end of the Radar Type 0 burst.
 Note 2: The Channel Closing Transmission Time is comprised of 200 milliseconds starting at the beginning of the Channel Move Time plus any additional intermittent control signals required to facilitate a Channel move (an aggregate of 60 milliseconds) during the remainder of the 10 second period. The aggregate duration of control signals will not count quiet periods in between transmissions.
 Note 3: During the U-NII Detection Bandwidth detection test, radar type 0 should be used. For each frequency step the minimum percentage of detection is 90 percent. Measurements are performed with no data traffic.

Parameters of DFS Test Signals

Step intervals of 0.1 microsecond for Pulse Width, 1 microsecond for PRI, 1 MHz for chirp width and 1 for the number of pulses will be utilized for the random determination of specific test waveforms.

Table 10: Short Pulse Radar Test Waveforms

Radar Type	Pulse Width (μsec)	PRI (μsec)	Number of Pulses	Minimum Percentage of Successful Detection	Minimum Number of Trials
0	1	1428	18	See Note 1	See Note 1
1	1	Test A: 15 unique PRI values randomly selected from the list of 23 PRI values in Table 5a	Roundup $\left\{ \left(\frac{1}{360} \right) \cdot \left(\frac{19 \cdot 10^6}{\text{PRI}_{\mu\text{sec}}} \right) \right\}$	60%	30
		Test B: 15 unique PRI values randomly selected within the range of 518-3066 μ sec, with a minimum increment of 1 μ sec, excluding PRI values selected in Test A			
2	1-5	150-230	23-29	60%	30
3	6-10	200-500	16-18	60%	30
4	11-20	200-500	12-16	60%	30
Aggregate (Radar Types 1-4)				80%	120
Note 1: Short Pulse Radar Type 0 should be used for the detection bandwidth test, channel move time, and channel closing time tests.					

Table 11: Long Pulse Radar Test Waveform

Radar Type	Pulse Width (μsec)	Chirp Width (MHz)	PRI (μsec)	Number Of Pulses Per Burst	Number Of Bursts	Minimum Percentage Of Successful Detection	Minimum Number Of Trials
5	50-100	5-20	1000-2000	1-3	8-20	80%	30

Table 12: Frequency Hopping Radar Test Waveform

Radar Type	Pulse Width (μsec)	PRI (μsec)	Pulses per Hop	Hopping Rate (kHz)	Hopping Sequence Length (msec)	Minimum Percentage Of Successful Detection	Minimum Number Of Trials
6	1	333	9	0.333	300	70%	30

4. Test & Support Equipment List

4.1 Test Instruments

Table 13: Test Instruments List

Description & Manufacturer	Model No.	Brand	Date Of Calibration	Due Date Of Calibration
R&S Spectrum analyzer	FSP40	R&S	2015/01/14	2016/01/13
Signal generator	8645A	Agilent	2014/06/24	2015/06/23

4.2 Description of Support Units

Table 14: Support Unit Information.

No.	Product	Brand	Model No.	FCC ID
1	AC1200 Dual Band USB Adapter	D-Link	DWA-182	KA2WA182A1

NOTE: This device was functioned as a Master Slave device during the DFS test.

5. Test Procedure

5.1 ADT DFS Measurement System

A complete ADT DFS Measurement System consists of two subsystems: (1) the Radar Signal Generating Subsystem and (2) the Traffic Monitoring Subsystem. The control PC is necessary for generating the Radar waveforms in Table 10, 11 and 12. The traffic monitoring subsystem is specified to the type of unit under test (UUT).

Radiated Setup Configuration of ADT DFS Measurement System

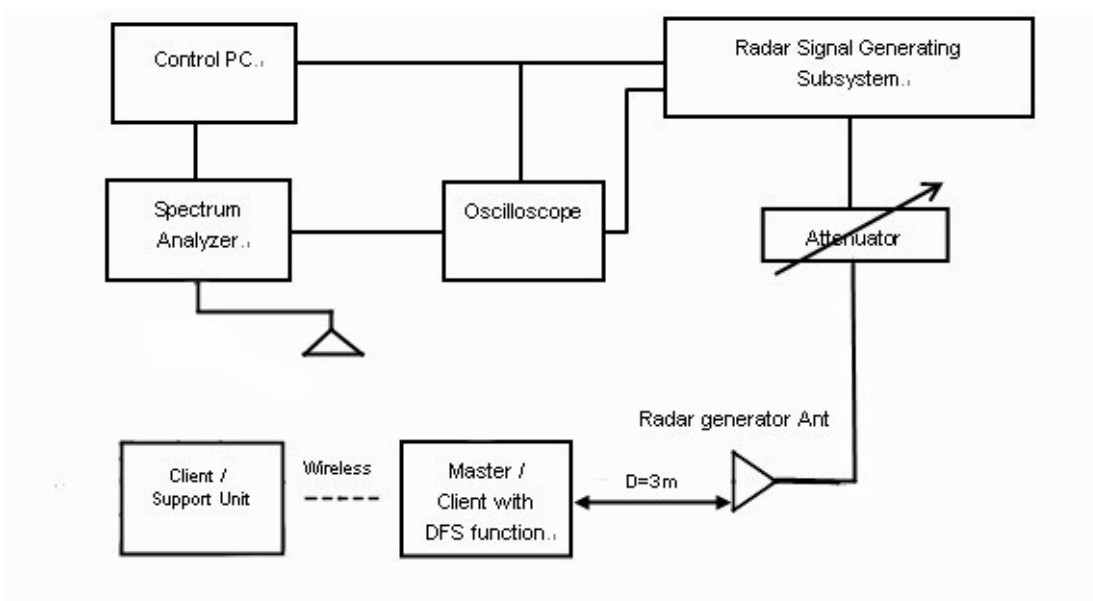

System testing will be performed with channel-loading using means appropriate to the data types that are used by the unlicensed device. The following requirements apply:

	a) The data file must be of a type that is typical for the device (i.e., MPEG-2, MPEG-4, WAV, MP3, MP4, AVI, etc.) and must generally be transmitting in a streaming mode.
	b) Software to ping the client is permitted to simulate data transfer but must have random ping intervals.
v	c) Timing plots are required with calculations demonstrating a minimum channel loading of approximately 17% or greater.
	d) Unicast or Multicast protocols are preferable but other protocols may be used. The appropriate protocol used must be described in the test procedures.

5.2 Calibration of DFS Detection Threshold Level

The measured channel is 5500MHz, 5510MHz and 5530MHz. The radar signal was the same as transmitted channels, and injected into the antenna of AP (master) or Client Device with Radar Detection, measured the channel closing transmission time and channel move time. The calibrated conducted detection threshold level is set to -64dBm. The tested level is lower than required level hence it provides margin to the limit.

Radiated setup configuration of Calibration of DFS Detection Threshold Level

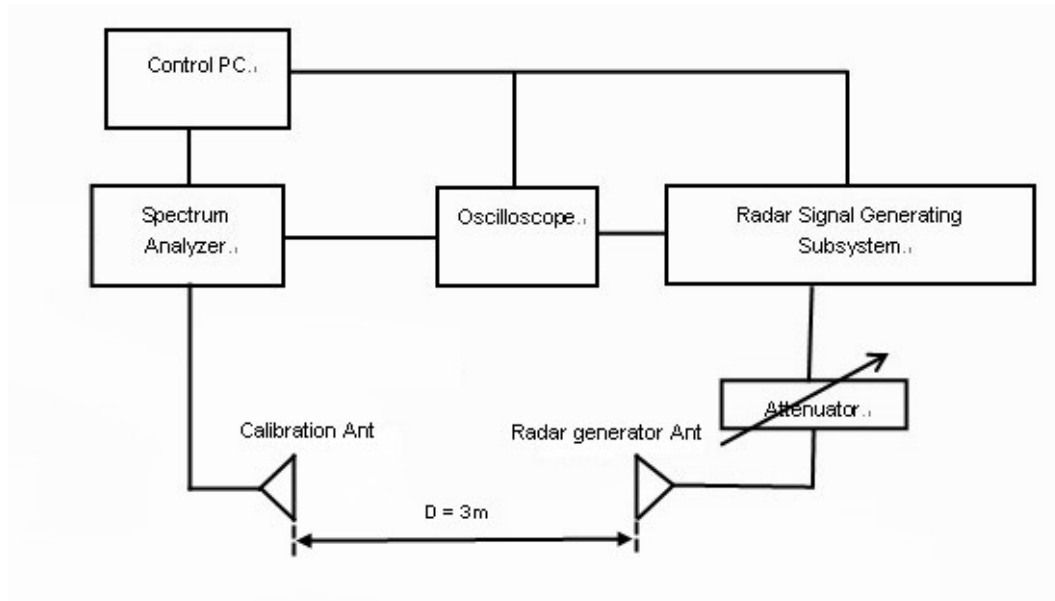

5.3 Deviation From Test Standard

No deviation.

5.4 Radiated Test Setup Configuration

5.4.1 Master Mode

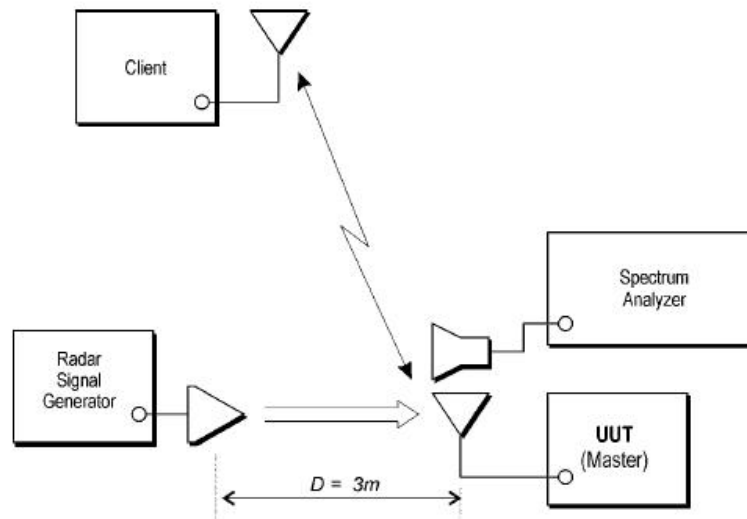

The EUT is a U-NII Device operating in Master mode. The radar test signals are injected into the Master Device.

6. Test Results

6.1 Summary of Test Results

Clause	Test Parameter	Remarks	Pass/Fail
15.407	DFS Detection Threshold	Applicable	Pass
15.407	U-NII Detection Bandwidth	Applicable	Pass
15.407	Channel Availability Check Time	Applicable	Pass
15.407	Channel Move Time	Applicable	Pass
15.407	Channel Closing Transmission Time	Applicable	Pass
15.407	Non- Occupancy Period	Applicable	Pass
15.407	Uniform Spreading	Applicable	Pass

6.2 Test Results

6.2.1 Test Mode

Master with injection at the Master. (Radar Test Waveforms are injected into the Master.)

The modulation and bandwidth are similar for 802.11n mode for HT20 / HT40 and 802.11ac mode for VHT20 / VHT40, therefore investigated worst case for final test were chosen 802.11an (HT20 / HT40) and record in test report.

DFS Detection Threshold

For detection threshold level of -64dBm, the required Radar Signal at antenna port was set to -64dBm. The tested level is lower than required level for 1dB, hence it provides margin to the limit.

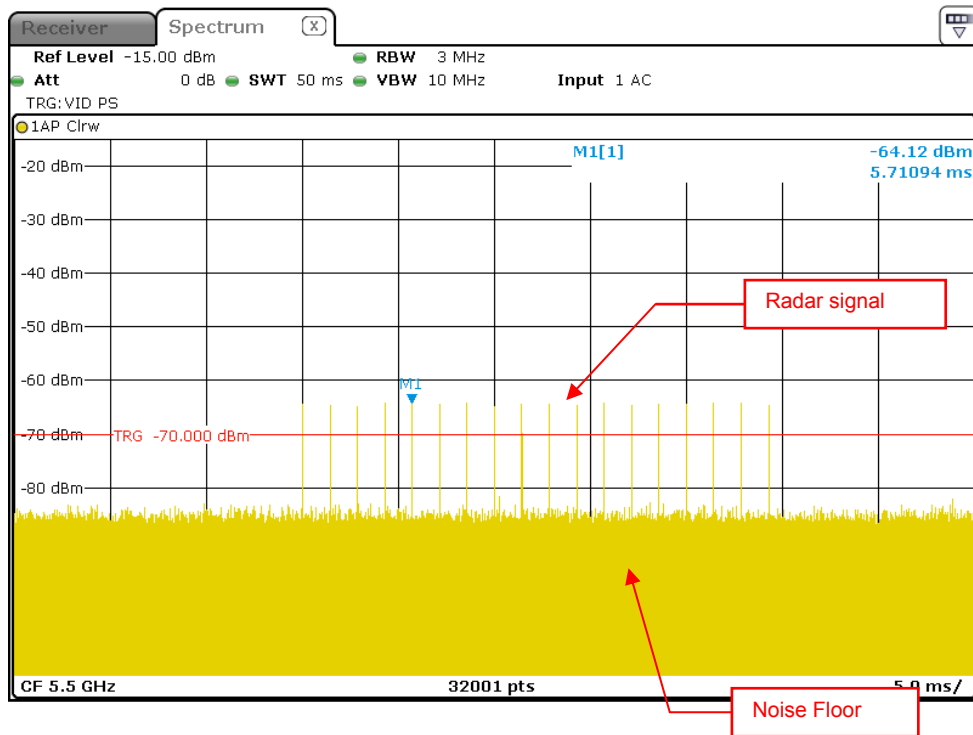

Radar Signal 0

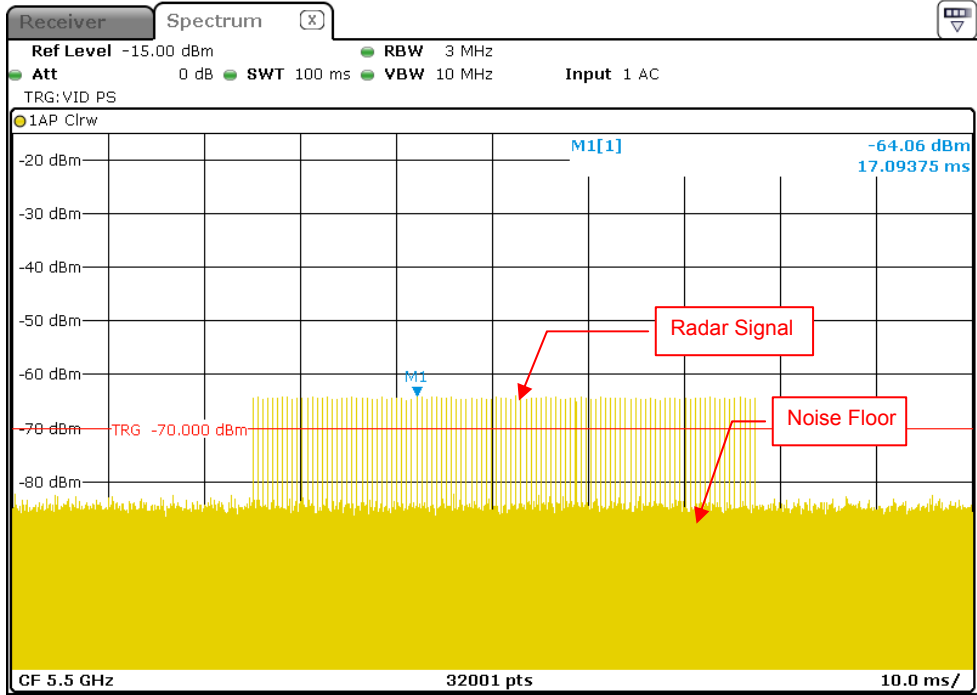

Radar Signal 1 (Test A)

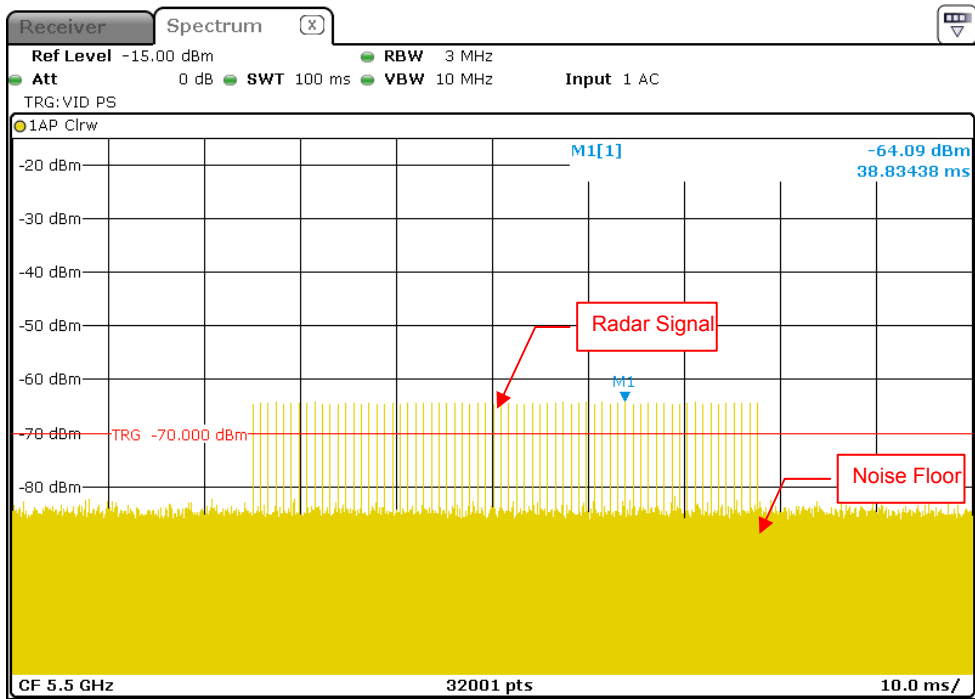

Radar Signal 1 (Test B)

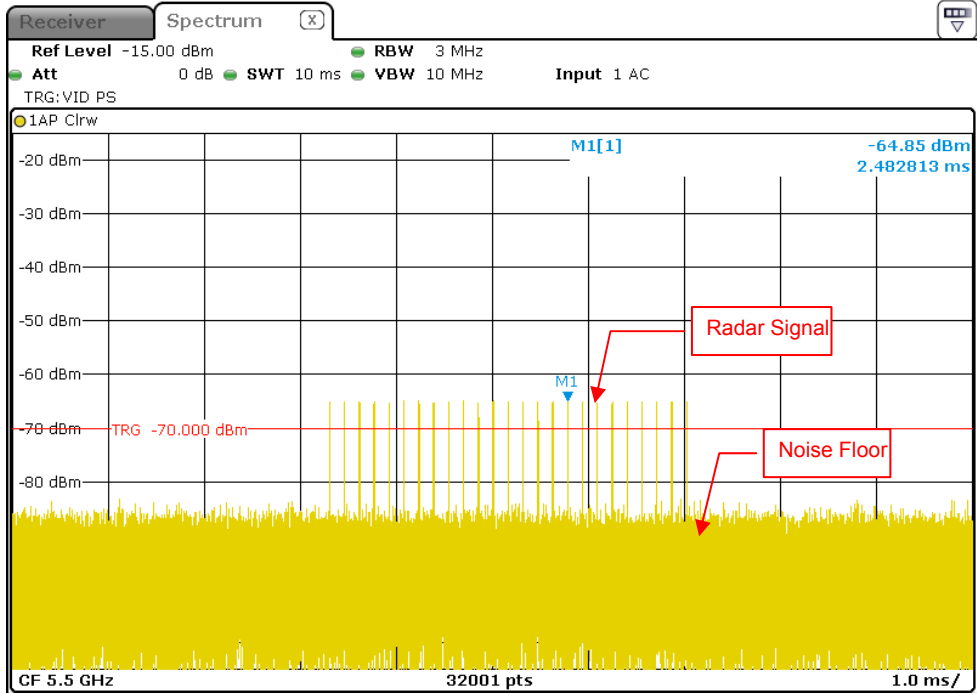

Radar Signal 2

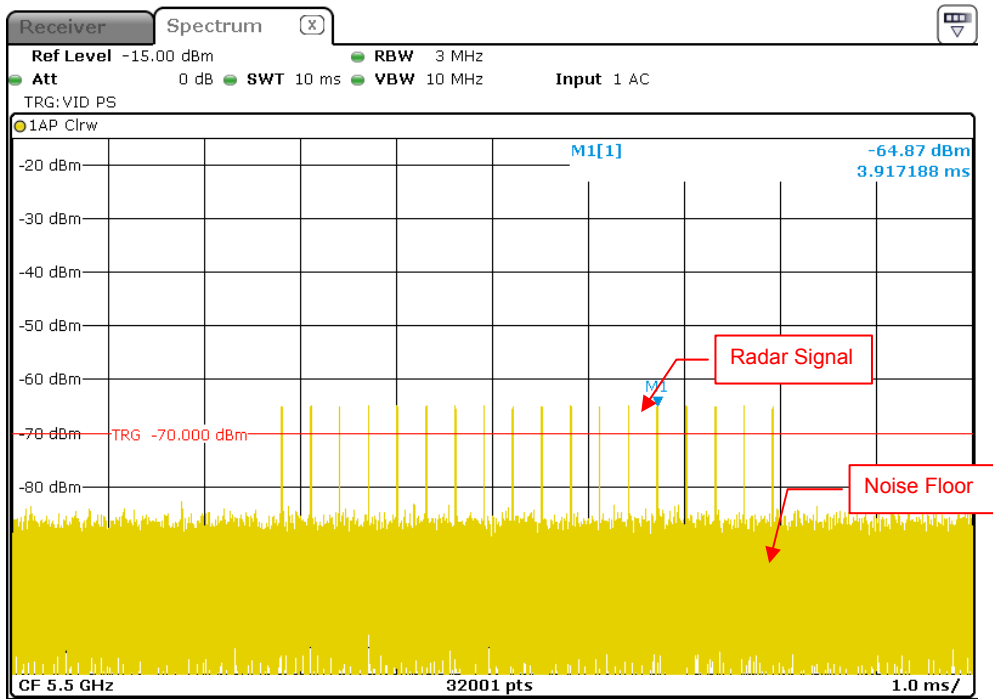

Radar Signal 3

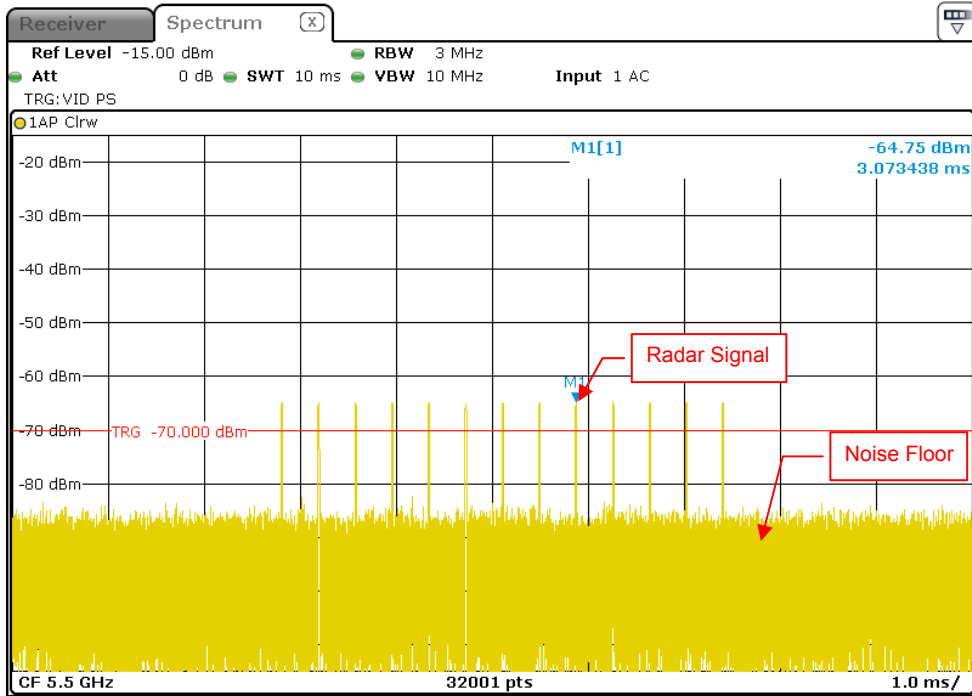

Single Burst of Radar Signal 4

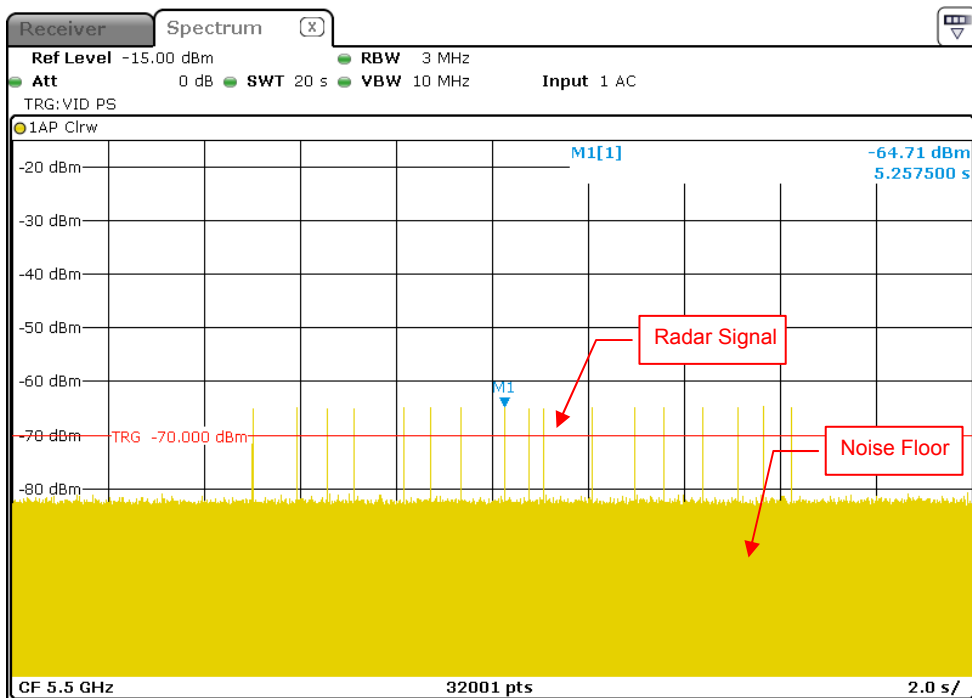

Radar Signal 5

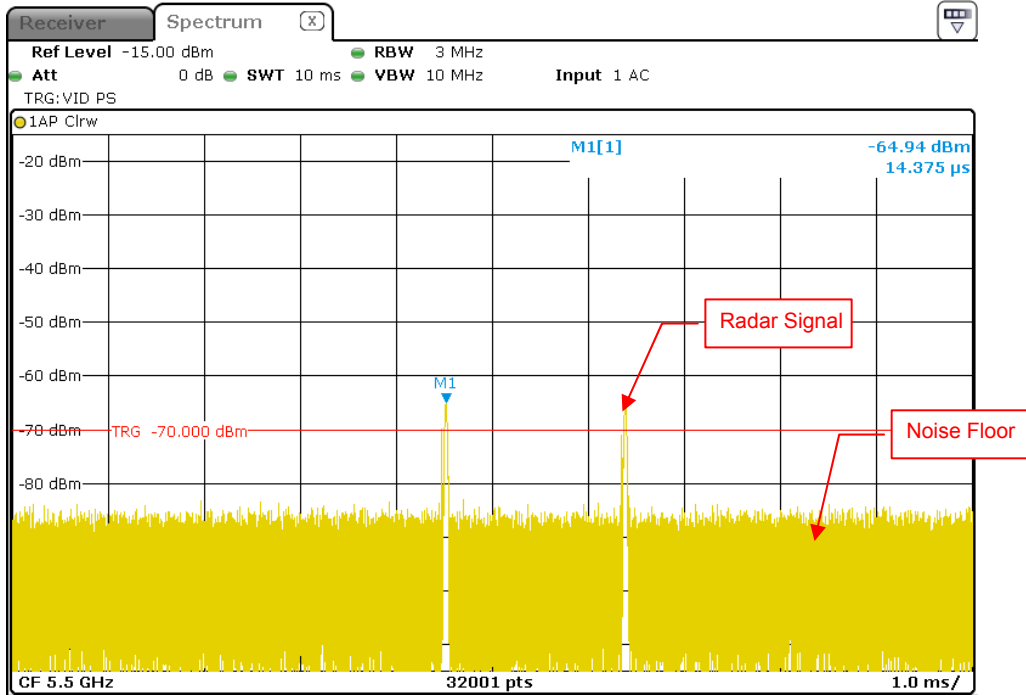

Single Burst of Radar Signal 5

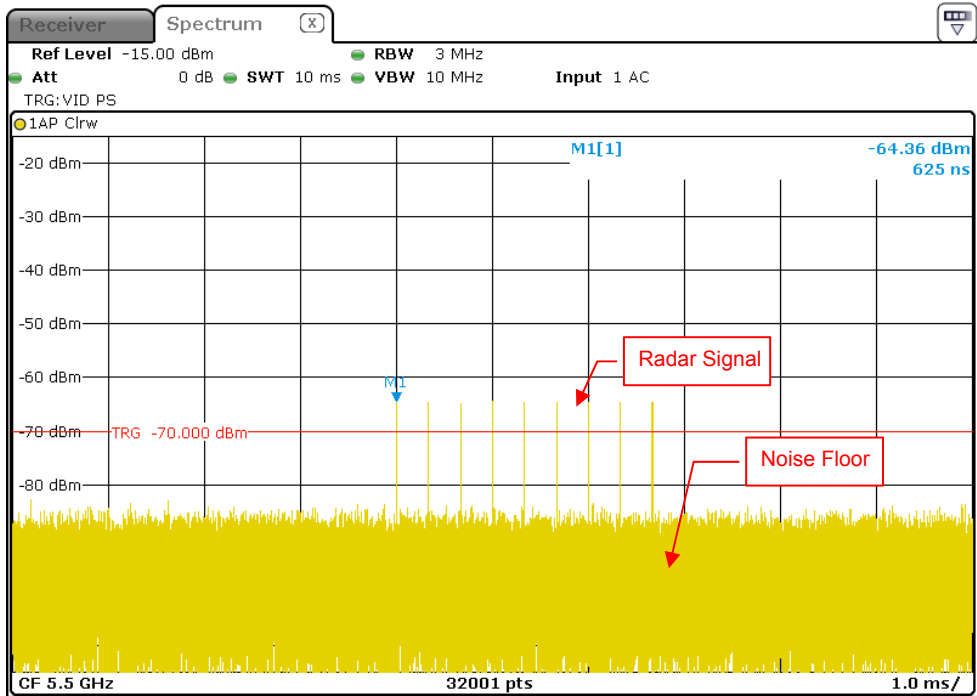

Radar Signal 6

6.2.2 U-NII Detection Bandwidth

IEEE 802.11an HT20

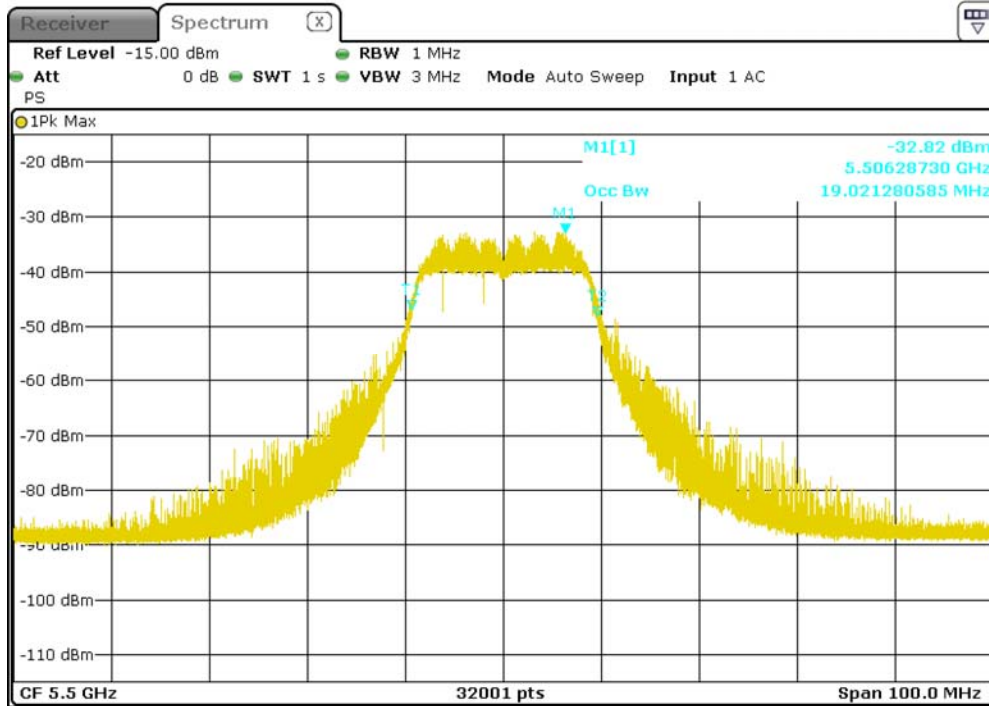

U-NII 99% Channel bandwidth

IEEE 802.11an HT40

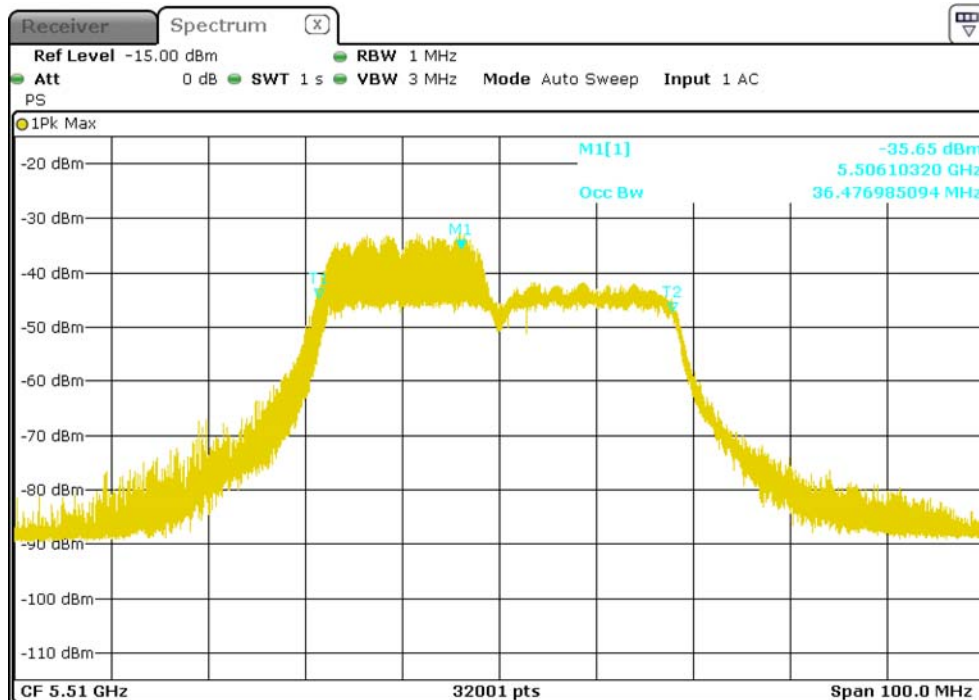

U-NII 99% Channel bandwidth

IEEE 802.11ac VHT80

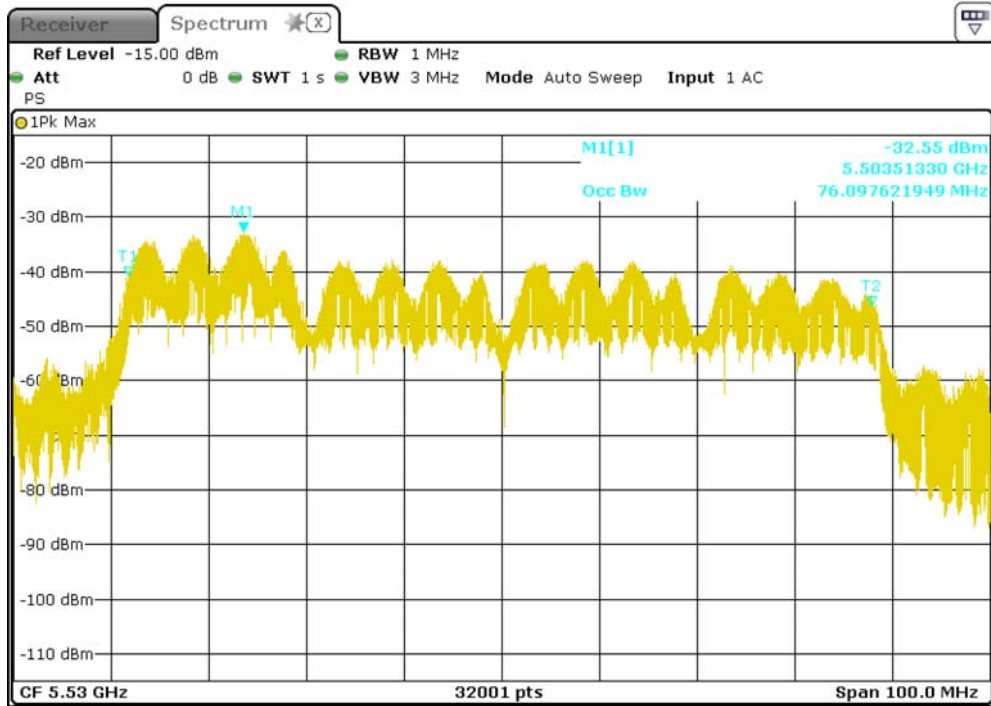

U-NII 99% Channel bandwidth

Detection Bandwidth Test - IEEE 802.11an HT20											
Radar Type 0											
EUT Frequency: 5500MHz											
EUT 99% Power bandwidth: 19.02MHz											
Detection bandwidth limit (100% of EUT 99% Power bandwidth): 19.02MHz											
Detection bandwidth (5510(FH) – 5490(FL)) : 20MHz											
Test Result : PASS											
Radar Frequency (MHz)	Trial Number / Detection										Detection Rate (%)
	1	2	3	4	5	6	7	8	9	10	
5489	N	N	N	N	N	N	N	N	N	N	0
5490(FL)	Y	Y	Y	Y	Y	Y	Y	Y	Y	Y	100
5491	Y	Y	Y	Y	Y	Y	Y	Y	Y	Y	100
5492	Y	Y	Y	Y	Y	Y	Y	Y	Y	Y	100
5493	Y	Y	Y	Y	Y	Y	Y	Y	Y	Y	100
5494	Y	Y	Y	Y	Y	Y	Y	Y	Y	Y	100
5495	Y	Y	Y	Y	Y	Y	Y	Y	Y	Y	100
5496	Y	Y	Y	Y	Y	Y	Y	Y	Y	Y	100
5497	Y	Y	Y	Y	Y	Y	Y	Y	Y	Y	100
5498	Y	Y	Y	Y	Y	Y	Y	Y	Y	Y	100
5499	Y	Y	Y	Y	Y	Y	Y	Y	Y	Y	100
5500	Y	Y	Y	Y	Y	Y	Y	Y	Y	Y	100
5501	Y	Y	Y	Y	Y	Y	Y	Y	Y	Y	100
5502	Y	Y	Y	Y	Y	Y	Y	Y	Y	Y	100
5503	Y	Y	Y	Y	Y	Y	Y	Y	Y	Y	100
5504	Y	Y	Y	Y	Y	Y	Y	Y	Y	Y	100
5505	Y	Y	Y	Y	Y	Y	Y	Y	Y	Y	100
5506	Y	Y	Y	Y	Y	Y	Y	Y	Y	Y	100
5507	Y	Y	Y	Y	Y	Y	Y	Y	Y	Y	100
5508	Y	Y	Y	Y	Y	Y	Y	Y	Y	Y	100
5509	Y	Y	Y	Y	Y	Y	Y	Y	Y	Y	100
5510(FH)	Y	Y	Y	Y	Y	Y	Y	Y	Y	Y	100
5511	N	N	N	N	N	N	N	N	N	N	0

Detection Bandwidth Test - IEEE 802.11ac HT40											
Radar Type 0											
EUT Frequency: 5510MHz											
EUT 99% Power bandwidth: 36.47MHz											
Detection bandwidth limit (100% of EUT 99% Power bandwidth):											
36.47MHz Detection bandwidth (5531(FH) – 5489(FL)) : 41MHz											
Test Result : PASS											
Radar Frequency (MHz)	Trial Number / Detection										Detection Rate (%)
	1	2	3	4	5	6	7	8	9	10	
5488	N	N	N	N	N	N	N	N	N	N	0
5489(FL)	Y	Y	Y	Y	Y	Y	Y	Y	Y	Y	100
5490	Y	Y	Y	Y	Y	Y	Y	Y	Y	Y	100
5491	Y	Y	Y	Y	Y	Y	Y	Y	Y	Y	100
5492	Y	Y	Y	Y	Y	Y	Y	Y	Y	Y	100
5493	Y	Y	Y	Y	Y	Y	Y	Y	Y	Y	100
5494	Y	Y	Y	Y	Y	Y	Y	Y	Y	Y	100
5495	Y	Y	Y	Y	Y	Y	Y	Y	Y	Y	100
5496	Y	Y	Y	Y	Y	Y	Y	Y	Y	Y	100
5497	Y	Y	Y	Y	Y	Y	Y	Y	Y	Y	100
5498	Y	Y	Y	Y	Y	Y	Y	Y	Y	Y	100
5499	Y	Y	Y	Y	Y	Y	Y	Y	Y	Y	100
5500	Y	Y	Y	Y	Y	Y	Y	Y	Y	Y	100
5501	Y	Y	Y	Y	Y	Y	Y	Y	Y	Y	100
5502	Y	Y	Y	Y	Y	Y	Y	Y	Y	Y	100
5503	Y	Y	Y	Y	Y	Y	Y	Y	Y	Y	100
5504	Y	Y	Y	Y	Y	Y	Y	Y	Y	Y	100
5505	Y	Y	Y	Y	Y	Y	Y	Y	Y	Y	100
5506	Y	Y	Y	Y	Y	Y	Y	Y	Y	Y	100
5507	Y	Y	Y	Y	Y	Y	Y	Y	Y	Y	100
5508	Y	Y	Y	Y	Y	Y	Y	Y	Y	Y	100
5509	Y	Y	Y	Y	Y	Y	Y	Y	Y	Y	100
5510	Y	Y	Y	Y	Y	Y	Y	Y	Y	Y	100
5511	Y	Y	Y	Y	Y	Y	Y	Y	Y	Y	100
5512	Y	Y	Y	Y	Y	Y	Y	Y	Y	Y	100
5513	Y	Y	Y	Y	Y	Y	Y	Y	Y	Y	100
5514	Y	Y	Y	Y	Y	Y	Y	Y	Y	Y	100
5515	Y	Y	Y	Y	Y	Y	Y	Y	Y	Y	100
5516	Y	Y	Y	Y	Y	Y	Y	Y	Y	Y	100
5517	Y	Y	Y	Y	Y	Y	Y	Y	Y	Y	100
5518	Y	Y	Y	Y	Y	Y	Y	Y	Y	Y	100
5519	Y	Y	Y	Y	Y	Y	Y	Y	Y	Y	100
5520	Y	Y	Y	Y	Y	Y	Y	Y	Y	Y	100
5521	Y	Y	Y	Y	Y	Y	Y	Y	Y	Y	100
5522	Y	Y	Y	Y	Y	Y	Y	Y	Y	Y	100
5523	Y	Y	Y	Y	Y	Y	Y	Y	Y	Y	100
5524	Y	Y	Y	Y	Y	Y	Y	Y	Y	Y	100
5525	Y	Y	Y	Y	Y	Y	Y	Y	Y	Y	100
5526	Y	Y	Y	Y	Y	Y	Y	Y	Y	Y	100
5527	Y	Y	Y	Y	Y	Y	Y	Y	Y	Y	100
5528	Y	Y	Y	Y	Y	Y	Y	Y	Y	Y	100
5529	Y	Y	Y	Y	Y	Y	Y	Y	Y	Y	100
5530(FH)	Y	Y	Y	Y	Y	Y	Y	Y	Y	Y	100
5531	N	N	N	N	N	N	N	N	N	N	0

Detection Bandwidth Test - IEEE 802.11ac VHT80											
Radar Type 0											
EUT Frequency: 5530MHz											
EUT 99% Power bandwidth: 76.09MHz											
Detection bandwidth limit (100% of EUT 99% Power bandwidth): 76.09MHz											
Detection bandwidth (5570(FH) – 5490(FL)) : 80MHz											
Test Result : PASS											
Radar Frequency (MHz)	Trial Number / Detection										Detection Rate (%)
	1	2	3	4	5	6	7	8	9	10	
5489	N	N	N	N	N	N	N	N	N	N	0
5490(FL)	Y	Y	Y	Y	Y	Y	Y	Y	Y	Y	100
5491	Y	Y	Y	Y	Y	Y	Y	Y	Y	Y	100
5492	Y	Y	Y	Y	Y	Y	Y	Y	Y	Y	100
5493	Y	Y	Y	Y	Y	Y	Y	Y	Y	Y	100
5494	Y	Y	Y	Y	Y	Y	Y	Y	Y	Y	100
5495	Y	Y	Y	Y	Y	Y	Y	Y	Y	Y	100
5496	Y	Y	Y	Y	Y	Y	Y	Y	Y	Y	100
5497	Y	Y	Y	Y	Y	Y	Y	Y	Y	Y	100
5498	Y	Y	Y	Y	Y	Y	Y	Y	Y	Y	100
5499	Y	Y	Y	Y	Y	Y	Y	Y	Y	Y	100
5500	Y	Y	Y	Y	Y	Y	Y	Y	Y	Y	100
5501	Y	Y	Y	Y	Y	Y	Y	Y	Y	Y	100
5502	Y	Y	Y	Y	Y	Y	Y	Y	Y	Y	100
5503	Y	Y	Y	Y	Y	Y	Y	Y	Y	Y	100
5504	Y	Y	Y	Y	Y	Y	Y	Y	Y	Y	100
5505	Y	Y	Y	Y	Y	Y	Y	Y	Y	Y	100
5506	Y	Y	Y	Y	Y	Y	Y	Y	Y	Y	100
5507	Y	Y	Y	Y	Y	Y	Y	Y	Y	Y	100
5508	Y	Y	Y	Y	Y	Y	Y	Y	Y	Y	100
5509	Y	Y	Y	Y	Y	Y	Y	Y	Y	Y	100
5510	Y	Y	Y	Y	Y	Y	Y	Y	Y	Y	100
5511	Y	Y	Y	Y	Y	Y	Y	Y	Y	Y	100
5512	Y	Y	Y	Y	Y	Y	Y	Y	Y	Y	100
5513	Y	Y	Y	Y	Y	Y	Y	Y	Y	Y	100
5514	Y	Y	Y	Y	Y	Y	Y	Y	Y	Y	100
5515	Y	Y	Y	Y	Y	Y	Y	Y	Y	Y	100
5516	Y	Y	Y	Y	Y	Y	Y	Y	Y	Y	100
5517	Y	Y	Y	Y	Y	Y	Y	Y	Y	Y	100
5518	Y	Y	Y	Y	Y	Y	Y	Y	Y	Y	100
5519	Y	Y	Y	Y	Y	Y	Y	Y	Y	Y	100
5520	Y	Y	Y	Y	Y	Y	Y	Y	Y	Y	100
5521	Y	Y	Y	Y	Y	Y	Y	Y	Y	Y	100
5522	Y	Y	Y	Y	Y	Y	Y	Y	Y	Y	100
5523	Y	Y	Y	Y	Y	Y	Y	Y	Y	Y	100
5524	Y	Y	Y	Y	Y	Y	Y	Y	Y	Y	100
5525	Y	Y	Y	Y	Y	Y	Y	Y	Y	Y	100
5526	Y	Y	Y	Y	Y	Y	Y	Y	Y	Y	100
5527	Y	Y	Y	Y	Y	Y	Y	Y	Y	Y	100
5528	Y	Y	Y	Y	Y	Y	Y	Y	Y	Y	100
5529	Y	Y	Y	Y	Y	Y	Y	Y	Y	Y	100
5530	Y	Y	Y	Y	Y	Y	Y	Y	Y	Y	100
5531	Y	Y	Y	Y	Y	Y	Y	Y	Y	Y	100
5532	Y	Y	Y	Y	Y	Y	Y	Y	Y	Y	100
5533	Y	Y	Y	Y	Y	Y	Y	Y	Y	Y	100
5534	Y	Y	Y	Y	Y	Y	Y	Y	Y	Y	100

5535	Y	Y	Y	Y	Y	Y	Y	Y	Y	Y	100
5536	Y	Y	Y	Y	Y	Y	Y	Y	Y	Y	100
5537	Y	Y	Y	Y	Y	Y	Y	Y	Y	Y	100
5538	Y	Y	Y	Y	Y	Y	Y	Y	Y	Y	100
5539	Y	Y	Y	Y	Y	Y	Y	Y	Y	Y	100
5540	Y	Y	Y	Y	Y	Y	Y	Y	Y	Y	100
5541	Y	Y	Y	Y	Y	Y	Y	Y	Y	Y	100
5542	Y	Y	Y	Y	Y	Y	Y	Y	Y	Y	100
5543	Y	Y	Y	Y	Y	Y	Y	Y	Y	Y	100
5544	Y	Y	Y	Y	Y	Y	Y	Y	Y	Y	100
5545	Y	Y	Y	Y	Y	Y	Y	Y	Y	Y	100
5546	Y	Y	Y	Y	Y	Y	Y	Y	Y	Y	100
5547	Y	Y	Y	Y	Y	Y	Y	Y	Y	Y	100
5548	Y	Y	Y	Y	Y	Y	Y	Y	Y	Y	100
5549	Y	Y	Y	Y	Y	Y	Y	Y	Y	Y	100
5550	Y	Y	Y	Y	Y	Y	Y	Y	Y	Y	100
5551	Y	Y	Y	Y	Y	Y	Y	Y	Y	Y	100
5552	Y	Y	Y	Y	Y	Y	Y	Y	Y	Y	100
5553	Y	Y	Y	Y	Y	Y	Y	Y	Y	Y	100
5554	Y	Y	Y	Y	Y	Y	Y	Y	Y	Y	100
5555	Y	Y	Y	Y	Y	Y	Y	Y	Y	Y	100
5556	Y	Y	Y	Y	Y	Y	Y	Y	Y	Y	100
5557	Y	Y	Y	Y	Y	Y	Y	Y	Y	Y	100
5558	Y	Y	Y	Y	Y	Y	Y	Y	Y	Y	100
5559	Y	Y	Y	Y	Y	Y	Y	Y	Y	Y	100
5560	Y	Y	Y	Y	Y	Y	Y	Y	Y	Y	100
5561	Y	Y	Y	Y	Y	Y	Y	Y	Y	Y	100
5562	Y	Y	Y	Y	Y	Y	Y	Y	Y	Y	100
5563	Y	Y	Y	Y	Y	Y	Y	Y	Y	Y	100
5564	Y	Y	Y	Y	Y	Y	Y	Y	Y	Y	100
5565	Y	Y	Y	Y	Y	Y	Y	Y	Y	Y	100
5566	Y	Y	Y	Y	Y	Y	Y	Y	Y	Y	100
5567	Y	Y	Y	Y	Y	Y	Y	Y	Y	Y	100
5568	Y	Y	Y	Y	Y	Y	Y	Y	Y	Y	100
5569	Y	Y	Y	Y	Y	Y	Y	Y	Y	Y	100
5570(FH)	Y	Y	Y	Y	Y	Y	Y	Y	Y	Y	100
5571	N	N	N	N	N	N	N	N	N	N	0

6.2.3 Channel Availability Check Time

If the EUT successfully detected the radar burst, it should be observed as the EUT has no transmissions occurred until the EUT starts transmitting on another channel.

Timing of Radar Signal	Observation	
	EUT	Spectrum Analyzer
Within 1 to 6 second	Detected	No transmissions
Within 54 to 60 second	Detected	No transmissions

Initial Channel Availability Check Time

Channel Availability Check

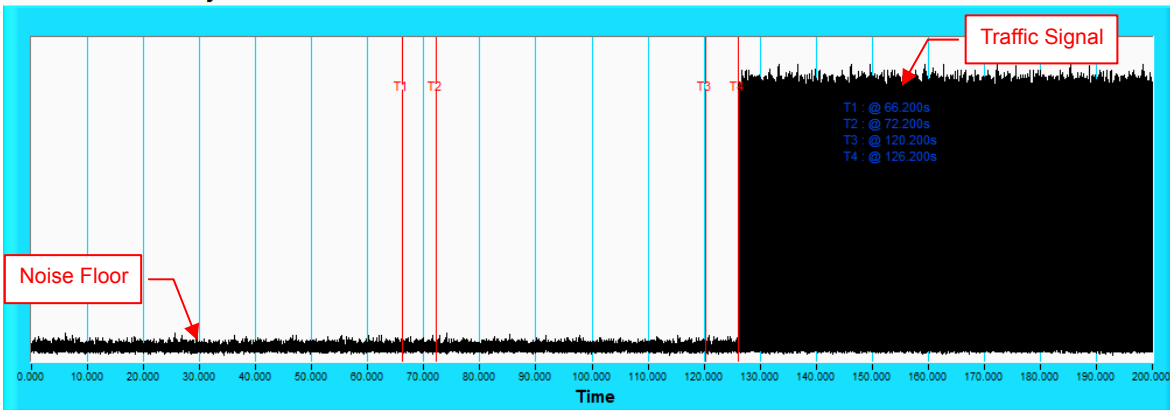

NOTE: T1 denotes the end of power-up time period is 46.8 second. T4 denotes the end of Channel Availability Check time is 106.8 second. Channel Availability Check time is equal to (T4 – T1) 60 seconds.

Radar Burst at the Beginning of the Channel Availability Check Time

Channel Availability Check

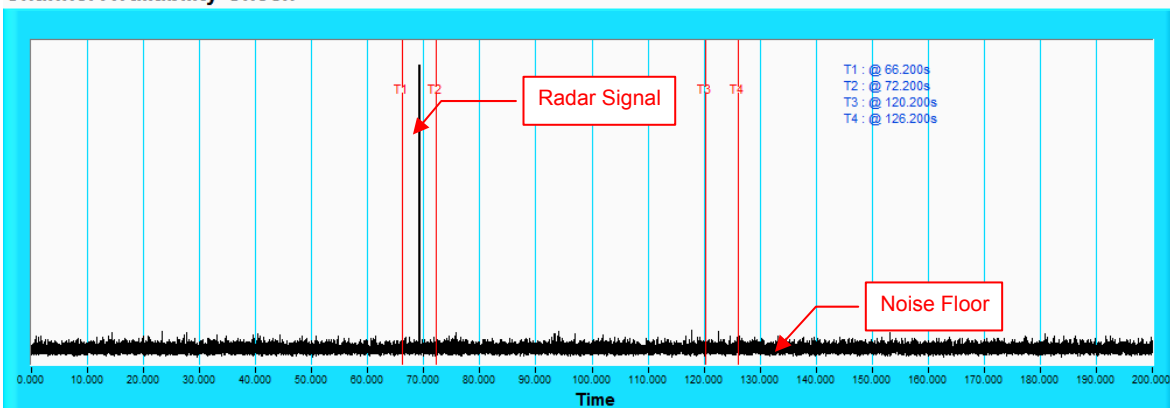

NOTE: T1 denotes the end of power up time period is 46.8 second. T2 denotes 52.8 second, the radar burst was commenced within a 6 second window starting from the end of power-up sequence. T4 denotes the 106.8 second.

Radar Burst at the End of the Channel Availability Check Channel Availability Check

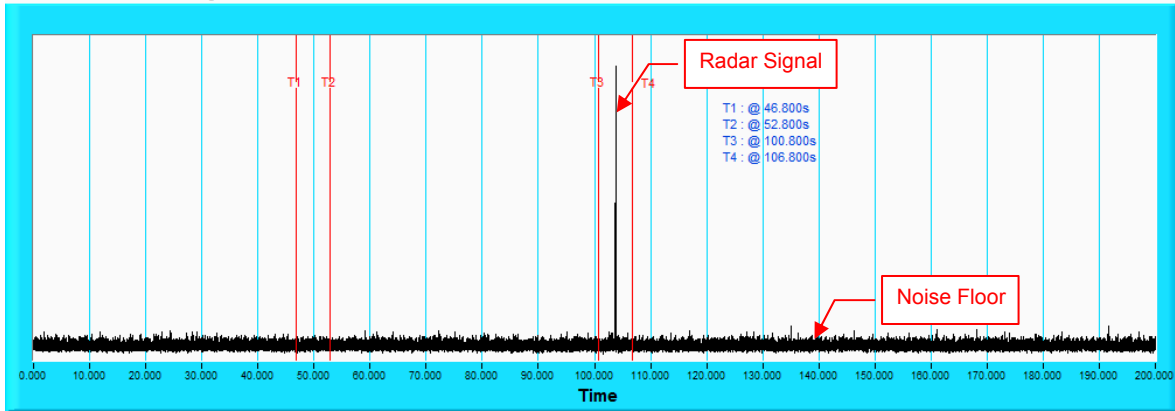

NOTE: T1 denotes the end of power up time period is 46.8 second. T3 denotes 100.8 second and radar burst was commenced within 54th second to 60th second window starting from the end of power-up sequence. T4 denotes the 106.8 second.

6.2.4 Channel Closing Transmission and Channel Move Time

Wireless Traffic Loading IEEE 802.11an HT20

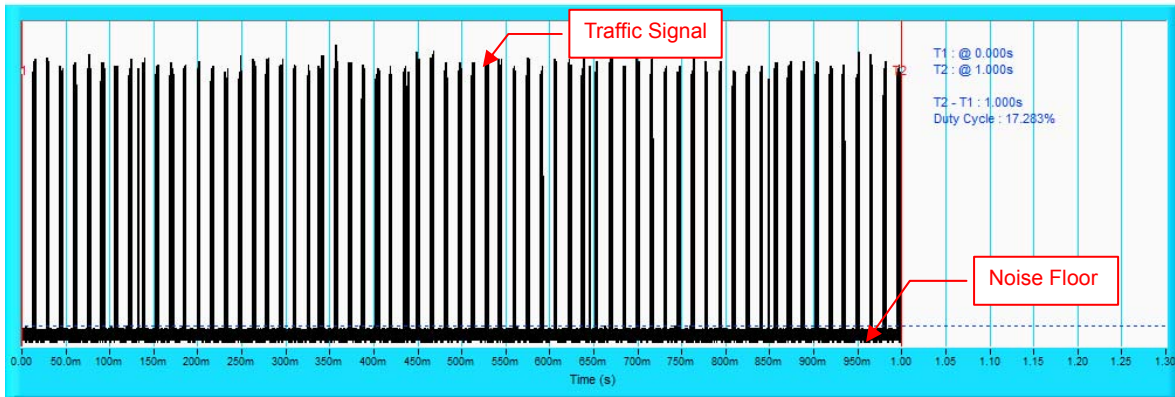

IEEE 802.11an HT40

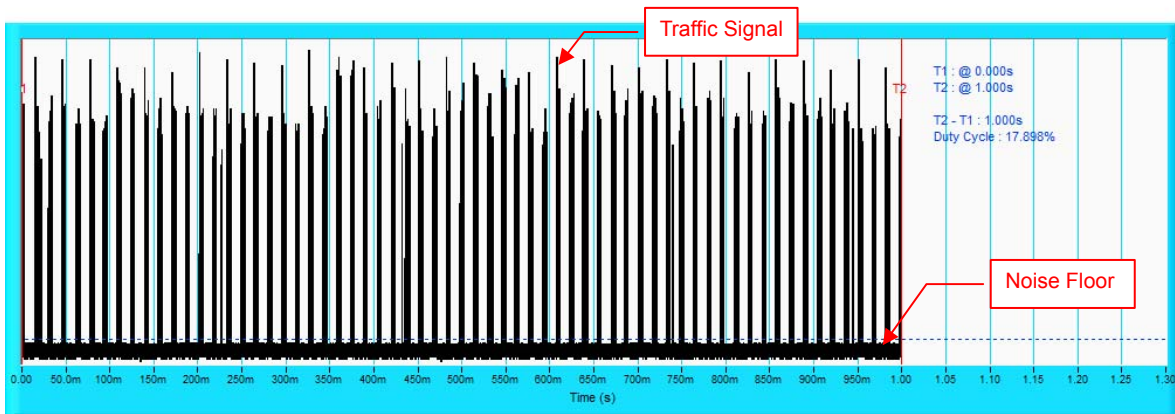

IEEE 802.11ac VHT80

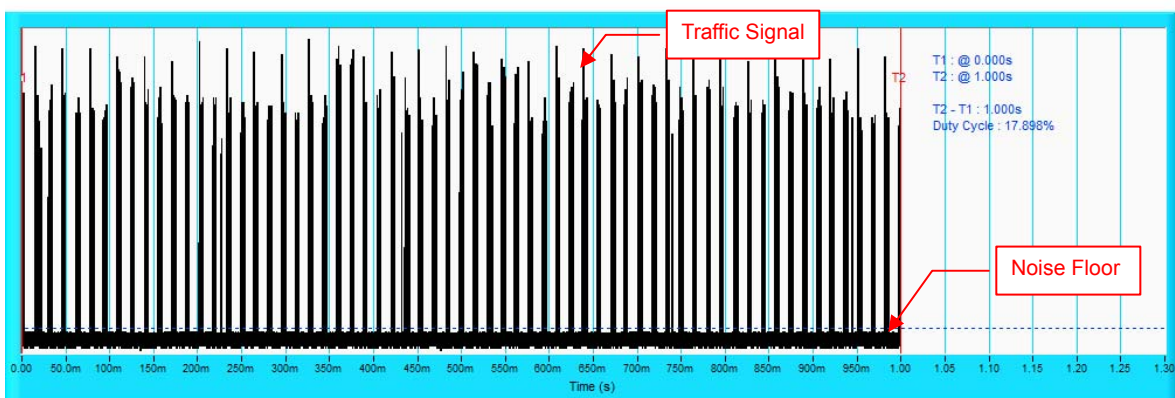

IEEE 802.11an HT20
Table 1: Short Pulse Radar Test Waveforms.

Radar Type	Pulse Width (μsec)	PRI (μsec)	Number of Pulses	Number of Trials(Times)	Percentage of Successful Detection (%)
1	1	Test A: 15 unique PRI values randomly selected from the list of 23 PRI values in Table 5a	Roundup $\left\{ \begin{array}{l} \left(\frac{1}{360} \right) \cdot \\ \left(\frac{19 \cdot 10^6}{PRI_{\mu sec}} \right) \end{array} \right\}$	30	100
		Test B: 15 unique PRI values randomly selected within the range of 518-3066 μ sec, with a minimum increment of 1 μ sec, excluding PRI values selected in Test A			
2	1-5	150-230	23-29	30	90
3	6-10	200-500	16-18	30	93.3
4	11-20	200-500	12-16	30	86.7
Aggregate (Radar Types 1-4)				120	92.5

Table 2: Long Pulse Radar Test Waveform

Radar Type	Pulse Width (μsec)	Chirp Width (MHz)	PRI (μsec)	Number of Pulses per Burst	Number of Bursts	Number of Trials(Times)	Percentage of Successful Detection (%)
5	50-100	5-20	1000-2000	1-3	8-20	30	86.7

Table 3: Frequency Hopping Radar Test Waveform

Radar Type	Pulse Width (μsec)	PRI (μsec)	Pulses per Hop	Hopping Rate (kHz)	Hopping Sequence Length (msec)	Number of Trials(Times)	Percentage of Successful Detection (%)
6	1	333	9	0.333	300	30	100

The Detailed Radar pattern and Statistical Performance showed in Annex A.

IEEE 802.11an HT40
Table 1: Short Pulse Radar Test Waveforms.

Radar Type	Pulse Width (μsec)	PRI (μsec)	Number of Pulses	Number of Trials(Times)	Percentage of Successful Detection (%)
1	1	Test A: 15 unique PRI values randomly selected from the list of 23 PRI values in Table 5a	Roundup $\left\{ \begin{array}{l} \left(\frac{1}{360} \right) \cdot \\ \left(\frac{19 \cdot 10^6}{PRI_{\mu sec}} \right) \end{array} \right\}$	30	100
		Test B: 15 unique PRI values randomly selected within the range of 518-3066 μ sec, with a minimum increment of 1 μ sec, excluding PRI values selected in Test A			
2	1-5	150-230	23-29	30	80
3	6-10	200-500	16-18	30	93.3
4	11-20	200-500	12-16	30	93.3
Aggregate (Radar Types 1-4)				120	91.65

Table 2: Long Pulse Radar Test Waveform

Radar Type	Pulse Width (μsec)	Chirp Width (MHz)	PRI (μsec)	Number of Pulses per Burst	Number of Bursts	Number of Trials(Times)	Percentage of Successful Detection (%)
5	50-100	5-20	1000-2000	1-3	8-20	30	100

Table 3: Frequency Hopping Radar Test Waveform

Radar Type	Pulse Width (μsec)	PRI (μsec)	Pulses per Hop	Hopping Rate (kHz)	Hopping Sequence Length (msec)	Number of Trials(Times)	Percentage of Successful Detection (%)
6	1	333	9	0.333	300	30	100

The Detailed Radar pattern and Statistical Performance showed in Annex A.

IEEE 802.11ac VHT80
Table 1: Short Pulse Radar Test Waveforms.

Radar Type	Pulse Width (μsec)	PRI (μsec)	Number of Pulses	Number of Trials(Times)	Percentage of Successful Detection (%)
1	1	Test A: 15 unique PRI values randomly selected from the list of 23 PRI values in Table 5a	$\text{Roundup} \left\{ \begin{array}{l} \left(\frac{1}{360} \right) \cdot \\ \left(\frac{19 \cdot 10^6}{\text{PRI}_{\mu\text{sec}}} \right) \end{array} \right\}$	30	100
		Test B: 15 unique PRI values randomly selected within the range of 518-3066 μ sec, with a minimum increment of 1 μ sec, excluding PRI values selected in Test A			
2	1-5	150-230	23-29	30	80
3	6-10	200-500	16-18	30	93.3
4	11-20	200-500	12-16	30	76.7
Aggregate (Radar Types 1-4)				120	87.5

Table 2: Long Pulse Radar Test Waveform

Radar Type	Pulse Width (μsec)	Chirp Width (MHz)	PRI (μsec)	Number of Pulses per Burst	Number of Bursts	Number of Trials(Times)	Percentage of Successful Detection (%)
5	50-100	5-20	1000-2000	1-3	8-20	30	90

Table 3: Frequency Hopping Radar Test Waveform

Radar Type	Pulse Width (μsec)	PRI (μsec)	Pulses per Hop	Hopping Rate (kHz)	Hopping Sequence Length (msec)	Number of Trials(Times)	Percentage of Successful Detection (%)
6	1	333	9	0.333	300	30	96.7

The Detailed Radar pattern and Statistical Performance showed in Annex A.

Radar signal 0

IEEE 802.11an HT20

Channel Closing Transmission Time & Channel Move Time

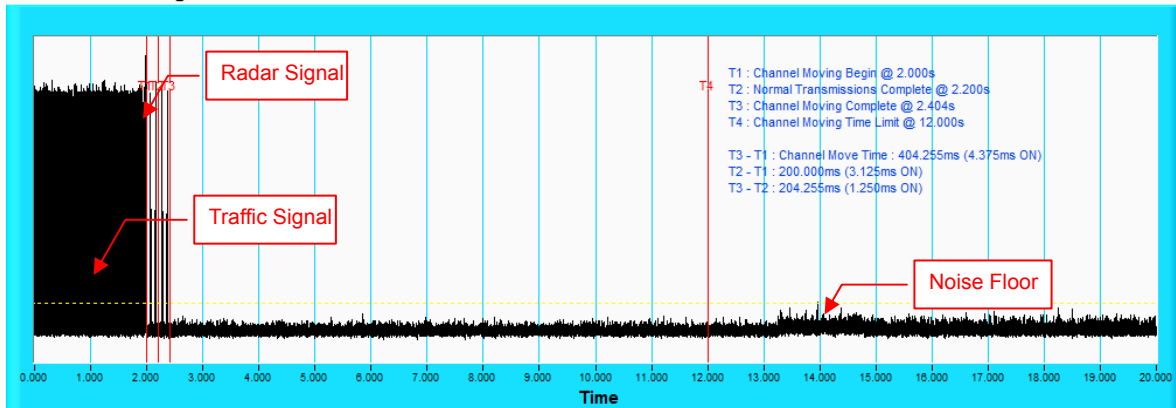

NOTE: T1 denotes the start of Channel Move Time upon the end of the last Radar burst. T2 denotes the data transmission time of 200ms from T1. T3 denotes the end of Channel Move Time. T4 denotes the 10 second from T1 to observe the aggregate duration of transmissions.

Channel Closing Transmission Time & Channel Move Time

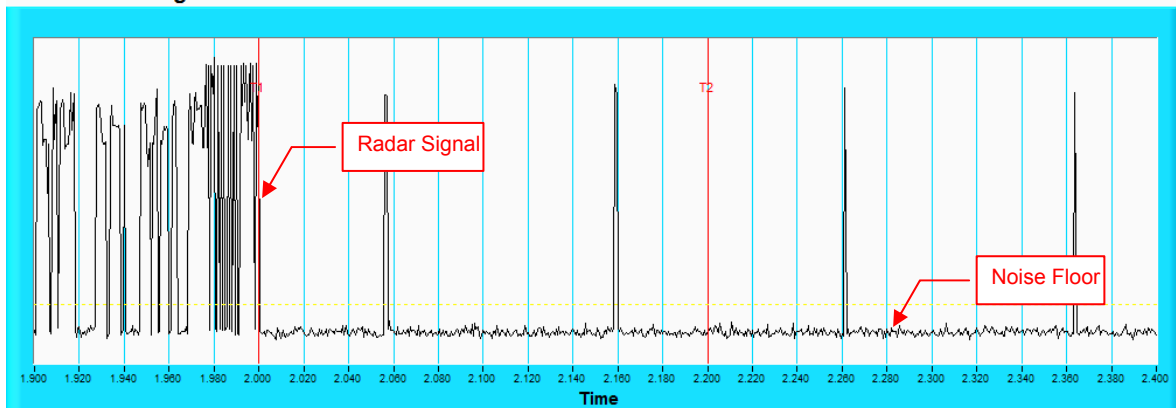

NOTE: Room-in of the first 500ms after radar signal applied.

Radar signal 1

IEEE 802.11an HT20

Channel Closing Transmission Time & Channel Move Time

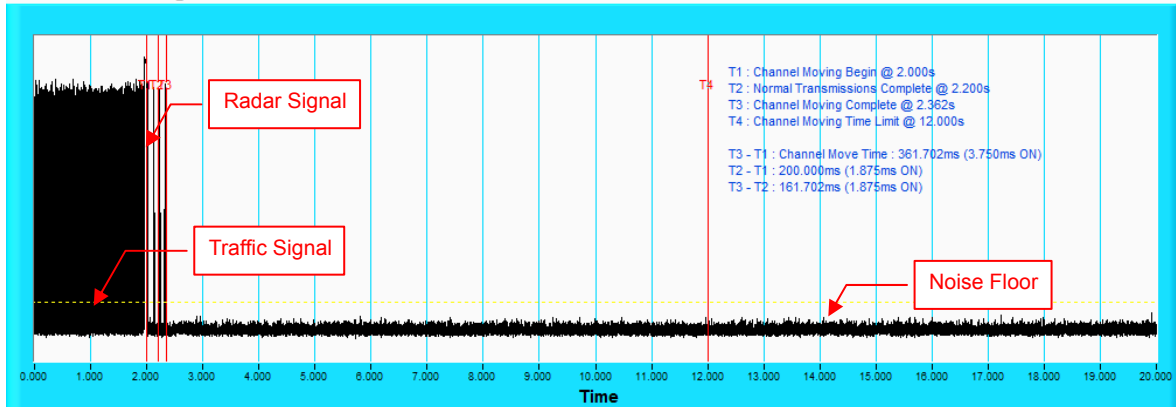

NOTE: T1 denotes the start of Channel Move Time upon the end of the last Radar burst. T2 denotes the data transmission time of 200ms from T1. T3 denotes the end of Channel Move Time. T4 denotes the 10 second from T1 to observe the aggregate duration of transmissions.

Channel Closing Transmission Time & Channel Move Time

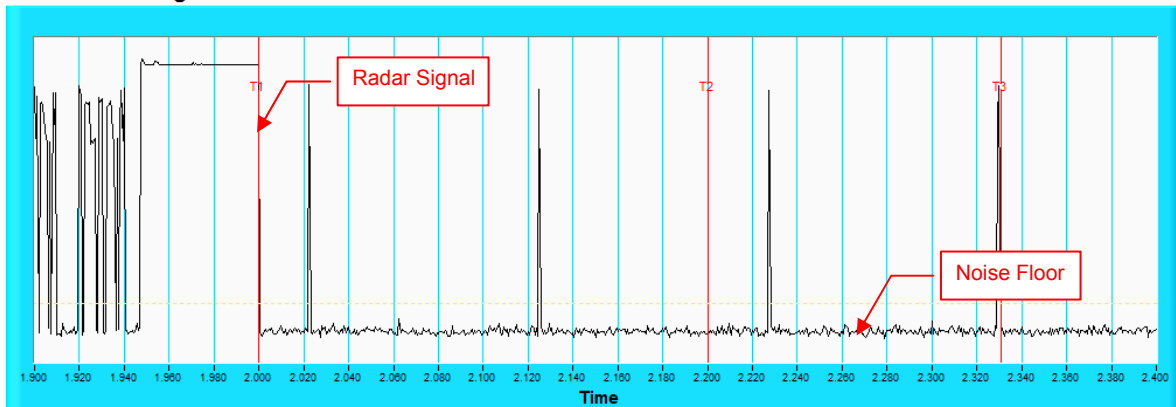

NOTE: Room-in of the first 500ms after radar signal applied.

Radar signal 2

IEEE 802.11an HT20

Channel Closing Transmission Time & Channel Move Time

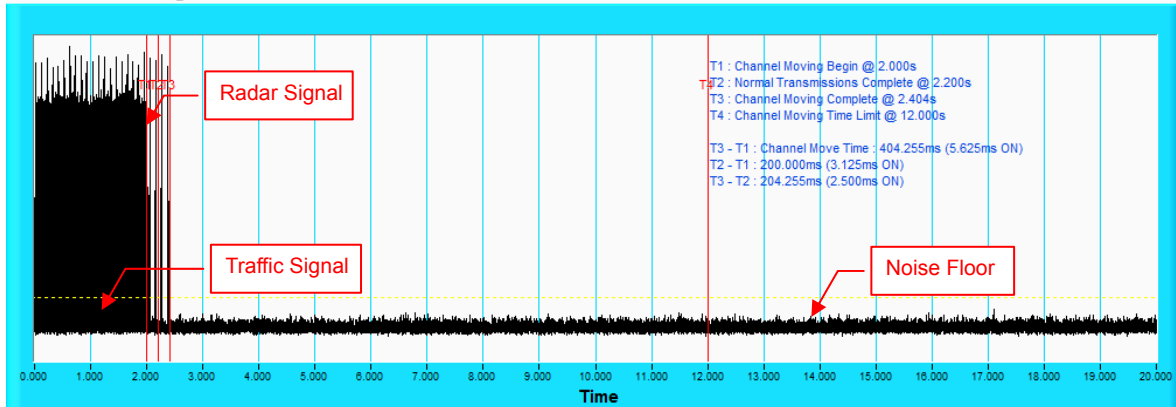

NOTE: T1 denotes the start of Channel Move Time upon the end of the last Radar burst. T2 denotes the data transmission time of 200ms from T1. T3 denotes the end of Channel Move Time. T4 denotes the 10 second from T1 to observe the aggregate duration of transmissions.

Channel Closing Transmission Time & Channel Move Time

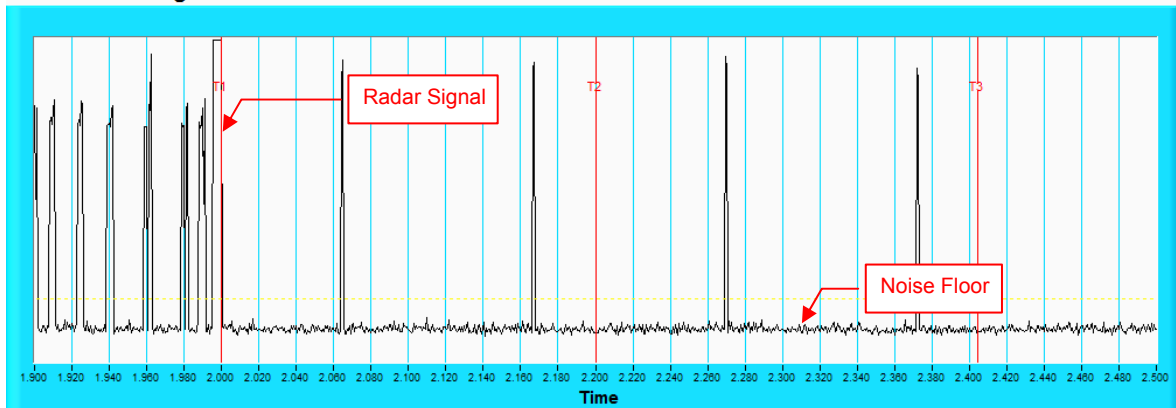

NOTE: Room-in of the first 500ms after radar signal applied.

Radar signal 3

IEEE 802.11an HT20

Channel Closing Transmission Time & Channel Move Time

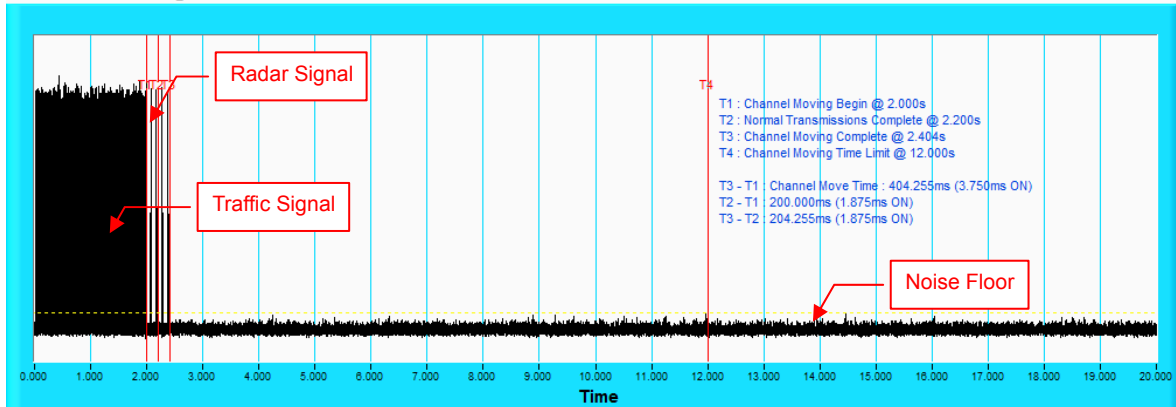

NOTE: T1 denotes the start of Channel Move Time upon the end of the last Radar burst. T2 denotes the data transmission time of 200ms from T1. T3 denotes the end of Channel Move Time. T4 denotes the 10 second from T1 to observe the aggregate duration of transmissions.

Channel Closing Transmission Time & Channel Move Time

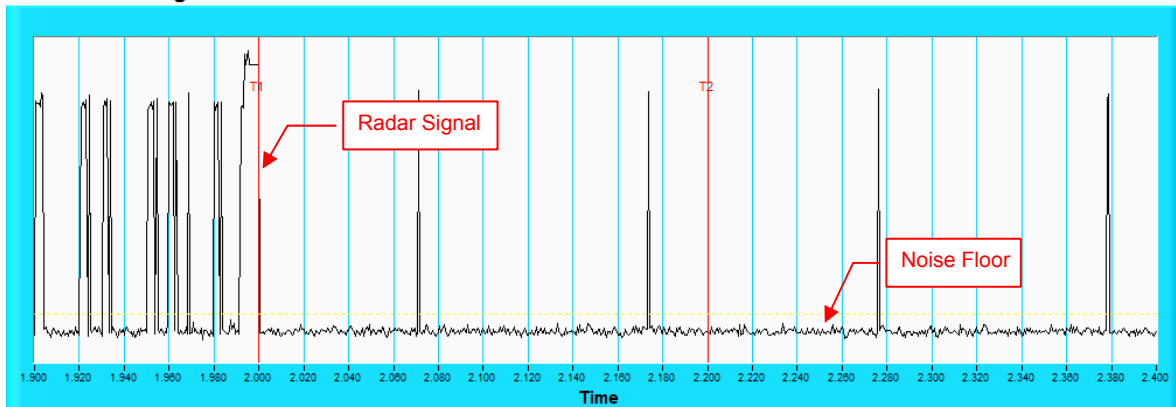

NOTE: Room-in of the first 500ms after radar signal applied.

Radar signal 4

IEEE 802.11an HT20

Channel Closing Transmission Time & Channel Move Time

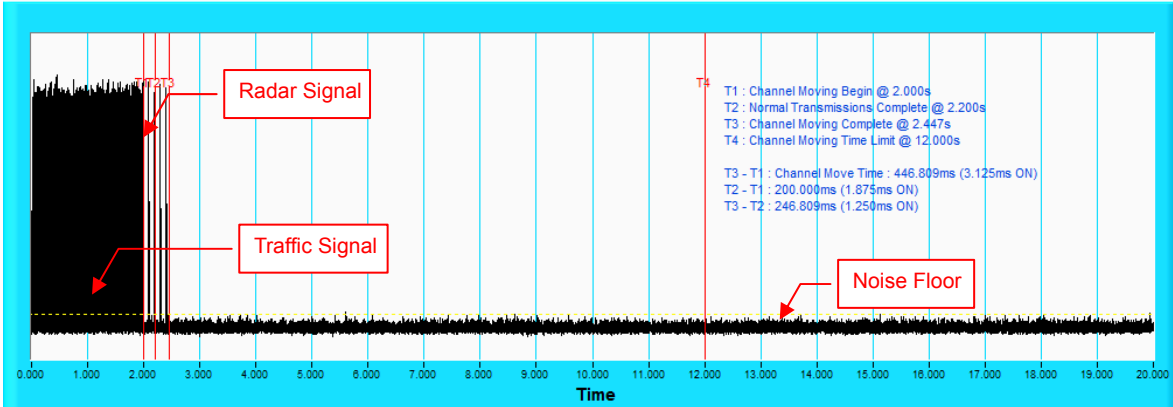

NOTE: T1 denotes the start of Channel Move Time upon the end of the last Radar burst. T2 denotes the data transmission time of 200ms from T1. T3 denotes the end of Channel Move Time. T4 denotes the 10 second from T1 to observe the aggregate duration of transmissions.

Channel Closing Transmission Time & Channel Move Time

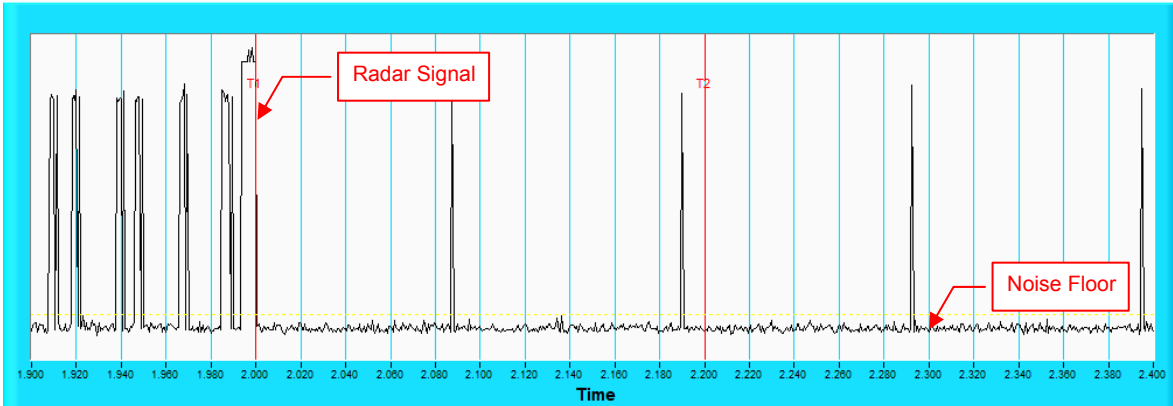

NOTE: Room-in of the first 500ms after radar signal applied.

6.2.5 Non- Occupancy Period

Associate test:

During the 30 minutes observation time, UUT did not make any transmissions on a channel after a radar signal was detected on that channel by either the Channel Availability Check or the In-Service Monitoring.

- 1) EUT (Client) links with master on 5500MHz.

Waveform of EUT links up with Master

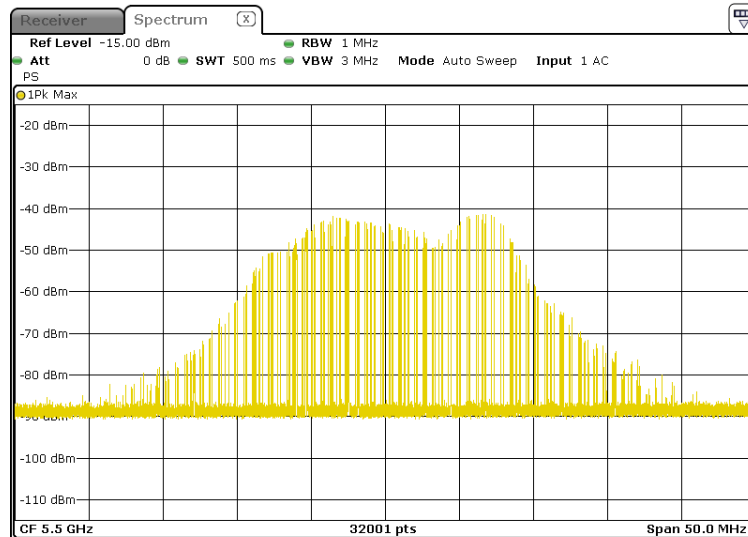

- 2) Client plays specified files via master.

Waveform of transmission

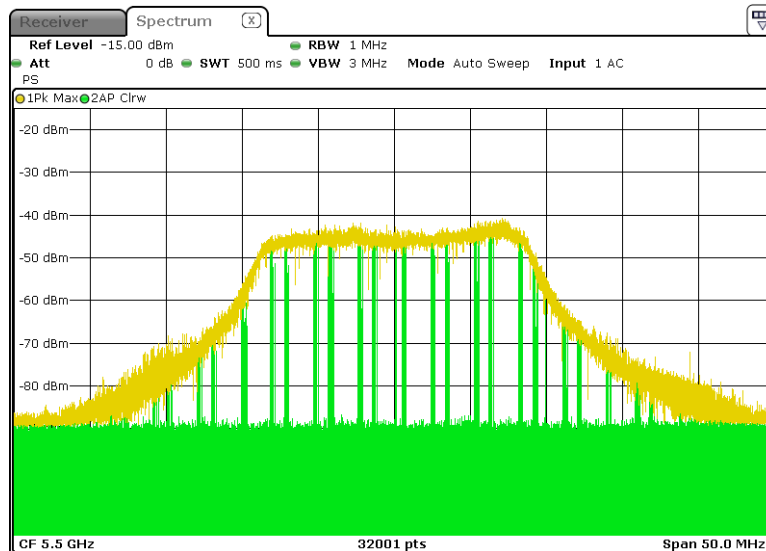

3) Radar signal is applied to the Master device and WiFi traffic signal stop immediately.

Radar 0

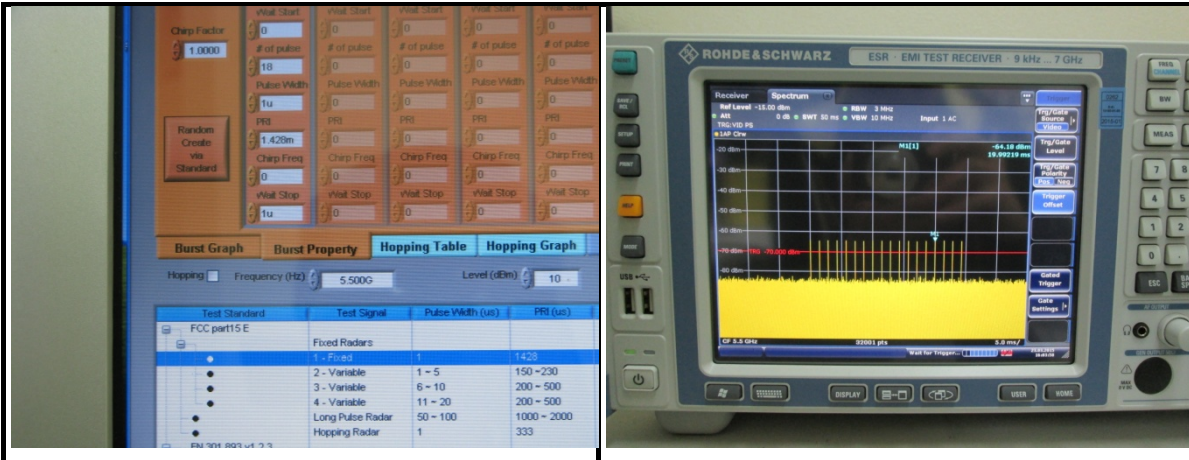

Radar 1

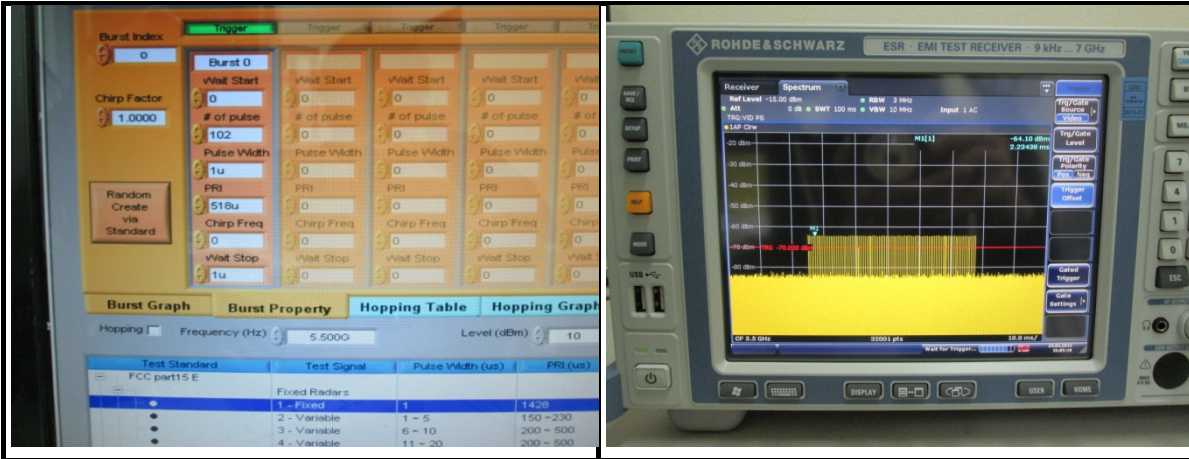

Radar 2



Radar 3

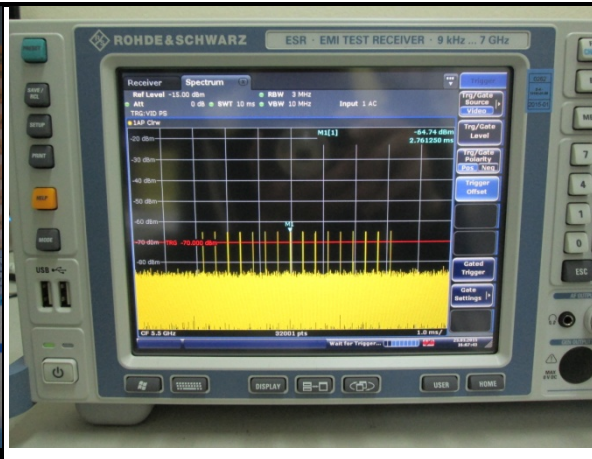

Radar 4

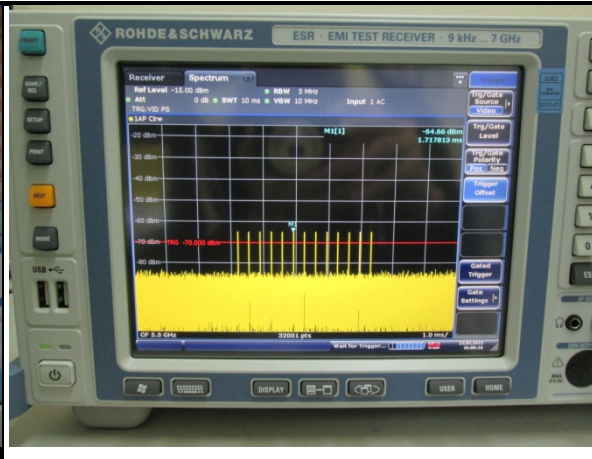
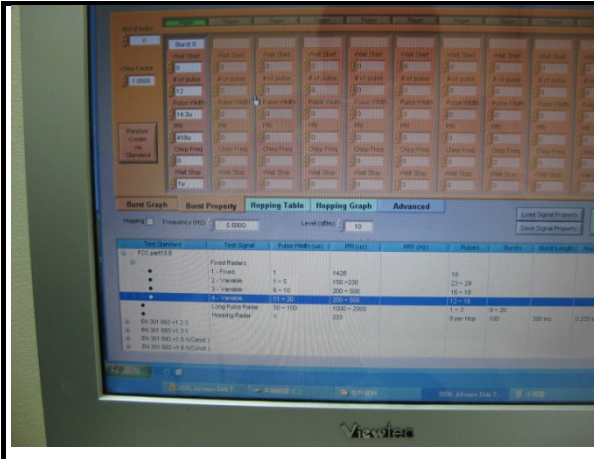

Radar 5

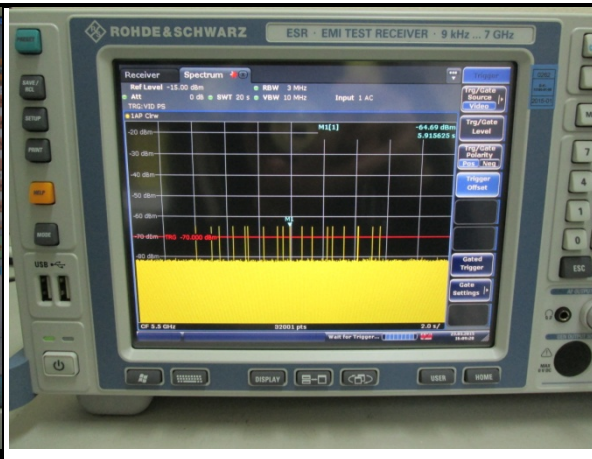
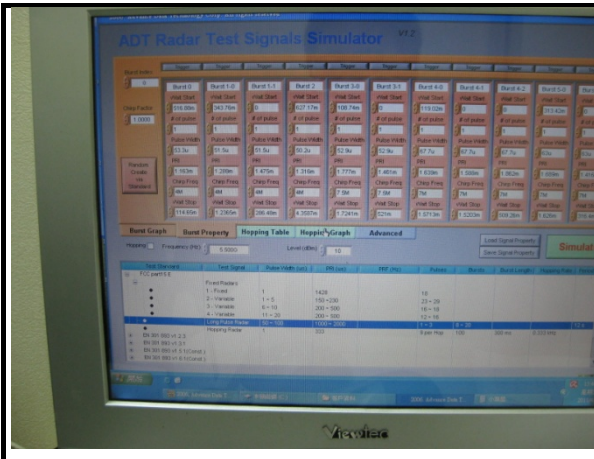

Radar 6



4) 5510MHz has been monitored in 30 minutes period. In this period, no any transmission occurs.

Plot of 30minutes period

802.11an HT20

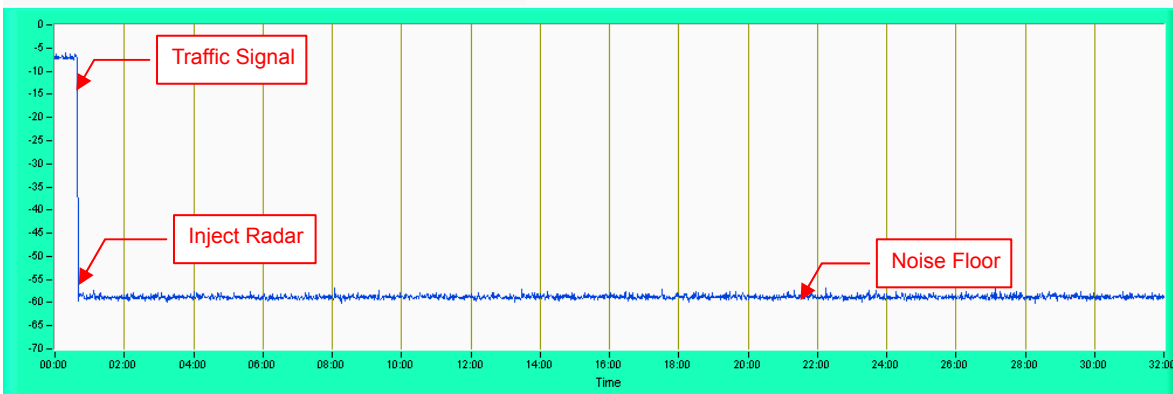

NOTE: Test setup are shown on Test setup photo.pdf

6.2.6 Uniform Spreading

The intention of the uniform spreading is to provide, on aggregate, a uniform loading of the spectrum. The EUT randomly select next output channel without any bias or fixed pattern, so that all channels in DFS bands (5250 to 5350MHz and 5470 to 5725 MHz) will be used equally.

6.2.7 Transmit Power Control (TPC)

TPC	E.I.R.P	FCC 15.407(h)(1)
√	> 500mW	The TPC mechanism is required for system with an E.I.R.P. of above 500mW
	< 500mW	The TPC mechanism is not required for system with an E.I.R.P. of less 500mW



7. Information on The Testing Laboratories

We, Bureau Veritas Consumer Products Services (H.K.) Ltd., Taoyuan Branch, were founded in 1988 to provide our best service in EMC, Radio, Telecom and Safety consultation. Our laboratories are accredited and approved according to ISO/IEC 17025.

If you have any comments, please feel free to contact us at the following:

Linko EMC/RF Lab:

Tel: 886-2-26052180

Fax: 886-2-26051924

Hsin Chu EMC/RF/Telecom Lab:

Tel: 886-3-5935343

Fax: 886-3-5935342

Hwa Ya EMC/RF/Safety Lab:

Tel: 886-3-3183232

Fax: 886-3-3270892

Email: service.adt@tw.bureauveritas.com

Web Site: www.bureauveritas-adt.com

The address and road map of all our labs can be found in our web site also.

--- END ---

Annex-A

Annex A.1: The Detailed Radar pattern and Statistical Performance

IEEE 802.11an HT20

Type 1 Radar Statistical Performances				
Trial #	Pulses per Burst	Pulse Width (s)	PRI (s)	Detection
1	102	1.0u	518.0u	Yes
2	99	1.0u	538.0u	Yes
3	95	1.0u	558.0u	Yes
4	92	1.0u	578.0u	Yes
5	89	1.0u	598.0u	Yes
6	83	1.0u	638.0u	Yes
7	78	1.0u	678.0u	Yes
8	76	1.0u	698.0u	Yes
9	74	1.0u	718.0u	Yes
10	72	1.0u	738.0u	Yes
11	67	1.0u	798.0u	Yes
12	65	1.0u	818.0u	Yes
13	62	1.0u	858.0u	Yes
14	59	1.0u	898.0u	Yes
15	57	1.0u	938.0u	Yes
16	98	1.0u	539.0u	Yes
17	89	1.0u	599.0u	Yes
18	83	1.0u	639.0u	Yes
19	78	1.0u	679.0u	Yes
20	98	1.0u	541.0u	Yes
21	88	1.0u	601.0u	Yes
22	98	1.0u	543.0u	Yes
23	88	1.0u	603.0u	Yes
24	97	1.0u	545.0u	Yes
25	88	1.0u	605.0u	Yes
26	80	1.0u	665.0u	Yes
27	75	1.0u	707.0u	Yes
28	69	1.0u	767.0u	Yes
29	64	1.0u	827.0u	Yes
30	90	1.0u	593.0u	Yes
Detection Rate: 100.0 %				

Type 2 Radar Statistical Performances				
Trial #	Pulses per Burst	Pulse Width (s)	PRI (s)	Detection
1	29	4.8u	194.0u	Yes
2	29	1.1u	168.0u	Yes
3	25	2.1u	162.0u	Yes
4	28	3.2u	179.0u	Yes
5	28	1.1u	152.0u	Yes
6	26	4.0u	213.0u	Yes
7	23	1.6u	230.0u	Yes
8	28	4.0u	213.0u	Yes
9	27	1.5u	184.0u	No
10	27	1.0u	181.0u	Yes
11	29	1.7u	196.0u	Yes
12	25	1.9u	196.0u	Yes
13	27	4.4u	223.0u	Yes
14	24	2.6u	200.0u	Yes
15	28	2.6u	175.0u	Yes
16	27	1.3u	182.0u	Yes
17	27	1.6u	154.0u	Yes
18	23	1.9u	185.0u	Yes
19	28	2.4u	207.0u	Yes
20	23	1.0u	180.0u	Yes
21	24	1.2u	201.0u	Yes
22	25	1.4u	176.0u	Yes
23	27	3.5u	209.0u	Yes
24	27	1.9u	223.0u	Yes
25	26	2.5u	188.0u	Yes
26	24	4.5u	186.0u	No
27	25	2.7u	226.0u	No
28	24	3.9u	218.0u	Yes
29	23	3.7u	199.0u	Yes
30	28	1.5u	228.0u	Yes
			Detection Rate: 90.0 %	

Type 3 Radar Statistical Performances				
Trial #	Pulses per Burst	Pulse Width (s)	PRI (s)	Detection
1	16	10.0u	402.0u	Yes
2	16	7.7u	239.0u	Yes
3	17	6.2u	255.0u	Yes
4	16	9.8u	484.0u	Yes
5	16	9.6u	225.0u	Yes
6	17	7.2u	255.0u	Yes
7	16	6.7u	419.0u	Yes
8	18	7.2u	479.0u	Yes
9	18	9.3u	289.0u	Yes
10	16	9.2u	246.0u	Yes
11	16	6.7u	338.0u	Yes
12	17	7.2u	400.0u	Yes
13	17	7.3u	496.0u	Yes
14	18	7.1u	380.0u	Yes
15	17	9.8u	201.0u	Yes
16	17	8.6u	380.0u	Yes
17	17	8.7u	467.0u	Yes
18	18	6.7u	218.0u	Yes
19	17	7.9u	414.0u	Yes
20	18	7.9u	464.0u	Yes
21	16	7.1u	490.0u	Yes
22	17	9.8u	480.0u	Yes
23	16	7.1u	236.0u	Yes
24	17	7.5u	283.0u	Yes
25	16	8.5u	482.0u	Yes
26	17	7.9u	252.0u	No
27	16	8.7u	205.0u	Yes
28	17	8.6u	432.0u	No
29	17	9.7u	225.0u	Yes
30	17	6.9u	310.0u	Yes
			Detection Rate: 93.3 %	

Type 4 Radar Statistical Performances				
Trial #	Pulses per Burst	Pulse Width (s)	PRI (s)	Detection
1	13	14.8u	419.0u	Yes
2	13	12.4u	334.0u	Yes
3	13	12.7u	226.0u	Yes
4	15	15.3u	375.0u	Yes
5	14	19.6u	245.0u	No
6	15	13.9u	452.0u	Yes
7	15	17.2u	358.0u	Yes
8	16	13.8u	373.0u	Yes
9	13	18.3u	365.0u	Yes
10	13	13.9u	259.0u	Yes
11	13	16.4u	275.0u	Yes
12	15	15.0u	244.0u	Yes
13	15	12.3u	339.0u	Yes
14	16	15.5u	400.0u	Yes
15	14	12.6u	369.0u	Yes
16	13	11.2u	469.0u	Yes
17	12	11.1u	448.0u	Yes
18	15	19.0u	453.0u	Yes
19	16	14.3u	357.0u	Yes
20	15	17.6u	434.0u	Yes
21	16	17.0u	463.0u	Yes
22	14	18.2u	431.0u	Yes
23	13	12.6u	232.0u	No
24	13	11.2u	283.0u	Yes
25	12	14.0u	272.0u	Yes
26	15	11.8u	297.0u	Yes
27	13	18.0u	232.0u	Yes
28	13	17.7u	313.0u	No
29	13	16.7u	282.0u	No
30	16	13.6u	267.0u	Yes
			Detection Rate: 86.7 %	

Type 5 Radar Statistical Performances		
Trial #	Test Signal Name	Detection
1	LP_Signal_01	Yes
2	LP_Signal_02	Yes
3	LP_Signal_03	Yes
4	LP_Signal_04	Yes
5	LP_Signal_05	Yes
6	LP_Signal_06	Yes
7	LP_Signal_07	Yes
8	LP_Signal_08	Yes
9	LP_Signal_09	Yes
10	LP_Signal_10	Yes
11	LP_Signal_11	Yes
12	LP_Signal_12	Yes
13	LP_Signal_13	No
14	LP_Signal_14	No
15	LP_Signal_15	No
16	LP_Signal_16	No
17	LP_Signal_17	Yes
18	LP_Signal_18	Yes
19	LP_Signal_19	Yes
20	LP_Signal_20	Yes
21	LP_Signal_21	Yes
22	LP_Signal_22	Yes
23	LP_Signal_23	Yes
24	LP_Signal_24	Yes
25	LP_Signal_25	Yes
26	LP_Signal_26	Yes
27	LP_Signal_27	Yes
28	LP_Signal_28	Yes
29	LP_Signal_29	Yes
30	LP_Signal_30	Yes
		Detection Rate: 86.7 %

Long Pulse Radar Test Signal						
Test Signal Name: LP_Signal_01						
Number of Bursts in Trial: 9						
Chrip Center Frequency: 5492MHz						
Burst	Pulses per Burst	Chrip (Hz)	Pulse Width (s)	Pulse 1 to 2 Spacing (s)	Pulse 2 to 3 Spacing (s)	Start Location (s)
1	2	9M	70.7u	1.655m	-	748.6m
2	1	7M	61.6u	-	-	368.1m
3	3	7M	80.1u	1.417m	1.424m	965.4m
4	2	6M	62.7u	1.219m	-	113.2m
5	3	5M	66.2u	949.8u	1.859m	1.277
6	1	17M	68.1u	-	-	663.1m
7	1	10M	99.3u	-	-	907.6m
8	1	9M	74.9u	-	-	1.254
9	3	16M	83.5u	1.200m	1.643m	69.81m

Long Pulse Radar Test Signal						
Test Signal Name: LP_Signal_02						
Number of Bursts in Trial: 19						
Chrip Center Frequency: 5493MHz						
Burst	Pulses per Burst	Chrip (Hz)	Pulse Width (s)	Pulse 1 to 2 Spacing (s)	Pulse 2 to 3 Spacing (s)	Start Location (s)
1	2	11M	98.7u	1.382m	-	330.9m
2	1	6M	52.1u	-	-	550.8m
3	3	7M	74.7u	956.3u	1.574m	291.7m
4	2	12M	66.1u	1.877m	-	299.0m
5	2	18M	83.2u	1.178m	-	477.2m
6	1	19M	64.3u	-	-	159.1m
7	2	5M	99.3u	1.474m	-	29.54m
8	1	20M	72.2u	-	-	518.6m
9	3	12M	95.9u	1.812m	1.075m	464.4m
10	2	11M	75.2u	925.8u	-	416.8m
11	3	17M	55.6u	1.547m	1.215m	552.6m
12	2	9M	69.5u	1.404m	-	180.7m
13	2	19M	69.6u	1.384m	-	434.8m

14	1	9M	68.4u	-	-	390.5m
15	1	13M	96.0u	-	-	309.1m
16	3	12M	84.9u	1.364m	1.686m	145.8m
17	2	17M	59.4u	1.591m	-	16.74m
18	3	8M	70.8u	1.584m	1.012m	270.6m
19	1	16M	51.6u	-	-	541.3m

Long Pulse Radar Test Signal						
Test Signal Name: LP_Signal_03						
Number of Bursts in Trial: 17						
Chrip Center Frequency: 5494MHz						
Burst	Pulses per Burst	Chrip (Hz)	Pulse Width (s)	Pulse 1 to 2 Spacing (s)	Pulse 2 to 3 Spacing (s)	Start Location (s)
1	2	17M	76.5u	1.298m	-	513.7m
2	3	7M	75.5u	1.192m	1.383m	463.1m
3	1	7M	56.2u	-	-	545.4m
4	3	7M	70.9u	958.1u	1.182m	671.6m
5	2	7M	63.7u	991.3u	-	357.2m
6	1	18M	77.3u	-	-	213.0m
7	1	14M	55.4u	-	-	637.9m
8	2	5M	61.7u	1.370m	-	473.0m
9	2	13M	62.2u	1.639m	-	47.96m
10	1	17M	64.1u	-	-	313.8m
11	2	11M	78.0u	1.146m	-	642.3m
12	2	6M	68.0u	1.326m	-	597.6m
13	2	8M	68.8u	1.203m	-	535.9m
14	2	6M	58.5u	1.274m	-	410.8m
15	1	16M	95.2u	-	-	85.59m
16	2	19M	63.1u	1.143m	-	73.05m
17	2	9M	100.0u	1.861m	-	349.4m

Long Pulse Radar Test Signal						
Test Signal Name: LP_Signal_04						
Number of Bursts in Trial: 17						
Chrip Center Frequency: 5495MHz						
Burst	Pulses per Burst	Chrip (Hz)	Pulse Width (s)	Pulse 1 to 2 Spacing (s)	Pulse 2 to 3 Spacing (s)	Start Location (s)
1	1	19M	91.6u	-	-	326.0m
2	2	13M	78.1u	1.190m	-	112.0m
3	3	6M	92.3u	1.111m	1.405m	418.2m
4	1	11M	51.0u	-	-	461.3m
5	1	18M	64.3u	-	-	285.1m
6	3	14M	91.7u	1.162m	973.3u	466.5m
7	2	10M	80.4u	1.070m	-	591.6m
8	2	11M	52.1u	1.046m	-	483.5m
9	1	9M	97.5u	-	-	23.67m
10	2	5M	58.0u	1.588m	-	124.1m
11	2	8M	70.9u	1.001m	-	694.4m
12	1	18M	64.4u	-	-	594.5m
13	2	8M	75.5u	1.324m	-	648.6m
14	2	14M	76.8u	1.815m	-	359.0m
15	2	9M	82.5u	1.720m	-	395.7m
16	3	13M	67.7u	1.810m	1.664m	642.4m
17	3	14M	93.3u	1.365m	1.220m	500.8m

Long Pulse Radar Test Signal						
Test Signal Name: LP_Signal_05						
Number of Bursts in Trial: 14						
Chrip Center Frequency: 5496MHz						
Burst	Pulses per Burst	Chrip (Hz)	Pulse Width (s)	Pulse 1 to 2 Spacing (s)	Pulse 2 to 3 Spacing (s)	Start Location (s)
1	2	6M	97.7u	1.370m	-	792.9m
2	3	18M	50.6u	1.456m	1.734m	55.10m
3	1	6M	76.4u	-	-	434.5m
4	3	10M	94.6u	1.009m	1.352m	472.9m
5	2	18M	52.3u	1.116m	-	453.0m

6	2	10M	53.1u	1.838m	-	307.0m
7	2	16M	54.4u	1.392m	-	451.0m
8	2	6M	96.3u	966.7u	-	808.6m
9	3	11M	58.9u	1.866m	1.779m	639.8m
10	3	14M	99.6u	941.4u	1.634m	650.7m
11	2	14M	71.7u	933.3u	-	346.9m
12	1	18M	65.1u	-	-	602.4m
13	2	9M	70.2u	1.601m	-	689.6m
14	3	16M	88.6u	1.507m	1.171m	41.54m

Long Pulse Radar Test Signal						
Test Signal Name: LP_Signal_06						
Number of Bursts in Trial: 14						
Chrip Center Frequency: 5497MHz						
Burst	Pulses per Burst	Chrip (Hz)	Pulse Width (s)	Pulse 1 to 2 Spacing (s)	Pulse 2 to 3 Spacing (s)	Start Location (s)
1	1	15M	81.0u	-	-	324.5m
2	2	19M	96.0u	1.828m	-	636.2m
3	3	18M	60.9u	1.638m	1.691m	592.1m
4	2	18M	58.3u	1.196m	-	598.2m
5	3	16M	65.7u	937.3u	1.606m	297.3m
6	1	10M	65.9u	-	-	459.1m
7	2	19M	59.0u	1.091m	-	433.1m
8	2	7M	86.3u	1.035m	-	329.7m
9	2	5M	96.6u	1.788m	-	802.6m
10	2	17M	96.3u	927.7u	-	723.1m
11	3	10M	98.9u	1.632m	1.707m	695.4m
12	2	16M	95.6u	1.683m	-	820.7m
13	1	20M	64.9u	-	-	385.8m
14	2	17M	83.7u	1.341m	-	668.5m

Long Pulse Radar Test Signal						
Test Signal Name: LP_Signal_07						
Number of Bursts in Trial: 16						
Chrip Center Frequency: 5498MHz						
Burst	Pulses per Burst	Chrip (Hz)	Pulse Width (s)	Pulse 1 to 2 Spacing (s)	Pulse 2 to 3 Spacing (s)	Start Location (s)
1	2	18M	55.8u	1.783m	-	122.9m
2	2	20M	59.9u	1.569m	-	580.4m
3	3	14M	83.5u	1.389m	926.5u	313.9m
4	1	7M	96.0u	-	-	338.1m
5	1	6M	55.0u	-	-	555.2m
6	2	17M	69.2u	1.872m	-	623.3m
7	3	6M	89.8u	1.188m	1.515m	502.1m
8	1	12M	82.5u	-	-	442.6m
9	2	13M	87.3u	1.385m	-	421.7m
10	2	17M	74.9u	1.720m	-	46.57m
11	2	14M	50.3u	1.072m	-	81.62m
12	3	9M	92.3u	1.821m	1.245m	456.5m
13	2	17M	86.7u	1.024m	-	122.2m
14	2	7M	96.0u	1.149m	-	269.2m
15	2	20M	93.8u	1.149m	-	331.4m
16	3	19M	80.9u	1.468m	1.728m	703.9m

Long Pulse Radar Test Signal						
Test Signal Name: LP_Signal_08						
Number of Bursts in Trial: 12						
Chrip Center Frequency: 5499MHz						
Burst	Pulses per Burst	Chrip (Hz)	Pulse Width (s)	Pulse 1 to 2 Spacing (s)	Pulse 2 to 3 Spacing (s)	Start Location (s)
1	3	19M	76.5u	1.700m	1.267m	562.2m
2	2	20M	58.1u	1.064m	-	748.2m
3	1	18M	65.2u	-	-	609.3m
4	2	17M	95.4u	1.894m	-	310.9m
5	3	12M	70.4u	1.420m	1.919m	662.5m
6	3	20M	93.5u	1.571m	1.391m	764.2m

7	1	11M	51.9u	-	-	74.45m
8	2	8M	81.0u	1.039m	-	836.5m
9	1	9M	63.5u	-	-	591.7m
10	1	7M	73.2u	-	-	221.4m
11	3	7M	92.3u	918.7u	1.862m	689.1m
12	2	10M	76.6u	1.598m	-	329.0m

Long Pulse Radar Test Signal						
Test Signal Name: LP_Signal_09						
Number of Bursts in Trial: 19						
Chrip Center Frequency: 5500MHz						
Burst	Pulses per Burst	Chrip (Hz)	Pulse Width (s)	Pulse 1 to 2 Spacing (s)	Pulse 2 to 3 Spacing (s)	Start Location (s)
1	2	10M	82.2u	963.8u	-	343.6m
2	1	19M	68.7u	-	-	543.3m
3	3	18M	78.4u	1.678m	1.404m	473.3m
4	2	8M	71.9u	1.609m	-	407.4m
5	2	7M	55.3u	1.521m	-	495.1m
6	1	6M	55.9u	-	-	214.4m
7	2	12M	67.2u	1.424m	-	88.86m
8	1	8M	92.6u	-	-	469.5m
9	3	6M	68.1u	1.015m	1.492m	557.1m
10	2	10M	86.7u	1.333m	-	581.1m
11	2	13M	73.9u	1.892m	-	142.6m
12	2	12M	61.3u	1.067m	-	186.2m
13	2	11M	59.1u	1.407m	-	259.0m
14	3	6M	60.4u	1.197m	1.906m	409.0m
15	3	12M	89.0u	1.068m	1.138m	194.8m
16	2	6M	52.9u	1.005m	-	219.6m
17	2	7M	84.0u	1.042m	-	585.4m
18	2	7M	69.4u	1.763m	-	537.6m
19	1	10M	61.8u	-	-	400.0m

Long Pulse Radar Test Signal						
Test Signal Name: LP_Signal_10						
Number of Bursts in Trial: 15						
Chrip Center Frequency: 5501MHz						
Burst	Pulses per Burst	Chrip (Hz)	Pulse Width (s)	Pulse 1 to 2 Spacing (s)	Pulse 2 to 3 Spacing (s)	Start Location (s)
1	2	17M	93.4u	1.852m	-	730.0m
2	2	12M	82.6u	1.896m	-	634.8m
3	2	17M	51.0u	1.214m	-	132.1m
4	3	13M	73.9u	1.237m	1.141m	176.5m
5	3	14M	57.7u	1.067m	1.892m	96.40m
6	2	10M	76.6u	1.546m	-	739.3m
7	3	8M	92.7u	1.432m	1.606m	730.1m
8	2	20M	57.6u	1.586m	-	167.2m
9	2	11M	74.4u	1.507m	-	474.3m
10	2	15M	70.3u	1.598m	-	537.6m
11	3	14M	94.0u	1.869m	1.625m	10.21m
12	1	19M	50.2u	-	-	278.5m
13	2	10M	75.1u	1.206m	-	275.1m
14	3	13M	98.4u	1.208m	1.126m	639.7m
15	3	19M	86.7u	1.610m	1.886m	294.3m

Long Pulse Radar Test Signal						
Test Signal Name: LP_Signal_11						
Number of Bursts in Trial: 18						
Chrip Center Frequency: 5502MHz						
Burst	Pulses per Burst	Chrip (Hz)	Pulse Width (s)	Pulse 1 to 2 Spacing (s)	Pulse 2 to 3 Spacing (s)	Start Location (s)
1	1	18M	89.1u	-	-	19.17m
2	1	9M	87.0u	-	-	212.4m
3	2	13M	69.5u	997.5u	-	286.8m
4	1	5M	69.2u	-	-	286.2m
5	2	12M	94.2u	1.413m	-	128.7m
6	1	14M	98.0u	-	-	265.2m
7	1	8M	82.9u	-	-	345.1m

8	1	10M	82.3u	-	-	138.8m
9	2	5M	68.6u	1.059m	-	54.31m
10	3	7M	84.4u	970.6u	1.110m	38.93m
11	1	14M	65.7u	-	-	100.3m
12	2	15M	99.8u	1.174m	-	662.6m
13	2	6M	86.2u	1.900m	-	434.0m
14	1	12M	74.0u	-	-	571.0m
15	1	14M	53.6u	-	-	98.50m
16	2	11M	77.1u	1.187m	-	5.465m
17	2	7M	76.8u	1.193m	-	52.88m
18	3	17M	59.3u	1.737m	1.105m	166.8m

Long Pulse Radar Test Signal						
Test Signal Name: LP_Signal_12						
Number of Bursts in Trial: 13						
Chrip Center Frequency: 5503MHz						
Burst	Pulses per Burst	Chrip (Hz)	Pulse Width (s)	Pulse 1 to 2 Spacing (s)	Pulse 2 to 3 Spacing (s)	Start Location (s)
1	1	18M	50.2u	-	-	742.1m
2	1	17M	83.1u	-	-	92.80m
3	2	9M	97.0u	1.378m	-	314.5m
4	2	19M	95.5u	1.184m	-	591.9m
5	1	11M	74.9u	-	-	601.9m
6	2	15M	60.0u	1.217m	-	544.1m
7	3	8M	85.6u	1.064m	1.507m	622.2m
8	2	19M	97.7u	1.286m	-	127.3m
9	2	7M	78.7u	1.353m	-	877.0m
10	2	18M	61.8u	1.823m	-	533.8m
11	1	18M	95.1u	-	-	488.4m
12	2	10M	95.8u	1.878m	-	855.6m
13	2	13M	61.3u	1.387m	-	913.0m

Long Pulse Radar Test Signal						
Test Signal Name: LP_Signal_13						
Number of Bursts in Trial: 10						
Chrip Center Frequency: 5504MHz						
Burst	Pulses per Burst	Chrip (Hz)	Pulse Width (s)	Pulse 1 to 2 Spacing (s)	Pulse 2 to 3 Spacing (s)	Start Location (s)
1	1	12M	73.7u	-	-	188.5m
2	2	14M	86.4u	1.325m	-	996.4m
3	1	10M	89.1u	-	-	892.9m
4	3	9M	85.2u	1.299m	1.533m	502.4m
5	2	7M	84.6u	1.234m	-	614.1m
6	1	7M	57.5u	-	-	125.5m
7	2	14M	51.0u	970.0u	-	1.076
8	2	7M	66.6u	1.546m	-	667.5m
9	3	12M	86.7u	1.033m	1.597m	622.9m
10	2	13M	61.2u	1.322m	-	664.9m

Long Pulse Radar Test Signal						
Test Signal Name: LP_Signal_14						
Number of Bursts in Trial: 15						
Chrip Center Frequency: 5505MHz						
Burst	Pulses per Burst	Chrip (Hz)	Pulse Width (s)	Pulse 1 to 2 Spacing (s)	Pulse 2 to 3 Spacing (s)	Start Location (s)
1	1	18M	70.5u	-	-	160.6m
2	3	10M	65.0u	1.209m	1.058m	767.6m
3	3	8M	54.1u	1.071m	1.347m	639.1m
4	2	16M	67.7u	1.311m	-	107.5m
5	2	8M	62.4u	1.585m	-	421.3m
6	2	17M	80.8u	1.790m	-	655.5m
7	2	20M	77.7u	1.882m	-	225.9m
8	2	12M	56.1u	1.743m	-	586.9m
9	2	14M	71.6u	1.015m	-	448.6m
10	2	13M	59.6u	1.809m	-	504.3m
11	2	7M	62.7u	1.857m	-	305.8m
12	1	13M	65.8u	-	-	62.25m

13	1	13M	74.1u	-	-	315.6m
14	3	16M	59.8u	1.185m	1.162m	61.77m
15	2	14M	58.6u	1.732m	-	231.3m

Long Pulse Radar Test Signal						
Test Signal Name: LP_Signal_15						
Number of Bursts in Trial: 11						
Chrip Center Frequency: 5506MHz						
Burst	Pulses per Burst	Chrip (Hz)	Pulse Width (s)	Pulse 1 to 2 Spacing (s)	Pulse 2 to 3 Spacing (s)	Start Location (s)
1	2	19M	77.8u	1.702m	-	310.1m
2	2	20M	79.0u	1.397m	-	684.1m
3	3	12M	70.8u	1.095m	976.2u	973.8m
4	1	12M	56.1u	-	-	337.7m
5	1	20M	78.3u	-	-	680.8m
6	3	6M	77.2u	1.455m	1.122m	212.6m
7	2	14M	76.4u	1.716m	-	555.8m
8	2	10M	91.8u	919.2u	-	283.6m
9	1	8M	53.3u	-	-	877.5m
10	2	7M	56.3u	1.572m	-	1.007
11	1	19M	96.8u	-	-	116.8m

Long Pulse Radar Test Signal						
Test Signal Name: LP_Signal_16						
Number of Bursts in Trial: 18						
Chrip Center Frequency: 5507MHz						
Burst	Pulses per Burst	Chrip (Hz)	Pulse Width (s)	Pulse 1 to 2 Spacing (s)	Pulse 2 to 3 Spacing (s)	Start Location (s)
1	3	8M	83.3u	1.527m	1.641m	1.265m
2	1	8M	78.9u	-	-	10.84m
3	2	8M	50.1u	1.575m	-	663.5m
4	2	11M	74.1u	1.559m	-	298.1m
5	2	16M	82.3u	1.560m	-	649.0m
6	1	11M	90.9u	-	-	655.8m
7	2	11M	72.0u	1.552m	-	254.4m
8	3	13M	66.7u	1.069m	1.691m	515.4m

9	2	11M	75.0u	1.252m	-	298.1m
10	2	9M	81.2u	1.659m	-	61.30m
11	1	8M	66.5u	-	-	271.9m
12	3	16M	54.8u	1.252m	1.598m	54.63m
13	3	12M	79.8u	1.393m	1.687m	188.8m
14	2	12M	57.7u	1.802m	-	352.8m
15	3	13M	73.6u	1.079m	1.597m	15.98m
16	3	9M	57.5u	1.320m	1.182m	116.9m
17	2	19M	92.7u	1.269m	-	256.7m
18	1	17M	78.9u	-	-	76.00m

Long Pulse Radar Test Signal						
Test Signal Name: LP_Signal_17						
Number of Bursts in Trial: 16						
Chrip Center Frequency: 5508MHz						
Burst	Pulses per Burst	Chrip (Hz)	Pulse Width (s)	Pulse 1 to 2 Spacing (s)	Pulse 2 to 3 Spacing (s)	Start Location (s)
1	1	15M	73.5u	-	-	469.1m
2	3	9M	81.1u	1.360m	1.585m	266.1m
3	2	12M	91.5u	1.086m	-	250.2m
4	3	12M	59.9u	1.153m	1.663m	617.1m
5	2	18M	68.4u	1.502m	-	744.8m
6	2	19M	88.4u	1.676m	-	639.7m
7	3	18M	88.0u	1.818m	1.247m	274.8m
8	2	13M	93.1u	1.530m	-	169.0m
9	2	18M	84.3u	1.069m	-	563.1m
10	1	18M	81.6u	-	-	507.5m
11	2	5M	86.0u	1.869m	-	390.2m
12	2	15M	97.3u	1.772m	-	273.4m
13	3	7M	87.5u	1.577m	1.666m	413.5m
14	2	9M	71.3u	1.242m	-	188.4m
15	1	11M	80.5u	-	-	420.9m
16	2	8M	88.0u	1.670m	-	278.8m

Long Pulse Radar Test Signal						
Test Signal Name: LP_Signal_18						
Number of Bursts in Trial: 14						
Chrip Center Frequency: 5500MHz						
Burst	Pulses per Burst	Chrip (Hz)	Pulse Width (s)	Pulse 1 to 2 Spacing (s)	Pulse 2 to 3 Spacing (s)	Start Location (s)
1	2	19M	92.9u	1.625m	-	217.2m
2	2	14M	66.1u	1.028m	-	54.58m
3	1	13M	68.6u	-	-	792.8m
4	3	6M	87.9u	1.603m	1.633m	727.2m
5	3	19M	75.2u	1.018m	1.898m	650.1m
6	3	10M	93.0u	1.094m	1.800m	623.1m
7	2	14M	89.8u	1.873m	-	390.3m
8	2	9M	56.8u	1.857m	-	443.5m
9	2	10M	61.9u	1.757m	-	119.5m
10	2	13M	95.9u	1.162m	-	235.0m
11	2	10M	70.1u	1.542m	-	716.2m
12	2	10M	59.4u	1.746m	-	144.3m
13	2	10M	93.6u	1.359m	-	437.3m
14	2	18M	95.4u	1.387m	-	604.2m

Long Pulse Radar Test Signal						
Test Signal Name: LP_Signal_19						
Number of Bursts in Trial: 13						
Chrip Center Frequency: 5501MHz						
Burst	Pulses per Burst	Chrip (Hz)	Pulse Width (s)	Pulse 1 to 2 Spacing (s)	Pulse 2 to 3 Spacing (s)	Start Location (s)
1	2	9M	97.5u	1.642m	-	456.1m
2	2	16M	82.5u	1.782m	-	840.1m
3	1	7M	63.2u	-	-	209.4m
4	2	18M	70.7u	1.365m	-	119.8m
5	2	18M	81.0u	1.596m	-	834.3m
6	2	15M	66.1u	1.919m	-	135.4m
7	1	15M	80.0u	-	-	489.5m
8	3	8M	51.0u	1.083m	1.184m	233.7m

9	3	20M	76.2u	1.014m	1.922m	36.97m
10	3	17M	64.7u	1.652m	1.514m	830.8m
11	1	19M	59.1u	-	-	345.8m
12	2	16M	73.4u	1.594m	-	776.1m
13	3	8M	62.1u	1.302m	1.157m	566.9m

Long Pulse Radar Test Signal						
Test Signal Name: LP_Signal_20						
Number of Bursts in Trial: 11						
Chrip Center Frequency: 5502MHz						
Burst	Pulses per Burst	Chrip (Hz)	Pulse Width (s)	Pulse 1 to 2 Spacing (s)	Pulse 2 to 3 Spacing (s)	Start Location (s)
1	3	13M	60.7u	1.624m	1.365m	504.3m
2	1	10M	80.7u	-	-	509.5m
3	2	14M	76.0u	1.185m	-	755.0m
4	2	18M	55.6u	1.036m	-	909.5m
5	3	16M	53.2u	995.8u	1.627m	980.1m
6	3	16M	64.1u	1.569m	1.272m	879.5m
7	3	10M	90.0u	938.0u	1.816m	596.7m
8	1	8M	63.2u	-	-	1.063
9	3	18M	97.3u	1.185m	1.463m	557.9m
10	1	6M	85.6u	-	-	841.8m
11	2	17M	72.1u	969.9u	-	134.4m

Long Pulse Radar Test Signal						
Test Signal Name: LP_Signal_21						
Number of Bursts in Trial: 11						
Chrip Center Frequency: 5503MHz						
Burst	Pulses per Burst	Chrip (Hz)	Pulse Width (s)	Pulse 1 to 2 Spacing (s)	Pulse 2 to 3 Spacing (s)	Start Location (s)
1	2	9M	97.2u	1.226m	-	466.9m
2	2	17M	91.5u	1.148m	-	523.5m
3	3	10M	65.8u	1.888m	1.085m	761.3m
4	2	18M	54.4u	1.726m	-	1.047
5	2	10M	50.5u	1.332m	-	605.4m
6	1	18M	85.2u	-	-	690.3m

7	1	20M	96.0u	-	-	245.1m
8	2	6M	60.3u	1.529m	-	103.0m
9	2	17M	59.7u	1.352m	-	324.2m
10	2	19M	53.6u	1.582m	-	1.082
11	2	7M	98.2u	1.661m	-	755.5m

Long Pulse Radar Test Signal						
Test Signal Name: LP_Signal_22						
Number of Bursts in Trial: 12						
Chrip Center Frequency: 5505MHz						
Burst	Pulses per Burst	Chrip (Hz)	Pulse Width (s)	Pulse 1 to 2 Spacing (s)	Pulse 2 to 3 Spacing (s)	Start Location (s)
1	3	15M	62.6u	1.187m	1.659m	373.3m
2	2	9M	73.6u	1.445m	-	368.2m
3	1	8M	77.8u	-	-	958.1m
4	2	18M	78.2u	1.456m	-	940.0m
5	1	12M	58.8u	-	-	876.0m
6	1	15M	56.7u	-	-	644.9m
7	1	19M	76.1u	-	-	893.6m
8	2	15M	95.8u	1.042m	-	244.5m
9	3	7M	67.8u	1.416m	1.539m	763.4m
10	3	10M	67.7u	1.130m	1.363m	78.78m
11	2	9M	51.9u	1.088m	-	293.6m
12	3	13M	95.6u	941.4u	1.041m	280.0m

Long Pulse Radar Test Signal						
Test Signal Name: LP_Signal_23						
Number of Bursts in Trial: 10						
Chrip Center Frequency: 5508MHz						
Burst	Pulses per Burst	Chrip (Hz)	Pulse Width (s)	Pulse 1 to 2 Spacing (s)	Pulse 2 to 3 Spacing (s)	Start Location (s)
1	2	13M	96.5u	1.004m	-	185.7m
2	3	7M	56.7u	1.158m	1.563m	648.7m
3	2	16M	62.6u	1.798m	-	864.5m
4	2	16M	94.2u	927.8u	-	616.7m
5	2	15M	92.2u	1.640m	-	841.1m

6	3	19M	68.7u	1.512m	1.801m	667.9m
7	3	15M	64.1u	984.9u	1.052m	961.9m
8	2	7M	62.8u	956.2u	-	226.8m
9	3	12M	71.9u	1.774m	1.290m	654.6m
10	2	6M	52.3u	1.374m	-	692.3m

Long Pulse Radar Test Signal						
Test Signal Name: LP_Signal_24						
Number of Bursts in Trial: 9						
Chrip Center Frequency: 5499MHz						
Burst	Pulses per Burst	Chrip (Hz)	Pulse Width (s)	Pulse 1 to 2 Spacing (s)	Pulse 2 to 3 Spacing (s)	Start Location (s)
1	3	9M	59.5u	1.541m	1.130m	892.5m
2	3	5M	61.0u	1.367m	979.0u	591.0m
3	1	14M	85.6u	-	-	20.53m
4	2	17M	66.5u	1.510m	-	677.2m
5	1	5M	99.6u	-	-	224.7m
6	2	6M	92.8u	1.292m	-	1.249
7	1	13M	59.0u	-	-	861.4m
8	2	18M	99.9u	1.433m	-	445.5m
9	2	12M	54.9u	1.661m	-	490.2m

Long Pulse Radar Test Signal						
Test Signal Name: LP_Signal_25						
Number of Bursts in Trial: 14						
Chrip Center Frequency: 5498MHz						
Burst	Pulses per Burst	Chrip (Hz)	Pulse Width (s)	Pulse 1 to 2 Spacing (s)	Pulse 2 to 3 Spacing (s)	Start Location (s)
1	2	8M	78.5u	1.337m	-	318.3m
2	2	12M	54.2u	1.429m	-	845.3m
3	2	19M	90.7u	1.866m	-	220.5m
4	3	8M	53.6u	1.058m	1.224m	477.7m
5	1	10M	93.7u	-	-	200.3m
6	2	8M	90.2u	1.902m	-	677.9m
7	1	18M	60.7u	-	-	282.8m
8	2	14M	52.5u	1.018m	-	352.5m

9	2	18M	74.9u	1.899m	-	318.6m
10	1	14M	63.6u	-	-	545.1m
11	3	16M	91.5u	1.172m	1.118m	461.6m
12	1	12M	97.3u	-	-	57.92m
13	1	16M	60.7u	-	-	639.0m
14	2	8M	71.5u	1.746m	-	138.8m

Long Pulse Radar Test Signal						
Test Signal Name: LP_Signal_26						
Number of Bursts in Trial: 17						
Chrip Center Frequency: 5497MHz						
Burst	Pulses per Burst	Chrip (Hz)	Pulse Width (s)	Pulse 1 to 2 Spacing (s)	Pulse 2 to 3 Spacing (s)	Start Location (s)
1	1	10M	95.4u	-	-	360.2m
2	2	16M	96.7u	1.141m	-	75.96m
3	3	17M	91.7u	968.3u	1.299m	603.6m
4	1	5M	81.2u	-	-	248.6m
5	2	11M	82.5u	1.723m	-	114.2m
6	3	8M	93.4u	1.827m	1.616m	420.9m
7	1	18M	91.7u	-	-	602.1m
8	2	16M	91.6u	1.337m	-	214.6m
9	2	17M	99.1u	1.524m	-	103.4m
10	3	13M	83.3u	1.382m	972.7u	83.47m
11	1	12M	78.8u	-	-	327.7m
12	2	12M	61.9u	1.849m	-	232.8m
13	2	9M	58.4u	1.905m	-	625.9m
14	1	19M	97.0u	-	-	665.4m
15	3	19M	73.7u	1.592m	1.864m	475.7m
16	2	5M	96.2u	1.322m	-	467.6m
17	2	9M	83.6u	1.433m	-	666.3m

Long Pulse Radar Test Signal						
Test Signal Name: LP_Signal_27						
Number of Bursts in Trial: 10						
Chrip Center Frequency: 5496MHz						
Burst	Pulses per Burst	Chrip (Hz)	Pulse Width (s)	Pulse 1 to 2 Spacing (s)	Pulse 2 to 3 Spacing (s)	Start Location (s)
1	2	8M	76.7u	1.643m	-	466.9m
2	3	18M	50.4u	967.6u	1.607m	809.3m
3	3	18M	62.5u	1.825m	1.717m	741.1m
4	2	9M	90.1u	1.625m	-	487.0m
5	2	17M	76.2u	1.785m	-	552.7m
6	3	15M	73.8u	1.241m	1.206m	524.1m
7	2	13M	78.3u	1.201m	-	604.4m
8	2	10M	63.3u	971.7u	-	168.4m
9	1	10M	50.8u	-	-	322.9m
10	3	19M	68.9u	1.033m	1.810m	882.7m

Long Pulse Radar Test Signal						
Test Signal Name: LP_Signal_28						
Number of Bursts in Trial: 15						
Chrip Center Frequency: 5495MHz						
Burst	Pulses per Burst	Chrip (Hz)	Pulse Width (s)	Pulse 1 to 2 Spacing (s)	Pulse 2 to 3 Spacing (s)	Start Location (s)
1	2	11M	97.0u	1.069m	-	568.0m
2	2	7M	59.0u	1.122m	-	308.9m
3	3	14M	53.4u	1.233m	1.005m	365.3m
4	2	11M	95.4u	1.845m	-	159.9m
5	2	12M	99.0u	1.451m	-	748.3m
6	3	10M	62.0u	1.153m	1.596m	209.3m
7	2	12M	96.1u	1.870m	-	242.5m
8	3	14M	59.5u	1.243m	1.700m	633.4m
9	1	10M	65.7u	-	-	781.4m
10	2	15M	64.5u	1.230m	-	324.2m
11	1	11M	69.3u	-	-	291.3m
12	2	15M	64.5u	1.187m	-	456.3m

13	2	9M	81.5u	1.022m	-	446.0m
14	2	14M	99.7u	910.3u	-	784.7m
15	2	9M	74.4u	1.310m	-	712.4m

Long Pulse Radar Test Signal						
Test Signal Name: LP_Signal_29						
Number of Bursts in Trial: 10						
Chrip Center Frequency: 5493MHz						
Burst	Pulses per Burst	Chrip (Hz)	Pulse Width (s)	Pulse 1 to 2 Spacing (s)	Pulse 2 to 3 Spacing (s)	Start Location (s)
1	2	18M	92.6u	1.048m	-	278.0m
2	1	9M	99.1u	-	-	1.111
3	2	13M	88.0u	956.0u	-	39.30m
4	1	13M	52.4u	-	-	826.3m
5	1	10M	62.6u	-	-	1.076
6	2	13M	50.8u	1.764m	-	350.6m
7	3	18M	69.1u	1.008m	1.331m	993.4m
8	3	8M	91.8u	1.881m	1.645m	724.4m
9	3	18M	71.6u	1.471m	1.464m	839.7m
10	3	10M	57.6u	1.899m	1.630m	56.13m

Long Pulse Radar Test Signal						
Test Signal Name: LP_Signal_30						
Number of Bursts in Trial: 12						
Chrip Center Frequency: 5492MHz						
Burst	Pulses per Burst	Chrip (Hz)	Pulse Width (s)	Pulse 1 to 2 Spacing (s)	Pulse 2 to 3 Spacing (s)	Start Location (s)
1	2	6M	60.5u	980.5u	-	51.65m
2	2	5M	76.1u	1.376m	-	523.8m
3	2	11M	83.7u	1.713m	-	774.2m
4	3	8M	54.1u	1.116m	1.719m	323.7m
5	3	14M	78.3u	1.345m	1.793m	722.4m
6	1	5M	53.1u	-	-	150.0m
7	1	10M	67.0u	-	-	720.1m
8	3	8M	59.1u	1.554m	1.878m	369.1m
9	2	20M	80.1u	1.586m	-	446.5m

10	1	20M	69.3u	-	-	490.7m
11	3	10M	79.9u	1.636m	1.365m	1.959m
12	3	20M	62.9u	1.164m	1.856m	509.4m

Type 6 Radar Statistical Performances				
Trial #	Pulses per Burst	Pulse Width (s)	PRI (s)	Detection
1	9	1.0u	333.0u	Yes
2	9	1.0u	333.0u	Yes
3	9	1.0u	333.0u	Yes
4	9	1.0u	333.0u	Yes
5	9	1.0u	333.0u	Yes
6	9	1.0u	333.0u	Yes
7	9	1.0u	333.0u	Yes
8	9	1.0u	333.0u	Yes
9	9	1.0u	333.0u	Yes
10	9	1.0u	333.0u	Yes
11	9	1.0u	333.0u	Yes
12	9	1.0u	333.0u	Yes
13	9	1.0u	333.0u	Yes
14	9	1.0u	333.0u	Yes
15	9	1.0u	333.0u	Yes
16	9	1.0u	333.0u	Yes
17	9	1.0u	333.0u	Yes
18	9	1.0u	333.0u	Yes
19	9	1.0u	333.0u	Yes
20	9	1.0u	333.0u	Yes
21	9	1.0u	333.0u	Yes
22	9	1.0u	333.0u	Yes
23	9	1.0u	333.0u	Yes
24	9	1.0u	333.0u	Yes
25	9	1.0u	333.0u	Yes
26	9	1.0u	333.0u	Yes
27	9	1.0u	333.0u	Yes
28	9	1.0u	333.0u	Yes
29	9	1.0u	333.0u	Yes
30	9	1.0u	333.0u	Yes
			Detection Rate: 100.0 %	

Type 6 Radar Statistical Performances		
Trial #	Hopping Frequency Sequence Name	Detection
1	HOP_FREQ_SEQ_01	Yes
2	HOP_FREQ_SEQ_02	Yes
3	HOP_FREQ_SEQ_03	Yes
4	HOP_FREQ_SEQ_04	Yes
5	HOP_FREQ_SEQ_05	Yes
6	HOP_FREQ_SEQ_06	Yes
7	HOP_FREQ_SEQ_07	Yes
8	HOP_FREQ_SEQ_08	Yes
9	HOP_FREQ_SEQ_09	Yes
10	HOP_FREQ_SEQ_10	Yes
11	HOP_FREQ_SEQ_11	Yes
12	HOP_FREQ_SEQ_12	Yes
13	HOP_FREQ_SEQ_13	Yes
14	HOP_FREQ_SEQ_14	Yes
15	HOP_FREQ_SEQ_15	Yes
16	HOP_FREQ_SEQ_16	Yes
17	HOP_FREQ_SEQ_17	Yes
18	HOP_FREQ_SEQ_18	Yes
19	HOP_FREQ_SEQ_19	Yes
20	HOP_FREQ_SEQ_20	Yes
21	HOP_FREQ_SEQ_21	Yes
22	HOP_FREQ_SEQ_22	Yes
23	HOP_FREQ_SEQ_23	Yes
24	HOP_FREQ_SEQ_24	Yes
25	HOP_FREQ_SEQ_25	Yes
26	HOP_FREQ_SEQ_26	Yes
27	HOP_FREQ_SEQ_27	Yes
28	HOP_FREQ_SEQ_28	Yes
29	HOP_FREQ_SEQ_29	Yes
30	HOP_FREQ_SEQ_30	Yes
Detection Rate: 100.0 %		

Hopping Frequency Sequence Name: HOP_FREQ_SEQ_01							
SEQ#	Frequency (Hz)	SEQ#	Frequency (Hz)	SEQ#	Frequency (Hz)	SEQ#	Frequency (Hz)
1	5.594G	2	5.685G	3	5.361G	4	5.582G
5	5.699G	6	5.598G	7	5.352G	8	5.301G
9	5.658G	10	5.311G	11	5.696G	12	5.278G
13	5.529G	14	5.462G	15	5.313G	16	5.655G
17	5.523G	18	5.390G	19	5.282G	20	5.273G
21	5.339G	22	5.595G	23	5.434G	24	5.300G
25	5.351G	26	5.617G	27	5.250G	28	5.436G
29	5.605G	30	5.508G	31	5.307G	32	5.636G
33	5.294G	34	5.401G	35	5.601G	36	5.460G
37	5.587G	38	5.324G	39	5.314G	40	5.349G
41	5.654G	42	5.576G	43	5.432G	44	5.413G
45	5.538G	46	5.336G	47	5.378G	48	5.702G
49	5.542G	50	5.417G	51	5.723G	52	5.374G
53	5.535G	54	5.485G	55	5.302G	56	5.635G
57	5.384G	58	5.503G	59	5.387G	60	5.575G
61	5.465G	62	5.297G	63	5.440G	64	5.602G
65	5.691G	66	5.715G	67	5.565G	68	5.579G
69	5.698G	70	5.500G	71	5.252G	72	5.649G
73	5.272G	74	5.589G	75	5.711G	76	5.712G
77	5.359G	78	5.592G	79	5.624G	80	5.671G
81	5.545G	82	5.402G	83	5.445G	84	5.514G
85	5.549G	86	5.291G	87	5.317G	88	5.299G
89	5.501G	90	5.554G	91	5.293G	92	5.285G
93	5.546G	94	5.253G	95	5.379G	96	5.551G
97	5.350G	98	5.550G	99	5.447G	100	5.358G

Hopping Frequency Sequence Name: HOP_FREQ_SEQ_02							
SEQ#	Frequency (Hz)	SEQ#	Frequency (Hz)	SEQ#	Frequency (Hz)	SEQ#	Frequency (Hz)
1	5.376G	2	5.709G	3	5.610G	4	5.380G
5	5.421G	6	5.506G	7	5.294G	8	5.373G
9	5.669G	10	5.716G	11	5.589G	12	5.307G
13	5.429G	14	5.651G	15	5.275G	16	5.478G
17	5.720G	18	5.667G	19	5.272G	20	5.534G

21	5.629G	22	5.405G	23	5.447G	24	5.543G
25	5.495G	26	5.279G	27	5.719G	28	5.444G
29	5.578G	30	5.512G	31	5.408G	32	5.250G
33	5.263G	34	5.372G	35	5.295G	36	5.433G
37	5.445G	38	5.586G	39	5.609G	40	5.381G
41	5.661G	42	5.655G	43	5.469G	44	5.273G
45	5.497G	46	5.717G	47	5.356G	48	5.611G
49	5.422G	50	5.439G	51	5.620G	52	5.260G
53	5.350G	54	5.282G	55	5.666G	56	5.701G
57	5.575G	58	5.633G	59	5.472G	60	5.367G
61	5.454G	62	5.416G	63	5.508G	64	5.340G
65	5.718G	66	5.561G	67	5.283G	68	5.274G
69	5.514G	70	5.568G	71	5.361G	72	5.605G
73	5.715G	74	5.639G	75	5.576G	76	5.658G
77	5.379G	78	5.300G	79	5.482G	80	5.311G
81	5.265G	82	5.501G	83	5.523G	84	5.480G
85	5.479G	86	5.722G	87	5.335G	88	5.359G
89	5.413G	90	5.425G	91	5.516G	92	5.532G
93	5.407G	94	5.343G	95	5.419G	96	5.703G
97	5.711G	98	5.527G	99	5.695G	100	5.546G

Hopping Frequency Sequence Name: HOP_FREQ_SEQ_03							
SEQ#	Frequency (Hz)	SEQ#	Frequency (Hz)	SEQ#	Frequency (Hz)	SEQ#	Frequency (Hz)
1	5.357G	2	5.382G	3	5.464G	4	5.556G
5	5.456G	6	5.458G	7	5.300G	8	5.616G
9	5.582G	10	5.499G	11	5.618G	12	5.402G
13	5.250G	14	5.684G	15	5.620G	16	5.723G
17	5.265G	18	5.379G	19	5.632G	20	5.486G
21	5.606G	22	5.496G	23	5.507G	24	5.411G
25	5.598G	26	5.435G	27	5.587G	28	5.373G
29	5.381G	30	5.344G	31	5.672G	32	5.480G
33	5.455G	34	5.296G	35	5.715G	36	5.409G
37	5.371G	38	5.539G	39	5.336G	40	5.557G
41	5.506G	42	5.254G	43	5.669G	44	5.405G
45	5.420G	46	5.714G	47	5.528G	48	5.701G
49	5.363G	50	5.626G	51	5.438G	52	5.542G
53	5.685G	54	5.568G	55	5.599G	56	5.595G

57	5.299G	58	5.580G	59	5.416G	60	5.372G
61	5.312G	62	5.629G	63	5.561G	64	5.393G
65	5.307G	66	5.313G	67	5.414G	68	5.417G
69	5.696G	70	5.719G	71	5.690G	72	5.627G
73	5.617G	74	5.636G	75	5.404G	76	5.593G
77	5.678G	78	5.399G	79	5.491G	80	5.304G
81	5.643G	82	5.608G	83	5.392G	84	5.263G
85	5.589G	86	5.466G	87	5.425G	88	5.553G
89	5.707G	90	5.453G	91	5.332G	92	5.590G
93	5.594G	94	5.272G	95	5.328G	96	5.708G
97	5.449G	98	5.298G	99	5.348G	100	5.365G

Hopping Frequency Sequence Name: HOP_FREQ_SEQ_04							
SEQ#	Frequency (Hz)	SEQ#	Frequency (Hz)	SEQ#	Frequency (Hz)	SEQ#	Frequency (Hz)
1	5.665G	2	5.500G	3	5.273G	4	5.495G
5	5.656G	6	5.481G	7	5.396G	8	5.355G
9	5.567G	10	5.431G	11	5.337G	12	5.473G
13	5.504G	14	5.320G	15	5.520G	16	5.685G
17	5.574G	18	5.638G	19	5.477G	20	5.306G
21	5.357G	22	5.255G	23	5.679G	24	5.258G
25	5.720G	26	5.564G	27	5.523G	28	5.696G
29	5.445G	30	5.290G	31	5.503G	32	5.681G
33	5.310G	34	5.446G	35	5.385G	36	5.551G
37	5.578G	38	5.279G	39	5.457G	40	5.430G
41	5.484G	42	5.657G	43	5.558G	44	5.518G
45	5.709G	46	5.492G	47	5.552G	48	5.597G
49	5.710G	50	5.527G	51	5.605G	52	5.266G
53	5.331G	54	5.300G	55	5.704G	56	5.667G
57	5.405G	58	5.352G	59	5.723G	60	5.269G
61	5.475G	62	5.659G	63	5.347G	64	5.555G
65	5.458G	66	5.628G	67	5.722G	68	5.646G
69	5.630G	70	5.340G	71	5.448G	72	5.391G
73	5.435G	74	5.612G	75	5.272G	76	5.314G
77	5.327G	78	5.476G	79	5.386G	80	5.381G
81	5.617G	82	5.443G	83	5.345G	84	5.607G
85	5.631G	86	5.374G	87	5.260G	88	5.261G
89	5.714G	90	5.287G	91	5.680G	92	5.451G

93	5.541G	94	5.265G	95	5.294G	96	5.399G
97	5.377G	98	5.432G	99	5.307G	100	5.707G

Hopping Frequency Sequence Name: HOP_FREQ_SEQ_05							
SEQ#	Frequency (Hz)	SEQ#	Frequency (Hz)	SEQ#	Frequency (Hz)	SEQ#	Frequency (Hz)
1	5.388G	2	5.353G	3	5.492G	4	5.545G
5	5.604G	6	5.585G	7	5.355G	8	5.720G
9	5.570G	10	5.403G	11	5.454G	12	5.258G
13	5.326G	14	5.573G	15	5.342G	16	5.562G
17	5.327G	18	5.348G	19	5.634G	20	5.499G
21	5.537G	22	5.451G	23	5.554G	24	5.260G
25	5.672G	26	5.627G	27	5.300G	28	5.712G
29	5.268G	30	5.603G	31	5.558G	32	5.387G
33	5.669G	34	5.619G	35	5.701G	36	5.504G
37	5.675G	38	5.709G	39	5.394G	40	5.589G
41	5.312G	42	5.459G	43	5.686G	44	5.599G
45	5.722G	46	5.445G	47	5.255G	48	5.270G
49	5.616G	50	5.567G	51	5.252G	52	5.430G
53	5.421G	54	5.310G	55	5.593G	56	5.569G
57	5.291G	58	5.611G	59	5.439G	60	5.356G
61	5.704G	62	5.538G	63	5.346G	64	5.607G
65	5.267G	66	5.295G	67	5.651G	68	5.527G
69	5.621G	70	5.311G	71	5.695G	72	5.697G
73	5.413G	74	5.693G	75	5.340G	76	5.673G
77	5.516G	78	5.321G	79	5.706G	80	5.333G
81	5.638G	82	5.301G	83	5.515G	84	5.389G
85	5.602G	86	5.698G	87	5.415G	88	5.369G
89	5.436G	90	5.711G	91	5.262G	92	5.650G
93	5.450G	94	5.419G	95	5.580G	96	5.282G
97	5.305G	98	5.618G	99	5.399G	100	5.581G

Hopping Frequency Sequence Name: HOP_FREQ_SEQ_06							
SEQ#	Frequency (Hz)	SEQ#	Frequency (Hz)	SEQ#	Frequency (Hz)	SEQ#	Frequency (Hz)
1	5.501G	2	5.702G	3	5.543G	4	5.629G
5	5.576G	6	5.687G	7	5.402G	8	5.504G
9	5.487G	10	5.293G	11	5.266G	12	5.562G

13	5.276G	14	5.282G	15	5.531G	16	5.535G
17	5.649G	18	5.361G	19	5.430G	20	5.529G
21	5.485G	22	5.523G	23	5.723G	24	5.471G
25	5.719G	26	5.253G	27	5.257G	28	5.414G
29	5.601G	30	5.621G	31	5.579G	32	5.600G
33	5.708G	34	5.469G	35	5.566G	36	5.552G
37	5.653G	38	5.612G	39	5.306G	40	5.557G
41	5.550G	42	5.321G	43	5.682G	44	5.415G
45	5.305G	46	5.505G	47	5.701G	48	5.433G
49	5.657G	50	5.404G	51	5.551G	52	5.545G
53	5.264G	54	5.339G	55	5.685G	56	5.442G
57	5.399G	58	5.636G	59	5.556G	60	5.525G
61	5.381G	62	5.666G	63	5.420G	64	5.389G
65	5.628G	66	5.397G	67	5.617G	68	5.400G
69	5.313G	70	5.391G	71	5.440G	72	5.615G
73	5.474G	74	5.307G	75	5.463G	76	5.611G
77	5.398G	78	5.340G	79	5.534G	80	5.330G
81	5.546G	82	5.284G	83	5.537G	84	5.625G
85	5.296G	86	5.259G	87	5.299G	88	5.401G
89	5.382G	90	5.547G	91	5.492G	92	5.518G
93	5.443G	94	5.376G	95	5.457G	96	5.473G
97	5.470G	98	5.539G	99	5.603G	100	5.290G

Hopping Frequency Sequence Name: HOP_FREQ_SEQ_07							
SEQ#	Frequency (Hz)	SEQ#	Frequency (Hz)	SEQ#	Frequency (Hz)	SEQ#	Frequency (Hz)
1	5.471G	2	5.572G	3	5.333G	4	5.307G
5	5.392G	6	5.555G	7	5.469G	8	5.531G
9	5.523G	10	5.339G	11	5.686G	12	5.538G
13	5.512G	14	5.520G	15	5.713G	16	5.621G
17	5.660G	18	5.434G	19	5.613G	20	5.430G
21	5.387G	22	5.589G	23	5.273G	24	5.385G
25	5.299G	26	5.619G	27	5.458G	28	5.563G
29	5.679G	30	5.446G	31	5.399G	32	5.321G
33	5.297G	34	5.647G	35	5.432G	36	5.668G
37	5.271G	38	5.503G	39	5.353G	40	5.290G
41	5.376G	42	5.326G	43	5.500G	44	5.675G
45	5.316G	46	5.580G	47	5.501G	48	5.677G

49	5.554G	50	5.415G	51	5.709G	52	5.498G
53	5.528G	54	5.288G	55	5.449G	56	5.630G
57	5.417G	58	5.536G	59	5.255G	60	5.639G
61	5.669G	62	5.482G	63	5.324G	64	5.591G
65	5.452G	66	5.502G	67	5.567G	68	5.542G
69	5.251G	70	5.718G	71	5.436G	72	5.695G
73	5.348G	74	5.525G	75	5.358G	76	5.466G
77	5.470G	78	5.712G	79	5.314G	80	5.394G
81	5.263G	82	5.391G	83	5.625G	84	5.483G
85	5.666G	86	5.537G	87	5.517G	88	5.653G
89	5.429G	90	5.305G	91	5.607G	92	5.298G
93	5.284G	94	5.687G	95	5.426G	96	5.623G
97	5.453G	98	5.388G	99	5.673G	100	5.608G

Hopping Frequency Sequence Name: HOP_FREQ_SEQ_08							
SEQ#	Frequency (Hz)	SEQ#	Frequency (Hz)	SEQ#	Frequency (Hz)	SEQ#	Frequency (Hz)
1	5.673G	2	5.401G	3	5.697G	4	5.716G
5	5.619G	6	5.251G	7	5.708G	8	5.499G
9	5.294G	10	5.565G	11	5.300G	12	5.593G
13	5.567G	14	5.549G	15	5.581G	16	5.598G
17	5.364G	18	5.571G	19	5.720G	20	5.589G
21	5.486G	22	5.534G	23	5.301G	24	5.569G
25	5.487G	26	5.652G	27	5.703G	28	5.586G
29	5.426G	30	5.509G	31	5.514G	32	5.525G
33	5.590G	34	5.453G	35	5.513G	36	5.685G
37	5.398G	38	5.602G	39	5.632G	40	5.377G
41	5.459G	42	5.664G	43	5.686G	44	5.408G
45	5.292G	46	5.307G	47	5.706G	48	5.387G
49	5.696G	50	5.298G	51	5.717G	52	5.721G
53	5.478G	54	5.381G	55	5.563G	56	5.468G
57	5.416G	58	5.325G	59	5.382G	60	5.680G
61	5.670G	62	5.681G	63	5.545G	64	5.316G
65	5.639G	66	5.614G	67	5.512G	68	5.419G
69	5.272G	70	5.302G	71	5.331G	72	5.659G
73	5.679G	74	5.526G	75	5.592G	76	5.576G
77	5.719G	78	5.397G	79	5.653G	80	5.551G
81	5.395G	82	5.353G	83	5.498G	84	5.405G

85	5.692G	86	5.374G	87	5.368G	88	5.434G
89	5.492G	90	5.271G	91	5.601G	92	5.273G
93	5.475G	94	5.322G	95	5.612G	96	5.350G
97	5.362G	98	5.517G	99	5.683G	100	5.712G

Hopping Frequency Sequence Name: HOP_FREQ_SEQ_09							
SEQ#	Frequency (Hz)	SEQ#	Frequency (Hz)	SEQ#	Frequency (Hz)	SEQ#	Frequency (Hz)
1	5.263G	2	5.355G	3	5.702G	4	5.382G
5	5.577G	6	5.648G	7	5.265G	8	5.516G
9	5.491G	10	5.566G	11	5.692G	12	5.363G
13	5.319G	14	5.469G	15	5.448G	16	5.507G
17	5.414G	18	5.708G	19	5.348G	20	5.644G
21	5.620G	22	5.449G	23	5.314G	24	5.674G
25	5.597G	26	5.723G	27	5.389G	28	5.509G
29	5.353G	30	5.317G	31	5.675G	32	5.392G
33	5.574G	34	5.568G	35	5.352G	36	5.659G
37	5.250G	38	5.408G	39	5.704G	40	5.681G
41	5.256G	42	5.388G	43	5.718G	44	5.466G
45	5.661G	46	5.270G	47	5.432G	48	5.683G
49	5.299G	50	5.627G	51	5.506G	52	5.343G
53	5.486G	54	5.366G	55	5.385G	56	5.406G
57	5.713G	58	5.709G	59	5.641G	60	5.714G
61	5.647G	62	5.460G	63	5.360G	64	5.544G
65	5.259G	66	5.722G	67	5.273G	68	5.457G
69	5.344G	70	5.303G	71	5.576G	72	5.498G
73	5.422G	74	5.439G	75	5.587G	76	5.454G
77	5.435G	78	5.676G	79	5.415G	80	5.285G
81	5.578G	82	5.545G	83	5.412G	84	5.624G
85	5.417G	86	5.530G	87	5.667G	88	5.338G
89	5.612G	90	5.266G	91	5.337G	92	5.476G
93	5.588G	94	5.690G	95	5.345G	96	5.482G
97	5.444G	98	5.295G	99	5.419G	100	5.426G

Hopping Frequency Sequence Name: HOP_FREQ_SEQ_10							
SEQ#	Frequency (Hz)	SEQ#	Frequency (Hz)	SEQ#	Frequency (Hz)	SEQ#	Frequency (Hz)
1	5.302G	2	5.691G	3	5.421G	4	5.695G
5	5.673G	6	5.539G	7	5.484G	8	5.367G
9	5.665G	10	5.344G	11	5.590G	12	5.321G
13	5.305G	14	5.292G	15	5.576G	16	5.718G
17	5.328G	18	5.573G	19	5.361G	20	5.331G
21	5.708G	22	5.516G	23	5.338G	24	5.629G
25	5.680G	26	5.415G	27	5.351G	28	5.264G
29	5.528G	30	5.488G	31	5.561G	32	5.541G
33	5.563G	34	5.723G	35	5.411G	36	5.591G
37	5.621G	38	5.668G	39	5.659G	40	5.623G
41	5.323G	42	5.373G	43	5.630G	44	5.538G
45	5.717G	46	5.453G	47	5.451G	48	5.520G
49	5.505G	50	5.575G	51	5.641G	52	5.554G
53	5.587G	54	5.669G	55	5.314G	56	5.420G
57	5.645G	58	5.459G	59	5.664G	60	5.329G
61	5.567G	62	5.464G	63	5.359G	64	5.706G
65	5.596G	66	5.434G	67	5.482G	68	5.313G
69	5.676G	70	5.529G	71	5.369G	72	5.504G
73	5.388G	74	5.315G	75	5.435G	76	5.483G
77	5.282G	78	5.704G	79	5.337G	80	5.307G
81	5.465G	82	5.412G	83	5.477G	84	5.372G
85	5.447G	86	5.322G	87	5.617G	88	5.707G
89	5.506G	90	5.310G	91	5.517G	92	5.527G
93	5.526G	94	5.425G	95	5.709G	96	5.386G
97	5.540G	98	5.259G	99	5.558G	100	5.345G

Hopping Frequency Sequence Name: HOP_FREQ_SEQ_11							
SEQ#	Frequency (Hz)	SEQ#	Frequency (Hz)	SEQ#	Frequency (Hz)	SEQ#	Frequency (Hz)
1	5.654G	2	5.398G	3	5.470G	4	5.660G
5	5.519G	6	5.321G	7	5.527G	8	5.513G
9	5.293G	10	5.600G	11	5.440G	12	5.302G
13	5.363G	14	5.491G	15	5.637G	16	5.450G
17	5.457G	18	5.683G	19	5.390G	20	5.535G

21	5.388G	22	5.546G	23	5.472G	24	5.534G
25	5.386G	26	5.595G	27	5.543G	28	5.394G
29	5.471G	30	5.320G	31	5.634G	32	5.458G
33	5.719G	34	5.566G	35	5.407G	36	5.677G
37	5.565G	38	5.524G	39	5.716G	40	5.681G
41	5.718G	42	5.486G	43	5.496G	44	5.709G
45	5.481G	46	5.482G	47	5.655G	48	5.572G
49	5.377G	50	5.704G	51	5.373G	52	5.528G
53	5.706G	54	5.666G	55	5.622G	56	5.614G
57	5.627G	58	5.349G	59	5.515G	60	5.422G
61	5.501G	62	5.617G	63	5.253G	64	5.281G
65	5.287G	66	5.526G	67	5.542G	68	5.673G
69	5.261G	70	5.498G	71	5.435G	72	5.480G
73	5.705G	74	5.668G	75	5.618G	76	5.536G
77	5.484G	78	5.529G	79	5.343G	80	5.374G
81	5.339G	82	5.552G	83	5.478G	84	5.475G
85	5.446G	86	5.329G	87	5.620G	88	5.447G
89	5.341G	90	5.304G	91	5.588G	92	5.591G
93	5.477G	94	5.664G	95	5.334G	96	5.357G
97	5.667G	98	5.579G	99	5.506G	100	5.412G

Hopping Frequency Sequence Name: HOP_FREQ_SEQ_12							
SEQ#	Frequency (Hz)	SEQ#	Frequency (Hz)	SEQ#	Frequency (Hz)	SEQ#	Frequency (Hz)
1	5.675G	2	5.480G	3	5.267G	4	5.630G
5	5.596G	6	5.633G	7	5.253G	8	5.317G
9	5.273G	10	5.362G	11	5.522G	12	5.594G
13	5.642G	14	5.547G	15	5.503G	16	5.672G
17	5.449G	18	5.316G	19	5.569G	20	5.555G
21	5.498G	22	5.710G	23	5.722G	24	5.682G
25	5.308G	26	5.598G	27	5.276G	28	5.495G
29	5.493G	30	5.593G	31	5.643G	32	5.377G
33	5.670G	34	5.294G	35	5.369G	36	5.714G
37	5.516G	38	5.648G	39	5.357G	40	5.621G
41	5.264G	42	5.261G	43	5.504G	44	5.392G
45	5.295G	46	5.334G	47	5.439G	48	5.305G
49	5.581G	50	5.624G	51	5.272G	52	5.297G
53	5.488G	54	5.629G	55	5.304G	56	5.368G

57	5.391G	58	5.379G	59	5.274G	60	5.263G
61	5.687G	62	5.285G	63	5.639G	64	5.347G
65	5.640G	66	5.579G	67	5.278G	68	5.705G
69	5.491G	70	5.250G	71	5.592G	72	5.344G
73	5.560G	74	5.321G	75	5.646G	76	5.563G
77	5.339G	78	5.453G	79	5.677G	80	5.507G
81	5.605G	82	5.617G	83	5.389G	84	5.462G
85	5.378G	86	5.390G	87	5.583G	88	5.469G
89	5.338G	90	5.568G	91	5.448G	92	5.329G
93	5.388G	94	5.380G	95	5.564G	96	5.418G
97	5.668G	98	5.303G	99	5.693G	100	5.404G

Hopping Frequency Sequence Name: HOP_FREQ_SEQ_13							
SEQ#	Frequency (Hz)	SEQ#	Frequency (Hz)	SEQ#	Frequency (Hz)	SEQ#	Frequency (Hz)
1	5.553G	2	5.630G	3	5.296G	4	5.685G
5	5.719G	6	5.441G	7	5.582G	8	5.386G
9	5.563G	10	5.689G	11	5.663G	12	5.610G
13	5.456G	14	5.352G	15	5.524G	16	5.586G
17	5.435G	18	5.270G	19	5.353G	20	5.534G
21	5.575G	22	5.470G	23	5.465G	24	5.671G
25	5.278G	26	5.604G	27	5.406G	28	5.475G
29	5.652G	30	5.550G	31	5.381G	32	5.443G
33	5.531G	34	5.307G	35	5.411G	36	5.634G
37	5.412G	38	5.568G	39	5.709G	40	5.626G
41	5.339G	42	5.621G	43	5.469G	44	5.327G
45	5.560G	46	5.501G	47	5.362G	48	5.314G
49	5.640G	50	5.667G	51	5.650G	52	5.710G
53	5.287G	54	5.544G	55	5.500G	56	5.617G
57	5.419G	58	5.334G	59	5.683G	60	5.533G
61	5.678G	62	5.447G	63	5.497G	64	5.715G
65	5.397G	66	5.356G	67	5.450G	68	5.658G
69	5.257G	70	5.618G	71	5.635G	72	5.696G
73	5.448G	74	5.371G	75	5.514G	76	5.579G
77	5.496G	78	5.439G	79	5.330G	80	5.250G
81	5.698G	82	5.482G	83	5.651G	84	5.564G
85	5.429G	86	5.494G	87	5.616G	88	5.676G
89	5.251G	90	5.253G	91	5.272G	92	5.644G

93	5.393G	94	5.628G	95	5.313G	96	5.665G
97	5.446G	98	5.624G	99	5.389G	100	5.484G

Hopping Frequency Sequence Name: HOP_FREQ_SEQ_14							
SEQ#	Frequency (Hz)	SEQ#	Frequency (Hz)	SEQ#	Frequency (Hz)	SEQ#	Frequency (Hz)
1	5.580G	2	5.447G	3	5.392G	4	5.691G
5	5.576G	6	5.444G	7	5.397G	8	5.477G
9	5.296G	10	5.288G	11	5.323G	12	5.608G
13	5.325G	14	5.313G	15	5.307G	16	5.350G
17	5.345G	18	5.396G	19	5.367G	20	5.648G
21	5.717G	22	5.577G	23	5.373G	24	5.401G
25	5.537G	26	5.438G	27	5.375G	28	5.689G
29	5.501G	30	5.498G	31	5.380G	32	5.439G
33	5.340G	34	5.645G	35	5.348G	36	5.636G
37	5.533G	38	5.437G	39	5.329G	40	5.291G
41	5.363G	42	5.278G	43	5.298G	44	5.255G
45	5.667G	46	5.379G	47	5.626G	48	5.354G
49	5.374G	50	5.364G	51	5.299G	52	5.552G
53	5.609G	54	5.459G	55	5.508G	56	5.516G
57	5.641G	58	5.446G	59	5.661G	60	5.700G
61	5.633G	62	5.346G	63	5.337G	64	5.642G
65	5.388G	66	5.265G	67	5.586G	68	5.435G
69	5.318G	70	5.674G	71	5.623G	72	5.594G
73	5.272G	74	5.680G	75	5.565G	76	5.721G
77	5.341G	78	5.338G	79	5.562G	80	5.409G
81	5.614G	82	5.369G	83	5.475G	84	5.544G
85	5.649G	86	5.411G	87	5.327G	88	5.651G
89	5.500G	90	5.520G	91	5.257G	92	5.551G
93	5.583G	94	5.424G	95	5.541G	96	5.723G
97	5.601G	98	5.322G	99	5.620G	100	5.557G

Hopping Frequency Sequence Name: HOP_FREQ_SEQ_15							
SEQ#	Frequency (Hz)	SEQ#	Frequency (Hz)	SEQ#	Frequency (Hz)	SEQ#	Frequency (Hz)
1	5.634G	2	5.567G	3	5.338G	4	5.557G
5	5.457G	6	5.390G	7	5.337G	8	5.443G
9	5.667G	10	5.418G	11	5.452G	12	5.349G

13	5.485G	14	5.437G	15	5.287G	16	5.377G
17	5.324G	18	5.583G	19	5.306G	20	5.578G
21	5.712G	22	5.684G	23	5.588G	24	5.343G
25	5.267G	26	5.657G	27	5.651G	28	5.496G
29	5.478G	30	5.671G	31	5.367G	32	5.462G
33	5.609G	34	5.624G	35	5.255G	36	5.332G
37	5.399G	38	5.703G	39	5.385G	40	5.545G
41	5.436G	42	5.266G	43	5.469G	44	5.560G
45	5.273G	46	5.431G	47	5.401G	48	5.600G
49	5.364G	50	5.687G	51	5.561G	52	5.625G
53	5.284G	54	5.468G	55	5.422G	56	5.376G
57	5.497G	58	5.615G	59	5.659G	60	5.523G
61	5.341G	62	5.455G	63	5.409G	64	5.479G
65	5.481G	66	5.498G	67	5.280G	68	5.704G
69	5.713G	70	5.470G	71	5.366G	72	5.356G
73	5.416G	74	5.607G	75	5.256G	76	5.454G
77	5.275G	78	5.420G	79	5.421G	80	5.627G
81	5.714G	82	5.542G	83	5.281G	84	5.289G
85	5.359G	86	5.311G	87	5.573G	88	5.645G
89	5.623G	90	5.690G	91	5.296G	92	5.465G
93	5.373G	94	5.509G	95	5.369G	96	5.282G
97	5.372G	98	5.348G	99	5.547G	100	5.681G

Hopping Frequency Sequence Name: HOP_FREQ_SEQ_16							
SEQ#	Frequency (Hz)	SEQ#	Frequency (Hz)	SEQ#	Frequency (Hz)	SEQ#	Frequency (Hz)
1	5.301G	2	5.473G	3	5.670G	4	5.364G
5	5.667G	6	5.471G	7	5.477G	8	5.508G
9	5.556G	10	5.320G	11	5.359G	12	5.558G
13	5.314G	14	5.581G	15	5.624G	16	5.656G
17	5.446G	18	5.502G	19	5.303G	20	5.361G
21	5.655G	22	5.485G	23	5.531G	24	5.406G
25	5.719G	26	5.565G	27	5.421G	28	5.657G
29	5.677G	30	5.307G	31	5.313G	32	5.537G
33	5.648G	34	5.542G	35	5.724G	36	5.689G
37	5.264G	38	5.611G	39	5.343G	40	5.405G
41	5.649G	42	5.414G	43	5.682G	44	5.325G
45	5.341G	46	5.296G	47	5.390G	48	5.614G

49	5.260G	50	5.567G	51	5.294G	52	5.444G
53	5.384G	54	5.275G	55	5.606G	56	5.460G
57	5.457G	58	5.373G	59	5.277G	60	5.713G
61	5.284G	62	5.602G	63	5.413G	64	5.478G
65	5.647G	66	5.544G	67	5.660G	68	5.626G
69	5.609G	70	5.439G	71	5.548G	72	5.358G
73	5.585G	74	5.643G	75	5.319G	76	5.597G
77	5.526G	78	5.554G	79	5.372G	80	5.493G
81	5.271G	82	5.340G	83	5.286G	84	5.506G
85	5.367G	86	5.662G	87	5.678G	88	5.467G
89	5.309G	90	5.424G	91	5.536G	92	5.632G
93	5.703G	94	5.386G	95	5.651G	96	5.570G
97	5.716G	98	5.253G	99	5.644G	100	5.491G

Hopping Frequency Sequence Name: HOP_FREQ_SEQ_17							
SEQ#	Frequency (Hz)	SEQ#	Frequency (Hz)	SEQ#	Frequency (Hz)	SEQ#	Frequency (Hz)
1	5.291G	2	5.604G	3	5.711G	4	5.721G
5	5.310G	6	5.283G	7	5.413G	8	5.623G
9	5.595G	10	5.570G	11	5.603G	12	5.338G
13	5.416G	14	5.439G	15	5.432G	16	5.523G
17	5.428G	18	5.468G	19	5.334G	20	5.656G
21	5.387G	22	5.611G	23	5.608G	24	5.385G
25	5.687G	26	5.363G	27	5.622G	28	5.682G
29	5.503G	30	5.696G	31	5.565G	32	5.336G
33	5.449G	34	5.321G	35	5.396G	36	5.300G
37	5.620G	38	5.599G	39	5.456G	40	5.673G
41	5.712G	42	5.315G	43	5.355G	44	5.613G
45	5.636G	46	5.590G	47	5.312G	48	5.557G
49	5.305G	50	5.380G	51	5.605G	52	5.384G
53	5.463G	54	5.400G	55	5.451G	56	5.643G
57	5.264G	58	5.724G	59	5.415G	60	5.640G
61	5.316G	62	5.579G	63	5.267G	64	5.375G
65	5.671G	66	5.547G	67	5.391G	68	5.318G
69	5.619G	70	5.537G	71	5.342G	72	5.271G
73	5.661G	74	5.542G	75	5.669G	76	5.710G
77	5.574G	78	5.586G	79	5.524G	80	5.378G
81	5.659G	82	5.423G	83	5.644G	84	5.258G

85	5.268G	86	5.377G	87	5.462G	88	5.529G
89	5.577G	90	5.684G	91	5.628G	92	5.648G
93	5.703G	94	5.543G	95	5.641G	96	5.531G
97	5.361G	98	5.365G	99	5.297G	100	5.362G

Hopping Frequency Sequence Name: HOP_FREQ_SEQ_18							
SEQ#	Frequency (Hz)	SEQ#	Frequency (Hz)	SEQ#	Frequency (Hz)	SEQ#	Frequency (Hz)
1	5.521G	2	5.365G	3	5.664G	4	5.548G
5	5.281G	6	5.534G	7	5.546G	8	5.276G
9	5.275G	10	5.292G	11	5.301G	12	5.597G
13	5.316G	14	5.595G	15	5.667G	16	5.641G
17	5.589G	18	5.269G	19	5.619G	20	5.611G
21	5.399G	22	5.274G	23	5.508G	24	5.333G
25	5.307G	26	5.605G	27	5.699G	28	5.604G
29	5.474G	30	5.435G	31	5.551G	32	5.693G
33	5.253G	34	5.700G	35	5.347G	36	5.405G
37	5.425G	38	5.309G	39	5.496G	40	5.343G
41	5.422G	42	5.341G	43	5.498G	44	5.433G
45	5.408G	46	5.633G	47	5.362G	48	5.639G
49	5.663G	50	5.550G	51	5.610G	52	5.487G
53	5.381G	54	5.349G	55	5.598G	56	5.657G
57	5.599G	58	5.300G	59	5.272G	60	5.383G
61	5.531G	62	5.560G	63	5.367G	64	5.417G
65	5.295G	66	5.661G	67	5.632G	68	5.557G
69	5.437G	70	5.416G	71	5.622G	72	5.704G
73	5.488G	74	5.370G	75	5.317G	76	5.583G
77	5.642G	78	5.407G	79	5.410G	80	5.715G
81	5.658G	82	5.466G	83	5.593G	84	5.532G
85	5.375G	86	5.252G	87	5.378G	88	5.578G
89	5.697G	90	5.413G	91	5.396G	92	5.293G
93	5.629G	94	5.371G	95	5.500G	96	5.411G
97	5.592G	98	5.460G	99	5.567G	100	5.288G

Hopping Frequency Sequence Name: HOP_FREQ_SEQ_19							
SEQ#	Frequency (Hz)	SEQ#	Frequency (Hz)	SEQ#	Frequency (Hz)	SEQ#	Frequency (Hz)
1	5.289G	2	5.358G	3	5.453G	4	5.440G
5	5.312G	6	5.469G	7	5.701G	8	5.292G
9	5.309G	10	5.467G	11	5.342G	12	5.695G
13	5.525G	14	5.473G	15	5.569G	16	5.529G
17	5.334G	18	5.588G	19	5.532G	20	5.592G
21	5.443G	22	5.722G	23	5.454G	24	5.508G
25	5.378G	26	5.487G	27	5.338G	28	5.496G
29	5.434G	30	5.663G	31	5.633G	32	5.531G
33	5.463G	34	5.616G	35	5.630G	36	5.333G
37	5.626G	38	5.468G	39	5.363G	40	5.279G
41	5.404G	42	5.311G	43	5.683G	44	5.416G
45	5.368G	46	5.484G	47	5.310G	48	5.702G
49	5.514G	50	5.542G	51	5.421G	52	5.268G
53	5.283G	54	5.520G	55	5.457G	56	5.438G
57	5.493G	58	5.323G	59	5.266G	60	5.331G
61	5.433G	62	5.715G	63	5.682G	64	5.582G
65	5.321G	66	5.388G	67	5.585G	68	5.330G
69	5.322G	70	5.314G	71	5.551G	72	5.365G
73	5.301G	74	5.623G	75	5.401G	76	5.370G
77	5.429G	78	5.284G	79	5.271G	80	5.672G
81	5.721G	82	5.658G	83	5.351G	84	5.361G
85	5.717G	86	5.287G	87	5.714G	88	5.606G
89	5.480G	90	5.684G	91	5.318G	92	5.693G
93	5.405G	94	5.261G	95	5.485G	96	5.417G
97	5.636G	98	5.448G	99	5.698G	100	5.295G

Hopping Frequency Sequence Name: HOP_FREQ_SEQ_20							
SEQ#	Frequency (Hz)	SEQ#	Frequency (Hz)	SEQ#	Frequency (Hz)	SEQ#	Frequency (Hz)
1	5.705G	2	5.525G	3	5.712G	4	5.547G
5	5.640G	6	5.681G	7	5.450G	8	5.352G
9	5.561G	10	5.469G	11	5.558G	12	5.674G
13	5.484G	14	5.536G	15	5.527G	16	5.444G
17	5.425G	18	5.327G	19	5.359G	20	5.570G

21	5.482G	22	5.512G	23	5.301G	24	5.330G
25	5.620G	26	5.355G	27	5.615G	28	5.318G
29	5.568G	30	5.313G	31	5.454G	32	5.552G
33	5.627G	34	5.542G	35	5.488G	36	5.545G
37	5.562G	38	5.716G	39	5.515G	40	5.508G
41	5.574G	42	5.315G	43	5.480G	44	5.294G
45	5.394G	46	5.537G	47	5.585G	48	5.328G
49	5.297G	50	5.688G	51	5.332G	52	5.581G
53	5.380G	54	5.576G	55	5.451G	56	5.284G
57	5.452G	58	5.422G	59	5.486G	60	5.507G
61	5.524G	62	5.575G	63	5.329G	64	5.283G
65	5.580G	66	5.291G	67	5.416G	68	5.643G
69	5.619G	70	5.589G	71	5.320G	72	5.711G
73	5.434G	74	5.473G	75	5.555G	76	5.504G
77	5.541G	78	5.260G	79	5.461G	80	5.350G
81	5.715G	82	5.456G	83	5.679G	84	5.676G
85	5.638G	86	5.478G	87	5.288G	88	5.277G
89	5.393G	90	5.466G	91	5.341G	92	5.386G
93	5.666G	94	5.453G	95	5.337G	96	5.358G
97	5.455G	98	5.413G	99	5.254G	100	5.414G

Hopping Frequency Sequence Name: HOP_FREQ_SEQ_21							
SEQ#	Frequency (Hz)	SEQ#	Frequency (Hz)	SEQ#	Frequency (Hz)	SEQ#	Frequency (Hz)
1	5.380G	2	5.680G	3	5.652G	4	5.398G
5	5.386G	6	5.422G	7	5.353G	8	5.369G
9	5.283G	10	5.578G	11	5.468G	12	5.405G
13	5.645G	14	5.605G	15	5.642G	16	5.312G
17	5.449G	18	5.464G	19	5.370G	20	5.383G
21	5.539G	22	5.653G	23	5.389G	24	5.570G
25	5.723G	26	5.697G	27	5.639G	28	5.598G
29	5.450G	30	5.676G	31	5.553G	32	5.257G
33	5.621G	34	5.296G	35	5.604G	36	5.366G
37	5.618G	38	5.318G	39	5.537G	40	5.626G
41	5.611G	42	5.499G	43	5.270G	44	5.359G
45	5.647G	46	5.409G	47	5.679G	48	5.686G
49	5.620G	50	5.555G	51	5.658G	52	5.334G
53	5.475G	54	5.328G	55	5.377G	56	5.674G

57	5.264G	58	5.517G	59	5.385G	60	5.254G
61	5.397G	62	5.443G	63	5.478G	64	5.584G
65	5.648G	66	5.547G	67	5.378G	68	5.687G
69	5.519G	70	5.396G	71	5.518G	72	5.597G
73	5.702G	74	5.348G	75	5.581G	76	5.567G
77	5.271G	78	5.454G	79	5.325G	80	5.573G
81	5.552G	82	5.374G	83	5.293G	84	5.544G
85	5.282G	86	5.448G	87	5.309G	88	5.612G
89	5.395G	90	5.557G	91	5.575G	92	5.323G
93	5.319G	94	5.536G	95	5.722G	96	5.387G
97	5.551G	98	5.259G	99	5.298G	100	5.582G

Hopping Frequency Sequence Name: HOP_FREQ_SEQ_22							
SEQ#	Frequency (Hz)	SEQ#	Frequency (Hz)	SEQ#	Frequency (Hz)	SEQ#	Frequency (Hz)
1	5.596G	2	5.649G	3	5.400G	4	5.522G
5	5.443G	6	5.391G	7	5.651G	8	5.535G
9	5.337G	10	5.268G	11	5.387G	12	5.587G
13	5.342G	14	5.274G	15	5.657G	16	5.351G
17	5.367G	18	5.565G	19	5.509G	20	5.523G
21	5.350G	22	5.280G	23	5.442G	24	5.584G
25	5.628G	26	5.422G	27	5.335G	28	5.372G
29	5.491G	30	5.462G	31	5.604G	32	5.363G
33	5.302G	34	5.658G	35	5.666G	36	5.578G
37	5.269G	38	5.263G	39	5.529G	40	5.308G
41	5.532G	42	5.287G	43	5.436G	44	5.528G
45	5.284G	46	5.689G	47	5.467G	48	5.665G
49	5.688G	50	5.333G	51	5.554G	52	5.722G
53	5.504G	54	5.285G	55	5.306G	56	5.551G
57	5.384G	58	5.580G	59	5.407G	60	5.361G
61	5.373G	62	5.676G	63	5.482G	64	5.347G
65	5.500G	66	5.710G	67	5.662G	68	5.623G
69	5.322G	70	5.612G	71	5.444G	72	5.429G
73	5.460G	74	5.629G	75	5.360G	76	5.313G
77	5.541G	78	5.416G	79	5.561G	80	5.619G
81	5.704G	82	5.300G	83	5.631G	84	5.611G
85	5.488G	86	5.618G	87	5.552G	88	5.250G
89	5.371G	90	5.258G	91	5.251G	92	5.633G

93	5.475G	94	5.639G	95	5.566G	96	5.632G
97	5.358G	98	5.617G	99	5.492G	100	5.498G

Hopping Frequency Sequence Name: HOP_FREQ_SEQ_23							
SEQ#	Frequency (Hz)	SEQ#	Frequency (Hz)	SEQ#	Frequency (Hz)	SEQ#	Frequency (Hz)
1	5.494G	2	5.369G	3	5.704G	4	5.580G
5	5.497G	6	5.598G	7	5.462G	8	5.435G
9	5.459G	10	5.591G	11	5.559G	12	5.495G
13	5.302G	14	5.558G	15	5.609G	16	5.306G
17	5.632G	18	5.639G	19	5.425G	20	5.702G
21	5.252G	22	5.263G	23	5.427G	24	5.330G
25	5.316G	26	5.253G	27	5.687G	28	5.266G
29	5.692G	30	5.472G	31	5.682G	32	5.708G
33	5.719G	34	5.716G	35	5.650G	36	5.717G
37	5.350G	38	5.452G	39	5.431G	40	5.429G
41	5.319G	42	5.393G	43	5.503G	44	5.620G
45	5.290G	46	5.400G	47	5.614G	48	5.312G
49	5.568G	50	5.373G	51	5.445G	52	5.636G
53	5.634G	54	5.331G	55	5.328G	56	5.483G
57	5.303G	58	5.700G	59	5.310G	60	5.505G
61	5.590G	62	5.533G	63	5.343G	64	5.711G
65	5.551G	66	5.506G	67	5.476G	68	5.407G
69	5.398G	70	5.357G	71	5.485G	72	5.292G
73	5.612G	74	5.584G	75	5.481G	76	5.694G
77	5.264G	78	5.683G	79	5.541G	80	5.475G
81	5.693G	82	5.388G	83	5.635G	84	5.555G
85	5.608G	86	5.283G	87	5.308G	88	5.493G
89	5.570G	90	5.260G	91	5.557G	92	5.411G
93	5.413G	94	5.295G	95	5.713G	96	5.507G
97	5.451G	98	5.254G	99	5.471G	100	5.709G

Hopping Frequency Sequence Name: HOP_FREQ_SEQ_24							
SEQ#	Frequency (Hz)	SEQ#	Frequency (Hz)	SEQ#	Frequency (Hz)	SEQ#	Frequency (Hz)
1	5.578G	2	5.505G	3	5.309G	4	5.599G
5	5.343G	6	5.532G	7	5.354G	8	5.671G
9	5.262G	10	5.602G	11	5.533G	12	5.250G

13	5.320G	14	5.632G	15	5.610G	16	5.308G
17	5.539G	18	5.717G	19	5.428G	20	5.707G
21	5.701G	22	5.442G	23	5.603G	24	5.375G
25	5.334G	26	5.706G	27	5.626G	28	5.702G
29	5.453G	30	5.703G	31	5.319G	32	5.478G
33	5.378G	34	5.520G	35	5.509G	36	5.447G
37	5.563G	38	5.678G	39	5.569G	40	5.346G
41	5.598G	42	5.596G	43	5.471G	44	5.680G
45	5.622G	46	5.306G	47	5.348G	48	5.468G
49	5.685G	50	5.633G	51	5.302G	52	5.665G
53	5.260G	54	5.494G	55	5.321G	56	5.480G
57	5.571G	58	5.661G	59	5.410G	60	5.394G
61	5.664G	62	5.570G	63	5.292G	64	5.630G
65	5.416G	66	5.545G	67	5.605G	68	5.639G
69	5.646G	70	5.593G	71	5.379G	72	5.648G
73	5.487G	74	5.625G	75	5.450G	76	5.301G
77	5.637G	78	5.549G	79	5.503G	80	5.564G
81	5.353G	82	5.662G	83	5.623G	84	5.565G
85	5.548G	86	5.467G	87	5.700G	88	5.445G
89	5.257G	90	5.360G	91	5.357G	92	5.543G
93	5.363G	94	5.519G	95	5.377G	96	5.463G
97	5.432G	98	5.328G	99	5.427G	100	5.281G

Hopping Frequency Sequence Name: HOP_FREQ_SEQ_25							
SEQ#	Frequency (Hz)	SEQ#	Frequency (Hz)	SEQ#	Frequency (Hz)	SEQ#	Frequency (Hz)
1	5.551G	2	5.406G	3	5.488G	4	5.357G
5	5.539G	6	5.635G	7	5.633G	8	5.518G
9	5.672G	10	5.636G	11	5.527G	12	5.450G
13	5.601G	14	5.279G	15	5.651G	16	5.641G
17	5.699G	18	5.323G	19	5.555G	20	5.274G
21	5.421G	22	5.505G	23	5.399G	24	5.674G
25	5.317G	26	5.306G	27	5.292G	28	5.609G
29	5.254G	30	5.686G	31	5.309G	32	5.537G
33	5.307G	34	5.523G	35	5.288G	36	5.632G
37	5.320G	38	5.715G	39	5.398G	40	5.335G
41	5.340G	42	5.509G	43	5.613G	44	5.458G
45	5.703G	46	5.506G	47	5.353G	48	5.375G

49	5.504G	50	5.623G	51	5.409G	52	5.516G
53	5.269G	54	5.610G	55	5.431G	56	5.554G
57	5.682G	58	5.679G	59	5.625G	60	5.696G
61	5.325G	62	5.534G	63	5.701G	64	5.478G
65	5.411G	66	5.347G	67	5.638G	68	5.430G
69	5.272G	70	5.657G	71	5.298G	72	5.700G
73	5.480G	74	5.680G	75	5.416G	76	5.376G
77	5.646G	78	5.587G	79	5.395G	80	5.514G
81	5.467G	82	5.343G	83	5.627G	84	5.316G
85	5.622G	86	5.559G	87	5.637G	88	5.541G
89	5.469G	90	5.662G	91	5.465G	92	5.466G
93	5.714G	94	5.310G	95	5.295G	96	5.337G
97	5.675G	98	5.293G	99	5.608G	100	5.558G

Hopping Frequency Sequence Name: HOP_FREQ_SEQ_26							
SEQ#	Frequency (Hz)	SEQ#	Frequency (Hz)	SEQ#	Frequency (Hz)	SEQ#	Frequency (Hz)
1	5.270G	2	5.280G	3	5.623G	4	5.597G
5	5.639G	6	5.290G	7	5.674G	8	5.438G
9	5.630G	10	5.284G	11	5.360G	12	5.389G
13	5.561G	14	5.530G	15	5.541G	16	5.604G
17	5.300G	18	5.704G	19	5.430G	20	5.564G
21	5.482G	22	5.675G	23	5.680G	24	5.590G
25	5.303G	26	5.268G	27	5.622G	28	5.508G
29	5.603G	30	5.474G	31	5.316G	32	5.497G
33	5.466G	34	5.660G	35	5.579G	36	5.450G
37	5.646G	38	5.415G	39	5.317G	40	5.707G
41	5.330G	42	5.322G	43	5.628G	44	5.484G
45	5.664G	46	5.700G	47	5.428G	48	5.371G
49	5.636G	50	5.377G	51	5.465G	52	5.481G
53	5.475G	54	5.665G	55	5.253G	56	5.591G
57	5.624G	58	5.609G	59	5.299G	60	5.440G
61	5.418G	62	5.384G	63	5.483G	64	5.582G
65	5.388G	66	5.666G	67	5.457G	68	5.708G
69	5.642G	70	5.411G	71	5.608G	72	5.627G
73	5.410G	74	5.499G	75	5.405G	76	5.544G
77	5.494G	78	5.718G	79	5.339G	80	5.442G
81	5.616G	82	5.261G	83	5.560G	84	5.373G

85	5.533G	86	5.263G	87	5.578G	88	5.509G
89	5.265G	90	5.691G	91	5.670G	92	5.369G
93	5.715G	94	5.283G	95	5.567G	96	5.407G
97	5.570G	98	5.645G	99	5.313G	100	5.306G

Hopping Frequency Sequence Name: HOP_FREQ_SEQ_27							
SEQ#	Frequency (Hz)	SEQ#	Frequency (Hz)	SEQ#	Frequency (Hz)	SEQ#	Frequency (Hz)
1	5.416G	2	5.254G	3	5.482G	4	5.523G
5	5.395G	6	5.387G	7	5.407G	8	5.685G
9	5.382G	10	5.352G	11	5.704G	12	5.721G
13	5.466G	14	5.348G	15	5.477G	16	5.540G
17	5.302G	18	5.568G	19	5.450G	20	5.521G
21	5.708G	22	5.326G	23	5.600G	24	5.411G
25	5.606G	26	5.278G	27	5.535G	28	5.616G
29	5.676G	30	5.536G	31	5.562G	32	5.662G
33	5.693G	34	5.688G	35	5.396G	36	5.461G
37	5.251G	38	5.417G	39	5.627G	40	5.598G
41	5.338G	42	5.555G	43	5.552G	44	5.362G
45	5.608G	46	5.316G	47	5.647G	48	5.397G
49	5.646G	50	5.331G	51	5.534G	52	5.250G
53	5.720G	54	5.480G	55	5.304G	56	5.611G
57	5.663G	58	5.405G	59	5.446G	60	5.700G
61	5.603G	62	5.515G	63	5.497G	64	5.341G
65	5.299G	66	5.376G	67	5.410G	68	5.545G
69	5.294G	70	5.711G	71	5.325G	72	5.285G
73	5.287G	74	5.644G	75	5.705G	76	5.690G
77	5.577G	78	5.363G	79	5.381G	80	5.588G
81	5.557G	82	5.436G	83	5.543G	84	5.378G
85	5.453G	86	5.589G	87	5.273G	88	5.615G
89	5.503G	90	5.559G	91	5.398G	92	5.621G
93	5.379G	94	5.394G	95	5.699G	96	5.619G
97	5.452G	98	5.502G	99	5.270G	100	5.255G

Hopping Frequency Sequence Name: HOP_FREQ_SEQ_28							
SEQ#	Frequency (Hz)	SEQ#	Frequency (Hz)	SEQ#	Frequency (Hz)	SEQ#	Frequency (Hz)
1	5.338G	2	5.353G	3	5.309G	4	5.401G

5	5.349G	6	5.659G	7	5.709G	8	5.679G
9	5.683G	10	5.544G	11	5.280G	12	5.382G
13	5.580G	14	5.379G	15	5.607G	16	5.551G
17	5.514G	18	5.260G	19	5.479G	20	5.714G
21	5.699G	22	5.494G	23	5.292G	24	5.316G
25	5.571G	26	5.691G	27	5.444G	28	5.655G
29	5.390G	30	5.584G	31	5.430G	32	5.393G
33	5.562G	34	5.633G	35	5.274G	36	5.368G
37	5.325G	38	5.436G	39	5.589G	40	5.472G
41	5.441G	42	5.285G	43	5.276G	44	5.478G
45	5.632G	46	5.535G	47	5.253G	48	5.581G
49	5.399G	50	5.255G	51	5.624G	52	5.715G
53	5.327G	54	5.340G	55	5.596G	56	5.323G
57	5.635G	58	5.261G	59	5.431G	60	5.331G
61	5.265G	62	5.394G	63	5.381G	64	5.626G
65	5.453G	66	5.308G	67	5.448G	68	5.582G
69	5.525G	70	5.644G	71	5.541G	72	5.687G
73	5.277G	74	5.304G	75	5.660G	76	5.618G
77	5.256G	78	5.366G	79	5.647G	80	5.565G
81	5.671G	82	5.252G	83	5.370G	84	5.496G
85	5.567G	86	5.395G	87	5.642G	88	5.588G
89	5.638G	90	5.389G	91	5.648G	92	5.458G
93	5.523G	94	5.563G	95	5.716G	96	5.597G
97	5.559G	98	5.426G	99	5.334G	100	5.534G

Hopping Frequency Sequence Name: HOP_FREQ_SEQ_29							
SEQ#	Frequency (Hz)	SEQ#	Frequency (Hz)	SEQ#	Frequency (Hz)	SEQ#	Frequency (Hz)
1	5.270G	2	5.282G	3	5.447G	4	5.316G
5	5.548G	6	5.334G	7	5.647G	8	5.576G
9	5.659G	10	5.314G	11	5.386G	12	5.345G
13	5.324G	14	5.290G	15	5.515G	16	5.597G
17	5.573G	18	5.470G	19	5.364G	20	5.712G
21	5.649G	22	5.461G	23	5.685G	24	5.320G
25	5.366G	26	5.413G	27	5.635G	28	5.411G
29	5.374G	30	5.351G	31	5.586G	32	5.286G
33	5.522G	34	5.390G	35	5.275G	36	5.349G
37	5.575G	38	5.258G	39	5.274G	40	5.662G

41	5.429G	42	5.658G	43	5.549G	44	5.449G
45	5.430G	46	5.634G	47	5.599G	48	5.695G
49	5.438G	50	5.454G	51	5.518G	52	5.384G
53	5.698G	54	5.525G	55	5.663G	56	5.672G
57	5.651G	58	5.279G	59	5.485G	60	5.631G
61	5.358G	62	5.406G	63	5.456G	64	5.622G
65	5.716G	66	5.620G	67	5.431G	68	5.460G
69	5.643G	70	5.359G	71	5.562G	72	5.288G
73	5.714G	74	5.289G	75	5.408G	76	5.572G
77	5.445G	78	5.577G	79	5.452G	80	5.371G
81	5.446G	82	5.262G	83	5.471G	84	5.656G
85	5.307G	86	5.574G	87	5.260G	88	5.362G
89	5.420G	90	5.674G	91	5.595G	92	5.629G
93	5.667G	94	5.387G	95	5.424G	96	5.709G
97	5.325G	98	5.507G	99	5.570G	100	5.513G

Hopping Frequency Sequence Name: HOP_FREQ_SEQ_30							
SEQ#	Frequency (Hz)	SEQ#	Frequency (Hz)	SEQ#	Frequency (Hz)	SEQ#	Frequency (Hz)
1	5.578G	2	5.337G	3	5.417G	4	5.700G
5	5.342G	6	5.667G	7	5.428G	8	5.415G
9	5.639G	10	5.525G	11	5.526G	12	5.533G
13	5.261G	14	5.631G	15	5.545G	16	5.577G
17	5.612G	18	5.498G	19	5.393G	20	5.574G
21	5.550G	22	5.718G	23	5.298G	24	5.520G
25	5.255G	26	5.387G	27	5.356G	28	5.444G
29	5.448G	30	5.353G	31	5.668G	32	5.402G
33	5.414G	34	5.637G	35	5.676G	36	5.363G
37	5.445G	38	5.354G	39	5.403G	40	5.267G
41	5.703G	42	5.560G	43	5.559G	44	5.680G
45	5.506G	46	5.257G	47	5.365G	48	5.317G
49	5.454G	50	5.629G	51	5.260G	52	5.543G
53	5.673G	54	5.620G	55	5.389G	56	5.627G
57	5.661G	58	5.386G	59	5.645G	60	5.373G
61	5.623G	62	5.456G	63	5.606G	64	5.289G
65	5.658G	66	5.258G	67	5.584G	68	5.446G
69	5.483G	70	5.427G	71	5.399G	72	5.457G
73	5.642G	74	5.299G	75	5.603G	76	5.552G

77	5.495G	78	5.576G	79	5.715G	80	5.652G
81	5.449G	82	5.410G	83	5.626G	84	5.651G
85	5.538G	86	5.687G	87	5.346G	88	5.250G
89	5.692G	90	5.252G	91	5.322G	92	5.632G
93	5.659G	94	5.681G	95	5.585G	96	5.426G
97	5.635G	98	5.657G	99	5.704G	100	5.297G

IEEE 802.11an HT40

Type 1 Radar Statistical Performances				
Trial #	Pulses per Burst	Pulse Width (s)	PRI (s)	Detection
1	102	1.0u	518.0u	Yes
2	95	1.0u	558.0u	Yes
3	92	1.0u	578.0u	Yes
4	86	1.0u	618.0u	Yes
5	81	1.0u	658.0u	Yes
6	76	1.0u	698.0u	Yes
7	72	1.0u	738.0u	Yes
8	67	1.0u	798.0u	Yes
9	65	1.0u	818.0u	Yes
10	62	1.0u	858.0u	Yes
11	61	1.0u	878.0u	Yes
12	59	1.0u	898.0u	Yes
13	58	1.0u	918.0u	Yes
14	57	1.0u	938.0u	Yes
15	18	1.0u	3.066m	Yes
16	95	1.0u	559.0u	Yes
17	89	1.0u	599.0u	Yes
18	76	1.0u	699.0u	Yes
19	91	1.0u	581.0u	Yes
20	78	1.0u	681.0u	Yes
21	59	1.0u	901.0u	Yes
22	94	1.0u	565.0u	Yes
23	80	1.0u	665.0u	Yes
24	93	1.0u	569.0u	Yes
25	73	1.0u	729.0u	Yes
26	63	1.0u	849.0u	Yes
27	93	1.0u	573.0u	Yes
28	77	1.0u	693.0u	Yes
29	61	1.0u	873.0u	Yes
30	56	1.0u	953.0u	Yes
				Detection Rate: 100.0 %

Type 2 Radar Statistical Performances				
Trial #	Pulses per Burst	Pulse Width (s)	PRI (s)	Detection
1	24	1.8u	180.0u	Yes
2	23	4.8u	213.0u	Yes
3	24	1.2u	177.0u	No
4	27	2.4u	206.0u	Yes
5	26	1.5u	153.0u	Yes
6	26	1.0u	158.0u	No
7	25	4.4u	193.0u	Yes
8	27	4.9u	167.0u	No
9	28	3.9u	197.0u	Yes
10	26	3.4u	152.0u	Yes
11	26	3.0u	175.0u	Yes
12	25	1.1u	185.0u	Yes
13	24	3.9u	174.0u	Yes
14	24	1.4u	175.0u	Yes
15	28	2.5u	188.0u	No
16	24	3.8u	209.0u	Yes
17	28	1.6u	200.0u	Yes
18	25	1.7u	187.0u	No
19	25	4.8u	164.0u	No
20	25	2.5u	172.0u	Yes
21	29	4.7u	179.0u	Yes
22	26	4.1u	181.0u	Yes
23	25	4.1u	223.0u	Yes
24	29	1.4u	195.0u	Yes
25	26	1.2u	185.0u	Yes
26	26	2.8u	171.0u	Yes
27	27	4.5u	156.0u	Yes
28	25	1.1u	203.0u	Yes
29	29	1.3u	180.0u	Yes
30	28	2.4u	207.0u	Yes
			Detection Rate: 80.0 %	

Type 3 Radar Statistical Performances				
Trial #	Pulses per Burst	Pulse Width (s)	PRI (s)	Detection
1	17	7.6u	336.0u	Yes
2	18	7.7u	499.0u	Yes
3	17	7.4u	451.0u	Yes
4	17	9.3u	319.0u	Yes
5	17	9.1u	293.0u	Yes
6	17	8.0u	403.0u	Yes
7	16	9.7u	481.0u	Yes
8	17	7.6u	333.0u	Yes
9	18	8.6u	348.0u	Yes
10	18	6.6u	487.0u	Yes
11	17	6.4u	217.0u	No
12	18	6.9u	472.0u	Yes
13	17	9.6u	210.0u	Yes
14	16	9.6u	349.0u	Yes
15	16	6.1u	271.0u	Yes
16	18	7.8u	306.0u	Yes
17	18	9.1u	431.0u	Yes
18	18	9.2u	267.0u	Yes
19	18	9.0u	230.0u	Yes
20	17	6.6u	363.0u	Yes
21	17	8.0u	358.0u	Yes
22	16	8.5u	496.0u	No
23	16	8.5u	472.0u	Yes
24	18	9.0u	392.0u	Yes
25	18	9.8u	284.0u	Yes
26	18	7.0u	231.0u	Yes
27	17	8.6u	348.0u	Yes
28	17	8.2u	293.0u	Yes
29	17	8.9u	499.0u	Yes
30	17	7.2u	264.0u	Yes
			Detection Rate: 93.3 %	

Type 4 Radar Statistical Performances				
Trial #	Pulses per Burst	Pulse Width (s)	PRI (s)	Detection
1	15	19.6u	390.0u	Yes
2	12	12.2u	297.0u	Yes
3	16	16.1u	379.0u	Yes
4	14	12.9u	383.0u	Yes
5	12	12.8u	409.0u	Yes
6	16	18.7u	486.0u	Yes
7	13	14.8u	490.0u	Yes
8	13	12.8u	369.0u	Yes
9	14	15.4u	298.0u	Yes
10	14	13.8u	312.0u	Yes
11	16	11.3u	472.0u	Yes
12	15	16.1u	443.0u	Yes
13	13	19.6u	317.0u	Yes
14	14	12.4u	245.0u	Yes
15	13	11.1u	277.0u	Yes
16	14	16.6u	235.0u	Yes
17	13	18.0u	204.0u	No
18	16	11.8u	266.0u	Yes
19	12	12.4u	318.0u	Yes
20	12	14.3u	463.0u	Yes
21	14	14.3u	472.0u	Yes
22	12	15.2u	434.0u	Yes
23	13	13.9u	395.0u	Yes
24	13	15.0u	457.0u	Yes
25	13	13.7u	335.0u	Yes
26	14	13.2u	343.0u	Yes
27	15	14.5u	387.0u	Yes
28	16	11.4u	444.0u	Yes
29	14	19.4u	317.0u	No
30	16	16.4u	429.0u	Yes
			Detection Rate: 93.3 %	

Type 5 Radar Statistical Performances		
Trial #	Test Signal Name	Detection
1	LP_Signal_01	Yes
2	LP_Signal_02	Yes
3	LP_Signal_03	Yes
4	LP_Signal_04	Yes
5	LP_Signal_05	Yes
6	LP_Signal_06	Yes
7	LP_Signal_07	Yes
8	LP_Signal_08	Yes
9	LP_Signal_09	Yes
10	LP_Signal_10	Yes
11	LP_Signal_11	Yes
12	LP_Signal_12	Yes
13	LP_Signal_13	Yes
14	LP_Signal_14	Yes
15	LP_Signal_15	Yes
16	LP_Signal_16	Yes
17	LP_Signal_17	Yes
18	LP_Signal_18	Yes
19	LP_Signal_19	Yes
20	LP_Signal_20	Yes
21	LP_Signal_21	Yes
22	LP_Signal_22	Yes
23	LP_Signal_23	Yes
24	LP_Signal_24	Yes
25	LP_Signal_25	Yes
26	LP_Signal_26	Yes
27	LP_Signal_27	Yes
28	LP_Signal_28	Yes
29	LP_Signal_29	Yes
30	LP_Signal_30	Yes
		Detection Rate: 100.0 %

Long Pulse Radar Test Signal						
Test Signal Name: LP_Signal_01						
Number of Bursts in Trial: 20						
Chrip Center Frequency: 5495MHz						
Burst	Pulses per Burst	Chrip (Hz)	Pulse Width (s)	Pulse 1 to 2 Spacing (s)	Pulse 2 to 3 Spacing (s)	Start Location (s)
1	2	14M	64.2u	1.059m	-	552.7m
2	2	8M	83.1u	1.801m	-	396.6m
3	3	8M	90.3u	1.063m	1.369m	567.2m
4	2	11M	73.1u	1.174m	-	467.5m
5	1	15M	57.9u	-	-	374.5m
6	1	13M	88.6u	-	-	468.9m
7	1	5M	61.4u	-	-	18.80m
8	2	10M	73.5u	1.411m	-	530.1m
9	1	9M	59.7u	-	-	186.2m
10	3	7M	98.9u	1.144m	1.052m	254.1m
11	1	18M	88.7u	-	-	572.9m
12	3	10M	91.3u	1.260m	1.620m	208.4m
13	2	8M	93.9u	1.418m	-	115.7m
14	2	6M	68.9u	1.666m	-	187.7m
15	2	5M	54.0u	1.496m	-	408.2m
16	1	11M	51.9u	-	-	272.2m
17	2	13M	70.7u	1.362m	-	305.8m
18	2	7M	94.6u	990.4u	-	276.4m
19	2	14M	56.8u	1.555m	-	582.7m
20	3	16M	89.0u	1.034m	1.359m	313.1m

Long Pulse Radar Test Signal						
Test Signal Name: LP_Signal_02						
Number of Bursts in Trial: 17						
Chrip Center Frequency: 5496MHz						
Burst	Pulses per Burst	Chrip (Hz)	Pulse Width (s)	Pulse 1 to 2 Spacing (s)	Pulse 2 to 3 Spacing (s)	Start Location (s)
1	1	12M	97.3u	-	-	386.4m
2	2	17M	95.9u	1.561m	-	634.5m
3	2	9M	91.0u	1.868m	-	154.5m
4	2	11M	95.9u	1.606m	-	297.9m
5	2	17M	52.7u	1.600m	-	600.3m
6	3	6M	67.6u	1.740m	1.786m	594.6m
7	2	16M	60.7u	1.815m	-	95.42m
8	2	11M	85.0u	1.388m	-	466.7m
9	3	17M	58.5u	1.179m	1.312m	520.7m
10	2	17M	98.6u	1.285m	-	6.999m
11	1	17M	77.5u	-	-	57.33m
12	2	18M	54.5u	1.143m	-	617.2m
13	3	5M	98.5u	1.131m	1.425m	313.3m
14	2	9M	97.1u	1.600m	-	242.7m
15	2	16M	67.2u	1.565m	-	108.8m
16	2	6M	63.8u	1.756m	-	29.45m
17	2	12M	80.6u	1.132m	-	140.5m

Long Pulse Radar Test Signal						
Test Signal Name: LP_Signal_03						
Number of Bursts in Trial: 16						
Chrip Center Frequency: 5496MHz						
Burst	Pulses per Burst	Chrip (Hz)	Pulse Width (s)	Pulse 1 to 2 Spacing (s)	Pulse 2 to 3 Spacing (s)	Start Location (s)
1	2	18M	83.8u	1.805m	-	153.0m
2	2	17M	84.9u	1.230m	-	589.8m
3	2	11M	68.7u	1.256m	-	113.0m
4	2	8M	71.4u	1.925m	-	733.4m

5	1	14M	57.9u	-	-	480.1m
6	2	14M	53.1u	1.516m	-	213.7m
7	2	16M	71.2u	1.253m	-	97.67m
8	1	20M	55.4u	-	-	108.3m
9	2	17M	64.0u	1.037m	-	50.59m
10	2	9M	62.6u	1.315m	-	63.70m
11	2	13M	74.1u	988.9u	-	454.2m
12	1	19M	57.1u	-	-	708.1m
13	3	6M	55.6u	1.374m	1.219m	34.45m
14	2	7M	93.5u	1.215m	-	427.0m
15	2	19M	76.5u	985.5u	-	172.4m
16	3	6M	84.2u	1.750m	1.713m	584.7m

Long Pulse Radar Test Signal						
Test Signal Name: LP_Signal_04						
Number of Bursts in Trial: 19						
Chrip Center Frequency: 5497MHz						
Burst	Pulses per Burst	Chrip (Hz)	Pulse Width (s)	Pulse 1 to 2 Spacing (s)	Pulse 2 to 3 Spacing (s)	Start Location (s)
1	2	16M	91.1u	1.711m	-	180.6m
2	1	14M	88.7u	-	-	95.10m
3	3	14M	93.8u	1.149m	991.2u	308.7m
4	2	17M	99.9u	1.336m	-	61.92m
5	1	12M	52.3u	-	-	604.1m
6	3	7M	99.9u	1.789m	954.1u	338.3m
7	1	7M	86.6u	-	-	37.01m
8	2	10M	99.1u	946.9u	-	27.25m
9	2	11M	63.0u	1.442m	-	434.6m
10	2	7M	96.6u	1.784m	-	116.2m
11	3	15M	62.1u	1.919m	1.582m	70.62m
12	1	18M	58.8u	-	-	546.1m
13	2	15M	62.2u	1.731m	-	451.3m
14	2	7M	59.4u	1.667m	-	431.0m
15	3	8M	51.8u	1.334m	1.553m	57.15m
16	2	10M	67.4u	1.044m	-	376.2m
17	2	14M	53.2u	1.475m	-	395.5m

18	3	19M	89.2u	1.134m	1.842m	545.8m
19	3	9M	64.8u	1.443m	1.515m	415.1m

Long Pulse Radar Test Signal						
Test Signal Name: LP_Signal_05						
Number of Bursts in Trial: 9						
Chrip Center Frequency: 5498MHz						
Burst	Pulses per Burst	Chrip (Hz)	Pulse Width (s)	Pulse 1 to 2 Spacing (s)	Pulse 2 to 3 Spacing (s)	Start Location (s)
1	2	19M	98.1u	1.776m	-	253.4m
2	2	15M	56.2u	1.467m	-	1.084
3	2	6M	75.7u	1.367m	-	632.9m
4	2	6M	69.8u	1.860m	-	958.1m
5	3	18M	77.5u	1.330m	1.052m	1.122
6	1	18M	63.9u	-	-	110.3m
7	2	19M	94.4u	1.826m	-	636.9m
8	2	20M	64.5u	1.887m	-	1.019
9	3	7M	74.8u	1.011m	1.304m	1.126

Long Pulse Radar Test Signal						
Test Signal Name: LP_Signal_06						
Number of Bursts in Trial: 13						
Chrip Center Frequency: 5499MHz						
Burst	Pulses per Burst	Chrip (Hz)	Pulse Width (s)	Pulse 1 to 2 Spacing (s)	Pulse 2 to 3 Spacing (s)	Start Location (s)
1	1	9M	85.9u	-	-	577.7m
2	2	20M	73.0u	1.741m	-	418.3m
3	2	8M	65.8u	1.239m	-	875.0m
4	2	20M	79.4u	1.234m	-	633.5m
5	3	11M	56.5u	1.399m	1.630m	869.1m
6	2	9M	80.4u	1.289m	-	77.73m
7	3	10M	97.9u	967.1u	1.454m	512.3m
8	2	12M	73.8u	1.353m	-	179.1m
9	3	7M	56.5u	1.168m	1.553m	232.8m
10	3	16M	92.3u	1.440m	1.466m	457.5m

11	1	19M	62.3u	-	-	828.0m
12	3	16M	81.6u	1.374m	1.655m	583.6m
13	2	14M	63.2u	1.076m	-	239.3m

Long Pulse Radar Test Signal
Test Signal Name: LP_Signal_07
Number of Bursts in Trial: 19
Chrip Center Frequency: 5500MHz

Burst	Pulses per Burst	Chrip (Hz)	Pulse Width (s)	Pulse 1 to 2 Spacing (s)	Pulse 2 to 3 Spacing (s)	Start Location (s)
1	1	19M	59.5u	-	-	156.8m
2	2	15M	83.6u	1.578m	-	511.4m
3	3	17M	60.9u	1.153m	1.606m	416.5m
4	2	11M	93.0u	1.830m	-	141.7m
5	2	10M	59.6u	1.831m	-	171.5m
6	1	16M	65.1u	-	-	329.3m
7	2	8M	50.2u	1.826m	-	333.2m
8	3	19M	68.1u	1.857m	1.003m	483.2m
9	2	9M	99.6u	1.794m	-	393.7m
10	3	19M	78.2u	1.683m	1.446m	229.9m
11	1	11M	65.9u	-	-	98.38m
12	2	17M	66.1u	1.432m	-	622.7m
13	2	15M	97.3u	1.081m	-	433.4m
14	1	15M	58.3u	-	-	453.0m
15	2	6M	75.0u	1.732m	-	517.2m
16	1	7M	64.9u	-	-	396.3m
17	3	9M	71.7u	1.422m	1.586m	214.5m
18	2	12M	88.9u	1.520m	-	69.25m
19	3	5M	58.1u	1.068m	1.719m	304.9m

Long Pulse Radar Test Signal						
Test Signal Name: LP_Signal_08						
Number of Bursts in Trial: 17						
Chrip Center Frequency: 5501MHz						
Burst	Pulses per Burst	Chrip (Hz)	Pulse Width (s)	Pulse 1 to 2 Spacing (s)	Pulse 2 to 3 Spacing (s)	Start Location (s)
1	2	14M	84.3u	1.190m	-	30.69m
2	2	17M	86.0u	1.872m	-	397.6m
3	2	13M	66.2u	1.325m	-	383.1m
4	3	5M	92.2u	1.576m	1.324m	693.6m
5	2	10M	96.1u	1.351m	-	410.5m
6	3	16M	84.8u	1.699m	1.501m	528.4m
7	2	18M	60.5u	1.450m	-	66.48m
8	1	6M	81.5u	-	-	128.5m
9	2	18M	67.0u	1.337m	-	413.2m
10	2	10M	60.8u	1.745m	-	457.9m
11	1	8M	82.9u	-	-	151.3m
12	2	7M	50.1u	1.015m	-	329.0m
13	1	5M	66.1u	-	-	128.9m
14	2	6M	95.0u	1.264m	-	522.3m
15	2	7M	50.9u	1.720m	-	268.9m
16	3	14M	58.9u	1.067m	1.686m	458.1m
17	1	11M	70.1u	-	-	389.6m

Long Pulse Radar Test Signal						
Test Signal Name: LP_Signal_09						
Number of Bursts in Trial: 11						
Chrip Center Frequency: 5502MHz						
Burst	Pulses per Burst	Chrip (Hz)	Pulse Width (s)	Pulse 1 to 2 Spacing (s)	Pulse 2 to 3 Spacing (s)	Start Location (s)
1	2	5M	75.0u	1.721m	-	1.042
2	2	11M	59.5u	1.518m	-	333.8m
3	2	12M	67.0u	1.913m	-	269.9m
4	3	19M	85.7u	1.249m	1.364m	37.14m

5	3	8M	64.6u	1.181m	1.751m	408.1m
6	2	10M	92.5u	933.5u	-	934.1m
7	2	7M	78.8u	1.629m	-	800.6m
8	2	8M	80.8u	1.888m	-	787.2m
9	2	10M	64.6u	1.250m	-	578.8m
10	1	16M	51.7u	-	-	116.7m
11	1	15M	63.5u	-	-	438.5m

Long Pulse Radar Test Signal						
Test Signal Name: LP_Signal_10						
Number of Bursts in Trial: 19						
Chrip Center Frequency: 5503MHz						
Burst	Pulses per Burst	Chrip (Hz)	Pulse Width (s)	Pulse 1 to 2 Spacing (s)	Pulse 2 to 3 Spacing (s)	Start Location (s)
1	3	19M	63.5u	1.520m	1.316m	157.8m
2	2	6M	74.0u	1.618m	-	423.4m
3	2	16M	77.1u	1.676m	-	351.2m
4	1	13M	79.8u	-	-	427.6m
5	3	9M	96.7u	1.475m	1.718m	411.8m
6	2	12M	65.2u	1.171m	-	207.5m
7	2	10M	85.0u	1.357m	-	72.16m
8	2	8M	96.0u	1.637m	-	426.8m
9	2	19M	91.5u	1.602m	-	333.1m
10	2	13M	70.1u	981.9u	-	530.2m
11	2	15M	74.8u	1.679m	-	297.3m
12	2	7M	64.8u	1.916m	-	9.109m
13	1	19M	64.1u	-	-	104.0m
14	3	15M	88.4u	1.629m	1.543m	13.68m
15	2	6M	98.8u	1.572m	-	91.11m
16	2	13M	66.3u	1.885m	-	325.0m
17	2	13M	63.1u	1.637m	-	149.0m
18	2	16M	64.8u	1.666m	-	28.55m
19	3	16M	94.5u	1.298m	1.717m	314.5m

Long Pulse Radar Test Signal						
Test Signal Name: LP_Signal_11						
Number of Bursts in Trial: 20						
Chrip Center Frequency: 5504MHz						
Burst	Pulses per Burst	Chrip (Hz)	Pulse Width (s)	Pulse 1 to 2 Spacing (s)	Pulse 2 to 3 Spacing (s)	Start Location (s)
1	2	16M	90.9u	1.526m	-	525.6m
2	2	19M	63.2u	1.091m	-	67.59m
3	1	13M	95.7u	-	-	197.3m
4	2	20M	96.4u	1.656m	-	68.64m
5	1	5M	65.2u	-	-	199.6m
6	1	7M	83.5u	-	-	540.0m
7	3	19M	95.9u	1.569m	1.135m	296.3m
8	3	13M	56.5u	1.204m	1.114m	166.0m
9	2	17M	83.5u	1.480m	-	471.5m
10	2	10M	63.7u	1.569m	-	123.8m
11	2	16M	76.7u	1.703m	-	340.3m
12	2	15M	61.2u	1.904m	-	294.1m
13	3	17M	56.9u	1.754m	979.1u	241.7m
14	2	17M	58.5u	1.564m	-	535.4m
15	1	18M	61.9u	-	-	510.0m
16	2	9M	83.9u	1.168m	-	172.9m
17	1	9M	52.4u	-	-	173.5m
18	2	5M	89.8u	1.425m	-	138.8m
19	2	10M	97.4u	1.793m	-	68.37m
20	3	8M	71.3u	961.7u	1.411m	42.34m

Long Pulse Radar Test Signal						
Test Signal Name: LP_Signal_12						
Number of Bursts in Trial: 20						
Chrip Center Frequency: 5505MHz						
Burst	Pulses per Burst	Chrip (Hz)	Pulse Width (s)	Pulse 1 to 2 Spacing (s)	Pulse 2 to 3 Spacing (s)	Start Location (s)
1	2	13M	53.9u	1.060m	-	197.3m
2	2	16M	60.5u	1.602m	-	415.6m
3	1	7M	66.1u	-	-	125.7m
4	3	15M	55.0u	1.585m	1.629m	415.0m
5	2	18M	92.3u	1.542m	-	437.0m
6	3	10M	85.7u	961.3u	1.733m	41.45m
7	2	19M	72.6u	1.230m	-	150.5m
8	1	19M	81.5u	-	-	490.2m
9	3	10M	67.8u	1.053m	1.336m	31.63m
10	2	7M	86.7u	1.287m	-	379.2m
11	2	6M	58.1u	1.849m	-	421.9m
12	2	8M	74.4u	1.788m	-	319.3m
13	2	16M	74.3u	1.595m	-	101.9m
14	2	12M	81.0u	1.069m	-	79.78m
15	2	13M	97.4u	1.742m	-	227.5m
16	3	13M	89.1u	1.275m	1.052m	551.6m
17	2	17M	94.0u	1.122m	-	23.70m
18	3	7M	98.7u	1.723m	1.061m	143.0m
19	3	9M	81.2u	1.199m	1.830m	118.2m
20	2	18M	69.6u	1.738m	-	261.1m

Long Pulse Radar Test Signal						
Test Signal Name: LP_Signal_13						
Number of Bursts in Trial: 19						
Chrip Center Frequency: 5506MHz						
Burst	Pulses per Burst	Chrip (Hz)	Pulse Width (s)	Pulse 1 to 2 Spacing (s)	Pulse 2 to 3 Spacing (s)	Start Location (s)
1	2	7M	69.5u	1.086m	-	252.5m

2	2	8M	54.9u	1.425m	-	84.94m
3	3	16M	64.1u	1.346m	1.245m	258.3m
4	2	12M	91.3u	1.034m	-	258.5m
5	2	13M	69.2u	1.374m	-	483.3m
6	3	15M	90.9u	1.239m	991.1u	262.4m
7	3	15M	66.7u	1.838m	1.830m	61.01m
8	2	9M	96.3u	1.837m	-	183.0m
9	2	19M	79.4u	1.684m	-	198.7m
10	2	17M	84.0u	1.297m	-	516.2m
11	1	9M	95.7u	-	-	486.3m
12	2	19M	53.4u	1.125m	-	237.4m
13	3	12M	89.1u	1.676m	1.215m	94.13m
14	3	13M	97.7u	906.3u	1.712m	157.8m
15	3	11M	84.6u	1.459m	1.361m	497.8m
16	2	8M	51.0u	976.0u	-	312.8m
17	1	15M	73.9u	-	-	96.07m
18	2	17M	97.5u	1.287m	-	192.4m
19	3	13M	53.2u	1.577m	1.069m	579.2m

Long Pulse Radar Test Signal						
Test Signal Name: LP_Signal_14						
Number of Bursts in Trial: 8						
Chrip Center Frequency: 5507MHz						
Burst	Pulses per Burst	Chrip (Hz)	Pulse Width (s)	Pulse 1 to 2 Spacing (s)	Pulse 2 to 3 Spacing (s)	Start Location (s)
1	3	14M	87.1u	1.765m	1.565m	61.39m
2	2	12M	82.3u	1.197m	-	1.371
3	2	14M	58.9u	1.114m	-	1.471
4	2	14M	93.1u	1.005m	-	1.080
5	1	14M	97.1u	-	-	322.3m
6	2	18M	74.9u	1.272m	-	1.219
7	1	17M	60.4u	-	-	365.3m
8	2	16M	55.7u	1.388m	-	502.8m

Long Pulse Radar Test Signal						
Test Signal Name: LP_Signal_15						
Number of Bursts in Trial: 12						
Chrip Center Frequency: 5508MHz						
Burst	Pulses per Burst	Chrip (Hz)	Pulse Width (s)	Pulse 1 to 2 Spacing (s)	Pulse 2 to 3 Spacing (s)	Start Location (s)
1	2	10M	79.9u	1.281m	-	809.3m
2	1	8M	75.3u	-	-	799.0m
3	3	12M	68.3u	1.808m	999.7u	834.5m
4	1	7M	52.6u	-	-	42.61m
5	2	16M	80.5u	1.105m	-	898.0m
6	3	5M	56.7u	1.669m	1.257m	284.5m
7	2	12M	53.6u	1.109m	-	636.5m
8	3	15M	93.0u	910.0u	1.678m	213.6m
9	3	15M	55.3u	1.406m	1.258m	95.26m
10	1	17M	68.6u	-	-	765.3m
11	2	9M	54.4u	1.828m	-	736.0m
12	2	17M	73.1u	1.012m	-	829.9m

Long Pulse Radar Test Signal						
Test Signal Name: LP_Signal_16						
Number of Bursts in Trial: 20						
Chrip Center Frequency: 5509MHz						
Burst	Pulses per Burst	Chrip (Hz)	Pulse Width (s)	Pulse 1 to 2 Spacing (s)	Pulse 2 to 3 Spacing (s)	Start Location (s)
1	1	18M	54.3u	-	-	356.1m
2	3	14M	94.5u	1.247m	1.522m	580.2m
3	1	8M	75.9u	-	-	462.9m
4	2	7M	62.9u	1.840m	-	509.7m
5	2	11M	89.9u	1.425m	-	347.3m
6	1	12M	80.6u	-	-	174.9m
7	2	12M	63.0u	1.759m	-	189.8m
8	1	5M	83.4u	-	-	93.20m
9	1	16M	57.9u	-	-	249.4m

10	2	8M	52.0u	1.678m	-	72.75m
11	1	13M	92.2u	-	-	360.0m
12	2	9M	75.2u	1.910m	-	151.4m
13	3	16M	90.6u	1.807m	1.184m	419.1m
14	2	8M	62.2u	954.8u	-	32.33m
15	3	19M	88.8u	1.407m	1.201m	376.7m
16	1	13M	50.1u	-	-	134.7m
17	1	9M	62.0u	-	-	276.9m
18	2	20M	96.8u	1.292m	-	137.9m
19	3	14M	69.7u	1.184m	955.3u	413.2m
20	1	14M	82.8u	-	-	337.5m

Long Pulse Radar Test Signal						
Test Signal Name: LP_Signal_17						
Number of Bursts in Trial: 12						
Chrip Center Frequency: 5510MHz						
Burst	Pulses per Burst	Chrip (Hz)	Pulse Width (s)	Pulse 1 to 2 Spacing (s)	Pulse 2 to 3 Spacing (s)	Start Location (s)
1	2	16M	91.2u	1.553m	-	323.4m
2	2	7M	51.9u	1.276m	-	826.9m
3	2	8M	89.5u	1.189m	-	638.6m
4	2	6M	78.0u	942.0u	-	764.5m
5	1	10M	68.4u	-	-	516.7m
6	2	5M	95.1u	1.893m	-	458.3m
7	2	7M	53.9u	1.781m	-	989.4m
8	2	15M	58.1u	1.622m	-	356.4m
9	3	11M	51.1u	1.573m	1.866m	41.67m
10	3	11M	51.5u	1.401m	1.690m	793.7m
11	3	20M	89.4u	1.398m	913.6u	249.5m
12	3	13M	92.8u	1.707m	1.073m	812.1m

Long Pulse Radar Test Signal						
Test Signal Name: LP_Signal_18						
Number of Bursts in Trial: 9						
Chrip Center Frequency: 5511MHz						
Burst	Pulses per Burst	Chrip (Hz)	Pulse Width (s)	Pulse 1 to 2 Spacing (s)	Pulse 2 to 3 Spacing (s)	Start Location (s)
1	2	8M	65.5u	1.612m	-	1.059
2	1	10M	85.3u	-	-	733.3m
3	3	17M	68.3u	1.031m	1.269m	977.9m
4	1	16M	59.1u	-	-	1.017
5	2	13M	96.2u	1.661m	-	34.33m
6	2	9M	59.6u	1.423m	-	86.83m
7	2	12M	70.0u	1.724m	-	51.12m
8	2	7M	50.5u	1.405m	-	814.3m
9	2	10M	60.8u	1.598m	-	693.0m

Long Pulse Radar Test Signal						
Test Signal Name: LP_Signal_19						
Number of Bursts in Trial: 11						
Chrip Center Frequency: 5512MHz						
Burst	Pulses per Burst	Chrip (Hz)	Pulse Width (s)	Pulse 1 to 2 Spacing (s)	Pulse 2 to 3 Spacing (s)	Start Location (s)
1	1	10M	80.6u	-	-	652.2m
2	3	14M	84.1u	1.477m	1.702m	794.9m
3	2	11M	97.0u	1.160m	-	273.1m
4	1	17M	92.2u	-	-	1.077
5	1	15M	78.6u	-	-	39.50m
6	3	13M	70.2u	1.658m	1.759m	533.6m
7	2	12M	87.0u	1.572m	-	657.1m
8	2	7M	72.8u	1.747m	-	844.5m
9	2	8M	92.9u	1.267m	-	670.0m
10	1	15M	59.1u	-	-	58.26m
11	2	7M	76.0u	1.305m	-	620.3m

Long Pulse Radar Test Signal						
Test Signal Name: LP_Signal_20						
Number of Bursts in Trial: 12						
Chrip Center Frequency: 5513MHz						
Burst	Pulses per Burst	Chrip (Hz)	Pulse Width (s)	Pulse 1 to 2 Spacing (s)	Pulse 2 to 3 Spacing (s)	Start Location (s)
1	1	19M	57.3u	-	-	533.5m
2	1	19M	54.9u	-	-	487.2m
3	2	17M	61.0u	1.458m	-	407.8m
4	3	7M	64.2u	1.389m	1.586m	815.5m
5	2	11M	90.4u	1.345m	-	807.4m
6	3	7M	81.3u	1.278m	1.599m	384.2m
7	2	15M	51.9u	1.350m	-	477.5m
8	3	18M	73.9u	1.676m	1.256m	840.9m
9	2	10M	83.6u	1.801m	-	594.4m
10	2	15M	63.0u	1.835m	-	505.6m
11	3	19M	82.3u	1.894m	1.321m	28.20m
12	1	16M	97.0u	-	-	660.1m

Long Pulse Radar Test Signal						
Test Signal Name: LP_Signal_21						
Number of Bursts in Trial: 16						
Chrip Center Frequency: 5514MHz						
Burst	Pulses per Burst	Chrip (Hz)	Pulse Width (s)	Pulse 1 to 2 Spacing (s)	Pulse 2 to 3 Spacing (s)	Start Location (s)
1	1	15M	85.0u	-	-	302.0m
2	2	16M	90.0u	1.364m	-	295.1m
3	2	8M	60.0u	1.226m	-	304.6m
4	2	20M	67.8u	1.419m	-	722.8m
5	1	11M	89.2u	-	-	571.1m
6	1	12M	98.0u	-	-	711.1m
7	1	12M	76.9u	-	-	147.8m
8	3	14M	83.2u	1.026m	1.726m	289.0m
9	1	18M	93.9u	-	-	430.8m
10	2	14M	67.8u	1.504m	-	150.2m

11	1	14M	54.5u	-	-	729.7m
12	2	16M	93.4u	1.835m	-	624.5m
13	1	17M	66.0u	-	-	70.58m
14	3	15M	74.5u	958.5u	1.026m	199.2m
15	2	14M	62.8u	1.734m	-	471.7m
16	2	5M	91.4u	1.054m	-	672.3m

Long Pulse Radar Test Signal						
Test Signal Name: LP_Signal_22						
Number of Bursts in Trial: 11						
Chrip Center Frequency: 5515MHz						
Burst	Pulses per Burst	Chrip (Hz)	Pulse Width (s)	Pulse 1 to 2 Spacing (s)	Pulse 2 to 3 Spacing (s)	Start Location (s)
1	2	11M	80.8u	1.059m	-	764.1m
2	2	10M	66.5u	1.599m	-	411.4m
3	3	14M	53.6u	1.104m	1.106m	645.2m
4	3	14M	65.4u	1.922m	1.016m	407.2m
5	3	8M	78.0u	1.465m	1.446m	1.007
6	2	9M	59.6u	1.123m	-	494.9m
7	2	14M	50.6u	1.589m	-	478.0m
8	1	19M	58.8u	-	-	651.0m
9	2	9M	56.0u	1.569m	-	474.0m
10	3	7M	87.7u	1.149m	1.000m	1.033
11	1	16M	50.6u	-	-	240.7m

Long Pulse Radar Test Signal						
Test Signal Name: LP_Signal_23						
Number of Bursts in Trial: 13						
Chrip Center Frequency: 5516MHz						
Burst	Pulses per Burst	Chrip (Hz)	Pulse Width (s)	Pulse 1 to 2 Spacing (s)	Pulse 2 to 3 Spacing (s)	Start Location (s)
1	2	15M	82.0u	1.872m	-	346.5m
2	2	10M	96.7u	1.596m	-	295.1m
3	2	15M	96.3u	1.520m	-	903.8m
4	2	13M	51.1u	1.455m	-	912.6m

5	3	15M	97.6u	1.676m	1.426m	30.55m
6	2	10M	89.9u	1.313m	-	241.2m
7	3	16M	54.6u	968.4u	961.4u	181.6m
8	2	11M	79.4u	1.149m	-	167.3m
9	3	13M	84.5u	1.107m	1.504m	803.5m
10	2	19M	75.2u	1.419m	-	263.5m
11	3	6M	68.2u	1.201m	1.520m	599.2m
12	3	5M	66.5u	1.683m	1.591m	654.5m
13	3	10M	96.1u	1.150m	1.621m	495.7m

Long Pulse Radar Test Signal						
Test Signal Name: LP_Signal_24						
Number of Bursts in Trial: 9						
Chrip Center Frequency: 5517MHz						
Burst	Pulses per Burst	Chrip (Hz)	Pulse Width (s)	Pulse 1 to 2 Spacing (s)	Pulse 2 to 3 Spacing (s)	Start Location (s)
1	3	13M	99.4u	1.649m	992.6u	956.0m
2	2	15M	78.5u	1.058m	-	726.3m
3	2	16M	63.5u	1.497m	-	34.09m
4	3	9M	57.5u	1.399m	1.696m	434.2m
5	2	11M	94.2u	1.305m	-	751.6m
6	2	10M	57.8u	1.068m	-	837.2m
7	2	7M	60.4u	1.727m	-	209.6m
8	1	15M	76.5u	-	-	1.148
9	2	18M	62.8u	1.288m	-	1.201

Long Pulse Radar Test Signal						
Test Signal Name: LP_Signal_25						
Number of Bursts in Trial: 11						
Chrip Center Frequency: 5518MHz						
Burst	Pulses per Burst	Chrip (Hz)	Pulse Width (s)	Pulse 1 to 2 Spacing (s)	Pulse 2 to 3 Spacing (s)	Start Location (s)
1	3	16M	78.7u	1.329m	1.448m	601.3m
2	3	17M	85.5u	1.223m	1.422m	287.5m
3	2	7M	85.3u	1.192m	-	169.2m

4	2	14M	94.2u	1.824m	-	74.75m
5	1	18M	71.6u	-	-	333.2m
6	1	11M	59.2u	-	-	37.23m
7	2	14M	67.8u	1.387m	-	645.7m
8	1	7M	53.4u	-	-	219.7m
9	2	14M	82.3u	1.820m	-	795.7m
10	1	13M	55.2u	-	-	439.1m
11	3	6M	64.1u	1.358m	1.151m	796.2m

Long Pulse Radar Test Signal						
Test Signal Name: LP_Signal_26						
Number of Bursts in Trial: 10						
Chrip Center Frequency: 5519MHz						
Burst	Pulses per Burst	Chrip (Hz)	Pulse Width (s)	Pulse 1 to 2 Spacing (s)	Pulse 2 to 3 Spacing (s)	Start Location (s)
1	3	15M	69.2u	1.694m	1.760m	52.91m
2	3	17M	59.0u	1.410m	1.037m	1.168
3	3	11M	78.5u	1.643m	1.190m	243.2m
4	2	6M	82.8u	1.640m	-	1.140
5	1	12M	74.2u	-	-	861.1m
6	2	8M	90.1u	1.869m	-	1.099
7	2	10M	73.0u	1.352m	-	407.3m
8	2	14M	86.8u	1.238m	-	316.1m
9	3	6M	67.7u	1.261m	1.104m	614.7m
10	2	13M	63.3u	1.234m	-	579.9m

Long Pulse Radar Test Signal						
Test Signal Name: LP_Signal_27						
Number of Bursts in Trial: 9						
Chrip Center Frequency: 5520MHz						
Burst	Pulses per Burst	Chrip (Hz)	Pulse Width (s)	Pulse 1 to 2 Spacing (s)	Pulse 2 to 3 Spacing (s)	Start Location (s)
1	2	13M	50.7u	1.676m	-	396.1m
2	2	11M	57.3u	972.7u	-	371.9m
3	1	11M	92.5u	-	-	1.007

4	3	9M	90.1u	938.9u	1.176m	1.291
5	3	17M	75.1u	1.382m	1.914m	1.033
6	1	12M	87.6u	-	-	234.2m
7	3	7M	83.8u	1.274m	1.764m	1.007
8	1	11M	68.8u	-	-	691.0m
9	2	10M	65.5u	1.282m	-	1.047

Long Pulse Radar Test Signal						
Test Signal Name: LP_Signal_28						
Number of Bursts in Trial: 11						
Chrip Center Frequency: 5521MHz						
Burst	Pulses per Burst	Chrip (Hz)	Pulse Width (s)	Pulse 1 to 2 Spacing (s)	Pulse 2 to 3 Spacing (s)	Start Location (s)
1	3	20M	54.2u	1.297m	1.736m	354.2m
2	1	18M	92.9u	-	-	71.46m
3	3	16M	61.3u	1.616m	1.217m	362.1m
4	3	19M	67.3u	1.069m	1.013m	766.7m
5	2	14M	72.3u	956.7u	-	909.2m
6	2	8M	75.0u	1.230m	-	29.21m
7	3	8M	97.7u	1.011m	1.208m	786.3m
8	2	8M	96.5u	1.780m	-	112.8m
9	1	10M	84.6u	-	-	386.8m
10	1	7M	50.5u	-	-	22.32m
11	1	11M	63.3u	-	-	330.4m

Long Pulse Radar Test Signal						
Test Signal Name: LP_Signal_29						
Number of Bursts in Trial: 14						
Chrip Center Frequency: 5523MHz						
Burst	Pulses per Burst	Chrip (Hz)	Pulse Width (s)	Pulse 1 to 2 Spacing (s)	Pulse 2 to 3 Spacing (s)	Start Location (s)
1	3	16M	60.3u	1.726m	961.7u	74.70m
2	3	10M	89.9u	1.470m	1.781m	776.6m
3	1	10M	60.2u	-	-	319.7m
4	3	11M	66.1u	1.529m	1.393m	511.2m
5	2	13M	57.2u	1.770m	-	511.6m
6	2	6M	58.2u	1.186m	-	208.0m
7	3	19M	54.1u	1.142m	1.062m	369.0m
8	1	16M	78.4u	-	-	665.3m
9	2	10M	75.5u	1.027m	-	539.1m
10	1	19M	86.4u	-	-	444.0m
11	3	7M	70.0u	1.390m	1.493m	437.8m
12	1	16M	52.3u	-	-	838.7m
13	2	11M	61.4u	1.880m	-	757.1m
14	3	5M	88.8u	1.391m	917.2u	747.2m

Long Pulse Radar Test Signal						
Test Signal Name: LP_Signal_30						
Number of Bursts in Trial: 20						
Chrip Center Frequency: 5525MHz						
Burst	Pulses per Burst	Chrip (Hz)	Pulse Width (s)	Pulse 1 to 2 Spacing (s)	Pulse 2 to 3 Spacing (s)	Start Location (s)
1	2	9M	82.5u	1.272m	-	575.7m
2	1	12M	71.0u	-	-	43.73m
3	2	20M	72.7u	1.581m	-	13.17m
4	2	8M	50.5u	1.679m	-	302.9m
5	1	19M	69.7u	-	-	116.5m
6	2	12M	95.1u	987.9u	-	585.8m
7	2	13M	71.5u	1.355m	-	480.2m

8	2	7M	56.2u	1.277m	-	340.3m
9	3	18M	99.8u	968.2u	1.845m	274.5m
10	3	18M	90.9u	1.369m	1.379m	78.28m
11	3	11M	82.0u	1.261m	1.737m	403.4m
12	2	9M	89.3u	1.353m	-	581.3m
13	2	16M	97.9u	1.331m	-	596.7m
14	1	11M	78.1u	-	-	50.82m
15	3	7M	80.7u	1.566m	1.247m	260.8m
16	2	19M	59.9u	1.095m	-	482.4m
17	3	19M	69.9u	1.278m	1.437m	265.6m
18	1	13M	67.5u	-	-	52.23m
19	3	10M	57.5u	1.784m	1.123m	251.9m
20	2	18M	62.7u	1.289m	-	261.2m

Type 6 Radar Statistical Performances				
Trial #	Pulses per Burst	Pulse Width (s)	PRI (s)	Detection
1	9	1.0u	333.0u	Yes
2	9	1.0u	333.0u	Yes
3	9	1.0u	333.0u	Yes
4	9	1.0u	333.0u	Yes
5	9	1.0u	333.0u	Yes
6	9	1.0u	333.0u	Yes
7	9	1.0u	333.0u	Yes
8	9	1.0u	333.0u	Yes
9	9	1.0u	333.0u	Yes
10	9	1.0u	333.0u	Yes
11	9	1.0u	333.0u	Yes
12	9	1.0u	333.0u	Yes
13	9	1.0u	333.0u	Yes
14	9	1.0u	333.0u	Yes
15	9	1.0u	333.0u	Yes
16	9	1.0u	333.0u	Yes
17	9	1.0u	333.0u	Yes
18	9	1.0u	333.0u	Yes
19	9	1.0u	333.0u	Yes
20	9	1.0u	333.0u	Yes
21	9	1.0u	333.0u	Yes
22	9	1.0u	333.0u	Yes
23	9	1.0u	333.0u	Yes
24	9	1.0u	333.0u	Yes
25	9	1.0u	333.0u	Yes
26	9	1.0u	333.0u	Yes
27	9	1.0u	333.0u	Yes
28	9	1.0u	333.0u	Yes
29	9	1.0u	333.0u	Yes
30	9	1.0u	333.0u	Yes
			Detection Rate: 100.0 %	

Type 6 Radar Statistical Performances		
Trial #	Hopping Frequency Sequence Name	Detection
1	HOP_FREQ_SEQ_01	Yes
2	HOP_FREQ_SEQ_02	Yes
3	HOP_FREQ_SEQ_03	Yes
4	HOP_FREQ_SEQ_04	Yes
5	HOP_FREQ_SEQ_05	Yes
6	HOP_FREQ_SEQ_06	Yes
7	HOP_FREQ_SEQ_07	Yes
8	HOP_FREQ_SEQ_08	Yes
9	HOP_FREQ_SEQ_09	Yes
10	HOP_FREQ_SEQ_10	Yes
11	HOP_FREQ_SEQ_11	Yes
12	HOP_FREQ_SEQ_12	Yes
13	HOP_FREQ_SEQ_13	Yes
14	HOP_FREQ_SEQ_14	Yes
15	HOP_FREQ_SEQ_15	Yes
16	HOP_FREQ_SEQ_16	Yes
17	HOP_FREQ_SEQ_17	Yes
18	HOP_FREQ_SEQ_18	Yes
19	HOP_FREQ_SEQ_19	Yes
20	HOP_FREQ_SEQ_20	Yes
21	HOP_FREQ_SEQ_21	Yes
22	HOP_FREQ_SEQ_22	Yes
23	HOP_FREQ_SEQ_23	Yes
24	HOP_FREQ_SEQ_24	Yes
25	HOP_FREQ_SEQ_25	Yes
26	HOP_FREQ_SEQ_26	Yes
27	HOP_FREQ_SEQ_27	Yes
28	HOP_FREQ_SEQ_28	Yes
29	HOP_FREQ_SEQ_29	Yes
30	HOP_FREQ_SEQ_30	Yes
		Detection Rate: 100.0 %

Hopping Frequency Sequence Name: HOP_FREQ_SEQ_01							
SEQ#	Frequency (Hz)	SEQ#	Frequency (Hz)	SEQ#	Frequency (Hz)	SEQ#	Frequency (Hz)
1	5.661G	2	5.682G	3	5.347G	4	5.275G
5	5.582G	6	5.334G	7	5.691G	8	5.453G
9	5.693G	10	5.601G	11	5.713G	12	5.585G
13	5.341G	14	5.511G	15	5.445G	16	5.670G
17	5.666G	18	5.296G	19	5.465G	20	5.679G
21	5.256G	22	5.714G	23	5.494G	24	5.454G
25	5.317G	26	5.290G	27	5.376G	28	5.612G
29	5.648G	30	5.439G	31	5.474G	32	5.563G
33	5.416G	34	5.721G	35	5.351G	36	5.668G
37	5.435G	38	5.440G	39	5.664G	40	5.369G
41	5.600G	42	5.292G	43	5.534G	44	5.708G
45	5.624G	46	5.537G	47	5.652G	48	5.655G
49	5.374G	50	5.336G	51	5.643G	52	5.437G
53	5.533G	54	5.482G	55	5.285G	56	5.443G
57	5.501G	58	5.547G	59	5.274G	60	5.650G
61	5.683G	62	5.615G	63	5.280G	64	5.469G
65	5.628G	66	5.639G	67	5.426G	68	5.379G
69	5.393G	70	5.479G	71	5.706G	72	5.604G
73	5.315G	74	5.605G	75	5.371G	76	5.409G
77	5.282G	78	5.572G	79	5.333G	80	5.272G
81	5.645G	82	5.588G	83	5.402G	84	5.399G
85	5.442G	86	5.258G	87	5.673G	88	5.575G
89	5.309G	90	5.570G	91	5.313G	92	5.701G
93	5.678G	94	5.510G	95	5.622G	96	5.580G
97	5.700G	98	5.250G	99	5.456G	100	5.633G

Hopping Frequency Sequence Name: HOP_FREQ_SEQ_02							
SEQ#	Frequency (Hz)	SEQ#	Frequency (Hz)	SEQ#	Frequency (Hz)	SEQ#	Frequency (Hz)
1	5.414G	2	5.439G	3	5.282G	4	5.592G
5	5.714G	6	5.570G	7	5.685G	8	5.466G
9	5.529G	10	5.637G	11	5.396G	12	5.708G
13	5.298G	14	5.361G	15	5.663G	16	5.651G

17	5.601G	18	5.690G	19	5.522G	20	5.557G
21	5.589G	22	5.391G	23	5.511G	24	5.263G
25	5.636G	26	5.284G	27	5.615G	28	5.408G
29	5.721G	30	5.318G	31	5.463G	32	5.562G
33	5.290G	34	5.250G	35	5.706G	36	5.452G
37	5.526G	38	5.588G	39	5.400G	40	5.399G
41	5.357G	42	5.541G	43	5.269G	44	5.552G
45	5.431G	46	5.481G	47	5.697G	48	5.724G
49	5.461G	50	5.322G	51	5.474G	52	5.476G
53	5.330G	54	5.359G	55	5.698G	56	5.358G
57	5.464G	58	5.547G	59	5.346G	60	5.386G
61	5.676G	62	5.560G	63	5.673G	64	5.543G
65	5.275G	66	5.691G	67	5.581G	68	5.598G
69	5.616G	70	5.471G	71	5.374G	72	5.405G
73	5.254G	74	5.537G	75	5.442G	76	5.315G
77	5.546G	78	5.274G	79	5.342G	80	5.671G
81	5.416G	82	5.545G	83	5.658G	84	5.512G
85	5.555G	86	5.381G	87	5.567G	88	5.672G
89	5.296G	90	5.595G	91	5.421G	92	5.299G
93	5.540G	94	5.701G	95	5.411G	96	5.376G
97	5.494G	98	5.329G	99	5.264G	100	5.270G

Hopping Frequency Sequence Name: HOP_FREQ_SEQ_03							
SEQ#	Frequency (Hz)	SEQ#	Frequency (Hz)	SEQ#	Frequency (Hz)	SEQ#	Frequency (Hz)
1	5.679G	2	5.317G	3	5.547G	4	5.700G
5	5.503G	6	5.452G	7	5.250G	8	5.582G
9	5.521G	10	5.374G	11	5.535G	12	5.340G
13	5.686G	14	5.430G	15	5.264G	16	5.364G
17	5.306G	18	5.462G	19	5.309G	20	5.516G
21	5.499G	22	5.315G	23	5.639G	24	5.636G
25	5.724G	26	5.417G	27	5.335G	28	5.444G
29	5.458G	30	5.536G	31	5.432G	32	5.551G
33	5.477G	34	5.661G	35	5.677G	36	5.344G
37	5.675G	38	5.693G	39	5.441G	40	5.287G
41	5.681G	42	5.328G	43	5.712G	44	5.454G
45	5.357G	46	5.561G	47	5.271G	48	5.515G

49	5.608G	50	5.538G	51	5.506G	52	5.376G
53	5.584G	54	5.355G	55	5.705G	56	5.406G
57	5.260G	58	5.683G	59	5.422G	60	5.343G
61	5.605G	62	5.518G	63	5.316G	64	5.459G
65	5.722G	66	5.689G	67	5.577G	68	5.423G
69	5.702G	70	5.527G	71	5.500G	72	5.716G
73	5.587G	74	5.710G	75	5.528G	76	5.562G
77	5.568G	78	5.349G	79	5.523G	80	5.609G
81	5.481G	82	5.378G	83	5.637G	84	5.684G
85	5.261G	86	5.615G	87	5.299G	88	5.410G
89	5.358G	90	5.548G	91	5.715G	92	5.534G
93	5.370G	94	5.289G	95	5.600G	96	5.553G
97	5.525G	98	5.520G	99	5.572G	100	5.273G

Hopping Frequency Sequence Name: HOP_FREQ_SEQ_04							
SEQ#	Frequency (Hz)	SEQ#	Frequency (Hz)	SEQ#	Frequency (Hz)	SEQ#	Frequency (Hz)
1	5.400G	2	5.348G	3	5.316G	4	5.506G
5	5.301G	6	5.657G	7	5.382G	8	5.300G
9	5.524G	10	5.617G	11	5.349G	12	5.646G
13	5.273G	14	5.283G	15	5.446G	16	5.588G
17	5.330G	18	5.417G	19	5.669G	20	5.528G
21	5.580G	22	5.679G	23	5.628G	24	5.621G
25	5.673G	26	5.651G	27	5.391G	28	5.444G
29	5.564G	30	5.685G	31	5.361G	32	5.454G
33	5.404G	34	5.690G	35	5.439G	36	5.380G
37	5.614G	38	5.516G	39	5.535G	40	5.536G
41	5.302G	42	5.388G	43	5.658G	44	5.426G
45	5.561G	46	5.550G	47	5.513G	48	5.451G
49	5.393G	50	5.560G	51	5.365G	52	5.703G
53	5.671G	54	5.684G	55	5.337G	56	5.256G
57	5.332G	58	5.571G	59	5.372G	60	5.544G
61	5.274G	62	5.723G	63	5.456G	64	5.520G
65	5.472G	66	5.425G	67	5.634G	68	5.702G
69	5.309G	70	5.710G	71	5.670G	72	5.533G
73	5.366G	74	5.724G	75	5.680G	76	5.595G
77	5.517G	78	5.287G	79	5.375G	80	5.574G

81	5.495G	82	5.328G	83	5.548G	84	5.668G
85	5.407G	86	5.579G	87	5.682G	88	5.291G
89	5.315G	90	5.586G	91	5.529G	92	5.584G
93	5.263G	94	5.541G	95	5.359G	96	5.340G
97	5.523G	98	5.543G	99	5.480G	100	5.485G

Hopping Frequency Sequence Name: HOP_FREQ_SEQ_05							
SEQ#	Frequency (Hz)	SEQ#	Frequency (Hz)	SEQ#	Frequency (Hz)	SEQ#	Frequency (Hz)
1	5.319G	2	5.719G	3	5.506G	4	5.714G
5	5.382G	6	5.638G	7	5.336G	8	5.350G
9	5.416G	10	5.352G	11	5.309G	12	5.381G
13	5.517G	14	5.669G	15	5.534G	16	5.540G
17	5.705G	18	5.637G	19	5.551G	20	5.471G
21	5.287G	22	5.608G	23	5.541G	24	5.606G
25	5.709G	26	5.500G	27	5.689G	28	5.527G
29	5.422G	30	5.710G	31	5.568G	32	5.346G
33	5.575G	34	5.514G	35	5.347G	36	5.391G
37	5.362G	38	5.625G	39	5.640G	40	5.258G
41	5.398G	42	5.270G	43	5.511G	44	5.499G
45	5.684G	46	5.314G	47	5.272G	48	5.303G
49	5.647G	50	5.379G	51	5.476G	52	5.392G
53	5.494G	54	5.501G	55	5.377G	56	5.467G
57	5.507G	58	5.295G	59	5.686G	60	5.254G
61	5.306G	62	5.572G	63	5.290G	64	5.373G
65	5.302G	66	5.632G	67	5.320G	68	5.578G
69	5.539G	70	5.327G	71	5.487G	72	5.515G
73	5.571G	74	5.370G	75	5.666G	76	5.604G
77	5.368G	78	5.528G	79	5.414G	80	5.695G
81	5.429G	82	5.641G	83	5.436G	84	5.417G
85	5.269G	86	5.649G	87	5.529G	88	5.457G
89	5.283G	90	5.444G	91	5.603G	92	5.372G
93	5.664G	94	5.503G	95	5.680G	96	5.563G
97	5.712G	98	5.673G	99	5.650G	100	5.296G

Hopping Frequency Sequence Name: HOP_FREQ_SEQ_06							
SEQ#	Frequency (Hz)	SEQ#	Frequency (Hz)	SEQ#	Frequency (Hz)	SEQ#	Frequency (Hz)
1	5.464G	2	5.500G	3	5.454G	4	5.723G
5	5.711G	6	5.679G	7	5.623G	8	5.303G
9	5.639G	10	5.651G	11	5.289G	12	5.657G
13	5.435G	14	5.551G	15	5.608G	16	5.335G
17	5.321G	18	5.467G	19	5.503G	20	5.543G
21	5.584G	22	5.481G	23	5.618G	24	5.650G
25	5.306G	26	5.366G	27	5.695G	28	5.328G
29	5.533G	30	5.461G	31	5.452G	32	5.708G
33	5.477G	34	5.479G	35	5.412G	36	5.407G
37	5.548G	38	5.683G	39	5.620G	40	5.315G
41	5.495G	42	5.416G	43	5.317G	44	5.327G
45	5.457G	46	5.641G	47	5.526G	48	5.309G
49	5.665G	50	5.636G	51	5.266G	52	5.675G
53	5.422G	54	5.271G	55	5.569G	56	5.288G
57	5.434G	58	5.505G	59	5.272G	60	5.643G
61	5.534G	62	5.259G	63	5.252G	64	5.592G
65	5.662G	66	5.267G	67	5.382G	68	5.433G
69	5.485G	70	5.682G	71	5.688G	72	5.590G
73	5.332G	74	5.269G	75	5.716G	76	5.427G
77	5.549G	78	5.456G	79	5.348G	80	5.357G
81	5.458G	82	5.440G	83	5.692G	84	5.693G
85	5.638G	86	5.509G	87	5.567G	88	5.409G
89	5.307G	90	5.715G	91	5.552G	92	5.360G
93	5.292G	94	5.470G	95	5.441G	96	5.587G
97	5.444G	98	5.365G	99	5.310G	100	5.394G

Hopping Frequency Sequence Name: HOP_FREQ_SEQ_07							
SEQ#	Frequency (Hz)	SEQ#	Frequency (Hz)	SEQ#	Frequency (Hz)	SEQ#	Frequency (Hz)
1	5.458G	2	5.662G	3	5.310G	4	5.348G
5	5.655G	6	5.508G	7	5.547G	8	5.650G
9	5.415G	10	5.350G	11	5.550G	12	5.474G
13	5.551G	14	5.450G	15	5.722G	16	5.417G

17	5.494G	18	5.409G	19	5.499G	20	5.327G
21	5.699G	22	5.403G	23	5.390G	24	5.448G
25	5.561G	26	5.632G	27	5.564G	28	5.618G
29	5.513G	30	5.260G	31	5.339G	32	5.437G
33	5.463G	34	5.406G	35	5.446G	36	5.690G
37	5.671G	38	5.723G	39	5.588G	40	5.712G
41	5.709G	42	5.328G	43	5.451G	44	5.438G
45	5.428G	46	5.479G	47	5.320G	48	5.413G
49	5.529G	50	5.554G	51	5.517G	52	5.663G
53	5.642G	54	5.331G	55	5.715G	56	5.677G
57	5.528G	58	5.330G	59	5.526G	60	5.570G
61	5.675G	62	5.600G	63	5.654G	64	5.595G
65	5.361G	66	5.633G	67	5.540G	68	5.357G
69	5.278G	70	5.300G	71	5.641G	72	5.258G
73	5.373G	74	5.273G	75	5.656G	76	5.408G
77	5.649G	78	5.500G	79	5.421G	80	5.630G
81	5.396G	82	5.251G	83	5.533G	84	5.433G
85	5.370G	86	5.524G	87	5.386G	88	5.605G
89	5.353G	90	5.256G	91	5.640G	92	5.591G
93	5.488G	94	5.312G	95	5.295G	96	5.364G
97	5.646G	98	5.599G	99	5.697G	100	5.696G

Hopping Frequency Sequence Name: HOP_FREQ_SEQ_08							
SEQ#	Frequency (Hz)	SEQ#	Frequency (Hz)	SEQ#	Frequency (Hz)	SEQ#	Frequency (Hz)
1	5.495G	2	5.553G	3	5.386G	4	5.410G
5	5.686G	6	5.417G	7	5.287G	8	5.575G
9	5.292G	10	5.356G	11	5.537G	12	5.589G
13	5.291G	14	5.624G	15	5.453G	16	5.485G
17	5.607G	18	5.339G	19	5.650G	20	5.660G
21	5.601G	22	5.486G	23	5.431G	24	5.328G
25	5.515G	26	5.678G	27	5.448G	28	5.371G
29	5.556G	30	5.661G	31	5.659G	32	5.599G
33	5.536G	34	5.521G	35	5.261G	36	5.305G
37	5.337G	38	5.646G	39	5.588G	40	5.527G
41	5.574G	42	5.642G	43	5.695G	44	5.380G
45	5.358G	46	5.484G	47	5.713G	48	5.629G

49	5.676G	50	5.704G	51	5.267G	52	5.555G
53	5.293G	54	5.326G	55	5.461G	56	5.544G
57	5.499G	58	5.342G	59	5.420G	60	5.437G
61	5.290G	62	5.579G	63	5.597G	64	5.426G
65	5.277G	66	5.389G	67	5.257G	68	5.557G
69	5.593G	70	5.393G	71	5.341G	72	5.405G
73	5.644G	74	5.618G	75	5.594G	76	5.477G
77	5.696G	78	5.447G	79	5.577G	80	5.325G
81	5.474G	82	5.616G	83	5.647G	84	5.679G
85	5.309G	86	5.440G	87	5.652G	88	5.627G
89	5.428G	90	5.382G	91	5.419G	92	5.501G
93	5.637G	94	5.600G	95	5.306G	96	5.517G
97	5.387G	98	5.545G	99	5.497G	100	5.488G

Hopping Frequency Sequence Name: HOP_FREQ_SEQ_09							
SEQ#	Frequency (Hz)	SEQ#	Frequency (Hz)	SEQ#	Frequency (Hz)	SEQ#	Frequency (Hz)
1	5.307G	2	5.564G	3	5.439G	4	5.660G
5	5.654G	6	5.676G	7	5.652G	8	5.527G
9	5.422G	10	5.452G	11	5.378G	12	5.550G
13	5.387G	14	5.542G	15	5.563G	16	5.290G
17	5.431G	18	5.516G	19	5.575G	20	5.671G
21	5.470G	22	5.696G	23	5.580G	24	5.591G
25	5.599G	26	5.703G	27	5.421G	28	5.679G
29	5.688G	30	5.395G	31	5.257G	32	5.388G
33	5.335G	34	5.390G	35	5.364G	36	5.666G
37	5.535G	38	5.450G	39	5.322G	40	5.686G
41	5.677G	42	5.325G	43	5.578G	44	5.344G
45	5.655G	46	5.295G	47	5.430G	48	5.522G
49	5.331G	50	5.424G	51	5.508G	52	5.368G
53	5.457G	54	5.285G	55	5.673G	56	5.689G
57	5.362G	58	5.698G	59	5.401G	60	5.691G
61	5.624G	62	5.482G	63	5.473G	64	5.310G
65	5.610G	66	5.558G	67	5.365G	68	5.273G
69	5.298G	70	5.380G	71	5.567G	72	5.708G
73	5.600G	74	5.269G	75	5.303G	76	5.398G
77	5.308G	78	5.404G	79	5.718G	80	5.499G

81	5.373G	82	5.593G	83	5.358G	84	5.468G
85	5.311G	86	5.488G	87	5.606G	88	5.363G
89	5.533G	90	5.700G	91	5.485G	92	5.346G
93	5.642G	94	5.256G	95	5.415G	96	5.721G
97	5.500G	98	5.381G	99	5.576G	100	5.585G

Hopping Frequency Sequence Name: HOP_FREQ_SEQ_10							
SEQ#	Frequency (Hz)	SEQ#	Frequency (Hz)	SEQ#	Frequency (Hz)	SEQ#	Frequency (Hz)
1	5.512G	2	5.624G	3	5.511G	4	5.656G
5	5.314G	6	5.708G	7	5.617G	8	5.352G
9	5.544G	10	5.669G	11	5.391G	12	5.671G
13	5.416G	14	5.501G	15	5.568G	16	5.318G
17	5.643G	18	5.275G	19	5.661G	20	5.567G
21	5.424G	22	5.274G	23	5.650G	24	5.276G
25	5.581G	26	5.418G	27	5.290G	28	5.395G
29	5.550G	30	5.601G	31	5.413G	32	5.468G
33	5.358G	34	5.534G	35	5.285G	36	5.600G
37	5.553G	38	5.638G	39	5.625G	40	5.506G
41	5.559G	42	5.305G	43	5.526G	44	5.717G
45	5.539G	46	5.542G	47	5.427G	48	5.484G
49	5.251G	50	5.269G	51	5.715G	52	5.478G
53	5.454G	54	5.359G	55	5.252G	56	5.353G
57	5.514G	58	5.436G	59	5.316G	60	5.343G
61	5.255G	62	5.604G	63	5.626G	64	5.340G
65	5.310G	66	5.482G	67	5.450G	68	5.431G
69	5.546G	70	5.645G	71	5.447G	72	5.623G
73	5.572G	74	5.723G	75	5.566G	76	5.449G
77	5.477G	78	5.356G	79	5.459G	80	5.465G
81	5.547G	82	5.532G	83	5.517G	84	5.380G
85	5.437G	86	5.594G	87	5.648G	88	5.637G
89	5.503G	90	5.474G	91	5.422G	92	5.589G
93	5.655G	94	5.333G	95	5.344G	96	5.635G
97	5.412G	98	5.504G	99	5.652G	100	5.607G

Hopping Frequency Sequence Name: HOP_FREQ_SEQ_11							
SEQ#	Frequency (Hz)	SEQ#	Frequency (Hz)	SEQ#	Frequency (Hz)	SEQ#	Frequency (Hz)
1	5.652G	2	5.570G	3	5.614G	4	5.430G
5	5.628G	6	5.368G	7	5.343G	8	5.681G
9	5.266G	10	5.707G	11	5.389G	12	5.409G
13	5.426G	14	5.458G	15	5.309G	16	5.330G
17	5.428G	18	5.598G	19	5.300G	20	5.621G
21	5.694G	22	5.566G	23	5.600G	24	5.423G
25	5.543G	26	5.644G	27	5.673G	28	5.528G
29	5.351G	30	5.503G	31	5.577G	32	5.595G
33	5.303G	34	5.572G	35	5.499G	36	5.632G
37	5.688G	38	5.525G	39	5.396G	40	5.315G
41	5.615G	42	5.436G	43	5.620G	44	5.386G
45	5.468G	46	5.712G	47	5.537G	48	5.534G
49	5.394G	50	5.697G	51	5.280G	52	5.488G
53	5.668G	54	5.716G	55	5.316G	56	5.591G
57	5.502G	58	5.392G	59	5.366G	60	5.255G
61	5.308G	62	5.292G	63	5.427G	64	5.327G
65	5.671G	66	5.610G	67	5.254G	68	5.660G
69	5.556G	70	5.553G	71	5.533G	72	5.522G
73	5.719G	74	5.446G	75	5.364G	76	5.439G
77	5.407G	78	5.440G	79	5.624G	80	5.265G
81	5.538G	82	5.710G	83	5.563G	84	5.500G
85	5.259G	86	5.271G	87	5.613G	88	5.698G
89	5.262G	90	5.622G	91	5.561G	92	5.687G
93	5.506G	94	5.648G	95	5.419G	96	5.541G
97	5.575G	98	5.701G	99	5.649G	100	5.551G

Hopping Frequency Sequence Name: HOP_FREQ_SEQ_12							
SEQ#	Frequency (Hz)	SEQ#	Frequency (Hz)	SEQ#	Frequency (Hz)	SEQ#	Frequency (Hz)
1	5.711G	2	5.453G	3	5.383G	4	5.419G
5	5.398G	6	5.591G	7	5.470G	8	5.534G
9	5.411G	10	5.405G	11	5.306G	12	5.264G
13	5.354G	14	5.581G	15	5.406G	16	5.439G

17	5.340G	18	5.585G	19	5.697G	20	5.723G
21	5.274G	22	5.500G	23	5.368G	24	5.358G
25	5.446G	26	5.393G	27	5.332G	28	5.580G
29	5.283G	30	5.372G	31	5.300G	32	5.296G
33	5.321G	34	5.420G	35	5.499G	36	5.484G
37	5.661G	38	5.409G	39	5.478G	40	5.565G
41	5.437G	42	5.506G	43	5.634G	44	5.612G
45	5.289G	46	5.626G	47	5.445G	48	5.620G
49	5.495G	50	5.712G	51	5.665G	52	5.644G
53	5.386G	54	5.452G	55	5.527G	56	5.691G
57	5.288G	58	5.519G	59	5.337G	60	5.258G
61	5.388G	62	5.532G	63	5.394G	64	5.299G
65	5.702G	66	5.682G	67	5.327G	68	5.608G
69	5.267G	70	5.385G	71	5.466G	72	5.415G
73	5.362G	74	5.716G	75	5.647G	76	5.587G
77	5.455G	78	5.520G	79	5.704G	80	5.414G
81	5.444G	82	5.720G	83	5.713G	84	5.373G
85	5.604G	86	5.292G	87	5.593G	88	5.542G
89	5.689G	90	5.325G	91	5.632G	92	5.539G
93	5.594G	94	5.524G	95	5.347G	96	5.724G
97	5.281G	98	5.521G	99	5.605G	100	5.262G

Hopping Frequency Sequence Name: HOP_FREQ_SEQ_13							
SEQ#	Frequency (Hz)	SEQ#	Frequency (Hz)	SEQ#	Frequency (Hz)	SEQ#	Frequency (Hz)
1	5.329G	2	5.719G	3	5.325G	4	5.419G
5	5.606G	6	5.510G	7	5.281G	8	5.571G
9	5.690G	10	5.423G	11	5.716G	12	5.266G
13	5.696G	14	5.607G	15	5.435G	16	5.394G
17	5.308G	18	5.665G	19	5.322G	20	5.600G
21	5.508G	22	5.518G	23	5.348G	24	5.471G
25	5.603G	26	5.724G	27	5.630G	28	5.330G
29	5.318G	30	5.278G	31	5.598G	32	5.405G
33	5.294G	34	5.464G	35	5.649G	36	5.583G
37	5.523G	38	5.663G	39	5.364G	40	5.382G
41	5.358G	42	5.353G	43	5.384G	44	5.277G
45	5.699G	46	5.406G	47	5.527G	48	5.470G

49	5.451G	50	5.568G	51	5.416G	52	5.386G
53	5.656G	54	5.389G	55	5.356G	56	5.501G
57	5.301G	58	5.346G	59	5.480G	60	5.367G
61	5.711G	62	5.529G	63	5.434G	64	5.581G
65	5.547G	66	5.307G	67	5.655G	68	5.582G
69	5.272G	70	5.631G	71	5.713G	72	5.556G
73	5.251G	74	5.397G	75	5.540G	76	5.537G
77	5.392G	78	5.381G	79	5.585G	80	5.575G
81	5.365G	82	5.579G	83	5.459G	84	5.404G
85	5.520G	86	5.639G	87	5.496G	88	5.331G
89	5.366G	90	5.624G	91	5.360G	92	5.698G
93	5.625G	94	5.553G	95	5.669G	96	5.532G
97	5.641G	98	5.629G	99	5.491G	100	5.474G

Hopping Frequency Sequence Name: HOP_FREQ_SEQ_14							
SEQ#	Frequency (Hz)	SEQ#	Frequency (Hz)	SEQ#	Frequency (Hz)	SEQ#	Frequency (Hz)
1	5.564G	2	5.296G	3	5.603G	4	5.441G
5	5.598G	6	5.358G	7	5.287G	8	5.590G
9	5.672G	10	5.569G	11	5.412G	12	5.445G
13	5.377G	14	5.428G	15	5.385G	16	5.500G
17	5.512G	18	5.701G	19	5.258G	20	5.354G
21	5.432G	22	5.717G	23	5.436G	24	5.324G
25	5.298G	26	5.722G	27	5.525G	28	5.661G
29	5.602G	30	5.687G	31	5.562G	32	5.494G
33	5.716G	34	5.269G	35	5.348G	36	5.647G
37	5.585G	38	5.297G	39	5.684G	40	5.643G
41	5.253G	42	5.612G	43	5.375G	44	5.401G
45	5.664G	46	5.678G	47	5.433G	48	5.523G
49	5.652G	50	5.680G	51	5.314G	52	5.552G
53	5.670G	54	5.695G	55	5.316G	56	5.460G
57	5.535G	58	5.620G	59	5.450G	60	5.439G
61	5.359G	62	5.502G	63	5.313G	64	5.328G
65	5.368G	66	5.681G	67	5.263G	68	5.578G
69	5.294G	70	5.629G	71	5.310G	72	5.607G
73	5.322G	74	5.616G	75	5.534G	76	5.673G
77	5.411G	78	5.615G	79	5.536G	80	5.285G

81	5.648G	82	5.330G	83	5.498G	84	5.458G
85	5.374G	86	5.389G	87	5.610G	88	5.274G
89	5.676G	90	5.601G	91	5.495G	92	5.520G
93	5.644G	94	5.521G	95	5.407G	96	5.404G
97	5.437G	98	5.633G	99	5.654G	100	5.267G

Hopping Frequency Sequence Name: HOP_FREQ_SEQ_15							
SEQ#	Frequency (Hz)	SEQ#	Frequency (Hz)	SEQ#	Frequency (Hz)	SEQ#	Frequency (Hz)
1	5.371G	2	5.447G	3	5.295G	4	5.475G
5	5.315G	6	5.417G	7	5.576G	8	5.543G
9	5.274G	10	5.354G	11	5.487G	12	5.286G
13	5.495G	14	5.521G	15	5.527G	16	5.296G
17	5.458G	18	5.549G	19	5.476G	20	5.445G
21	5.613G	22	5.653G	23	5.510G	24	5.656G
25	5.383G	26	5.506G	27	5.273G	28	5.702G
29	5.312G	30	5.331G	31	5.492G	32	5.443G
33	5.522G	34	5.427G	35	5.338G	36	5.674G
37	5.638G	38	5.694G	39	5.636G	40	5.572G
41	5.570G	42	5.419G	43	5.715G	44	5.384G
45	5.645G	46	5.307G	47	5.300G	48	5.633G
49	5.707G	50	5.260G	51	5.683G	52	5.374G
53	5.632G	54	5.666G	55	5.689G	56	5.609G
57	5.563G	58	5.682G	59	5.435G	60	5.252G
61	5.272G	62	5.469G	63	5.375G	64	5.423G
65	5.639G	66	5.403G	67	5.542G	68	5.471G
69	5.512G	70	5.455G	71	5.278G	72	5.405G
73	5.253G	74	5.438G	75	5.473G	76	5.292G
77	5.626G	78	5.343G	79	5.667G	80	5.267G
81	5.498G	82	5.545G	83	5.400G	84	5.655G
85	5.451G	86	5.529G	87	5.285G	88	5.416G
89	5.577G	90	5.325G	91	5.554G	92	5.568G
93	5.519G	94	5.566G	95	5.380G	96	5.693G
97	5.479G	98	5.298G	99	5.481G	100	5.442G

Hopping Frequency Sequence Name: HOP_FREQ_SEQ_16							
SEQ#	Frequency (Hz)	SEQ#	Frequency (Hz)	SEQ#	Frequency (Hz)	SEQ#	Frequency (Hz)
1	5.517G	2	5.386G	3	5.347G	4	5.448G
5	5.356G	6	5.667G	7	5.291G	8	5.538G
9	5.714G	10	5.257G	11	5.387G	12	5.644G
13	5.293G	14	5.504G	15	5.657G	16	5.596G
17	5.480G	18	5.638G	19	5.631G	20	5.682G
21	5.699G	22	5.519G	23	5.696G	24	5.558G
25	5.721G	26	5.705G	27	5.358G	28	5.365G
29	5.641G	30	5.399G	31	5.462G	32	5.340G
33	5.625G	34	5.254G	35	5.713G	36	5.272G
37	5.343G	38	5.712G	39	5.686G	40	5.666G
41	5.264G	42	5.718G	43	5.273G	44	5.430G
45	5.453G	46	5.537G	47	5.630G	48	5.674G
49	5.385G	50	5.455G	51	5.433G	52	5.389G
53	5.550G	54	5.336G	55	5.577G	56	5.582G
57	5.529G	58	5.578G	59	5.408G	60	5.594G
61	5.524G	62	5.518G	63	5.307G	64	5.417G
65	5.299G	66	5.338G	67	5.393G	68	5.319G
69	5.405G	70	5.516G	71	5.391G	72	5.560G
73	5.411G	74	5.655G	75	5.653G	76	5.328G
77	5.499G	78	5.348G	79	5.722G	80	5.521G
81	5.341G	82	5.506G	83	5.422G	84	5.324G
85	5.645G	86	5.583G	87	5.597G	88	5.684G
89	5.271G	90	5.419G	91	5.672G	92	5.364G
93	5.279G	94	5.315G	95	5.366G	96	5.624G
97	5.494G	98	5.255G	99	5.382G	100	5.440G

Hopping Frequency Sequence Name: HOP_FREQ_SEQ_17							
SEQ#	Frequency (Hz)	SEQ#	Frequency (Hz)	SEQ#	Frequency (Hz)	SEQ#	Frequency (Hz)
1	5.506G	2	5.256G	3	5.686G	4	5.406G
5	5.443G	6	5.716G	7	5.719G	8	5.660G
9	5.519G	10	5.690G	11	5.569G	12	5.365G
13	5.645G	14	5.654G	15	5.417G	16	5.402G

17	5.625G	18	5.477G	19	5.277G	20	5.388G
21	5.580G	22	5.581G	23	5.682G	24	5.289G
25	5.607G	26	5.720G	27	5.634G	28	5.263G
29	5.395G	30	5.513G	31	5.511G	32	5.677G
33	5.692G	34	5.463G	35	5.383G	36	5.604G
37	5.687G	38	5.614G	39	5.315G	40	5.502G
41	5.309G	42	5.526G	43	5.662G	44	5.352G
45	5.495G	46	5.508G	47	5.487G	48	5.366G
49	5.313G	50	5.343G	51	5.599G	52	5.320G
53	5.430G	54	5.408G	55	5.629G	56	5.722G
57	5.585G	58	5.706G	59	5.280G	60	5.387G
61	5.415G	62	5.381G	63	5.510G	64	5.471G
65	5.299G	66	5.566G	67	5.550G	68	5.468G
69	5.563G	70	5.393G	71	5.691G	72	5.539G
73	5.721G	74	5.707G	75	5.681G	76	5.591G
77	5.536G	78	5.701G	79	5.708G	80	5.621G
81	5.453G	82	5.715G	83	5.446G	84	5.254G
85	5.649G	86	5.276G	87	5.449G	88	5.357G
89	5.396G	90	5.622G	91	5.638G	92	5.287G
93	5.616G	94	5.680G	95	5.610G	96	5.601G
97	5.259G	98	5.483G	99	5.596G	100	5.640G

Hopping Frequency Sequence Name: HOP_FREQ_SEQ_18							
SEQ#	Frequency (Hz)	SEQ#	Frequency (Hz)	SEQ#	Frequency (Hz)	SEQ#	Frequency (Hz)
1	5.710G	2	5.546G	3	5.289G	4	5.331G
5	5.419G	6	5.552G	7	5.663G	8	5.543G
9	5.467G	10	5.330G	11	5.435G	12	5.603G
13	5.724G	14	5.634G	15	5.469G	16	5.495G
17	5.259G	18	5.581G	19	5.487G	20	5.563G
21	5.610G	22	5.651G	23	5.407G	24	5.699G
25	5.398G	26	5.612G	27	5.387G	28	5.277G
29	5.712G	30	5.571G	31	5.444G	32	5.607G
33	5.290G	34	5.388G	35	5.601G	36	5.297G
37	5.293G	38	5.465G	39	5.349G	40	5.381G
41	5.723G	42	5.428G	43	5.448G	44	5.284G
45	5.510G	46	5.527G	47	5.504G	48	5.598G

49	5.609G	50	5.362G	51	5.640G	52	5.458G
53	5.393G	54	5.347G	55	5.478G	56	5.568G
57	5.451G	58	5.320G	59	5.459G	60	5.368G
61	5.644G	62	5.673G	63	5.449G	64	5.391G
65	5.375G	66	5.570G	67	5.309G	68	5.540G
69	5.692G	70	5.539G	71	5.698G	72	5.691G
73	5.285G	74	5.361G	75	5.281G	76	5.486G
77	5.628G	78	5.721G	79	5.573G	80	5.605G
81	5.295G	82	5.376G	83	5.298G	84	5.355G
85	5.536G	86	5.338G	87	5.709G	88	5.390G
89	5.575G	90	5.475G	91	5.429G	92	5.503G
93	5.505G	94	5.516G	95	5.464G	96	5.493G
97	5.574G	98	5.311G	99	5.319G	100	5.565G

Hopping Frequency Sequence Name: HOP_FREQ_SEQ_19							
SEQ#	Frequency (Hz)	SEQ#	Frequency (Hz)	SEQ#	Frequency (Hz)	SEQ#	Frequency (Hz)
1	5.538G	2	5.393G	3	5.323G	4	5.571G
5	5.643G	6	5.353G	7	5.660G	8	5.668G
9	5.459G	10	5.454G	11	5.665G	12	5.573G
13	5.400G	14	5.277G	15	5.498G	16	5.406G
17	5.424G	18	5.595G	19	5.696G	20	5.597G
21	5.664G	22	5.255G	23	5.639G	24	5.389G
25	5.514G	26	5.576G	27	5.536G	28	5.642G
29	5.366G	30	5.336G	31	5.431G	32	5.518G
33	5.482G	34	5.345G	35	5.532G	36	5.297G
37	5.321G	38	5.589G	39	5.474G	40	5.686G
41	5.445G	42	5.362G	43	5.702G	44	5.288G
45	5.456G	46	5.631G	47	5.259G	48	5.577G
49	5.282G	50	5.387G	51	5.372G	52	5.303G
53	5.593G	54	5.635G	55	5.477G	56	5.691G
57	5.339G	58	5.446G	59	5.275G	60	5.533G
61	5.697G	62	5.606G	63	5.414G	64	5.268G
65	5.652G	66	5.442G	67	5.687G	68	5.348G
69	5.318G	70	5.542G	71	5.319G	72	5.616G
73	5.250G	74	5.556G	75	5.486G	76	5.419G
77	5.695G	78	5.379G	79	5.545G	80	5.401G

81	5.485G	82	5.280G	83	5.548G	84	5.262G
85	5.363G	86	5.581G	87	5.516G	88	5.554G
89	5.579G	90	5.596G	91	5.376G	92	5.479G
93	5.563G	94	5.505G	95	5.298G	96	5.347G
97	5.549G	98	5.524G	99	5.410G	100	5.291G

Hopping Frequency Sequence Name: HOP_FREQ_SEQ_20							
SEQ#	Frequency (Hz)	SEQ#	Frequency (Hz)	SEQ#	Frequency (Hz)	SEQ#	Frequency (Hz)
1	5.674G	2	5.475G	3	5.290G	4	5.341G
5	5.404G	6	5.336G	7	5.428G	8	5.429G
9	5.583G	10	5.611G	11	5.608G	12	5.511G
13	5.427G	14	5.305G	15	5.701G	16	5.619G
17	5.303G	18	5.626G	19	5.684G	20	5.719G
21	5.614G	22	5.301G	23	5.355G	24	5.252G
25	5.327G	26	5.379G	27	5.682G	28	5.395G
29	5.576G	30	5.575G	31	5.293G	32	5.461G
33	5.538G	34	5.493G	35	5.348G	36	5.268G
37	5.665G	38	5.332G	39	5.699G	40	5.679G
41	5.598G	42	5.484G	43	5.307G	44	5.559G
45	5.331G	46	5.383G	47	5.660G	48	5.451G
49	5.328G	50	5.573G	51	5.693G	52	5.387G
53	5.636G	54	5.605G	55	5.285G	56	5.691G
57	5.506G	58	5.510G	59	5.597G	60	5.476G
61	5.666G	62	5.517G	63	5.600G	64	5.337G
65	5.500G	66	5.460G	67	5.703G	68	5.425G
69	5.670G	70	5.555G	71	5.564G	72	5.250G
73	5.570G	74	5.507G	75	5.596G	76	5.482G
77	5.519G	78	5.662G	79	5.257G	80	5.491G
81	5.412G	82	5.292G	83	5.400G	84	5.295G
85	5.525G	86	5.453G	87	5.560G	88	5.592G
89	5.364G	90	5.494G	91	5.687G	92	5.351G
93	5.297G	94	5.577G	95	5.612G	96	5.463G
97	5.349G	98	5.552G	99	5.492G	100	5.546G

Hopping Frequency Sequence Name: HOP_FREQ_SEQ_21							
SEQ#	Frequency (Hz)	SEQ#	Frequency (Hz)	SEQ#	Frequency (Hz)	SEQ#	Frequency (Hz)
1	5.270G	2	5.525G	3	5.527G	4	5.628G
5	5.402G	6	5.639G	7	5.615G	8	5.369G
9	5.302G	10	5.456G	11	5.250G	12	5.407G
13	5.362G	14	5.435G	15	5.252G	16	5.698G
17	5.660G	18	5.442G	19	5.385G	20	5.359G
21	5.685G	22	5.263G	23	5.404G	24	5.387G
25	5.661G	26	5.510G	27	5.449G	28	5.395G
29	5.704G	30	5.496G	31	5.467G	32	5.554G
33	5.257G	34	5.393G	35	5.305G	36	5.572G
37	5.700G	38	5.373G	39	5.548G	40	5.320G
41	5.392G	42	5.296G	43	5.274G	44	5.610G
45	5.611G	46	5.581G	47	5.409G	48	5.390G
49	5.451G	50	5.376G	51	5.417G	52	5.523G
53	5.282G	54	5.432G	55	5.546G	56	5.497G
57	5.355G	58	5.276G	59	5.342G	60	5.327G
61	5.637G	62	5.289G	63	5.293G	64	5.539G
65	5.627G	66	5.379G	67	5.299G	68	5.427G
69	5.595G	70	5.553G	71	5.315G	72	5.669G
73	5.709G	74	5.405G	75	5.587G	76	5.360G
77	5.663G	78	5.461G	79	5.565G	80	5.275G
81	5.308G	82	5.487G	83	5.620G	84	5.540G
85	5.469G	86	5.561G	87	5.545G	88	5.597G
89	5.536G	90	5.506G	91	5.318G	92	5.697G
93	5.295G	94	5.519G	95	5.560G	96	5.389G
97	5.719G	98	5.654G	99	5.336G	100	5.608G

Hopping Frequency Sequence Name: HOP_FREQ_SEQ_22							
SEQ#	Frequency (Hz)	SEQ#	Frequency (Hz)	SEQ#	Frequency (Hz)	SEQ#	Frequency (Hz)
1	5.288G	2	5.441G	3	5.682G	4	5.304G
5	5.313G	6	5.446G	7	5.442G	8	5.612G
9	5.345G	10	5.337G	11	5.557G	12	5.638G
13	5.427G	14	5.303G	15	5.298G	16	5.592G

17	5.267G	18	5.717G	19	5.568G	20	5.320G
21	5.697G	22	5.541G	23	5.667G	24	5.506G
25	5.423G	26	5.518G	27	5.575G	28	5.413G
29	5.527G	30	5.283G	31	5.709G	32	5.469G
33	5.554G	34	5.418G	35	5.250G	36	5.495G
37	5.366G	38	5.681G	39	5.716G	40	5.471G
41	5.302G	42	5.628G	43	5.534G	44	5.698G
45	5.439G	46	5.510G	47	5.673G	48	5.408G
49	5.624G	50	5.280G	51	5.473G	52	5.676G
53	5.582G	54	5.400G	55	5.648G	56	5.383G
57	5.626G	58	5.358G	59	5.296G	60	5.641G
61	5.690G	62	5.608G	63	5.365G	64	5.397G
65	5.629G	66	5.647G	67	5.620G	68	5.493G
69	5.417G	70	5.570G	71	5.596G	72	5.581G
73	5.285G	74	5.606G	75	5.654G	76	5.445G
77	5.318G	78	5.404G	79	5.553G	80	5.335G
81	5.378G	82	5.505G	83	5.694G	84	5.487G
85	5.715G	86	5.269G	87	5.552G	88	5.287G
89	5.315G	90	5.289G	91	5.422G	92	5.431G
93	5.569G	94	5.507G	95	5.478G	96	5.464G
97	5.702G	98	5.347G	99	5.275G	100	5.409G

Hopping Frequency Sequence Name: HOP_FREQ_SEQ_23							
SEQ#	Frequency (Hz)	SEQ#	Frequency (Hz)	SEQ#	Frequency (Hz)	SEQ#	Frequency (Hz)
1	5.521G	2	5.425G	3	5.711G	4	5.694G
5	5.679G	6	5.449G	7	5.723G	8	5.440G
9	5.279G	10	5.442G	11	5.700G	12	5.326G
13	5.286G	14	5.608G	15	5.664G	16	5.265G
17	5.395G	18	5.687G	19	5.258G	20	5.656G
21	5.348G	22	5.319G	23	5.306G	24	5.412G
25	5.624G	26	5.556G	27	5.420G	28	5.457G
29	5.404G	30	5.693G	31	5.640G	32	5.606G
33	5.627G	34	5.367G	35	5.387G	36	5.401G
37	5.441G	38	5.580G	39	5.398G	40	5.274G
41	5.323G	42	5.651G	43	5.386G	44	5.683G
45	5.300G	46	5.283G	47	5.655G	48	5.638G

49	5.487G	50	5.705G	51	5.358G	52	5.600G
53	5.559G	54	5.261G	55	5.614G	56	5.581G
57	5.409G	58	5.424G	59	5.322G	60	5.292G
61	5.263G	62	5.667G	63	5.682G	64	5.397G
65	5.264G	66	5.482G	67	5.713G	68	5.302G
69	5.650G	70	5.572G	71	5.464G	72	5.686G
73	5.351G	74	5.562G	75	5.573G	76	5.355G
77	5.724G	78	5.550G	79	5.476G	80	5.603G
81	5.450G	82	5.601G	83	5.684G	84	5.592G
85	5.354G	86	5.255G	87	5.359G	88	5.568G
89	5.702G	90	5.692G	91	5.336G	92	5.639G
93	5.484G	94	5.637G	95	5.477G	96	5.520G
97	5.327G	98	5.378G	99	5.461G	100	5.501G

Hopping Frequency Sequence Name: HOP_FREQ_SEQ_24							
SEQ#	Frequency (Hz)	SEQ#	Frequency (Hz)	SEQ#	Frequency (Hz)	SEQ#	Frequency (Hz)
1	5.461G	2	5.451G	3	5.572G	4	5.600G
5	5.561G	6	5.338G	7	5.515G	8	5.403G
9	5.527G	10	5.628G	11	5.654G	12	5.544G
13	5.367G	14	5.353G	15	5.665G	16	5.573G
17	5.377G	18	5.534G	19	5.432G	20	5.621G
21	5.302G	22	5.414G	23	5.560G	24	5.574G
25	5.381G	26	5.533G	27	5.546G	28	5.404G
29	5.700G	30	5.325G	31	5.355G	32	5.685G
33	5.588G	34	5.625G	35	5.294G	36	5.505G
37	5.344G	38	5.352G	39	5.630G	40	5.599G
41	5.430G	42	5.495G	43	5.431G	44	5.253G
45	5.714G	46	5.258G	47	5.691G	48	5.719G
49	5.287G	50	5.557G	51	5.623G	52	5.343G
53	5.682G	54	5.717G	55	5.408G	56	5.526G
57	5.569G	58	5.393G	59	5.452G	60	5.549G
61	5.705G	62	5.375G	63	5.271G	64	5.264G
65	5.470G	66	5.674G	67	5.312G	68	5.389G
69	5.341G	70	5.358G	71	5.394G	72	5.440G
73	5.493G	74	5.538G	75	5.604G	76	5.699G
77	5.554G	78	5.586G	79	5.380G	80	5.454G

81	5.662G	82	5.304G	83	5.443G	84	5.267G
85	5.649G	86	5.364G	87	5.487G	88	5.636G
89	5.276G	90	5.360G	91	5.722G	92	5.694G
93	5.616G	94	5.255G	95	5.351G	96	5.424G
97	5.279G	98	5.663G	99	5.382G	100	5.373G

Hopping Frequency Sequence Name: HOP_FREQ_SEQ_25							
SEQ#	Frequency (Hz)	SEQ#	Frequency (Hz)	SEQ#	Frequency (Hz)	SEQ#	Frequency (Hz)
1	5.536G	2	5.267G	3	5.257G	4	5.254G
5	5.720G	6	5.325G	7	5.329G	8	5.393G
9	5.689G	10	5.621G	11	5.601G	12	5.464G
13	5.700G	14	5.261G	15	5.418G	16	5.270G
17	5.417G	18	5.702G	19	5.341G	20	5.565G
21	5.573G	22	5.310G	23	5.537G	24	5.612G
25	5.495G	26	5.314G	27	5.714G	28	5.723G
29	5.292G	30	5.369G	31	5.401G	32	5.378G
33	5.716G	34	5.311G	35	5.667G	36	5.455G
37	5.467G	38	5.336G	39	5.520G	40	5.600G
41	5.535G	42	5.595G	43	5.604G	44	5.363G
45	5.696G	46	5.472G	47	5.677G	48	5.598G
49	5.425G	50	5.391G	51	5.660G	52	5.650G
53	5.352G	54	5.586G	55	5.360G	56	5.371G
57	5.532G	58	5.420G	59	5.692G	60	5.454G
61	5.579G	62	5.539G	63	5.617G	64	5.516G
65	5.498G	66	5.649G	67	5.452G	68	5.514G
69	5.412G	70	5.293G	71	5.668G	72	5.574G
73	5.547G	74	5.424G	75	5.326G	76	5.722G
77	5.524G	78	5.289G	79	5.258G	80	5.713G
81	5.451G	82	5.251G	83	5.618G	84	5.357G
85	5.446G	86	5.348G	87	5.427G	88	5.681G
89	5.544G	90	5.260G	91	5.606G	92	5.280G
93	5.501G	94	5.438G	95	5.474G	96	5.284G
97	5.382G	98	5.376G	99	5.444G	100	5.496G

Hopping Frequency Sequence Name: HOP_FREQ_SEQ_26							
SEQ#	Frequency (Hz)	SEQ#	Frequency (Hz)	SEQ#	Frequency (Hz)	SEQ#	Frequency (Hz)
1	5.635G	2	5.651G	3	5.269G	4	5.372G
5	5.328G	6	5.410G	7	5.344G	8	5.563G
9	5.250G	10	5.420G	11	5.549G	12	5.565G
13	5.346G	14	5.682G	15	5.548G	16	5.632G
17	5.573G	18	5.614G	19	5.376G	20	5.690G
21	5.495G	22	5.409G	23	5.348G	24	5.648G
25	5.469G	26	5.666G	27	5.272G	28	5.408G
29	5.584G	30	5.571G	31	5.553G	32	5.425G
33	5.512G	34	5.619G	35	5.386G	36	5.368G
37	5.318G	38	5.620G	39	5.609G	40	5.336G
41	5.560G	42	5.424G	43	5.610G	44	5.429G
45	5.433G	46	5.680G	47	5.313G	48	5.366G
49	5.576G	50	5.396G	51	5.669G	52	5.663G
53	5.283G	54	5.562G	55	5.270G	56	5.697G
57	5.481G	58	5.668G	59	5.533G	60	5.688G
61	5.487G	62	5.305G	63	5.389G	64	5.589G
65	5.296G	66	5.364G	67	5.597G	68	5.494G
69	5.419G	70	5.698G	71	5.427G	72	5.662G
73	5.397G	74	5.261G	75	5.444G	76	5.465G
77	5.678G	78	5.498G	79	5.684G	80	5.629G
81	5.464G	82	5.282G	83	5.251G	84	5.700G
85	5.473G	86	5.634G	87	5.567G	88	5.380G
89	5.460G	90	5.468G	91	5.362G	92	5.527G
93	5.539G	94	5.720G	95	5.439G	96	5.704G
97	5.438G	98	5.339G	99	5.583G	100	5.486G

Hopping Frequency Sequence Name: HOP_FREQ_SEQ_27							
SEQ#	Frequency (Hz)	SEQ#	Frequency (Hz)	SEQ#	Frequency (Hz)	SEQ#	Frequency (Hz)
1	5.370G	2	5.453G	3	5.644G	4	5.308G
5	5.373G	6	5.503G	7	5.257G	8	5.336G
9	5.387G	10	5.669G	11	5.319G	12	5.548G
13	5.273G	14	5.334G	15	5.663G	16	5.428G

17	5.492G	18	5.638G	19	5.295G	20	5.388G
21	5.512G	22	5.513G	23	5.455G	24	5.405G
25	5.496G	26	5.538G	27	5.596G	28	5.654G
29	5.368G	30	5.674G	31	5.279G	32	5.696G
33	5.277G	34	5.718G	35	5.600G	36	5.327G
37	5.660G	38	5.714G	39	5.723G	40	5.631G
41	5.539G	42	5.420G	43	5.482G	44	5.353G
45	5.345G	46	5.702G	47	5.390G	48	5.668G
49	5.349G	50	5.480G	51	5.534G	52	5.583G
53	5.256G	54	5.526G	55	5.643G	56	5.304G
57	5.435G	58	5.377G	59	5.264G	60	5.656G
61	5.450G	62	5.448G	63	5.298G	64	5.697G
65	5.282G	66	5.468G	67	5.586G	68	5.430G
69	5.561G	70	5.576G	71	5.401G	72	5.402G
73	5.553G	74	5.568G	75	5.323G	76	5.281G
77	5.285G	78	5.381G	79	5.270G	80	5.635G
81	5.577G	82	5.486G	83	5.684G	84	5.602G
85	5.374G	86	5.708G	87	5.501G	88	5.592G
89	5.499G	90	5.484G	91	5.682G	92	5.607G
93	5.507G	94	5.375G	95	5.678G	96	5.641G
97	5.646G	98	5.557G	99	5.588G	100	5.691G

Hopping Frequency Sequence Name: HOP_FREQ_SEQ_28							
SEQ#	Frequency (Hz)	SEQ#	Frequency (Hz)	SEQ#	Frequency (Hz)	SEQ#	Frequency (Hz)
1	5.347G	2	5.450G	3	5.355G	4	5.604G
5	5.544G	6	5.673G	7	5.325G	8	5.523G
9	5.721G	10	5.585G	11	5.703G	12	5.475G
13	5.390G	14	5.525G	15	5.337G	16	5.267G
17	5.285G	18	5.320G	19	5.322G	20	5.281G
21	5.682G	22	5.675G	23	5.718G	24	5.669G
25	5.279G	26	5.269G	27	5.265G	28	5.636G
29	5.677G	30	5.483G	31	5.376G	32	5.495G
33	5.535G	34	5.335G	35	5.601G	36	5.275G
37	5.349G	38	5.368G	39	5.552G	40	5.521G
41	5.411G	42	5.417G	43	5.457G	44	5.303G
45	5.366G	46	5.709G	47	5.437G	48	5.292G

49	5.536G	50	5.298G	51	5.405G	52	5.333G
53	5.658G	54	5.354G	55	5.657G	56	5.623G
57	5.403G	58	5.421G	59	5.534G	60	5.491G
61	5.582G	62	5.713G	63	5.546G	64	5.428G
65	5.459G	66	5.435G	67	5.512G	68	5.352G
69	5.280G	70	5.440G	71	5.338G	72	5.487G
73	5.426G	74	5.288G	75	5.722G	76	5.705G
77	5.704G	78	5.628G	79	5.538G	80	5.478G
81	5.602G	82	5.434G	83	5.710G	84	5.441G
85	5.315G	86	5.717G	87	5.714G	88	5.569G
89	5.592G	90	5.461G	91	5.344G	92	5.622G
93	5.511G	94	5.460G	95	5.409G	96	5.668G
97	5.264G	98	5.517G	99	5.584G	100	5.259G

Hopping Frequency Sequence Name: HOP_FREQ_SEQ_29							
SEQ#	Frequency (Hz)	SEQ#	Frequency (Hz)	SEQ#	Frequency (Hz)	SEQ#	Frequency (Hz)
1	5.449G	2	5.476G	3	5.473G	4	5.397G
5	5.508G	6	5.695G	7	5.656G	8	5.679G
9	5.435G	10	5.293G	11	5.618G	12	5.439G
13	5.468G	14	5.521G	15	5.563G	16	5.462G
17	5.633G	18	5.641G	19	5.533G	20	5.669G
21	5.486G	22	5.627G	23	5.403G	24	5.348G
25	5.614G	26	5.529G	27	5.671G	28	5.549G
29	5.638G	30	5.295G	31	5.518G	32	5.255G
33	5.432G	34	5.277G	35	5.709G	36	5.535G
37	5.286G	38	5.557G	39	5.619G	40	5.719G
41	5.259G	42	5.320G	43	5.639G	44	5.429G
45	5.451G	46	5.603G	47	5.382G	48	5.341G
49	5.357G	50	5.714G	51	5.377G	52	5.423G
53	5.580G	54	5.314G	55	5.335G	56	5.543G
57	5.278G	58	5.406G	59	5.676G	60	5.454G
61	5.591G	62	5.433G	63	5.632G	64	5.532G
65	5.697G	66	5.422G	67	5.478G	68	5.321G
69	5.381G	70	5.569G	71	5.398G	72	5.272G
73	5.500G	74	5.635G	75	5.280G	76	5.323G
77	5.516G	78	5.299G	79	5.710G	80	5.620G

81	5.675G	82	5.345G	83	5.362G	84	5.498G
85	5.322G	86	5.339G	87	5.552G	88	5.648G
89	5.541G	90	5.523G	91	5.337G	92	5.380G
93	5.650G	94	5.326G	95	5.418G	96	5.502G
97	5.351G	98	5.264G	99	5.626G	100	5.565G

Hopping Frequency Sequence Name: HOP_FREQ_SEQ_30							
SEQ#	Frequency (Hz)	SEQ#	Frequency (Hz)	SEQ#	Frequency (Hz)	SEQ#	Frequency (Hz)
1	5.672G	2	5.293G	3	5.512G	4	5.436G
5	5.415G	6	5.447G	7	5.336G	8	5.636G
9	5.316G	10	5.650G	11	5.392G	12	5.567G
13	5.600G	14	5.668G	15	5.696G	16	5.459G
17	5.305G	18	5.396G	19	5.574G	20	5.587G
21	5.623G	22	5.644G	23	5.724G	24	5.442G
25	5.294G	26	5.548G	27	5.253G	28	5.443G
29	5.542G	30	5.258G	31	5.261G	32	5.353G
33	5.515G	34	5.430G	35	5.648G	36	5.344G
37	5.296G	38	5.462G	39	5.514G	40	5.709G
41	5.562G	42	5.622G	43	5.540G	44	5.365G
45	5.417G	46	5.255G	47	5.513G	48	5.639G
49	5.621G	50	5.494G	51	5.358G	52	5.398G
53	5.700G	54	5.569G	55	5.378G	56	5.420G
57	5.444G	58	5.572G	59	5.362G	60	5.297G
61	5.712G	62	5.519G	63	5.303G	64	5.505G
65	5.486G	66	5.466G	67	5.597G	68	5.427G
69	5.448G	70	5.460G	71	5.310G	72	5.502G
73	5.590G	74	5.487G	75	5.625G	76	5.581G
77	5.431G	78	5.723G	79	5.545G	80	5.264G
81	5.651G	82	5.338G	83	5.301G	84	5.299G
85	5.346G	86	5.713G	87	5.282G	88	5.286G
89	5.559G	90	5.593G	91	5.533G	92	5.278G
93	5.266G	94	5.332G	95	5.380G	96	5.350G
97	5.483G	98	5.682G	99	5.414G	100	5.428G

IEEE 802.11ac VHT80

Type 1 Radar Statistical Performances				
Trial #	Pulses per Burst	Pulse Width (s)	PRI (s)	Detection
1	102	1.0u	518.0u	Yes
2	99	1.0u	538.0u	Yes
3	95	1.0u	558.0u	Yes
4	92	1.0u	578.0u	Yes
5	89	1.0u	598.0u	Yes
6	86	1.0u	618.0u	Yes
7	83	1.0u	638.0u	Yes
8	81	1.0u	658.0u	Yes
9	78	1.0u	678.0u	Yes
10	76	1.0u	698.0u	Yes
11	74	1.0u	718.0u	Yes
12	72	1.0u	738.0u	Yes
13	68	1.0u	778.0u	Yes
14	65	1.0u	818.0u	Yes
15	61	1.0u	878.0u	Yes
16	80	1.0u	667.0u	Yes
17	75	1.0u	707.0u	Yes
18	83	1.0u	639.0u	Yes
19	74	1.0u	719.0u	Yes
20	57	1.0u	927.0u	Yes
21	100	1.0u	529.0u	Yes
22	93	1.0u	569.0u	Yes
23	72	1.0u	739.0u	Yes
24	84	1.0u	629.0u	Yes
25	71	1.0u	749.0u	Yes
26	63	1.0u	849.0u	Yes
27	96	1.0u	551.0u	Yes
28	67	1.0u	799.0u	Yes
29	81	1.0u	653.0u	Yes
30	58	1.0u	913.0u	Yes
				Detection Rate: 100.0 %

Type 2 Radar Statistical Performances				
Trial #	Pulses per Burst	Pulse Width (s)	PRI (s)	Detection
1	26	4.5u	178.0u	No
2	28	2.4u	183.0u	Yes
3	25	3.0u	208.0u	No
4	26	3.5u	157.0u	Yes
5	26	3.1u	189.0u	Yes
6	29	2.9u	176.0u	Yes
7	28	3.5u	177.0u	No
8	27	4.3u	211.0u	Yes
9	28	3.7u	168.0u	Yes
10	26	2.7u	181.0u	No
11	23	2.7u	217.0u	Yes
12	27	3.8u	225.0u	Yes
13	26	2.0u	216.0u	Yes
14	25	4.3u	164.0u	Yes
15	29	4.3u	170.0u	Yes
16	28	4.9u	180.0u	Yes
17	29	2.1u	196.0u	Yes
18	28	4.5u	207.0u	No
19	25	4.4u	157.0u	Yes
20	26	2.6u	212.0u	Yes
21	29	3.9u	184.0u	No
22	26	3.9u	197.0u	Yes
23	25	4.6u	157.0u	Yes
24	28	1.3u	175.0u	Yes
25	26	1.9u	212.0u	Yes
26	26	3.1u	191.0u	Yes
27	29	3.6u	174.0u	Yes
28	25	4.0u	174.0u	Yes
29	27	2.5u	197.0u	Yes
30	27	3.2u	226.0u	Yes
			Detection Rate: 80.0 %	

Type 3 Radar Statistical Performances				
Trial #	Pulses per Burst	Pulse Width (s)	PRI (s)	Detection
1	16	7.5u	305.0u	Yes
2	16	9.7u	274.0u	Yes
3	17	7.6u	422.0u	Yes
4	17	7.4u	436.0u	Yes
5	17	8.7u	460.0u	Yes
6	17	9.0u	389.0u	Yes
7	17	8.3u	381.0u	Yes
8	17	6.8u	273.0u	Yes
9	17	9.4u	346.0u	Yes
10	16	8.1u	342.0u	Yes
11	17	9.8u	497.0u	No
12	18	6.6u	254.0u	Yes
13	17	9.7u	384.0u	Yes
14	17	7.6u	243.0u	Yes
15	18	7.5u	348.0u	Yes
16	16	6.9u	284.0u	Yes
17	17	8.0u	272.0u	Yes
18	17	8.8u	395.0u	Yes
19	17	7.5u	453.0u	Yes
20	18	7.7u	263.0u	Yes
21	17	9.1u	384.0u	Yes
22	17	8.2u	226.0u	No
23	17	6.7u	474.0u	Yes
24	16	8.5u	429.0u	Yes
25	16	7.3u	301.0u	Yes
26	17	9.6u	271.0u	Yes
27	18	9.3u	375.0u	Yes
28	18	8.5u	254.0u	Yes
29	16	9.2u	428.0u	Yes
30	17	8.5u	318.0u	Yes
			Detection Rate: 93.3 %	

Type 4 Radar Statistical Performances				
Trial #	Pulses per Burst	Pulse Width (s)	PRI (s)	Detection
1	14	16.1u	359.0u	No
2	12	19.9u	419.0u	Yes
3	15	19.1u	300.0u	No
4	12	16.5u	497.0u	Yes
5	16	11.5u	347.0u	Yes
6	15	17.7u	333.0u	Yes
7	15	13.0u	396.0u	Yes
8	16	12.4u	326.0u	No
9	14	17.7u	309.0u	Yes
10	14	17.9u	416.0u	Yes
11	14	14.4u	441.0u	Yes
12	14	11.4u	305.0u	Yes
13	13	17.2u	203.0u	No
14	16	16.1u	371.0u	Yes
15	15	19.9u	204.0u	Yes
16	12	12.8u	444.0u	No
17	15	15.6u	415.0u	Yes
18	14	19.7u	321.0u	Yes
19	14	19.9u	499.0u	Yes
20	13	13.1u	438.0u	Yes
21	15	16.6u	432.0u	Yes
22	13	18.1u	351.0u	Yes
23	16	18.6u	382.0u	Yes
24	15	19.2u	484.0u	Yes
25	16	15.7u	496.0u	Yes
26	15	13.7u	368.0u	Yes
27	13	17.7u	311.0u	Yes
28	13	13.8u	368.0u	Yes
29	13	19.1u	404.0u	No
30	13	15.2u	226.0u	No
			Detection Rate: 76.7 %	

Type 5 Radar Statistical Performances		
Trial #	Test Signal Name	Detection
1	LP_Signal_01	Yes
2	LP_Signal_02	Yes
3	LP_Signal_03	Yes
4	LP_Signal_04	Yes
5	LP_Signal_05	Yes
6	LP_Signal_06	Yes
7	LP_Signal_07	Yes
8	LP_Signal_08	Yes
9	LP_Signal_09	Yes
10	LP_Signal_10	Yes
11	LP_Signal_11	No
12	LP_Signal_12	Yes
13	LP_Signal_13	Yes
14	LP_Signal_14	Yes
15	LP_Signal_15	Yes
16	LP_Signal_16	Yes
17	LP_Signal_17	Yes
18	LP_Signal_18	Yes
19	LP_Signal_19	Yes
20	LP_Signal_20	Yes
21	LP_Signal_21	Yes
22	LP_Signal_22	Yes
23	LP_Signal_23	Yes
24	LP_Signal_24	Yes
25	LP_Signal_25	Yes
26	LP_Signal_26	No
27	LP_Signal_27	No
28	LP_Signal_28	Yes
29	LP_Signal_29	Yes
30	LP_Signal_30	Yes
		Detection Rate: 90.0 %

Long Pulse Radar Test Signal						
Test Signal Name: LP_Signal_01						
Number of Bursts in Trial: 13						
Chrip Center Frequency: 5499MHz						
Burst	Pulses per Burst	Chrip (Hz)	Pulse Width (s)	Pulse 1 to 2 Spacing (s)	Pulse 2 to 3 Spacing (s)	Start Location (s)
1	1	14M	98.4u	-	-	455.0m
2	2	12M	55.6u	1.396m	-	534.3m
3	3	11M	88.6u	1.055m	1.079m	156.1m
4	2	7M	64.8u	1.901m	-	132.9m
5	3	12M	79.0u	993.0u	998.0u	120.0m
6	2	15M	64.5u	1.496m	-	769.4m
7	2	6M	97.9u	1.601m	-	460.5m
8	1	16M	95.0u	-	-	550.0m
9	2	6M	51.7u	1.251m	-	344.8m
10	1	18M	81.7u	-	-	395.7m
11	3	7M	95.9u	1.352m	1.146m	558.8m
12	2	14M	79.2u	1.876m	-	89.70m
13	2	15M	91.2u	1.210m	-	425.3m

Long Pulse Radar Test Signal						
Test Signal Name: LP_Signal_02						
Number of Bursts in Trial: 16						
Chrip Center Frequency: 5502MHz						
Burst	Pulses per Burst	Chrip (Hz)	Pulse Width (s)	Pulse 1 to 2 Spacing (s)	Pulse 2 to 3 Spacing (s)	Start Location (s)
1	3	14M	64.3u	971.7u	1.410m	149.4m
2	2	9M	69.2u	1.861m	-	538.8m
3	2	16M	59.4u	1.302m	-	511.1m
4	3	15M	55.3u	968.7u	1.083m	229.2m
5	3	12M	84.8u	1.088m	1.366m	607.3m
6	1	18M	58.9u	-	-	646.1m
7	3	16M	56.6u	1.149m	1.131m	464.4m
8	2	18M	99.2u	1.209m	-	239.8m

9	2	5M	80.2u	1.220m	-	452.8m
10	2	20M	78.6u	1.438m	-	235.4m
11	2	9M	89.3u	1.264m	-	192.6m
12	2	9M	76.8u	1.856m	-	387.2m
13	1	12M	69.2u	-	-	447.7m
14	2	17M	97.1u	1.154m	-	535.9m
15	2	7M	94.8u	1.299m	-	163.7m
16	3	9M	84.1u	1.478m	1.505m	175.1m

Long Pulse Radar Test Signal						
Test Signal Name: LP_Signal_03						
Number of Bursts in Trial: 16						
Chrip Center Frequency: 5505MHz						
Burst	Pulses per Burst	Chrip (Hz)	Pulse Width (s)	Pulse 1 to 2 Spacing (s)	Pulse 2 to 3 Spacing (s)	Start Location (s)
1	1	16M	51.2u	-	-	713.2m
2	2	8M	65.6u	1.679m	-	64.79m
3	1	7M	57.2u	-	-	64.06m
4	3	5M	72.8u	1.613m	1.695m	3.216m
5	1	19M	94.4u	-	-	401.1m
6	2	11M	87.4u	1.721m	-	49.87m
7	2	10M	50.2u	1.188m	-	730.7m
8	2	11M	91.9u	1.264m	-	622.7m
9	1	8M	72.2u	-	-	235.9m
10	2	7M	70.5u	1.615m	-	692.6m
11	2	6M	84.0u	1.135m	-	695.6m
12	2	14M	77.4u	1.238m	-	400.7m
13	2	15M	80.2u	1.171m	-	628.3m
14	2	14M	91.8u	1.287m	-	719.6m
15	2	17M	99.2u	995.8u	-	553.9m
16	2	11M	83.4u	1.542m	-	239.6m

Long Pulse Radar Test Signal						
Test Signal Name: LP_Signal_04						
Number of Bursts in Trial: 16						
Chrip Center Frequency: 5508MHz						
Burst	Pulses per Burst	Chrip (Hz)	Pulse Width (s)	Pulse 1 to 2 Spacing (s)	Pulse 2 to 3 Spacing (s)	Start Location (s)
1	2	11M	83.5u	1.408m	-	372.0m
2	2	8M	84.0u	1.625m	-	612.9m
3	2	16M	98.2u	1.071m	-	28.15m
4	1	5M	91.2u	-	-	457.7m
5	2	13M	52.4u	1.909m	-	213.7m
6	2	10M	67.2u	1.278m	-	714.9m
7	2	20M	81.3u	1.808m	-	132.2m
8	3	5M	90.0u	1.272m	1.869m	18.42m
9	2	12M	85.2u	1.447m	-	723.9m
10	2	14M	75.2u	1.410m	-	509.2m
11	3	6M	83.8u	1.276m	955.2u	534.4m
12	2	13M	56.6u	1.738m	-	287.8m
13	2	17M	65.6u	1.454m	-	21.77m
14	1	18M	60.4u	-	-	180.0m
15	1	7M	74.6u	-	-	608.4m
16	3	17M	51.8u	1.166m	1.324m	281.6m

Long Pulse Radar Test Signal						
Test Signal Name: LP_Signal_05						
Number of Bursts in Trial: 11						
Burst	Pulses per Burst	Chrip (Hz)	Pulse Width (s)	Pulse 1 to 2 Spacing (s)	Pulse 2 to 3 Spacing (s)	Start Location (s)
1	3	17M	80.7u	1.178m	1.669m	248.0m
2	2	14M	94.6u	1.005m	-	6.709m
3	2	7M	71.1u	1.239m	-	922.2m
4	3	7M	77.8u	1.705m	1.059m	891.1m
5	2	8M	76.7u	1.210m	-	989.2m
6	3	5M	63.5u	966.5u	992.5u	728.6m

7	3	13M	90.7u	1.477m	1.181m	1.005
8	3	17M	87.9u	1.015m	1.053m	720.0m
9	3	18M	87.5u	974.5u	930.5u	1.037
10	2	14M	86.8u	1.185m	-	819.5m
11	3	8M	70.5u	1.722m	1.283m	82.74m

Long Pulse Radar Test Signal						
Test Signal Name: LP_Signal_06						
Number of Bursts in Trial: 13						
Chrip Center Frequency: 5511MHz						
Burst	Pulses per Burst	Chrip (Hz)	Pulse Width (s)	Pulse 1 to 2 Spacing (s)	Pulse 2 to 3 Spacing (s)	Start Location (s)
1	2	15M	59.5u	1.569m	-	54.41m
2	1	20M	57.3u	-	-	603.7m
3	2	5M	59.1u	1.703m	-	618.9m
4	3	14M	52.8u	1.695m	1.774m	833.5m
5	2	16M	98.6u	1.616m	-	980.0u
6	1	17M	95.1u	-	-	379.7m
7	2	13M	50.7u	1.015m	-	5.528m
8	1	18M	82.6u	-	-	741.8m
9	2	15M	51.4u	1.337m	-	837.7m
10	1	5M	52.3u	-	-	489.7m
11	2	10M	75.6u	1.477m	-	549.4m
12	1	11M	89.1u	-	-	25.18m
13	1	18M	59.9u	-	-	67.05m

Long Pulse Radar Test Signal						
Test Signal Name: LP_Signal_07						
Number of Bursts in Trial: 19						
Chrip Center Frequency: 5514MHz						
Burst	Pulses per Burst	Chrip (Hz)	Pulse Width (s)	Pulse 1 to 2 Spacing (s)	Pulse 2 to 3 Spacing (s)	Start Location (s)
1	2	14M	66.7u	1.183m	-	142.4m
2	3	13M	66.1u	1.443m	996.9u	348.1m
3	2	8M	71.9u	1.168m	-	221.2m

4	2	18M	71.4u	1.889m	-	136.6m
5	1	16M	99.9u	-	-	392.0m
6	2	14M	85.1u	1.342m	-	367.1m
7	3	13M	72.5u	1.043m	1.357m	486.8m
8	3	7M	93.3u	1.129m	1.692m	311.2m
9	2	5M	85.6u	1.042m	-	254.8m
10	1	16M	67.1u	-	-	457.6m
11	2	16M	76.9u	1.406m	-	220.3m
12	1	7M	55.9u	-	-	390.3m
13	1	13M	86.6u	-	-	58.39m
14	2	11M	61.9u	1.871m	-	342.5m
15	2	20M	56.1u	1.169m	-	627.8m
16	3	6M	50.1u	1.782m	1.342m	107.1m
17	3	16M	86.4u	1.903m	1.212m	159.4m
18	2	9M	82.5u	1.848m	-	618.0m
19	2	9M	70.8u	1.242m	-	344.1m

Long Pulse Radar Test Signal						
Test Signal Name: LP_Signal_08						
Number of Bursts in Trial: 15						
Chrip Center Frequency: 5517MHz						
Burst	Pulses per Burst	Chrip (Hz)	Pulse Width (s)	Pulse 1 to 2 Spacing (s)	Pulse 2 to 3 Spacing (s)	Start Location (s)
1	1	7M	78.9u	-	-	435.9m
2	2	15M	70.5u	1.133m	-	584.7m
3	3	9M	56.4u	1.153m	1.877m	53.73m
4	2	18M	93.3u	983.7u	-	345.9m
5	1	15M	66.7u	-	-	145.4m
6	3	15M	92.6u	1.523m	1.547m	202.1m
7	2	19M	59.0u	1.511m	-	515.7m
8	3	6M	70.2u	1.474m	1.574m	590.9m
9	2	15M	73.4u	1.619m	-	322.1m
10	2	18M	84.0u	1.323m	-	241.2m
11	2	12M	89.8u	1.402m	-	596.0m
12	1	15M	61.8u	-	-	400.4m
13	2	15M	60.4u	1.247m	-	371.1m

14	2	9M	52.1u	1.459m	-	103.0m
15	2	13M	77.8u	1.138m	-	458.6m

Long Pulse Radar Test Signal						
Test Signal Name: LP_Signal_09						
Number of Bursts in Trial: 18						
Chrip Center Frequency: 5520MHz						
Burst	Pulses per Burst	Chrip (Hz)	Pulse Width (s)	Pulse 1 to 2 Spacing (s)	Pulse 2 to 3 Spacing (s)	Start Location (s)
1	2	5M	68.3u	1.433m	-	179.0m
2	2	15M	88.9u	1.639m	-	271.4m
3	2	6M	92.0u	1.668m	-	307.4m
4	2	18M	95.3u	1.445m	-	419.2m
5	2	16M	86.4u	1.065m	-	549.5m
6	2	15M	63.0u	1.343m	-	133.9m
7	3	16M	74.5u	1.525m	1.261m	476.1m
8	2	18M	51.3u	953.7u	-	351.8m
9	1	20M	73.7u	-	-	545.0m
10	2	14M	69.4u	1.469m	-	143.0m
11	3	7M	72.3u	1.814m	1.731m	582.4m
12	2	20M	61.5u	1.564m	-	663.2m
13	1	8M	64.2u	-	-	460.0m
14	2	10M	57.4u	1.677m	-	177.0m
15	1	11M	88.8u	-	-	50.51m
16	3	18M	93.5u	1.293m	1.687m	162.6m
17	3	12M	88.0u	1.902m	1.344m	105.9m
18	2	15M	53.2u	1.544m	-	349.0m

Long Pulse Radar Test Signal						
Test Signal Name: LP_Signal_10						
Number of Bursts in Trial: 13						
Chrip Center Frequency: 5523MHz						
Burst	Pulses per Burst	Chrip (Hz)	Pulse Width (s)	Pulse 1 to 2 Spacing (s)	Pulse 2 to 3 Spacing (s)	Start Location (s)
1	1	6M	74.7u	-	-	843.0m

2	2	16M	90.5u	1.448m	-	337.8m
3	2	8M	93.2u	1.217m	-	372.5m
4	1	11M	90.6u	-	-	395.2m
5	2	14M	91.8u	1.823m	-	502.5m
6	1	8M	74.7u	-	-	325.7m
7	1	6M	72.2u	-	-	838.0m
8	1	16M	93.2u	-	-	410.9m
9	2	17M	51.7u	1.805m	-	887.0m
10	3	17M	98.9u	1.129m	1.100m	109.2m
11	1	6M	86.4u	-	-	155.0m
12	2	8M	64.3u	1.329m	-	330.0u
13	1	16M	87.6u	-	-	468.2m

Long Pulse Radar Test Signal						
Test Signal Name: LP_Signal_11						
Number of Bursts in Trial: 8						
Chrip Center Frequency: 5526MHz						
Burst	Pulses per Burst	Chrip (Hz)	Pulse Width (s)	Pulse 1 to 2 Spacing (s)	Pulse 2 to 3 Spacing (s)	Start Location (s)
1	3	5M	72.9u	1.796m	1.901m	1.348
2	1	16M	69.5u	-	-	575.5m
3	2	17M	64.6u	1.190m	-	219.9m
4	2	15M	76.4u	1.902m	-	571.7m
5	3	16M	60.7u	1.117m	1.732m	1.229
6	3	11M	64.7u	1.101m	1.301m	398.4m
7	1	8M	65.9u	-	-	1.197
8	3	13M	83.0u	1.153m	1.424m	94.84m

Long Pulse Radar Test Signal						
Test Signal Name: LP_Signal_12						
Number of Bursts in Trial: 13						
Chrip Center Frequency: 5529MHz						
Burst	Pulses per Burst	Chrip (Hz)	Pulse Width (s)	Pulse 1 to 2 Spacing (s)	Pulse 2 to 3 Spacing (s)	Start Location (s)
1	1	10M	60.8u	-	-	867.4m

2	1	9M	68.2u	-	-	589.2m
3	2	8M	98.2u	1.503m	-	749.0m
4	3	9M	62.3u	1.056m	1.814m	581.8m
5	2	10M	90.3u	1.816m	-	838.5m
6	3	15M	77.8u	1.207m	1.163m	180.6m
7	2	11M	62.2u	1.572m	-	354.0m
8	1	7M	72.3u	-	-	123.0m
9	1	11M	80.6u	-	-	455.3m
10	2	15M	93.7u	966.3u	-	776.5m
11	2	13M	73.3u	1.824m	-	373.1m
12	2	17M	81.2u	1.377m	-	676.8m
13	2	11M	100.0u	1.487m	-	97.43m

Long Pulse Radar Test Signal						
Test Signal Name: LP_Signal_13						
Number of Bursts in Trial: 12						
Chrip Center Frequency: 5530MHz						
Burst	Pulses per Burst	Chrip (Hz)	Pulse Width (s)	Pulse 1 to 2 Spacing (s)	Pulse 2 to 3 Spacing (s)	Start Location (s)
1	1	15M	63.5u	-	-	954.8m
2	2	12M	51.0u	1.652m	-	301.6m
3	2	11M	60.9u	1.900m	-	836.0m
4	1	18M	69.4u	-	-	61.53m
5	2	15M	88.6u	1.272m	-	26.36m
6	2	18M	95.6u	957.4u	-	648.4m
7	2	5M	87.0u	1.829m	-	323.0m
8	3	5M	74.8u	1.424m	1.428m	435.3m
9	2	8M	68.8u	1.129m	-	918.6m
10	1	15M	59.6u	-	-	710.3m
11	2	17M	94.2u	930.8u	-	824.0m
12	2	19M	63.2u	1.172m	-	956.4m

Long Pulse Radar Test Signal						
Test Signal Name: LP_Signal_14						
Number of Bursts in Trial: 18						
Chrip Center Frequency: 5531MHz						
Burst	Pulses per Burst	Chrip (Hz)	Pulse Width (s)	Pulse 1 to 2 Spacing (s)	Pulse 2 to 3 Spacing (s)	Start Location (s)
1	2	7M	51.6u	1.436m	-	444.1m
2	1	14M	62.0u	-	-	323.6m
3	2	18M	83.4u	969.6u	-	398.6m
4	1	11M	60.3u	-	-	321.4m
5	2	8M	68.4u	1.632m	-	659.8m
6	3	17M	61.5u	1.669m	1.197m	64.22m
7	3	8M	71.0u	1.885m	1.503m	630.9m
8	1	8M	95.9u	-	-	16.51m
9	3	19M	51.0u	1.371m	1.871m	27.83m
10	2	9M	95.5u	1.603m	-	509.3m
11	2	18M	64.5u	1.717m	-	412.1m
12	2	14M	91.5u	1.460m	-	130.3m
13	1	6M	79.1u	-	-	412.6m
14	2	11M	76.0u	1.314m	-	379.4m
15	2	5M	81.2u	1.247m	-	42.66m
16	3	14M	86.2u	1.371m	1.776m	613.3m
17	3	7M	99.3u	1.322m	1.512m	200.9m
18	2	16M	68.1u	1.916m	-	498.9m

Long Pulse Radar Test Signal						
Test Signal Name: LP_Signal_15						
Number of Bursts in Trial: 16						
Chrip Center Frequency: 5534MHz						
Burst	Pulses per Burst	Chrip (Hz)	Pulse Width (s)	Pulse 1 to 2 Spacing (s)	Pulse 2 to 3 Spacing (s)	Start Location (s)
1	3	9M	50.6u	1.520m	1.687m	720.9m
2	2	13M	97.0u	1.194m	-	150.4m
3	1	10M	83.6u	-	-	252.0m

4	1	11M	85.3u	-	-	203.4m
5	2	15M	84.8u	941.2u	-	141.9m
6	1	13M	88.8u	-	-	28.48m
7	3	14M	78.4u	987.6u	1.161m	246.5m
8	3	10M	71.6u	1.374m	1.668m	604.1m
9	2	11M	55.3u	1.886m	-	667.7m
10	3	9M	80.0u	1.417m	1.372m	126.2m
11	2	20M	74.2u	1.919m	-	416.6m
12	2	9M	55.7u	1.378m	-	137.9m
13	2	18M	92.5u	1.814m	-	439.0m
14	1	7M	80.4u	-	-	435.4m
15	1	6M	82.5u	-	-	181.6m
16	2	9M	60.6u	1.007m	-	524.7m

Long Pulse Radar Test Signal						
Test Signal Name: LP_Signal_16						
Number of Bursts in Trial: 16						
Chrip Center Frequency: 5537MHz						
Burst	Pulses per Burst	Chrip (Hz)	Pulse Width (s)	Pulse 1 to 2 Spacing (s)	Pulse 2 to 3 Spacing (s)	Start Location (s)
1	3	16M	61.3u	1.396m	1.069m	252.6m
2	2	14M	70.8u	1.380m	-	253.2m
3	3	15M	95.3u	1.879m	1.731m	573.9m
4	1	6M	76.9u	-	-	402.5m
5	2	7M	71.8u	1.783m	-	12.22m
6	2	13M	66.3u	1.478m	-	722.8m
7	3	17M	60.5u	1.837m	1.202m	99.87m
8	2	10M	98.4u	1.398m	-	561.2m
9	2	8M	86.5u	1.569m	-	395.3m
10	1	11M	71.7u	-	-	136.3m
11	1	13M	57.1u	-	-	38.71m
12	1	20M	59.1u	-	-	119.6m
13	1	6M	51.4u	-	-	472.7m
14	2	13M	98.6u	1.724m	-	336.6m
15	1	17M	50.8u	-	-	538.9m
16	2	19M	96.7u	1.376m	-	319.9m

Long Pulse Radar Test Signal						
Test Signal Name: LP_Signal_17						
Number of Bursts in Trial: 10						
Chrip Center Frequency: 5540MHz						
Burst	Pulses per Burst	Chrip (Hz)	Pulse Width (s)	Pulse 1 to 2 Spacing (s)	Pulse 2 to 3 Spacing (s)	Start Location (s)
1	1	6M	80.1u	-	-	42.43m
2	2	12M	69.6u	1.689m	-	815.5m
3	1	9M	71.0u	-	-	767.5m
4	1	11M	51.4u	-	-	1.147
5	2	7M	50.2u	1.905m	-	719.1m
6	1	10M	66.4u	-	-	263.4m
7	2	5M	57.8u	1.278m	-	583.2m
8	1	18M	74.0u	-	-	643.4m
9	3	12M	55.7u	1.059m	1.141m	1.021
10	2	12M	51.9u	1.267m	-	586.9m

Long Pulse Radar Test Signal						
Test Signal Name: LP_Signal_18						
Number of Bursts in Trial: 18						
Chrip Center Frequency: 5543MHz						
Burst	Pulses per Burst	Chrip (Hz)	Pulse Width (s)	Pulse 1 to 2 Spacing (s)	Pulse 2 to 3 Spacing (s)	Start Location (s)
1	2	16M	58.3u	1.327m	-	118.5m
2	2	6M	56.1u	971.9u	-	657.9m
3	2	12M	50.4u	1.462m	-	95.20m
4	3	7M	65.6u	1.498m	1.624m	315.2m
5	2	17M	74.9u	1.483m	-	612.9m
6	2	8M	88.0u	1.661m	-	608.3m
7	2	18M	61.6u	941.4u	-	537.6m
8	1	12M	79.7u	-	-	587.5m
9	2	13M	77.7u	1.519m	-	289.8m
10	1	17M	79.3u	-	-	21.64m
11	3	15M	70.4u	1.893m	1.929m	542.5m

12	2	12M	87.4u	1.389m	-	415.5m
13	1	7M	91.1u	-	-	98.77m
14	2	12M	66.2u	1.803m	-	123.7m
15	1	19M	96.6u	-	-	516.1m
16	2	8M	87.9u	1.325m	-	25.39m
17	2	20M	83.0u	1.018m	-	285.4m
18	2	17M	82.9u	929.1u	-	584.2m

Long Pulse Radar Test Signal						
Test Signal Name: LP_Signal_19						
Number of Bursts in Trial: 8						
Chrip Center Frequency: 5546MHz						
Burst	Pulses per Burst	Chrip (Hz)	Pulse Width (s)	Pulse 1 to 2 Spacing (s)	Pulse 2 to 3 Spacing (s)	Start Location (s)
1	1	15M	81.0u	-	-	138.3m
2	2	19M	60.0u	1.459m	-	1.005
3	3	18M	50.9u	1.079m	1.113m	1.464
4	2	12M	69.7u	1.789m	-	1.321
5	1	18M	98.8u	-	-	1.149
6	2	10M	51.8u	1.414m	-	902.4m
7	1	8M	72.5u	-	-	523.7m
8	3	12M	77.1u	979.9u	1.489m	481.8m

Long Pulse Radar Test Signal						
Test Signal Name: LP_Signal_20						
Number of Bursts in Trial: 19						
Chrip Center Frequency: 5549MHz						
Burst	Pulses per Burst	Chrip (Hz)	Pulse Width (s)	Pulse 1 to 2 Spacing (s)	Pulse 2 to 3 Spacing (s)	Start Location (s)
1	2	17M	53.6u	949.4u	-	185.3m
2	2	13M	89.5u	1.085m	-	439.0m
3	3	18M	54.0u	1.787m	1.346m	557.1m
4	3	16M	57.5u	1.598m	1.889m	265.1m
5	2	19M	72.5u	1.678m	-	439.2m
6	2	7M	60.5u	1.608m	-	275.9m

7	2	11M	63.3u	1.310m	-	468.1m
8	1	9M	97.7u	-	-	168.0m
9	3	19M	55.7u	1.307m	1.516m	311.5m
10	2	16M	67.5u	1.821m	-	476.2m
11	3	10M	92.7u	1.843m	1.140m	62.61m
12	3	20M	51.1u	991.9u	1.585m	601.0m
13	1	13M	91.2u	-	-	500.8m
14	1	13M	55.8u	-	-	402.3m
15	1	13M	75.0u	-	-	151.1m
16	2	7M	66.4u	1.837m	-	533.3m
17	3	6M	86.6u	1.440m	1.008m	500.0m
18	1	11M	73.0u	-	-	590.5m
19	1	18M	86.4u	-	-	362.1m

Long Pulse Radar Test Signal						
Test Signal Name: LP_Signal_21						
Number of Bursts in Trial: 12						
Chrip Center Frequency: 5552MHz						
Burst	Pulses per Burst	Chrip (Hz)	Pulse Width (s)	Pulse 1 to 2 Spacing (s)	Pulse 2 to 3 Spacing (s)	Start Location (s)
1	1	7M	75.9u	-	-	781.9m
2	2	19M	56.9u	1.313m	-	922.6m
3	3	16M	68.1u	1.230m	1.264m	174.3m
4	2	9M	97.2u	1.134m	-	437.1m
5	1	12M	60.1u	-	-	888.3m
6	3	6M	50.4u	1.745m	1.635m	606.3m
7	1	17M	61.3u	-	-	651.3m
8	2	18M	70.0u	1.158m	-	652.9m
9	1	10M	67.9u	-	-	421.3m
10	3	17M	93.0u	1.387m	1.802m	908.0m
11	3	16M	87.6u	1.131m	1.482m	919.7m
12	2	9M	50.5u	1.891m	-	824.8m

Long Pulse Radar Test Signal						
Test Signal Name: LP_Signal_22						
Number of Bursts in Trial: 15						
Chrip Center Frequency: 5555MHz						
Burst	Pulses per Burst	Chrip (Hz)	Pulse Width (s)	Pulse 1 to 2 Spacing (s)	Pulse 2 to 3 Spacing (s)	Start Location (s)
1	2	16M	51.1u	1.194m	-	28.25m
2	3	17M	61.3u	1.668m	1.085m	213.0m
3	2	20M	91.1u	990.9u	-	191.4m
4	2	12M	96.4u	1.651m	-	34.25m
5	2	20M	56.4u	1.678m	-	585.4m
6	2	17M	97.2u	1.117m	-	99.65m
7	3	17M	86.5u	1.888m	1.621m	105.0m
8	3	17M	76.6u	1.251m	1.356m	250.1m
9	2	13M	93.2u	949.8u	-	585.4m
10	2	7M	80.5u	1.584m	-	539.3m
11	1	20M	95.3u	-	-	204.6m
12	1	11M	71.6u	-	-	305.6m
13	2	12M	95.1u	1.198m	-	374.4m
14	3	11M	50.5u	1.061m	1.307m	377.5m
15	1	16M	85.9u	-	-	209.9m

Long Pulse Radar Test Signal						
Test Signal Name: LP_Signal_23						
Number of Bursts in Trial: 10						
Chrip Center Frequency: 5558MHz						
Burst	Pulses per Burst	Chrip (Hz)	Pulse Width (s)	Pulse 1 to 2 Spacing (s)	Pulse 2 to 3 Spacing (s)	Start Location (s)
1	2	10M	76.3u	1.197m	-	246.3m
2	3	18M	82.5u	1.841m	1.747m	960.3m
3	3	5M	88.7u	1.399m	1.550m	998.2m
4	2	11M	95.2u	1.820m	-	1.189
5	1	18M	61.2u	-	-	1.111
6	1	7M	66.5u	-	-	774.2m

7	3	19M	73.4u	1.781m	1.100m	310.7m
8	2	16M	99.6u	1.743m	-	273.9m
9	1	8M	70.0u	-	-	991.2m
10	2	12M	98.1u	1.640m	-	1.021

Long Pulse Radar Test Signal						
Test Signal Name: LP_Signal_24						
Number of Bursts in Trial: 9						
Chrip Center Frequency: 5561MHz						
Burst	Pulses per Burst	Chrip (Hz)	Pulse Width (s)	Pulse 1 to 2 Spacing (s)	Pulse 2 to 3 Spacing (s)	Start Location (s)
1	3	12M	82.5u	1.154m	1.586m	423.4m
2	3	13M	58.7u	989.3u	1.035m	832.9m
3	2	19M	52.0u	1.905m	-	4.504m
4	2	11M	63.5u	1.886m	-	1.086
5	2	6M	79.6u	1.629m	-	41.52m
6	1	13M	84.9u	-	-	22.72m
7	3	7M	93.0u	1.322m	1.504m	394.0m
8	2	18M	98.3u	1.803m	-	597.4m
9	1	15M	80.3u	-	-	860.4m

Long Pulse Radar Test Signal						
Test Signal Name: LP_Signal_25						
Number of Bursts in Trial: 10						
Chrip Center Frequency: 5530MHz						
Burst	Pulses per Burst	Chrip (Hz)	Pulse Width (s)	Pulse 1 to 2 Spacing (s)	Pulse 2 to 3 Spacing (s)	Start Location (s)
1	2	11M	68.6u	1.901m	-	1.074
2	2	17M	57.0u	1.069m	-	962.1m
3	1	9M	53.6u	-	-	919.9m
4	2	17M	64.9u	1.186m	-	962.1m
5	1	7M	77.5u	-	-	978.8m
6	2	16M	77.2u	1.898m	-	1.098
7	1	14M	73.4u	-	-	744.8m
8	2	18M	58.7u	978.3u	-	951.5m

9	2	14M	70.3u	1.472m	-	362.2m
10	2	19M	71.1u	1.687m	-	805.1m

Long Pulse Radar Test Signal						
Test Signal Name: LP_Signal_26						
Number of Bursts in Trial: 15						
Chrip Center Frequency: 5533MHz						
Burst	Pulses per Burst	Chrip (Hz)	Pulse Width (s)	Pulse 1 to 2 Spacing (s)	Pulse 2 to 3 Spacing (s)	Start Location (s)
1	1	11M	66.5u	-	-	402.1m
2	1	11M	63.0u	-	-	156.7m
3	2	11M	68.5u	1.342m	-	328.1m
4	1	7M	61.7u	-	-	68.57m
5	2	13M	51.8u	1.831m	-	36.73m
6	1	10M	53.1u	-	-	123.4m
7	2	14M	77.4u	1.511m	-	561.9m
8	2	11M	51.0u	1.510m	-	80.40m
9	3	12M	80.2u	1.631m	1.817m	220.6m
10	2	7M	77.8u	1.828m	-	214.3m
11	3	17M	72.5u	1.760m	1.092m	694.6m
12	1	16M	50.7u	-	-	285.3m
13	1	14M	58.2u	-	-	654.0m
14	1	17M	96.9u	-	-	158.0m
15	2	13M	96.8u	1.814m	-	341.2m

Long Pulse Radar Test Signal						
Test Signal Name: LP_Signal_27						
Number of Bursts in Trial: 9						
Chrip Center Frequency: 5536MHz						
Burst	Pulses per Burst	Chrip (Hz)	Pulse Width (s)	Pulse 1 to 2 Spacing (s)	Pulse 2 to 3 Spacing (s)	Start Location (s)
1	2	16M	64.9u	1.838m	-	177.6m
2	1	6M	52.2u	-	-	327.5m
3	3	13M	84.6u	1.116m	1.009m	368.0u
4	3	13M	91.1u	1.052m	1.031m	438.4m

5	3	9M	79.1u	1.581m	1.074m	1.050
6	2	6M	57.4u	1.311m	-	571.5m
7	2	17M	52.1u	1.925m	-	30.44m
8	1	9M	65.7u	-	-	42.00m
9	2	9M	73.6u	1.913m	-	990.3m

Long Pulse Radar Test Signal						
Test Signal Name: LP_Signal_28						
Number of Bursts in Trial: 18						
Chrip Center Frequency: 5527MHz						
Burst	Pulses per Burst	Chrip (Hz)	Pulse Width (s)	Pulse 1 to 2 Spacing (s)	Pulse 2 to 3 Spacing (s)	Start Location (s)
1	2	9M	52.6u	1.612m	-	491.4m
2	2	11M	60.0u	1.372m	-	309.9m
3	2	16M	52.8u	1.406m	-	228.2m
4	2	13M	52.8u	1.470m	-	81.48m
5	2	15M	57.5u	1.294m	-	87.39m
6	2	13M	74.0u	1.275m	-	244.2m
7	1	7M	51.7u	-	-	466.1m
8	2	10M	84.8u	1.495m	-	591.2m
9	2	6M	56.0u	1.105m	-	5.730m
10	3	16M	68.0u	1.819m	997.0u	401.9m
11	1	12M	61.7u	-	-	612.1m
12	2	9M	83.5u	1.529m	-	464.2m
13	3	5M	62.1u	1.446m	1.708m	172.7m
14	2	8M	68.9u	1.457m	-	502.4m
15	2	7M	68.9u	1.019m	-	64.78m
16	1	10M	61.2u	-	-	501.4m
17	3	8M	91.8u	1.226m	1.668m	529.6m
18	1	7M	91.6u	-	-	486.1m

Long Pulse Radar Test Signal						
Test Signal Name: LP_Signal_29						
Number of Bursts in Trial: 12						
Chrip Center Frequency: 5524MHz						
Burst	Pulses per Burst	Chrip (Hz)	Pulse Width (s)	Pulse 1 to 2 Spacing (s)	Pulse 2 to 3 Spacing (s)	Start Location (s)
1	1	12M	93.2u	-	-	436.1m
2	2	10M	68.8u	1.329m	-	634.4m
3	1	13M	50.9u	-	-	107.6m
4	3	10M	79.2u	1.349m	1.890m	270.3m
5	1	8M	74.0u	-	-	717.1m
6	2	10M	67.4u	1.372m	-	199.5m
7	3	7M	50.8u	1.115m	1.463m	140.0m
8	3	16M	51.3u	1.934m	1.795m	737.4m
9	3	13M	90.5u	1.195m	1.201m	546.7m
10	2	15M	77.7u	1.574m	-	576.8m
11	2	7M	51.4u	1.292m	-	357.3m
12	1	13M	99.2u	-	-	72.15m

Long Pulse Radar Test Signal						
Test Signal Name: LP_Signal_30						
Number of Bursts in Trial: 9						
Chrip Center Frequency: 5530MHz						
Burst	Pulses per Burst	Chrip (Hz)	Pulse Width (s)	Pulse 1 to 2 Spacing (s)	Pulse 2 to 3 Spacing (s)	Start Location (s)
1	2	15M	86.5u	1.458m	-	651.0m
2	3	8M	59.9u	1.346m	1.360m	457.7m
3	2	9M	68.9u	1.443m	-	1.228
4	1	9M	83.3u	-	-	948.0m
5	2	10M	89.9u	1.563m	-	1.122
6	1	8M	73.1u	-	-	638.5m
7	1	13M	85.5u	-	-	1.127
8	2	11M	78.3u	1.076m	-	705.3m
9	2	9M	92.9u	1.217m	-	1.024

Type 6 Radar Statistical Performances				
Trial #	Pulses per Burst	Pulse Width (s)	PRI (s)	Detection
1	9	1.0u	333.0u	Yes
2	9	1.0u	333.0u	Yes
3	9	1.0u	333.0u	Yes
4	9	1.0u	333.0u	Yes
5	9	1.0u	333.0u	Yes
6	9	1.0u	333.0u	No
7	9	1.0u	333.0u	Yes
8	9	1.0u	333.0u	Yes
9	9	1.0u	333.0u	Yes
10	9	1.0u	333.0u	Yes
11	9	1.0u	333.0u	Yes
12	9	1.0u	333.0u	Yes
13	9	1.0u	333.0u	Yes
14	9	1.0u	333.0u	Yes
15	9	1.0u	333.0u	Yes
16	9	1.0u	333.0u	Yes
17	9	1.0u	333.0u	Yes
18	9	1.0u	333.0u	Yes
19	9	1.0u	333.0u	Yes
20	9	1.0u	333.0u	Yes
21	9	1.0u	333.0u	Yes
22	9	1.0u	333.0u	Yes
23	9	1.0u	333.0u	Yes
24	9	1.0u	333.0u	Yes
25	9	1.0u	333.0u	Yes
26	9	1.0u	333.0u	Yes
27	9	1.0u	333.0u	Yes
28	9	1.0u	333.0u	Yes
29	9	1.0u	333.0u	Yes
30	9	1.0u	333.0u	Yes
			Detection Rate: 96.7 %	

Type 6 Radar Statistical Performances		
Trial #	Hopping Frequency Sequence Name	Detection
1	HOP_FREQ_SEQ_01	Yes
2	HOP_FREQ_SEQ_02	Yes
3	HOP_FREQ_SEQ_03	Yes
4	HOP_FREQ_SEQ_04	Yes
5	HOP_FREQ_SEQ_05	Yes
6	HOP_FREQ_SEQ_06	No
7	HOP_FREQ_SEQ_07	Yes
8	HOP_FREQ_SEQ_08	Yes
9	HOP_FREQ_SEQ_09	Yes
10	HOP_FREQ_SEQ_10	Yes
11	HOP_FREQ_SEQ_11	Yes
12	HOP_FREQ_SEQ_12	Yes
13	HOP_FREQ_SEQ_13	Yes
14	HOP_FREQ_SEQ_14	Yes
15	HOP_FREQ_SEQ_15	Yes
16	HOP_FREQ_SEQ_16	Yes
17	HOP_FREQ_SEQ_17	Yes
18	HOP_FREQ_SEQ_18	Yes
19	HOP_FREQ_SEQ_19	Yes
20	HOP_FREQ_SEQ_20	Yes
21	HOP_FREQ_SEQ_21	Yes
22	HOP_FREQ_SEQ_22	Yes
23	HOP_FREQ_SEQ_23	Yes
24	HOP_FREQ_SEQ_24	Yes
25	HOP_FREQ_SEQ_25	Yes
26	HOP_FREQ_SEQ_26	Yes
27	HOP_FREQ_SEQ_27	Yes
28	HOP_FREQ_SEQ_28	Yes
29	HOP_FREQ_SEQ_29	Yes
30	HOP_FREQ_SEQ_30	Yes
		Detection Rate: 96.7 %

Hopping Frequency Sequence Name: HOP_FREQ_SEQ_01							
SEQ#	Frequency (Hz)	SEQ#	Frequency (Hz)	SEQ#	Frequency (Hz)	SEQ#	Frequency (Hz)
1	5.393G	2	5.555G	3	5.365G	4	5.531G
5	5.414G	6	5.467G	7	5.343G	8	5.349G
9	5.628G	10	5.546G	11	5.482G	12	5.640G
13	5.382G	14	5.581G	15	5.293G	16	5.381G
17	5.471G	18	5.525G	19	5.403G	20	5.637G
21	5.407G	22	5.326G	23	5.388G	24	5.544G
25	5.263G	26	5.255G	27	5.657G	28	5.511G
29	5.594G	30	5.705G	31	5.562G	32	5.579G
33	5.480G	34	5.366G	35	5.702G	36	5.370G
37	5.515G	38	5.535G	39	5.420G	40	5.457G
41	5.530G	42	5.258G	43	5.402G	44	5.659G
45	5.591G	46	5.436G	47	5.284G	48	5.621G
49	5.510G	50	5.340G	51	5.385G	52	5.548G
53	5.364G	54	5.526G	55	5.585G	56	5.529G
57	5.459G	58	5.309G	59	5.260G	60	5.636G
61	5.270G	62	5.613G	63	5.479G	64	5.684G
65	5.566G	66	5.512G	67	5.677G	68	5.587G
69	5.717G	70	5.477G	71	5.396G	72	5.339G
73	5.295G	74	5.406G	75	5.346G	76	5.341G
77	5.361G	78	5.466G	79	5.708G	80	5.401G
81	5.682G	82	5.665G	83	5.391G	84	5.715G
85	5.533G	86	5.528G	87	5.397G	88	5.670G
89	5.676G	90	5.266G	91	5.410G	92	5.567G
93	5.416G	94	5.575G	95	5.597G	96	5.322G
97	5.606G	98	5.622G	99	5.320G	100	5.712G

Hopping Frequency Sequence Name: HOP_FREQ_SEQ_02							
SEQ#	Frequency (Hz)	SEQ#	Frequency (Hz)	SEQ#	Frequency (Hz)	SEQ#	Frequency (Hz)
1	5.324G	2	5.503G	3	5.289G	4	5.384G
5	5.611G	6	5.637G	7	5.387G	8	5.604G
9	5.575G	10	5.582G	11	5.440G	12	5.595G
13	5.723G	14	5.528G	15	5.427G	16	5.623G

17	5.633G	18	5.424G	19	5.502G	20	5.661G
21	5.443G	22	5.328G	23	5.356G	24	5.366G
25	5.685G	26	5.473G	27	5.597G	28	5.455G
29	5.278G	30	5.446G	31	5.696G	32	5.319G
33	5.509G	34	5.682G	35	5.271G	36	5.252G
37	5.543G	38	5.705G	39	5.371G	40	5.415G
41	5.320G	42	5.437G	43	5.351G	44	5.710G
45	5.416G	46	5.274G	47	5.607G	48	5.265G
49	5.469G	50	5.615G	51	5.404G	52	5.635G
53	5.669G	54	5.426G	55	5.435G	56	5.527G
57	5.513G	58	5.402G	59	5.323G	60	5.365G
61	5.681G	62	5.441G	63	5.521G	64	5.545G
65	5.386G	66	5.634G	67	5.672G	68	5.507G
69	5.456G	70	5.287G	71	5.472G	72	5.307G
73	5.266G	74	5.273G	75	5.420G	76	5.548G
77	5.646G	78	5.684G	79	5.510G	80	5.538G
81	5.335G	82	5.395G	83	5.300G	84	5.698G
85	5.651G	86	5.617G	87	5.569G	88	5.355G
89	5.656G	90	5.374G	91	5.467G	92	5.491G
93	5.425G	94	5.554G	95	5.368G	96	5.631G
97	5.482G	98	5.361G	99	5.674G	100	5.390G

Hopping Frequency Sequence Name: HOP_FREQ_SEQ_03							
SEQ#	Frequency (Hz)	SEQ#	Frequency (Hz)	SEQ#	Frequency (Hz)	SEQ#	Frequency (Hz)
1	5.477G	2	5.584G	3	5.301G	4	5.387G
5	5.699G	6	5.610G	7	5.436G	8	5.701G
9	5.680G	10	5.618G	11	5.336G	12	5.445G
13	5.263G	14	5.712G	15	5.431G	16	5.578G
17	5.668G	18	5.303G	19	5.550G	20	5.539G
21	5.451G	22	5.505G	23	5.506G	24	5.693G
25	5.313G	26	5.535G	27	5.564G	28	5.476G
29	5.398G	30	5.328G	31	5.651G	32	5.339G
33	5.261G	34	5.305G	35	5.528G	36	5.290G
37	5.273G	38	5.619G	39	5.304G	40	5.466G
41	5.609G	42	5.596G	43	5.363G	44	5.705G
45	5.280G	46	5.400G	47	5.511G	48	5.714G

49	5.418G	50	5.684G	51	5.592G	52	5.595G
53	5.504G	54	5.636G	55	5.566G	56	5.268G
57	5.456G	58	5.532G	59	5.334G	60	5.358G
61	5.341G	62	5.513G	63	5.650G	64	5.364G
65	5.670G	66	5.710G	67	5.299G	68	5.297G
69	5.368G	70	5.633G	71	5.275G	72	5.420G
73	5.488G	74	5.423G	75	5.321G	76	5.585G
77	5.483G	78	5.457G	79	5.703G	80	5.497G
81	5.485G	82	5.346G	83	5.521G	84	5.464G
85	5.391G	86	5.531G	87	5.446G	88	5.473G
89	5.682G	90	5.281G	91	5.270G	92	5.658G
93	5.367G	94	5.405G	95	5.276G	96	5.673G
97	5.277G	98	5.333G	99	5.459G	100	5.601G

Hopping Frequency Sequence Name: HOP_FREQ_SEQ_04							
SEQ#	Frequency (Hz)	SEQ#	Frequency (Hz)	SEQ#	Frequency (Hz)	SEQ#	Frequency (Hz)
1	5.637G	2	5.325G	3	5.468G	4	5.598G
5	5.326G	6	5.632G	7	5.437G	8	5.676G
9	5.261G	10	5.456G	11	5.296G	12	5.276G
13	5.715G	14	5.695G	15	5.518G	16	5.298G
17	5.687G	18	5.673G	19	5.525G	20	5.609G
21	5.709G	22	5.493G	23	5.349G	24	5.506G
25	5.426G	26	5.663G	27	5.427G	28	5.625G
29	5.513G	30	5.404G	31	5.385G	32	5.323G
33	5.373G	34	5.569G	35	5.407G	36	5.594G
37	5.260G	38	5.576G	39	5.622G	40	5.716G
41	5.662G	42	5.318G	43	5.606G	44	5.702G
45	5.552G	46	5.655G	47	5.713G	48	5.512G
49	5.279G	50	5.372G	51	5.666G	52	5.494G
53	5.718G	54	5.264G	55	5.559G	56	5.689G
57	5.497G	58	5.671G	59	5.314G	60	5.429G
61	5.399G	62	5.450G	63	5.346G	64	5.299G
65	5.333G	66	5.618G	67	5.390G	68	5.696G
69	5.475G	70	5.319G	71	5.420G	72	5.320G
73	5.523G	74	5.251G	75	5.685G	76	5.527G
77	5.596G	78	5.539G	79	5.677G	80	5.341G

81	5.563G	82	5.280G	83	5.607G	84	5.587G
85	5.459G	86	5.288G	87	5.316G	88	5.548G
89	5.644G	90	5.507G	91	5.541G	92	5.545G
93	5.445G	94	5.700G	95	5.568G	96	5.363G
97	5.482G	98	5.499G	99	5.267G	100	5.650G

Hopping Frequency Sequence Name: HOP_FREQ_SEQ_05							
SEQ#	Frequency (Hz)	SEQ#	Frequency (Hz)	SEQ#	Frequency (Hz)	SEQ#	Frequency (Hz)
1	5.662G	2	5.508G	3	5.705G	4	5.479G
5	5.510G	6	5.568G	7	5.319G	8	5.554G
9	5.553G	10	5.337G	11	5.259G	12	5.299G
13	5.717G	14	5.443G	15	5.306G	16	5.493G
17	5.432G	18	5.530G	19	5.261G	20	5.716G
21	5.304G	22	5.615G	23	5.640G	24	5.536G
25	5.483G	26	5.655G	27	5.349G	28	5.278G
29	5.638G	30	5.253G	31	5.362G	32	5.320G
33	5.618G	34	5.377G	35	5.700G	36	5.613G
37	5.675G	38	5.577G	39	5.497G	40	5.369G
41	5.564G	42	5.252G	43	5.307G	44	5.609G
45	5.719G	46	5.255G	47	5.632G	48	5.566G
49	5.602G	50	5.578G	51	5.383G	52	5.572G
53	5.265G	54	5.310G	55	5.706G	56	5.340G
57	5.557G	58	5.309G	59	5.539G	60	5.317G
61	5.714G	62	5.296G	63	5.523G	64	5.399G
65	5.556G	66	5.403G	67	5.541G	68	5.324G
69	5.250G	70	5.266G	71	5.680G	72	5.560G
73	5.585G	74	5.581G	75	5.427G	76	5.308G
77	5.401G	78	5.358G	79	5.611G	80	5.656G
81	5.436G	82	5.448G	83	5.393G	84	5.573G
85	5.646G	86	5.318G	87	5.625G	88	5.600G
89	5.351G	90	5.538G	91	5.599G	92	5.626G
93	5.688G	94	5.516G	95	5.402G	96	5.381G
97	5.545G	98	5.328G	99	5.420G	100	5.654G

Hopping Frequency Sequence Name: HOP_FREQ_SEQ_06							
SEQ#	Frequency (Hz)	SEQ#	Frequency (Hz)	SEQ#	Frequency (Hz)	SEQ#	Frequency (Hz)
1	5.449G	2	5.261G	3	5.578G	4	5.680G
5	5.699G	6	5.572G	7	5.693G	8	5.619G
9	5.601G	10	5.598G	11	5.430G	12	5.540G
13	5.316G	14	5.497G	15	5.678G	16	5.353G
17	5.640G	18	5.655G	19	5.274G	20	5.347G
21	5.509G	22	5.330G	23	5.419G	24	5.462G
25	5.405G	26	5.475G	27	5.716G	28	5.673G
29	5.551G	30	5.672G	31	5.413G	32	5.599G
33	5.366G	34	5.595G	35	5.414G	36	5.660G
37	5.416G	38	5.576G	39	5.402G	40	5.460G
41	5.398G	42	5.643G	43	5.715G	44	5.550G
45	5.517G	46	5.380G	47	5.483G	48	5.372G
49	5.318G	50	5.401G	51	5.670G	52	5.270G
53	5.637G	54	5.700G	55	5.420G	56	5.711G
57	5.627G	58	5.307G	59	5.527G	60	5.295G
61	5.638G	62	5.258G	63	5.529G	64	5.698G
65	5.659G	66	5.662G	67	5.343G	68	5.722G
69	5.546G	70	5.618G	71	5.518G	72	5.324G
73	5.596G	74	5.639G	75	5.471G	76	5.440G
77	5.652G	78	5.387G	79	5.364G	80	5.254G
81	5.724G	82	5.663G	83	5.681G	84	5.260G
85	5.352G	86	5.713G	87	5.442G	88	5.501G
89	5.377G	90	5.368G	91	5.493G	92	5.624G
93	5.444G	94	5.425G	95	5.469G	96	5.649G
97	5.351G	98	5.415G	99	5.492G	100	5.675G

Hopping Frequency Sequence Name: HOP_FREQ_SEQ_07							
SEQ#	Frequency (Hz)	SEQ#	Frequency (Hz)	SEQ#	Frequency (Hz)	SEQ#	Frequency (Hz)
1	5.448G	2	5.436G	3	5.572G	4	5.263G
5	5.508G	6	5.462G	7	5.303G	8	5.392G
9	5.640G	10	5.425G	11	5.382G	12	5.697G
13	5.638G	14	5.317G	15	5.285G	16	5.370G

17	5.353G	18	5.460G	19	5.672G	20	5.686G
21	5.564G	22	5.555G	23	5.453G	24	5.266G
25	5.258G	26	5.443G	27	5.651G	28	5.702G
29	5.325G	30	5.360G	31	5.264G	32	5.692G
33	5.371G	34	5.433G	35	5.505G	36	5.414G
37	5.608G	38	5.568G	39	5.710G	40	5.459G
41	5.279G	42	5.315G	43	5.272G	44	5.410G
45	5.637G	46	5.261G	47	5.625G	48	5.714G
49	5.461G	50	5.585G	51	5.259G	52	5.471G
53	5.687G	54	5.379G	55	5.355G	56	5.282G
57	5.539G	58	5.416G	59	5.499G	60	5.395G
61	5.664G	62	5.605G	63	5.326G	64	5.506G
65	5.549G	66	5.319G	67	5.480G	68	5.404G
69	5.536G	70	5.556G	71	5.526G	72	5.680G
73	5.401G	74	5.454G	75	5.331G	76	5.610G
77	5.498G	78	5.583G	79	5.348G	80	5.271G
81	5.309G	82	5.635G	83	5.493G	84	5.466G
85	5.601G	86	5.606G	87	5.349G	88	5.304G
89	5.354G	90	5.587G	91	5.704G	92	5.618G
93	5.675G	94	5.305G	95	5.481G	96	5.336G
97	5.278G	98	5.703G	99	5.442G	100	5.723G

Hopping Frequency Sequence Name: HOP_FREQ_SEQ_08							
SEQ#	Frequency (Hz)	SEQ#	Frequency (Hz)	SEQ#	Frequency (Hz)	SEQ#	Frequency (Hz)
1	5.308G	2	5.283G	3	5.468G	4	5.266G
5	5.507G	6	5.495G	7	5.365G	8	5.604G
9	5.285G	10	5.508G	11	5.318G	12	5.471G
13	5.592G	14	5.280G	15	5.629G	16	5.703G
17	5.351G	18	5.641G	19	5.591G	20	5.663G
21	5.610G	22	5.373G	23	5.678G	24	5.532G
25	5.274G	26	5.544G	27	5.358G	28	5.594G
29	5.676G	30	5.413G	31	5.695G	32	5.584G
33	5.257G	34	5.500G	35	5.288G	36	5.305G
37	5.459G	38	5.630G	39	5.622G	40	5.359G
41	5.621G	42	5.448G	43	5.470G	44	5.295G
45	5.480G	46	5.706G	47	5.397G	48	5.719G

49	5.431G	50	5.253G	51	5.411G	52	5.255G
53	5.590G	54	5.296G	55	5.575G	56	5.595G
57	5.686G	58	5.314G	59	5.424G	60	5.492G
61	5.338G	62	5.510G	63	5.620G	64	5.588G
65	5.264G	66	5.633G	67	5.444G	68	5.712G
69	5.315G	70	5.432G	71	5.600G	72	5.301G
73	5.702G	74	5.556G	75	5.525G	76	5.477G
77	5.412G	78	5.407G	79	5.668G	80	5.309G
81	5.398G	82	5.422G	83	5.404G	84	5.557G
85	5.392G	86	5.615G	87	5.534G	88	5.469G
89	5.409G	90	5.360G	91	5.713G	92	5.474G
93	5.423G	94	5.649G	95	5.504G	96	5.585G
97	5.560G	98	5.278G	99	5.325G	100	5.709G

Hopping Frequency Sequence Name: HOP_FREQ_SEQ_09							
SEQ#	Frequency (Hz)	SEQ#	Frequency (Hz)	SEQ#	Frequency (Hz)	SEQ#	Frequency (Hz)
1	5.628G	2	5.481G	3	5.583G	4	5.647G
5	5.516G	6	5.369G	7	5.312G	8	5.507G
9	5.580G	10	5.509G	11	5.702G	12	5.530G
13	5.423G	14	5.377G	15	5.285G	16	5.543G
17	5.602G	18	5.420G	19	5.595G	20	5.589G
21	5.591G	22	5.319G	23	5.430G	24	5.464G
25	5.600G	26	5.522G	27	5.472G	28	5.344G
29	5.553G	30	5.450G	31	5.634G	32	5.700G
33	5.511G	34	5.719G	35	5.635G	36	5.457G
37	5.680G	38	5.331G	39	5.360G	40	5.587G
41	5.462G	42	5.281G	43	5.411G	44	5.564G
45	5.480G	46	5.712G	47	5.631G	48	5.534G
49	5.609G	50	5.399G	51	5.330G	52	5.620G
53	5.623G	54	5.313G	55	5.389G	56	5.437G
57	5.271G	58	5.471G	59	5.488G	60	5.639G
61	5.718G	62	5.339G	63	5.451G	64	5.407G
65	5.556G	66	5.370G	67	5.657G	68	5.277G
69	5.710G	70	5.352G	71	5.317G	72	5.425G
73	5.287G	74	5.468G	75	5.267G	76	5.409G
77	5.696G	78	5.554G	79	5.253G	80	5.671G

81	5.365G	82	5.263G	83	5.574G	84	5.624G
85	5.309G	86	5.491G	87	5.284G	88	5.563G
89	5.678G	90	5.477G	91	5.643G	92	5.492G
93	5.345G	94	5.519G	95	5.685G	96	5.637G
97	5.592G	98	5.367G	99	5.715G	100	5.638G

Hopping Frequency Sequence Name: HOP_FREQ_SEQ_10							
SEQ#	Frequency (Hz)	SEQ#	Frequency (Hz)	SEQ#	Frequency (Hz)	SEQ#	Frequency (Hz)
1	5.651G	2	5.542G	3	5.607G	4	5.713G
5	5.487G	6	5.560G	7	5.634G	8	5.509G
9	5.563G	10	5.510G	11	5.482G	12	5.536G
13	5.677G	14	5.433G	15	5.519G	16	5.432G
17	5.637G	18	5.497G	19	5.685G	20	5.575G
21	5.686G	22	5.632G	23	5.466G	24	5.594G
25	5.620G	26	5.624G	27	5.349G	28	5.401G
29	5.381G	30	5.559G	31	5.373G	32	5.454G
33	5.355G	34	5.275G	35	5.448G	36	5.389G
37	5.710G	38	5.321G	39	5.602G	40	5.576G
41	5.270G	42	5.262G	43	5.699G	44	5.581G
45	5.273G	46	5.453G	47	5.494G	48	5.449G
49	5.511G	50	5.475G	51	5.610G	52	5.527G
53	5.328G	54	5.645G	55	5.720G	56	5.425G
57	5.647G	58	5.261G	59	5.656G	60	5.398G
61	5.438G	62	5.721G	63	5.665G	64	5.455G
65	5.378G	66	5.589G	67	5.606G	68	5.317G
69	5.388G	70	5.353G	71	5.456G	72	5.630G
73	5.605G	74	5.698G	75	5.711G	76	5.679G
77	5.302G	78	5.385G	79	5.314G	80	5.675G
81	5.580G	82	5.520G	83	5.538G	84	5.535G
85	5.366G	86	5.613G	87	5.431G	88	5.676G
89	5.338G	90	5.659G	91	5.681G	92	5.709G
93	5.274G	94	5.693G	95	5.579G	96	5.319G
97	5.316G	98	5.444G	99	5.329G	100	5.558G

Hopping Frequency Sequence Name: HOP_FREQ_SEQ_11							
SEQ#	Frequency (Hz)	SEQ#	Frequency (Hz)	SEQ#	Frequency (Hz)	SEQ#	Frequency (Hz)
1	5.520G	2	5.604G	3	5.602G	4	5.295G
5	5.567G	6	5.425G	7	5.498G	8	5.328G
9	5.712G	10	5.486G	11	5.369G	12	5.333G
13	5.481G	14	5.477G	15	5.284G	16	5.331G
17	5.268G	18	5.610G	19	5.434G	20	5.263G
21	5.580G	22	5.630G	23	5.616G	24	5.708G
25	5.464G	26	5.553G	27	5.535G	28	5.555G
29	5.643G	30	5.335G	31	5.398G	32	5.334G
33	5.468G	34	5.283G	35	5.606G	36	5.605G
37	5.669G	38	5.287G	39	5.341G	40	5.305G
41	5.674G	42	5.677G	43	5.299G	44	5.312G
45	5.680G	46	5.347G	47	5.594G	48	5.649G
49	5.497G	50	5.442G	51	5.479G	52	5.429G
53	5.597G	54	5.304G	55	5.291G	56	5.373G
57	5.321G	58	5.370G	59	5.463G	60	5.572G
61	5.350G	62	5.713G	63	5.539G	64	5.663G
65	5.635G	66	5.661G	67	5.702G	68	5.664G
69	5.430G	70	5.359G	71	5.285G	72	5.621G
73	5.316G	74	5.377G	75	5.358G	76	5.456G
77	5.656G	78	5.542G	79	5.710G	80	5.293G
81	5.416G	82	5.394G	83	5.551G	84	5.294G
85	5.566G	86	5.450G	87	5.279G	88	5.381G
89	5.485G	90	5.255G	91	5.611G	92	5.447G
93	5.432G	94	5.271G	95	5.403G	96	5.476G
97	5.537G	98	5.276G	99	5.688G	100	5.665G

Hopping Frequency Sequence Name: HOP_FREQ_SEQ_12							
SEQ#	Frequency (Hz)	SEQ#	Frequency (Hz)	SEQ#	Frequency (Hz)	SEQ#	Frequency (Hz)
1	5.384G	2	5.529G	3	5.452G	4	5.458G
5	5.480G	6	5.664G	7	5.275G	8	5.400G
9	5.290G	10	5.494G	11	5.440G	12	5.324G
13	5.277G	14	5.558G	15	5.315G	16	5.438G

17	5.381G	18	5.411G	19	5.622G	20	5.602G
21	5.302G	22	5.596G	23	5.641G	24	5.327G
25	5.391G	26	5.471G	27	5.361G	28	5.716G
29	5.303G	30	5.453G	31	5.306G	32	5.338G
33	5.636G	34	5.513G	35	5.643G	36	5.294G
37	5.589G	38	5.659G	39	5.485G	40	5.593G
41	5.539G	42	5.487G	43	5.319G	44	5.661G
45	5.584G	46	5.371G	47	5.419G	48	5.316G
49	5.491G	50	5.445G	51	5.645G	52	5.251G
53	5.279G	54	5.597G	55	5.618G	56	5.341G
57	5.328G	58	5.336G	59	5.686G	60	5.546G
61	5.652G	62	5.289G	63	5.669G	64	5.500G
65	5.269G	66	5.299G	67	5.581G	68	5.441G
69	5.454G	70	5.396G	71	5.543G	72	5.695G
73	5.350G	74	5.477G	75	5.395G	76	5.538G
77	5.631G	78	5.700G	79	5.547G	80	5.357G
81	5.647G	82	5.387G	83	5.675G	84	5.376G
85	5.495G	86	5.293G	87	5.369G	88	5.427G
89	5.474G	90	5.259G	91	5.696G	92	5.380G
93	5.577G	94	5.372G	95	5.330G	96	5.505G
97	5.291G	98	5.478G	99	5.642G	100	5.576G

Hopping Frequency Sequence Name: HOP_FREQ_SEQ_13							
SEQ#	Frequency (Hz)	SEQ#	Frequency (Hz)	SEQ#	Frequency (Hz)	SEQ#	Frequency (Hz)
1	5.698G	2	5.478G	3	5.598G	4	5.380G
5	5.302G	6	5.678G	7	5.496G	8	5.664G
9	5.351G	10	5.278G	11	5.482G	12	5.626G
13	5.627G	14	5.466G	15	5.717G	16	5.684G
17	5.414G	18	5.303G	19	5.643G	20	5.498G
21	5.384G	22	5.283G	23	5.307G	24	5.590G
25	5.421G	26	5.488G	27	5.454G	28	5.712G
29	5.607G	30	5.495G	31	5.395G	32	5.425G
33	5.600G	34	5.422G	35	5.721G	36	5.551G
37	5.387G	38	5.538G	39	5.603G	40	5.338G
41	5.706G	42	5.400G	43	5.624G	44	5.442G
45	5.693G	46	5.435G	47	5.559G	48	5.267G

49	5.491G	50	5.416G	51	5.720G	52	5.574G
53	5.708G	54	5.587G	55	5.656G	56	5.348G
57	5.558G	58	5.529G	59	5.695G	60	5.500G
61	5.285G	62	5.271G	63	5.374G	64	5.575G
65	5.683G	66	5.629G	67	5.415G	68	5.615G
69	5.612G	70	5.502G	71	5.701G	72	5.670G
73	5.381G	74	5.652G	75	5.611G	76	5.632G
77	5.679G	78	5.459G	79	5.263G	80	5.682G
81	5.424G	82	5.550G	83	5.517G	84	5.323G
85	5.579G	86	5.620G	87	5.318G	88	5.592G
89	5.480G	90	5.507G	91	5.335G	92	5.503G
93	5.360G	94	5.357G	95	5.658G	96	5.660G
97	5.311G	98	5.286G	99	5.567G	100	5.260G

Hopping Frequency Sequence Name: HOP_FREQ_SEQ_14							
SEQ#	Frequency (Hz)	SEQ#	Frequency (Hz)	SEQ#	Frequency (Hz)	SEQ#	Frequency (Hz)
1	5.694G	2	5.279G	3	5.273G	4	5.264G
5	5.696G	6	5.394G	7	5.640G	8	5.577G
9	5.476G	10	5.634G	11	5.629G	12	5.617G
13	5.482G	14	5.605G	15	5.374G	16	5.688G
17	5.453G	18	5.559G	19	5.498G	20	5.503G
21	5.675G	22	5.283G	23	5.347G	24	5.313G
25	5.315G	26	5.697G	27	5.396G	28	5.328G
29	5.349G	30	5.468G	31	5.690G	32	5.595G
33	5.333G	34	5.422G	35	5.455G	36	5.702G
37	5.644G	38	5.671G	39	5.484G	40	5.686G
41	5.632G	42	5.719G	43	5.311G	44	5.253G
45	5.458G	46	5.462G	47	5.316G	48	5.590G
49	5.323G	50	5.539G	51	5.256G	52	5.423G
53	5.467G	54	5.584G	55	5.309G	56	5.428G
57	5.359G	58	5.586G	59	5.358G	60	5.680G
61	5.436G	62	5.611G	63	5.668G	64	5.592G
65	5.569G	66	5.576G	67	5.379G	68	5.566G
69	5.626G	70	5.301G	71	5.534G	72	5.581G
73	5.260G	74	5.512G	75	5.656G	76	5.693G
77	5.717G	78	5.261G	79	5.676G	80	5.454G

81	5.344G	82	5.343G	83	5.529G	84	5.679G
85	5.440G	86	5.317G	87	5.445G	88	5.425G
89	5.406G	90	5.294G	91	5.575G	92	5.658G
93	5.326G	94	5.446G	95	5.386G	96	5.607G
97	5.312G	98	5.289G	99	5.662G	100	5.390G

Hopping Frequency Sequence Name: HOP_FREQ_SEQ_15							
SEQ#	Frequency (Hz)	SEQ#	Frequency (Hz)	SEQ#	Frequency (Hz)	SEQ#	Frequency (Hz)
1	5.404G	2	5.510G	3	5.331G	4	5.666G
5	5.480G	6	5.260G	7	5.614G	8	5.720G
9	5.513G	10	5.379G	11	5.318G	12	5.596G
13	5.297G	14	5.324G	15	5.467G	16	5.410G
17	5.558G	18	5.670G	19	5.465G	20	5.485G
21	5.555G	22	5.470G	23	5.341G	24	5.266G
25	5.499G	26	5.713G	27	5.512G	28	5.372G
29	5.368G	30	5.457G	31	5.692G	32	5.378G
33	5.684G	34	5.658G	35	5.647G	36	5.585G
37	5.532G	38	5.592G	39	5.488G	40	5.560G
41	5.688G	42	5.721G	43	5.327G	44	5.478G
45	5.699G	46	5.714G	47	5.544G	48	5.622G
49	5.346G	50	5.250G	51	5.381G	52	5.282G
53	5.335G	54	5.420G	55	5.673G	56	5.686G
57	5.263G	58	5.304G	59	5.548G	60	5.252G
61	5.689G	62	5.395G	63	5.409G	64	5.521G
65	5.481G	66	5.575G	67	5.441G	68	5.389G
69	5.376G	70	5.258G	71	5.610G	72	5.645G
73	5.296G	74	5.529G	75	5.320G	76	5.533G
77	5.476G	78	5.497G	79	5.447G	80	5.255G
81	5.632G	82	5.685G	83	5.299G	84	5.284G
85	5.275G	86	5.398G	87	5.542G	88	5.411G
89	5.574G	90	5.553G	91	5.332G	92	5.524G
93	5.576G	94	5.506G	95	5.310G	96	5.635G
97	5.691G	98	5.716G	99	5.615G	100	5.613G

Hopping Frequency Sequence Name: HOP_FREQ_SEQ_16							
SEQ#	Frequency (Hz)	SEQ#	Frequency (Hz)	SEQ#	Frequency (Hz)	SEQ#	Frequency (Hz)
1	5.610G	2	5.359G	3	5.657G	4	5.616G
5	5.692G	6	5.425G	7	5.488G	8	5.708G
9	5.714G	10	5.464G	11	5.305G	12	5.549G
13	5.264G	14	5.405G	15	5.327G	16	5.572G
17	5.699G	18	5.254G	19	5.288G	20	5.499G
21	5.311G	22	5.664G	23	5.619G	24	5.358G
25	5.295G	26	5.267G	27	5.703G	28	5.477G
29	5.585G	30	5.303G	31	5.360G	32	5.517G
33	5.723G	34	5.522G	35	5.298G	36	5.313G
37	5.563G	38	5.621G	39	5.496G	40	5.687G
41	5.586G	42	5.651G	43	5.552G	44	5.250G
45	5.325G	46	5.635G	47	5.286G	48	5.686G
49	5.506G	50	5.605G	51	5.291G	52	5.306G
53	5.535G	54	5.457G	55	5.312G	56	5.627G
57	5.334G	58	5.382G	59	5.316G	60	5.318G
61	5.661G	62	5.547G	63	5.704G	64	5.702G
65	5.456G	66	5.510G	67	5.320G	68	5.370G
69	5.644G	70	5.548G	71	5.497G	72	5.502G
73	5.452G	74	5.709G	75	5.417G	76	5.406G
77	5.401G	78	5.588G	79	5.534G	80	5.622G
81	5.665G	82	5.566G	83	5.478G	84	5.513G
85	5.463G	86	5.710G	87	5.270G	88	5.594G
89	5.626G	90	5.527G	91	5.409G	92	5.330G
93	5.299G	94	5.413G	95	5.574G	96	5.712G
97	5.567G	98	5.446G	99	5.545G	100	5.263G

Hopping Frequency Sequence Name: HOP_FREQ_SEQ_17							
SEQ#	Frequency (Hz)	SEQ#	Frequency (Hz)	SEQ#	Frequency (Hz)	SEQ#	Frequency (Hz)
1	5.385G	2	5.389G	3	5.678G	4	5.324G
5	5.452G	6	5.634G	7	5.351G	8	5.419G
9	5.511G	10	5.534G	11	5.661G	12	5.252G
13	5.637G	14	5.308G	15	5.469G	16	5.258G

17	5.530G	18	5.533G	19	5.345G	20	5.285G
21	5.702G	22	5.305G	23	5.312G	24	5.528G
25	5.488G	26	5.497G	27	5.684G	28	5.685G
29	5.598G	30	5.662G	31	5.421G	32	5.608G
33	5.516G	34	5.444G	35	5.397G	36	5.339G
37	5.621G	38	5.649G	39	5.526G	40	5.589G
41	5.479G	42	5.459G	43	5.261G	44	5.399G
45	5.372G	46	5.441G	47	5.253G	48	5.433G
49	5.424G	50	5.666G	51	5.381G	52	5.429G
53	5.294G	54	5.465G	55	5.504G	56	5.710G
57	5.568G	58	5.331G	59	5.711G	60	5.494G
61	5.716G	62	5.319G	63	5.505G	64	5.485G
65	5.267G	66	5.336G	67	5.383G	68	5.275G
69	5.518G	70	5.354G	71	5.343G	72	5.427G
73	5.264G	74	5.715G	75	5.510G	76	5.297G
77	5.611G	78	5.292G	79	5.581G	80	5.375G
81	5.446G	82	5.302G	83	5.371G	84	5.636G
85	5.288G	86	5.320G	87	5.557G	88	5.373G
89	5.386G	90	5.327G	91	5.357G	92	5.480G
93	5.654G	94	5.693G	95	5.541G	96	5.695G
97	5.387G	98	5.350G	99	5.304G	100	5.272G

Hopping Frequency Sequence Name: HOP_FREQ_SEQ_18							
SEQ#	Frequency (Hz)	SEQ#	Frequency (Hz)	SEQ#	Frequency (Hz)	SEQ#	Frequency (Hz)
1	5.527G	2	5.719G	3	5.285G	4	5.696G
5	5.718G	6	5.671G	7	5.500G	8	5.252G
9	5.657G	10	5.629G	11	5.585G	12	5.564G
13	5.307G	14	5.542G	15	5.340G	16	5.258G
17	5.642G	18	5.360G	19	5.440G	20	5.383G
21	5.386G	22	5.634G	23	5.268G	24	5.720G
25	5.316G	26	5.313G	27	5.406G	28	5.471G
29	5.624G	30	5.558G	31	5.327G	32	5.475G
33	5.400G	34	5.614G	35	5.654G	36	5.370G
37	5.469G	38	5.618G	39	5.264G	40	5.496G
41	5.514G	42	5.670G	43	5.648G	44	5.701G
45	5.510G	46	5.461G	47	5.541G	48	5.250G

49	5.610G	50	5.594G	51	5.646G	52	5.336G
53	5.325G	54	5.389G	55	5.562G	56	5.358G
57	5.442G	58	5.596G	59	5.257G	60	5.398G
61	5.572G	62	5.506G	63	5.688G	64	5.708G
65	5.371G	66	5.548G	67	5.554G	68	5.530G
69	5.498G	70	5.663G	71	5.342G	72	5.365G
73	5.586G	74	5.414G	75	5.716G	76	5.627G
77	5.446G	78	5.343G	79	5.305G	80	5.628G
81	5.632G	82	5.668G	83	5.647G	84	5.532G
85	5.267G	86	5.409G	87	5.326G	88	5.704G
89	5.540G	90	5.455G	91	5.390G	92	5.494G
93	5.565G	94	5.411G	95	5.723G	96	5.538G
97	5.529G	98	5.296G	99	5.256G	100	5.280G

Hopping Frequency Sequence Name: HOP_FREQ_SEQ_19							
SEQ#	Frequency (Hz)	SEQ#	Frequency (Hz)	SEQ#	Frequency (Hz)	SEQ#	Frequency (Hz)
1	5.334G	2	5.291G	3	5.586G	4	5.609G
5	5.438G	6	5.301G	7	5.422G	8	5.383G
9	5.256G	10	5.713G	11	5.643G	12	5.460G
13	5.555G	14	5.593G	15	5.700G	16	5.480G
17	5.251G	18	5.707G	19	5.326G	20	5.611G
21	5.353G	22	5.335G	23	5.694G	24	5.537G
25	5.458G	26	5.687G	27	5.346G	28	5.338G
29	5.414G	30	5.702G	31	5.430G	32	5.386G
33	5.486G	34	5.587G	35	5.333G	36	5.724G
37	5.285G	38	5.436G	39	5.396G	40	5.542G
41	5.433G	42	5.306G	43	5.704G	44	5.380G
45	5.384G	46	5.255G	47	5.496G	48	5.340G
49	5.605G	50	5.473G	51	5.416G	52	5.466G
53	5.610G	54	5.716G	55	5.527G	56	5.504G
57	5.685G	58	5.357G	59	5.370G	60	5.365G
61	5.699G	62	5.439G	63	5.567G	64	5.483G
65	5.269G	66	5.261G	67	5.404G	68	5.634G
69	5.389G	70	5.655G	71	5.459G	72	5.413G
73	5.391G	74	5.690G	75	5.632G	76	5.645G
77	5.465G	78	5.250G	79	5.666G	80	5.392G

81	5.472G	82	5.701G	83	5.319G	84	5.415G
85	5.451G	86	5.705G	87	5.288G	88	5.670G
89	5.583G	90	5.714G	91	5.622G	92	5.423G
93	5.624G	94	5.500G	95	5.358G	96	5.710G
97	5.703G	98	5.298G	99	5.420G	100	5.267G

Hopping Frequency Sequence Name: HOP_FREQ_SEQ_20							
SEQ#	Frequency (Hz)	SEQ#	Frequency (Hz)	SEQ#	Frequency (Hz)	SEQ#	Frequency (Hz)
1	5.551G	2	5.321G	3	5.512G	4	5.476G
5	5.699G	6	5.425G	7	5.454G	8	5.358G
9	5.414G	10	5.697G	11	5.364G	12	5.267G
13	5.517G	14	5.305G	15	5.285G	16	5.492G
17	5.262G	18	5.363G	19	5.276G	20	5.537G
21	5.621G	22	5.549G	23	5.301G	24	5.428G
25	5.399G	26	5.485G	27	5.594G	28	5.643G
29	5.595G	30	5.434G	31	5.641G	32	5.313G
33	5.642G	34	5.664G	35	5.620G	36	5.268G
37	5.590G	38	5.426G	39	5.710G	40	5.259G
41	5.718G	42	5.474G	43	5.404G	44	5.593G
45	5.402G	46	5.495G	47	5.447G	48	5.644G
49	5.660G	50	5.683G	51	5.527G	52	5.572G
53	5.688G	54	5.449G	55	5.713G	56	5.279G
57	5.553G	58	5.493G	59	5.635G	60	5.578G
61	5.403G	62	5.336G	63	5.256G	64	5.374G
65	5.368G	66	5.326G	67	5.466G	68	5.451G
69	5.265G	70	5.366G	71	5.344G	72	5.513G
73	5.639G	74	5.340G	75	5.299G	76	5.694G
77	5.353G	78	5.564G	79	5.270G	80	5.281G
81	5.562G	82	5.544G	83	5.510G	84	5.338G
85	5.254G	86	5.263G	87	5.347G	88	5.622G
89	5.717G	90	5.329G	91	5.677G	92	5.487G
93	5.533G	94	5.682G	95	5.705G	96	5.518G
97	5.277G	98	5.667G	99	5.464G	100	5.441G

Hopping Frequency Sequence Name: HOP_FREQ_SEQ_21							
SEQ#	Frequency (Hz)	SEQ#	Frequency (Hz)	SEQ#	Frequency (Hz)	SEQ#	Frequency (Hz)
1	5.358G	2	5.484G	3	5.337G	4	5.633G
5	5.692G	6	5.279G	7	5.520G	8	5.340G
9	5.611G	10	5.466G	11	5.599G	12	5.277G
13	5.610G	14	5.671G	15	5.675G	16	5.577G
17	5.608G	18	5.430G	19	5.626G	20	5.573G
21	5.387G	22	5.617G	23	5.282G	24	5.609G
25	5.698G	26	5.656G	27	5.384G	28	5.440G
29	5.558G	30	5.590G	31	5.352G	32	5.392G
33	5.582G	34	5.429G	35	5.515G	36	5.472G
37	5.388G	38	5.681G	39	5.424G	40	5.426G
41	5.674G	42	5.443G	43	5.719G	44	5.620G
45	5.299G	46	5.616G	47	5.569G	48	5.287G
49	5.265G	50	5.554G	51	5.664G	52	5.601G
53	5.482G	54	5.398G	55	5.365G	56	5.642G
57	5.714G	58	5.696G	59	5.446G	60	5.294G
61	5.444G	62	5.542G	63	5.397G	64	5.721G
65	5.560G	66	5.414G	67	5.701G	68	5.514G
69	5.268G	70	5.636G	71	5.689G	72	5.557G
73	5.510G	74	5.594G	75	5.604G	76	5.564G
77	5.257G	78	5.381G	79	5.587G	80	5.369G
81	5.668G	82	5.415G	83	5.703G	84	5.383G
85	5.585G	86	5.433G	87	5.417G	88	5.347G
89	5.368G	90	5.308G	91	5.521G	92	5.354G
93	5.531G	94	5.290G	95	5.360G	96	5.565G
97	5.649G	98	5.391G	99	5.305G	100	5.319G

Hopping Frequency Sequence Name: HOP_FREQ_SEQ_22							
SEQ#	Frequency (Hz)	SEQ#	Frequency (Hz)	SEQ#	Frequency (Hz)	SEQ#	Frequency (Hz)
1	5.667G	2	5.543G	3	5.530G	4	5.595G
5	5.624G	6	5.437G	7	5.628G	8	5.533G
9	5.538G	10	5.425G	11	5.499G	12	5.623G
13	5.669G	14	5.268G	15	5.366G	16	5.355G

17	5.369G	18	5.553G	19	5.251G	20	5.400G
21	5.719G	22	5.347G	23	5.592G	24	5.383G
25	5.710G	26	5.398G	27	5.404G	28	5.706G
29	5.320G	30	5.278G	31	5.641G	32	5.513G
33	5.326G	34	5.537G	35	5.397G	36	5.700G
37	5.566G	38	5.306G	39	5.406G	40	5.309G
41	5.361G	42	5.455G	43	5.510G	44	5.378G
45	5.314G	46	5.465G	47	5.301G	48	5.454G
49	5.632G	50	5.402G	51	5.637G	52	5.373G
53	5.250G	54	5.578G	55	5.360G	56	5.391G
57	5.682G	58	5.650G	59	5.433G	60	5.444G
61	5.427G	62	5.639G	63	5.352G	64	5.479G
65	5.580G	66	5.671G	67	5.388G	68	5.313G
69	5.396G	70	5.713G	71	5.354G	72	5.634G
73	5.405G	74	5.293G	75	5.561G	76	5.422G
77	5.462G	78	5.385G	79	5.364G	80	5.317G
81	5.616G	82	5.686G	83	5.542G	84	5.416G
85	5.333G	86	5.631G	87	5.331G	88	5.606G
89	5.492G	90	5.393G	91	5.575G	92	5.610G
93	5.619G	94	5.335G	95	5.415G	96	5.692G
97	5.544G	98	5.327G	99	5.617G	100	5.648G

Hopping Frequency Sequence Name: HOP_FREQ_SEQ_23							
SEQ#	Frequency (Hz)	SEQ#	Frequency (Hz)	SEQ#	Frequency (Hz)	SEQ#	Frequency (Hz)
1	5.412G	2	5.407G	3	5.435G	4	5.418G
5	5.409G	6	5.553G	7	5.611G	8	5.478G
9	5.559G	10	5.301G	11	5.402G	12	5.382G
13	5.508G	14	5.706G	15	5.422G	16	5.315G
17	5.655G	18	5.377G	19	5.709G	20	5.677G
21	5.493G	22	5.313G	23	5.446G	24	5.343G
25	5.285G	26	5.275G	27	5.703G	28	5.321G
29	5.597G	30	5.466G	31	5.555G	32	5.349G
33	5.464G	34	5.479G	35	5.659G	36	5.252G
37	5.558G	38	5.347G	39	5.512G	40	5.398G
41	5.338G	42	5.648G	43	5.345G	44	5.271G
45	5.681G	46	5.284G	47	5.615G	48	5.673G

49	5.326G	50	5.461G	51	5.426G	52	5.594G
53	5.309G	54	5.319G	55	5.403G	56	5.462G
57	5.380G	58	5.324G	59	5.290G	60	5.267G
61	5.441G	62	5.608G	63	5.576G	64	5.717G
65	5.484G	66	5.511G	67	5.640G	68	5.375G
69	5.451G	70	5.342G	71	5.722G	72	5.266G
73	5.362G	74	5.666G	75	5.724G	76	5.283G
77	5.623G	78	5.662G	79	5.416G	80	5.575G
81	5.372G	82	5.354G	83	5.357G	84	5.391G
85	5.713G	86	5.317G	87	5.381G	88	5.428G
89	5.376G	90	5.568G	91	5.369G	92	5.439G
93	5.639G	94	5.487G	95	5.396G	96	5.689G
97	5.642G	98	5.366G	99	5.482G	100	5.638G

Hopping Frequency Sequence Name: HOP_FREQ_SEQ_24							
SEQ#	Frequency (Hz)	SEQ#	Frequency (Hz)	SEQ#	Frequency (Hz)	SEQ#	Frequency (Hz)
1	5.344G	2	5.355G	3	5.506G	4	5.486G
5	5.372G	6	5.357G	7	5.628G	8	5.305G
9	5.537G	10	5.350G	11	5.498G	12	5.277G
13	5.719G	14	5.462G	15	5.609G	16	5.463G
17	5.366G	18	5.673G	19	5.512G	20	5.407G
21	5.427G	22	5.282G	23	5.360G	24	5.301G
25	5.347G	26	5.578G	27	5.265G	28	5.293G
29	5.518G	30	5.499G	31	5.291G	32	5.513G
33	5.722G	34	5.685G	35	5.326G	36	5.393G
37	5.354G	38	5.388G	39	5.493G	40	5.292G
41	5.701G	42	5.507G	43	5.371G	44	5.586G
45	5.605G	46	5.621G	47	5.313G	48	5.336G
49	5.510G	50	5.476G	51	5.315G	52	5.556G
53	5.322G	54	5.713G	55	5.629G	56	5.593G
57	5.711G	58	5.643G	59	5.443G	60	5.258G
61	5.375G	62	5.359G	63	5.458G	64	5.594G
65	5.302G	66	5.721G	67	5.312G	68	5.430G
69	5.269G	70	5.267G	71	5.496G	72	5.617G
73	5.555G	74	5.418G	75	5.352G	76	5.399G
77	5.520G	78	5.343G	79	5.530G	80	5.681G

81	5.289G	82	5.616G	83	5.646G	84	5.690G
85	5.665G	86	5.649G	87	5.428G	88	5.479G
89	5.565G	90	5.582G	91	5.329G	92	5.638G
93	5.259G	94	5.272G	95	5.509G	96	5.387G
97	5.672G	98	5.704G	99	5.705G	100	5.494G

Hopping Frequency Sequence Name: HOP_FREQ_SEQ_25							
SEQ#	Frequency (Hz)	SEQ#	Frequency (Hz)	SEQ#	Frequency (Hz)	SEQ#	Frequency (Hz)
1	5.474G	2	5.343G	3	5.526G	4	5.618G
5	5.558G	6	5.445G	7	5.376G	8	5.315G
9	5.617G	10	5.475G	11	5.659G	12	5.585G
13	5.724G	14	5.611G	15	5.350G	16	5.284G
17	5.299G	18	5.510G	19	5.584G	20	5.681G
21	5.599G	22	5.381G	23	5.297G	24	5.463G
25	5.436G	26	5.703G	27	5.389G	28	5.509G
29	5.506G	30	5.421G	31	5.572G	32	5.615G
33	5.289G	34	5.405G	35	5.656G	36	5.689G
37	5.688G	38	5.386G	39	5.697G	40	5.529G
41	5.269G	42	5.591G	43	5.254G	44	5.579G
45	5.710G	46	5.484G	47	5.511G	48	5.629G
49	5.325G	50	5.338G	51	5.367G	52	5.632G
53	5.649G	54	5.513G	55	5.355G	56	5.583G
57	5.434G	58	5.722G	59	5.313G	60	5.624G
61	5.371G	62	5.458G	63	5.586G	64	5.532G
65	5.485G	66	5.607G	67	5.667G	68	5.479G
69	5.517G	70	5.520G	71	5.354G	72	5.723G
73	5.466G	74	5.518G	75	5.403G	76	5.564G
77	5.633G	78	5.342G	79	5.307G	80	5.271G
81	5.335G	82	5.539G	83	5.275G	84	5.660G
85	5.653G	86	5.544G	87	5.394G	88	5.423G
89	5.634G	90	5.664G	91	5.550G	92	5.620G
93	5.272G	94	5.671G	95	5.375G	96	5.597G
97	5.560G	98	5.396G	99	5.361G	100	5.470G

Hopping Frequency Sequence Name: HOP_FREQ_SEQ_26							
SEQ#	Frequency (Hz)	SEQ#	Frequency (Hz)	SEQ#	Frequency (Hz)	SEQ#	Frequency (Hz)
1	5.617G	2	5.547G	3	5.303G	4	5.521G
5	5.532G	6	5.454G	7	5.354G	8	5.268G
9	5.362G	10	5.336G	11	5.372G	12	5.285G
13	5.623G	14	5.597G	15	5.549G	16	5.677G
17	5.537G	18	5.666G	19	5.492G	20	5.659G
21	5.346G	22	5.267G	23	5.723G	24	5.564G
25	5.427G	26	5.543G	27	5.310G	28	5.673G
29	5.656G	30	5.582G	31	5.468G	32	5.288G
33	5.413G	34	5.465G	35	5.457G	36	5.724G
37	5.429G	38	5.337G	39	5.640G	40	5.322G
41	5.334G	42	5.687G	43	5.435G	44	5.282G
45	5.297G	46	5.550G	47	5.283G	48	5.348G
49	5.657G	50	5.387G	51	5.631G	52	5.486G
53	5.390G	54	5.678G	55	5.587G	56	5.351G
57	5.517G	58	5.583G	59	5.696G	60	5.287G
61	5.407G	62	5.608G	63	5.671G	64	5.445G
65	5.271G	66	5.394G	67	5.485G	68	5.446G
69	5.279G	70	5.621G	71	5.341G	72	5.514G
73	5.318G	74	5.408G	75	5.437G	76	5.456G
77	5.643G	78	5.693G	79	5.681G	80	5.257G
81	5.401G	82	5.393G	83	5.614G	84	5.533G
85	5.699G	86	5.620G	87	5.350G	88	5.720G
89	5.368G	90	5.609G	91	5.598G	92	5.538G
93	5.505G	94	5.498G	95	5.719G	96	5.516G
97	5.684G	98	5.645G	99	5.460G	100	5.309G

Hopping Frequency Sequence Name: HOP_FREQ_SEQ_27							
SEQ#	Frequency (Hz)	SEQ#	Frequency (Hz)	SEQ#	Frequency (Hz)	SEQ#	Frequency (Hz)
1	5.252G	2	5.411G	3	5.333G	4	5.656G
5	5.593G	6	5.524G	7	5.257G	8	5.270G
9	5.380G	10	5.532G	11	5.376G	12	5.429G
13	5.278G	14	5.374G	15	5.453G	16	5.716G

17	5.560G	18	5.426G	19	5.514G	20	5.711G
21	5.315G	22	5.447G	23	5.403G	24	5.528G
25	5.534G	26	5.525G	27	5.424G	28	5.615G
29	5.479G	30	5.432G	31	5.536G	32	5.659G
33	5.482G	34	5.503G	35	5.358G	36	5.470G
37	5.576G	38	5.530G	39	5.433G	40	5.678G
41	5.585G	42	5.665G	43	5.391G	44	5.510G
45	5.449G	46	5.387G	47	5.624G	48	5.583G
49	5.283G	50	5.635G	51	5.507G	52	5.390G
53	5.370G	54	5.419G	55	5.251G	56	5.527G
57	5.496G	58	5.291G	59	5.294G	60	5.443G
61	5.616G	62	5.435G	63	5.540G	64	5.699G
65	5.709G	66	5.506G	67	5.280G	68	5.563G
69	5.493G	70	5.579G	71	5.360G	72	5.553G
73	5.431G	74	5.375G	75	5.701G	76	5.262G
77	5.599G	78	5.529G	79	5.693G	80	5.269G
81	5.652G	82	5.481G	83	5.523G	84	5.454G
85	5.359G	86	5.501G	87	5.346G	88	5.268G
89	5.303G	90	5.588G	91	5.710G	92	5.477G
93	5.264G	94	5.610G	95	5.675G	96	5.718G
97	5.255G	98	5.601G	99	5.312G	100	5.367G

Hopping Frequency Sequence Name: HOP_FREQ_SEQ_28							
SEQ#	Frequency (Hz)	SEQ#	Frequency (Hz)	SEQ#	Frequency (Hz)	SEQ#	Frequency (Hz)
1	5.473G	2	5.308G	3	5.549G	4	5.486G
5	5.345G	6	5.595G	7	5.651G	8	5.567G
9	5.259G	10	5.667G	11	5.670G	12	5.710G
13	5.458G	14	5.692G	15	5.329G	16	5.610G
17	5.699G	18	5.538G	19	5.532G	20	5.524G
21	5.545G	22	5.586G	23	5.256G	24	5.434G
25	5.480G	26	5.472G	27	5.298G	28	5.384G
29	5.262G	30	5.377G	31	5.454G	32	5.615G
33	5.718G	34	5.475G	35	5.621G	36	5.484G
37	5.507G	38	5.299G	39	5.324G	40	5.523G
41	5.562G	42	5.647G	43	5.393G	44	5.681G
45	5.365G	46	5.544G	47	5.419G	48	5.638G

49	5.310G	50	5.348G	51	5.596G	52	5.338G
53	5.632G	54	5.513G	55	5.530G	56	5.717G
57	5.293G	58	5.422G	59	5.448G	60	5.265G
61	5.450G	62	5.566G	63	5.270G	64	5.665G
65	5.305G	66	5.491G	67	5.295G	68	5.354G
69	5.515G	70	5.339G	71	5.250G	72	5.642G
73	5.522G	74	5.702G	75	5.349G	76	5.322G
77	5.656G	78	5.502G	79	5.671G	80	5.641G
81	5.290G	82	5.708G	83	5.289G	84	5.672G
85	5.620G	86	5.394G	87	5.373G	88	5.360G
89	5.468G	90	5.334G	91	5.361G	92	5.272G
93	5.358G	94	5.594G	95	5.504G	96	5.263G
97	5.646G	98	5.385G	99	5.356G	100	5.589G

Hopping Frequency Sequence Name: HOP_FREQ_SEQ_29							
SEQ#	Frequency (Hz)	SEQ#	Frequency (Hz)	SEQ#	Frequency (Hz)	SEQ#	Frequency (Hz)
1	5.251G	2	5.353G	3	5.408G	4	5.270G
5	5.346G	6	5.381G	7	5.637G	8	5.537G
9	5.723G	10	5.722G	11	5.563G	12	5.686G
13	5.721G	14	5.359G	15	5.667G	16	5.677G
17	5.333G	18	5.433G	19	5.455G	20	5.289G
21	5.358G	22	5.318G	23	5.258G	24	5.342G
25	5.298G	26	5.439G	27	5.529G	28	5.611G
29	5.561G	30	5.469G	31	5.459G	32	5.553G
33	5.635G	34	5.451G	35	5.420G	36	5.254G
37	5.331G	38	5.630G	39	5.681G	40	5.339G
41	5.424G	42	5.581G	43	5.496G	44	5.398G
45	5.355G	46	5.277G	47	5.363G	48	5.539G
49	5.533G	50	5.350G	51	5.414G	52	5.613G
53	5.556G	54	5.250G	55	5.348G	56	5.583G
57	5.683G	58	5.664G	59	5.383G	60	5.493G
61	5.536G	62	5.614G	63	5.593G	64	5.443G
65	5.697G	66	5.509G	67	5.325G	68	5.513G
69	5.633G	70	5.410G	71	5.707G	72	5.655G
73	5.627G	74	5.596G	75	5.397G	76	5.456G
77	5.472G	78	5.545G	79	5.438G	80	5.488G

81	5.287G	82	5.302G	83	5.300G	84	5.484G
85	5.549G	86	5.466G	87	5.505G	88	5.471G
89	5.491G	90	5.544G	91	5.663G	92	5.713G
93	5.423G	94	5.518G	95	5.413G	96	5.506G
97	5.724G	98	5.494G	99	5.374G	100	5.269G

Hopping Frequency Sequence Name: HOP_FREQ_SEQ_30							
SEQ#	Frequency (Hz)	SEQ#	Frequency (Hz)	SEQ#	Frequency (Hz)	SEQ#	Frequency (Hz)
1	5.653G	2	5.651G	3	5.538G	4	5.509G
5	5.600G	6	5.355G	7	5.599G	8	5.310G
9	5.407G	10	5.637G	11	5.398G	12	5.306G
13	5.534G	14	5.349G	15	5.459G	16	5.620G
17	5.473G	18	5.437G	19	5.348G	20	5.320G
21	5.486G	22	5.479G	23	5.692G	24	5.461G
25	5.335G	26	5.540G	27	5.626G	28	5.722G
29	5.621G	30	5.719G	31	5.481G	32	5.379G
33	5.578G	34	5.589G	35	5.347G	36	5.390G
37	5.456G	38	5.698G	39	5.618G	40	5.341G
41	5.420G	42	5.458G	43	5.323G	44	5.272G
45	5.471G	46	5.502G	47	5.614G	48	5.315G
49	5.513G	50	5.396G	51	5.628G	52	5.387G
53	5.307G	54	5.656G	55	5.598G	56	5.448G
57	5.607G	58	5.495G	59	5.346G	60	5.300G
61	5.679G	62	5.450G	63	5.288G	64	5.680G
65	5.443G	66	5.667G	67	5.549G	68	5.281G
69	5.474G	70	5.367G	71	5.556G	72	5.321G
73	5.329G	74	5.609G	75	5.674G	76	5.377G
77	5.336G	78	5.491G	79	5.624G	80	5.576G
81	5.380G	82	5.666G	83	5.305G	84	5.442G
85	5.285G	86	5.529G	87	5.591G	88	5.282G
89	5.350G	90	5.492G	91	5.579G	92	5.585G
93	5.676G	94	5.482G	95	5.539G	96	5.309G
97	5.635G	98	5.402G	99	5.544G	100	5.382G