



FCC Test Report

Equipment : Sophos Wireless Access Point AP15
Brand Name : Sophos
Model No. : AP 15
FCC ID : 2ACTO-AP15
Standard : 47 CFR FCC Part 15.247
Operating Band : 2400 MHz – 2483.5 MHz
FCC Classification : DTS
Applicant : Sophos Ltd
The Pentagon, Abingdon, OX14 3YP,
United Kingdom
Manufacturer : Edimax Technology Co., Ltd.
No.3, Wu-Chuan 3rd Road, Wu-Ku Industrial Park,
New Taipei City 24891, Taiwan R.O.C.

The product sample received on Jun. 26, 2014 and completely tested on Aug. 7, 2014. We, SPORTON, would like to declare that the tested sample has been evaluated in accordance with the procedures given in ANSI C63.10-2009 and shown compliance with the applicable technical standards.

The test results in this report apply exclusively to the tested model / sample. Without written approval of SPORTON INTERNATIONAL INC., the test report shall not be reproduced except in full.

Reviewed by:

Wayne Hsu / Assistant Manager





Table of Contents

- 1 GENERAL DESCRIPTION5**
- 1.1 Information.....5
- 1.2 Accessories and Support Equipment7
- 1.3 Testing Applied Standards7
- 1.4 Testing Location Information8
- 1.5 Measurement Uncertainty8
- 2 TEST CONFIGURATION OF EUT9**
- 2.1 The Worst Case Modulation Configuration9
- 2.2 The Worst Case Power Setting Parameter9
- 2.3 The Worst Case Measurement Configuration10
- 2.4 Test Setup Diagram 11
- 3 TRANSMITTER TEST RESULT13**
- 3.1 AC Power-line Conducted Emissions13
- 3.2 6dB Bandwidth16
- 3.3 RF Output Power.....18
- 3.4 Power Spectral Density23
- 3.5 Transmitter Bandedge Emissions25
- 3.6 Transmitter Unwanted Emissions.....28
- 4 TEST EQUIPMENT AND CALIBRATION DATA57**

APPENDIX A. TEST PHOTOS

APPENDIX B. PHOTOGRAPHS OF EUT



Summary of Test Result

Conformance Test Specifications					
Report Clause	Ref. Std. Clause	Description	Measured	Limit	Result
1.1.2	15.203	Antenna Requirement	Antenna connector mechanism complied	FCC 15.203	Complied
3.1	15.207	AC Power-line Conducted Emissions	[dBuV]: 0.5100690MHz 38.03 (Margin 17.97dB) - QP 34.23 (Margin 11.77dB) - AV	FCC 15.207	Complied
3.2	15.247(a)	6dB Bandwidth	6dB Bandwidth Unit [MHz] 20M: 6.57 / 40M: 35.72	≥500kHz	Complied
3.3	15.247(b)	RF Output Power (Maximum Peak Conducted Output Power)	Power [dBm]: 21.36	Power [dBm]:30	Complied
3.4	15.247(d)	Power Spectral Density	PSD [dBm/100kHz]: -6.96	PSD [dBm/3kHz]:8	Complied
3.5	15.247(c)	Transmitter Radiated Bandedge Emissions	Non-Restricted Bands: 2400.05MHz: 28.89dB Restricted Bands [dBuV/m at 3m]: 2486.20MHz 61.12 (Margin 12.88dB) - PK 52.83 (Margin 1.17dB) - AV	Non-Restricted Bands: > 20 dBc Restricted Bands: FCC 15.209	Complied
3.6	15.247(c)	Transmitter Radiated Unwanted Emissions	[dBuV/m at 3m]: 4874.00MHz 52.33 (Margin 1.67dB) - AV 54.45 (Margin 19.55dB) - PK	Non-Restricted Bands: > 20 dBc Restricted Bands: FCC 15.209	Complied



Revision History

Report No.	Version	Description	Issued Date
FR462304	Rev. 01	Initial issue of report	Aug. 28, 2014

1 General Description

1.1 Information

1.1.1 RF General Information

RF General Information					
Frequency Range (MHz)	IEEE Std. 802.11	Ch. Freq. (MHz)	Channel Number	Transmit Chains (N _{TX})	RF Output Power (dBm)
2400-2483.5	b	2412-2462	1-11 [11]	1	21.25
2400-2483.5	g	2412-2462	1-11 [11]	1	19.42
2400-2483.5	n (HT20)	2412-2462	1-11 [11]	2	21.18
2400-2483.5	n (HT40)	2422-2452	3-9 [7]	2	21.36

Note 1: RF output power specifies that Maximum Peak Conducted Output Power.
 Note 2: 802.11b uses a combination of DSSS-DBPSK, DQPSK, CCK modulation.
 Note 3: 802.11g/n uses a combination of OFDM-BPSK, QPSK, 16QAM, 64QAM modulation.
 Note 4: Co-location, Co-location is generally defined as simultaneously transmitting (co-transmitting) antennas within 20 cm of each other. (i.e., EUT has simultaneously co-transmitting that operating 2.4GHz and 5GHz.)

1.1.2 Antenna Information

Antenna Category	
<input checked="" type="checkbox"/>	External antenna (dedicated antennas)
<input checked="" type="checkbox"/>	Single power level with corresponding antenna(s).
<input type="checkbox"/>	Multiple power level and corresponding antenna(s).
<input checked="" type="checkbox"/>	RF connector provided
<input checked="" type="checkbox"/>	Unique antenna connector. (e.g., MMCX, U.FL, IPX, and RP-SMA, RP-N type...)
<input type="checkbox"/>	Standard antenna connector. (e.g., SMA, N, BNC, and TNC type...)

Antenna General Information			
Port No.	Ant. Cat.	Ant. Type	Gain (dBi)
1	External	Dipole	2.00
2	External	Dipole	2.00

The EUT supported CDD function.



1.1.3 Type of EUT

Identify EUT	
EUT Serial Number	N/A
Presentation of Equipment	<input type="checkbox"/> Production ; <input type="checkbox"/> Pre-Production ; <input checked="" type="checkbox"/> Prototype
Type of EUT	
<input checked="" type="checkbox"/>	Stand-alone
<input type="checkbox"/>	Combined (EUT where the radio part is fully integrated within another device) Combined Equipment - Brand Name / Model No.:
<input type="checkbox"/>	Plug-in radio (EUT intended for a variety of host systems) Host System - Brand Name / Model No.:
<input type="checkbox"/>	Other:

1.1.4 Test Signal Duty Cycle

Operated Mode for Worst Duty Cycle	
<input type="checkbox"/> Operated normally mode for worst duty cycle	
<input checked="" type="checkbox"/> Operated test mode for worst duty cycle	
Test Signal Duty Cycle (x)	Power Duty Factor [dB] – (10 log 1/x)
<input checked="" type="checkbox"/> 100% - IEEE 802.11b	0.00
<input checked="" type="checkbox"/> 99.30% - IEEE 802.11g	0.03
<input checked="" type="checkbox"/> 99.25% - IEEE 802.11n (HT20)	0.03
<input checked="" type="checkbox"/> 98.51% - IEEE 802.11n (HT40)	0.07

1.1.5 EUT Operational Condition

Supply Voltage	<input checked="" type="checkbox"/> AC mains	<input type="checkbox"/> DC	<input type="checkbox"/> System
Type of DC Source	<input type="checkbox"/> Internal DC supply	<input checked="" type="checkbox"/> External DC adapter	<input type="checkbox"/> Battery

1.2 Accessories and Support Equipment

Accessories Information				
AC Adapter	Brand Name	APD	Model Name	WA-12M12R
	Power Rating	I/P: 100-240V~, 50-60Hz 0.5A Max ; O/P: 12V === 1A		
UTM	Brand Name	SOPHOS	Model Name	UTM110/120/100 rev.5
	Power Rating	I/P: 12VDC === 3.33A		
AC Adapter for UTM	Brand Name	FSP	Model Name	FSP040-DGAA1
	Power Rating	I/P: 100-240V~, 1.3A, 50-60Hz ; O/P: 12.0V === 3.33A MAX		
RJ45 Cable for UTM	Brand Name	CABLETECH	Model Name	2835
	Signal Line	1.0 meter, shielded cable, w/o ferrite core		
RJ45-RS232 Cable for UTM	Brand Name	CABLETECH	Model Name	2835
	Signal Line	1.8 meter, shielded cable, w/o ferrite core		

Reminder: Regarding to more detail and other information, please refer to user manual.

Support Equipment - AC Conduction and Radiated Emission				
No.	Equipment	Brand Name	Model Name	FCC ID
Local				
1	PoE	PowerDsine	PD-3501G/AC	N/A
Remote				
-	Notebook	DELL	E5530	DoC
-	HUB	DELL	Power Connect 2816	DoC
-	UTM	Sophos	UTM110/120/100 rev.5	DoC

Support Equipment - RF Conducted				
No.	Equipment	Brand Name	Model Name	FCC ID
1	Notebook	DELL	E5520	DoC
2	HUB	DELL	Power Connect 2816	DoC
3	UTM	Sophos	UTM110/120/100 rev.5	DoC

1.3 Testing Applied Standards

According to the specifications of the manufacturer, the EUT must comply with the requirements of the following standards:

- ◆ 47 CFR FCC Part 15
- ◆ ANSI C63.10-2009
- ◆ FCC KDB 558074 D01 v03r02
- ◆ FCC KDB 662911 v02r01
- ◆

1.4 Testing Location Information

Testing Location			
<input checked="" type="checkbox"/>	HWA YA	ADD : No. 52, Hwa Ya 1 st Rd., Hwa Ya Technology Park, Kwei-Shan Hsiang, Tao Yuan Hsien, Taiwan, R.O.C.	
		TEL : 886-3-327-3456	FAX : 886-3-327-0973
Test Condition	Test Site No.	Test Engineer	Test Environment
AC Conduction	CO04-HY	Zeus	24°C / 45%
RF Conducted	TH06-HY	Wei	24.3°C / 63.2%
Radiated Emission	03CH03-HY	Hunter	25°C / 52%

1.5 Measurement Uncertainty

ISO/IEC 17025 requires that an estimate of the measurement uncertainties associated with the emissions test results be included in the report. The measurement uncertainties given below are based on a 95% confidence level (based on a coverage factor (k=2))

Measurement Uncertainty		
Test Item	Uncertainty	
AC power-line conducted emissions	±2.2 dB	
Emission bandwidth, 6dB bandwidth	±1.4 %	
RF output power, conducted	±0.6 dB	
Power density, conducted	±0.8 dB	
Unwanted emissions, conducted	9 – 150 kHz	±0.3 dB
	0.15 – 30 MHz	±0.4 dB
	30 – 1000 MHz	±0.5 dB
	1 – 18 GHz	±0.6 dB
	18 – 40 GHz	±0.8 dB
	40 – 200 GHz	N/A
All emissions, radiated	9 – 150 kHz	±2.4 dB
	0.15 – 30 MHz	±2.2 dB
	30 – 1000 MHz	±2.5 dB
	1 – 18 GHz	±3.5 dB
	18 – 40 GHz	±3.8 dB
	40 – 200 GHz	N/A
Temperature	±0.8 °C	
Humidity	±3 %	
DC and low frequency voltages	±3 %	
Time	±1.4 %	
Duty Cycle	±1.4 %	

2 Test Configuration of EUT

2.1 The Worst Case Modulation Configuration

Worst Modulation Used for Conformance Testing			
Modulation Mode	Transmit Chains (N _{TX})	Data Rate / MCS	Worst Data Rate / MCS
11b,1-11Mbps	1	1-11 Mbps	1 Mbps
11g,6-54Mbps	1	6-54 Mbps	6 Mbps
HT20,M0-15	2	MCS 0-15	MCS 0
HT40,M0-15	2	MCS 0-15	MCS 0



2.2 The Worst Case Power Setting Parameter

The Worst Case Power Setting Parameter (2400-2483.5MHz band)							
Test Software Version	Dos						
Modulation Mode	N _{TX}	Test Frequency (MHz)					
		NCB: 20MHz			NCB: 40MHz		
		2412	2437	2462	2422	2437	2452
11b	1	19	19.5	19	-	-	-
11g	1	15	15.5	14.5	-	-	-
HT20	2	13.5	14.5	13.5	-	-	-
HT40	2	-	-	-	13.5	14	14.5

2.3 The Worst Case Measurement Configuration

The Worst Case Mode for Following Conformance Tests	
Tests Item	AC power-line conducted emissions
Condition	AC power-line conducted measurement for line and neutral Test Voltage: 120Vac / 60Hz
Operating Mode	Operating Mode Description
1	AC Power & Radio link (Transmitter)
2	PoE & Radio link (Transmit)
For operating mode 2 was the worst case and it was recorded in this test report.	

The Worst Case Mode for Following Conformance Tests	
Tests Item	RF Output Power, Power Spectral Density, 6 dB Bandwidth
Test Condition	Conducted measurement at transmit chains
Modulation Mode	11b, 11g, HT20, HT40

The Worst Case Mode for Following Conformance Tests			
Tests Item	Transmitter Radiated Unwanted Emissions Transmitter Radiated Bandedge Emissions		
Test Condition	Radiated measurement If EUT consist of multiple antenna assembly (multiple antenna are used in EUT regardless of spatial multiplexing MIMO configuration), the radiated test should be performed with highest antenna gain of each antenna type.		
User Position	<input type="checkbox"/> EUT will be placed in fixed position.		
	<input checked="" type="checkbox"/> EUT will be placed in mobile position and operating multiple positions. The worst planes is Y.		
	<input type="checkbox"/> EUT will be a hand-held or body-worn battery-powered devices and operating multiple positions.		
Operating Mode	Operating Mode Description		
1	AC Power & Radio link (Transmit)		
2	PoE & Radio link (Transmit)		
For operating mode 1 was the worst case and it was recorded in this test report.			
Modulation Mode	11b, 11g, HT20, HT40		
Orthogonal Planes of EUT	X Plane	Y Plane	Z Plane
			

2.4 Test Setup Diagram

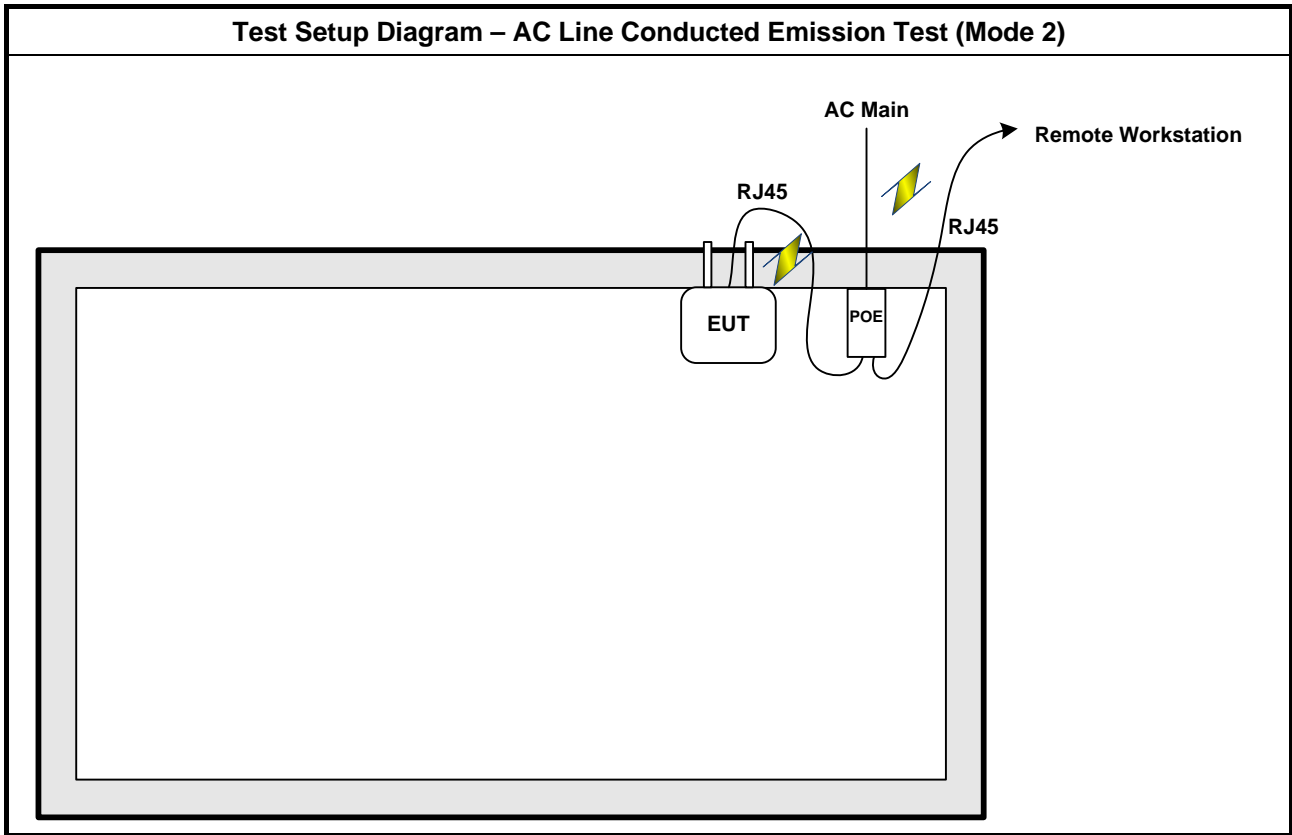

Test Setup Diagram - Radiated Test Below 1GHz (Mode 1)

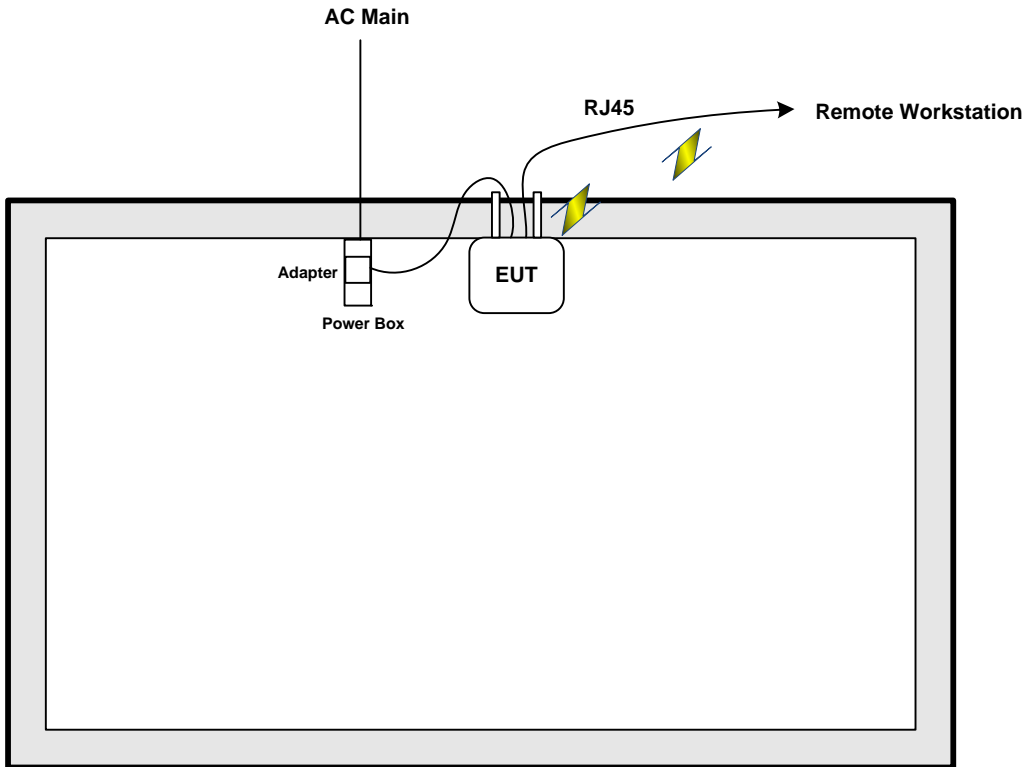

Test Setup Diagram - Radiated Test Above 1GHz (Mode 1)

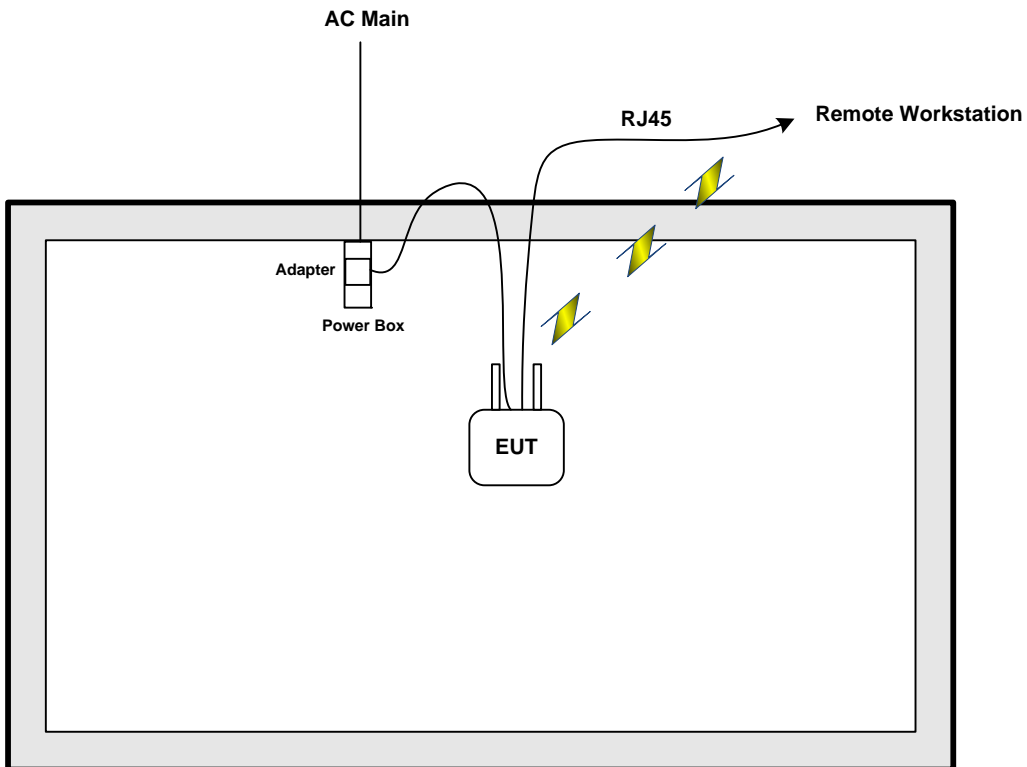

3 Transmitter Test Result

3.1 AC Power-line Conducted Emissions

3.1.1 AC Power-line Conducted Emissions Limit

AC Power-line Conducted Emissions Limit		
Frequency Emission (MHz)	Quasi-Peak	Average
0.15-0.5	66 - 56 *	56 - 46 *
0.5-5	56	46
5-30	60	50

Note 1: * Decreases with the logarithm of the frequency.

3.1.2 Measuring Instruments

Refer a test equipment and calibration data table in this test report.

3.1.3 Test Procedures

Test Method
<input checked="" type="checkbox"/> Refer as ANSI C63.10-2009, clause 6.2 for AC power-line conducted emissions.

3.1.4 Test Setup

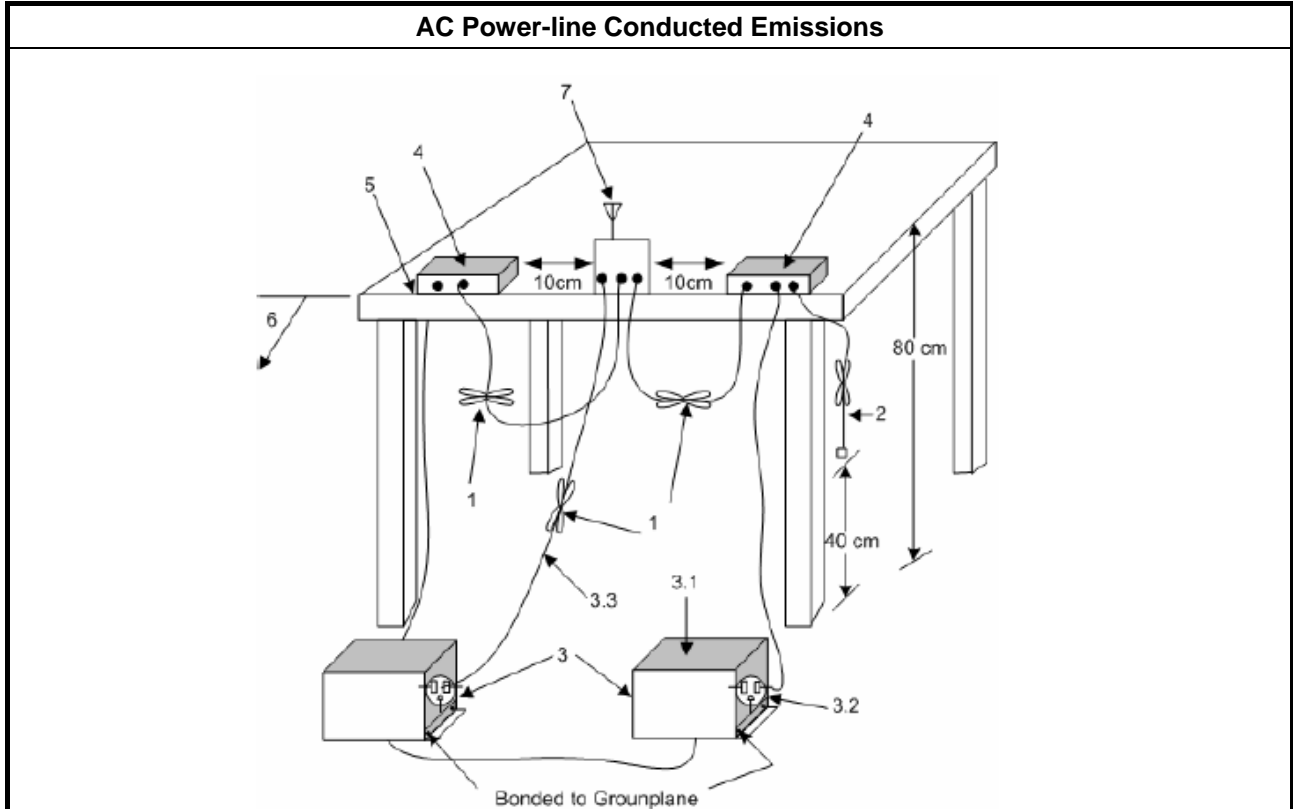

3.1.5 Test Result of AC Power-line Conducted Emissions

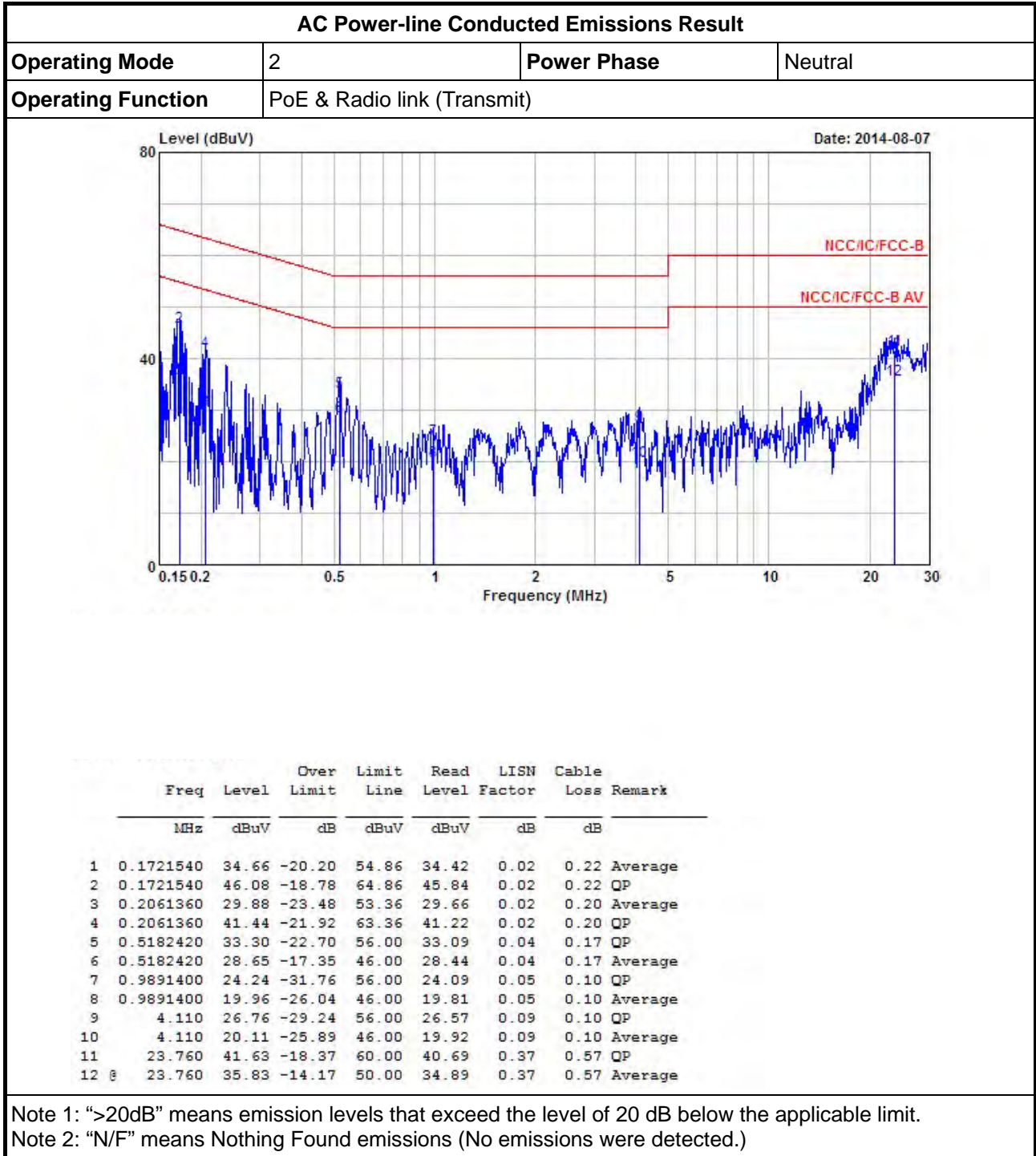



AC Power-line Conducted Emissions Result

Operating Mode	2	Power Phase	Line
Operating Function	PoE & Radio link (Transmit)		

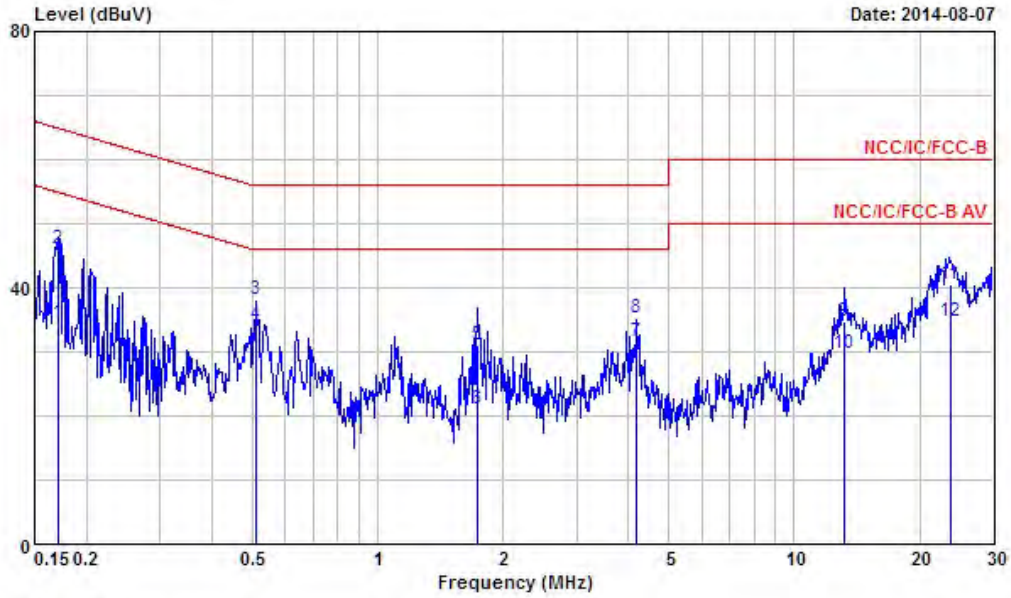

	Freq	Level	Over	Limit	Read	LISM	Cable	Remark
	MHz	dBuV	Limit	Line	Level	Factor	Loss	
			dB	dBuV	dBuV	dB	dB	
1	0.1703400	34.58	-20.36	54.94	34.33	0.03	0.22	Average
2	0.1703400	46.15	-18.79	64.94	45.90	0.03	0.22	QP
3	0.5100690	38.03	-17.97	56.00	37.82	0.04	0.17	QP
4	0.5100690	34.23	-11.77	46.00	34.02	0.04	0.17	Average
5	1.730	31.16	-24.84	56.00	30.83	0.07	0.26	QP
6	1.730	21.10	-24.90	46.00	20.77	0.07	0.26	Average
7	4.180	31.50	-14.50	46.00	31.30	0.10	0.10	Average
8	4.180	35.22	-20.78	56.00	35.02	0.10	0.10	QP
9	13.200	34.85	-25.15	60.00	34.34	0.24	0.27	QP
10	13.200	29.68	-20.32	50.00	29.17	0.24	0.27	Average
11	23.640	40.51	-19.49	60.00	39.58	0.36	0.57	QP
12	23.640	34.70	-15.30	50.00	33.77	0.36	0.57	Average

Note 1: ">20dB" means emission levels that exceed the level of 20 dB below the applicable limit.
 Note 2: "N/F" means Nothing Found emissions (No emissions were detected.)

3.2 6dB Bandwidth

3.2.1 6dB Bandwidth Limit

6dB Bandwidth Limit	
Systems using digital modulation techniques:	
<input checked="" type="checkbox"/>	6 dB bandwidth \geq 500 kHz.

3.2.2 Measuring Instruments

Refer a test equipment and calibration data table in this test report.

3.2.3 Test Procedures

Test Method	
<input checked="" type="checkbox"/>	For the emission bandwidth shall be measured using one of the options below:
<input checked="" type="checkbox"/>	Refer as FCC KDB 558074 D01 v03r02, clause 8.1 Option 1 for 6 dB bandwidth measurement.
<input type="checkbox"/>	Refer as FCC KDB 558074 D01 v03r02, clause 8.2 Option 2 for 6 dB bandwidth measurement.
<input type="checkbox"/>	Refer as ANSI C63.10, clause 6.9.1 for occupied bandwidth testing.
<input checked="" type="checkbox"/>	For conducted measurement.
<input checked="" type="checkbox"/>	The EUT supports single transmit chain and measurements performed on this transmit chain.
<input type="checkbox"/>	The EUT supports diversity transmitting and the results on transmit chain port 1 is the worst case.
<input checked="" type="checkbox"/>	The EUT supports multiple transmit chains using options given below:
<input type="checkbox"/>	Option 1: Multiple transmit chains measurements need to be performed on one of the active transmit chains (antenna outputs). All measurement had be performed on transmit chains 1.
<input checked="" type="checkbox"/>	Option 2: Multiple transmit chains measurements need to be performed on each transmit chains individually (antenna outputs). All measurement had be performed on all transmit chains.

3.2.4 Test Setup

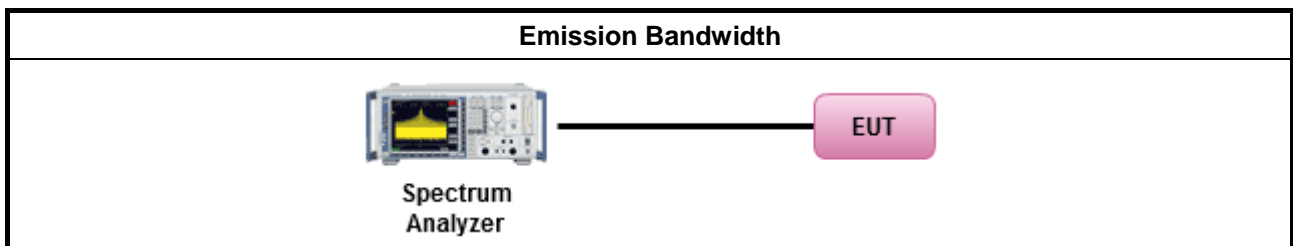

3.2.5 Test Result of Emission Bandwidth

Emission Bandwidth Result						
Condition			Emission Bandwidth (MHz)			
Modulation Mode	N _{TX}	Freq. (MHz)	99% Bandwidth		6dB Bandwidth	
			Chain Port 1	Chain Port 2	Chain Port 1	Chain Port 2
11b	1	2412	11.76	-	6.57	-
11b	1	2437	11.91	-	6.61	-
11b	1	2462	11.79	-	7.05	-
11g	1	2412	16.46	-	16.51	-
11g	1	2437	16.52	-	16.47	-
11g	1	2462	16.50	-	16.57	-
HT20	2	2412	17.72	17.75	17.80	17.82
HT20	2	2437	17.64	17.66	17.64	17.58
HT20	2	2462	17.61	17.70	17.64	17.74
HT40	2	2422	36.26	36.18	35.92	35.88
HT40	2	2437	36.22	36.22	36.40	36.28
HT40	2	2452	36.18	36.22	35.72	36.28
Limit			N/A		≥500 kHz	
Result			Complied			

Note 1: N_{TX} = Number of Transmit Chains

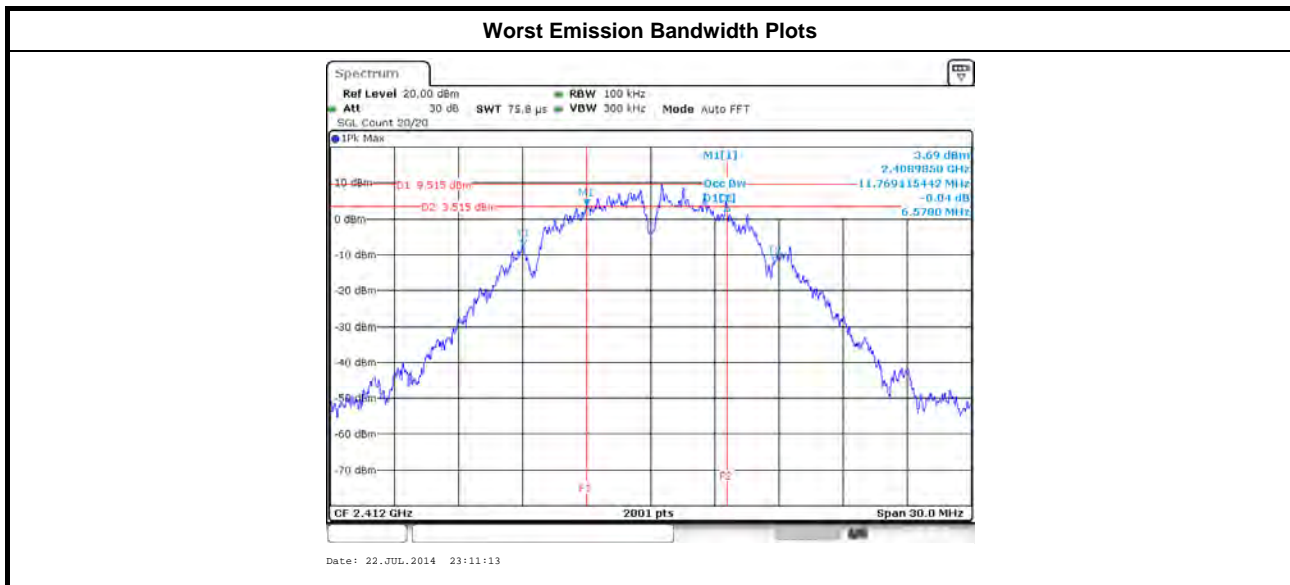

3.3 RF Output Power

3.3.1 RF Output Power Limit

RF Output Power Limit	
Maximum Peak Conducted Output Power or Maximum Conducted Output Power Limit	
<input checked="" type="checkbox"/> 2400-2483.5 MHz Band:	
<input checked="" type="checkbox"/>	If $G_{TX} \leq 6$ dBi, then $P_{Out} \leq 30$ dBm (1 W)
<input checked="" type="checkbox"/>	Point-to-multipoint systems (P2M): If $G_{TX} > 6$ dBi, then $P_{Out} = 30 - (G_{TX} - 6)$ dBm
<input type="checkbox"/>	Point-to-point systems (P2P): If $G_{TX} > 6$ dBi, then $P_{Out} = 30 - (G_{TX} - 6)/3$ dBm
<input type="checkbox"/>	Smart antenna system (SAS):
<input type="checkbox"/>	Single beam: If $G_{TX} > 6$ dBi, then $P_{Out} = 30 - (G_{TX} - 6)/3$ dBm
<input type="checkbox"/>	Overlap beam: If $G_{TX} > 6$ dBi, then $P_{Out} = 30 - (G_{TX} - 6)/3$ dBm
<input type="checkbox"/>	Aggregate power on all beams: If $G_{TX} > 6$ dBi, then $P_{Out} = 30 - (G_{TX} - 6)/3 + 8$ dBm
e.i.r.p. Power Limit:	
<input checked="" type="checkbox"/> 2400-2483.5 MHz Band	
<input checked="" type="checkbox"/>	Point-to-multipoint systems (P2M): $P_{eirp} \leq 36$ dBm (4 W)
<input type="checkbox"/>	Point-to-point systems (P2P): $P_{eirp} \leq \text{MAX}(36, [P_{Out} + G_{TX}])$ dBm
<input type="checkbox"/>	Smart antenna system (SAS)
<input type="checkbox"/>	Single beam: $P_{eirp} \leq \text{MAX}(36, P_{Out} + G_{TX})$ dBm
<input type="checkbox"/>	Overlap beam: $P_{eirp} \leq \text{MAX}(36, P_{Out} + G_{TX})$ dBm
<input type="checkbox"/>	Aggregate power on all beams: $P_{eirp} \leq \text{MAX}(36, [P_{Out} + G_{TX} + 8])$ dBm
P_{Out} = maximum peak conducted output power or maximum conducted output power in dBm, G_{TX} = the maximum transmitting antenna directional gain in dBi. P_{eirp} = e.i.r.p. Power in dBm.	

3.3.2 Measuring Instruments

Refer a test equipment and calibration data table in this test report.

3.3.3 Test Procedures

Test Method	
<input checked="" type="checkbox"/>	Maximum Peak Conducted Output Power
<input type="checkbox"/>	Refer as FCC KDB 558074 D01 v03r02, clause 9.1.1 (RBW ≥ EBW method).
<input checked="" type="checkbox"/>	Refer as FCC KDB 558074 D01 v03r02, clause 9.1.2 (peak power meter for VBW ≥ DTS BW).
<input checked="" type="checkbox"/>	Maximum Conducted Output Power
	[duty cycle ≥ 98% or external video / power trigger]
<input checked="" type="checkbox"/>	Refer as FCC KDB 558074 D01 v03r02, clause 9.2.2.2 Method AVGSA-1 (spectral trace averaging).
<input type="checkbox"/>	Refer as FCC KDB 558074 D01 v03r02, clause 9.2.2.3 Method AVGSA-1 Alt. (slow sweep speed)
	duty cycle < 98% and average over on/off periods with duty factor
<input type="checkbox"/>	Refer as FCC KDB 558074 D01 v03r02, clause 9.2.2.4 Method AVGSA-2 (spectral trace averaging).
<input type="checkbox"/>	Refer as FCC KDB 558074 D01 v03r02, clause 9.2.2.5 Method AVGSA-2 Alt. (slow sweep speed)
	RF power meter and average over on/off periods with duty factor or gated trigger
<input type="checkbox"/>	Refer as FCC KDB 558074 D01 v03r02, clause 9.2.3 Method AVGPM (using an RF average power meter).
<input checked="" type="checkbox"/>	For conducted measurement.
<input checked="" type="checkbox"/>	The EUT supports single transmit chain and measurements performed on this transmit chain.
<input type="checkbox"/>	The EUT supports diversity transmitting and the results on transmit chain port 1 is the worst case.
<input checked="" type="checkbox"/>	The EUT supports multiple transmit chains using options given below: Refer as FCC KDB 662911, In-band power measurements. Using the measure-and-sum approach, measured all transmit ports individually. Sum the power (in linear power units e.g., mW) of all ports for each individual sample and save them.
<input checked="" type="checkbox"/>	If multiple transmit chains, EIRP calculation could be following as methods: $P_{total} = P_1 + P_2 + \dots + P_n$ (calculated in linear unit [mW] and transfer to log unit [dBm]) $EIRP_{total} = P_{total} + DG$

3.3.4 Test Setup

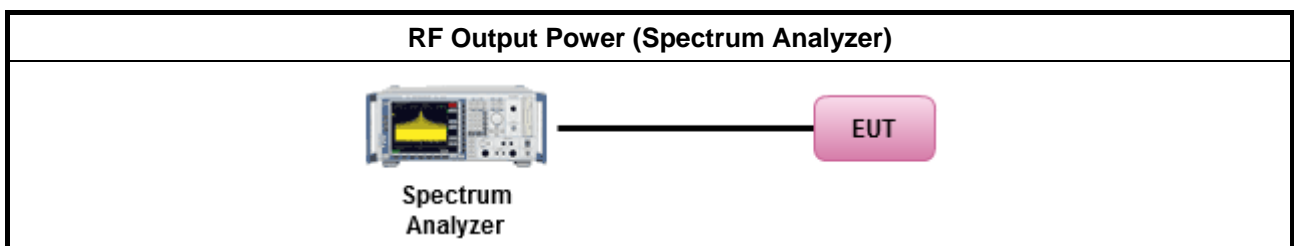

3.3.5 Directional Gain for Power Measurement

Directional Gain (DG) Result			
Transmit Chains No.	1	2	-
Maximum G _{ANT} (dBi)	2.00	2.00	-
Modulation Mode	N _{TX}	N _{SS} (Min.)	DG (dBi) (See the Note 4)
11b	1	1	2.00
11g	1	1	2.00
HT20	2	1	2.00
HT40	2	1	2.00

Note 1: For all transmitter outputs with equal antenna gains, directional gain is to be computed as follows:
 Any transmit signals are correlated, Directional Gain = G_{ANT} + 10 log(N_{TX})
 All transmit signals are completely uncorrelated, Directional Gain = G_{ANT}

Note 2: For all transmitter outputs with unequal antenna gains, directional gain is to be computed as follows:
 Any transmit signals are correlated, Directional Gain = 10 log[(10^{G_{1/20}} + ... + 10^{G_{N/20}})² / N_{TX}]
 All transmit signals are completely uncorrelated, Directional Gain = 10 log[(10^{G_{1/10}} + ... + 10^{G_{N/10}}) / N_{TX}]

Note 3: For Spatial Multiplexing, Directional Gain (DG) = G_{ANT} + 10 log(N_{TX}/N_{SS}),
 where N_{SS} = the number of independent spatial streams data.

Note 4: For CDD transmissions, directional gain is calculated as power measurements:
 Directional Gain (DG) = G_{ANT} + Array Gain, where Array Gain is as follows:
 Array Gain = 0 dB (i.e., no array gain) for N_{TX} ≤ 4;
 Array Gain = 0 dB (i.e., no array gain) for channel widths ≥ 40 MHz for any N_{TX}



3.3.6 Test Result of Maximum Peak Conducted Output Power

Maximum Peak Conducted Output Power Result									
Condition			RF Output Power (dBm)						
Modulation Mode	N _{TX}	Freq. (MHz)	Chain Port 1	Chain Port 2	Sum Chain	Power Limit	DG (dBi)	EIRP Power	EIRP Limit
11b	1	2412	21.25	-	21.25	30.00	2.00	23.25	36.00
11b	1	2437	20.89	-	20.89	30.00	2.00	22.89	36.00
11b	1	2462	21.18	-	21.18	30.00	2.00	23.18	36.00
11g	1	2412	19.42	-	19.42	30.00	2.00	21.42	36.00
11g	1	2437	19.02	-	19.02	30.00	2.00	21.02	36.00
11g	1	2462	19.04	-	19.04	30.00	2.00	21.04	36.00
HT20	2	2412	18.04	18.02	21.04	30.00	2.00	23.04	36.00
HT20	2	2437	18.27	18.07	21.18	30.00	2.00	23.18	36.00
HT20	2	2462	18.30	18.03	21.18	30.00	2.00	23.18	36.00
HT40	2	2422	18.12	18.01	21.08	30.00	2.00	23.08	36.00
HT40	2	2437	18.39	17.92	21.17	30.00	2.00	23.17	36.00
HT40	2	2452	18.48	18.22	21.36	30.00	2.00	23.36	36.00
Result			Complied						

3.3.7 Test Result of Maximum Conducted Output Power

Maximum Conducted Output Power									
Condition			RF Output Power (dBm)						
Modulation Mode	N _{TX}	Freq. (MHz)	Chain Port 1	Chain Port 2	Sum Chain	Power Limit	DG (dBi)	EIRP Power	EIRP Limit
11b	1	2412	18.25	-	18.25	30.00	2.00	20.25	36.00
11b	1	2437	18.08	-	18.08	30.00	2.00	20.08	36.00
11b	1	2462	18.27	-	18.27	30.00	2.00	20.27	36.00
11g	1	2412	14.36	-	14.36	30.00	2.00	16.36	36.00
11g	1	2437	14.13	-	14.13	30.00	2.00	16.13	36.00
11g	1	2462	14.07	-	14.07	30.00	2.00	16.07	36.00
HT20	2	2412	13.16	13.01	16.10	30.00	2.00	18.10	36.00
HT20	2	2437	13.29	12.99	16.16	30.00	2.00	18.16	36.00
HT20	2	2462	13.32	12.89	16.12	30.00	2.00	18.12	36.00
HT40	2	2422	13.23	12.95	16.10	30.00	2.00	18.10	36.00
HT40	2	2437	13.40	12.83	16.13	30.00	2.00	18.13	36.00
HT40	2	2452	13.33	13.15	16.25	30.00	2.00	18.25	36.00
Result			Complied						



2400-2483.5MHz - Worst RF Output Power Plots

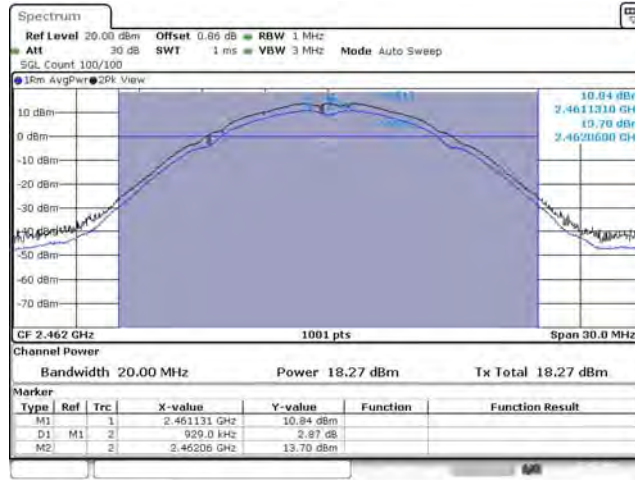

Date: 22/07/2014 13:10:48

3.4 Power Spectral Density

3.4.1 Power Spectral Density Limit

Power Spectral Density Limit
<input checked="" type="checkbox"/> Power Spectral Density (PSD) \leq 8 dBm/3kHz

3.4.2 Measuring Instruments

Refer a test equipment and calibration data table in this test report.

3.4.3 Test Procedures

Test Method
<input checked="" type="checkbox"/> Peak power spectral density procedures that the same method as used to determine the conducted output power. If maximum peak conducted output power was measured to demonstrate compliance to the output power limit, then the peak PSD procedure below (Method PKPSD) shall be used. If maximum conducted output power was measured to demonstrate compliance to the output power limit, then one of the average PSD procedures shall be used, as applicable based on the following criteria (the peak PSD procedure is also an acceptable option).
<input checked="" type="checkbox"/> Refer as FCC KDB 558074 D01 v03r02, clause 10.2 Method PKPSD (RBW=3-100kHz;detector=peak)..
[duty cycle \geq 98% or external video / power trigger]
<input checked="" type="checkbox"/> Refer as FCC KDB 558074 D01 v03r02, clause 10.3 Method AVGPSD-1 (spectral trace averaging).
<input type="checkbox"/> Refer as FCC KDB 558074 D01 v03r02, clause 10.4 Method AVGPSD-1 Alt. (slow sweep speed)
duty cycle < 98% and average over on/off periods with duty factor
<input type="checkbox"/> Refer as FCC KDB 558074 D01 v03r02, clause 10.5 Method AVGPSD-2 (spectral trace averaging).
<input type="checkbox"/> Refer as FCC KDB 558074 D01 v03r02, clause 10.6 Method AVGPSD-2 Alt. (slow sweep speed)
<input checked="" type="checkbox"/> For conducted measurement.
<input checked="" type="checkbox"/> The EUT supports single transmit chain and measurements performed on this transmit chain.
<input type="checkbox"/> The EUT supports diversity transmitting and the results on transmit chain port 1 is the worst case.
<input checked="" type="checkbox"/> The EUT supports multiple transmit chains using options given below:
<input checked="" type="checkbox"/> Option 1: Measure and sum the spectra across the outputs. Refer as FCC KDB 662911, In-band power spectral density (PSD). Sample all transmit ports simultaneously using a spectrum analyzer for each transmit port. Where the trace bin-by-bin of each transmit port summing can be performed. (i.e., in the first spectral bin of output 1 is summed with that in the first spectral bin of output 2 and that from the first spectral bin of output 3, and so on up to the N _{TX} output to obtain the value for the first frequency bin of the summed spectrum.). Add up the amplitude (power) values for the different transmit chains and use this as the new data trace.
<input type="checkbox"/> Option 2: Measure and add 10 log(N) dB, where N is the number of transmit chains. Refer as FCC KDB 662911, In-band power spectral density (PSD). Performed at each transmit chains and each transmit chains shall be compared with the limit have been reduced with 10 log(N). Or each transmit chains shall be add 10 log(N) to compared with the limit.

3.4.4 Test Setup

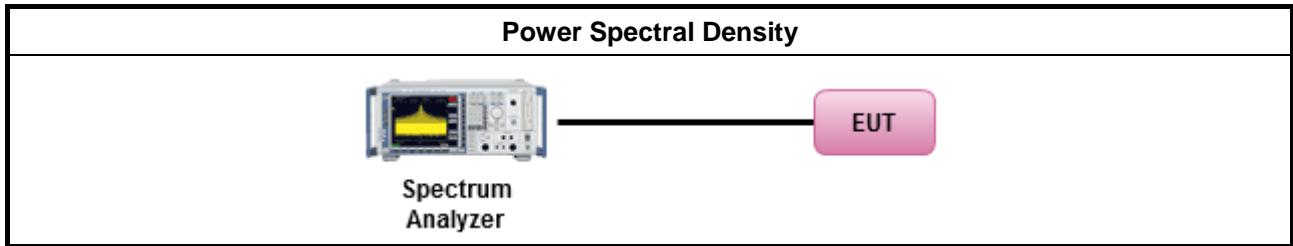

3.4.5 Test Result of Power Spectral Density

Power Spectral Density Result				
Condition			Power Spectral Density	
Modulation Mode	N _{TX}	Freq. (MHz)	Sum Chain (dBm/100kHz)	PSD Limit (dBm/3kHz)
11b	1	2412	-7.11	8
11b	1	2437	-7.32	8
11b	1	2462	-6.96	8
11g	1	2412	-15.68	8
11g	1	2437	-15.89	8
11g	1	2462	-15.84	8
HT20	2	2412	-14.33	8
HT20	2	2437	-14.26	8
HT20	2	2462	-14.59	8
HT40	2	2422	-16.05	8
HT40	2	2437	-15.94	8
HT40	2	2452	-15.42	8
Result			Complied	

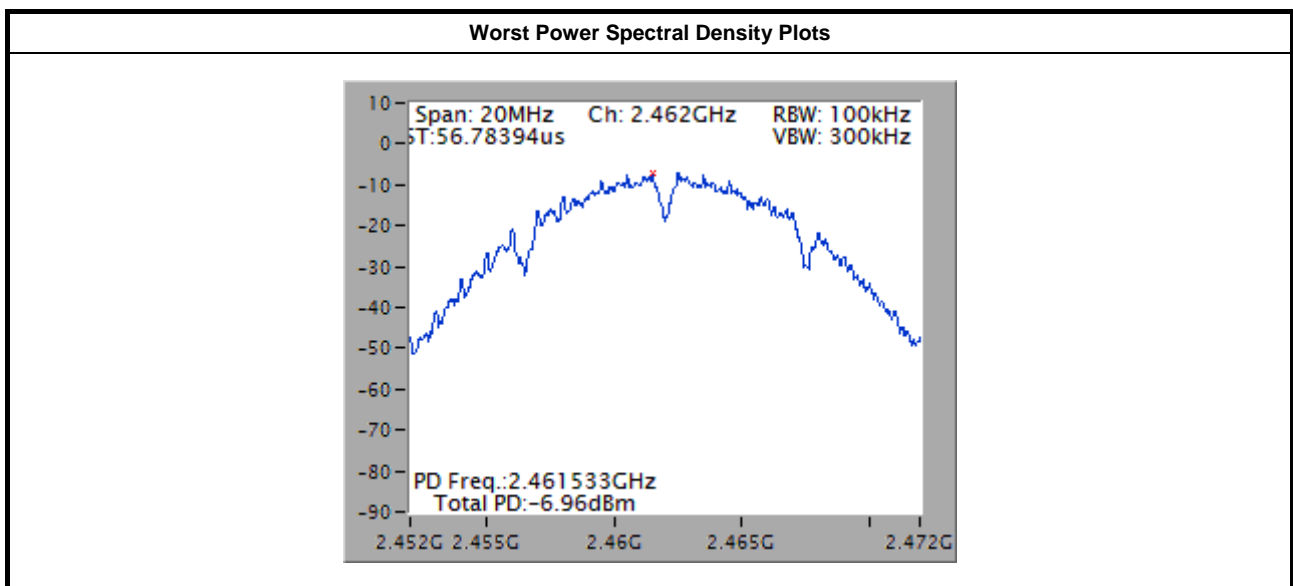

3.5 Transmitter Bandedge Emissions

3.5.1 Transmitter Radiated Bandedge Emissions Limit

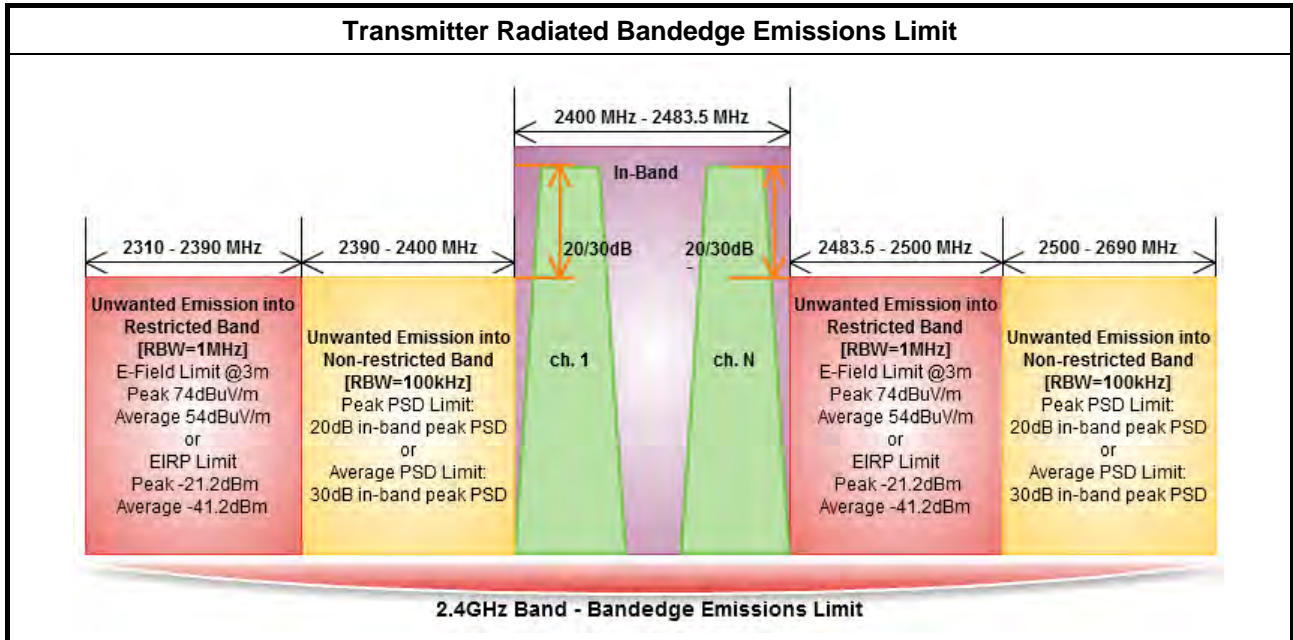

3.5.2 Measuring Instruments

Refer a test equipment and calibration data table in this test report.

3.5.3 Test Procedures

Test Method	
<input checked="" type="checkbox"/>	The average emission levels shall be measured in [duty cycle ≥ 98 or duty factor].
<input checked="" type="checkbox"/>	Refer as ANSI C63.10, clause 6.9.2.2 bandedge testing shall be performed at the lowest frequency channel and highest frequency channel within the allowed operating band.
<input checked="" type="checkbox"/>	For the transmitter unwanted emissions shall be measured using following options below:
<input checked="" type="checkbox"/>	Refer as FCC KDB 558074 D01 v03r02, clause 11 for unwanted emissions into non-restricted bands.
<input checked="" type="checkbox"/>	Refer as FCC KDB 558074 D01 v03r02, clause 12 for unwanted emissions into restricted bands.
<input type="checkbox"/>	Refer as FCC KDB 558074 D01 v03r02, clause 12.2.5.1 Option 1 (trace averaging for duty cycle $\geq 98\%$)
<input type="checkbox"/>	Refer as FCC KDB 558074 D01 v03r02, clause 12.2.5.2 Option 2 (trace averaging + duty factor).
<input type="checkbox"/>	Refer as FCC KDB 558074 D01 v03r02, clause 12.2.5.3 Option 3 (Reduced VBW $\geq 1/T$).
<input checked="" type="checkbox"/>	Refer as ANSI C63.10, clause 4.2.3.2.3 (Reduced VBW). VBW $\geq 1/T$, where T is pulse time.
<input type="checkbox"/>	Refer as ANSI C63.10, clause 4.2.3.2.4 average value of pulsed emissions.
<input checked="" type="checkbox"/>	Refer as FCC KDB 558074 D01 v03r02, clause 11.3 and 12.2.4 measurement procedure peak limit.
<input checked="" type="checkbox"/>	For the transmitter bandedge emissions shall be measured using following options below:
<input type="checkbox"/>	Refer as FCC KDB 558074 D01 v03r02, clause 13.3 for narrower resolution bandwidth (100kHz) using the band power and summing the spectral levels (i.e., 1 MHz).
<input checked="" type="checkbox"/>	Refer as ANSI C63.10, clause 6.9.2 for band-edge testing.
<input type="checkbox"/>	Refer as ANSI C63.10, clause 6.9.3 for marker-delta method for band-edge measurements.
<input checked="" type="checkbox"/>	For radiated measurement, refer as FCC KDB 558074 D01 v03r02, clause 12.2.7.

3.5.4 Test Setup

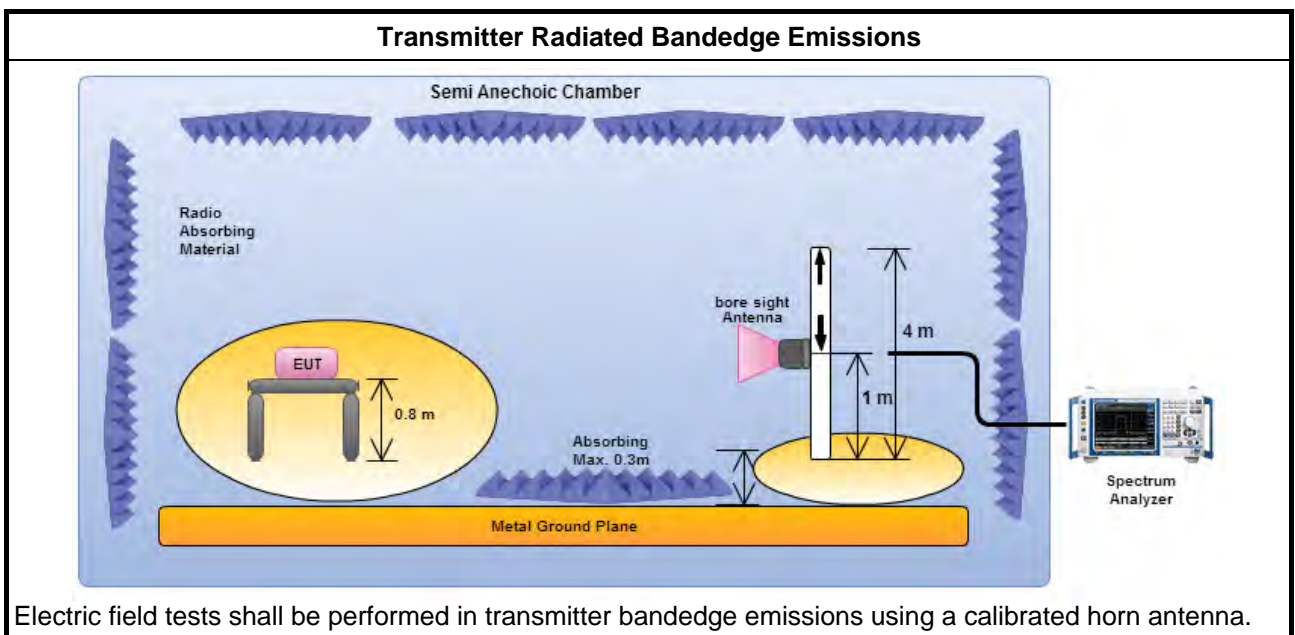

3.5.5 Transmitter Radiated Bandedge Emissions

2400-2483.5MHz Transmitter Radiated Bandedge Emissions (Non-restricted Band)								
Modulation	N _{TX}	Test Freq. (MHz)	In-band PSD [i] (dBuV/100kHz)	Freq. (MHz)	Out-band PSD [o] (dBuV/100kHz)	[i] – [o] (dB)	Limit (dB)	Pol.
11b	1	2412	109.51	2399.15	68.55	40.96	20	V
11b	1	2462	109.24	2541.40	61.15	48.09	20	V
11g	1	2412	100.36	2400.05	71.47	28.89	20	V
11g	1	2462	100.42	2532.20	60.56	39.86	20	V
HT20	2	2412	102.36	2400.05	71.26	31.10	20	V
HT20	2	2462	101.92	2517.20	60.85	41.07	20	V
HT40	2	2422	98.85	2400.02	67.66	31.19	20	V
HT40	2	2452	98.98	2520.08	60.53	38.45	20	V

Note 1: Measurement worst emissions of receive antenna polarization

2400-2483.5MHz Transmitter Radiated Bandedge Emissions (Restricted Band)										
Modulation Mode	N _{TX}	Freq. (MHz)	Measure Distance (m)	Freq. (MHz) PK	Level (dBuV/m) PK	Limit (dBuV/m) PK	Freq. (MHz) AV	Level (dBuV/m) AV	Limit (dBuV/m) AV	Pol.
11b	1	2412	3	2332.18	60.15	74	2387.28	51.58	54	V
11b	1	2462	3	2486.70	61.12	74	2486.20	52.83	54	V
11g	1	2412	3	2389.97	72.10	74	2389.74	52.08	54	V
11g	1	2462	3	2483.80	71.80	74	2483.50	50.67	54	V
HT20	2	2412	3	2389.97	72.01	74	2389.74	50.81	54	V
HT20	2	2462	3	2483.80	72.72	74	2483.40	49.47	54	V
HT40	2	2422	3	2388.67	71.47	74	2389.73	50.53	54	V
HT40	2	2452	3	2484.08	72.95	74	2483.48	52.25	54	V

Note 1: Measurement worst emissions of receive antenna polarization.

3.6 Transmitter Unwanted Emissions

3.6.1 Transmitter Radiated Unwanted Emissions Limit

Restricted Band Emissions Limit			
Frequency Range (MHz)	Field Strength (uV/m)	Field Strength (dBuV/m)	Measure Distance (m)
0.009~0.490	2400/F(kHz)	48.5 - 13.8	300
0.490~1.705	24000/F(kHz)	33.8 - 23	30
1.705~30.0	30	29	30
30~88	100	40	3
88~216	150	43.5	3
216~960	200	46	3
Above 960	500	54	3

Note 1: Test distance for frequencies at or above 30 MHz, measurements may be performed at a distance other than the limit distance provided they are not performed in the near field and the emissions to be measured can be detected by the measurement equipment. When performing measurements at a distance other than that specified, the results shall be extrapolated to the specified distance using an extrapolation factor of 20 dB/decade (inverse of linear distance for field-strength measurements, inverse of linear distance-squared for power-density measurements).

Note 2: Test distance for frequencies at below 30 MHz, measurements may be performed at a distance closer than the EUT limit distance; however, an attempt should be made to avoid making measurements in the near field. When performing measurements below 30 MHz at a closer distance than the limit distance, the results shall be extrapolated to the specified distance by either making measurements at a minimum of two or more distances on at least one radial to determine the proper extrapolation factor or by using the square of an inverse linear distance extrapolation factor (40 dB/decade). The test report shall specify the extrapolation method used to determine compliance of the EUT.

Un-restricted Band Emissions Limit	
RF output power procedure	Limit (dB)
Peak output power procedure	20
Average output power procedure	30

Note 1: If the peak output power procedure is used to measure the fundamental emission power to demonstrate compliance to requirements, then the peak conducted output power measured within any 100 kHz outside the authorized frequency band shall be attenuated by at least 20 dB relative to the maximum measured in-band peak PSD level.

Note 2: If the average output power procedure is used to measure the fundamental emission power to demonstrate compliance to requirements, then the power in any 100 kHz outside of the authorized frequency band shall be attenuated by at least 30 dB relative to the maximum measured in-band average PSD level.

3.6.2 Measuring Instruments

Refer a test equipment and calibration data table in this test report.

3.6.3 Test Procedures

Test Method	
<input checked="" type="checkbox"/>	Measurements may be performed at a distance other than the limit distance provided they are not performed in the near field and the emissions to be measured can be detected by the measurement equipment. When performing measurements at a distance other than that specified, the results shall be extrapolated to the specified distance using an extrapolation factor of 20 dB/decade (inverse of linear distance for field-strength measurements, inverse of linear distance-squared for power-density measurements).
<input checked="" type="checkbox"/>	Measurements in the frequency range 10 GHz - 18GHz are typically made at a closer distance 1m, because the instrumentation noise floor is typically close to the radiated emission limit.
<input checked="" type="checkbox"/>	Measurements in the frequency range above 18 GHz - 25GHz are typically made at a closer distance 0.5m, because the instrumentation noise floor is typically close to the radiated emission limit.
<input checked="" type="checkbox"/>	The average emission levels shall be measured in [duty cycle \geq 98 or duty factor].
<input checked="" type="checkbox"/>	For the transmitter unwanted emissions shall be measured using following options below:
<input checked="" type="checkbox"/>	Refer as FCC KDB 558074 D01 v03r02, clause 11 for unwanted emissions into non-restricted bands.
<input checked="" type="checkbox"/>	Refer as FCC KDB 558074 D01 v03r02, clause 12 for unwanted emissions into restricted bands.
<input type="checkbox"/>	Refer as FCC KDB 558074 D01 v03r02, clause 12.2.5.1 Option 1 (trace averaging for duty cycle \geq 98%)
<input type="checkbox"/>	Refer as FCC KDB 558074 D01 v03r02, clause 12.2.5.2 Option 2 (trace averaging + duty factor).
<input type="checkbox"/>	Refer as FCC KDB 558074 D01 v03r02, clause 12.2.5.3 Option 3 (Reduced VBW \geq 1/T).
<input checked="" type="checkbox"/>	Refer as ANSI C63.10, clause 4.2.3.2.3 (Reduced VBW). VBW \geq 1/T, where T is pulse time.
<input type="checkbox"/>	Refer as ANSI C63.10, clause 4.2.3.2.4 average value of pulsed emissions.
<input checked="" type="checkbox"/>	Refer as FCC KDB 558074 D01 v03r02, clause 11.3 and 12.2.4 measurement procedure peak limit.
<input checked="" type="checkbox"/>	Refer as FCC KDB 558074 D01 v03r02, clause 12.2.3 measurement procedure Quasi-Peak limit.
<input checked="" type="checkbox"/>	For radiated measurement, refer as FCC KDB 558074 D01 v03r02, clause 12.2.7.
<input checked="" type="checkbox"/>	Refer as ANSI C63.10, clause 6.4 for radiated emissions below 30 MHz and test distance is 3m.
<input checked="" type="checkbox"/>	Refer as ANSI C63.10, clause 6.5 for radiated emissions 30 MHz to 1 GHz and test distance is 3m.
<input checked="" type="checkbox"/>	Refer as ANSI C63.10, clause 6.6 for radiated emissions above 1 GHz and test distance is 3m.

3.6.4 Test Setup

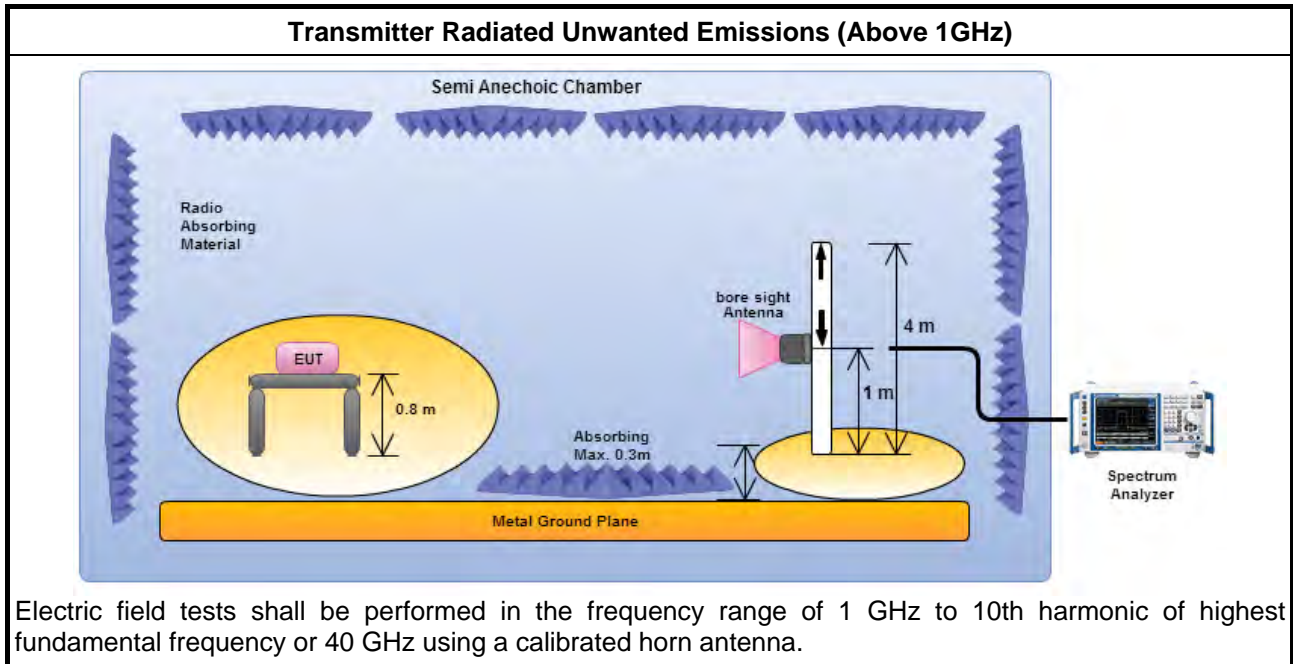
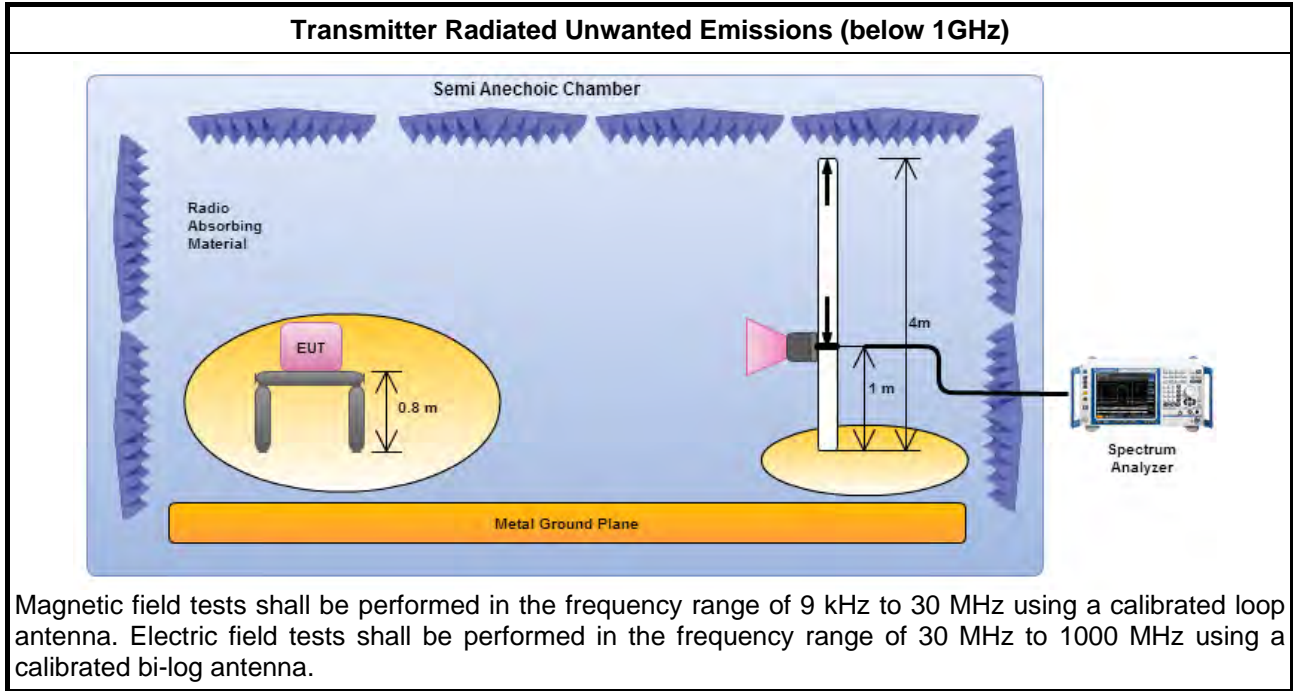

3.6.5 Transmitter Radiated Unwanted Emissions (Below 30MHz)

All amplitude of spurious emissions that are attenuated by more than 20 dB below the permissible value has no need to be reported.

3.6.6 Transmitter Radiated Unwanted Emissions (Below 1GHz)

Transmitter Radiated Unwanted Emissions (Below 1GHz)			
Operating Mode	1	Polarization	V
Operating Function	AC Power & Radio link (Transmit)		

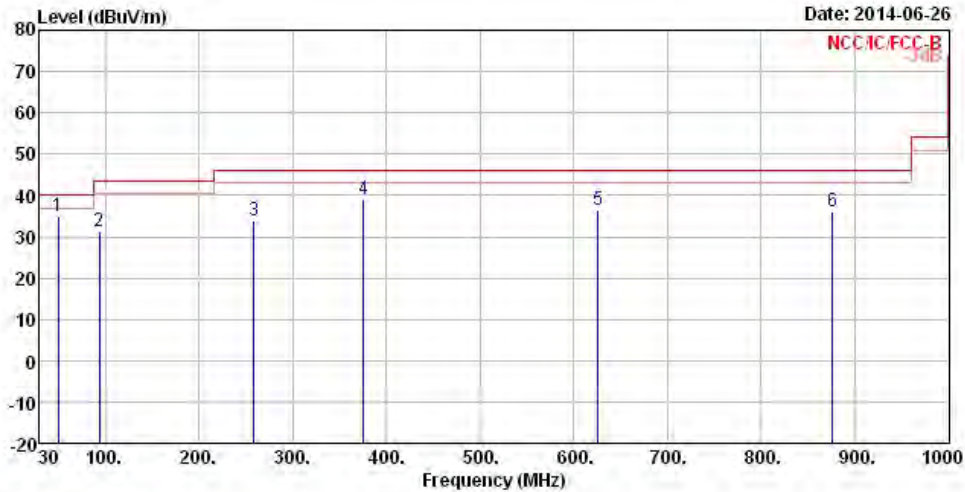

	Freq	Level	Over Limit	Limit Line	ReadAntenna Level	Antenna Factor	Cable Loss	Preamp Factor	Remark	A/Pos	T/Pos
	MHz	dBuV/m	dB	dBuV/m	dBuV	dB/m	dB	dB		cm	deg
1	49.40	34.95	-5.05	40.00	52.51	8.74	1.13	27.43	Peak	---	---
2	94.02	31.40	-12.10	43.50	47.01	10.12	1.53	27.26	Peak	---	---
3	258.92	33.81	-12.19	46.00	44.30	13.72	2.66	26.87	Peak	---	---
4	375.32	39.12	-6.88	46.00	48.24	14.81	3.23	27.16	Peak	---	---
5	625.58	36.52	-9.48	46.00	41.37	18.67	4.25	27.77	Peak	---	---
6	875.84	36.09	-9.91	46.00	37.92	20.47	5.07	27.37	Peak	---	---

Note 1: ">20dB" means spurious emission levels that exceed the level of 20 dB below the applicable limit.
 Note 2: "N/F" means Nothing Found spurious emissions (No spurious emissions were detected.)
 Note 3: Measurement receive antenna polarization: H (Horizontal), V (Vertical)

Transmitter Radiated Unwanted Emissions (Below 1GHz)

Operating Mode	1	Polarization	H
Operating Function	AC Power & Radio link (Transmit)		

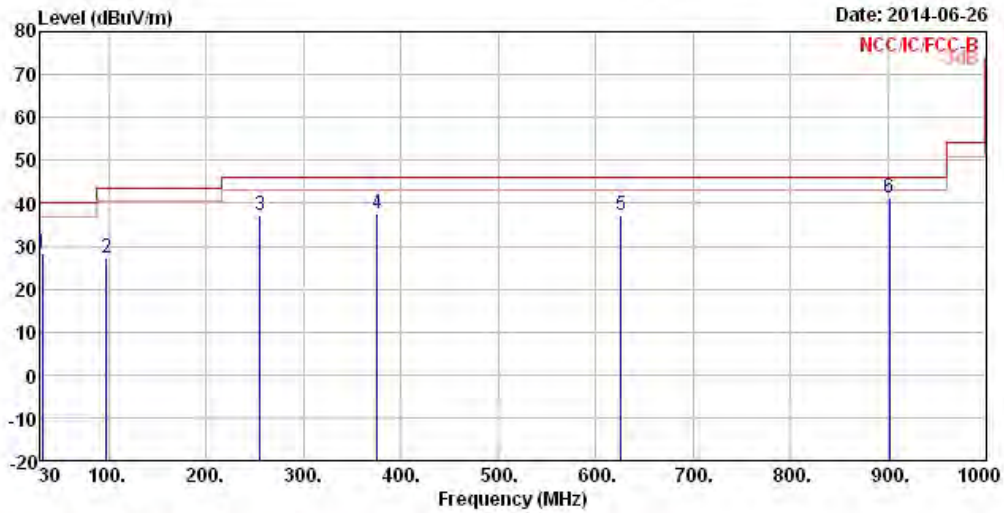

	Freq	Level	Over Limit	Limit Line	ReadAntenna Level	Antenna Factor	Cable Loss	Preamp Factor	Remark	A/Pos	T/Pos
	MHz	dBuV/m	dB	dBuV/m	dBuV	dB/m	dB	dB		cm	deg
1	31.94	28.16	-11.84	40.00	36.88	17.76	0.87	27.35	Peak	---	---
2	97.90	27.12	-16.38	43.50	42.10	10.69	1.57	27.24	Peak	---	---
3	255.04	37.17	-8.83	46.00	48.13	13.28	2.64	26.88	Peak	---	---
4	375.32	37.64	-8.36	46.00	46.76	14.81	3.23	27.16	Peak	---	---
5	625.58	37.12	-8.88	46.00	41.97	18.67	4.25	27.77	Peak	---	---

Note 1: ">20dB" means spurious emission levels that exceed the level of 20 dB below the applicable limit.
 Note 2: "N/F" means Nothing Found spurious emissions (No spurious emissions were detected.)
 Note 3: Measurement receive antenna polarization: H (Horizontal), V (Vertical)



3.6.7 Transmitter Radiated Unwanted Emissions (Above 1GHz)

Transmitter Radiated Unwanted Emissions (Above 1GHz)			
Modulation Mode	11b	Test Freq. (MHz)	2412
N _{TX}	1	Polarization	V

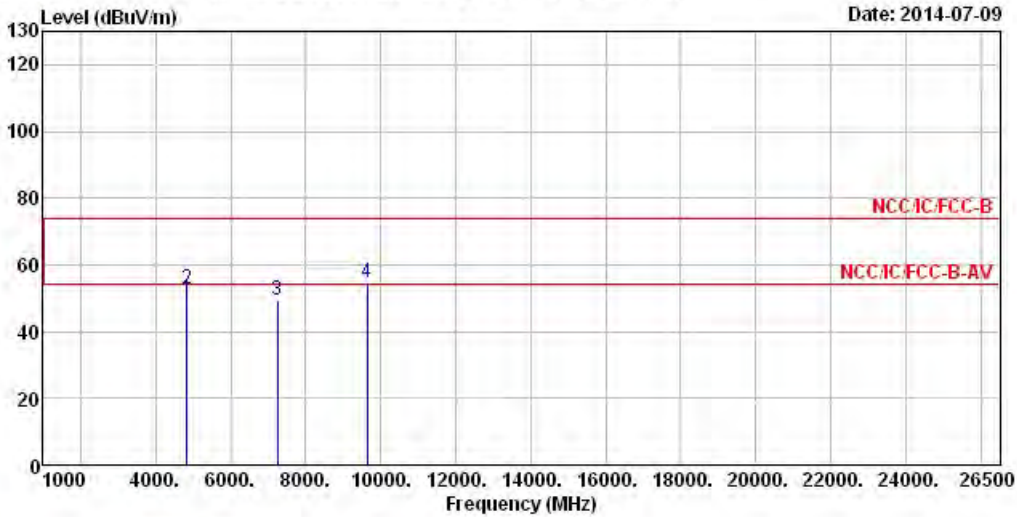

	Freq	Level	Over Limit	Limit Line	ReadAntenna Level	Antenna Factor	Cable Loss	Preamp Factor	Remark	A/Pos	T/Pos
	MHz	dBuV/m	dB	dBuV/m	dBuV	dB/m	dB	dB		cm	deg
1	4824.00	49.50	-4.50	54.00	43.33	32.89	5.71	32.43	Average	0	0
2	4824.00	52.59	-21.41	74.00	46.42	32.89	5.71	32.43	Peak	0	0
3	7236.00	49.54			39.23	35.73	7.23	32.65	Peak	---	---
4	9648.00	54.81			41.53	37.59	8.79	33.10	Peak	---	---

- Note 1: ">20dB" means spurious emission levels that exceed the level of 20 dB below the applicable limit.
- Note 2: "N/F" means Nothing Found spurious emissions (No spurious emissions were detected.)
- Note 3: Measurement receive antenna polarization: H (Horizontal), V (Vertical)
- Note 4: For restricted bands, the peak measurement is fully sufficient, as the max field strength as measured with the Peak-Detector meets the AV-Limit so that the AV level does not need to be reported in addition.
- Note 5: For un-restricted bands, unwanted emissions shall be attenuated by at least 20 dB relative to the maximum measured in-band level (111.57 dBuV/m).
- Note 6: No level of unwanted emissions exceeds the level of the fundamental emission.



Transmitter Radiated Unwanted Emissions (Above 1GHz)

Modulation Mode	11b	Test Freq. (MHz)	2412
N _{TX}	1	Polarization	H

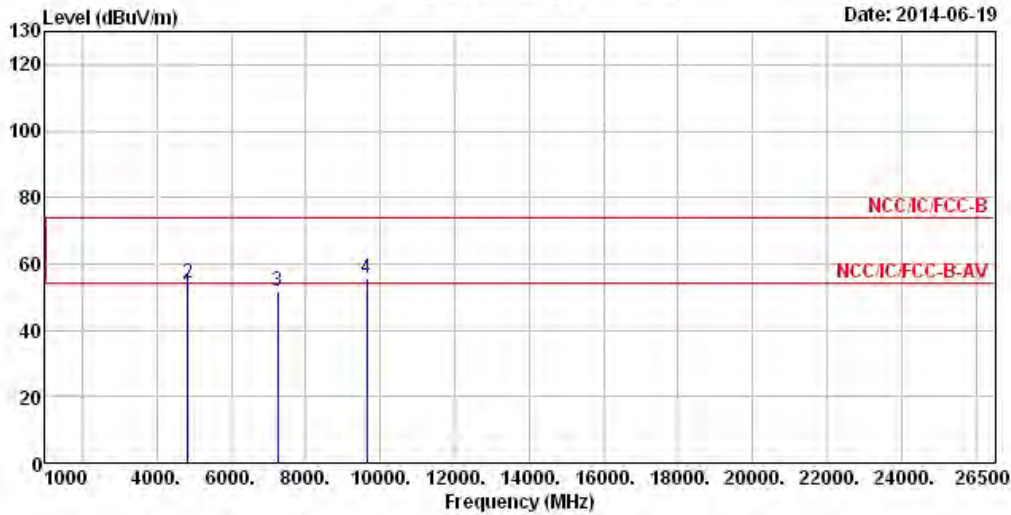

	Freq	Level	Over Limit	Limit Line	ReadAntenna Level	Antenna Factor	Cable Loss	Preamp Factor	Remark	A/Pos	T/Pos
	MHz	dBuV/m	dB	dBuV/m	dBuV	dB/m	dB	dB		cm	deg
1	4824.00	51.01	-2.99	54.00	44.84	32.89	5.71	32.43	Average	---	---
2	4824.00	54.24	-19.76	74.00	48.07	32.89	5.71	32.43	Peak	---	---
3	7236.00	51.76			41.45	35.73	7.23	32.65	Peak	---	---
4	9648.00	55.50			42.22	37.59	8.79	33.10	Peak	---	---

- Note 1: ">20dB" means spurious emission levels that exceed the level of 20 dB below the applicable limit.
- Note 2: "N/F" means Nothing Found spurious emissions (No spurious emissions were detected.)
- Note 3: Measurement receive antenna polarization: H (Horizontal), V (Vertical)
- Note 4: For restricted bands, the peak measurement is fully sufficient, as the max field strength as measured with the Peak-Detector meets the AV-Limit so that the AV level does not need to be reported in addition.
- Note 5: For un-restricted bands, unwanted emissions shall be attenuated by at least 20 dB relative to the maximum measured in-band level (111.57 dBuV/m).
- Note 6: No level of unwanted emissions exceeds the level of the fundamental emission.



Transmitter Radiated Unwanted Emissions (Above 1GHz)

Modulation Mode	11b	Test Freq. (MHz)	2437
N _{TX}	1	Polarization	V

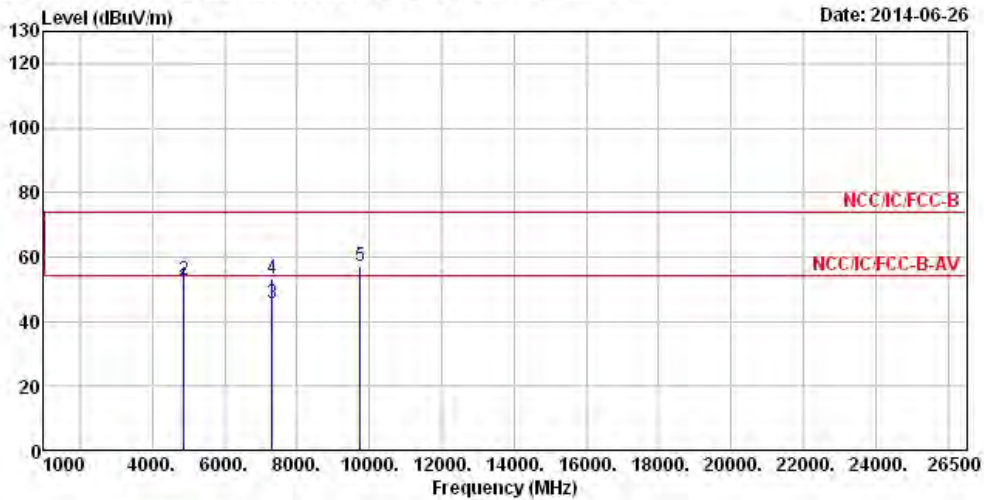

	Freq	Level	Over Limit	Limit Line	ReadAntenna Level	Antenna Factor	Cable Loss	Preamp Factor	Remark	A/Pos	T/Pos
	MHz	dBuV/m	dB	dBuV/m	dBuV	dB/m	dB	dB		cm	deg
1	4874.00	50.79	-3.21	54.00	44.53	32.96	5.72	32.42	Average	---	---
2	4874.00	52.85	-21.15	74.00	46.59	32.96	5.72	32.42	Peak	---	---
3	7311.00	45.62	-8.38	54.00	35.12	35.88	7.28	32.66	Average	---	---
4	7311.00	53.08	-20.92	74.00	42.58	35.88	7.28	32.66	Peak	---	---
5	9748.00	57.24			43.84	37.71	8.77	33.08	Peak	---	---

- Note 1: ">20dB" means spurious emission levels that exceed the level of 20 dB below the applicable limit.
- Note 2: "N/F" means Nothing Found spurious emissions (No spurious emissions were detected.)
- Note 3: Measurement receive antenna polarization: H (Horizontal), V (Vertical)
- Note 4: For restricted bands, the peak measurement is fully sufficient, as the max field strength as measured with the Peak-Detector meets the AV-Limit so that the AV level does not need to be reported in addition.
- Note 5: For un-restricted bands, unwanted emissions shall be attenuated by at least 20 dB relative to the maximum measured in-band level (112.13 dBuV/m).
- Note 6: No level of unwanted emissions exceeds the level of the fundamental emission.



Transmitter Radiated Unwanted Emissions (Above 1GHz)

Modulation Mode	11b	Test Freq. (MHz)	2437
N _{TX}	1	Polarization	H

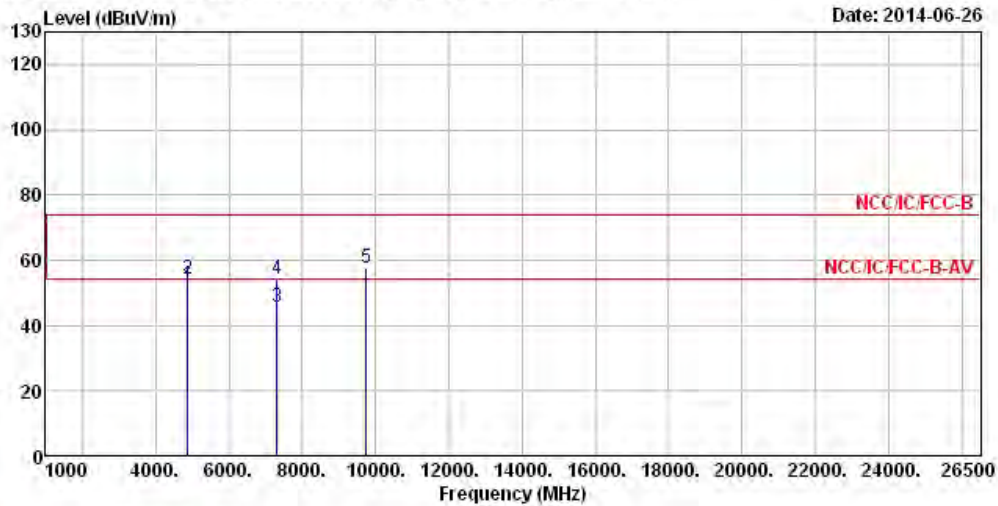

	Freq	Level	Over Limit	Limit Line	ReadAntenna Level	Antenna Factor	Cable Loss	Preamp Factor	Remark	A/Pos	T/Pos
	MHz	dBuV/m	dB	dBuV/m	dBuV	dB/m	dB	dB		cm	deg
1	4874.00	52.33	-1.67	54.00	46.07	32.96	5.72	32.42	Average	---	---
2	4874.00	54.45	-19.55	74.00	48.19	32.96	5.72	32.42	Peak	---	---
3	7311.00	45.50	-8.50	54.00	35.00	35.88	7.28	32.66	Average	---	---
4	7311.00	54.26	-19.74	74.00	43.76	35.88	7.28	32.66	Peak	---	---
5	9748.00	57.53			44.13	37.71	8.77	33.08	Peak	---	---

- Note 1: ">20dB" means spurious emission levels that exceed the level of 20 dB below the applicable limit.
- Note 2: "N/F" means Nothing Found spurious emissions (No spurious emissions were detected.)
- Note 3: Measurement receive antenna polarization: H (Horizontal), V (Vertical)
- Note 4: For restricted bands, the peak measurement is fully sufficient, as the max field strength as measured with the Peak-Detector meets the AV-Limit so that the AV level does not need to be reported in addition.
- Note 5: For un-restricted bands, unwanted emissions shall be attenuated by at least 20 dB relative to the maximum measured in-band level (112.13 dBuV/m).
- Note 6: No level of unwanted emissions exceeds the level of the fundamental emission.



Transmitter Radiated Unwanted Emissions (Above 1GHz)

Modulation Mode	11b	Test Freq. (MHz)	2462
N _{TX}	1	Polarization	V

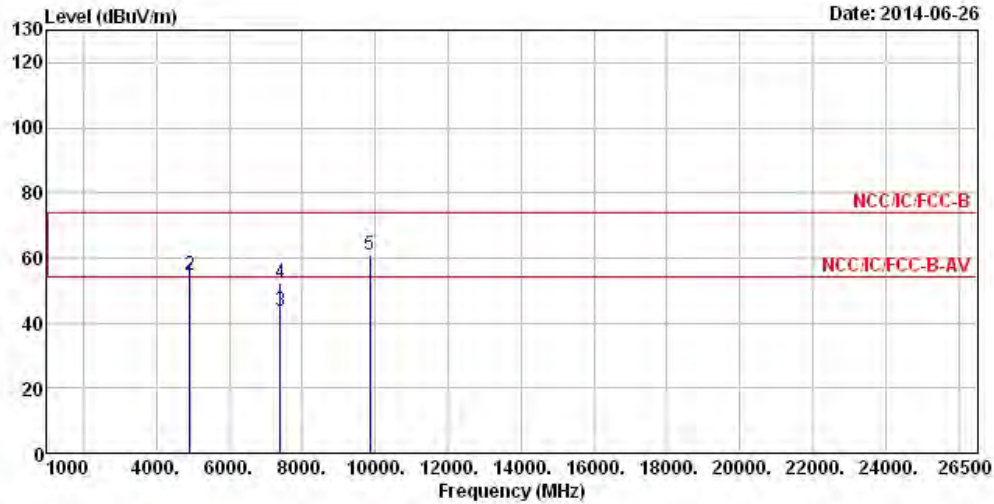

	Freq	Level	Over Limit	Limit Line	ReadAntenna Level	Antenna Factor	Cable Loss	Preamp Factor	Remark	A/Pos	T/Pos
	MHz	dBuV/m	dB	dBuV/m	dBuV	dB/m	dB	dB		cm	deg
1	4924.00	52.23	-1.77	54.00	45.88	33.02	5.74	32.41	Average	---	---
2	4924.00	54.61	-19.39	74.00	48.26	33.02	5.74	32.41	Peak	---	---
3	7386.00	43.67	-10.33	54.00	32.95	36.07	7.34	32.69	Average	---	---
4	7386.00	52.52	-21.48	74.00	41.80	36.07	7.34	32.69	Peak	---	---
5	9848.00	61.05			47.58	37.81	8.74	33.08	Peak	---	---

- Note 1: ">20dB" means spurious emission levels that exceed the level of 20 dB below the applicable limit.
- Note 2: "N/F" means Nothing Found spurious emissions (No spurious emissions were detected.)
- Note 3: Measurement receive antenna polarization: H (Horizontal), V (Vertical)
- Note 4: For restricted bands, the peak measurement is fully sufficient, as the max field strength as measured with the Peak-Detector meets the AV-Limit so that the AV level does not need to be reported in addition.
- Note 5: For un-restricted bands, unwanted emissions shall be attenuated by at least 20 dB relative to the maximum measured in-band level (111.44 dBuV/m).
- Note 6: No level of unwanted emissions exceeds the level of the fundamental emission.



Transmitter Radiated Unwanted Emissions (Above 1GHz)

Modulation Mode	11b	Test Freq. (MHz)	2462
N _{TX}	1	Polarization	H

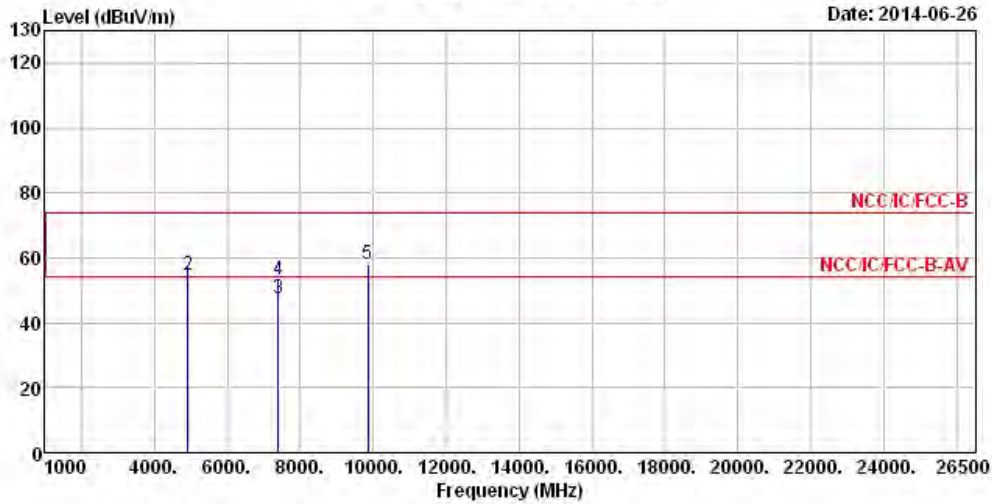

	Freq	Level	Over Limit	Limit Line	ReadAntenna Level	Cable Factor	Preamp Loss	Preamp Factor	Remark	A/Pos	T/Pos
	MHz	dBuV/m	dB	dBuV/m	dBuV	dB/m	dB	dB		cm	deg
1	4924.00	52.05	-1.95	54.00	45.70	33.02	5.74	32.41	Average	---	---
2	4924.00	54.46	-19.54	74.00	48.11	33.02	5.74	32.41	Peak	---	---
3	7386.00	47.61	-6.39	54.00	36.89	36.07	7.34	32.69	Average	---	---
4	7386.00	53.19	-20.81	74.00	42.47	36.07	7.34	32.69	Peak	---	---
5	9848.00	57.94			44.47	37.81	8.74	33.08	Peak	---	---

- Note 1: ">20dB" means spurious emission levels that exceed the level of 20 dB below the applicable limit.
- Note 2: "N/F" means Nothing Found spurious emissions (No spurious emissions were detected.)
- Note 3: Measurement receive antenna polarization: H (Horizontal), V (Vertical)
- Note 4: For restricted bands, the peak measurement is fully sufficient, as the max field strength as measured with the Peak-Detector meets the AV-Limit so that the AV level does not need to be reported in addition.
- Note 5: For un-restricted bands, unwanted emissions shall be attenuated by at least 20 dB relative to the maximum measured in-band level (111.44 dBuV/m).
- Note 6: No level of unwanted emissions exceeds the level of the fundamental emission.



Transmitter Radiated Unwanted Emissions (Above 1GHz)

Modulation Mode	11g	Test Freq. (MHz)	2412
N _{TX}	1	Polarization	V

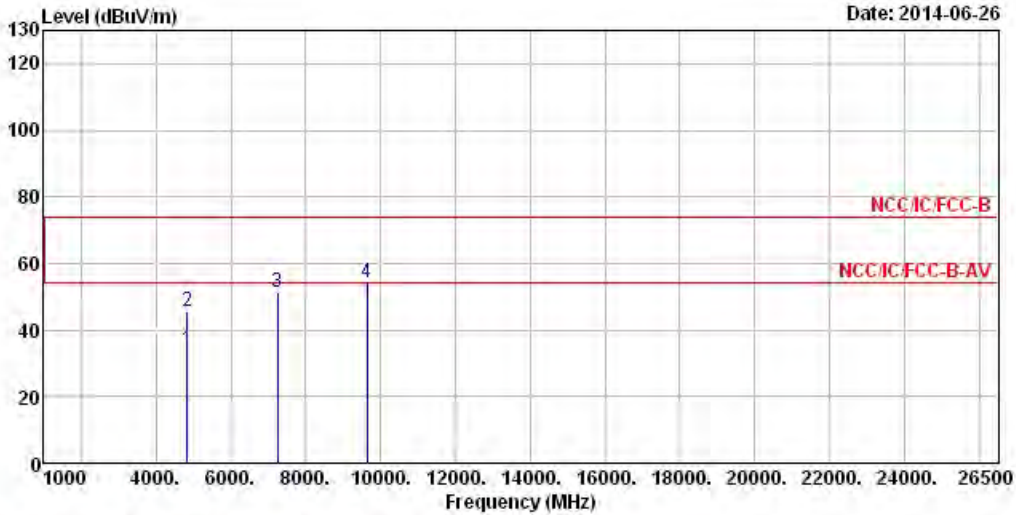

	Freq	Level	Over Limit	Limit Line	ReadAntenna Level	Antenna Factor	Cable Loss	Preamp Factor	Remark	A/Pos	T/Pos
	MHz	dBuV/m	dB	dBuV/m	dBuV	dB/m	dB	dB		cm	deg
1	4824.00	34.14	-19.86	54.00	27.97	32.89	5.71	32.43	Average	---	---
2	4824.00	45.75	-28.25	74.00	39.58	32.89	5.71	32.43	Peak	---	---
3	7236.00	51.47			41.16	35.73	7.23	32.65	Peak	---	---
4	9648.00	54.29			41.01	37.59	8.79	33.10	Peak	---	---

- Note 1: ">20dB" means spurious emission levels that exceed the level of 20 dB below the applicable limit.
- Note 2: "N/F" means Nothing Found spurious emissions (No spurious emissions were detected.)
- Note 3: Measurement receive antenna polarization: H (Horizontal), V (Vertical)
- Note 4: For restricted bands, the peak measurement is fully sufficient, as the max field strength as measured with the Peak-Detector meets the AV-Limit so that the AV level does not need to be reported in addition.
- Note 5: For un-restricted bands, unwanted emissions shall be attenuated by at least 20 dB relative to the maximum measured in-band level (107.82 dBuV/m).
- Note 6: No level of unwanted emissions exceeds the level of the fundamental emission.



Transmitter Radiated Unwanted Emissions (Above 1GHz)

Modulation Mode	11g	Test Freq. (MHz)	2412
N _{TX}	1	Polarization	H

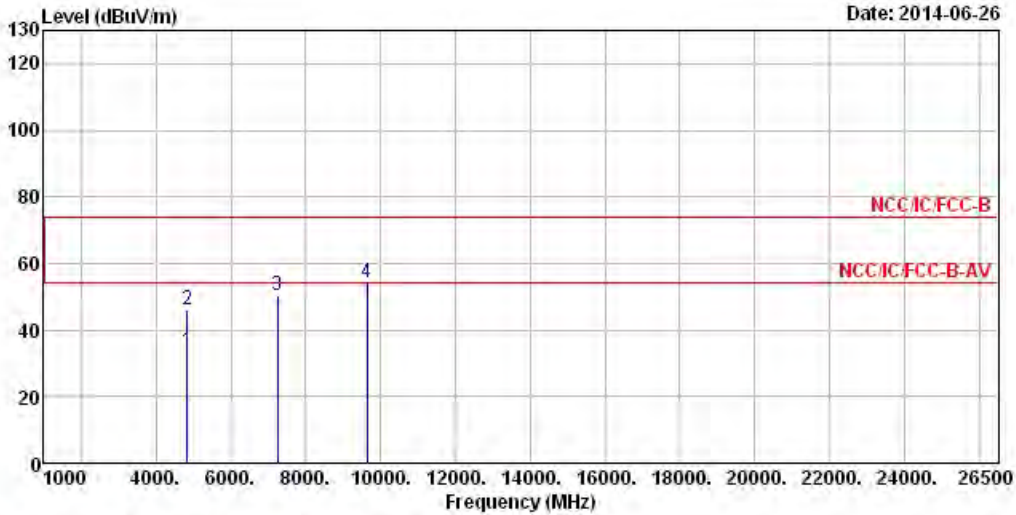

	Freq	Level	Over Limit	Limit Line	ReadAntenna Level	Antenna Factor	Cable Loss	Preamp Factor	Remark	A/Pos	T/Pos
	MHz	dBuV/m	dB	dBuV/m	dBuV	dB/m	dB	dB		cm	deg
1	4824.00	33.69	-20.31	54.00	27.52	32.89	5.71	32.43	Average	---	---
2	4824.00	46.17	-27.83	74.00	40.00	32.89	5.71	32.43	Peak	---	---
3	7236.00	50.60			40.29	35.73	7.23	32.65	Peak	---	---
4	9648.00	54.21			40.93	37.59	8.79	33.10	Peak	---	---

- Note 1: ">20dB" means spurious emission levels that exceed the level of 20 dB below the applicable limit.
- Note 2: "N/F" means Nothing Found spurious emissions (No spurious emissions were detected.)
- Note 3: Measurement receive antenna polarization: H (Horizontal), V (Vertical)
- Note 4: For restricted bands, the peak measurement is fully sufficient, as the max field strength as measured with the Peak-Detector meets the AV-Limit so that the AV level does not need to be reported in addition.
- Note 5: For un-restricted bands, unwanted emissions shall be attenuated by at least 20 dB relative to the maximum measured in-band level (107.82 dBUV/m).
- Note 6: No level of unwanted emissions exceeds the level of the fundamental emission.



Transmitter Radiated Unwanted Emissions (Above 1GHz)

Modulation Mode	11g	Test Freq. (MHz)	2437
N _{TX}	1	Polarization	V

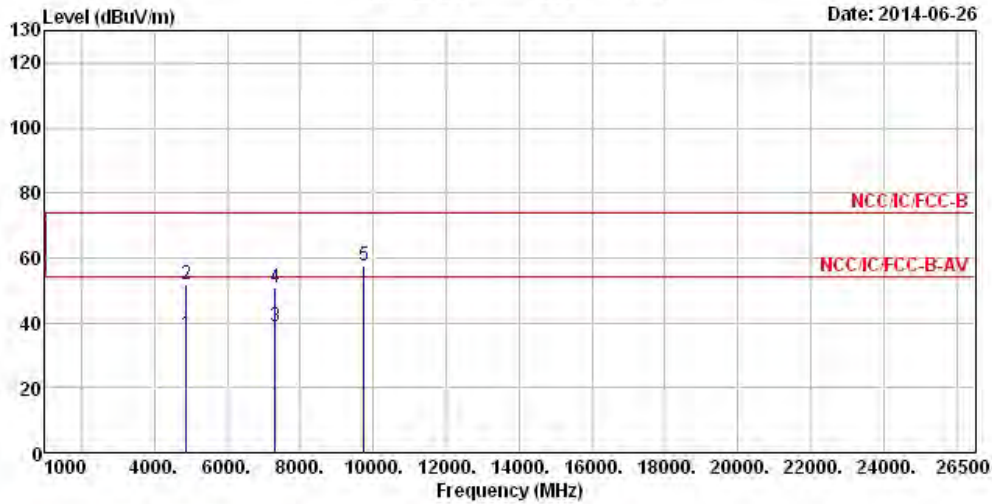

	Freq	Level	Over Limit	Limit Line	ReadAntenna Level	Antenna Factor	Cable Loss	Preamp Factor	Remark	A/Pos	T/Pos
	MHz	dBuV/m	dB	dBuV/m	dBuV	dB/m	dB	dB		cm	deg
1	4874.00	36.46	-17.54	54.00	30.20	32.96	5.72	32.42	Average	---	---
2	4874.00	51.96	-22.04	74.00	45.70	32.96	5.72	32.42	Peak	---	---
3	7311.00	38.62	-15.38	54.00	28.12	35.88	7.28	32.66	Average	---	---
4	7311.00	51.05	-22.95	74.00	40.55	35.88	7.28	32.66	Peak	---	---
5	9748.00	57.65			44.25	37.71	8.77	33.08	Peak	---	---

- Note 1: ">20dB" means spurious emission levels that exceed the level of 20 dB below the applicable limit.
- Note 2: "N/F" means Nothing Found spurious emissions (No spurious emissions were detected.)
- Note 3: Measurement receive antenna polarization: H (Horizontal), V (Vertical)
- Note 4: For restricted bands, the peak measurement is fully sufficient, as the max field strength as measured with the Peak-Detector meets the AV-Limit so that the AV level does not need to be reported in addition.
- Note 5: For un-restricted bands, unwanted emissions shall be attenuated by at least 20 dB relative to the maximum measured in-band level (114.74 dBuV/m).
- Note 6: No level of unwanted emissions exceeds the level of the fundamental emission.



Transmitter Radiated Unwanted Emissions (Above 1GHz)

Modulation Mode	11g	Test Freq. (MHz)	2437
N _{TX}	1	Polarization	H

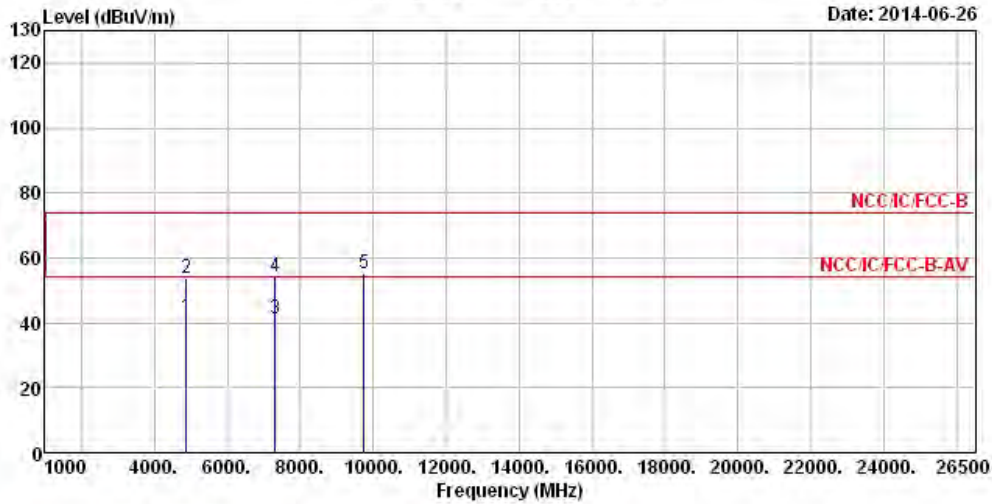

	Freq	Level	Over Limit	Limit Line	ReadAntenna Level	Cable Factor	Preamp Loss	Preamp Factor	Remark	A/Pos	T/Pos
	MHz	dBuV/m	dB	dBuV/m	dBuV	dB/m	dB	dB		cm	deg
1	4874.00	41.58	-12.42	54.00	35.32	32.96	5.72	32.42	Average	---	---
2	4874.00	53.73	-20.27	74.00	47.47	32.96	5.72	32.42	Peak	---	---
3	7311.00	41.48	-12.52	54.00	30.98	35.88	7.28	32.66	Average	---	---
4	7311.00	54.19	-19.81	74.00	43.69	35.88	7.28	32.66	Peak	---	---
5	9748.00	55.15			41.75	37.71	8.77	33.08	Peak	---	---

- Note 1: ">20dB" means spurious emission levels that exceed the level of 20 dB below the applicable limit.
- Note 2: "N/F" means Nothing Found spurious emissions (No spurious emissions were detected.)
- Note 3: Measurement receive antenna polarization: H (Horizontal), V (Vertical)
- Note 4: For restricted bands, the peak measurement is fully sufficient, as the max field strength as measured with the Peak-Detector meets the AV-Limit so that the AV level does not need to be reported in addition.
- Note 5: For un-restricted bands, unwanted emissions shall be attenuated by at least 20 dB relative to the maximum measured in-band level (114.74 dBuV/m).
- Note 6: No level of unwanted emissions exceeds the level of the fundamental emission.



Transmitter Radiated Unwanted Emissions (Above 1GHz)

Modulation Mode	11g	Test Freq. (MHz)	2462
N _{TX}	1	Polarization	V

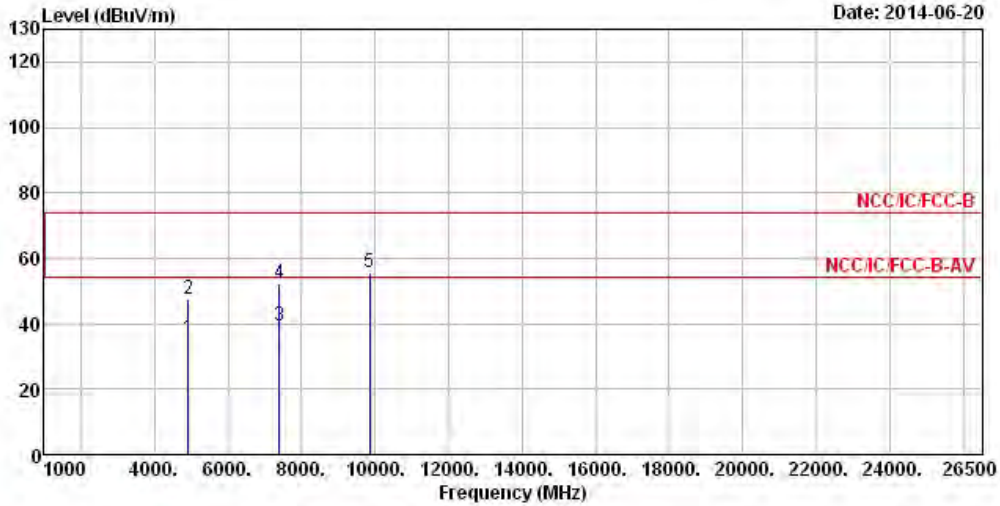

	Freq	Level	Over Limit	Limit Line	ReadAntenna Level	Antenna Factor	Cable Loss	Preamp Factor	Remark	A/Pos	T/Pos
	MHz	dBuV/m	dB	dBuV/m	dBuV	dB/m	dB	dB		cm	deg
1	4924.00	35.49	-18.51	54.00	29.14	33.02	5.74	32.41	Average	---	---
2	4924.00	47.44	-26.56	74.00	41.09	33.02	5.74	32.41	Peak	---	---
3	7386.00	39.23	-14.77	54.00	28.51	36.07	7.34	32.69	Average	---	---
4	7386.00	52.15	-21.85	74.00	41.43	36.07	7.34	32.69	Peak	---	---
5	9848.00	55.54			42.07	37.81	8.74	33.08	Peak	---	---

- Note 1: ">20dB" means spurious emission levels that exceed the level of 20 dB below the applicable limit.
- Note 2: "N/F" means Nothing Found spurious emissions (No spurious emissions were detected.)
- Note 3: Measurement receive antenna polarization: H (Horizontal), V (Vertical)
- Note 4: For restricted bands, the peak measurement is fully sufficient, as the max field strength as measured with the Peak-Detector meets the AV-Limit so that the AV level does not need to be reported in addition.
- Note 5: For un-restricted bands, unwanted emissions shall be attenuated by at least 20 dB relative to the maximum measured in-band level (107.56 dBuV/m).
- Note 6: No level of unwanted emissions exceeds the level of the fundamental emission.



Transmitter Radiated Unwanted Emissions (Above 1GHz)

Modulation Mode	11g	Test Freq. (MHz)	2462
N _{TX}	1	Polarization	H

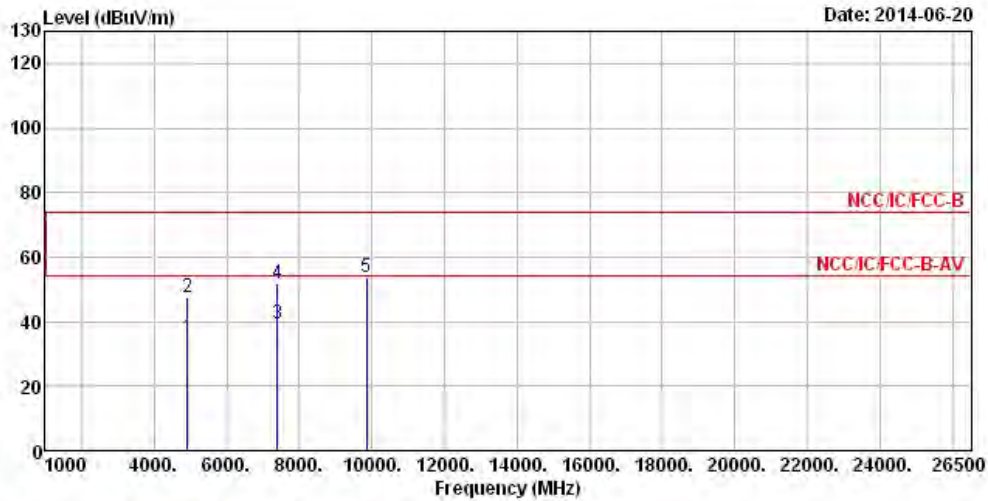

	Freq	Level	Over Limit	Limit Line	ReadAntenna Level	Antenna Factor	Cable Loss	Preamp Factor	Remark	A/Pos	T/Pos
	MHz	dBuV/m	dB	dBuV/m	dBuV	dB/m	dB	dB		cm	deg
1	4924.00	34.92	-19.08	54.00	28.57	33.02	5.74	32.41	Average	---	---
2	4924.00	47.47	-26.53	74.00	41.12	33.02	5.74	32.41	Peak	---	---
3	7386.00	39.40	-14.60	54.00	28.68	36.07	7.34	32.69	Average	---	---
4	7386.00	51.84	-22.16	74.00	41.12	36.07	7.34	32.69	Peak	---	---
5	9848.00	53.92			40.45	37.81	8.74	33.08	Peak	---	---

- Note 1: ">20dB" means spurious emission levels that exceed the level of 20 dB below the applicable limit.
- Note 2: "N/F" means Nothing Found spurious emissions (No spurious emissions were detected.)
- Note 3: Measurement receive antenna polarization: H (Horizontal), V (Vertical)
- Note 4: For restricted bands, the peak measurement is fully sufficient, as the max field strength as measured with the Peak-Detector meets the AV-Limit so that the AV level does not need to be reported in addition.
- Note 5: For un-restricted bands, unwanted emissions shall be attenuated by at least 20 dB relative to the maximum measured in-band level (107.56 dBuV/m).
- Note 6: No level of unwanted emissions exceeds the level of the fundamental emission.



Transmitter Radiated Unwanted Emissions (Above 1GHz)

Modulation Mode	HT20	Test Freq. (MHz)	2412
N _{TX}	2	Polarization	V

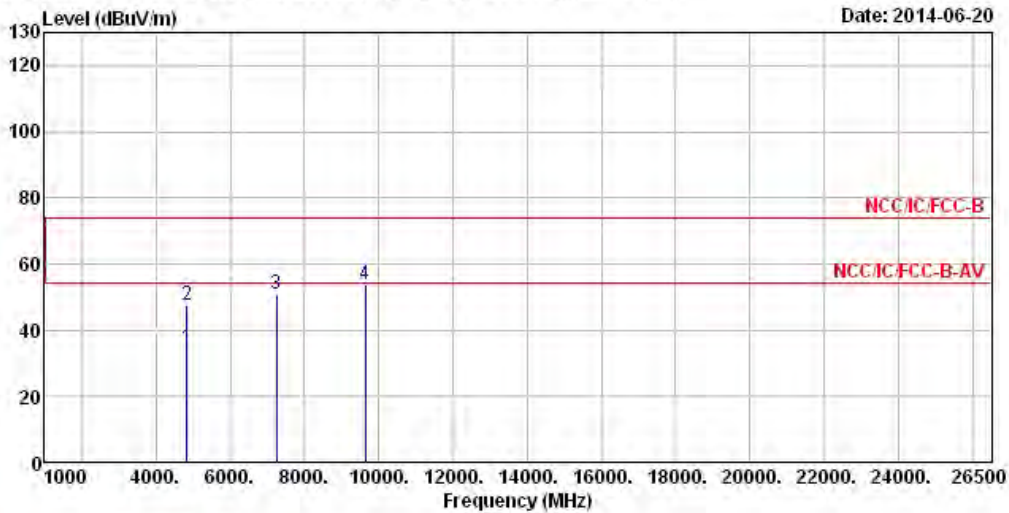

	Freq	Level	Over Limit	Limit Line	ReadAntenna Level	Antenna Factor	Cable Loss	Preamp Factor	Remark	A/Pos	T/Pos
	MHz	dBuV/m	dB	dBuV/m	dBuV	dB/m	dB	dB		cm	deg
1	4824.00	34.43	-19.57	54.00	28.26	32.89	5.71	32.43	Average	---	---
2	4824.00	47.49	-26.51	74.00	41.14	33.02	5.74	32.41	Peak	---	---
3	7236.00	50.93			40.62	35.73	7.23	32.65	Peak	---	---
4	9648.00	53.77			40.51	37.57	8.79	33.10	Peak	---	---

- Note 1: ">20dB" means spurious emission levels that exceed the level of 20 dB below the applicable limit.
- Note 2: "N/F" means Nothing Found spurious emissions (No spurious emissions were detected.)
- Note 3: Measurement receive antenna polarization: H (Horizontal), V (Vertical)
- Note 4: For restricted bands, the peak measurement is fully sufficient, as the max field strength as measured with the Peak-Detector meets the AV-Limit so that the AV level does not need to be reported in addition.
- Note 5: For un-restricted bands, unwanted emissions shall be attenuated by at least 20 dB relative to the maximum measured in-band level (108.73 dBuV/m).
- Note 6: No level of unwanted emissions exceeds the level of the fundamental emission.



Transmitter Radiated Unwanted Emissions (Above 1GHz)

Modulation Mode	HT20	Test Freq. (MHz)	2412
N _{TX}	2	Polarization	H

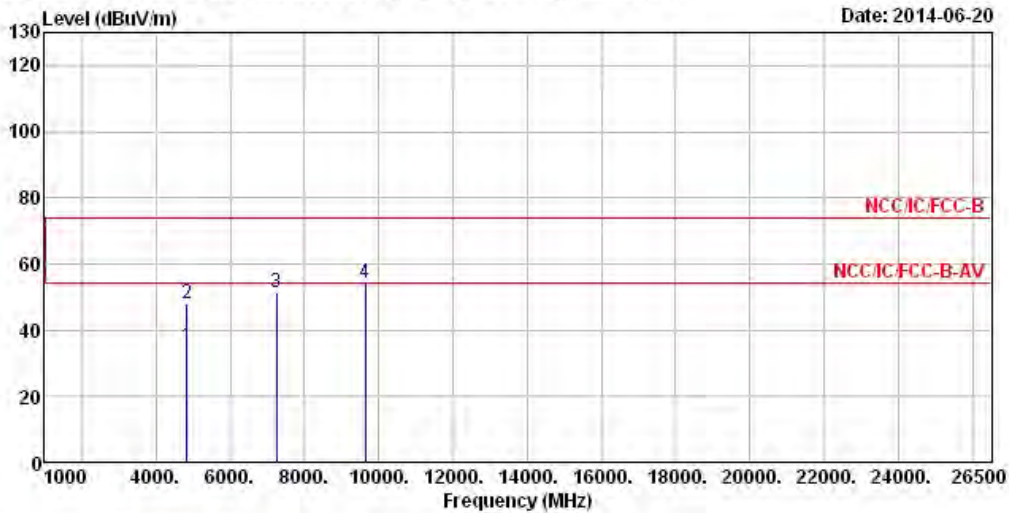

	Freq	Level	Over Limit	Limit Line	ReadAntenna Level	Antenna Factor	Cable Loss	Preamp Factor	Remark	A/Pos	T/Pos
	MHz	dBuV/m	dB	dBuV/m	dBuV	dB/m	dB	dB		cm	deg
1	4824.00	35.16	-18.84	54.00	28.99	32.89	5.71	32.43	Average	---	---
2	4824.00	47.75	-26.25	74.00	41.58	32.89	5.71	32.43	Peak	---	---
3	7236.00	51.47			41.16	35.73	7.23	32.65	Peak	---	---
4	9648.00	54.31			41.03	37.59	8.79	33.10	Peak	---	---

- Note 1: ">20dB" means spurious emission levels that exceed the level of 20 dB below the applicable limit.
- Note 2: "N/F" means Nothing Found spurious emissions (No spurious emissions were detected.)
- Note 3: Measurement receive antenna polarization: H (Horizontal), V (Vertical)
- Note 4: For restricted bands, the peak measurement is fully sufficient, as the max field strength as measured with the Peak-Detector meets the AV-Limit so that the AV level does not need to be reported in addition.
- Note 5: For un-restricted bands, unwanted emissions shall be attenuated by at least 20 dB relative to the maximum measured in-band level (108.73 dBuV/m).
- Note 6: No level of unwanted emissions exceeds the level of the fundamental emission.



Transmitter Radiated Unwanted Emissions (Above 1GHz)

Modulation Mode	HT20	Test Freq. (MHz)	2437
N _{TX}	2	Polarization	V

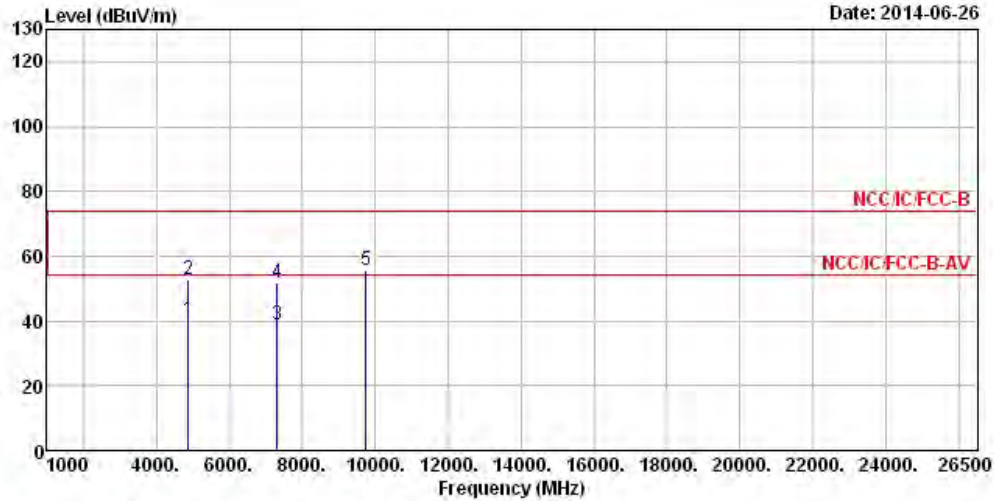

	Freq	Level	Over Limit	Limit Line	ReadAntenna Level	Antenna Factor	Cable Loss	Preamp Factor	Remark	A/Pos	T/Pos
	MHz	dBuV/m	dB	dBuV/m	dBuV	dB/m	dB	dB		cm	deg
1	4874.00	40.13	-13.87	54.00	33.87	32.96	5.72	32.42	Average	---	---
2	4874.00	52.60	-21.40	74.00	46.34	32.96	5.72	32.42	Peak	---	---
3	7311.00	39.03	-14.97	54.00	28.53	35.88	7.28	32.66	Average	---	---
4	7311.00	51.60	-22.40	74.00	41.10	35.88	7.28	32.66	Peak	---	---
5	9748.00	55.57			42.17	37.71	8.77	33.08	Peak	---	---

- Note 1: ">20dB" means spurious emission levels that exceed the level of 20 dB below the applicable limit.
- Note 2: "N/F" means Nothing Found spurious emissions (No spurious emissions were detected.)
- Note 3: Measurement receive antenna polarization: H (Horizontal), V (Vertical)
- Note 4: For restricted bands, the peak measurement is fully sufficient, as the max field strength as measured with the Peak-Detector meets the AV-Limit so that the AV level does not need to be reported in addition.
- Note 5: For un-restricted bands, unwanted emissions shall be attenuated by at least 20 dB relative to the maximum measured in-band level (117.68 dBuV/m).
- Note 6: No level of unwanted emissions exceeds the level of the fundamental emission.



Transmitter Radiated Unwanted Emissions (Above 1GHz)

Modulation Mode	HT20	Test Freq. (MHz)	2437
N _{TX}	2	Polarization	H

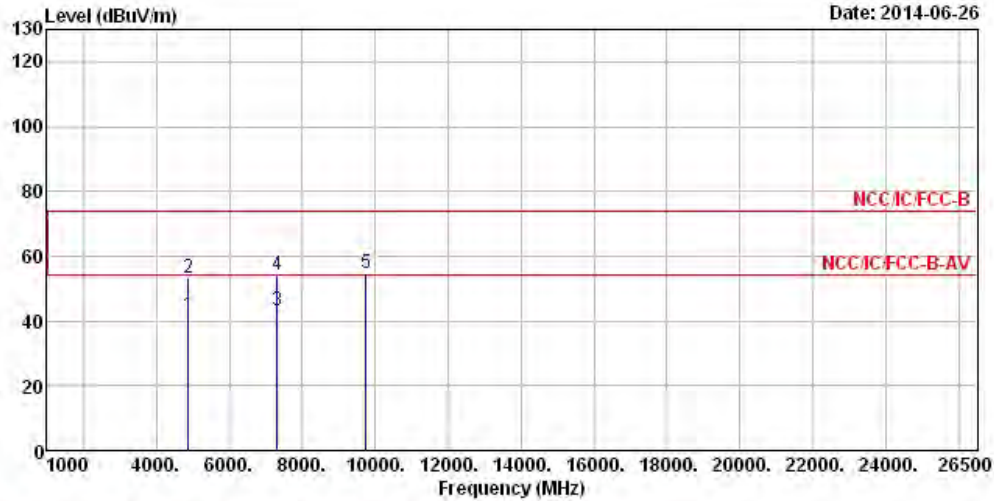

	Freq	Level	Over Limit	Limit Line	ReadAntenna Level	Antenna Factor	Cable Loss	Preamp Factor	Remark	A/Pos	T/Pos
	MHz	dBuV/m	dB	dBuV/m	dBuV	dB/m	dB	dB		cm	deg
1	4874.00	41.76	-12.24	54.00	35.50	32.96	5.72	32.42	Average	---	---
2	4874.00	53.30	-20.70	74.00	47.04	32.96	5.72	32.42	Peak	---	---
3	7311.00	43.28	-10.72	54.00	32.78	35.88	7.28	32.66	Average	---	---
4	7311.00	54.43	-19.57	74.00	43.93	35.88	7.28	32.66	Peak	---	---
5	9748.00	54.64			41.24	37.71	8.77	33.08	Peak	---	---

- Note 1: ">20dB" means spurious emission levels that exceed the level of 20 dB below the applicable limit.
- Note 2: "N/F" means Nothing Found spurious emissions (No spurious emissions were detected.)
- Note 3: Measurement receive antenna polarization: H (Horizontal), V (Vertical)
- Note 4: For restricted bands, the peak measurement is fully sufficient, as the max field strength as measured with the Peak-Detector meets the AV-Limit so that the AV level does not need to be reported in addition.
- Note 5: For un-restricted bands, unwanted emissions shall be attenuated by at least 20 dB relative to the maximum measured in-band level 117.68 dBuV/m).
- Note 6: No level of unwanted emissions exceeds the level of the fundamental emission.



Transmitter Radiated Unwanted Emissions (Above 1GHz)

Modulation Mode	HT20	Test Freq. (MHz)	2462
N _{TX}	2	Polarization	V

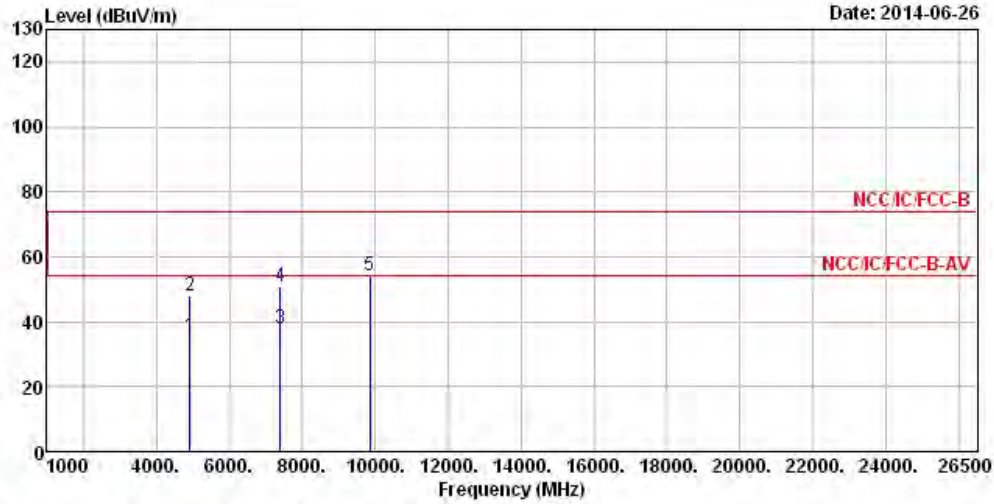

	Freq	Level	Over Limit	Limit Line	ReadAntenna Level	Antenna Factor	Cable Loss	Preamp Factor	Remark	A/Pos	T/Pos
	MHz	dBuV/m	dB	dBuV/m	dBuV	dB/m	dB	dB		cm	deg
1	4924.00	35.34	-18.66	54.00	28.99	33.02	5.74	32.41	Average	---	---
2	4924.00	47.86	-26.14	74.00	41.51	33.02	5.74	32.41	Peak	---	---
3	7386.00	37.97	-16.03	54.00	27.25	36.07	7.34	32.69	Average	---	---
4	7386.00	50.83	-23.17	74.00	40.11	36.07	7.34	32.69	Peak	---	---
5	9848.00	54.37			40.90	37.81	8.74	33.08	Peak	---	---

- Note 1: ">20dB" means spurious emission levels that exceed the level of 20 dB below the applicable limit.
- Note 2: "N/F" means Nothing Found spurious emissions (No spurious emissions were detected.)
- Note 3: Measurement receive antenna polarization: H (Horizontal), V (Vertical)
- Note 4: For restricted bands, the peak measurement is fully sufficient, as the max field strength as measured with the Peak-Detector meets the AV-Limit so that the AV level does not need to be reported in addition.
- Note 5: For un-restricted bands, unwanted emissions shall be attenuated by at least 20 dB relative to the maximum measured in-band level (107.61 dBuV/m).
- Note 6: No level of unwanted emissions exceeds the level of the fundamental emission.



Transmitter Radiated Unwanted Emissions (Above 1GHz)

Modulation Mode	HT20	Test Freq. (MHz)	2462
N _{TX}	2	Polarization	H

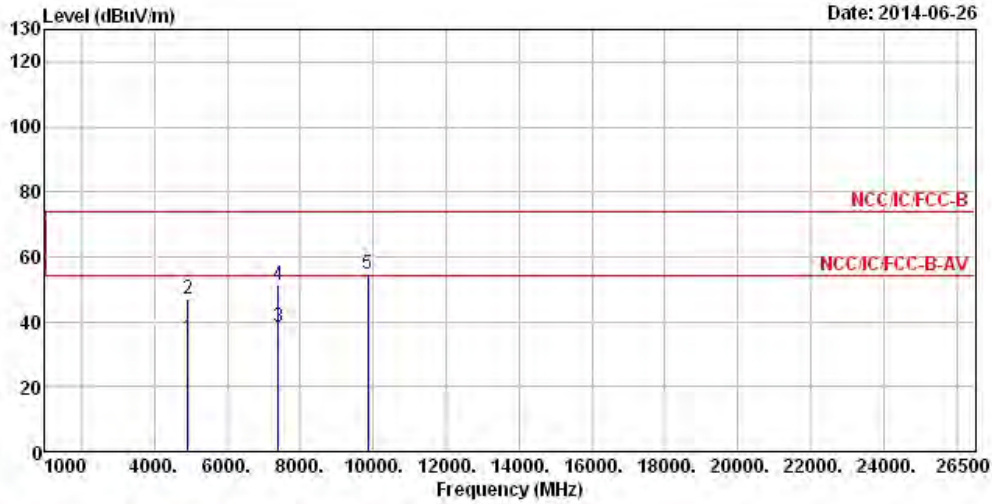

	Freq	Level	Over Limit	Limit Line	ReadAntenna Level	Antenna Factor	Cable Loss	Preamp Factor	Remark	A/Pos	T/Pos
	MHz	dBuV/m	dB	dBuV/m	dBuV	dB/m	dB	dB		cm	deg
1	4924.00	34.88	-19.12	54.00	28.53	33.02	5.74	32.41	Average	---	---
2	4924.00	47.00	-27.00	74.00	40.65	33.02	5.74	32.41	Peak	---	---
3	7386.00	38.29	-15.71	54.00	27.57	36.07	7.34	32.69	Average	---	---
4	7386.00	51.34	-22.66	74.00	40.62	36.07	7.34	32.69	Peak	---	---
5	9848.00	54.64			41.17	37.81	8.74	33.08	Peak	---	---

- Note 1: ">20dB" means spurious emission levels that exceed the level of 20 dB below the applicable limit.
- Note 2: "N/F" means Nothing Found spurious emissions (No spurious emissions were detected.)
- Note 3: Measurement receive antenna polarization: H (Horizontal), V (Vertical)
- Note 4: For restricted bands, the peak measurement is fully sufficient, as the max field strength as measured with the Peak-Detector meets the AV-Limit so that the AV level does not need to be reported in addition.
- Note 5: For un-restricted bands, unwanted emissions shall be attenuated by at least 20 dB relative to the maximum measured in-band level (107.61 dBuV/m).
- Note 6: No level of unwanted emissions exceeds the level of the fundamental emission.



Transmitter Radiated Unwanted Emissions (Above 1GHz)

Modulation Mode	HT40	Test Freq. (MHz)	2422
N _{TX}	2	Polarization	V

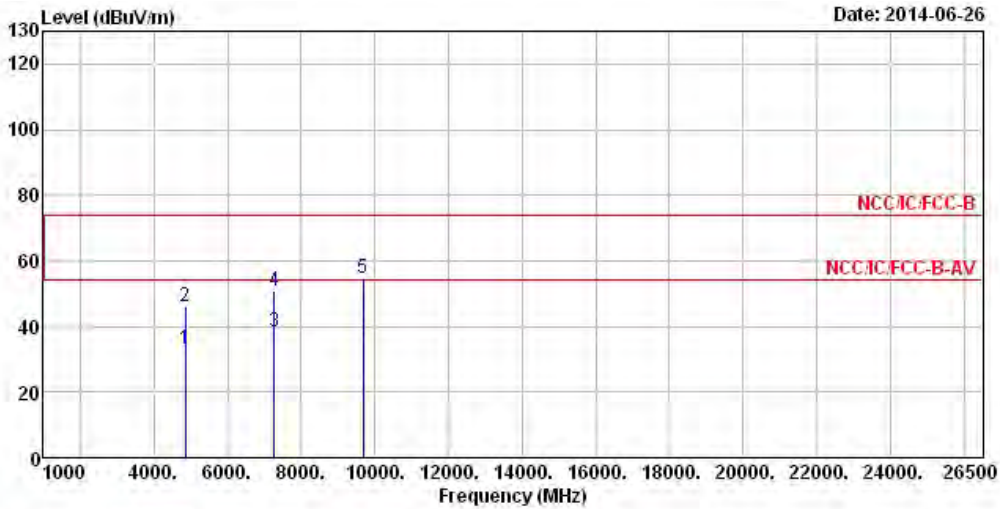

	Freq	Level	Over Limit	Limit Line	ReadAntenna Level	Cable Loss	Preamp Factor	Remark	A/Pos	T/Pos
	MHz	dBuV/m	dB	dBuV/m	dBuV	dB/m	dB	dB	cm	deg
1	4844.00	32.89	-21.11	54.00	26.69	32.91	5.72	32.43 Average	---	---
2	4844.00	46.05	-27.95	74.00	39.85	32.91	5.72	32.43 Peak	---	---
3	7266.00	38.20	-15.80	54.00	27.80	35.81	7.25	32.66 Average	---	---
4	7266.00	50.68	-23.32	74.00	40.28	35.81	7.25	32.66 Peak	---	---
5	9688.00	54.92			41.60	37.63	8.78	33.09 Peak	---	---

- Note 1: ">20dB" means spurious emission levels that exceed the level of 20 dB below the applicable limit.
- Note 2: "N/F" means Nothing Found spurious emissions (No spurious emissions were detected.)
- Note 3: Measurement receive antenna polarization: H (Horizontal), V (Vertical)
- Note 4: For restricted bands, the peak measurement is fully sufficient, as the max field strength as measured with the Peak-Detector meets the AV-Limit so that the AV level does not need to be reported in addition.
- Note 5: For un-restricted bands, unwanted emissions shall be attenuated by at least 20 dB relative to the maximum measured in-band level (105.66 dBuV/m).
- Note 6: No level of unwanted emissions exceeds the level of the fundamental emission.



Transmitter Radiated Unwanted Emissions (Above 1GHz)

Modulation Mode	HT40	Test Freq. (MHz)	2422
N _{TX}	2	Polarization	H

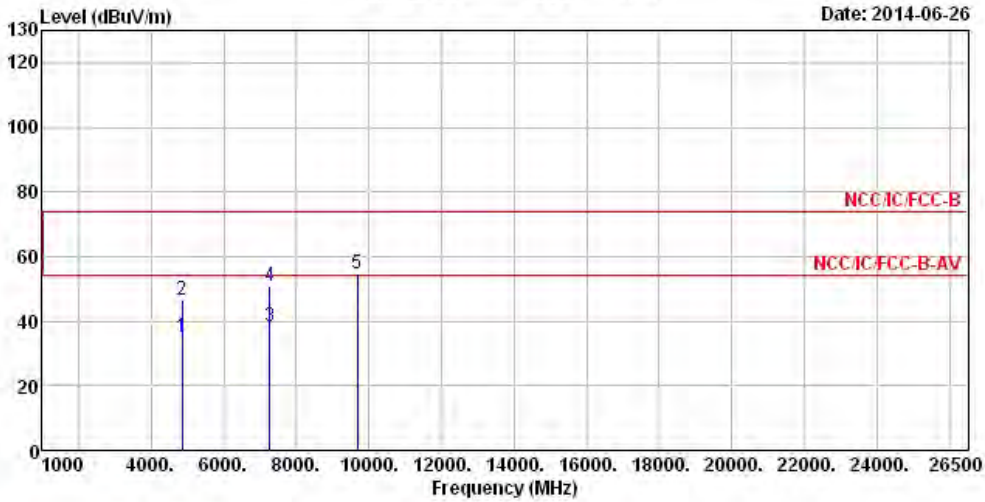

	Freq	Level	Over Limit	Limit Line	ReadAntenna Level	Antenna Factor	Cable Loss	Preamp Factor	Remark	A/Pos	T/Pos
	MHz	dBuV/m	dB	dBuV/m	dBuV	dB/m	dB	dB		cm	deg
1	4844.00	35.16	-18.84	54.00	28.96	32.91	5.72	32.43	Average	---	---
2	4844.00	46.40	-27.60	74.00	40.20	32.91	5.72	32.43	Peak	---	---
3	7266.00	38.35	-15.65	54.00	27.95	35.81	7.25	32.66	Average	---	---
4	7266.00	50.77	-23.23	74.00	40.37	35.81	7.25	32.66	Peak	---	---
5	9688.00	54.54			41.22	37.63	8.78	33.09	Peak	---	---

- Note 1: ">20dB" means spurious emission levels that exceed the level of 20 dB below the applicable limit.
- Note 2: "N/F" means Nothing Found spurious emissions (No spurious emissions were detected.)
- Note 3: Measurement receive antenna polarization: H (Horizontal), V (Vertical)
- Note 4: For restricted bands, the peak measurement is fully sufficient, as the max field strength as measured with the Peak-Detector meets the AV-Limit so that the AV level does not need to be reported in addition.
- Note 5: For un-restricted bands, unwanted emissions shall be attenuated by at least 20 dB relative to the maximum measured in-band level (105.66 dBuV/m).
- Note 6: No level of unwanted emissions exceeds the level of the fundamental emission.



Transmitter Radiated Unwanted Emissions (Above 1GHz)

Modulation Mode	HT40	Test Freq. (MHz)	2437
N _{TX}	2	Polarization	V

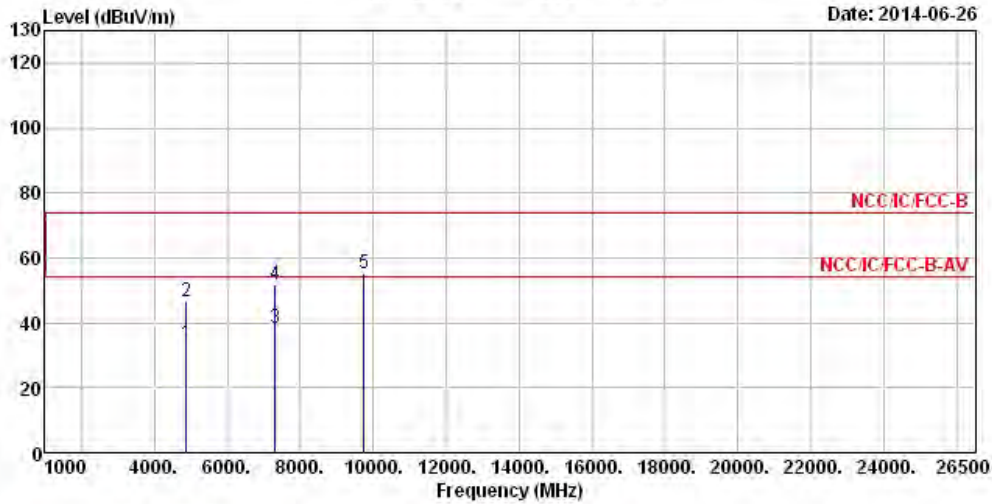

	Freq	Level	Over Limit	Limit Line	ReadAntenna Level	Cable Factor	Preamp Loss	Preamp Factor	Remark	A/Pos	T/Pos
	MHz	dBuV/m	dB	dBuV/m	dBuV	dB/m	dB	dB		cm	deg
1	4874.00	33.49	-20.51	54.00	27.23	32.96	5.72	32.42	Average	---	---
2	4874.00	46.52	-27.48	74.00	40.26	32.96	5.72	32.42	Peak	---	---
3	7311.00	38.39	-15.61	54.00	27.89	35.88	7.28	32.66	Average	---	---
4	7311.00	52.00	-22.00	74.00	41.50	35.88	7.28	32.66	Peak	---	---
5	9748.00	55.01			41.61	37.71	8.77	33.08	Peak	---	---

- Note 1: ">20dB" means spurious emission levels that exceed the level of 20 dB below the applicable limit.
- Note 2: "N/F" means Nothing Found spurious emissions (No spurious emissions were detected.)
- Note 3: Measurement receive antenna polarization: H (Horizontal), V (Vertical)
- Note 4: For restricted bands, the peak measurement is fully sufficient, as the max field strength as measured with the Peak-Detector meets the AV-Limit so that the AV level does not need to be reported in addition.
- Note 5: For un-restricted bands, unwanted emissions shall be attenuated by at least 20 dB relative to the maximum measured in-band level (109.19 dBuV/m).
- Note 6: No level of unwanted emissions exceeds the level of the fundamental emission.



Transmitter Radiated Unwanted Emissions (Above 1GHz)

Modulation Mode	HT40	Test Freq. (MHz)	2437
N _{TX}	2	Polarization	H

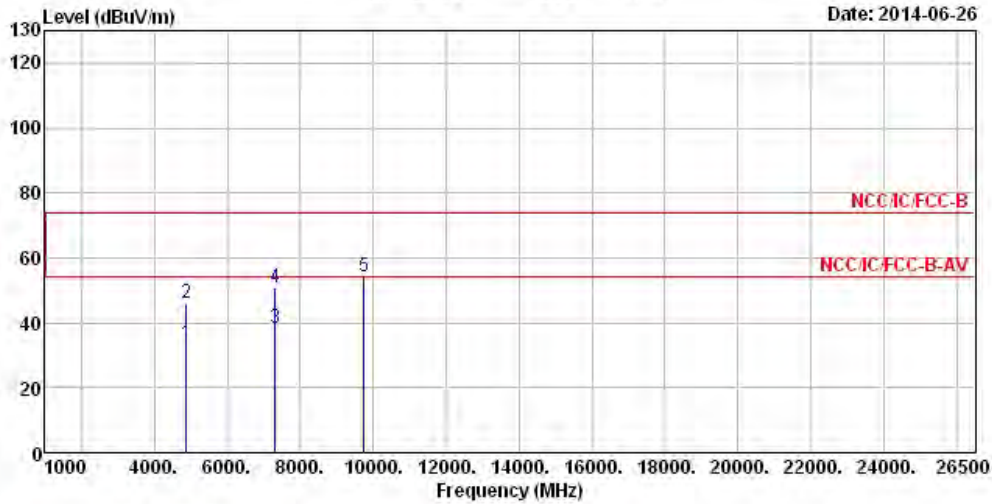

	Freq	Level	Over Limit	Limit Line	ReadAntenna Level	Antenna Factor	Cable Loss	Preamp Factor	Remark	A/Pos	T/Pos
	MHz	dBuV/m	dB	dBuV/m	dBuV	dB/m	dB	dB		cm	deg
1	4874.00	33.47	-20.53	54.00	27.21	32.96	5.72	32.42	Average	---	---
2	4874.00	46.28	-27.72	74.00	40.02	32.96	5.72	32.42	Peak	---	---
3	7311.00	38.14	-15.86	54.00	27.64	35.88	7.28	32.66	Average	---	---
4	7311.00	50.61	-23.39	74.00	40.11	35.88	7.28	32.66	Peak	---	---
5	9748.00	54.37			40.97	37.71	8.77	33.08	Peak	---	---

- Note 1: ">20dB" means spurious emission levels that exceed the level of 20 dB below the applicable limit.
- Note 2: "N/F" means Nothing Found spurious emissions (No spurious emissions were detected.)
- Note 3: Measurement receive antenna polarization: H (Horizontal), V (Vertical)
- Note 4: For restricted bands, the peak measurement is fully sufficient, as the max field strength as measured with the Peak-Detector meets the AV-Limit so that the AV level does not need to be reported in addition.
- Note 5: For un-restricted bands, unwanted emissions shall be attenuated by at least 20 dB relative to the maximum measured in-band level (109.19 dBuV/m).
- Note 6: No level of unwanted emissions exceeds the level of the fundamental emission.



Transmitter Radiated Unwanted Emissions (Above 1GHz)

Modulation Mode	HT40	Test Freq. (MHz)	2452
N _{TX}	2	Polarization	V

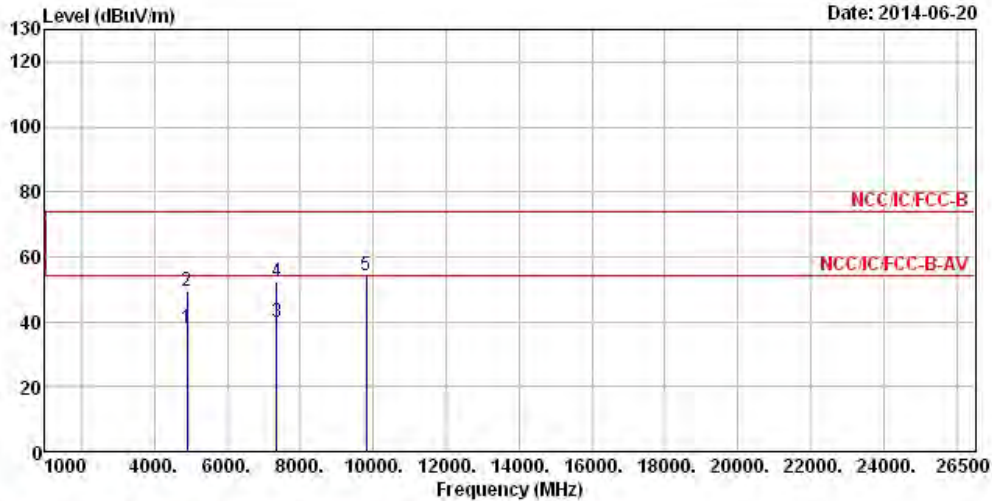

	Freq	Level	Over Limit	Limit Line	ReadAntenna Level	Antenna Factor	Cable Loss	Preamp Factor	Remark	A/Pos	T/Pos
	MHz	dBuV/m	dB	dBuV/m	dBuV	dB/m	dB	dB		cm	deg
1	4904.00	37.95	-16.05	54.00	31.73	32.93	5.72	32.43	Average	---	---
2	4904.00	49.21	-24.79	74.00	43.01	32.91	5.72	32.43	Peak	---	---
3	7356.00	39.88	-14.12	54.00	29.52	35.77	7.25	32.66	Average	---	---
4	7356.00	52.11	-21.89	74.00	41.75	35.77	7.25	32.66	Peak	---	---
5	9808.00	54.29			40.97	37.63	8.78	33.09	Peak	---	---

- Note 1: ">20dB" means spurious emission levels that exceed the level of 20 dB below the applicable limit.
- Note 2: "N/F" means Nothing Found spurious emissions (No spurious emissions were detected.)
- Note 3: Measurement receive antenna polarization: H (Horizontal), V (Vertical)
- Note 4: For restricted bands, the peak measurement is fully sufficient, as the max field strength as measured with the Peak-Detector meets the AV-Limit so that the AV level does not need to be reported in addition.
- Note 5: For un-restricted bands, unwanted emissions shall be attenuated by at least 20 dB relative to the maximum measured in-band level (105.49 dBuV/m).
- Note 6: No level of unwanted emissions exceeds the level of the fundamental emission.



Transmitter Radiated Unwanted Emissions (Above 1GHz)

Modulation Mode	HT40	Test Freq. (MHz)	2452
N _{TX}	2	Polarization	H

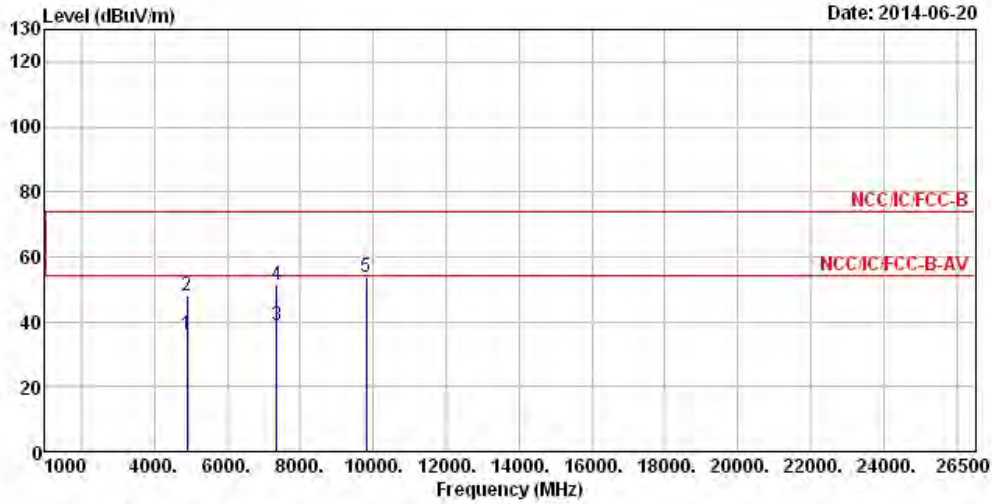

	Freq	Level	Over Limit	Limit Line	ReadAntenna Level	Antenna Factor	Cable Loss	Preamp Factor	Remark	A/Pos	T/Pos
	MHz	dBuV/m	dB	dBuV/m	dBuV	dB/m	dB	dB		cm	deg
1	4904.00	36.17	-17.83	54.00	29.97	32.91	5.72	32.43	Average	---	---
2	4904.00	47.88	-26.12	74.00	41.68	32.91	5.72	32.43	Peak	---	---
3	7356.00	38.68	-15.32	54.00	28.33	35.77	7.23	32.65	Average	---	---
4	7356.00	51.30	-22.70	74.00	40.90	35.81	7.25	32.66	Peak	---	---
5	9808.00	53.62			40.30	37.63	8.78	33.09	Peak	---	---

- Note 1: ">20dB" means spurious emission levels that exceed the level of 20 dB below the applicable limit.
- Note 2: "N/F" means Nothing Found spurious emissions (No spurious emissions were detected.)
- Note 3: Measurement receive antenna polarization: H (Horizontal), V (Vertical)
- Note 4: For restricted bands, the peak measurement is fully sufficient, as the max field strength as measured with the Peak-Detector meets the AV-Limit so that the AV level does not need to be reported in addition.
- Note 5: For un-restricted bands, unwanted emissions shall be attenuated by at least 20 dB relative to the maximum measured in-band level (105.49 dBuV/m).
- Note 6: No level of unwanted emissions exceeds the level of the fundamental emission.



4 Test Equipment and Calibration Data

Instrument	Manufacturer	Model No.	Serial No.	Characteristics	Calibration Date	Remark
EMC Receiver	R&S	ESCS 30	100174	9kHz ~ 2.75GHz	Mar. 26, 2014	AC Conduction
LISN	SCHWARZBECK MESS-ELEKTRONIK	NSLK 8127	8127-477	9kHz ~ 30MHz	Jan. 21, 2014	AC Conduction
RF Cable-CON	HUBER+SUHNER	RG213/U	0-7611832020001	9kHz ~ 30MHz	Oct. 30, 2013	AC Conduction
EMI Filter	LINDGREN	LRE-2030	2651	< 450 Hz	N/A	AC Conduction

Note: Calibration Interval of instruments listed above is one year.

Instrument	Manufacturer	Model No.	Serial No.	Characteristics	Calibration Date	Remark
Spectrum Analyzer	R&S	FSV 40	101013	9kHz ~ 40GHz	Jan. 25, 2014	RF Conducted
Signal Generator	R&S	SMB 100A	175727	100kHz ~ 40GHz	Jan. 07, 2014	RF Conducted
RF Cable-2m	HUBER+SUHNER	SUCOFLEX_104	SN 345673/4	30MHz ~ 26.5GHz	Dec. 02, 2013	RF Conducted

Note: Calibration Interval of instruments listed above is one year.

Instrument	Manufacturer	Model No.	Serial No.	Characteristics	Calibration Date	Remark
3m Semi Anechoic Chamber	SIDT FRANKONIA	SAC-3M	03CH03-HY	30MHz ~ 1GHz 3m	Nov. 30, 2013	Radiation
Amplifier	HP	8447D	2944A08033	10kHz ~ 1.3GHz	May 05, 2014	Radiation
Amplifier	Agilent	8449B	3008A02120	1GHz ~ 26.5GHz	Aug. 20, 2013	Radiation
Spectrum	R&S	FSP40	100004	9kHz ~ 40GHz	Mar. 27, 2014	Radiation
Bilog Antenna	SCHAFFNER	CBL 6112D	22237	30MHz ~ 1GHz	Sep. 21, 2013	Radiation
Horn Antenna	ETS · LINDGREN	3115	6744	1GHz ~ 18GHz	May 05, 2014	Radiation
Horn Antenna	SCHWARZBECK	BBHA9170	BBHA9170154	15GHz ~ 40GHz	Jan. 10, 2014	Radiation
RF Cable-R03m	Jye Bao	RG142	CB021	9kHz ~ 1GHz	Nov. 16, 2013	Radiation
RF Cable-high	SUHNER	SUCOFLEX 106	03CH03-HY	1GHz ~ 40GHz	Dec. 11, 2013	Radiation
Turn Table	EM Electronics	EM Electronics	060615	0 ~ 360 degree	N/A	Radiation
Antenna Mast	MF	MF-7802	MF780208179	1 ~ 4 m	N/A	Radiation

Note: Calibration Interval of instruments listed above is one year.

Instrument	Manufacturer	Model No.	Serial No.	Characteristics	Calibration Date	Remark
Loop Antenna	TESEQ	HLA 6120	31244	9 kHz - 30 MHz	Dec. 02, 2012	Radiation

Note: Calibration Interval of instruments listed above is two year.