



# DFS TEST REPORT

**REPORT NO.:** RF141108C01A-1  
**MODEL NO.:** AP 100X  
**FCC ID:** 2ACTO-AP100X  
**RECEIVED:** Nov. 08, 2014  
**TESTED:** Dec. 23 ~ Dec. 30, 2014  
**ISSUED:** Dec. 31, 2014

**APPLICANT:** Sophos Ltd

**ADDRESS:** The Pentagon, Abingdon, OX14 3YP, United Kingdom

**ISSUED BY:** Bureau Veritas Consumer Products Services (H.K.) Ltd., Taoyuan Branch

**LAB ADDRESS:** No. 47-2, 14th Ling, Chia Pau Vil., Lin Kou Dist., New Taipei City, Taiwan, R.O.C.

**TEST LOCATION:** No. 19, Hwa Ya 2nd Rd, Wen Hwa Tsuen, Kwei Shan Hsiang, Taoyuan Hsien 333, Taiwan, R.O.C.

This report should not be used by the client to claim product certification, approval, or endorsement by TAF or any government agencies.



This report is for your exclusive use. Any copying or replication of this report to or for any other person or entity, or use of our name or trademark, is permitted only with our prior written permission. This report sets forth our findings solely with respect to the test samples identified herein. The results set forth in this report are not indicative or representative of the quality or characteristics of the lot from which a test sample was taken or any similar or identical product unless specifically and expressly noted. Our report includes all of the tests requested by you and the results thereof based upon the information that you provided to us. You have 60 days from date of issuance of this report to notify us of any material error or omission caused by our negligence, provided, however, that such notice shall be in writing and shall specifically address the issue you wish to raise. A failure to raise such issue within the prescribed time shall constitute your unqualified acceptance of the completeness of this report, the tests conducted and the correctness of the report contents. Unless specific mention, the uncertainty of measurement has been explicitly taken into account to declare the compliance or non-compliance to the specification.



A D T

## TABLE OF CONTENTS

RELEASE CONTROL RECORD .....	3
1. CERTIFICATION .....	4
2. EUT INFORMATION .....	5
2.1 OPERATING FREQUENCY BANDS AND MODE OF EUT .....	5
2.2 EUT SOFTWARE AND FIRMWARE VERSION .....	5
2.3 DESCRIPTION OF AVAILABLE ANTENNAS TO THE EUT .....	5
2.4 EUT MAXIMUM CONDUCTED POWER .....	6
2.5 EUT MAXIMUM E.I.R.P. POWER .....	8
2.6 TRANSMIT POWER CONTROL (TPC) .....	10
2.7 STATEMENT OF MAUNFACTURER .....	10
3. U-NII DFS RULE REQUIREMENTS .....	11
3.1 WORKING MODES AND REQUIRED TEST ITEMS .....	11
3.2 TEST LIMITS AND RADAR SIGNAL PARAMETERS .....	12
4. TEST & SUPPORT EQUIPMENT LIST .....	14
4.1 TEST INSTRUMENTS .....	14
4.2 DESCRIPTION OF SUPPORT UNITS .....	14
5. TEST PROCEDURE .....	15
5.1 ADT DFS MEASUREMENT SYSTEM .....	15
5.2 CALIBRATION OF DFS DETECTION THRESHOLD LEVEL .....	16
5.3 DEVIATION FROM TEST STANDARD .....	16
5.4 RADIATED TEST SETUP CONFIGURATION .....	17
5.4.1 MASTER MODE .....	17
6. TEST RESULTS .....	18
6.1 SUMMARY OF TEST RESULTS .....	18
6.2 TEST RESULTS .....	19
6.2.1 TEST MODE: DEVICE OPERATING IN MASTER MODE .....	19
6.2.2 U-NII DETECTION BANDWIDTH .....	23
6.2.3 CHANNEL AVAILABILITY CHECK TIME .....	34
6.2.4 CHANNEL CLOSING TRANSMISSION AND CHANNEL MOVE TIME .....	36
6.2.5 NON- OCCUPANCY PERIOD .....	46
6.2.6 UNIFORM SPREADING .....	49
6.2.7 TRANSMIT POWER CONTROL (TPC) .....	49
7. INFORMATION ON THE TESTING LABORATORIES .....	50
APPENDIX A - MODIFICATIONS RECORDERS FOR ENGINEERING CHANGES TO THE EUT BY THE LAB .....	51



A D T

## RELEASE CONTROL RECORD

ISSUE NO.	REASON FOR CHANGE	DATE ISSUED
RF141108C01A-1	Original release	Dec. 31, 2014



A D T

## 1. CERTIFICATION

**PRODUCT:** Sophos wireless Access Point AP 100X

**MODEL:** AP 100X

**BRAND:** Sophos

**APPLICANT:** Sophos Ltd

**TESTED:** Dec. 23 ~ Dec. 30, 2014

**TEST SAMPLE:** ENGINEERING SAMPLE

**STANDARDS:** FCC Part 15, Subpart E (Section 15.407 under old rule)

KDB 905462 D01

FCC 06-96

The above equipment (model: AP 100X) has been tested by **Bureau Veritas Consumer Products Services (H.K.) Ltd., Taoyuan Branch**, and found compliance with the requirement of the above standards. The test record, data evaluation & Equipment Under Test (EUT) configurations represented herein are true and accurate accounts of the measurements of the sample's EMC characteristics under the conditions specified in this report.

**PREPARED BY** : Celine Chou , **DATE** : Dec. 31, 2014  
Celine Chou / Specialist

**APPROVED BY** : Ken Liu , **DATE** : Dec. 31, 2014  
Ken Liu / Senior Manager

## 2. EUT INFORMATION

### 2.1 OPERATING FREQUENCY BANDS AND MODE OF EUT

**TABLE 1: OPERATING FREQUENCY BANDS AND MODE OF EUT**

OPERATIONAL MODE	OPERATING FREQUENCY RANGE	
	5250~5350MHz	5470~5725MHz
Master	✓	✓

**Note:** The EUT has disabled the 5600-5650MHz band by S/W to avoid 5600-5650MHz.

### 2.2 EUT SOFTWARE AND FIRMWARE VERSION

**TABLE 2: THE EUT SOFTWARE/FIRMWARE VERSION**

NO.	PRODUCT	MODEL NO.	SOFTWARE/FIRMWARE VERSION
1	Sophos wireless Access Point AP 100X	AP 100X	Firmware version : 9.301-2 Pattern version : 70416

### 2.3 DESCRIPTION OF AVAILABLE ANTENNAS TO THE EUT

**TABLE 3: ANTENNA LIST**

ANT NO.	ANTENNA TYPE	OPERATION FREQUENCY RANGE (MHz)	MAX. GAIN (dBi)
1.	Dipole	5250-5725	6
2.	Dipole	5250-5725	6
3.	Dipole	5250-5725	6



## 2.4 EUT MAXIMUM CONDUCTED POWER

TABLE 4: THE MEASURED CONDUCTED OUTPUT POWER

### 802.11a

ANT NO.	FREQUENCY BAND (MHz)	MAX. POWER	
		OUTPUT POWER(dBm)	OUTPUT POWER(mW)
1	5250~5350	20.85	121.619
1	5470~5725	20.81	120.504

### 802.11n (20MHz)

ANT NO.	FREQUENCY BAND (MHz)	MAX. POWER	
		OUTPUT POWER(dBm)	OUTPUT POWER(mW)
1	5250~5350	19.62	91.588
1	5470~5725	19.51	89.262

### 802.11n (40MHz)

ANT NO.	FREQUENCY BAND (MHz)	MAX. POWER	
		OUTPUT POWER(dBm)	OUTPUT POWER(mW)
1	5250~5350	20.85	121.486
1	5470~5725	20.82	120.770



A D T

### 802.11ac (20MHz)

ANT NO.	FREQUENCY BAND (MHz)	MAX. POWER	
		OUTPUT POWER(dBm)	OUTPUT POWER(mW)
1	5250~5350	19.57	90.661
1	5470~5725	19.41	87.231

### 802.11ac (40MHz)

ANT NO.	FREQUENCY BAND (MHz)	MAX. POWER	
		OUTPUT POWER(dBm)	OUTPUT POWER(mW)
1	5250~5350	20.92	123.725
1	5470~5725	20.89	122.837

### 802.11ac (80MHz)

ANT NO.	FREQUENCY BAND (MHz)	MAX. POWER	
		OUTPUT POWER(dBm)	OUTPUT POWER(mW)
1	5250~5350	15.75	37.582
1	5470~5725	14.56	28.572



## 2.5 EUT MAXIMUM E.I.R.P. POWER

TABLE 5: THE E.I.R.P OUTPUT POWER LIST

### 802.11a

ANT NO.	FREQUENCY BAND (MHz)	MAX. POWER	
		OUTPUT POWER(dBm)	OUTPUT POWER(mW)
1	5250~5350	26.85	484.172
1	5470~5725	26.81	479.733

### 802.11n (20MHz)

ANT NO.	FREQUENCY BAND (MHz)	MAX. POWER	
		OUTPUT POWER(dBm)	OUTPUT POWER(mW)
1	5250~5350	25.62	364.754
1	5470~5725	25.51	355.631

### 802.11n (40MHz)

ANT NO.	FREQUENCY BAND (MHz)	MAX. POWER	
		OUTPUT POWER(dBm)	OUTPUT POWER(mW)
1	5250~5350	26.85	484.172
1	5470~5725	26.82	480.839





**802.11ac (20MHz)**

ANT NO.	FREQUENCY BAND (MHz)	MAX. POWER	
		OUTPUT POWER(dBm)	OUTPUT POWER(mW)
1	5250~5350	25.57	360.579
1	5470~5725	25.41	347.536

**802.11ac (40MHz)**

ANT NO.	FREQUENCY BAND (MHz)	MAX. POWER	
		OUTPUT POWER(dBm)	OUTPUT POWER(mW)
1	5250~5350	26.92	492.040
1	5470~5725	26.89	488.652

**802.11ac (80MHz)**

ANT NO.	FREQUENCY BAND (MHz)	MAX. POWER	
		OUTPUT POWER(dBm)	OUTPUT POWER(mW)
1	5250~5350	21.75	149.624
1	5470~5725	20.56	113.763

## 2.6 TRANSMIT POWER CONTROL (TPC)

U-NII devices operating in the 5.25-5.35 GHz band and the 5.47-5.725 GHz band shall employ a TPC mechanism. The U-NII device is required to have the capability to operate at least 6 dB below the mean EIRP value of 30 dBm. A TPC mechanism is not required for systems with an e.i.r.p. of less than 500 mW.

Maximum EIRP of this device is 492.040mW which less than 500mW, therefore it's not require TPC function.

## 2.7 STATEMENT OF MAUNFACTURER

Manufacturer statement confirming that information regarding the parameters of the detected Radar Waveforms is not available to the end user.



### 3. U-NII DFS RULE REQUIREMENTS

#### 3.1 WORKING MODES AND REQUIRED TEST ITEMS

The manufacturer shall state whether the EUT is capable of operating as a Master and/or a Client. If the EUT is capable of operating in more than one operating mode then each operating mode shall be tested separately. See tables 6 and 7 for the applicability of DFS requirements for each of the operational modes.

**TABLE 6: APPLICABILITY OF DFS REQUIREMENTS PRIOR TO USE A CHANNEL**

Requirement	Operational Mode		
	Master	Client without radar detection	Client with radar detection
Non-Occupancy Period	✓	Not required	✓
DFS Detection Threshold	✓	Not required	✓
Channel Availability Check Time	✓	Not required	Not required
Uniform Spreading	✓	Not required	Not required
U-NII Detection Bandwidth	✓	Not required	✓

**TABLE 7: APPLICABILITY OF DFS REQUIREMENTS DURING NORMAL OPERATION.**

Requirement	Operational Mode		
	Master	Client without radar detection	Client with radar detection
DFS Detection Threshold	✓	Not required	✓
Channel Closing Transmission Time	✓	✓	✓
Channel Move Time	✓	✓	✓
U-NII Detection Bandwidth	✓	Not required	✓



### 3.2 TEST LIMITS AND RADAR SIGNAL PARAMETERS

#### DETECTION THRESHOLD VALUES

**TABLE 8: DFS DETECTION THRESHOLDS FOR MASTER DEVICES AND CLIENT DEVICES WITH RADAR DETECTION.**

Maximum Transmit Power	Value (See Notes 1 and 2)
≥ 200 milliwatt	-64 dBm
< 200 milliwatt	-62 dBm

Note 1: This is the level at the input of the receiver assuming a 0 dBi receive antenna.  
 Note 2: Throughout these test procedures an additional 1 dB has been added to the amplitude of the test transmission waveforms to account for variations in measurement equipment. This will ensure that the test signal is at or above the detection threshold level to trigger a DFS response.

**TABLE 9: DFS RESPONSE REQUIREMENT VALUES**

Parameter	Value
Non-occupancy period	Minimum 30 minutes
Channel Availability Check Time	60 seconds
Channel Move Time	10 seconds See Note 1.
Channel Closing Transmission Time	200 milliseconds + an aggregate of 60 milliseconds over remaining 10 second period. See Notes 1 and 2.
U-NII Detection Bandwidth	Minimum 80% of the UNII 99% transmission power bandwidth. See Note 3.

**Note 1:** The instant that the Channel Move Time and the Channel Closing Transmission Time begins is as follows:

- For the Short Pulse Radar Test Signals this instant is the end of the Burst.
- For the Frequency Hopping radar Test Signal, this instant is the end of the last radar Burst generated.
- For the Long Pulse Radar Test Signal this instant is the end of the 12 second period defining the Radar Waveform.

**Note 2:** The Channel Closing Transmission Time is comprised of 200 milliseconds starting at the beginning of the Channel Move Time plus any additional intermittent control signals required to facilitate a Channel move (an aggregate of 60 milliseconds) during the remainder of the 10 second period. The aggregate duration of control signals will not count quiet periods in between transmissions.

**Note 3:** During the U-NII Detection Bandwidth detection test, radar type 1 is used and for each frequency step the minimum percentage of detection is 90 percent. Measurements are performed with no data traffic.



### PARAMETERS OF DFS TEST SIGNALS

Step intervals of 0.1 microsecond for Pulse Width, 1 microsecond for PRI, 1 MHz for chirp width and 1 for the number of pulses will be utilized for the random determination of specific test waveforms.

**TABLE 10: SHORT PULSE RADAR TEST WAVEFORMS.**

Radar Type	Pulse Width (µsec)	PRI (µsec)	Number of Pulses	Minimum Percentage of Successful Detection	Minimum Number of Trials
1	1	1428	18	60%	30
2	1-5	150-230	23-29	60%	30
3	6-10	200-500	16-18	60%	30
4	11-20	200-500	12-16	60%	30
Aggregate (Radar Types 1-4)				80%	120

**TABLE 11: LONG PULSE RADAR TEST WAVEFORM**

Radar Type	Pulse Width (µsec)	Chirp Width (MHz)	PRI (µsec)	Number of Pulses per Burst	Number of Bursts	Minimum Percentage of Successful Detection	Minimum Number of Trials
5	50-100	5-20	1000-2000	1-3	8-20	80%	30

**TABLE 12: FREQUENCY HOPPING RADAR TEST WAVEFORM**

Radar Type	Pulse Width (µsec)	PRI (µsec)	Pulses per Hop	Hopping Rate (kHz)	Hopping Sequence Length (msec)	Minimum Percentage of Successful Detection	Minimum Number of Trials
6	1	333	9	0.333	300	70%	30



## 4. TEST & SUPPORT EQUIPMENT LIST

### 4.1 TEST INSTRUMENTS

TABLE 13: TEST INSTRUMENTS LIST

DESCRIPTION & MANUFACTURER	MODEL NO.	BRAND	DATE OF CALIBRATION	DUE DATE OF CALIBRATION
R&S Spectrum analyzer	FSP40	R&S	2014/03/03	2015/03/02
Signal generator	8645A	Agilent	2014/06/24	2015/06/23
Oscilloscope	TDS 5104	Tektronix	2014/03/20	2015/03/19

### 4.2 DESCRIPTION OF SUPPORT UNITS

TABLE 14: SUPPORT UNIT INFORMATION.

No.	Product	Brand	Model No.	FCC ID
1	AC1200 Dual Band USB Adapter	D-Link	DWA-182	1023.5.116.2013

NOTE: This device was functioned as a  Master  Slave device during the DFS test.

## 5. TEST PROCEDURE

### 5.1 BV ADT DFS MEASUREMENT SYSTEM

A complete BV ADT DFS Measurement System consists of two subsystems: (1) the Radar Signal Generating Subsystem and (2) the Traffic Monitoring Subsystem. The control PC is necessary for generating the Radar waveforms in Table 10, 11 and 12. The traffic monitoring subsystem is specified to the type of unit under test (UUT).

#### RADIATED SETUP CONFIGURATION OF ADT DFS MEASUREMENT SYSTEM

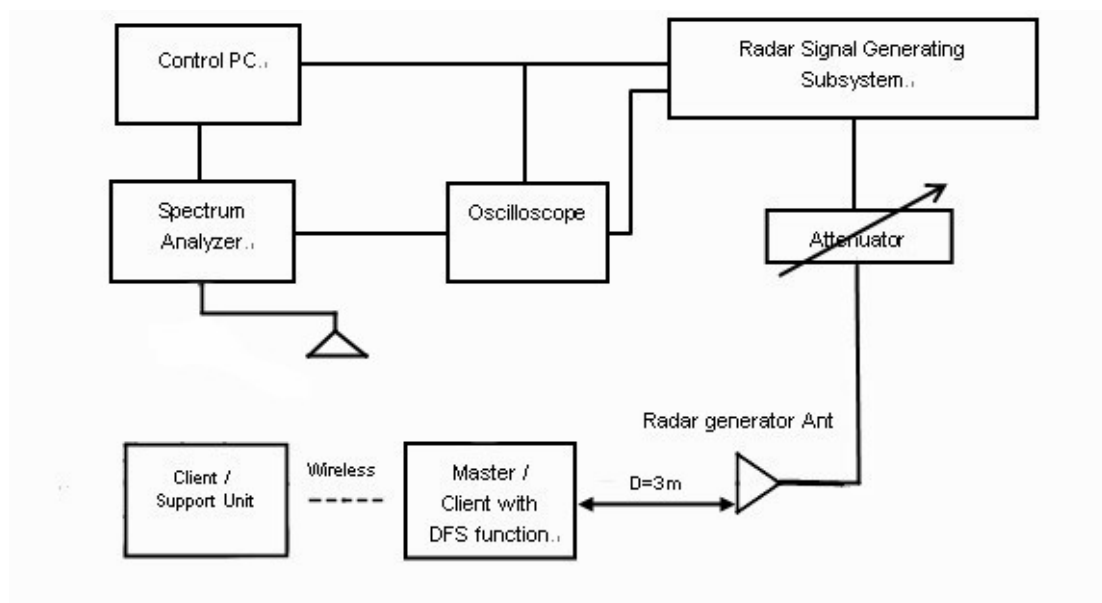

The test transmission will always be from the Master Device to the Client Device. While the Client device is set up to associate with the Master device and play the MPEG file (6  $\frac{1}{2}$  Magic Hours) from Master device, the designated MPEG test file and instructions are located at:

<http://ntiacsd.ntia.doc.gov/dfs/>.

## 5.2 CALIBRATION OF DFS DETECTION THRESHOLD LEVEL

The measured channel is 5500MHz, 5510MHz and 5530 MHz, The radar signal was the same as transmitted channels, and injected into the antenna of AP (master) or Client Device with Radar Detection, measured the channel closing transmission time and channel move time. The calibrated detection threshold level is set to -64dBm. The tested level is lower than required level hence it provides margin to the limit.

### Radiated setup configuration of Calibration of DFS Detection Threshold Level

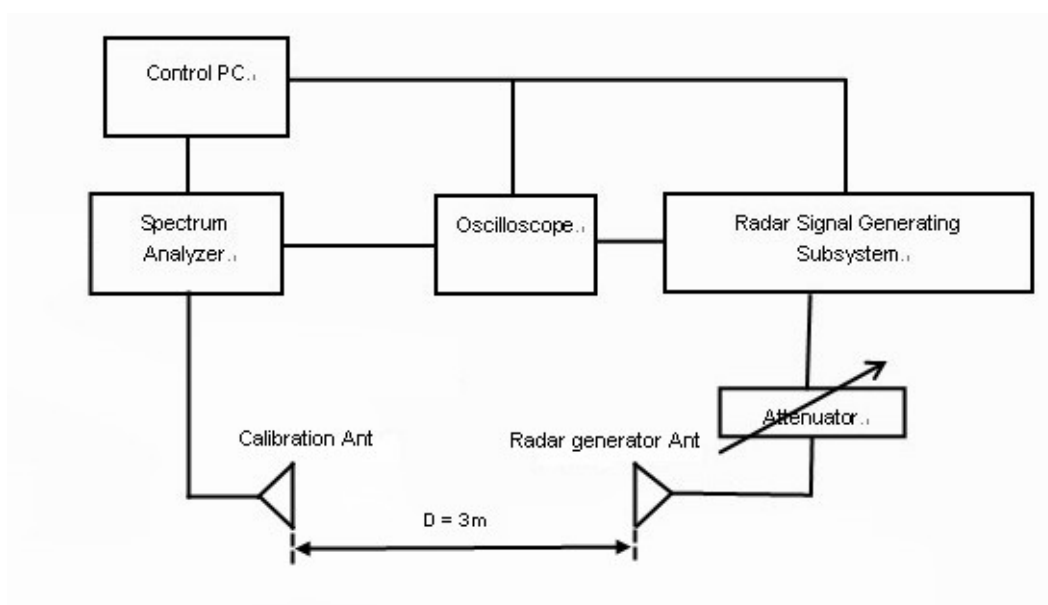

## 5.3 DEVIATION FROM TEST STANDARD

No deviation.



## 5.4 RADIATED TEST SETUP CONFIGURATION

### 5.4.1 MASTER MODE

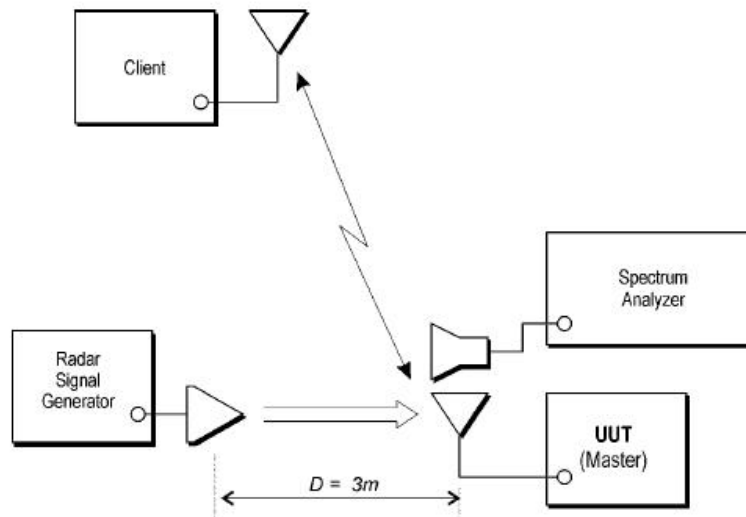

The EUT is a U-NII Device operating in Master mode. The radar test signals are injected into the Master Device.



## 6. TEST RESULTS

### 6.1 SUMMARY OF TEST RESULTS

CLAUSE	TEST PARAMETER	REMARKS	PASS/FAIL
15.407	DFS Detection Threshold	Applicable	Pass
15.407	U-NII Detection Bandwidth	Applicable	Pass
15.407	Channel Availability Check Time	Applicable	Pass
15.407	Channel Move Time	Applicable	Pass
15.407	Channel Closing Transmission Time	Applicable	Pass
15.407	Non- Occupancy Period	Applicable	Pass
15.407	Uniform Spreading	Applicable	Pass

## 6.2 TEST RESULTS

### 6.2.1 TEST MODE: DEVICE OPERATING IN MASTER MODE

Master with injection at the Master. (Radar Test Waveforms are injected into the Master.

### DFS DETECTION THRESHOLD

For a detection threshold level of -64dBm, the required signal strength at EUT antenna location is -64 dBm. The tested level is lower than required level hence it provides margin to the limit.

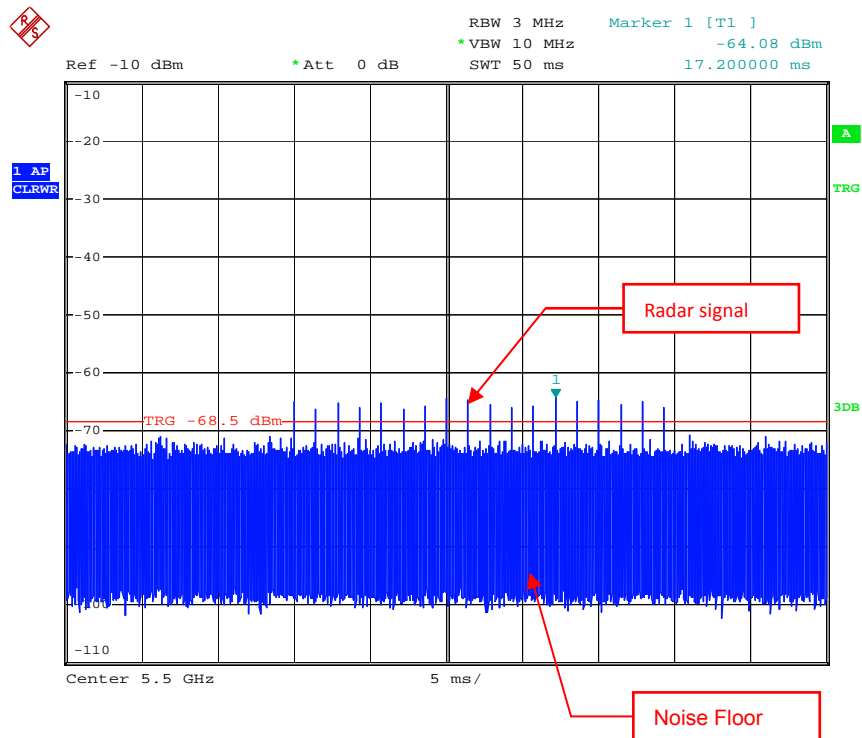

Radar Signal 1

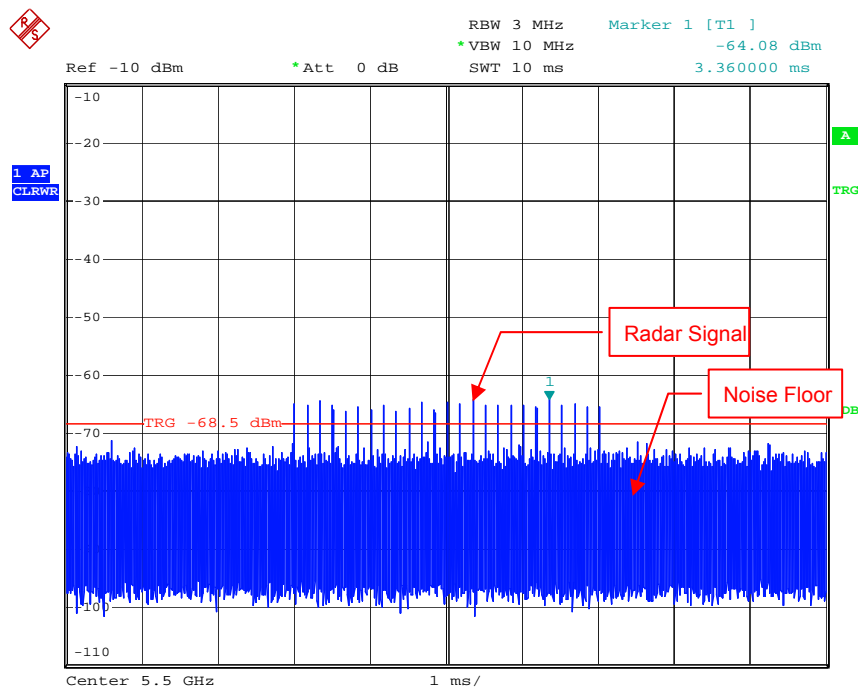

Radar Signal 2

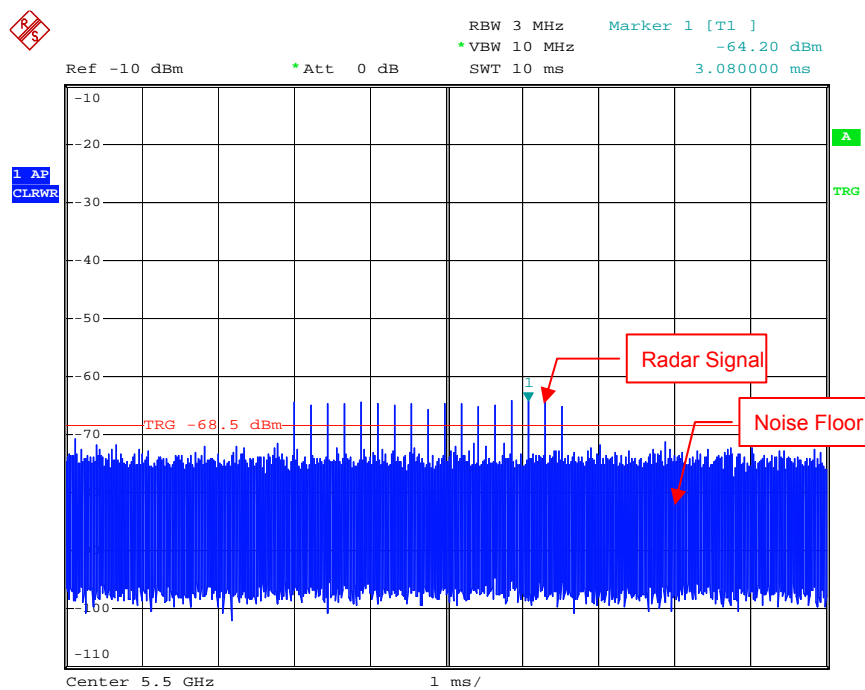

Radar Signal 3



A D T

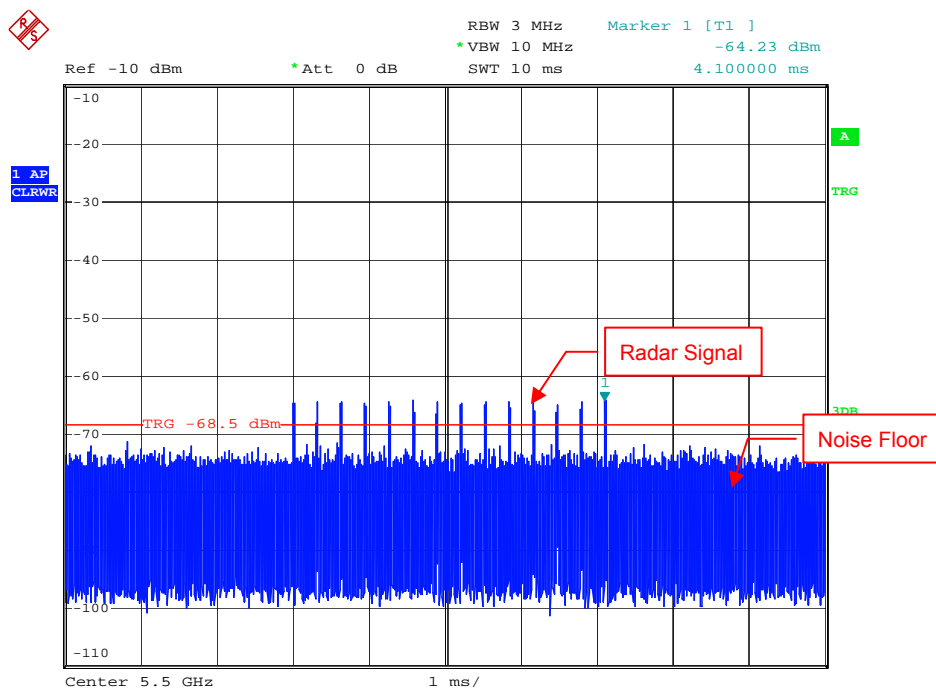

Radar Signal 4

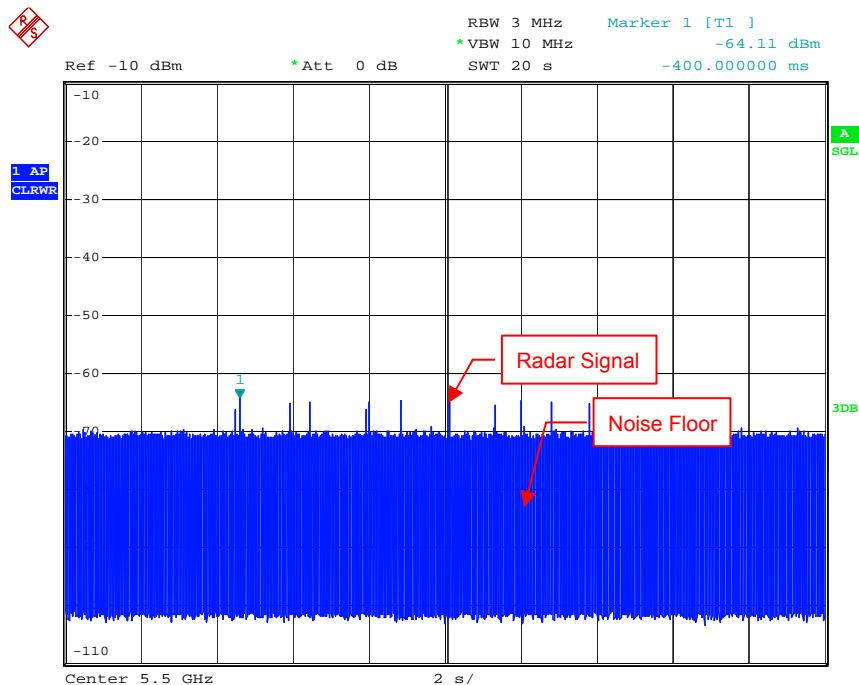

Radar Signal 5

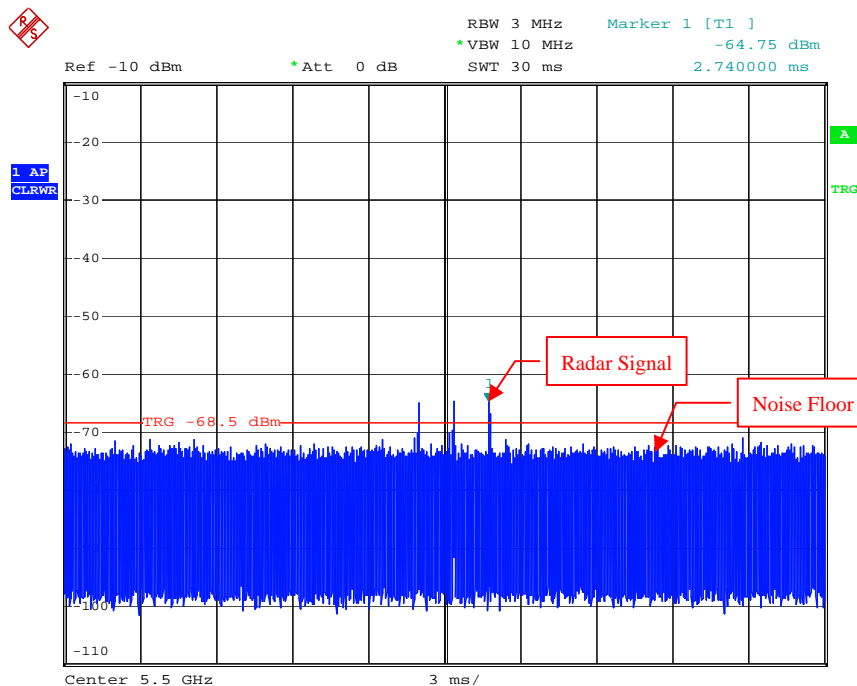

Single Burst of Radar Signal 5

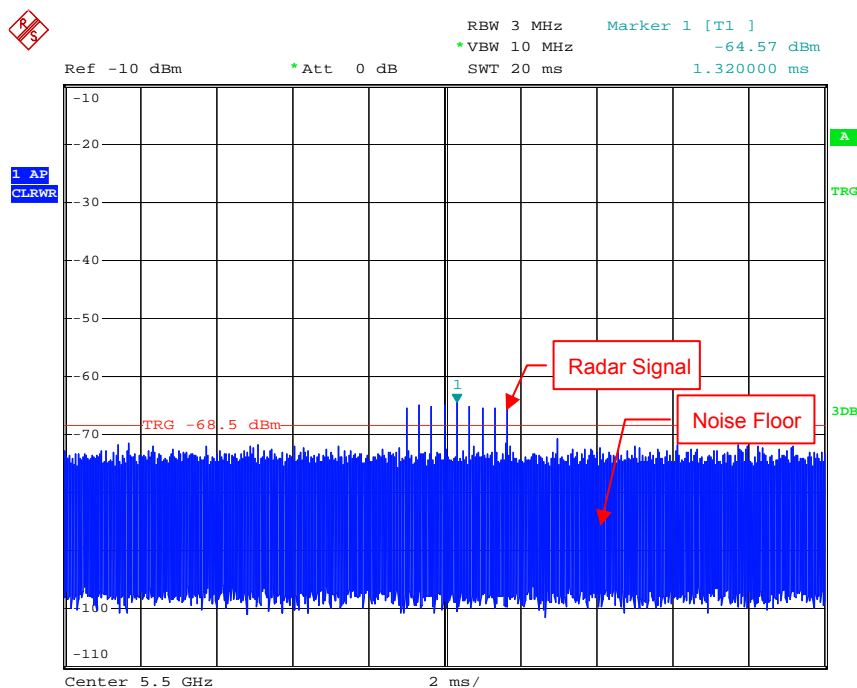

Radar Signal 6



A D T

## 6.2.2 U-NII DETECTION BANDWIDTH

### IEEE 802.11n 20MHz

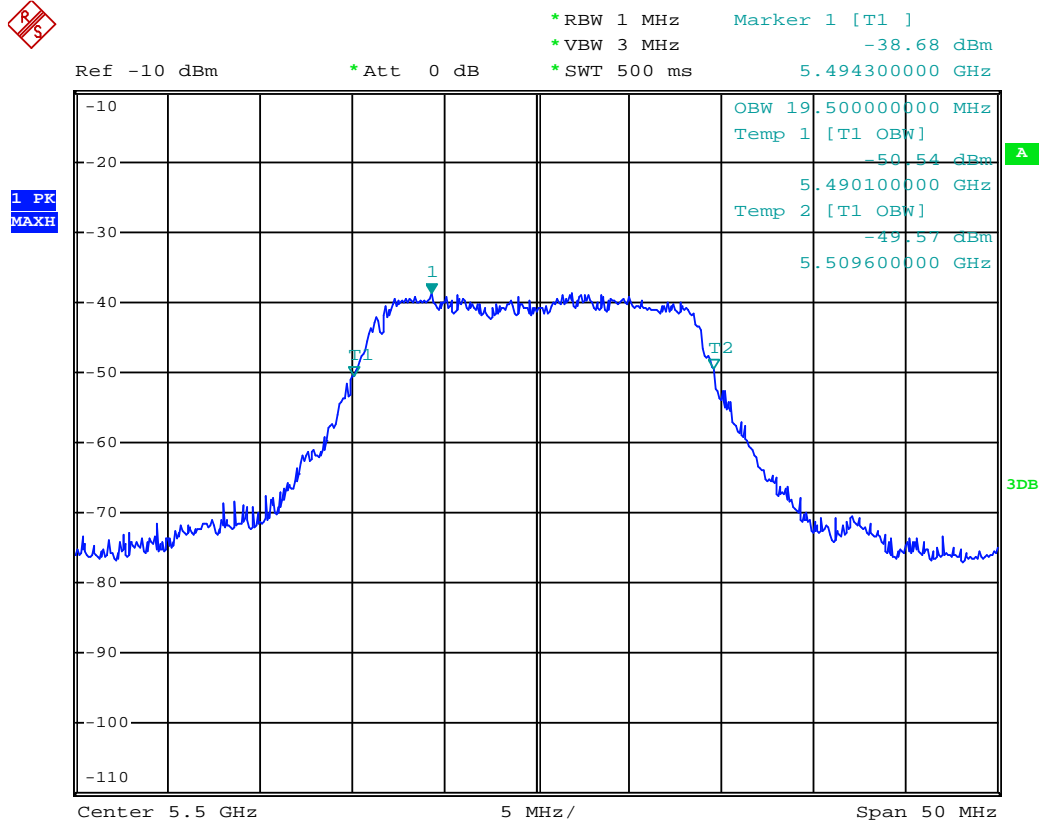

U-NII 99% Channel bandwidth



A D T

# IEEE 802.11n 40MHz



Ref -10 dBm      \*Att 0 dB      \*RBW 1 MHz      Marker 1 [T1 ]  
\*VBW 3 MHz      -41.75 dBm  
\*SWT 500 ms      5.500400000 GHz

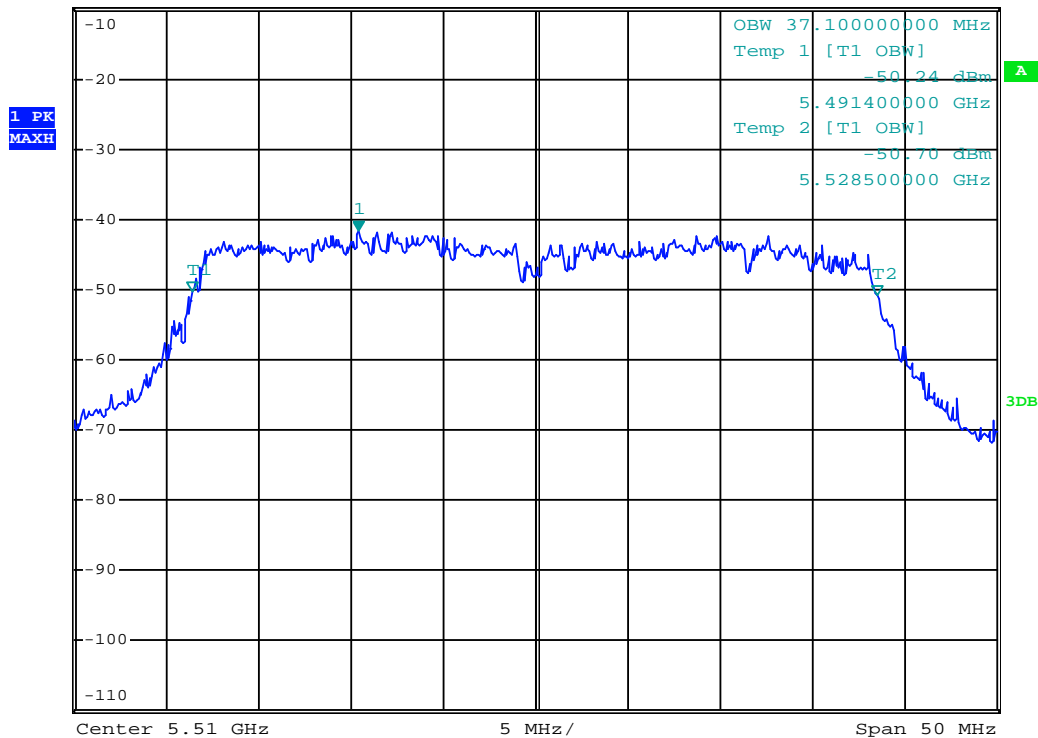

U-NII 99% Channel bandwidth





A D T

# IEEE 802.11ac 20MHz

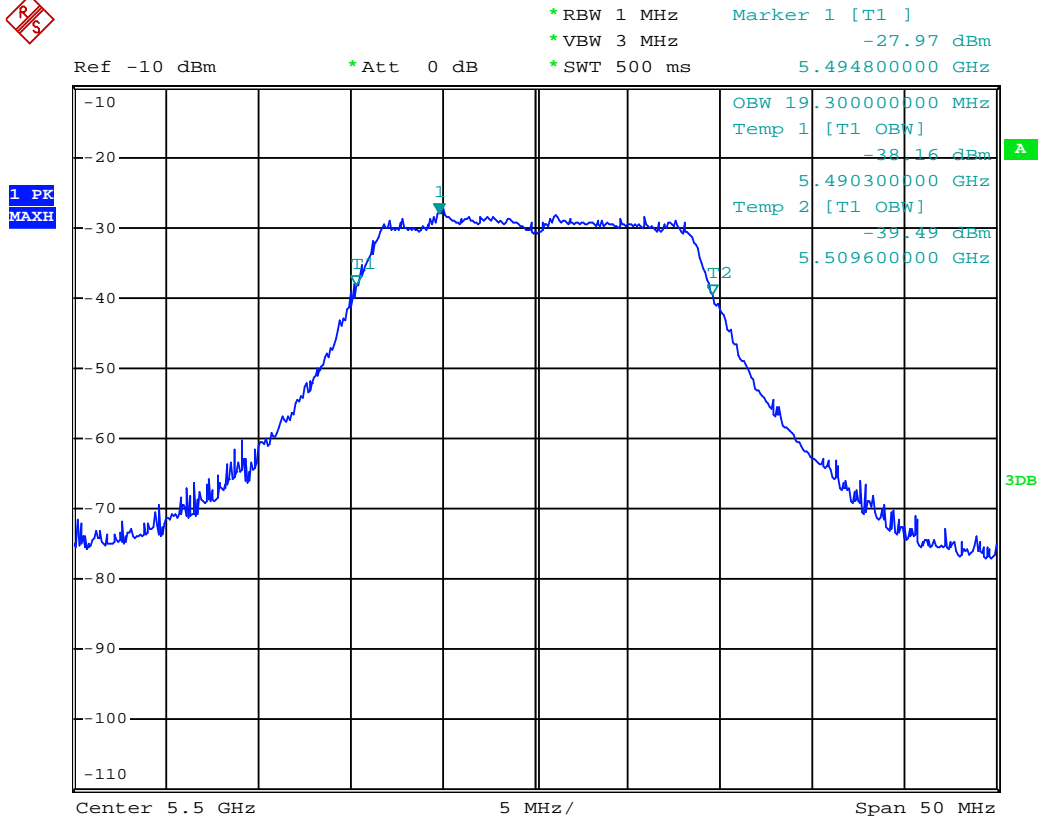

U-NII 99% Channel bandwidth



A D T

# IEEE 802.11ac 40MHz

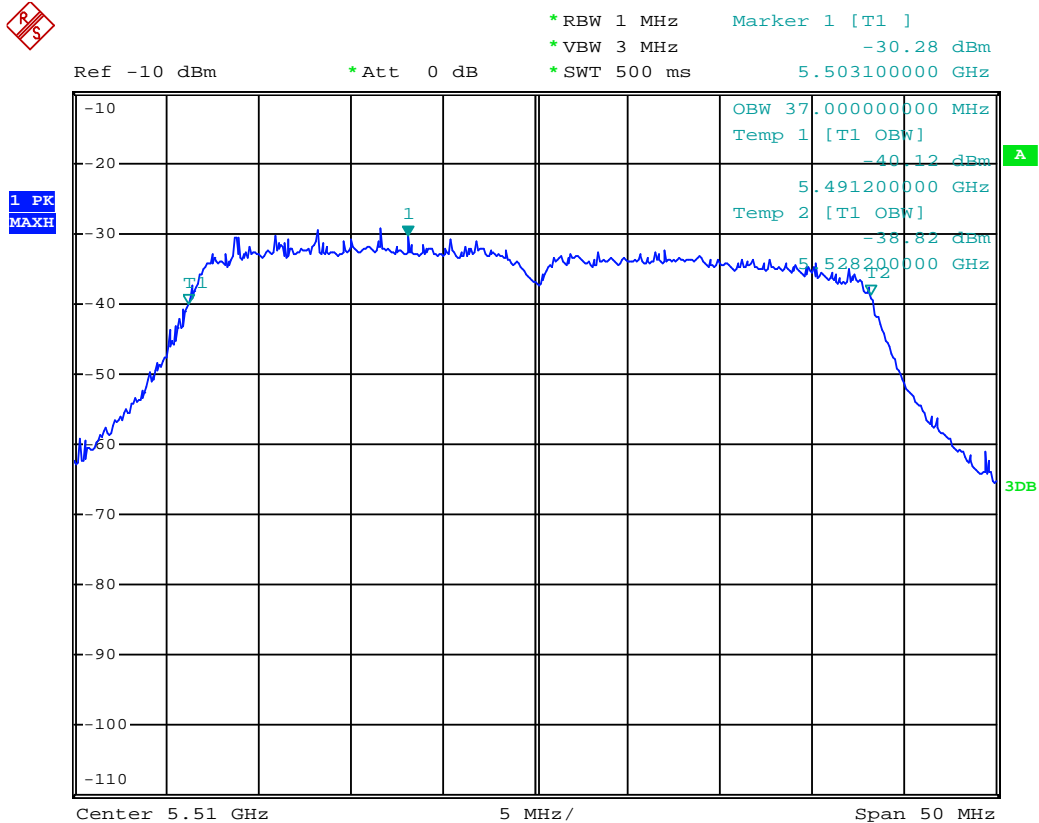

U-NII 99% Channel bandwidth



A D T

# IEEE 802.11ac 80MHz



\*RBW 1 MHz      Marker 1 [T1 ]  
 \*VBW 3 MHz      -43.04 dBm  
 \*Att 0 dB      \*SWT 500 ms      5.498400000 GHz

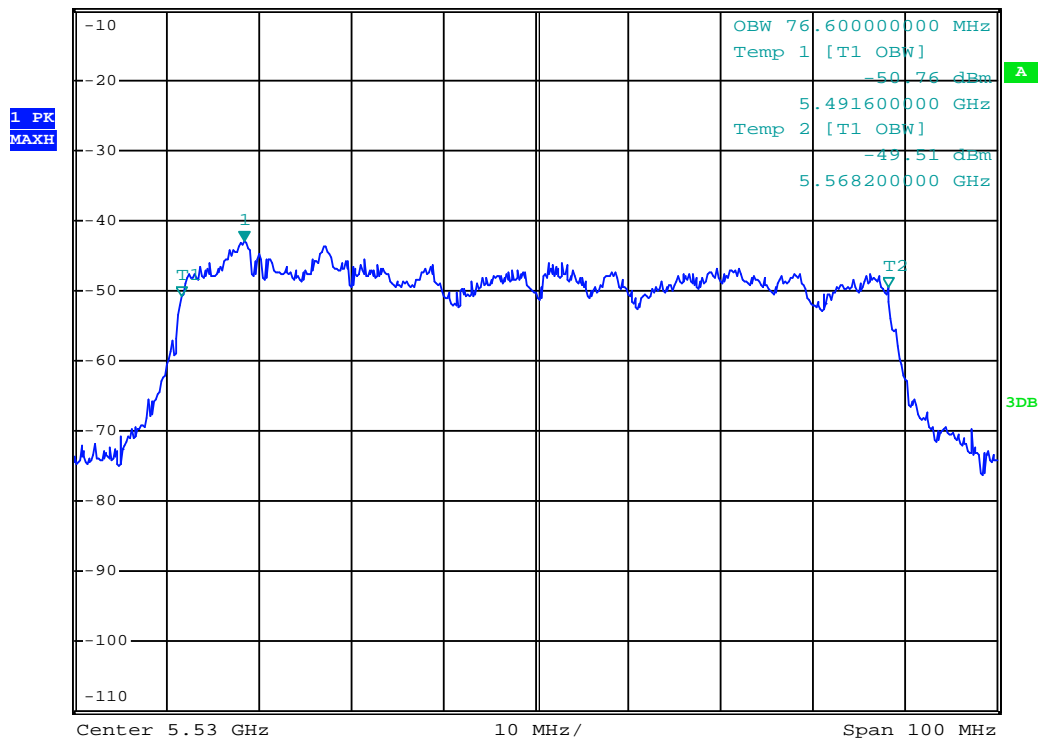

### U-NII 99% Channel bandwidth



Detection Bandwidth Test - IEEE 802.11n 20MHz  
 EUT Frequency: 5500MHz  
 EUT 99% Power bandwidth: 19.5MHz  
 Detection bandwidth limit (80% of EUT 99% Power bandwidth): 15.6MHz  
 Detection bandwidth (5510(FH) – 5490(FL)) : 20MHz  
 Test Result : PASS

Radar Frequency (MHz)	Trial Number / Detection										Detection Rate (%)
	1	2	3	4	5	6	7	8	9	10	
5489	N	N	N	N	N	N	N	N	N	N	0
5490(FL)	Y	Y	Y	Y	Y	Y	Y	Y	Y	Y	100
5491	Y	Y	Y	Y	Y	Y	Y	Y	Y	Y	100
5492	Y	Y	Y	Y	Y	Y	Y	Y	Y	Y	100
5493	Y	Y	Y	Y	Y	Y	Y	Y	Y	Y	100
5494	Y	Y	Y	Y	Y	Y	Y	Y	Y	Y	100
5495	Y	Y	Y	Y	Y	Y	Y	Y	Y	Y	100
5496	Y	Y	Y	Y	Y	Y	Y	Y	Y	Y	100
5497	Y	Y	Y	Y	Y	Y	Y	Y	Y	Y	100
5498	Y	Y	Y	Y	Y	Y	Y	Y	Y	Y	100
5499	Y	Y	Y	Y	Y	Y	Y	Y	Y	Y	100
5500	Y	Y	Y	Y	Y	Y	Y	Y	Y	Y	100
5501	Y	Y	Y	Y	Y	Y	Y	Y	Y	Y	100
5502	Y	Y	Y	Y	Y	Y	Y	Y	Y	Y	100
5503	Y	Y	Y	Y	Y	Y	Y	Y	Y	Y	100
5504	Y	Y	Y	Y	Y	Y	Y	Y	Y	Y	100
5505	Y	Y	Y	Y	Y	Y	Y	Y	Y	Y	100
5506	Y	Y	Y	Y	Y	Y	Y	Y	Y	Y	100
5507	Y	Y	Y	Y	Y	Y	Y	Y	Y	Y	100
5508	Y	Y	Y	Y	Y	Y	Y	Y	Y	Y	100
5509	Y	Y	Y	Y	Y	Y	Y	Y	Y	Y	100
5510(FH)	Y	Y	Y	Y	Y	Y	Y	Y	Y	Y	100
5511	N	N	N	N	N	N	N	N	N	N	0



Detection Bandwidth Test - IEEE 802.11n 40MHz  
EUT Frequency: 5510MHz  
EUT 99% Power bandwidth: 37.1MHz  
Detection bandwidth limit (80% of EUT 99% Power bandwidth): 29.68MHz  
Detection bandwidth (5529(FH) – 5491(FL)) : 38MHz  
Test Result : PASS

Radar Frequency (MHz)	Trial Number / Detection										Detection Rate (%)
	1	2	3	4	5	6	7	8	9	10	
5490	N	N	N	N	N	N	N	N	N	N	0
5491(FL)	Y	Y	Y	Y	Y	Y	Y	Y	Y	Y	100
5492	Y	Y	Y	Y	Y	Y	Y	Y	Y	Y	100
5493	Y	Y	Y	Y	Y	Y	Y	Y	Y	Y	100
5494	Y	Y	Y	Y	Y	Y	Y	Y	Y	Y	100
5495	Y	Y	Y	Y	Y	Y	Y	Y	Y	Y	100
5496	Y	Y	Y	Y	Y	Y	Y	Y	Y	Y	100
5497	Y	Y	Y	Y	Y	Y	Y	Y	Y	Y	100
5498	Y	Y	Y	Y	Y	Y	Y	Y	Y	Y	100
5499	Y	Y	Y	Y	Y	Y	Y	Y	Y	Y	100
5500	Y	Y	Y	Y	Y	Y	Y	Y	Y	Y	100
5501	Y	Y	Y	Y	Y	Y	Y	Y	Y	Y	100
5502	Y	Y	Y	Y	Y	Y	Y	Y	Y	Y	100
5503	Y	Y	Y	Y	Y	Y	Y	Y	Y	Y	100
5504	Y	Y	Y	Y	Y	Y	Y	Y	Y	Y	100
5505	Y	Y	Y	Y	Y	Y	Y	Y	Y	Y	100
5506	Y	Y	Y	Y	Y	Y	Y	Y	Y	Y	100
5507	Y	Y	Y	Y	Y	Y	Y	Y	Y	Y	100
5508	Y	Y	Y	Y	Y	Y	Y	Y	Y	Y	100
5509	Y	Y	Y	Y	Y	Y	Y	Y	Y	Y	100
5510	Y	Y	Y	Y	Y	Y	Y	Y	Y	Y	100
5511	Y	Y	Y	Y	Y	Y	Y	Y	Y	Y	100
5512	Y	Y	Y	Y	Y	Y	Y	Y	Y	Y	100
5513	Y	Y	Y	Y	Y	Y	Y	Y	Y	Y	100
5514	Y	Y	Y	Y	Y	Y	Y	Y	Y	Y	100
5515	Y	Y	Y	Y	Y	Y	Y	Y	Y	Y	100
5516	Y	Y	Y	Y	Y	Y	Y	Y	Y	Y	100
5517	Y	Y	Y	Y	Y	Y	Y	Y	Y	Y	100
5518	Y	Y	Y	Y	Y	Y	Y	Y	Y	Y	100
5519	Y	Y	Y	Y	Y	Y	Y	Y	Y	Y	100
5520	Y	Y	Y	Y	Y	Y	Y	Y	Y	Y	100
5521	Y	Y	Y	Y	Y	Y	Y	Y	Y	Y	100
5522	Y	Y	Y	Y	Y	Y	Y	Y	Y	Y	100
5523	Y	Y	Y	Y	Y	Y	Y	Y	Y	Y	100
5524	Y	Y	Y	Y	Y	Y	Y	Y	Y	Y	100
5525	Y	Y	Y	Y	Y	Y	Y	Y	Y	Y	100
5526	Y	Y	Y	Y	Y	Y	Y	Y	Y	Y	100
5527	Y	Y	Y	Y	Y	Y	Y	Y	Y	Y	100
5528	Y	Y	Y	Y	Y	Y	Y	Y	Y	Y	100
5529(FH)	Y	Y	Y	Y	Y	Y	Y	Y	Y	Y	100
5530	N	N	N	N	N	N	N	N	N	N	0



A D T

Detection Bandwidth Test - IEEE 802.11ac 20MHz  
EUT Frequency: 5500MHz  
EUT 99% Power bandwidth: 19.3MHz  
Detection bandwidth limit (80% of EUT 99% Power bandwidth): 15.44MHz  
Detection bandwidth (5510(FH) – 5490(FL)) : 20MHz  
Test Result : PASS

Radar Frequency (MHz)	Trial Number / Detection										Detection Rate (%)
	1	2	3	4	5	6	7	8	9	10	
5489	N	N	N	N	N	N	N	N	N	N	0
5490(FL)	Y	Y	Y	Y	Y	Y	Y	Y	Y	Y	100
5491	Y	Y	Y	Y	Y	Y	Y	Y	Y	Y	100
5492	Y	Y	Y	Y	Y	Y	Y	Y	Y	Y	100
5493	Y	Y	Y	Y	Y	Y	Y	Y	Y	Y	100
5494	Y	Y	Y	Y	Y	Y	Y	Y	Y	Y	100
5495	Y	Y	Y	Y	Y	Y	Y	Y	Y	Y	100
5496	Y	Y	Y	Y	Y	Y	Y	Y	Y	Y	100
5497	Y	Y	Y	Y	Y	Y	Y	Y	Y	Y	100
5498	Y	Y	Y	Y	Y	Y	Y	Y	Y	Y	100
5499	Y	Y	Y	Y	Y	Y	Y	Y	Y	Y	100
5500	Y	Y	Y	Y	Y	Y	Y	Y	Y	Y	100
5501	Y	Y	Y	Y	Y	Y	Y	Y	Y	Y	100
5502	Y	Y	Y	Y	Y	Y	Y	Y	Y	Y	100
5503	Y	Y	Y	Y	Y	Y	Y	Y	Y	Y	100
5504	Y	Y	Y	Y	Y	Y	Y	Y	Y	Y	100
5505	Y	Y	Y	Y	Y	Y	Y	Y	Y	Y	100
5506	Y	Y	Y	Y	Y	Y	Y	Y	Y	Y	100
5507	Y	Y	Y	Y	Y	Y	Y	Y	Y	Y	100
5508	Y	Y	Y	Y	Y	Y	Y	Y	Y	Y	100
5509	Y	Y	Y	Y	Y	Y	Y	Y	Y	Y	100
5510(FH)	Y	Y	Y	Y	Y	Y	Y	Y	Y	Y	100
5511	N	N	N	N	N	N	N	N	N	N	0



Detection Bandwidth Test - IEEE 802.11ac 40MHz											
EUT Frequency: 5510MHz											
EUT 99% Power bandwidth: 37MHz											
Detection bandwidth limit (80% of EUT 99% Power bandwidth): 29.6MHz											
Detection bandwidth (5529(FH) – 5491(FL)) : 38MHz											
Test Result : PASS											
Radar Frequency (MHz)	Trial Number / Detection										Detection Rate (%)
	1	2	3	4	5	6	7	8	9	10	
5490	N	N	N	N	N	N	N	N	N	N	0
5491(FL)	Y	Y	Y	Y	Y	Y	Y	Y	Y	Y	100
5492	Y	Y	Y	Y	Y	Y	Y	Y	Y	Y	100
5493	Y	Y	Y	Y	Y	Y	Y	Y	Y	Y	100
5494	Y	Y	Y	Y	Y	Y	Y	Y	Y	Y	100
5495	Y	Y	Y	Y	Y	Y	Y	Y	Y	Y	100
5496	Y	Y	Y	Y	Y	Y	Y	Y	Y	Y	100
5497	Y	Y	Y	Y	Y	Y	Y	Y	Y	Y	100
5498	Y	Y	Y	Y	Y	Y	Y	Y	Y	Y	100
5499	Y	Y	Y	Y	Y	Y	Y	Y	Y	Y	100
5500	Y	Y	Y	Y	Y	Y	Y	Y	Y	Y	100
5501	Y	Y	Y	Y	Y	Y	Y	Y	Y	Y	100
5502	Y	Y	Y	Y	Y	Y	Y	Y	Y	Y	100
5503	Y	Y	Y	Y	Y	Y	Y	Y	Y	Y	100
5504	Y	Y	Y	Y	Y	Y	Y	Y	Y	Y	100
5505	Y	Y	Y	Y	Y	Y	Y	Y	Y	Y	100
5506	Y	Y	Y	Y	Y	Y	Y	Y	Y	Y	100
5507	Y	Y	Y	Y	Y	Y	Y	Y	Y	Y	100
5508	Y	Y	Y	Y	Y	Y	Y	Y	Y	Y	100
5509	Y	Y	Y	Y	Y	Y	Y	Y	Y	Y	100
5510	Y	Y	Y	Y	Y	Y	Y	Y	Y	Y	100
5511	Y	Y	Y	Y	Y	Y	Y	Y	Y	Y	100
5512	Y	Y	Y	Y	Y	Y	Y	Y	Y	Y	100
5513	Y	Y	Y	Y	Y	Y	Y	Y	Y	Y	100
5514	Y	Y	Y	Y	Y	Y	Y	Y	Y	Y	100
5515	Y	Y	Y	Y	Y	Y	Y	Y	Y	Y	100
5516	Y	Y	Y	Y	Y	Y	Y	Y	Y	Y	100
5517	Y	Y	Y	Y	Y	Y	Y	Y	Y	Y	100
5518	Y	Y	Y	Y	Y	Y	Y	Y	Y	Y	100
5519	Y	Y	Y	Y	Y	Y	Y	Y	Y	Y	100
5520	Y	Y	Y	Y	Y	Y	Y	Y	Y	Y	100
5521	Y	Y	Y	Y	Y	Y	Y	Y	Y	Y	100
5522	Y	Y	Y	Y	Y	Y	Y	Y	Y	Y	100
5523	Y	Y	Y	Y	Y	Y	Y	Y	Y	Y	100
5524	Y	Y	Y	Y	Y	Y	Y	Y	Y	Y	100
5525	Y	Y	Y	Y	Y	Y	Y	Y	Y	Y	100
5526	Y	Y	Y	Y	Y	Y	Y	Y	Y	Y	100
5527	Y	Y	Y	Y	Y	Y	Y	Y	Y	Y	100
5528	Y	Y	Y	Y	Y	Y	Y	Y	Y	Y	100
5529(FH)	Y	Y	Y	Y	Y	Y	Y	Y	Y	Y	100
5530	N	N	N	N	N	N	N	N	N	N	0



Detection Bandwidth Test - IEEE 802.11ac 80MHz  
EUT Frequency: 5530MHz  
EUT 99% Power bandwidth: 76.6MHz  
Detection bandwidth limit (80% of EUT 99% Power bandwidth): 61.28MHz  
Detection bandwidth (5570(FH) – 5490(FL)) : 80MHz  
Test Result : PASS

Radar Frequency (MHz)	Trial Number / Detection										Detection Rate (%)
	1	2	3	4	5	6	7	8	9	10	
5489	N	N	N	N	N	N	N	N	N	N	0
5490(FL)	Y	Y	Y	Y	Y	Y	Y	Y	Y	Y	100
5491	Y	Y	Y	Y	Y	Y	Y	Y	Y	Y	100
5492	Y	Y	Y	Y	Y	Y	Y	Y	Y	Y	100
5493	Y	Y	Y	Y	Y	Y	Y	Y	Y	Y	100
5494	Y	Y	Y	Y	Y	Y	Y	Y	Y	Y	100
5495	Y	Y	Y	Y	Y	Y	Y	Y	Y	Y	100
5496	Y	Y	Y	Y	Y	Y	Y	Y	Y	Y	100
5497	Y	Y	Y	Y	Y	Y	Y	Y	Y	Y	100
5498	Y	Y	Y	Y	Y	Y	Y	Y	Y	Y	100
5499	Y	Y	Y	Y	Y	Y	Y	Y	Y	Y	100
5500	Y	Y	Y	Y	Y	Y	Y	Y	Y	Y	100
5501	Y	Y	Y	Y	Y	Y	Y	Y	Y	Y	100
5502	Y	Y	Y	Y	Y	Y	Y	Y	Y	Y	100
5503	Y	Y	Y	Y	Y	Y	Y	Y	Y	Y	100
5504	Y	Y	Y	Y	Y	Y	Y	Y	Y	Y	100
5505	Y	Y	Y	Y	Y	Y	Y	Y	Y	Y	100
5506	Y	Y	Y	Y	Y	Y	Y	Y	Y	Y	100
5507	Y	Y	Y	Y	Y	Y	Y	Y	Y	Y	100
5508	Y	Y	Y	Y	Y	Y	Y	Y	Y	Y	100
5509	Y	Y	Y	Y	Y	Y	Y	Y	Y	Y	100
5510	Y	Y	Y	Y	Y	Y	Y	Y	Y	Y	100
5511	Y	Y	Y	Y	Y	Y	Y	Y	Y	Y	100
5512	Y	Y	Y	Y	Y	Y	Y	Y	Y	Y	100
5513	Y	Y	Y	Y	Y	Y	Y	Y	Y	Y	100
5514	Y	Y	Y	Y	Y	Y	Y	Y	Y	Y	100
5515	Y	Y	Y	Y	Y	Y	Y	Y	Y	Y	100
5516	Y	Y	Y	Y	Y	Y	Y	Y	Y	Y	100
5517	Y	Y	Y	Y	Y	Y	Y	Y	Y	Y	100
5518	Y	Y	Y	Y	Y	Y	Y	Y	Y	Y	100
5519	Y	Y	Y	Y	Y	Y	Y	Y	Y	Y	100
5520	Y	Y	Y	Y	Y	Y	Y	Y	Y	Y	100
5521	Y	Y	Y	Y	Y	Y	Y	Y	Y	Y	100
5522	Y	Y	Y	Y	Y	Y	Y	Y	Y	Y	100
5523	Y	Y	Y	Y	Y	Y	Y	Y	Y	Y	100
5524	Y	Y	Y	Y	Y	Y	Y	Y	Y	Y	100
5525	Y	Y	Y	Y	Y	Y	Y	Y	Y	Y	100
5526	Y	Y	Y	Y	Y	Y	Y	Y	Y	Y	100
5527	Y	Y	Y	Y	Y	Y	Y	Y	Y	Y	100
5528	Y	Y	Y	Y	Y	Y	Y	Y	Y	Y	100
5529	Y	Y	Y	Y	Y	Y	Y	Y	Y	Y	100
5530	Y	Y	Y	Y	Y	Y	Y	Y	Y	Y	100
5531	Y	Y	Y	Y	Y	Y	Y	Y	Y	Y	100





A D T

Radar Frequency (MHz)	Trial Number / Detection										Detection Rate (%)
	1	2	3	4	5	6	7	8	9	10	
5532	Y	Y	Y	Y	Y	Y	Y	Y	Y	Y	100
5533	Y	Y	Y	Y	Y	Y	Y	Y	Y	Y	100
5534	Y	Y	Y	Y	Y	Y	Y	Y	Y	Y	100
5535	Y	Y	Y	Y	Y	Y	Y	Y	Y	Y	100
5536	Y	Y	Y	Y	Y	Y	Y	Y	Y	Y	100
5537	Y	Y	Y	Y	Y	Y	Y	Y	Y	Y	100
5538	Y	Y	Y	Y	Y	Y	Y	Y	Y	Y	100
5539	Y	Y	Y	Y	Y	Y	Y	Y	Y	Y	100
5540	Y	Y	Y	Y	Y	Y	Y	Y	Y	Y	100
5541	Y	Y	Y	Y	Y	Y	Y	Y	Y	Y	100
5542	Y	Y	Y	Y	Y	Y	Y	Y	Y	Y	100
5543	Y	Y	Y	Y	Y	Y	Y	Y	Y	Y	100
5544	Y	Y	Y	Y	Y	Y	Y	Y	Y	Y	100
5545	Y	Y	Y	Y	Y	Y	Y	Y	Y	Y	100
5546	Y	Y	Y	Y	Y	Y	Y	Y	Y	Y	100
5547	Y	Y	Y	Y	Y	Y	Y	Y	Y	Y	100
5548	Y	Y	Y	Y	Y	Y	Y	Y	Y	Y	100
5549	Y	Y	Y	Y	Y	Y	Y	Y	Y	Y	100
5550	Y	Y	Y	Y	Y	Y	Y	Y	Y	Y	100
5551	Y	Y	Y	Y	Y	Y	Y	Y	Y	Y	100
5552	Y	Y	Y	Y	Y	Y	Y	Y	Y	Y	100
5553	Y	Y	Y	Y	Y	Y	Y	Y	Y	Y	100
5554	Y	Y	Y	Y	Y	Y	Y	Y	Y	Y	100
5555	Y	Y	Y	Y	Y	Y	Y	Y	Y	Y	100
5556	Y	Y	Y	Y	Y	Y	Y	Y	Y	Y	100
5557	Y	Y	Y	Y	Y	Y	Y	Y	Y	Y	100
5558	Y	Y	Y	Y	Y	Y	Y	Y	Y	Y	100
5559	Y	Y	Y	Y	Y	Y	Y	Y	Y	Y	100
5560	Y	Y	Y	Y	Y	Y	Y	Y	Y	Y	100
5561	Y	Y	Y	Y	Y	Y	Y	Y	Y	Y	100
5562	Y	Y	Y	Y	Y	Y	Y	Y	Y	Y	100
5563	Y	Y	Y	Y	Y	Y	Y	Y	Y	Y	100
5564	Y	Y	Y	Y	Y	Y	Y	Y	Y	Y	100
5565	Y	Y	Y	Y	Y	Y	Y	Y	Y	Y	100
5566	Y	Y	Y	Y	Y	Y	Y	Y	Y	Y	100
5567	Y	Y	Y	Y	Y	Y	Y	Y	Y	Y	100
5568	Y	Y	Y	Y	Y	Y	Y	Y	Y	Y	100
5569	Y	Y	Y	Y	Y	Y	Y	Y	Y	Y	100
5570(FH)	Y	Y	Y	Y	Y	Y	Y	Y	Y	Y	100
5571	N	N	N	N	N	N	N	N	N	N	0

### 6.2.3 CHANNEL AVAILABILITY CHECK TIME

If the EUT successfully detected the radar burst, it should be observed as the EUT has no transmissions occurred until the EUT starts transmitting on another channel.

Timing of Radar Signal	Observation	
	EUT	Spectrum Analyzer
Within 1 to 6 second	Detected	No transmissions
Within 54 to 60 second	Detected	No transmissions

#### Initial Channel Availability Check Time

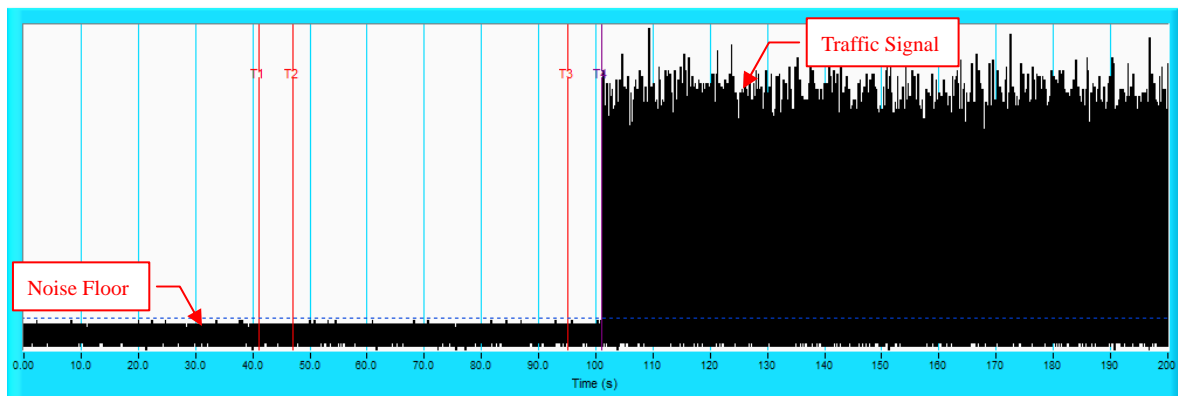

**NOTE:** T1 denotes the end of power-up time period is 41<sup>th</sup> second. T4 denotes the end of Channel Availability Check time is 101<sup>th</sup> second. Channel Availability Check time is equal to ( T4 – T1) 60 seconds.

### Radar Burst at the Beginning of the Channel Availability Check Time

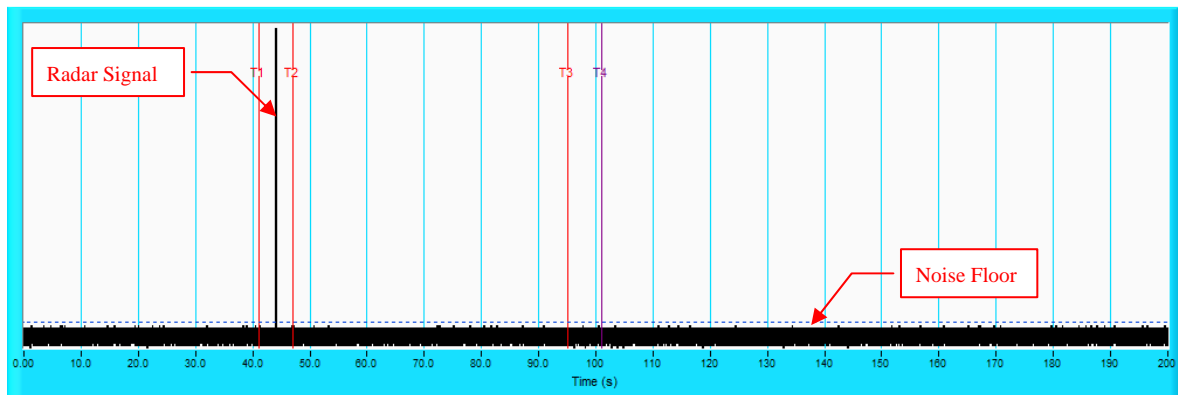

**NOTE:** T1 denotes the end of power up time period is 41 second. T2 denotes 47 second, the radar burst was commenced within a 6 second window starting from the end of power-up sequence. T4 denotes the 101 second.

### Radar Burst at the End of the Channel Availability Check Time

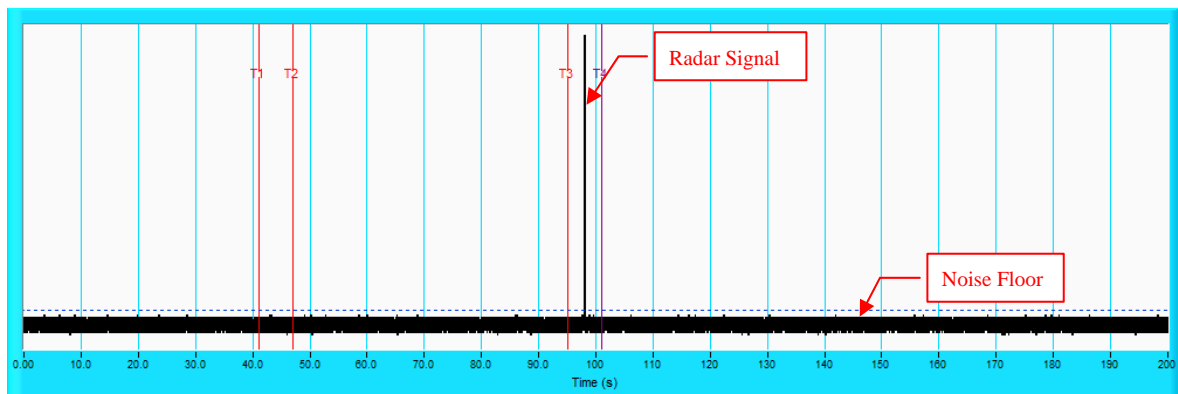

**NOTE:** T1 denotes the end of power up time period is 41 second. T3 denotes 95<sup>h</sup> second and radar burst was commenced within 54<sup>th</sup> second to 60<sup>th</sup> second window starting from the end of power-up sequence. T4 denotes the 101<sup>h</sup> second.

## 6.2.4 CHANNEL CLOSING TRANSMISSION AND CHANNEL MOVE TIME

### Wireless Traffic Loading

#### IEEE 802.11n 20MHz

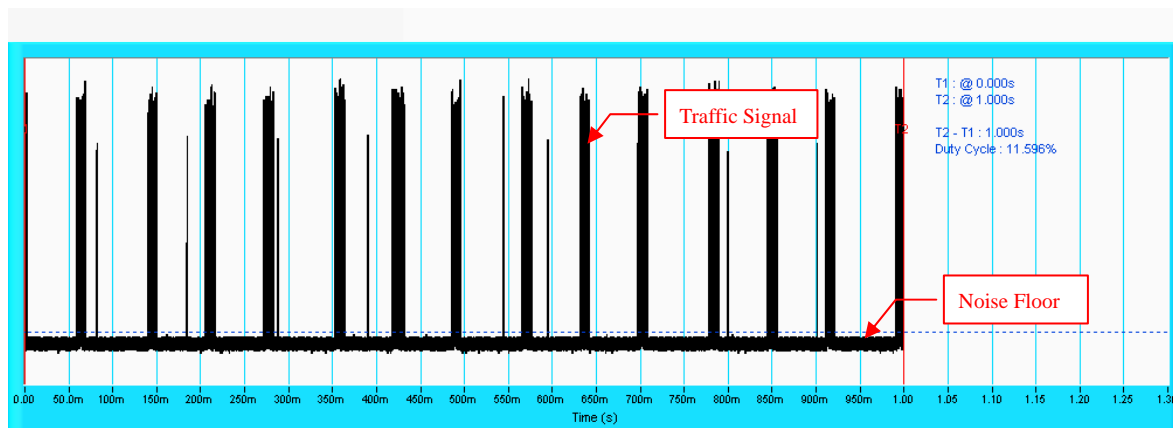

#### IEEE 802.11n 40MHz



#### IEEE 802.11ac 80MHz

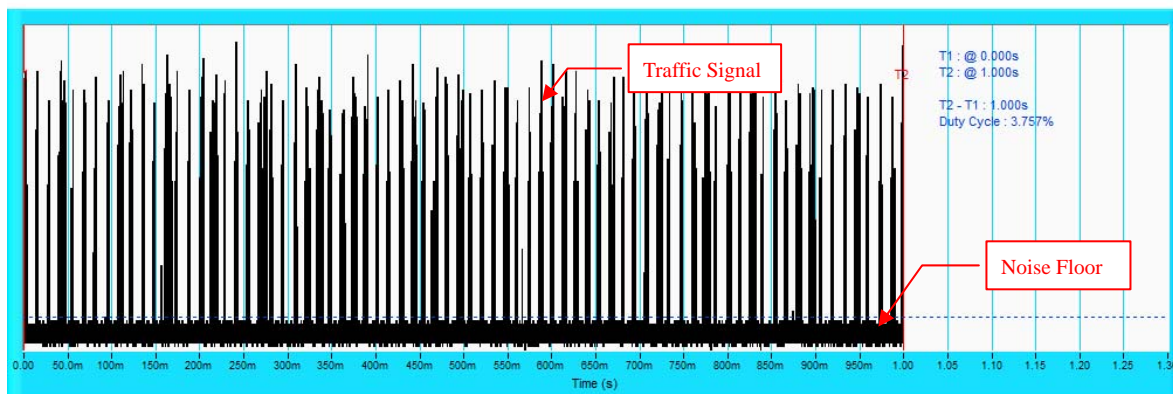



## IEEE 802.11n 20MHz

**Table 1: Short Pulse Radar Test Waveforms.**

Radar Type	Pulse Width (µsec)	PRI (µsec)	Number of Pulses	Number of Trials(Times)	Percentage of Successful Detection (%)
1	1	1428	18	30	100
2	1-5	150-230	23-29	30	90
3	6-10	200-500	16-18	30	90
4	11-20	200-500	12-16	30	90
Aggregate (Radar Types 1-4)				120	92.5

**Table 2: Long Pulse Radar Test Waveform**

Radar Type	Pulse Width (µsec)	Chirp Width (MHz)	PRI (µsec)	Number of Pulses per Burst	Number of Bursts	Number of Trials(Times)	Percentage of Successful Detection (%)
5	50-100	5-20	1000-2000	1-3	8-20	30	83.3

**Table 3: Frequency Hopping Radar Test Waveform**

Radar Type	Pulse Width (µsec)	PRI (µsec)	Pulses per Hop	Hopping Rate (kHz)	Hopping Sequence Length (msec)	Number of Trials(Times)	Percentage of Successful Detection (%)
6	1	333	9	0.333	300	30	96.7

The Detailed Radar pattern and Statistical Performance showed in Annex A.

**IEEE 802.11n 40MHz****Table 1: Short Pulse Radar Test Waveforms.**

Radar Type	Pulse Width (µsec)	PRI (µsec)	Number of Pulses	Number of Trials(Times)	Percentage of Successful Detection (%)
1	1	1428	18	30	93.3
2	1-5	150-230	23-29	30	86.7
3	6-10	200-500	16-18	30	90
4	11-20	200-500	12-16	30	86.7
Aggregate (Radar Types 1-4)				120	89.175

**Table 2: Long Pulse Radar Test Waveform**

Radar Type	Pulse Width (µsec)	Chirp Width (MHz)	PRI (µsec)	Number of Pulses per Burst	Number of Bursts	Number of Trials(Times)	Percentage of Successful Detection (%)
5	50-100	5-20	1000-2000	1-3	8-20	30	83.3

**Table 3: Frequency Hopping Radar Test Waveform**

Radar Type	Pulse Width (µsec)	PRI (µsec)	Pulses per Hop	Hopping Rate (kHz)	Hopping Sequence Length (msec)	Number of Trials(Times)	Percentage of Successful Detection (%)
6	1	333	9	0.333	300	30	100

The Detailed Radar pattern and Statistical Performance showed in Annex A.



### IEEE 802.11ac 80MHz

**Table 1: Short Pulse Radar Test Waveforms.**

Radar Type	Pulse Width (µsec)	PRI (µsec)	Number of Pulses	Number of Trials(Times)	Percentage of Successful Detection (%)
1	1	1428	18	30	96.7
2	1-5	150-230	23-29	30	86.7
3	6-10	200-500	16-18	30	86.7
4	11-20	200-500	12-16	30	86.7
Aggregate (Radar Types 1-4)				120	89.2

**Table 2: Long Pulse Radar Test Waveform**

Radar Type	Pulse Width (µsec)	Chirp Width (MHz)	PRI (µsec)	Number of Pulses per Burst	Number of Bursts	Number of Trials(Times)	Percentage of Successful Detection (%)
5	50-100	5-20	1000-2000	1-3	8-20	30	90

**Table 3: Frequency Hopping Radar Test Waveform**

Radar Type	Pulse Width (µsec)	PRI (µsec)	Pulses per Hop	Hopping Rate (kHz)	Hopping Sequence Length (msec)	Number of Trials(Times)	Percentage of Successful Detection (%)
6	1	333	9	0.333	300	30	93.3

The Detailed Radar pattern and Statistical Performance showed in Annex A.

### Radar signal 1

IEEE 802.11n 20MHz

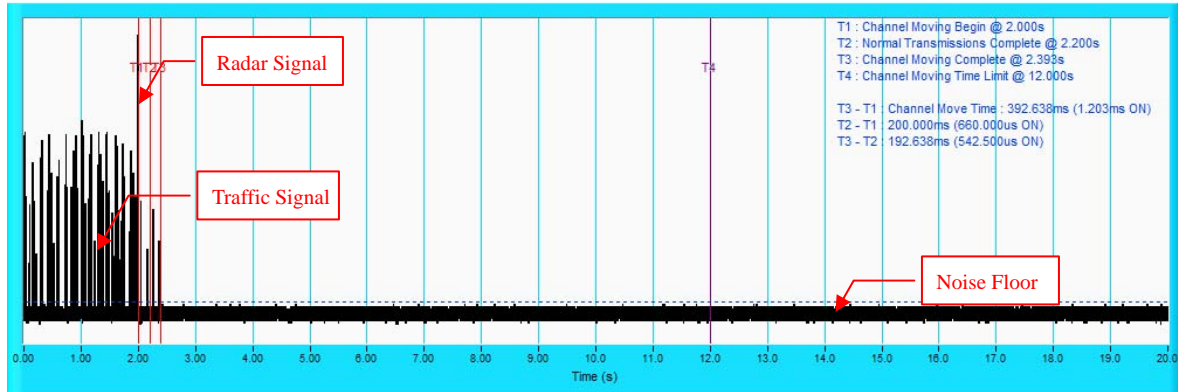

**NOTE:** T1 denotes the start of Channel Move Time upon the end of the last Radar burst. T2 denotes the data transmission time of 200ms from T1. T3 denotes the end of Channel Move Time. T4 denotes the 10 second from T1 to observe the aggregate duration of transmissions.

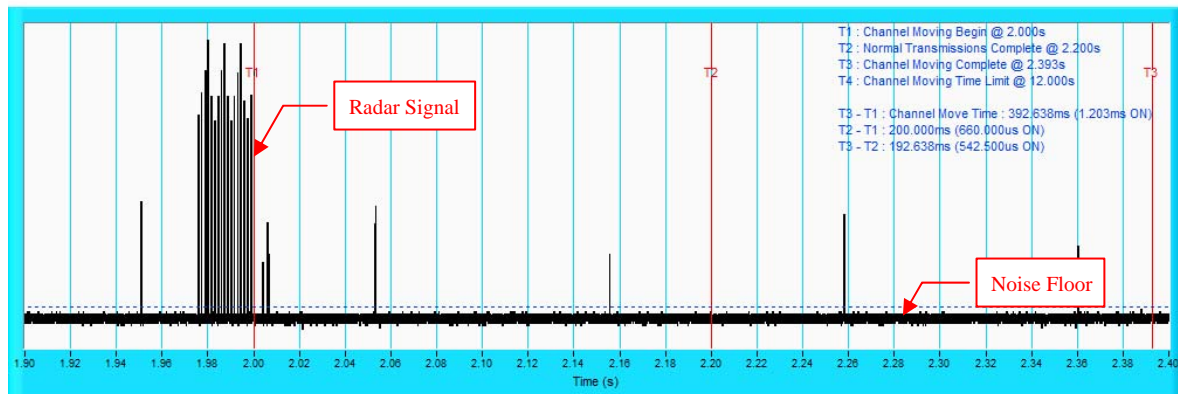

**NOTE:** Room-in of the first 500ms after radar signal applied.



## Radar signal 2

IEEE 802.11n 20MHz

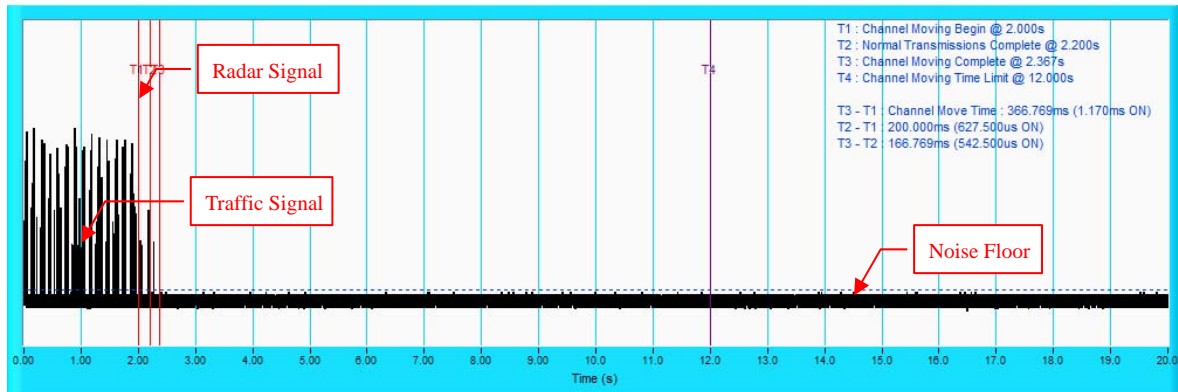

**NOTE:** T1 denotes the start of Channel Move Time upon the end of the last Radar burst. T2 denotes the data transmission time of 200ms from T1. T3 denotes the end of Channel Move Time. T4 denotes the 10 second from T1 to observe the aggregate duration of transmissions.

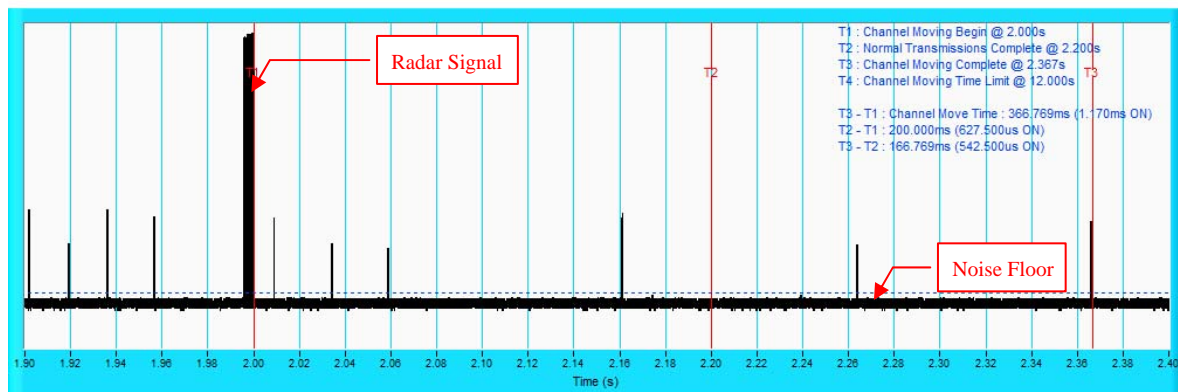

**NOTE:** Room-in of the first 500ms after radar signal applied.

### Radar signal 3

IEEE 802.11n 20MHz

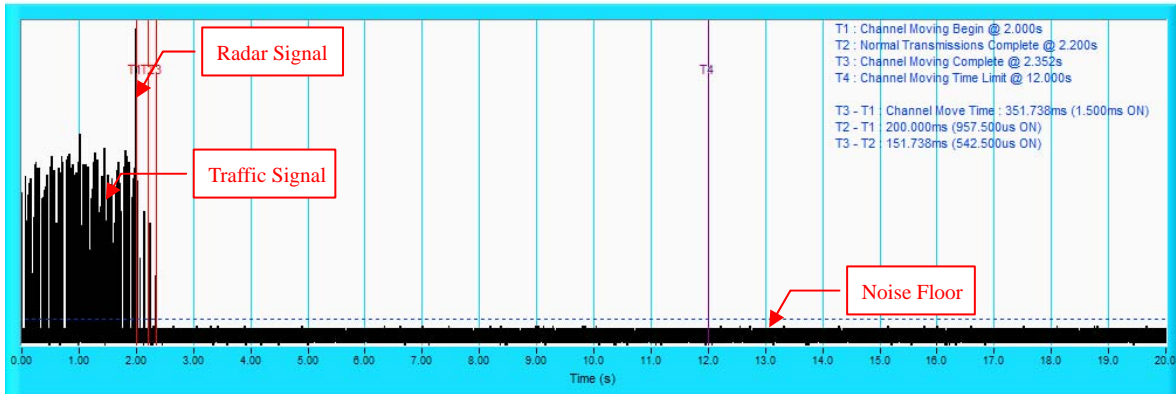

**NOTE:** T1 denotes the start of Channel Move Time upon the end of the last Radar burst. T2 denotes the data transmission time of 200ms from T1. T3 denotes the end of Channel Move Time. T4 denotes the 10 second from T1 to observe the aggregate duration of transmissions.

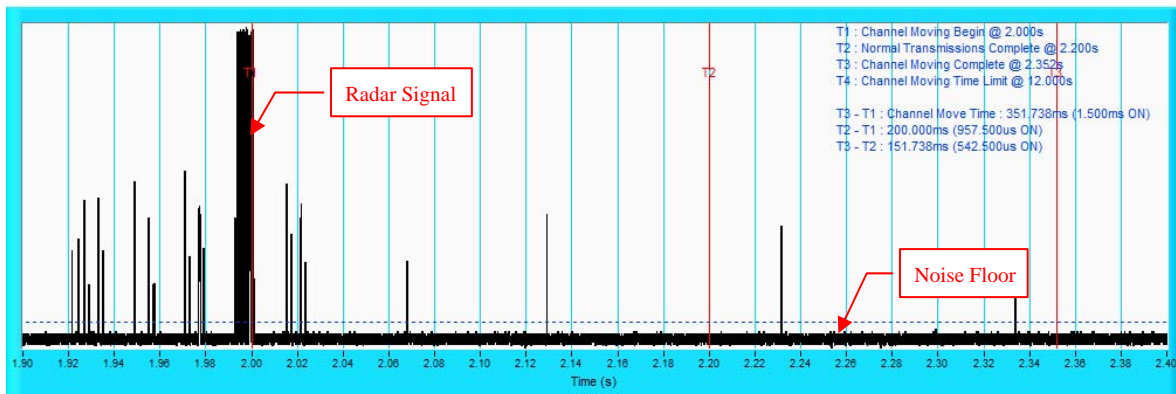

**NOTE:** Room-in of the first 500ms after radar signal applied.

### Radar signal 4

IEEE 802.11n 20MHz

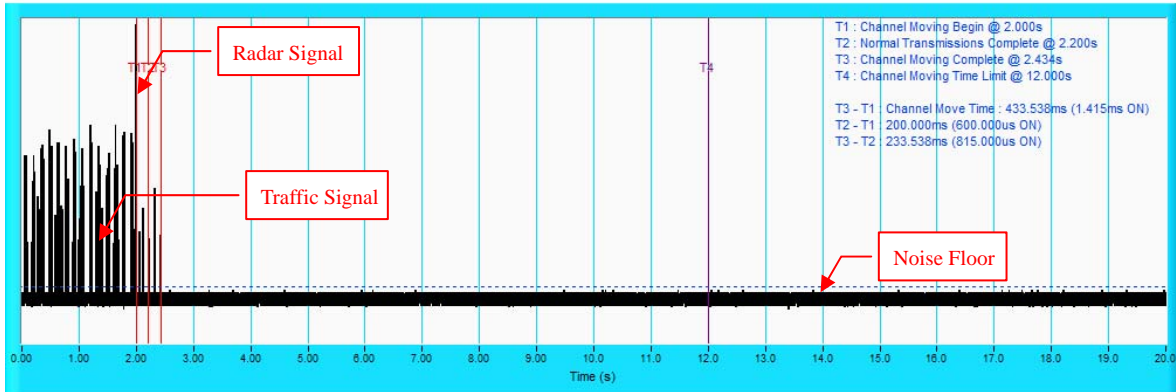

**NOTE:** T1 denotes the start of Channel Move Time upon the end of the last Radar burst. T2 denotes the data transmission time of 200ms from T1. T3 denotes the end of Channel Move Time. T4 denotes the 10 second from T1 to observe the aggregate duration of transmissions.

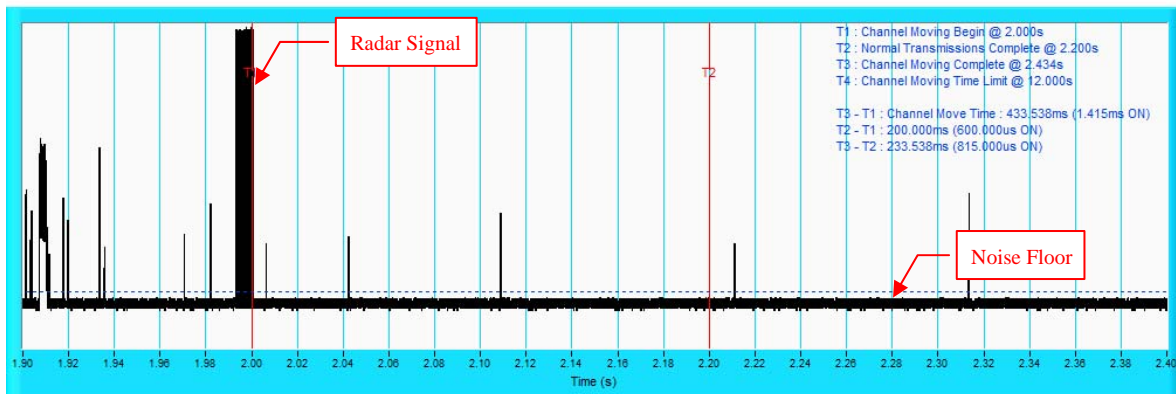

**NOTE:** Room-in of the first 500ms after radar signal applied.

### Radar signal 5

IEEE 802.11n 20MHz

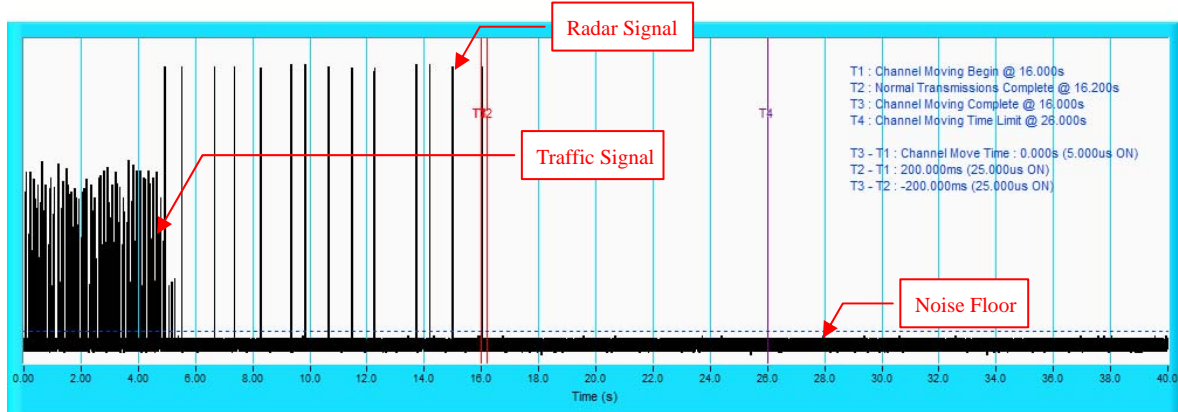

**NOTE:** T1 denotes the start of Channel Move Time upon the end of the last Radar burst. T2 denotes the data transmission time of 200ms from T1. T3 denotes the end of Channel Move Time. T4 denotes the 10 second from T1 to observe the aggregate duration of transmissions.

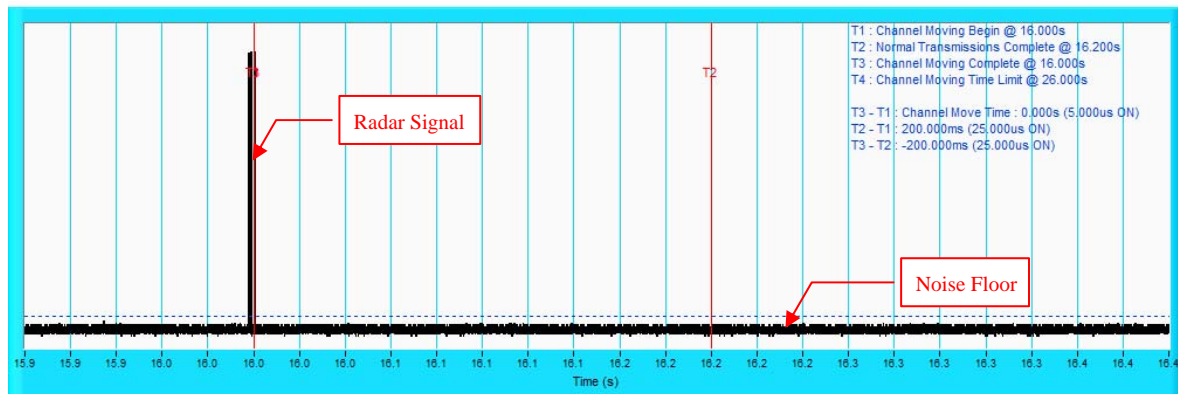

**NOTE:** Room-in of the first 500ms after radar signal applied.

### Radar signal 6

IEEE 802.11n 20MHz

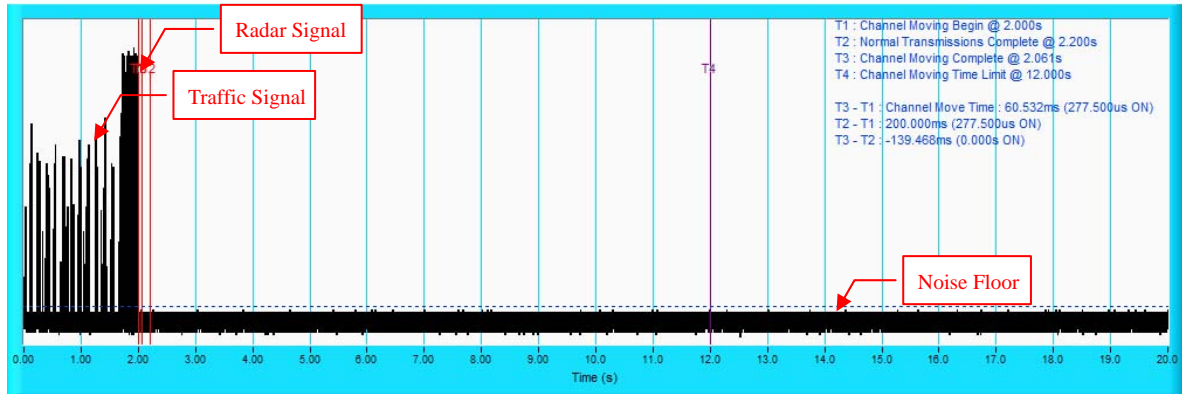

**NOTE:** T1 denotes the start of Channel Move Time upon the end of the last Radar burst. T2 denotes the data transmission time of 200ms from T1. T3 denotes the end of Channel Move Time. T4 denotes the 10 second from T1 to observe the aggregate duration of transmissions.

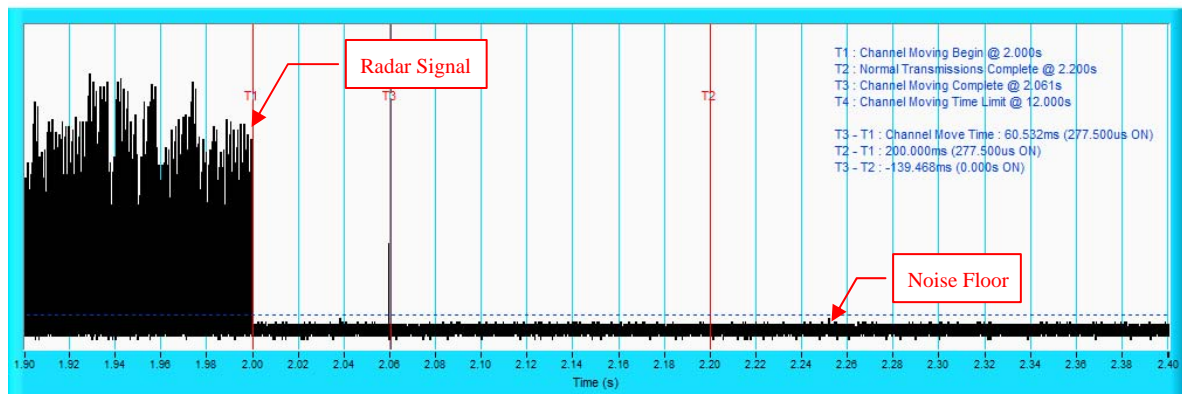

**NOTE:** Room-in of the first 500ms after radar signal applied.

## 6.2.5 NON- OCCUPANCY PERIOD

### Associate test:

During the 30 minutes observation time, UUT did not make any transmissions on a channel after a radar signal was detected on that channel by either the Channel Availability Check or the In-Service Monitoring.

1) EUT (Client) links with master on 5500MHz.

Waveform of EUT links up with Master

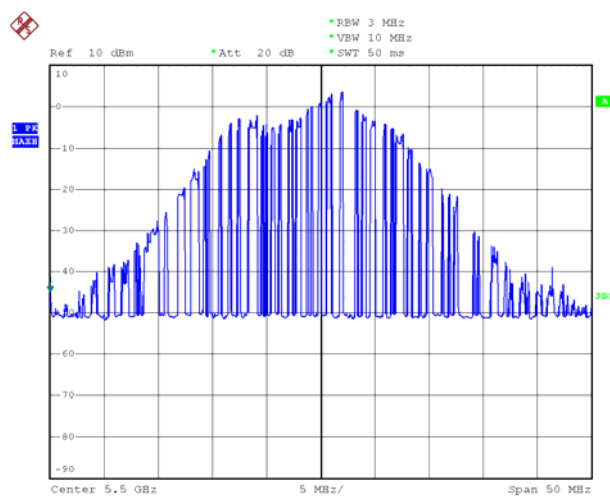

2) Client plays specified files via master.

Waveform of transmission

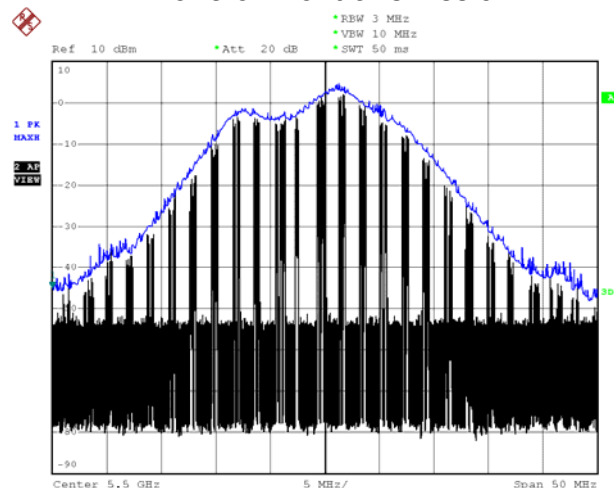

3) Radar signal is applied to the Master device and WiFi traffic signal stop immediately.

**Radar 1**



**Radar 2**

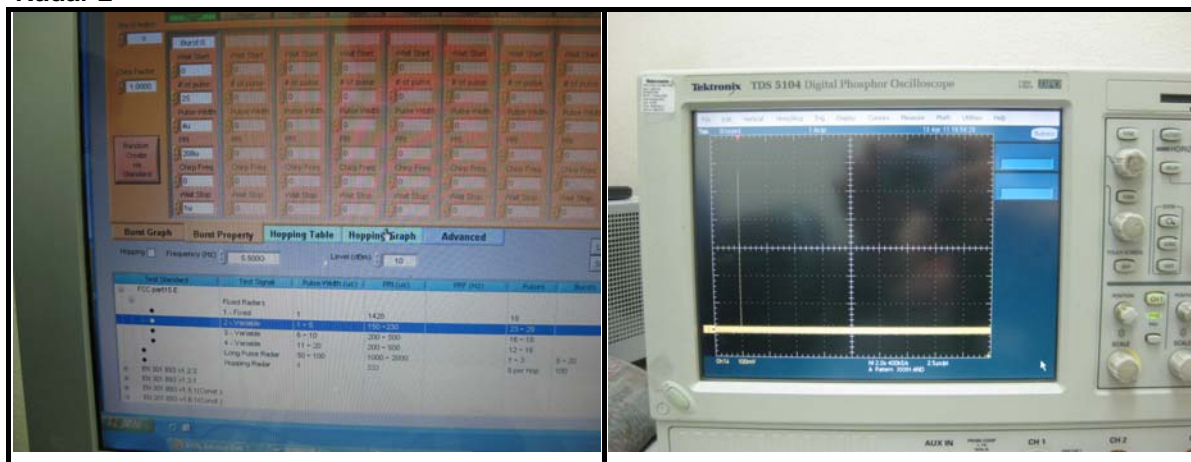

**Radar 3**

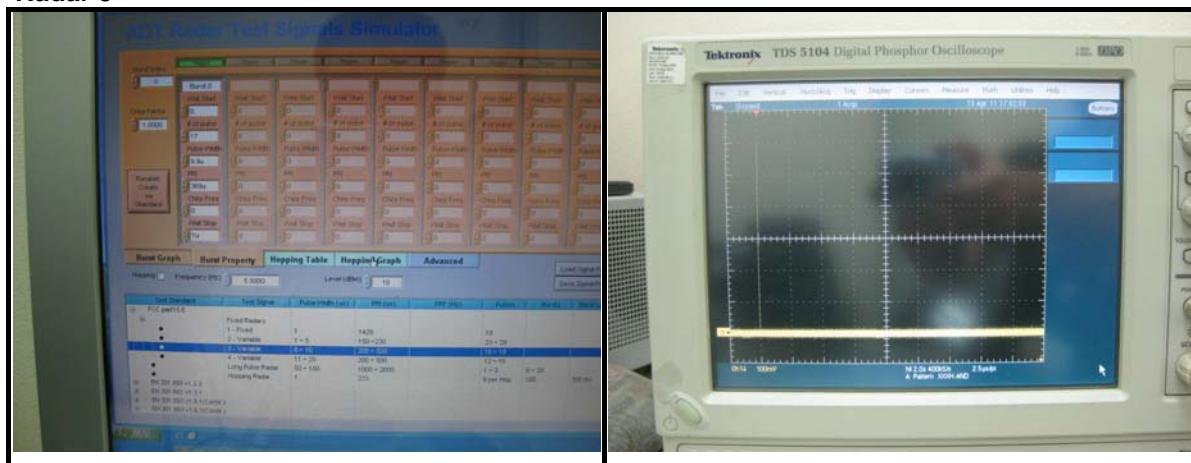

**Radar 4**

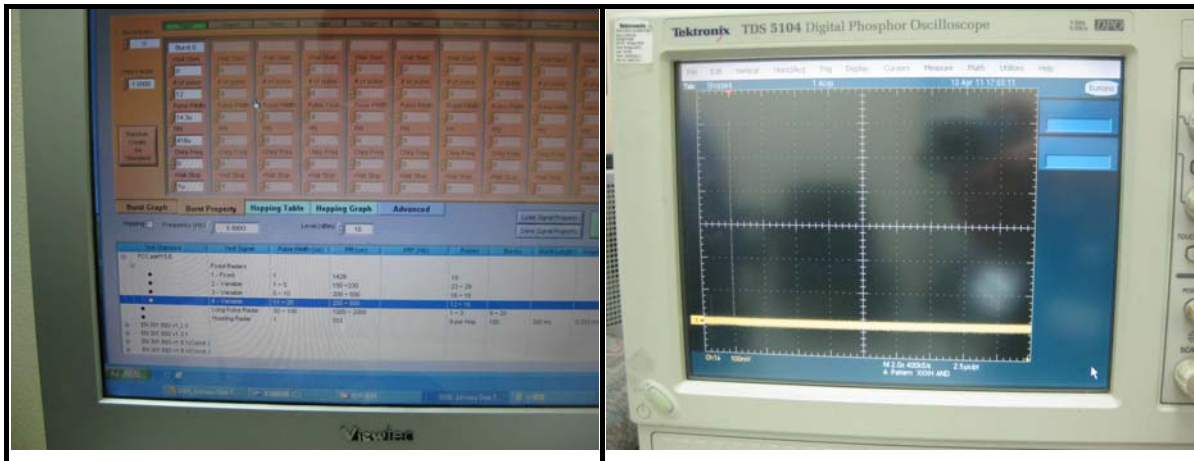

**Radar 5**



**Radar 6**





4) 5510MHz has been monitored in 30 minutes period. In this period, no any transmission occurs.

Plot of 30minutes period

802.11n 20MHz

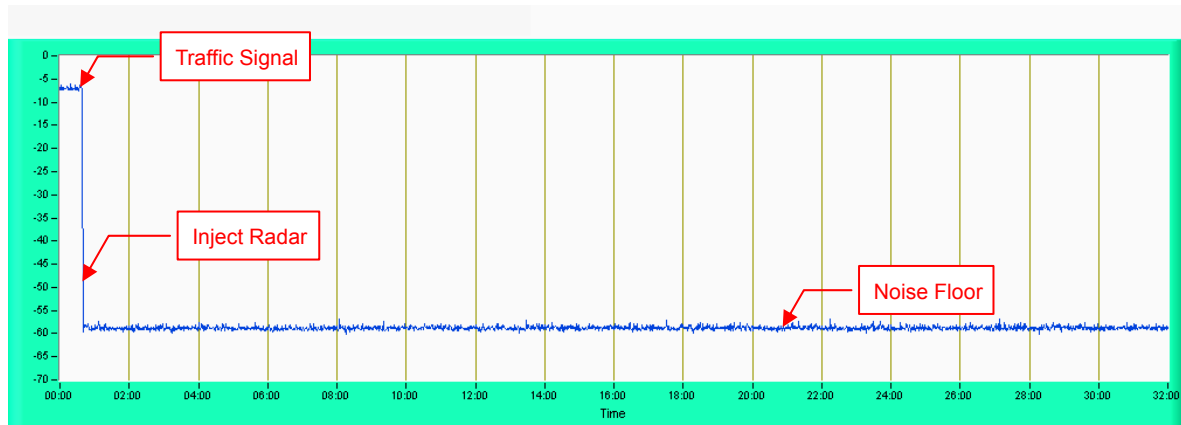

**NOTE:** Test setup are shown on Test setup photo.pdf

## 6.2.6 UNIFORM SPREADING

The intention of the uniform spreading is to provide, on aggregate, a uniform loading of the spectrum. The EUT randomly select next output channel without any bias or fixed pattern, so that all channels in DFS bands (5250 to 5350MHz and 5470 to 5725 MHz) will be used equally.

## 6.2.7 TRANSMIT POWER CONTROL (TPC)

According to FCC 15.407(h)(1) the TPC mechanism is not required for system with an E.I.R.P. of less 500mW.



## 7. INFORMATION ON THE TESTING LABORATORIES

We, Bureau Veritas Consumer Products Services (H.K.) Ltd., Taoyuan Branch, were founded in 1988 to provide our best service in EMC, Radio, Telecom and Safety consultation. Our laboratories are accredited and approved according to ISO/IEC 17025.

If you have any comments, please feel free to contact us at the following:

**Linko EMC/RF Lab**

Tel: 886-2-26052180

Fax: 886-2-26051924

**Hsin Chu EMC/RF/Telecom Lab**

Tel: 886-3-5935343

Fax: 886-3-5935342

**Hwa Ya EMC/RF/Safety Lab**

Tel: 886-3-3183232

Fax: 886-3-3270892

**Email:** [service.adt@tw.bureauveritas.com](mailto:service.adt@tw.bureauveritas.com)

**Web Site:** [www.bureauveritas-adt.com](http://www.bureauveritas-adt.com)

The address and road map of all our labs can be found in our web site also.



## **APPENDIX A - MODIFICATIONS RECORDERS FOR ENGINEERING CHANGES TO THE EUT BY THE LAB**

No modifications were made to the EUT by the lab during the test.

**---END---**

## Annex-A

### Annex A.1 : The Detailed Radar pattern and Statistical Performance

#### IEEE 802.11n 20MHz

Type 1 Radar Statistical Performances				
Trial #	Pulses per Burst	Pulse Width (s)	PRI (s)	Detection
1	18	1.0u	1.428m	Yes
2	18	1.0u	1.428m	Yes
3	18	1.0u	1.428m	Yes
4	18	1.0u	1.428m	Yes
5	18	1.0u	1.428m	Yes
6	18	1.0u	1.428m	Yes
7	18	1.0u	1.428m	Yes
8	18	1.0u	1.428m	Yes
9	18	1.0u	1.428m	Yes
10	18	1.0u	1.428m	Yes
11	18	1.0u	1.428m	Yes
12	18	1.0u	1.428m	Yes
13	18	1.0u	1.428m	Yes
14	18	1.0u	1.428m	Yes
15	18	1.0u	1.428m	Yes
16	18	1.0u	1.428m	Yes
17	18	1.0u	1.428m	Yes
18	18	1.0u	1.428m	Yes
19	18	1.0u	1.428m	Yes
20	18	1.0u	1.428m	Yes
21	18	1.0u	1.428m	Yes
22	18	1.0u	1.428m	Yes
23	18	1.0u	1.428m	Yes
24	18	1.0u	1.428m	Yes
25	18	1.0u	1.428m	Yes
26	18	1.0u	1.428m	Yes
27	18	1.0u	1.428m	Yes
28	18	1.0u	1.428m	Yes
29	18	1.0u	1.428m	Yes
30	18	1.0u	1.428m	Yes
				Detection Rate: 100.0 %

Type 2 Radar Statistical Performances				
Trial #	Pulses per Burst	Pulse Width (s)	PRI (s)	Detection
1	24	4.5u	192.0u	Yes
2	24	4.6u	176.0u	Yes
3	28	2.4u	186.0u	Yes
4	23	3.9u	151.0u	Yes
5	23	1.5u	153.0u	Yes
6	27	2.6u	197.0u	No
7	26	1.1u	224.0u	Yes
8	25	1.3u	195.0u	Yes
9	28	2.7u	223.0u	Yes
10	27	2.0u	155.0u	Yes
11	29	1.5u	222.0u	Yes
12	23	3.6u	177.0u	Yes
13	25	2.5u	160.0u	Yes
14	28	3.5u	159.0u	Yes
15	26	4.5u	159.0u	No
16	24	5.0u	151.0u	Yes
17	26	2.8u	181.0u	Yes
18	26	1.4u	198.0u	Yes
19	25	2.3u	182.0u	Yes
20	28	4.1u	175.0u	Yes
21	24	4.0u	207.0u	Yes
22	25	2.7u	218.0u	Yes
23	26	1.2u	151.0u	Yes
24	23	1.5u	199.0u	Yes
25	27	1.5u	182.0u	Yes
26	26	4.9u	219.0u	Yes
27	27	2.0u	193.0u	Yes
28	25	3.0u	152.0u	Yes
29	26	3.8u	219.0u	Yes
30	28	4.9u	170.0u	No
				Detection Rate: 90.0 %

Type 3 Radar Statistical Performances				
Trial #	Pulses per Burst	Pulse Width (s)	PRI (s)	Detection
1	16	7.0u	231.0u	Yes
2	16	8.8u	424.0u	Yes
3	17	6.8u	487.0u	Yes
4	17	9.3u	446.0u	Yes
5	17	8.5u	302.0u	Yes
6	18	7.5u	371.0u	Yes
7	17	9.4u	334.0u	Yes
8	17	9.9u	218.0u	Yes
9	16	8.0u	320.0u	Yes
10	16	6.2u	493.0u	Yes
11	17	8.7u	404.0u	Yes
12	18	9.6u	393.0u	Yes
13	18	8.6u	245.0u	Yes
14	16	7.1u	379.0u	Yes
15	17	7.4u	438.0u	Yes
16	17	9.6u	224.0u	Yes
17	17	6.6u	207.0u	No
18	17	9.7u	420.0u	Yes
19	17	9.3u	320.0u	Yes
20	16	8.0u	458.0u	No
21	17	7.0u	278.0u	Yes
22	17	7.4u	415.0u	Yes
23	17	7.6u	342.0u	Yes
24	17	8.9u	379.0u	Yes
25	18	8.0u	252.0u	Yes
26	17	6.9u	459.0u	Yes
27	17	8.2u	493.0u	Yes
28	17	6.4u	244.0u	No
29	17	6.8u	414.0u	Yes
30	18	8.0u	232.0u	Yes
				Detection Rate: 90.0 %

Type 4 Radar Statistical Performances				
Trial #	Pulses per Burst	Pulse Width (s)	PRI (s)	Detection
1	15	12.1u	371.0u	Yes
2	15	11.6u	370.0u	Yes
3	15	16.0u	385.0u	Yes
4	15	18.7u	426.0u	Yes
5	16	12.3u	266.0u	Yes
6	15	17.4u	462.0u	Yes
7	13	19.1u	500.0u	Yes
8	14	17.8u	397.0u	Yes
9	14	18.3u	269.0u	Yes
10	14	18.7u	435.0u	Yes
11	15	16.2u	328.0u	Yes
12	14	15.9u	374.0u	Yes
13	14	14.5u	426.0u	Yes
14	16	18.1u	424.0u	Yes
15	12	15.2u	259.0u	Yes
16	13	19.2u	223.0u	Yes
17	14	14.7u	217.0u	No
18	14	15.7u	398.0u	Yes
19	13	12.2u	397.0u	Yes
20	16	18.3u	214.0u	Yes
21	13	14.2u	491.0u	Yes
22	13	13.1u	405.0u	Yes
23	12	13.4u	255.0u	No
24	14	14.4u	432.0u	Yes
25	12	12.2u	303.0u	Yes
26	15	14.3u	491.0u	Yes
27	13	17.2u	458.0u	Yes
28	13	13.6u	354.0u	Yes
29	14	12.0u	479.0u	No
30	14	17.8u	260.0u	Yes
				Detection Rate: 90.0 %

Type 5 Radar Statistical Performances		
Trial #	Test Signal Name	Detection
1	LP_Signal_01	Yes
2	LP_Signal_02	Yes
3	LP_Signal_03	Yes
4	LP_Signal_04	Yes
5	LP_Signal_05	Yes
6	LP_Signal_06	Yes
7	LP_Signal_07	Yes
8	LP_Signal_08	Yes
9	LP_Signal_09	Yes
10	LP_Signal_10	Yes
11	LP_Signal_11	Yes
12	LP_Signal_12	Yes
13	LP_Signal_13	Yes
14	LP_Signal_14	Yes
15	LP_Signal_15	Yes
16	LP_Signal_16	Yes
17	LP_Signal_17	Yes
18	LP_Signal_18	No
19	LP_Signal_19	No
20	LP_Signal_20	Yes
21	LP_Signal_21	Yes
22	LP_Signal_22	No
23	LP_Signal_23	No
24	LP_Signal_24	No
25	LP_Signal_25	Yes
26	LP_Signal_26	Yes
27	LP_Signal_27	Yes
28	LP_Signal_28	Yes
29	LP_Signal_29	Yes
30	LP_Signal_30	Yes
		Detection Rate: 83.3 %



Long Pulse Radar Test Signal						
Test Signal Name: LP_Signal_01						
Number of Bursts in Trial: 17						
Burst	Pulses per Burst	Chrip (Hz)	Pulse Width (s)	Pulse 1 to 2 Spacing (s)	Pulse 2 to 3 Spacing (s)	Start Location (s)
1	3	12M	79.5u	1.705m	1.445m	362.4m
2	2	18M	69.9u	1.602m	-	523.1m
3	3	18M	70.8u	1.255m	1.794m	353.4m
4	1	11M	86.2u	-	-	401.1m
5	2	19M	92.9u	1.810m	-	119.5m
6	2	12M	55.4u	1.331m	-	323.8m
7	2	9M	96.6u	1.406m	-	284.8m
8	2	12M	74.4u	1.213m	-	30.24m
9	3	17M	74.1u	1.752m	1.858m	98.58m
10	3	20M	96.3u	967.7u	1.566m	391.9m
11	2	7M	66.2u	1.650m	-	503.8m
12	3	8M	65.2u	1.218m	1.706m	286.2m
13	2	9M	81.5u	1.875m	-	288.0m
14	3	12M	63.9u	1.622m	1.383m	103.7m
15	1	17M	82.9u	-	-	530.4m
16	2	9M	72.5u	1.271m	-	172.0m
17	2	19M	99.3u	1.461m	-	132.0m

Long Pulse Radar Test Signal						
Test Signal Name: LP_Signal_02						
Number of Bursts in Trial: 15						
Burst	Pulses per Burst	Chrip (Hz)	Pulse Width (s)	Pulse 1 to 2 Spacing (s)	Pulse 2 to 3 Spacing (s)	Start Location (s)
1	2	12M	63.4u	1.747m	-	402.8m
2	1	11M	92.8u	-	-	680.9m
3	1	8M	51.2u	-	-	480.0m
4	1	6M	69.0u	-	-	394.9m
5	3	20M	85.0u	1.161m	1.795m	365.1m
6	2	18M	73.3u	1.770m	-	84.27m
7	2	9M	72.0u	1.545m	-	419.2m
8	2	12M	90.3u	1.566m	-	287.3m
9	2	6M	83.2u	936.8u	-	460.7m
10	2	15M	56.2u	985.8u	-	356.1m
11	3	18M	56.5u	1.253m	1.256m	746.0m
12	2	19M	68.9u	1.080m	-	197.1m
13	3	18M	83.7u	1.845m	1.883m	393.6m
14	1	14M	66.5u	-	-	434.6m
15	2	8M	80.2u	1.411m	-	391.3m

Long Pulse Radar Test Signal						
Test Signal Name: LP_Signal_03						
Number of Bursts in Trial: 10						
Burst	Pulses per Burst	Chrip (Hz)	Pulse Width (s)	Pulse 1 to 2 Spacing (s)	Pulse 2 to 3 Spacing (s)	Start Location (s)
1	2	8M	84.5u	1.580m	-	330.9m
2	2	15M	58.8u	1.662m	-	984.0m
3	2	7M	85.5u	1.704m	-	786.0m
4	2	11M	95.9u	1.349m	-	65.99m
5	2	19M	85.6u	1.021m	-	1.100
6	1	20M	74.6u	-	-	1.147
7	1	11M	70.5u	-	-	20.10m
8	1	18M	66.9u	-	-	743.3m
9	3	18M	56.1u	1.441m	1.561m	1.071
10	3	14M	69.5u	1.857m	1.765m	542.6m

Long Pulse Radar Test Signal						
Test Signal Name: LP_Signal_04						
Number of Bursts in Trial: 9						
Burst	Pulses per Burst	Chrip (Hz)	Pulse Width (s)	Pulse 1 to 2 Spacing (s)	Pulse 2 to 3 Spacing (s)	Start Location (s)
1	1	12M	56.2u	-	-	597.6m
2	1	15M	50.2u	-	-	58.69m
3	3	18M	83.6u	1.492m	968.4u	378.8m
4	1	13M	67.3u	-	-	316.8m
5	3	10M	63.5u	956.5u	1.896m	151.0m
6	3	16M	51.0u	1.150m	1.515m	177.6m
7	2	11M	73.4u	1.224m	-	363.2m
8	2	13M	84.6u	1.441m	-	559.2m
9	1	12M	98.2u	-	-	975.3m

Long Pulse Radar Test Signal						
Test Signal Name: LP_Signal_05						
Number of Bursts in Trial: 10						
Burst	Pulses per Burst	Chrip (Hz)	Pulse Width (s)	Pulse 1 to 2 Spacing (s)	Pulse 2 to 3 Spacing (s)	Start Location (s)
1	1	12M	91.6u	-	-	83.79m
2	2	13M	98.2u	1.696m	-	728.7m
3	2	15M	94.8u	1.142m	-	721.9m
4	3	16M	97.5u	1.417m	917.5u	1.089
5	2	18M	72.6u	1.577m	-	371.1m
6	2	14M	69.3u	1.314m	-	1.131
7	2	17M	65.5u	1.524m	-	862.1m
8	1	11M	98.5u	-	-	960.9m
9	2	17M	77.2u	1.726m	-	1.178
10	3	16M	83.8u	1.007m	1.499m	969.2m

Long Pulse Radar Test Signal						
Test Signal Name: LP_Signal_06						
Number of Bursts in Trial: 18						
Burst	Pulses per Burst	Chrip (Hz)	Pulse Width (s)	Pulse 1 to 2 Spacing (s)	Pulse 2 to 3 Spacing (s)	Start Location (s)
1	2	7M	63.1u	1.205m	-	543.3m
2	3	9M	89.1u	917.9u	1.824m	233.1m
3	2	14M	79.7u	1.399m	-	518.9m
4	2	7M	78.7u	1.743m	-	263.2m
5	3	19M	81.0u	1.692m	1.356m	631.0m
6	1	10M	73.7u	-	-	164.8m
7	1	13M	66.0u	-	-	203.2m
8	1	5M	66.3u	-	-	585.1m
9	3	12M	65.2u	1.604m	1.707m	37.25m
10	3	19M	85.0u	1.507m	1.715m	268.8m
11	2	19M	78.1u	1.635m	-	662.6m
12	3	6M	54.6u	1.244m	971.4u	570.4m
13	3	16M	89.5u	1.901m	1.486m	363.1m
14	3	10M	54.8u	1.659m	1.558m	340.2m
15	2	12M	69.5u	973.5u	-	361.4m
16	2	12M	96.6u	1.005m	-	613.1m
17	3	9M	64.5u	1.828m	1.587m	499.4m
18	1	10M	86.0u	-	-	392.9m

Long Pulse Radar Test Signal						
Test Signal Name: LP_Signal_07						
Number of Bursts in Trial: 15						
Burst	Pulses per Burst	Chrip (Hz)	Pulse Width (s)	Pulse 1 to 2 Spacing (s)	Pulse 2 to 3 Spacing (s)	Start Location (s)
1	1	19M	68.5u	-	-	234.5m
2	2	14M	83.5u	1.251m	-	33.14m
3	2	14M	54.8u	1.868m	-	759.3m
4	1	15M	53.0u	-	-	482.6m
5	2	12M	88.5u	1.793m	-	85.48m
6	3	12M	81.8u	1.099m	1.165m	107.1m
7	2	11M	85.8u	1.525m	-	420.7m
8	2	6M	80.3u	1.824m	-	569.6m
9	3	20M	68.0u	1.664m	979.0u	606.3m
10	1	12M	84.7u	-	-	600.4m
11	3	5M	78.9u	1.666m	1.092m	700.4m
12	1	18M	50.8u	-	-	277.9m
13	2	15M	99.0u	1.672m	-	402.5m
14	3	11M	75.4u	1.338m	1.162m	371.6m
15	2	9M	52.3u	1.939m	-	217.1m

Long Pulse Radar Test Signal						
Test Signal Name: LP_Signal_08						
Number of Bursts in Trial: 10						
Burst	Pulses per Burst	Chrip (Hz)	Pulse Width (s)	Pulse 1 to 2 Spacing (s)	Pulse 2 to 3 Spacing (s)	Start Location (s)
1	3	18M	51.7u	1.675m	1.840m	844.6m
2	2	16M	52.5u	1.309m	-	371.1m
3	3	17M	53.9u	1.386m	1.436m	351.4m
4	1	8M	64.4u	-	-	205.2m
5	3	15M	89.5u	1.332m	1.846m	532.3m
6	2	12M	87.6u	1.343m	-	598.3m
7	1	16M	72.6u	-	-	856.0m
8	2	14M	99.2u	1.799m	-	1.053
9	1	13M	95.1u	-	-	1.086
10	1	13M	88.4u	-	-	621.7m

Long Pulse Radar Test Signal						
Test Signal Name: LP_Signal_09						
Number of Bursts in Trial: 9						
Burst	Pulses per Burst	Chrip (Hz)	Pulse Width (s)	Pulse 1 to 2 Spacing (s)	Pulse 2 to 3 Spacing (s)	Start Location (s)
1	3	8M	70.3u	1.737m	1.252m	335.6m
2	1	11M	84.7u	-	-	440.9m
3	2	12M	84.2u	1.530m	-	1.207
4	1	8M	93.4u	-	-	363.1m
5	2	9M	97.9u	1.187m	-	529.2m
6	2	14M	53.2u	1.425m	-	1.218
7	2	7M	88.5u	1.373m	-	328.2m
8	2	19M	83.6u	1.112m	-	810.2m
9	1	13M	67.7u	-	-	1.173

Long Pulse Radar Test Signal						
Test Signal Name: LP_Signal_10						
Number of Bursts in Trial: 19						
Burst	Pulses per Burst	Chrip (Hz)	Pulse Width (s)	Pulse 1 to 2 Spacing (s)	Pulse 2 to 3 Spacing (s)	Start Location (s)
1	2	8M	63.8u	1.661m	-	86.75m
2	1	9M	69.9u	-	-	34.87m
3	2	20M	73.5u	1.108m	-	289.6m
4	3	15M	50.1u	1.415m	1.854m	304.0m
5	2	6M	76.5u	1.236m	-	570.2m
6	3	10M	55.2u	1.346m	1.212m	40.77m
7	1	17M	74.8u	-	-	50.11m
8	2	18M	82.2u	1.200m	-	430.8m
9	2	14M	66.8u	1.121m	-	76.06m
10	1	16M	80.0u	-	-	105.0m
11	3	9M	60.6u	1.769m	1.214m	417.9m
12	2	6M	66.1u	1.004m	-	28.34m
13	1	16M	75.1u	-	-	533.8m
14	2	8M	92.1u	1.154m	-	138.0m
15	2	7M	64.1u	1.869m	-	192.0m
16	1	15M	71.7u	-	-	607.4m
17	2	6M	57.0u	1.751m	-	74.28m
18	2	15M	56.4u	1.384m	-	458.1m
19	3	13M	94.4u	1.583m	1.741m	377.3m



Long Pulse Radar Test Signal						
Test Signal Name: LP_Signal_11						
Number of Bursts in Trial: 10						
Burst	Pulses per Burst	Chrip (Hz)	Pulse Width (s)	Pulse 1 to 2 Spacing (s)	Pulse 2 to 3 Spacing (s)	Start Location (s)
1	2	11M	92.8u	1.034m	-	1.018
2	1	7M	98.5u	-	-	678.2m
3	1	6M	59.7u	-	-	527.1m
4	1	16M	59.9u	-	-	43.10m
5	1	5M	62.5u	-	-	941.7m
6	2	12M	68.7u	1.737m	-	612.4m
7	3	20M	89.8u	1.363m	1.082m	174.3m
8	2	8M	83.2u	1.828m	-	455.5m
9	3	19M	71.8u	1.034m	1.344m	52.44m
10	1	7M	84.5u	-	-	581.3m

Long Pulse Radar Test Signal						
Test Signal Name: LP_Signal_12						
Number of Bursts in Trial: 10						
Burst	Pulses per Burst	Chrip (Hz)	Pulse Width (s)	Pulse 1 to 2 Spacing (s)	Pulse 2 to 3 Spacing (s)	Start Location (s)
1	2	14M	61.8u	1.843m	-	734.7m
2	3	13M	78.1u	1.671m	1.013m	712.5m
3	1	19M	88.0u	-	-	590.6m
4	3	6M	82.0u	1.833m	1.447m	918.1m
5	2	20M	55.2u	1.797m	-	389.3m
6	2	11M	60.4u	1.321m	-	799.7m
7	3	14M	94.9u	1.114m	1.231m	514.6m
8	2	6M	79.8u	1.703m	-	424.0m
9	3	15M	75.7u	1.657m	1.862m	1.180
10	2	9M	51.1u	1.004m	-	18.70m

Long Pulse Radar Test Signal						
Test Signal Name: LP_Signal_13						
Number of Bursts in Trial: 13						
Burst	Pulses per Burst	Chrip (Hz)	Pulse Width (s)	Pulse 1 to 2 Spacing (s)	Pulse 2 to 3 Spacing (s)	Start Location (s)
1	1	6M	73.4u	-	-	504.3m
2	2	19M	98.1u	994.9u	-	545.5m
3	1	9M	93.5u	-	-	322.4m
4	1	14M	77.3u	-	-	180.2m
5	1	6M	76.0u	-	-	350.6m
6	2	15M	56.2u	1.416m	-	467.3m
7	1	8M	88.1u	-	-	522.0m
8	3	10M	73.4u	1.053m	1.825m	172.9m
9	2	15M	75.0u	1.232m	-	802.1m
10	1	18M	97.8u	-	-	25.50m
11	2	8M	93.1u	1.807m	-	143.8m
12	2	10M	68.7u	1.591m	-	761.4m
13	2	15M	82.8u	1.258m	-	687.8m

Long Pulse Radar Test Signal						
Test Signal Name: LP_Signal_14						
Number of Bursts in Trial: 14						
Burst	Pulses per Burst	Chrip (Hz)	Pulse Width (s)	Pulse 1 to 2 Spacing (s)	Pulse 2 to 3 Spacing (s)	Start Location (s)
1	1	7M	56.9u	-	-	481.2m
2	3	6M	82.8u	1.716m	1.682m	269.8m
3	2	11M	71.1u	1.766m	-	702.4m
4	2	19M	86.4u	1.320m	-	765.0m
5	3	18M	79.2u	1.262m	1.445m	547.2m
6	3	17M	92.2u	1.672m	1.581m	241.3m
7	3	14M	79.3u	1.430m	1.585m	138.0m
8	3	17M	53.9u	1.293m	947.1u	843.3m
9	1	8M	54.2u	-	-	217.9m
10	2	9M	71.5u	1.347m	-	68.80m
11	2	11M	65.4u	1.467m	-	803.0m
12	1	8M	62.5u	-	-	250.4m
13	2	12M	60.0u	1.119m	-	699.2m
14	2	20M	59.1u	1.772m	-	263.5m

Long Pulse Radar Test Signal						
Test Signal Name: LP_Signal_15						
Number of Bursts in Trial: 17						
Burst	Pulses per Burst	Chrip (Hz)	Pulse Width (s)	Pulse 1 to 2 Spacing (s)	Pulse 2 to 3 Spacing (s)	Start Location (s)
1	2	10M	61.4u	1.925m	-	406.7m
2	2	17M	65.2u	1.930m	-	506.3m
3	2	5M	60.1u	1.225m	-	352.2m
4	2	14M	69.3u	1.628m	-	516.1m
5	1	12M	76.7u	-	-	69.02m
6	2	8M	57.8u	1.232m	-	293.7m
7	1	10M	76.9u	-	-	51.10m
8	2	13M	73.9u	1.390m	-	649.1m
9	2	9M	96.1u	1.023m	-	116.4m
10	3	16M	84.4u	935.6u	1.252m	618.9m
11	1	8M	57.6u	-	-	114.9m
12	2	7M	76.8u	1.252m	-	693.3m
13	2	12M	67.0u	1.358m	-	205.6m
14	2	12M	56.9u	1.727m	-	338.7m
15	2	13M	68.6u	1.723m	-	307.5m
16	2	19M	65.2u	1.584m	-	276.2m
17	1	17M	60.4u	-	-	100.8m

Long Pulse Radar Test Signal						
Test Signal Name: LP_Signal_16						
Number of Bursts in Trial: 10						
Burst	Pulses per Burst	Chrip (Hz)	Pulse Width (s)	Pulse 1 to 2 Spacing (s)	Pulse 2 to 3 Spacing (s)	Start Location (s)
1	3	17M	92.7u	1.327m	1.415m	126.9m
2	3	20M	66.5u	1.708m	1.334m	696.5m
3	2	15M	92.8u	1.617m	-	1.188
4	1	11M	53.6u	-	-	586.6m
5	3	15M	84.0u	1.000m	1.158m	127.9m
6	2	16M	52.4u	1.495m	-	534.9m
7	1	7M	71.1u	-	-	871.5m
8	3	8M	63.9u	1.711m	1.585m	333.7m
9	2	7M	70.7u	1.502m	-	77.02m
10	2	10M	77.2u	1.164m	-	226.4m

Long Pulse Radar Test Signal						
Test Signal Name: LP_Signal_17						
Number of Bursts in Trial: 18						
Burst	Pulses per Burst	Chrip (Hz)	Pulse Width (s)	Pulse 1 to 2 Spacing (s)	Pulse 2 to 3 Spacing (s)	Start Location (s)
1	2	13M	53.0u	1.063m	-	376.6m
2	2	16M	76.6u	1.134m	-	365.2m
3	1	19M	74.2u	-	-	632.6m
4	2	16M	79.6u	1.428m	-	14.43m
5	1	13M	68.1u	-	-	502.7m
6	1	6M	88.3u	-	-	607.1m
7	2	8M	95.8u	1.628m	-	514.6m
8	3	7M	96.4u	1.346m	1.609m	33.40m
9	2	10M	58.3u	990.7u	-	49.06m
10	1	14M	59.0u	-	-	90.22m
11	2	18M	71.3u	1.224m	-	83.70m
12	3	17M	82.1u	1.132m	1.707m	366.2m
13	3	19M	86.6u	1.125m	1.614m	177.7m
14	1	8M	58.1u	-	-	169.5m
15	1	17M	93.6u	-	-	80.21m
16	1	9M	56.3u	-	-	376.6m
17	2	14M	96.1u	1.463m	-	416.0m
18	1	5M	89.1u	-	-	640.9m

Long Pulse Radar Test Signal						
Test Signal Name: LP_Signal_18						
Number of Bursts in Trial: 14						
Burst	Pulses per Burst	Chrip (Hz)	Pulse Width (s)	Pulse 1 to 2 Spacing (s)	Pulse 2 to 3 Spacing (s)	Start Location (s)
1	2	8M	65.5u	1.832m	-	789.4m
2	3	19M	91.5u	1.605m	1.548m	238.0m
3	3	18M	83.3u	1.642m	1.615m	48.26m
4	3	17M	94.6u	932.4u	1.648m	727.5m
5	3	6M	61.7u	1.259m	1.506m	471.0m
6	2	19M	68.2u	1.239m	-	132.6m
7	2	10M	64.9u	1.355m	-	138.8m
8	2	18M	81.0u	1.697m	-	445.2m
9	2	6M	88.3u	1.309m	-	285.2m
10	3	12M	90.9u	1.274m	1.119m	429.4m
11	3	11M	53.0u	948.0u	1.200m	482.1m
12	2	17M	73.5u	1.914m	-	735.5m
13	2	19M	71.7u	1.165m	-	525.5m
14	2	17M	55.9u	1.939m	-	491.3m

Long Pulse Radar Test Signal						
Test Signal Name: LP_Signal_19						
Number of Bursts in Trial: 13						
Burst	Pulses per Burst	Chrip (Hz)	Pulse Width (s)	Pulse 1 to 2 Spacing (s)	Pulse 2 to 3 Spacing (s)	Start Location (s)
1	3	13M	51.9u	1.544m	1.864m	375.1m
2	2	11M	81.5u	1.143m	-	192.7m
3	1	19M	91.3u	-	-	633.2m
4	2	13M	97.6u	1.724m	-	756.5m
5	3	5M	97.2u	1.842m	1.182m	890.8m
6	1	14M	62.6u	-	-	420.7m
7	2	15M	59.3u	1.146m	-	707.2m
8	1	13M	62.5u	-	-	668.1m
9	1	16M	76.1u	-	-	360.0m
10	2	13M	82.1u	1.526m	-	570.7m
11	3	8M	87.5u	1.894m	1.907m	759.4m
12	3	13M	60.4u	1.459m	1.237m	103.4m
13	2	15M	63.9u	1.313m	-	583.3m



Long Pulse Radar Test Signal						
Test Signal Name: LP_Signal_20						
Number of Bursts in Trial: 14						
Burst	Pulses per Burst	Chrip (Hz)	Pulse Width (s)	Pulse 1 to 2 Spacing (s)	Pulse 2 to 3 Spacing (s)	Start Location (s)
1	2	8M	64.0u	1.885m	-	398.6m
2	2	6M	80.1u	1.386m	-	516.7m
3	2	15M	89.2u	1.549m	-	66.33m
4	1	15M	71.7u	-	-	355.1m
5	2	10M	94.9u	1.166m	-	571.5m
6	2	7M	76.0u	1.788m	-	195.6m
7	2	11M	53.3u	1.302m	-	602.4m
8	2	18M	56.3u	1.384m	-	424.1m
9	2	20M	98.6u	1.624m	-	158.0m
10	2	9M	80.9u	1.343m	-	423.4m
11	2	13M	82.2u	1.817m	-	608.6m
12	1	13M	93.2u	-	-	310.3m
13	1	5M	55.8u	-	-	821.3m
14	1	20M	63.0u	-	-	421.6m

Long Pulse Radar Test Signal						
Test Signal Name: LP_Signal_21						
Number of Bursts in Trial: 10						
Burst	Pulses per Burst	Chrip (Hz)	Pulse Width (s)	Pulse 1 to 2 Spacing (s)	Pulse 2 to 3 Spacing (s)	Start Location (s)
1	2	14M	81.2u	1.666m	-	562.9m
2	1	7M	83.7u	-	-	932.9m
3	3	7M	80.2u	1.590m	1.831m	176.9m
4	2	18M	92.0u	1.519m	-	323.6m
5	3	18M	92.6u	1.055m	970.4u	817.2m
6	2	6M	74.2u	926.8u	-	691.5m
7	2	10M	71.2u	1.683m	-	1.054
8	2	5M	61.9u	1.087m	-	838.7m
9	2	8M	68.9u	1.360m	-	414.8m
10	2	10M	71.0u	1.394m	-	775.8m

Long Pulse Radar Test Signal						
Test Signal Name: LP_Signal_22						
Number of Bursts in Trial: 15						
Burst	Pulses per Burst	Chrip (Hz)	Pulse Width (s)	Pulse 1 to 2 Spacing (s)	Pulse 2 to 3 Spacing (s)	Start Location (s)
1	1	6M	89.2u	-	-	343.1m
2	3	9M	71.1u	1.713m	1.792m	238.0m
3	2	18M	78.1u	1.252m	-	342.7m
4	3	13M	66.6u	1.709m	1.755m	446.9m
5	2	14M	50.2u	1.120m	-	165.3m
6	2	20M	82.7u	1.589m	-	513.9m
7	1	18M	69.3u	-	-	343.3m
8	2	16M	75.7u	1.814m	-	701.8m
9	2	14M	50.7u	1.070m	-	754.0m
10	3	5M	87.7u	1.512m	1.442m	100.1m
11	3	20M	51.9u	1.696m	1.681m	96.05m
12	3	18M	73.9u	1.616m	1.166m	368.0m
13	2	7M	97.2u	914.8u	-	298.8m
14	3	5M	75.6u	1.798m	1.175m	511.0m
15	1	7M	60.5u	-	-	656.6m

Long Pulse Radar Test Signal						
Test Signal Name: LP_Signal_23						
Number of Bursts in Trial: 10						
Burst	Pulses per Burst	Chrip (Hz)	Pulse Width (s)	Pulse 1 to 2 Spacing (s)	Pulse 2 to 3 Spacing (s)	Start Location (s)
1	2	8M	98.4u	1.057m	-	804.0m
2	3	11M	60.6u	1.163m	1.594m	514.2m
3	2	17M	71.7u	1.263m	-	460.4m
4	2	18M	58.6u	1.118m	-	333.8m
5	1	12M	71.5u	-	-	196.3m
6	1	20M	86.5u	-	-	480.7m
7	1	6M	82.9u	-	-	701.2m
8	1	16M	73.5u	-	-	1.165
9	3	16M	77.6u	948.4u	1.047m	589.3m
10	3	16M	88.9u	1.304m	1.586m	998.7m

Long Pulse Radar Test Signal						
Test Signal Name: LP_Signal_24						
Number of Bursts in Trial: 18						
Burst	Pulses per Burst	Chrip (Hz)	Pulse Width (s)	Pulse 1 to 2 Spacing (s)	Pulse 2 to 3 Spacing (s)	Start Location (s)
1	1	5M	78.2u	-	-	538.8m
2	1	6M	75.6u	-	-	187.9m
3	1	13M	88.6u	-	-	584.6m
4	1	13M	72.7u	-	-	356.1m
5	2	7M	69.5u	961.5u	-	304.4m
6	2	5M	62.0u	1.691m	-	267.7m
7	1	15M	95.5u	-	-	353.6m
8	3	11M	92.2u	1.844m	1.630m	41.27m
9	2	9M	97.7u	1.446m	-	552.6m
10	3	10M	57.6u	1.621m	1.203m	120.4m
11	1	6M	89.9u	-	-	35.45m
12	1	7M	88.2u	-	-	3.635m
13	2	20M	64.6u	1.541m	-	575.6m
14	2	9M	53.7u	1.100m	-	335.2m
15	2	18M	92.6u	1.104m	-	617.2m
16	1	9M	65.3u	-	-	260.3m
17	1	18M	75.2u	-	-	187.2m
18	1	14M	69.9u	-	-	335.0m

Long Pulse Radar Test Signal						
Test Signal Name: LP_Signal_25						
Number of Bursts in Trial: 17						
Burst	Pulses per Burst	Chrip (Hz)	Pulse Width (s)	Pulse 1 to 2 Spacing (s)	Pulse 2 to 3 Spacing (s)	Start Location (s)
1	2	19M	74.3u	1.849m	-	83.06m
2	2	15M	67.0u	1.333m	-	107.9m
3	1	14M	98.1u	-	-	121.0m
4	2	17M	81.7u	1.444m	-	244.0m
5	2	19M	66.1u	1.689m	-	477.3m
6	2	6M	96.9u	909.1u	-	492.9m
7	2	7M	67.7u	1.375m	-	322.3m
8	2	18M	85.7u	1.112m	-	247.8m
9	1	11M	63.1u	-	-	172.3m
10	1	12M	80.5u	-	-	204.5m
11	3	11M	99.1u	1.124m	1.855m	98.56m
12	2	9M	87.1u	1.271m	-	649.2m
13	1	17M	58.8u	-	-	326.8m
14	2	7M	88.9u	1.003m	-	360.9m
15	1	17M	85.1u	-	-	201.1m
16	2	20M	82.8u	1.511m	-	617.1m
17	2	19M	61.9u	1.657m	-	522.4m

Long Pulse Radar Test Signal						
Test Signal Name: LP_Signal_26						
Number of Bursts in Trial: 12						
Burst	Pulses per Burst	Chrip (Hz)	Pulse Width (s)	Pulse 1 to 2 Spacing (s)	Pulse 2 to 3 Spacing (s)	Start Location (s)
1	2	7M	65.5u	1.429m	-	528.4m
2	2	6M	67.7u	1.925m	-	252.5m
3	1	17M	83.7u	-	-	285.4m
4	1	16M	59.2u	-	-	997.6m
5	2	9M	76.5u	1.161m	-	272.6m
6	2	6M	79.5u	1.873m	-	406.8m
7	1	7M	86.5u	-	-	104.5m
8	1	19M	85.6u	-	-	223.4m
9	1	11M	92.2u	-	-	640.5m
10	2	19M	54.6u	1.308m	-	353.7m
11	2	11M	70.1u	1.599m	-	746.9m
12	3	20M	71.6u	997.4u	1.068m	208.9m

Long Pulse Radar Test Signal						
Test Signal Name: LP_Signal_27						
Number of Bursts in Trial: 17						
Burst	Pulses per Burst	Chrip (Hz)	Pulse Width (s)	Pulse 1 to 2 Spacing (s)	Pulse 2 to 3 Spacing (s)	Start Location (s)
1	2	7M	73.2u	1.141m	-	378.0m
2	1	18M	91.5u	-	-	129.8m
3	2	14M	70.5u	1.723m	-	484.5m
4	2	5M	77.2u	1.621m	-	257.3m
5	3	19M	65.6u	1.689m	1.600m	684.0m
6	3	14M	81.8u	1.783m	1.009m	463.4m
7	3	18M	52.1u	1.574m	1.617m	124.9m
8	2	9M	64.7u	1.617m	-	629.4m
9	2	12M	96.0u	1.437m	-	535.1m
10	1	18M	83.1u	-	-	354.6m
11	1	8M	74.3u	-	-	28.15m
12	1	14M	94.4u	-	-	525.6m
13	3	12M	69.5u	1.452m	1.730m	346.9m
14	2	20M	86.8u	1.054m	-	673.0m
15	2	15M	57.0u	1.236m	-	697.4m
16	2	8M	55.7u	1.378m	-	197.8m
17	2	12M	67.9u	1.630m	-	263.1m



Long Pulse Radar Test Signal						
Test Signal Name: LP_Signal_28						
Number of Bursts in Trial: 16						
Burst	Pulses per Burst	Chrip (Hz)	Pulse Width (s)	Pulse 1 to 2 Spacing (s)	Pulse 2 to 3 Spacing (s)	Start Location (s)
1	2	11M	91.2u	1.196m	-	595.0m
2	3	17M	57.3u	1.641m	1.021m	5.132m
3	1	17M	72.7u	-	-	665.6m
4	2	13M	68.8u	1.231m	-	119.0m
5	3	8M	67.1u	1.603m	1.916m	43.18m
6	1	19M	75.7u	-	-	172.4m
7	1	18M	50.4u	-	-	224.6m
8	3	16M	73.8u	1.285m	1.091m	678.5m
9	2	7M	86.5u	1.003m	-	670.5m
10	1	12M	55.0u	-	-	352.1m
11	2	15M	54.9u	1.687m	-	306.9m
12	1	9M	86.4u	-	-	731.7m
13	1	7M	71.4u	-	-	699.2m
14	1	6M	50.6u	-	-	40.77m
15	3	17M	94.5u	1.110m	1.796m	272.4m
16	1	6M	66.6u	-	-	423.4m

Long Pulse Radar Test Signal

Test Signal Name: LP\_Signal\_29

Number of Bursts in Trial: 13

Burst	Pulses per Burst	Chrip (Hz)	Pulse Width (s)	Pulse 1 to 2 Spacing (s)	Pulse 2 to 3 Spacing (s)	Start Location (s)
1	3	8M	96.8u	1.257m	1.528m	862.3m
2	3	15M	53.3u	1.351m	1.462m	610.2m
3	3	8M	63.9u	1.872m	1.549m	199.9m
4	3	15M	64.2u	1.028m	961.8u	196.7m
5	2	18M	59.0u	1.052m	-	740.8m
6	1	16M	78.3u	-	-	624.1m
7	2	8M	62.5u	954.5u	-	531.3m
8	3	18M	72.5u	1.832m	1.530m	714.7m
9	3	12M	60.7u	965.3u	1.236m	673.5m
10	2	13M	79.6u	1.583m	-	334.2m
11	2	9M	68.8u	1.557m	-	316.9m
12	2	8M	69.4u	947.6u	-	492.5m
13	1	14M	64.5u	-	-	399.5m

Long Pulse Radar Test Signal						
Test Signal Name: LP_Signal_30						
Number of Bursts in Trial: 11						
Burst	Pulses per Burst	Chrip (Hz)	Pulse Width (s)	Pulse 1 to 2 Spacing (s)	Pulse 2 to 3 Spacing (s)	Start Location (s)
1	1	16M	50.2u	-	-	278.4m
2	2	12M	80.7u	1.382m	-	730.0m
3	1	12M	81.1u	-	-	265.9m
4	2	7M	84.2u	1.356m	-	400.6m
5	2	9M	65.9u	1.133m	-	406.3m
6	1	11M	89.9u	-	-	847.0m
7	2	13M	98.9u	1.563m	-	242.1m
8	2	8M	82.2u	1.518m	-	565.1m
9	1	6M	68.9u	-	-	482.4m
10	2	11M	87.1u	1.471m	-	945.3m
11	2	19M	92.9u	1.341m	-	1.012

Type 6 Radar Statistical Performances				
Trial #	Pulses per Burst	Pulse Width (s)	PRI (s)	Detection
1	9	1.0u	333.0u	Yes
2	9	1.0u	333.0u	Yes
3	9	1.0u	333.0u	Yes
4	9	1.0u	333.0u	Yes
5	9	1.0u	333.0u	Yes
6	9	1.0u	333.0u	Yes
7	9	1.0u	333.0u	Yes
8	9	1.0u	333.0u	Yes
9	9	1.0u	333.0u	Yes
10	9	1.0u	333.0u	Yes
11	9	1.0u	333.0u	Yes
12	9	1.0u	333.0u	Yes
13	9	1.0u	333.0u	Yes
14	9	1.0u	333.0u	No
15	9	1.0u	333.0u	Yes
16	9	1.0u	333.0u	Yes
17	9	1.0u	333.0u	Yes
18	9	1.0u	333.0u	Yes
19	9	1.0u	333.0u	Yes
20	9	1.0u	333.0u	Yes
21	9	1.0u	333.0u	Yes
22	9	1.0u	333.0u	Yes
23	9	1.0u	333.0u	Yes
24	9	1.0u	333.0u	Yes
25	9	1.0u	333.0u	Yes
26	9	1.0u	333.0u	Yes
27	9	1.0u	333.0u	Yes
28	9	1.0u	333.0u	Yes
29	9	1.0u	333.0u	Yes
30	9	1.0u	333.0u	Yes
				Detection Rate: 96.7 %

Type 6 Radar Statistical Performances		
Trial #	Hopping Frequency Sequence Name	Detection
1	HOP_FREQ_SEQ_01	Yes
2	HOP_FREQ_SEQ_02	Yes
3	HOP_FREQ_SEQ_03	Yes
4	HOP_FREQ_SEQ_04	Yes
5	HOP_FREQ_SEQ_05	Yes
6	HOP_FREQ_SEQ_06	Yes
7	HOP_FREQ_SEQ_07	Yes
8	HOP_FREQ_SEQ_08	Yes
9	HOP_FREQ_SEQ_09	Yes
10	HOP_FREQ_SEQ_10	Yes
11	HOP_FREQ_SEQ_11	Yes
12	HOP_FREQ_SEQ_12	Yes
13	HOP_FREQ_SEQ_13	Yes
14	HOP_FREQ_SEQ_14	No
15	HOP_FREQ_SEQ_15	Yes
16	HOP_FREQ_SEQ_16	Yes
17	HOP_FREQ_SEQ_17	Yes
18	HOP_FREQ_SEQ_18	Yes
19	HOP_FREQ_SEQ_19	Yes
20	HOP_FREQ_SEQ_20	Yes
21	HOP_FREQ_SEQ_21	Yes
22	HOP_FREQ_SEQ_22	Yes
23	HOP_FREQ_SEQ_23	Yes
24	HOP_FREQ_SEQ_24	Yes
25	HOP_FREQ_SEQ_25	Yes
26	HOP_FREQ_SEQ_26	Yes
27	HOP_FREQ_SEQ_27	Yes
28	HOP_FREQ_SEQ_28	Yes
29	HOP_FREQ_SEQ_29	Yes
30	HOP_FREQ_SEQ_30	Yes
		Detection Rate: 96.7 %

Hopping Frequency Sequence Name: HOP_FREQ_SEQ_01							
SEQ#	Frequency (Hz)	SEQ#	Frequency (Hz)	SEQ#	Frequency (Hz)	SEQ#	Frequency (Hz)
1	5.571G	2	5.440G	3	5.375G	4	5.328G
5	5.357G	6	5.298G	7	5.281G	8	5.376G
9	5.689G	10	5.587G	11	5.625G	12	5.684G
13	5.636G	14	5.309G	15	5.596G	16	5.660G
17	5.409G	18	5.452G	19	5.339G	20	5.661G
21	5.351G	22	5.260G	23	5.616G	24	5.712G
25	5.459G	26	5.423G	27	5.546G	28	5.678G
29	5.522G	30	5.435G	31	5.458G	32	5.566G
33	5.532G	34	5.548G	35	5.693G	36	5.267G
37	5.584G	38	5.377G	39	5.429G	40	5.415G
41	5.519G	42	5.460G	43	5.296G	44	5.554G
45	5.493G	46	5.715G	47	5.384G	48	5.492G
49	5.611G	50	5.531G	51	5.671G	52	5.707G
53	5.457G	54	5.366G	55	5.403G	56	5.414G
57	5.686G	58	5.569G	59	5.555G	60	5.346G
61	5.302G	62	5.622G	63	5.672G	64	5.551G
65	5.682G	66	5.326G	67	5.656G	68	5.432G
69	5.605G	70	5.419G	71	5.310G	72	5.647G
73	5.710G	74	5.297G	75	5.711G	76	5.353G
77	5.442G	78	5.553G	79	5.677G	80	5.523G
81	5.401G	82	5.500G	83	5.674G	84	5.597G
85	5.633G	86	5.431G	87	5.441G	88	5.499G
89	5.685G	90	5.393G	91	5.679G	92	5.704G
93	5.486G	94	5.389G	95	5.662G	96	5.444G
97	5.694G	98	5.552G	99	5.545G	100	5.445G

Hopping Frequency Sequence Name: HOP_FREQ_SEQ_02							
SEQ#	Frequency (Hz)	SEQ#	Frequency (Hz)	SEQ#	Frequency (Hz)	SEQ#	Frequency (Hz)
1	5.266G	2	5.335G	3	5.722G	4	5.621G
5	5.646G	6	5.629G	7	5.552G	8	5.635G
9	5.675G	10	5.571G	11	5.693G	12	5.344G
13	5.419G	14	5.408G	15	5.359G	16	5.630G
17	5.453G	18	5.477G	19	5.425G	20	5.528G
21	5.294G	22	5.555G	23	5.463G	24	5.319G
25	5.513G	26	5.677G	27	5.276G	28	5.422G
29	5.557G	30	5.553G	31	5.710G	32	5.551G
33	5.482G	34	5.492G	35	5.525G	36	5.720G
37	5.432G	38	5.663G	39	5.360G	40	5.680G
41	5.327G	42	5.585G	43	5.407G	44	5.541G
45	5.450G	46	5.503G	47	5.617G	48	5.502G
49	5.678G	50	5.538G	51	5.536G	52	5.473G
53	5.464G	54	5.277G	55	5.460G	56	5.575G
57	5.648G	58	5.479G	59	5.272G	60	5.337G
61	5.321G	62	5.383G	63	5.415G	64	5.293G
65	5.560G	66	5.505G	67	5.403G	68	5.458G
69	5.597G	70	5.656G	71	5.471G	72	5.483G
73	5.310G	74	5.507G	75	5.542G	76	5.556G
77	5.548G	78	5.665G	79	5.699G	80	5.279G
81	5.545G	82	5.703G	83	5.481G	84	5.709G
85	5.494G	86	5.681G	87	5.658G	88	5.652G
89	5.307G	90	5.343G	91	5.696G	92	5.444G
93	5.330G	94	5.382G	95	5.365G	96	5.332G
97	5.539G	98	5.508G	99	5.270G	100	5.642G

Hopping Frequency Sequence Name: HOP_FREQ_SEQ_03							
SEQ#	Frequency (Hz)	SEQ#	Frequency (Hz)	SEQ#	Frequency (Hz)	SEQ#	Frequency (Hz)
1	5.691G	2	5.517G	3	5.653G	4	5.437G
5	5.451G	6	5.509G	7	5.350G	8	5.496G
9	5.707G	10	5.315G	11	5.471G	12	5.359G
13	5.712G	14	5.694G	15	5.601G	16	5.638G
17	5.530G	18	5.685G	19	5.632G	20	5.722G
21	5.438G	22	5.322G	23	5.469G	24	5.671G
25	5.609G	26	5.532G	27	5.483G	28	5.679G
29	5.686G	30	5.402G	31	5.693G	32	5.486G
33	5.275G	34	5.323G	35	5.667G	36	5.670G
37	5.408G	38	5.598G	39	5.507G	40	5.292G
41	5.696G	42	5.628G	43	5.715G	44	5.518G
45	5.522G	46	5.508G	47	5.580G	48	5.360G
49	5.723G	50	5.556G	51	5.536G	52	5.655G
53	5.485G	54	5.462G	55	5.255G	56	5.371G
57	5.662G	58	5.273G	59	5.258G	60	5.724G
61	5.257G	62	5.321G	63	5.579G	64	5.384G
65	5.306G	66	5.294G	67	5.393G	68	5.357G
69	5.259G	70	5.254G	71	5.695G	72	5.646G
73	5.299G	74	5.700G	75	5.295G	76	5.537G
77	5.423G	78	5.590G	79	5.689G	80	5.659G
81	5.560G	82	5.484G	83	5.431G	84	5.474G
85	5.716G	86	5.581G	87	5.647G	88	5.634G
89	5.320G	90	5.645G	91	5.594G	92	5.633G
93	5.549G	94	5.277G	95	5.428G	96	5.397G
97	5.512G	98	5.710G	99	5.660G	100	5.559G



Hopping Frequency Sequence Name: HOP_FREQ_SEQ_04							
SEQ#	Frequency (Hz)	SEQ#	Frequency (Hz)	SEQ#	Frequency (Hz)	SEQ#	Frequency (Hz)
1	5.379G	2	5.282G	3	5.287G	4	5.494G
5	5.529G	6	5.512G	7	5.650G	8	5.641G
9	5.521G	10	5.543G	11	5.669G	12	5.621G
13	5.453G	14	5.631G	15	5.606G	16	5.419G
17	5.500G	18	5.643G	19	5.691G	20	5.425G
21	5.432G	22	5.355G	23	5.587G	24	5.626G
25	5.492G	26	5.649G	27	5.284G	28	5.486G
29	5.267G	30	5.553G	31	5.315G	32	5.599G
33	5.335G	34	5.381G	35	5.261G	36	5.629G
37	5.370G	38	5.524G	39	5.252G	40	5.611G
41	5.476G	42	5.437G	43	5.346G	44	5.259G
45	5.430G	46	5.360G	47	5.506G	48	5.557G
49	5.367G	50	5.640G	51	5.427G	52	5.674G
53	5.703G	54	5.548G	55	5.693G	56	5.412G
57	5.340G	58	5.615G	59	5.395G	60	5.502G
61	5.270G	62	5.390G	63	5.518G	64	5.470G
65	5.454G	66	5.718G	67	5.618G	68	5.609G
69	5.319G	70	5.291G	71	5.634G	72	5.590G
73	5.269G	74	5.374G	75	5.450G	76	5.721G
77	5.362G	78	5.597G	79	5.608G	80	5.682G
81	5.526G	82	5.332G	83	5.272G	84	5.329G
85	5.583G	86	5.431G	87	5.416G	88	5.318G
89	5.593G	90	5.504G	91	5.714G	92	5.509G
93	5.279G	94	5.636G	95	5.559G	96	5.572G
97	5.467G	98	5.628G	99	5.465G	100	5.720G

Hopping Frequency Sequence Name: HOP_FREQ_SEQ_05							
SEQ#	Frequency (Hz)	SEQ#	Frequency (Hz)	SEQ#	Frequency (Hz)	SEQ#	Frequency (Hz)
1	5.415G	2	5.354G	3	5.580G	4	5.424G
5	5.704G	6	5.649G	7	5.516G	8	5.645G
9	5.308G	10	5.710G	11	5.459G	12	5.565G
13	5.549G	14	5.446G	15	5.543G	16	5.373G
17	5.291G	18	5.382G	19	5.706G	20	5.724G
21	5.618G	22	5.722G	23	5.358G	24	5.594G
25	5.263G	26	5.660G	27	5.491G	28	5.492G
29	5.522G	30	5.640G	31	5.642G	32	5.524G
33	5.701G	34	5.665G	35	5.623G	36	5.466G
37	5.359G	38	5.502G	39	5.442G	40	5.434G
41	5.363G	42	5.507G	43	5.251G	44	5.279G
45	5.626G	46	5.383G	47	5.419G	48	5.371G
49	5.593G	50	5.298G	51	5.512G	52	5.423G
53	5.378G	54	5.683G	55	5.289G	56	5.403G
57	5.674G	58	5.631G	59	5.411G	60	5.532G
61	5.460G	62	5.453G	63	5.632G	64	5.501G
65	5.461G	66	5.406G	67	5.436G	68	5.596G
69	5.719G	70	5.673G	71	5.582G	72	5.468G
73	5.479G	74	5.717G	75	5.666G	76	5.329G
77	5.659G	78	5.691G	79	5.577G	80	5.443G
81	5.473G	82	5.334G	83	5.258G	84	5.533G
85	5.478G	86	5.422G	87	5.290G	88	5.647G
89	5.541G	90	5.572G	91	5.418G	92	5.341G
93	5.561G	94	5.652G	95	5.625G	96	5.515G
97	5.556G	98	5.707G	99	5.441G	100	5.484G

Hopping Frequency Sequence Name: HOP_FREQ_SEQ_06							
SEQ#	Frequency (Hz)	SEQ#	Frequency (Hz)	SEQ#	Frequency (Hz)	SEQ#	Frequency (Hz)
1	5.588G	2	5.669G	3	5.273G	4	5.594G
5	5.311G	6	5.345G	7	5.488G	8	5.355G
9	5.615G	10	5.678G	11	5.438G	12	5.269G
13	5.290G	14	5.616G	15	5.531G	16	5.359G
17	5.693G	18	5.399G	19	5.486G	20	5.553G
21	5.431G	22	5.252G	23	5.592G	24	5.361G
25	5.539G	26	5.284G	27	5.476G	28	5.713G
29	5.554G	30	5.468G	31	5.274G	32	5.295G
33	5.364G	34	5.581G	35	5.402G	36	5.602G
37	5.446G	38	5.558G	39	5.277G	40	5.309G
41	5.335G	42	5.560G	43	5.327G	44	5.509G
45	5.527G	46	5.397G	47	5.651G	48	5.427G
49	5.278G	50	5.534G	51	5.276G	52	5.296G
53	5.424G	54	5.434G	55	5.495G	56	5.370G
57	5.637G	58	5.257G	59	5.494G	60	5.512G
61	5.497G	62	5.502G	63	5.377G	64	5.655G
65	5.537G	66	5.671G	67	5.606G	68	5.608G
69	5.599G	70	5.398G	71	5.408G	72	5.357G
73	5.565G	74	5.662G	75	5.521G	76	5.266G
77	5.329G	78	5.326G	79	5.283G	80	5.299G
81	5.448G	82	5.598G	83	5.469G	84	5.690G
85	5.267G	86	5.635G	87	5.319G	88	5.700G
89	5.375G	90	5.519G	91	5.605G	92	5.478G
93	5.396G	94	5.409G	95	5.569G	96	5.414G
97	5.721G	98	5.280G	99	5.352G	100	5.580G

Hopping Frequency Sequence Name: HOP_FREQ_SEQ_07							
SEQ#	Frequency (Hz)	SEQ#	Frequency (Hz)	SEQ#	Frequency (Hz)	SEQ#	Frequency (Hz)
1	5.349G	2	5.447G	3	5.369G	4	5.495G
5	5.563G	6	5.390G	7	5.557G	8	5.636G
9	5.289G	10	5.571G	11	5.298G	12	5.569G
13	5.644G	14	5.493G	15	5.299G	16	5.664G
17	5.423G	18	5.548G	19	5.272G	20	5.691G
21	5.411G	22	5.294G	23	5.265G	24	5.502G
25	5.523G	26	5.556G	27	5.429G	28	5.524G
29	5.570G	30	5.658G	31	5.509G	32	5.578G
33	5.648G	34	5.555G	35	5.330G	36	5.580G
37	5.615G	38	5.341G	39	5.336G	40	5.482G
41	5.562G	42	5.286G	43	5.414G	44	5.560G
45	5.290G	46	5.476G	47	5.420G	48	5.705G
49	5.484G	50	5.345G	51	5.721G	52	5.606G
53	5.305G	54	5.405G	55	5.681G	56	5.353G
57	5.685G	58	5.306G	59	5.535G	60	5.434G
61	5.409G	62	5.276G	63	5.630G	64	5.334G
65	5.622G	66	5.722G	67	5.398G	68	5.585G
69	5.426G	70	5.371G	71	5.635G	72	5.407G
73	5.301G	74	5.697G	75	5.587G	76	5.527G
77	5.531G	78	5.710G	79	5.596G	80	5.496G
81	5.581G	82	5.700G	83	5.266G	84	5.459G
85	5.391G	86	5.262G	87	5.676G	88	5.433G
89	5.356G	90	5.450G	91	5.327G	92	5.499G
93	5.688G	94	5.549G	95	5.457G	96	5.504G
97	5.453G	98	5.684G	99	5.703G	100	5.270G

Hopping Frequency Sequence Name: HOP_FREQ_SEQ_08							
SEQ#	Frequency (Hz)	SEQ#	Frequency (Hz)	SEQ#	Frequency (Hz)	SEQ#	Frequency (Hz)
1	5.363G	2	5.262G	3	5.577G	4	5.717G
5	5.258G	6	5.695G	7	5.437G	8	5.430G
9	5.328G	10	5.628G	11	5.417G	12	5.263G
13	5.712G	14	5.508G	15	5.316G	16	5.444G
17	5.337G	18	5.346G	19	5.591G	20	5.519G
21	5.512G	22	5.465G	23	5.571G	24	5.590G
25	5.630G	26	5.653G	27	5.432G	28	5.534G
29	5.409G	30	5.529G	31	5.404G	32	5.646G
33	5.657G	34	5.365G	35	5.567G	36	5.587G
37	5.659G	38	5.427G	39	5.370G	40	5.496G
41	5.407G	42	5.515G	43	5.672G	44	5.680G
45	5.619G	46	5.301G	47	5.558G	48	5.683G
49	5.720G	50	5.624G	51	5.350G	52	5.563G
53	5.383G	54	5.528G	55	5.267G	56	5.445G
57	5.400G	58	5.357G	59	5.458G	60	5.500G
61	5.668G	62	5.715G	63	5.509G	64	5.584G
65	5.614G	66	5.599G	67	5.367G	68	5.420G
69	5.362G	70	5.270G	71	5.623G	72	5.616G
73	5.652G	74	5.518G	75	5.542G	76	5.314G
77	5.342G	78	5.384G	79	5.280G	80	5.373G
81	5.306G	82	5.621G	83	5.658G	84	5.431G
85	5.615G	86	5.266G	87	5.513G	88	5.671G
89	5.352G	90	5.335G	91	5.576G	92	5.303G
93	5.557G	94	5.704G	95	5.539G	96	5.535G
97	5.354G	98	5.608G	99	5.475G	100	5.560G

Hopping Frequency Sequence Name: HOP_FREQ_SEQ_09							
SEQ#	Frequency (Hz)	SEQ#	Frequency (Hz)	SEQ#	Frequency (Hz)	SEQ#	Frequency (Hz)
1	5.544G	2	5.513G	3	5.676G	4	5.478G
5	5.688G	6	5.494G	7	5.366G	8	5.633G
9	5.280G	10	5.559G	11	5.611G	12	5.296G
13	5.330G	14	5.421G	15	5.441G	16	5.273G
17	5.265G	18	5.350G	19	5.316G	20	5.488G
21	5.645G	22	5.703G	23	5.472G	24	5.547G
25	5.613G	26	5.606G	27	5.443G	28	5.467G
29	5.582G	30	5.555G	31	5.540G	32	5.548G
33	5.447G	34	5.619G	35	5.318G	36	5.262G
37	5.439G	38	5.313G	39	5.448G	40	5.678G
41	5.495G	42	5.630G	43	5.689G	44	5.646G
45	5.470G	46	5.625G	47	5.453G	48	5.491G
49	5.713G	50	5.695G	51	5.518G	52	5.628G
53	5.269G	54	5.528G	55	5.526G	56	5.565G
57	5.523G	58	5.533G	59	5.696G	60	5.364G
61	5.706G	62	5.370G	63	5.289G	64	5.652G
65	5.444G	66	5.641G	67	5.701G	68	5.365G
69	5.381G	70	5.643G	71	5.719G	72	5.363G
73	5.299G	74	5.367G	75	5.300G	76	5.479G
77	5.651G	78	5.465G	79	5.634G	80	5.588G
81	5.475G	82	5.531G	83	5.721G	84	5.274G
85	5.504G	86	5.332G	87	5.675G	88	5.355G
89	5.487G	90	5.637G	91	5.463G	92	5.293G
93	5.545G	94	5.449G	95	5.656G	96	5.462G
97	5.687G	98	5.614G	99	5.427G	100	5.360G

Hopping Frequency Sequence Name: HOP_FREQ_SEQ_10							
SEQ#	Frequency (Hz)	SEQ#	Frequency (Hz)	SEQ#	Frequency (Hz)	SEQ#	Frequency (Hz)
1	5.366G	2	5.457G	3	5.616G	4	5.665G
5	5.432G	6	5.405G	7	5.453G	8	5.397G
9	5.528G	10	5.299G	11	5.629G	12	5.608G
13	5.541G	14	5.342G	15	5.641G	16	5.671G
17	5.480G	18	5.696G	19	5.331G	20	5.322G
21	5.420G	22	5.602G	23	5.610G	24	5.416G
25	5.506G	26	5.700G	27	5.452G	28	5.640G
29	5.613G	30	5.590G	31	5.705G	32	5.384G
33	5.264G	34	5.302G	35	5.723G	36	5.365G
37	5.557G	38	5.577G	39	5.359G	40	5.691G
41	5.360G	42	5.620G	43	5.258G	44	5.718G
45	5.296G	46	5.656G	47	5.497G	48	5.274G
49	5.437G	50	5.294G	51	5.394G	52	5.275G
53	5.661G	54	5.312G	55	5.434G	56	5.418G
57	5.576G	58	5.566G	59	5.381G	60	5.666G
61	5.327G	62	5.717G	63	5.555G	64	5.445G
65	5.668G	66	5.300G	67	5.498G	68	5.377G
69	5.310G	70	5.650G	71	5.462G	72	5.669G
73	5.441G	74	5.575G	75	5.325G	76	5.267G
77	5.632G	78	5.351G	79	5.543G	80	5.478G
81	5.426G	82	5.502G	83	5.634G	84	5.352G
85	5.442G	86	5.282G	87	5.542G	88	5.330G
89	5.270G	90	5.399G	91	5.293G	92	5.287G
93	5.367G	94	5.251G	95	5.531G	96	5.395G
97	5.463G	98	5.257G	99	5.503G	100	5.707G

Hopping Frequency Sequence Name: HOP_FREQ_SEQ_11							
SEQ#	Frequency (Hz)	SEQ#	Frequency (Hz)	SEQ#	Frequency (Hz)	SEQ#	Frequency (Hz)
1	5.322G	2	5.615G	3	5.463G	4	5.448G
5	5.472G	6	5.282G	7	5.602G	8	5.673G
9	5.590G	10	5.395G	11	5.652G	12	5.393G
13	5.616G	14	5.635G	15	5.630G	16	5.693G
17	5.678G	18	5.612G	19	5.687G	20	5.255G
21	5.493G	22	5.263G	23	5.549G	24	5.710G
25	5.584G	26	5.299G	27	5.319G	28	5.486G
29	5.374G	30	5.515G	31	5.698G	32	5.505G
33	5.606G	34	5.320G	35	5.543G	36	5.622G
37	5.460G	38	5.632G	39	5.517G	40	5.568G
41	5.540G	42	5.677G	43	5.444G	44	5.594G
45	5.485G	46	5.258G	47	5.600G	48	5.487G
49	5.380G	50	5.536G	51	5.323G	52	5.435G
53	5.637G	54	5.578G	55	5.449G	56	5.286G
57	5.475G	58	5.351G	59	5.546G	60	5.500G
61	5.628G	62	5.433G	63	5.437G	64	5.634G
65	5.723G	66	5.538G	67	5.342G	68	5.266G
69	5.724G	70	5.350G	71	5.502G	72	5.553G
73	5.459G	74	5.406G	75	5.717G	76	5.654G
77	5.709G	78	5.440G	79	5.371G	80	5.661G
81	5.484G	82	5.593G	83	5.525G	84	5.411G
85	5.327G	86	5.274G	87	5.585G	88	5.712G
89	5.310G	90	5.577G	91	5.701G	92	5.638G
93	5.399G	94	5.722G	95	5.720G	96	5.567G
97	5.439G	98	5.269G	99	5.290G	100	5.363G



Hopping Frequency Sequence Name: HOP_FREQ_SEQ_12							
SEQ#	Frequency (Hz)	SEQ#	Frequency (Hz)	SEQ#	Frequency (Hz)	SEQ#	Frequency (Hz)
1	5.492G	2	5.688G	3	5.600G	4	5.705G
5	5.278G	6	5.375G	7	5.486G	8	5.525G
9	5.497G	10	5.266G	11	5.380G	12	5.662G
13	5.596G	14	5.587G	15	5.505G	16	5.628G
17	5.305G	18	5.598G	19	5.389G	20	5.286G
21	5.461G	22	5.716G	23	5.449G	24	5.318G
25	5.341G	26	5.310G	27	5.404G	28	5.617G
29	5.641G	30	5.259G	31	5.469G	32	5.253G
33	5.267G	34	5.533G	35	5.667G	36	5.692G
37	5.547G	38	5.574G	39	5.556G	40	5.680G
41	5.465G	42	5.707G	43	5.672G	44	5.257G
45	5.698G	46	5.646G	47	5.666G	48	5.315G
49	5.390G	50	5.402G	51	5.468G	52	5.357G
53	5.601G	54	5.476G	55	5.430G	56	5.488G
57	5.718G	58	5.273G	59	5.427G	60	5.344G
61	5.271G	62	5.454G	63	5.580G	64	5.586G
65	5.435G	66	5.507G	67	5.424G	68	5.664G
69	5.369G	70	5.621G	71	5.373G	72	5.258G
73	5.445G	74	5.370G	75	5.487G	76	5.410G
77	5.302G	78	5.374G	79	5.640G	80	5.643G
81	5.314G	82	5.651G	83	5.541G	84	5.683G
85	5.442G	86	5.669G	87	5.407G	88	5.496G
89	5.512G	90	5.552G	91	5.308G	92	5.475G
93	5.498G	94	5.372G	95	5.695G	96	5.376G
97	5.499G	98	5.637G	99	5.420G	100	5.624G

Hopping Frequency Sequence Name: HOP_FREQ_SEQ_13							
SEQ#	Frequency (Hz)	SEQ#	Frequency (Hz)	SEQ#	Frequency (Hz)	SEQ#	Frequency (Hz)
1	5.410G	2	5.300G	3	5.615G	4	5.298G
5	5.352G	6	5.558G	7	5.600G	8	5.422G
9	5.281G	10	5.279G	11	5.522G	12	5.552G
13	5.450G	14	5.585G	15	5.339G	16	5.614G
17	5.267G	18	5.694G	19	5.285G	20	5.513G
21	5.326G	22	5.387G	23	5.506G	24	5.388G
25	5.712G	26	5.343G	27	5.318G	28	5.313G
29	5.478G	30	5.534G	31	5.323G	32	5.346G
33	5.463G	34	5.554G	35	5.540G	36	5.551G
37	5.666G	38	5.334G	39	5.629G	40	5.574G
41	5.702G	42	5.415G	43	5.724G	44	5.488G
45	5.664G	46	5.430G	47	5.671G	48	5.261G
49	5.532G	50	5.275G	51	5.292G	52	5.271G
53	5.652G	54	5.498G	55	5.350G	56	5.662G
57	5.418G	58	5.505G	59	5.374G	60	5.508G
61	5.663G	62	5.714G	63	5.347G	64	5.570G
65	5.580G	66	5.480G	67	5.302G	68	5.665G
69	5.646G	70	5.503G	71	5.398G	72	5.703G
73	5.491G	74	5.581G	75	5.409G	76	5.591G
77	5.563G	78	5.473G	79	5.403G	80	5.562G
81	5.575G	82	5.365G	83	5.649G	84	5.621G
85	5.507G	86	5.687G	87	5.425G	88	5.341G
89	5.706G	90	5.359G	91	5.690G	92	5.477G
93	5.354G	94	5.459G	95	5.435G	96	5.376G
97	5.617G	98	5.620G	99	5.330G	100	5.557G

Hopping Frequency Sequence Name: HOP_FREQ_SEQ_14							
SEQ#	Frequency (Hz)	SEQ#	Frequency (Hz)	SEQ#	Frequency (Hz)	SEQ#	Frequency (Hz)
1	5.456G	2	5.600G	3	5.468G	4	5.387G
5	5.551G	6	5.310G	7	5.276G	8	5.699G
9	5.633G	10	5.537G	11	5.530G	12	5.697G
13	5.579G	14	5.696G	15	5.289G	16	5.333G
17	5.614G	18	5.617G	19	5.322G	20	5.319G
21	5.473G	22	5.353G	23	5.450G	24	5.649G
25	5.440G	26	5.258G	27	5.393G	28	5.318G
29	5.529G	30	5.700G	31	5.500G	32	5.636G
33	5.425G	34	5.454G	35	5.612G	36	5.377G
37	5.605G	38	5.475G	39	5.445G	40	5.562G
41	5.693G	42	5.477G	43	5.395G	44	5.368G
45	5.497G	46	5.713G	47	5.514G	48	5.295G
49	5.290G	50	5.373G	51	5.553G	52	5.264G
53	5.394G	54	5.417G	55	5.591G	56	5.372G
57	5.482G	58	5.418G	59	5.351G	60	5.522G
61	5.487G	62	5.413G	63	5.525G	64	5.308G
65	5.428G	66	5.640G	67	5.397G	68	5.592G
69	5.668G	70	5.662G	71	5.251G	72	5.282G
73	5.340G	74	5.576G	75	5.646G	76	5.589G
77	5.546G	78	5.643G	79	5.347G	80	5.673G
81	5.575G	82	5.405G	83	5.486G	84	5.360G
85	5.404G	86	5.294G	87	5.712G	88	5.655G
89	5.505G	90	5.570G	91	5.564G	92	5.447G
93	5.552G	94	5.641G	95	5.320G	96	5.637G
97	5.691G	98	5.465G	99	5.467G	100	5.412G

Hopping Frequency Sequence Name: HOP_FREQ_SEQ_15							
SEQ#	Frequency (Hz)	SEQ#	Frequency (Hz)	SEQ#	Frequency (Hz)	SEQ#	Frequency (Hz)
1	5.456G	2	5.251G	3	5.378G	4	5.654G
5	5.410G	6	5.639G	7	5.398G	8	5.480G
9	5.577G	10	5.656G	11	5.426G	12	5.545G
13	5.658G	14	5.380G	15	5.431G	16	5.326G
17	5.593G	18	5.614G	19	5.677G	20	5.602G
21	5.496G	22	5.284G	23	5.671G	24	5.579G
25	5.259G	26	5.336G	27	5.312G	28	5.403G
29	5.631G	30	5.483G	31	5.569G	32	5.291G
33	5.520G	34	5.563G	35	5.588G	36	5.299G
37	5.486G	38	5.565G	39	5.329G	40	5.369G
41	5.621G	42	5.609G	43	5.661G	44	5.538G
45	5.303G	46	5.571G	47	5.500G	48	5.430G
49	5.434G	50	5.394G	51	5.498G	52	5.675G
53	5.292G	54	5.470G	55	5.605G	56	5.652G
57	5.334G	58	5.504G	59	5.529G	60	5.627G
61	5.420G	62	5.317G	63	5.554G	64	5.306G
65	5.536G	66	5.640G	67	5.664G	68	5.309G
69	5.518G	70	5.673G	71	5.560G	72	5.625G
73	5.353G	74	5.648G	75	5.547G	76	5.342G
77	5.553G	78	5.375G	79	5.508G	80	5.466G
81	5.682G	82	5.493G	83	5.628G	84	5.585G
85	5.457G	86	5.290G	87	5.253G	88	5.517G
89	5.476G	90	5.436G	91	5.718G	92	5.716G
93	5.454G	94	5.482G	95	5.330G	96	5.644G
97	5.611G	98	5.408G	99	5.649G	100	5.667G

Hopping Frequency Sequence Name: HOP_FREQ_SEQ_16							
SEQ#	Frequency (Hz)	SEQ#	Frequency (Hz)	SEQ#	Frequency (Hz)	SEQ#	Frequency (Hz)
1	5.686G	2	5.627G	3	5.708G	4	5.542G
5	5.341G	6	5.612G	7	5.443G	8	5.650G
9	5.457G	10	5.574G	11	5.404G	12	5.451G
13	5.724G	14	5.716G	15	5.570G	16	5.498G
17	5.651G	18	5.312G	19	5.448G	20	5.617G
21	5.437G	22	5.715G	23	5.293G	24	5.563G
25	5.620G	26	5.454G	27	5.480G	28	5.387G
29	5.552G	30	5.486G	31	5.485G	32	5.491G
33	5.307G	34	5.531G	35	5.255G	36	5.334G
37	5.318G	38	5.305G	39	5.466G	40	5.250G
41	5.494G	42	5.640G	43	5.638G	44	5.405G
45	5.357G	46	5.633G	47	5.616G	48	5.317G
49	5.402G	50	5.606G	51	5.327G	52	5.497G
53	5.378G	54	5.252G	55	5.265G	56	5.450G
57	5.581G	58	5.468G	59	5.278G	60	5.415G
61	5.439G	62	5.274G	63	5.577G	64	5.330G
65	5.356G	66	5.475G	67	5.536G	68	5.645G
69	5.525G	70	5.548G	71	5.452G	72	5.503G
73	5.592G	74	5.270G	75	5.398G	76	5.534G
77	5.262G	78	5.302G	79	5.280G	80	5.571G
81	5.401G	82	5.504G	83	5.588G	84	5.524G
85	5.458G	86	5.306G	87	5.721G	88	5.385G
89	5.382G	90	5.431G	91	5.671G	92	5.611G
93	5.427G	94	5.301G	95	5.550G	96	5.400G
97	5.602G	98	5.446G	99	5.662G	100	5.381G

Hopping Frequency Sequence Name: HOP_FREQ_SEQ_17							
SEQ#	Frequency (Hz)	SEQ#	Frequency (Hz)	SEQ#	Frequency (Hz)	SEQ#	Frequency (Hz)
1	5.587G	2	5.701G	3	5.676G	4	5.319G
5	5.429G	6	5.466G	7	5.673G	8	5.277G
9	5.461G	10	5.583G	11	5.313G	12	5.287G
13	5.275G	14	5.465G	15	5.335G	16	5.637G
17	5.451G	18	5.614G	19	5.642G	20	5.516G
21	5.639G	22	5.351G	23	5.252G	24	5.315G
25	5.568G	26	5.290G	27	5.474G	28	5.361G
29	5.494G	30	5.362G	31	5.626G	32	5.506G
33	5.523G	34	5.372G	35	5.484G	36	5.578G
37	5.694G	38	5.283G	39	5.343G	40	5.323G
41	5.299G	42	5.627G	43	5.279G	44	5.294G
45	5.346G	46	5.300G	47	5.724G	48	5.696G
49	5.453G	50	5.255G	51	5.380G	52	5.260G
53	5.482G	54	5.598G	55	5.658G	56	5.263G
57	5.593G	58	5.640G	59	5.580G	60	5.497G
61	5.450G	62	5.328G	63	5.660G	64	5.320G
65	5.644G	66	5.345G	67	5.485G	68	5.609G
69	5.625G	70	5.411G	71	5.303G	72	5.291G
73	5.360G	74	5.295G	75	5.615G	76	5.261G
77	5.548G	78	5.698G	79	5.353G	80	5.683G
81	5.528G	82	5.667G	83	5.486G	84	5.618G
85	5.396G	86	5.292G	87	5.652G	88	5.705G
89	5.712G	90	5.391G	91	5.648G	92	5.702G
93	5.336G	94	5.418G	95	5.371G	96	5.703G
97	5.339G	98	5.316G	99	5.682G	100	5.550G

Hopping Frequency Sequence Name: HOP_FREQ_SEQ_18							
SEQ#	Frequency (Hz)	SEQ#	Frequency (Hz)	SEQ#	Frequency (Hz)	SEQ#	Frequency (Hz)
1	5.475G	2	5.427G	3	5.712G	4	5.464G
5	5.373G	6	5.474G	7	5.648G	8	5.387G
9	5.647G	10	5.523G	11	5.539G	12	5.641G
13	5.465G	14	5.342G	15	5.360G	16	5.656G
17	5.298G	18	5.292G	19	5.572G	20	5.366G
21	5.458G	22	5.307G	23	5.349G	24	5.251G
25	5.554G	26	5.392G	27	5.272G	28	5.323G
29	5.587G	30	5.687G	31	5.579G	32	5.544G
33	5.637G	34	5.486G	35	5.440G	36	5.479G
37	5.379G	38	5.639G	39	5.266G	40	5.625G
41	5.422G	42	5.405G	43	5.412G	44	5.608G
45	5.505G	46	5.267G	47	5.657G	48	5.684G
49	5.497G	50	5.480G	51	5.501G	52	5.269G
53	5.466G	54	5.401G	55	5.472G	56	5.660G
57	5.614G	58	5.615G	59	5.593G	60	5.283G
61	5.601G	62	5.644G	63	5.646G	64	5.668G
65	5.720G	66	5.456G	67	5.653G	68	5.581G
69	5.512G	70	5.552G	71	5.372G	72	5.259G
73	5.557G	74	5.573G	75	5.457G	76	5.327G
77	5.507G	78	5.268G	79	5.551G	80	5.319G
81	5.383G	82	5.493G	83	5.499G	84	5.381G
85	5.277G	86	5.434G	87	5.482G	88	5.638G
89	5.543G	90	5.548G	91	5.492G	92	5.570G
93	5.626G	94	5.441G	95	5.673G	96	5.698G
97	5.389G	98	5.500G	99	5.357G	100	5.707G

Hopping Frequency Sequence Name: HOP_FREQ_SEQ_19							
SEQ#	Frequency (Hz)	SEQ#	Frequency (Hz)	SEQ#	Frequency (Hz)	SEQ#	Frequency (Hz)
1	5.304G	2	5.594G	3	5.336G	4	5.257G
5	5.678G	6	5.716G	7	5.645G	8	5.399G
9	5.302G	10	5.381G	11	5.453G	12	5.681G
13	5.720G	14	5.722G	15	5.259G	16	5.450G
17	5.351G	18	5.314G	19	5.268G	20	5.641G
21	5.506G	22	5.601G	23	5.642G	24	5.481G
25	5.444G	26	5.395G	27	5.648G	28	5.479G
29	5.693G	30	5.568G	31	5.602G	32	5.333G
33	5.598G	34	5.687G	35	5.474G	36	5.603G
37	5.460G	38	5.263G	39	5.673G	40	5.318G
41	5.553G	42	5.352G	43	5.586G	44	5.529G
45	5.539G	46	5.717G	47	5.465G	48	5.697G
49	5.699G	50	5.516G	51	5.297G	52	5.316G
53	5.588G	54	5.514G	55	5.295G	56	5.379G
57	5.672G	58	5.462G	59	5.619G	60	5.380G
61	5.485G	62	5.543G	63	5.618G	64	5.368G
65	5.689G	66	5.521G	67	5.505G	68	5.430G
69	5.696G	70	5.437G	71	5.312G	72	5.384G
73	5.417G	74	5.599G	75	5.421G	76	5.659G
77	5.638G	78	5.515G	79	5.555G	80	5.651G
81	5.398G	82	5.431G	83	5.698G	84	5.377G
85	5.328G	86	5.497G	87	5.639G	88	5.710G
89	5.559G	90	5.653G	91	5.445G	92	5.606G
93	5.486G	94	5.310G	95	5.563G	96	5.254G
97	5.518G	98	5.690G	99	5.386G	100	5.688G



Hopping Frequency Sequence Name: HOP_FREQ_SEQ_20							
SEQ#	Frequency (Hz)	SEQ#	Frequency (Hz)	SEQ#	Frequency (Hz)	SEQ#	Frequency (Hz)
1	5.471G	2	5.355G	3	5.462G	4	5.272G
5	5.647G	6	5.357G	7	5.463G	8	5.465G
9	5.598G	10	5.721G	11	5.363G	12	5.298G
13	5.601G	14	5.367G	15	5.453G	16	5.430G
17	5.300G	18	5.715G	19	5.576G	20	5.630G
21	5.499G	22	5.267G	23	5.632G	24	5.667G
25	5.570G	26	5.518G	27	5.669G	28	5.292G
29	5.522G	30	5.482G	31	5.483G	32	5.475G
33	5.649G	34	5.717G	35	5.368G	36	5.585G
37	5.271G	38	5.703G	39	5.639G	40	5.269G
41	5.572G	42	5.719G	43	5.515G	44	5.376G
45	5.291G	46	5.288G	47	5.591G	48	5.395G
49	5.607G	50	5.508G	51	5.545G	52	5.341G
53	5.707G	54	5.429G	55	5.657G	56	5.474G
57	5.620G	58	5.358G	59	5.480G	60	5.501G
61	5.382G	62	5.262G	63	5.467G	64	5.602G
65	5.705G	66	5.334G	67	5.318G	68	5.258G
69	5.678G	70	5.380G	71	5.523G	72	5.421G
73	5.533G	74	5.558G	75	5.655G	76	5.461G
77	5.679G	78	5.338G	79	5.264G	80	5.403G
81	5.330G	82	5.493G	83	5.711G	84	5.496G
85	5.353G	86	5.614G	87	5.276G	88	5.560G
89	5.426G	90	5.634G	91	5.688G	92	5.442G
93	5.436G	94	5.662G	95	5.460G	96	5.401G
97	5.708G	98	5.310G	99	5.283G	100	5.328G

Hopping Frequency Sequence Name: HOP_FREQ_SEQ_21							
SEQ#	Frequency (Hz)	SEQ#	Frequency (Hz)	SEQ#	Frequency (Hz)	SEQ#	Frequency (Hz)
1	5.666G	2	5.551G	3	5.678G	4	5.335G
5	5.319G	6	5.371G	7	5.676G	8	5.425G
9	5.328G	10	5.437G	11	5.483G	12	5.364G
13	5.579G	14	5.473G	15	5.711G	16	5.713G
17	5.545G	18	5.647G	19	5.458G	20	5.259G
21	5.255G	22	5.719G	23	5.515G	24	5.524G
25	5.419G	26	5.260G	27	5.635G	28	5.374G
29	5.563G	30	5.258G	31	5.434G	32	5.367G
33	5.331G	34	5.366G	35	5.314G	36	5.674G
37	5.451G	38	5.615G	39	5.386G	40	5.427G
41	5.269G	42	5.445G	43	5.416G	44	5.698G
45	5.392G	46	5.361G	47	5.571G	48	5.526G
49	5.329G	50	5.583G	51	5.689G	52	5.709G
53	5.393G	54	5.394G	55	5.646G	56	5.501G
57	5.261G	58	5.342G	59	5.540G	60	5.315G
61	5.544G	62	5.391G	63	5.513G	64	5.569G
65	5.496G	66	5.442G	67	5.618G	68	5.553G
69	5.356G	70	5.480G	71	5.694G	72	5.409G
73	5.656G	74	5.701G	75	5.441G	76	5.278G
77	5.370G	78	5.297G	79	5.603G	80	5.502G
81	5.485G	82	5.598G	83	5.421G	84	5.341G
85	5.444G	86	5.400G	87	5.607G	88	5.467G
89	5.538G	90	5.352G	91	5.688G	92	5.535G
93	5.311G	94	5.594G	95	5.457G	96	5.586G
97	5.272G	98	5.578G	99	5.608G	100	5.274G

Hopping Frequency Sequence Name: HOP_FREQ_SEQ_22							
SEQ#	Frequency (Hz)	SEQ#	Frequency (Hz)	SEQ#	Frequency (Hz)	SEQ#	Frequency (Hz)
1	5.261G	2	5.374G	3	5.611G	4	5.309G
5	5.418G	6	5.252G	7	5.260G	8	5.393G
9	5.591G	10	5.303G	11	5.268G	12	5.724G
13	5.601G	14	5.541G	15	5.462G	16	5.717G
17	5.644G	18	5.680G	19	5.609G	20	5.702G
21	5.621G	22	5.476G	23	5.341G	24	5.630G
25	5.468G	26	5.398G	27	5.584G	28	5.354G
29	5.570G	30	5.547G	31	5.459G	32	5.688G
33	5.475G	34	5.278G	35	5.314G	36	5.703G
37	5.663G	38	5.257G	39	5.589G	40	5.637G
41	5.508G	42	5.448G	43	5.265G	44	5.367G
45	5.361G	46	5.647G	47	5.506G	48	5.522G
49	5.593G	50	5.662G	51	5.414G	52	5.349G
53	5.355G	54	5.685G	55	5.451G	56	5.494G
57	5.415G	58	5.525G	59	5.698G	60	5.291G
61	5.477G	62	5.330G	63	5.569G	64	5.460G
65	5.677G	66	5.333G	67	5.472G	68	5.411G
69	5.602G	70	5.581G	71	5.505G	72	5.542G
73	5.699G	74	5.607G	75	5.722G	76	5.568G
77	5.442G	78	5.562G	79	5.387G	80	5.713G
81	5.376G	82	5.467G	83	5.715G	84	5.648G
85	5.381G	86	5.576G	87	5.655G	88	5.292G
89	5.615G	90	5.325G	91	5.347G	92	5.539G
93	5.307G	94	5.283G	95	5.284G	96	5.669G
97	5.397G	98	5.499G	99	5.465G	100	5.658G

Hopping Frequency Sequence Name: HOP_FREQ_SEQ_23							
SEQ#	Frequency (Hz)	SEQ#	Frequency (Hz)	SEQ#	Frequency (Hz)	SEQ#	Frequency (Hz)
1	5.724G	2	5.268G	3	5.254G	4	5.433G
5	5.276G	6	5.695G	7	5.627G	8	5.312G
9	5.513G	10	5.681G	11	5.334G	12	5.463G
13	5.293G	14	5.666G	15	5.343G	16	5.267G
17	5.431G	18	5.322G	19	5.339G	20	5.538G
21	5.673G	22	5.607G	23	5.325G	24	5.664G
25	5.536G	26	5.281G	27	5.443G	28	5.514G
29	5.589G	30	5.272G	31	5.502G	32	5.594G
33	5.451G	34	5.441G	35	5.523G	36	5.622G
37	5.353G	38	5.608G	39	5.708G	40	5.672G
41	5.714G	42	5.378G	43	5.571G	44	5.303G
45	5.667G	46	5.368G	47	5.579G	48	5.417G
49	5.279G	50	5.568G	51	5.711G	52	5.308G
53	5.337G	54	5.432G	55	5.532G	56	5.572G
57	5.309G	58	5.696G	59	5.614G	60	5.358G
61	5.603G	62	5.385G	63	5.439G	64	5.453G
65	5.274G	66	5.280G	67	5.365G	68	5.363G
69	5.438G	70	5.289G	71	5.655G	72	5.318G
73	5.585G	74	5.349G	75	5.455G	76	5.346G
77	5.396G	78	5.686G	79	5.350G	80	5.545G
81	5.405G	82	5.409G	83	5.465G	84	5.301G
85	5.599G	86	5.360G	87	5.691G	88	5.381G
89	5.540G	90	5.469G	91	5.561G	92	5.406G
93	5.652G	94	5.651G	95	5.486G	96	5.701G
97	5.389G	98	5.375G	99	5.461G	100	5.418G

Hopping Frequency Sequence Name: HOP_FREQ_SEQ_24							
SEQ#	Frequency (Hz)	SEQ#	Frequency (Hz)	SEQ#	Frequency (Hz)	SEQ#	Frequency (Hz)
1	5.406G	2	5.350G	3	5.638G	4	5.302G
5	5.412G	6	5.559G	7	5.471G	8	5.481G
9	5.348G	10	5.688G	11	5.554G	12	5.320G
13	5.437G	14	5.467G	15	5.709G	16	5.580G
17	5.333G	18	5.396G	19	5.651G	20	5.596G
21	5.669G	22	5.545G	23	5.434G	24	5.494G
25	5.407G	26	5.670G	27	5.469G	28	5.438G
29	5.573G	30	5.606G	31	5.250G	32	5.425G
33	5.284G	34	5.415G	35	5.500G	36	5.446G
37	5.259G	38	5.660G	39	5.586G	40	5.528G
41	5.347G	42	5.682G	43	5.397G	44	5.344G
45	5.265G	46	5.675G	47	5.257G	48	5.703G
49	5.475G	50	5.604G	51	5.535G	52	5.546G
53	5.400G	54	5.285G	55	5.718G	56	5.650G
57	5.620G	58	5.564G	59	5.693G	60	5.349G
61	5.523G	62	5.668G	63	5.626G	64	5.311G
65	5.522G	66	5.441G	67	5.386G	68	5.657G
69	5.714G	70	5.338G	71	5.255G	72	5.477G
73	5.408G	74	5.575G	75	5.639G	76	5.525G
77	5.663G	78	5.269G	79	5.337G	80	5.541G
81	5.607G	82	5.508G	83	5.431G	84	5.395G
85	5.390G	86	5.628G	87	5.619G	88	5.673G
89	5.345G	90	5.263G	91	5.721G	92	5.676G
93	5.453G	94	5.578G	95	5.558G	96	5.643G
97	5.723G	98	5.491G	99	5.328G	100	5.410G

Hopping Frequency Sequence Name: HOP_FREQ_SEQ_25							
SEQ#	Frequency (Hz)	SEQ#	Frequency (Hz)	SEQ#	Frequency (Hz)	SEQ#	Frequency (Hz)
1	5.307G	2	5.683G	3	5.310G	4	5.425G
5	5.426G	6	5.324G	7	5.330G	8	5.622G
9	5.356G	10	5.554G	11	5.421G	12	5.611G
13	5.588G	14	5.413G	15	5.551G	16	5.404G
17	5.595G	18	5.376G	19	5.641G	20	5.253G
21	5.664G	22	5.523G	23	5.604G	24	5.318G
25	5.317G	26	5.600G	27	5.557G	28	5.540G
29	5.507G	30	5.341G	31	5.542G	32	5.283G
33	5.675G	34	5.350G	35	5.628G	36	5.610G
37	5.606G	38	5.475G	39	5.250G	40	5.393G
41	5.357G	42	5.576G	43	5.701G	44	5.631G
45	5.388G	46	5.602G	47	5.570G	48	5.457G
49	5.428G	50	5.303G	51	5.639G	52	5.418G
53	5.677G	54	5.623G	55	5.414G	56	5.635G
57	5.304G	58	5.459G	59	5.716G	60	5.666G
61	5.265G	62	5.302G	63	5.454G	64	5.462G
65	5.374G	66	5.336G	67	5.287G	68	5.407G
69	5.312G	70	5.331G	71	5.720G	72	5.572G
73	5.714G	74	5.306G	75	5.522G	76	5.596G
77	5.433G	78	5.309G	79	5.373G	80	5.401G
81	5.340G	82	5.549G	83	5.552G	84	5.464G
85	5.299G	86	5.436G	87	5.384G	88	5.478G
89	5.533G	90	5.276G	91	5.580G	92	5.477G
93	5.670G	94	5.252G	95	5.483G	96	5.502G
97	5.680G	98	5.353G	99	5.636G	100	5.556G

Hopping Frequency Sequence Name: HOP_FREQ_SEQ_26							
SEQ#	Frequency (Hz)	SEQ#	Frequency (Hz)	SEQ#	Frequency (Hz)	SEQ#	Frequency (Hz)
1	5.335G	2	5.638G	3	5.268G	4	5.530G
5	5.404G	6	5.399G	7	5.368G	8	5.646G
9	5.382G	10	5.475G	11	5.500G	12	5.497G
13	5.724G	14	5.668G	15	5.608G	16	5.355G
17	5.427G	18	5.572G	19	5.584G	20	5.429G
21	5.574G	22	5.591G	23	5.694G	24	5.455G
25	5.364G	26	5.676G	27	5.303G	28	5.482G
29	5.547G	30	5.711G	31	5.654G	32	5.398G
33	5.421G	34	5.639G	35	5.612G	36	5.444G
37	5.378G	38	5.520G	39	5.369G	40	5.679G
41	5.340G	42	5.657G	43	5.598G	44	5.410G
45	5.348G	46	5.375G	47	5.323G	48	5.554G
49	5.438G	50	5.423G	51	5.424G	52	5.349G
53	5.656G	54	5.528G	55	5.544G	56	5.558G
57	5.696G	58	5.586G	59	5.411G	60	5.680G
61	5.315G	62	5.611G	63	5.465G	64	5.551G
65	5.600G	66	5.447G	67	5.599G	68	5.630G
69	5.330G	70	5.287G	71	5.606G	72	5.358G
73	5.457G	74	5.501G	75	5.643G	76	5.366G
77	5.493G	78	5.623G	79	5.555G	80	5.619G
81	5.590G	82	5.473G	83	5.440G	84	5.367G
85	5.557G	86	5.471G	87	5.395G	88	5.328G
89	5.626G	90	5.459G	91	5.486G	92	5.263G
93	5.408G	94	5.689G	95	5.699G	96	5.351G
97	5.363G	98	5.414G	99	5.697G	100	5.409G

Hopping Frequency Sequence Name: HOP_FREQ_SEQ_27							
SEQ#	Frequency (Hz)	SEQ#	Frequency (Hz)	SEQ#	Frequency (Hz)	SEQ#	Frequency (Hz)
1	5.429G	2	5.538G	3	5.442G	4	5.291G
5	5.714G	6	5.647G	7	5.578G	8	5.350G
9	5.440G	10	5.614G	11	5.324G	12	5.695G
13	5.633G	14	5.450G	15	5.418G	16	5.655G
17	5.433G	18	5.606G	19	5.312G	20	5.356G
21	5.626G	22	5.330G	23	5.367G	24	5.349G
25	5.555G	26	5.559G	27	5.341G	28	5.691G
29	5.579G	30	5.495G	31	5.544G	32	5.668G
33	5.331G	34	5.272G	35	5.261G	36	5.516G
37	5.363G	38	5.458G	39	5.268G	40	5.589G
41	5.576G	42	5.251G	43	5.337G	44	5.469G
45	5.287G	46	5.476G	47	5.370G	48	5.496G
49	5.386G	50	5.682G	51	5.259G	52	5.518G
53	5.343G	54	5.355G	55	5.527G	56	5.323G
57	5.492G	58	5.260G	59	5.439G	60	5.486G
61	5.672G	62	5.634G	63	5.645G	64	5.366G
65	5.677G	66	5.407G	67	5.618G	68	5.673G
69	5.293G	70	5.271G	71	5.710G	72	5.671G
73	5.651G	74	5.351G	75	5.375G	76	5.596G
77	5.317G	78	5.552G	79	5.454G	80	5.696G
81	5.512G	82	5.417G	83	5.557G	84	5.639G
85	5.624G	86	5.362G	87	5.494G	88	5.625G
89	5.584G	90	5.548G	91	5.394G	92	5.338G
93	5.667G	94	5.303G	95	5.318G	96	5.365G
97	5.387G	98	5.305G	99	5.683G	100	5.573G



Hopping Frequency Sequence Name: HOP_FREQ_SEQ_28							
SEQ#	Frequency (Hz)	SEQ#	Frequency (Hz)	SEQ#	Frequency (Hz)	SEQ#	Frequency (Hz)
1	5.426G	2	5.442G	3	5.421G	4	5.642G
5	5.367G	6	5.404G	7	5.639G	8	5.265G
9	5.682G	10	5.498G	11	5.292G	12	5.551G
13	5.721G	14	5.448G	15	5.356G	16	5.290G
17	5.338G	18	5.530G	19	5.514G	20	5.341G
21	5.408G	22	5.476G	23	5.574G	24	5.429G
25	5.470G	26	5.375G	27	5.606G	28	5.467G
29	5.653G	30	5.496G	31	5.557G	32	5.697G
33	5.256G	34	5.381G	35	5.362G	36	5.406G
37	5.438G	38	5.624G	39	5.592G	40	5.300G
41	5.427G	42	5.454G	43	5.335G	44	5.403G
45	5.360G	46	5.322G	47	5.506G	48	5.570G
49	5.371G	50	5.302G	51	5.493G	52	5.650G
53	5.683G	54	5.471G	55	5.560G	56	5.562G
57	5.361G	58	5.722G	59	5.334G	60	5.586G
61	5.561G	62	5.710G	63	5.286G	64	5.644G
65	5.536G	66	5.398G	67	5.717G	68	5.252G
69	5.538G	70	5.434G	71	5.707G	72	5.698G
73	5.446G	74	5.350G	75	5.413G	76	5.364G
77	5.531G	78	5.311G	79	5.323G	80	5.712G
81	5.255G	82	5.468G	83	5.521G	84	5.517G
85	5.351G	86	5.724G	87	5.324G	88	5.693G
89	5.461G	90	5.685G	91	5.464G	92	5.542G
93	5.649G	94	5.329G	95	5.540G	96	5.667G
97	5.344G	98	5.319G	99	5.328G	100	5.405G

Hopping Frequency Sequence Name: HOP_FREQ_SEQ_29							
SEQ#	Frequency (Hz)	SEQ#	Frequency (Hz)	SEQ#	Frequency (Hz)	SEQ#	Frequency (Hz)
1	5.436G	2	5.468G	3	5.482G	4	5.412G
5	5.400G	6	5.555G	7	5.567G	8	5.612G
9	5.404G	10	5.676G	11	5.408G	12	5.389G
13	5.383G	14	5.634G	15	5.391G	16	5.299G
17	5.652G	18	5.478G	19	5.376G	20	5.428G
21	5.378G	22	5.677G	23	5.598G	24	5.570G
25	5.450G	26	5.361G	27	5.655G	28	5.520G
29	5.351G	30	5.491G	31	5.287G	32	5.508G
33	5.656G	34	5.278G	35	5.569G	36	5.602G
37	5.592G	38	5.373G	39	5.397G	40	5.387G
41	5.414G	42	5.538G	43	5.684G	44	5.722G
45	5.721G	46	5.597G	47	5.499G	48	5.530G
49	5.717G	50	5.711G	51	5.650G	52	5.599G
53	5.437G	54	5.614G	55	5.308G	56	5.343G
57	5.493G	58	5.621G	59	5.279G	60	5.505G
61	5.282G	62	5.531G	63	5.498G	64	5.258G
65	5.549G	66	5.695G	67	5.405G	68	5.320G
69	5.692G	70	5.418G	71	5.518G	72	5.410G
73	5.346G	74	5.274G	75	5.496G	76	5.255G
77	5.675G	78	5.718G	79	5.312G	80	5.528G
81	5.335G	82	5.344G	83	5.560G	84	5.647G
85	5.337G	86	5.542G	87	5.585G	88	5.363G
89	5.487G	90	5.353G	91	5.458G	92	5.653G
93	5.494G	94	5.706G	95	5.658G	96	5.254G
97	5.456G	98	5.623G	99	5.548G	100	5.322G

Hopping Frequency Sequence Name: HOP_FREQ_SEQ_30							
SEQ#	Frequency (Hz)	SEQ#	Frequency (Hz)	SEQ#	Frequency (Hz)	SEQ#	Frequency (Hz)
1	5.353G	2	5.618G	3	5.610G	4	5.714G
5	5.335G	6	5.666G	7	5.691G	8	5.358G
9	5.337G	10	5.558G	11	5.329G	12	5.665G
13	5.467G	14	5.607G	15	5.488G	16	5.592G
17	5.657G	18	5.317G	19	5.502G	20	5.682G
21	5.555G	22	5.690G	23	5.339G	24	5.302G
25	5.461G	26	5.654G	27	5.585G	28	5.676G
29	5.629G	30	5.342G	31	5.681G	32	5.506G
33	5.650G	34	5.425G	35	5.299G	36	5.323G
37	5.370G	38	5.282G	39	5.318G	40	5.421G
41	5.594G	42	5.474G	43	5.428G	44	5.702G
45	5.532G	46	5.279G	47	5.531G	48	5.389G
49	5.410G	50	5.569G	51	5.567G	52	5.698G
53	5.435G	54	5.258G	55	5.473G	56	5.464G
57	5.457G	58	5.505G	59	5.384G	60	5.362G
61	5.707G	62	5.431G	63	5.254G	64	5.386G
65	5.719G	66	5.327G	67	5.263G	68	5.439G
69	5.641G	70	5.500G	71	5.675G	72	5.601G
73	5.341G	74	5.522G	75	5.379G	76	5.614G
77	5.559G	78	5.472G	79	5.524G	80	5.359G
81	5.291G	82	5.597G	83	5.262G	84	5.535G
85	5.434G	86	5.712G	87	5.551G	88	5.620G
89	5.480G	90	5.390G	91	5.724G	92	5.465G
93	5.660G	94	5.408G	95	5.405G	96	5.580G
97	5.672G	98	5.304G	99	5.515G	100	5.699G

**IEEE 802.11n 40MHz**

Type 1 Radar Statistical Performances				
Trial #	Pulses per Burst	Pulse Width (s)	PRI (s)	Detection
1	18	1.0u	1.428m	Yes
2	18	1.0u	1.428m	Yes
3	18	1.0u	1.428m	Yes
4	18	1.0u	1.428m	Yes
5	18	1.0u	1.428m	Yes
6	18	1.0u	1.428m	Yes
7	18	1.0u	1.428m	Yes
8	18	1.0u	1.428m	Yes
9	18	1.0u	1.428m	Yes
10	18	1.0u	1.428m	Yes
11	18	1.0u	1.428m	Yes
12	18	1.0u	1.428m	Yes
13	18	1.0u	1.428m	Yes
14	18	1.0u	1.428m	Yes
15	18	1.0u	1.428m	Yes
16	18	1.0u	1.428m	Yes
17	18	1.0u	1.428m	Yes
18	18	1.0u	1.428m	Yes
19	18	1.0u	1.428m	Yes
20	18	1.0u	1.428m	Yes
21	18	1.0u	1.428m	No
22	18	1.0u	1.428m	Yes
23	18	1.0u	1.428m	Yes
24	18	1.0u	1.428m	Yes
25	18	1.0u	1.428m	Yes
26	18	1.0u	1.428m	No
27	18	1.0u	1.428m	Yes
28	18	1.0u	1.428m	Yes
29	18	1.0u	1.428m	Yes
30	18	1.0u	1.428m	Yes
Detection Rate: 93.3 %				

Type 2 Radar Statistical Performances				
Trial #	Pulses per Burst	Pulse Width (s)	PRI (s)	Detection
1	25	4.6u	200.0u	Yes
2	27	2.8u	200.0u	Yes
3	27	1.7u	161.0u	Yes
4	28	2.6u	220.0u	Yes
5	27	2.6u	218.0u	Yes
6	27	1.7u	172.0u	Yes
7	26	1.6u	191.0u	Yes
8	25	3.7u	158.0u	Yes
9	28	1.5u	228.0u	Yes
10	26	4.9u	198.0u	No
11	28	1.3u	205.0u	Yes
12	29	2.6u	155.0u	Yes
13	28	4.9u	224.0u	Yes
14	24	2.9u	169.0u	No
15	28	4.1u	183.0u	Yes
16	27	1.7u	192.0u	No
17	24	2.6u	191.0u	Yes
18	27	4.6u	173.0u	Yes
19	28	3.4u	187.0u	No
20	27	4.3u	214.0u	Yes
21	29	1.2u	179.0u	Yes
22	25	1.1u	154.0u	Yes
23	25	4.1u	159.0u	Yes
24	28	2.9u	158.0u	Yes
25	25	2.8u	215.0u	Yes
26	27	4.0u	196.0u	Yes
27	27	4.5u	215.0u	Yes
28	27	2.9u	180.0u	Yes
29	27	1.5u	177.0u	Yes
30	28	1.6u	186.0u	Yes
				Detection Rate: 86.7 %

Type 3 Radar Statistical Performances				
Trial #	Pulses per Burst	Pulse Width (s)	PRI (s)	Detection
1	18	7.1u	412.0u	Yes
2	18	9.7u	423.0u	No
3	17	7.4u	489.0u	Yes
4	17	7.8u	280.0u	Yes
5	17	9.7u	416.0u	No
6	18	8.4u	224.0u	Yes
7	17	8.5u	363.0u	Yes
8	16	7.1u	409.0u	Yes
9	16	6.0u	411.0u	Yes
10	17	7.6u	207.0u	Yes
11	17	9.2u	333.0u	Yes
12	17	8.8u	338.0u	Yes
13	17	9.7u	473.0u	Yes
14	17	9.1u	320.0u	Yes
15	17	7.3u	239.0u	Yes
16	17	6.6u	335.0u	Yes
17	18	9.2u	295.0u	Yes
18	16	8.9u	414.0u	Yes
19	18	9.5u	387.0u	Yes
20	16	7.3u	497.0u	Yes
21	16	7.1u	426.0u	Yes
22	17	6.0u	493.0u	No
23	17	9.5u	315.0u	Yes
24	18	7.9u	338.0u	Yes
25	18	9.3u	477.0u	Yes
26	17	6.0u	327.0u	Yes
27	17	6.7u	495.0u	Yes
28	17	6.0u	336.0u	Yes
29	18	6.4u	372.0u	Yes
30	17	7.5u	494.0u	Yes
				Detection Rate: 90.0 %

Type 4 Radar Statistical Performances				
Trial #	Pulses per Burst	Pulse Width (s)	PRI (s)	Detection
1	14	14.3u	312.0u	Yes
2	13	18.3u	368.0u	No
3	13	18.4u	392.0u	Yes
4	16	14.9u	457.0u	Yes
5	13	15.9u	337.0u	Yes
6	14	13.7u	413.0u	Yes
7	13	13.6u	263.0u	No
8	14	11.2u	484.0u	Yes
9	12	11.6u	341.0u	Yes
10	14	18.2u	448.0u	No
11	14	14.2u	423.0u	Yes
12	14	12.4u	470.0u	Yes
13	13	18.0u	336.0u	Yes
14	15	17.8u	213.0u	Yes
15	14	11.8u	297.0u	Yes
16	15	16.6u	436.0u	Yes
17	15	16.8u	298.0u	Yes
18	13	14.9u	459.0u	Yes
19	14	19.5u	286.0u	No
20	16	18.4u	462.0u	Yes
21	15	19.0u	314.0u	Yes
22	15	16.2u	284.0u	Yes
23	13	16.9u	396.0u	Yes
24	15	14.9u	202.0u	Yes
25	14	17.8u	492.0u	Yes
26	12	14.2u	451.0u	Yes
27	12	18.2u	350.0u	Yes
28	15	14.7u	204.0u	Yes
29	12	16.6u	418.0u	Yes
30	13	14.1u	218.0u	Yes
				Detection Rate: 86.7 %

Type 5 Radar Statistical Performances		
Trial #	Test Signal Name	Detection
1	LP_Signal_01	No
2	LP_Signal_02	Yes
3	LP_Signal_03	No
4	LP_Signal_04	No
5	LP_Signal_05	Yes
6	LP_Signal_06	Yes
7	LP_Signal_07	Yes
8	LP_Signal_08	Yes
9	LP_Signal_09	Yes
10	LP_Signal_10	Yes
11	LP_Signal_11	Yes
12	LP_Signal_12	Yes
13	LP_Signal_13	Yes
14	LP_Signal_14	Yes
15	LP_Signal_15	No
16	LP_Signal_16	Yes
17	LP_Signal_17	Yes
18	LP_Signal_18	Yes
19	LP_Signal_19	Yes
20	LP_Signal_20	Yes
21	LP_Signal_21	Yes
22	LP_Signal_22	Yes
23	LP_Signal_23	Yes
24	LP_Signal_24	Yes
25	LP_Signal_25	Yes
26	LP_Signal_26	No
27	LP_Signal_27	Yes
28	LP_Signal_28	Yes
29	LP_Signal_29	Yes
30	LP_Signal_30	Yes
		Detection Rate: 83.3 %



Long Pulse Radar Test Signal						
Test Signal Name: LP_Signal_01						
Number of Bursts in Trial: 17						
Burst	Pulses per Burst	Chrip (Hz)	Pulse Width (s)	Pulse 1 to 2 Spacing (s)	Pulse 2 to 3 Spacing (s)	Start Location (s)
1	3	12M	79.5u	1.705m	1.445m	362.4m
2	2	18M	69.9u	1.602m	-	523.1m
3	3	18M	70.8u	1.255m	1.794m	353.4m
4	1	11M	86.2u	-	-	401.1m
5	2	19M	92.9u	1.810m	-	119.5m
6	2	12M	55.4u	1.331m	-	323.8m
7	2	9M	96.6u	1.406m	-	284.8m
8	2	12M	74.4u	1.213m	-	30.24m
9	3	17M	74.1u	1.752m	1.858m	98.58m
10	3	20M	96.3u	967.7u	1.566m	391.9m
11	2	7M	66.2u	1.650m	-	503.8m
12	3	8M	65.2u	1.218m	1.706m	286.2m
13	2	9M	81.5u	1.875m	-	288.0m
14	3	12M	63.9u	1.622m	1.383m	103.7m
15	1	17M	82.9u	-	-	530.4m
16	2	9M	72.5u	1.271m	-	172.0m
17	2	19M	99.3u	1.461m	-	132.0m

Long Pulse Radar Test Signal						
Test Signal Name: LP_Signal_02						
Number of Bursts in Trial: 15						
Burst	Pulses per Burst	Chrip (Hz)	Pulse Width (s)	Pulse 1 to 2 Spacing (s)	Pulse 2 to 3 Spacing (s)	Start Location (s)
1	2	12M	63.4u	1.747m	-	402.8m
2	1	11M	92.8u	-	-	680.9m
3	1	8M	51.2u	-	-	480.0m
4	1	6M	69.0u	-	-	394.9m
5	3	20M	85.0u	1.161m	1.795m	365.1m
6	2	18M	73.3u	1.770m	-	84.27m
7	2	9M	72.0u	1.545m	-	419.2m
8	2	12M	90.3u	1.566m	-	287.3m
9	2	6M	83.2u	936.8u	-	460.7m
10	2	15M	56.2u	985.8u	-	356.1m
11	3	18M	56.5u	1.253m	1.256m	746.0m
12	2	19M	68.9u	1.080m	-	197.1m
13	3	18M	83.7u	1.845m	1.883m	393.6m
14	1	14M	66.5u	-	-	434.6m
15	2	8M	80.2u	1.411m	-	391.3m

Long Pulse Radar Test Signal						
Test Signal Name: LP_Signal_03						
Number of Bursts in Trial: 10						
Burst	Pulses per Burst	Chrip (Hz)	Pulse Width (s)	Pulse 1 to 2 Spacing (s)	Pulse 2 to 3 Spacing (s)	Start Location (s)
1	2	8M	84.5u	1.580m	-	330.9m
2	2	15M	58.8u	1.662m	-	984.0m
3	2	7M	85.5u	1.704m	-	786.0m
4	2	11M	95.9u	1.349m	-	65.99m
5	2	19M	85.6u	1.021m	-	1.100
6	1	20M	74.6u	-	-	1.147
7	1	11M	70.5u	-	-	20.10m
8	1	18M	66.9u	-	-	743.3m
9	3	18M	56.1u	1.441m	1.561m	1.071
10	3	14M	69.5u	1.857m	1.765m	542.6m

Long Pulse Radar Test Signal						
Test Signal Name: LP_Signal_04						
Number of Bursts in Trial: 9						
Burst	Pulses per Burst	Chrip (Hz)	Pulse Width (s)	Pulse 1 to 2 Spacing (s)	Pulse 2 to 3 Spacing (s)	Start Location (s)
1	1	12M	56.2u	-	-	597.6m
2	1	15M	50.2u	-	-	58.69m
3	3	18M	83.6u	1.492m	968.4u	378.8m
4	1	13M	67.3u	-	-	316.8m
5	3	10M	63.5u	956.5u	1.896m	151.0m
6	3	16M	51.0u	1.150m	1.515m	177.6m
7	2	11M	73.4u	1.224m	-	363.2m
8	2	13M	84.6u	1.441m	-	559.2m
9	1	12M	98.2u	-	-	975.3m

Long Pulse Radar Test Signal						
Test Signal Name: LP_Signal_05						
Number of Bursts in Trial: 10						
Burst	Pulses per Burst	Chrip (Hz)	Pulse Width (s)	Pulse 1 to 2 Spacing (s)	Pulse 2 to 3 Spacing (s)	Start Location (s)
1	1	12M	91.6u	-	-	83.79m
2	2	13M	98.2u	1.696m	-	728.7m
3	2	15M	94.8u	1.142m	-	721.9m
4	3	16M	97.5u	1.417m	917.5u	1.089
5	2	18M	72.6u	1.577m	-	371.1m
6	2	14M	69.3u	1.314m	-	1.131
7	2	17M	65.5u	1.524m	-	862.1m
8	1	11M	98.5u	-	-	960.9m
9	2	17M	77.2u	1.726m	-	1.178
10	3	16M	83.8u	1.007m	1.499m	969.2m

Long Pulse Radar Test Signal						
Test Signal Name: LP_Signal_06						
Number of Bursts in Trial: 18						
Burst	Pulses per Burst	Chrip (Hz)	Pulse Width (s)	Pulse 1 to 2 Spacing (s)	Pulse 2 to 3 Spacing (s)	Start Location (s)
1	2	7M	63.1u	1.205m	-	543.3m
2	3	9M	89.1u	917.9u	1.824m	233.1m
3	2	14M	79.7u	1.399m	-	518.9m
4	2	7M	78.7u	1.743m	-	263.2m
5	3	19M	81.0u	1.692m	1.356m	631.0m
6	1	10M	73.7u	-	-	164.8m
7	1	13M	66.0u	-	-	203.2m
8	1	5M	66.3u	-	-	585.1m
9	3	12M	65.2u	1.604m	1.707m	37.25m
10	3	19M	85.0u	1.507m	1.715m	268.8m
11	2	19M	78.1u	1.635m	-	662.6m
12	3	6M	54.6u	1.244m	971.4u	570.4m
13	3	16M	89.5u	1.901m	1.486m	363.1m
14	3	10M	54.8u	1.659m	1.558m	340.2m
15	2	12M	69.5u	973.5u	-	361.4m
16	2	12M	96.6u	1.005m	-	613.1m
17	3	9M	64.5u	1.828m	1.587m	499.4m
18	1	10M	86.0u	-	-	392.9m

Long Pulse Radar Test Signal						
Test Signal Name: LP_Signal_07						
Number of Bursts in Trial: 15						
Burst	Pulses per Burst	Chrip (Hz)	Pulse Width (s)	Pulse 1 to 2 Spacing (s)	Pulse 2 to 3 Spacing (s)	Start Location (s)
1	1	19M	68.5u	-	-	234.5m
2	2	14M	83.5u	1.251m	-	33.14m
3	2	14M	54.8u	1.868m	-	759.3m
4	1	15M	53.0u	-	-	482.6m
5	2	12M	88.5u	1.793m	-	85.48m
6	3	12M	81.8u	1.099m	1.165m	107.1m
7	2	11M	85.8u	1.525m	-	420.7m
8	2	6M	80.3u	1.824m	-	569.6m
9	3	20M	68.0u	1.664m	979.0u	606.3m
10	1	12M	84.7u	-	-	600.4m
11	3	5M	78.9u	1.666m	1.092m	700.4m
12	1	18M	50.8u	-	-	277.9m
13	2	15M	99.0u	1.672m	-	402.5m
14	3	11M	75.4u	1.338m	1.162m	371.6m
15	2	9M	52.3u	1.939m	-	217.1m

Long Pulse Radar Test Signal						
Test Signal Name: LP_Signal_08						
Number of Bursts in Trial: 10						
Burst	Pulses per Burst	Chrip (Hz)	Pulse Width (s)	Pulse 1 to 2 Spacing (s)	Pulse 2 to 3 Spacing (s)	Start Location (s)
1	3	18M	51.7u	1.675m	1.840m	844.6m
2	2	16M	52.5u	1.309m	-	371.1m
3	3	17M	53.9u	1.386m	1.436m	351.4m
4	1	8M	64.4u	-	-	205.2m
5	3	15M	89.5u	1.332m	1.846m	532.3m
6	2	12M	87.6u	1.343m	-	598.3m
7	1	16M	72.6u	-	-	856.0m
8	2	14M	99.2u	1.799m	-	1.053
9	1	13M	95.1u	-	-	1.086
10	1	13M	88.4u	-	-	621.7m

Long Pulse Radar Test Signal						
Test Signal Name: LP_Signal_09						
Number of Bursts in Trial: 9						
Burst	Pulses per Burst	Chrip (Hz)	Pulse Width (s)	Pulse 1 to 2 Spacing (s)	Pulse 2 to 3 Spacing (s)	Start Location (s)
1	3	8M	70.3u	1.737m	1.252m	335.6m
2	1	11M	84.7u	-	-	440.9m
3	2	12M	84.2u	1.530m	-	1.207
4	1	8M	93.4u	-	-	363.1m
5	2	9M	97.9u	1.187m	-	529.2m
6	2	14M	53.2u	1.425m	-	1.218
7	2	7M	88.5u	1.373m	-	328.2m
8	2	19M	83.6u	1.112m	-	810.2m
9	1	13M	67.7u	-	-	1.173

Long Pulse Radar Test Signal						
Test Signal Name: LP_Signal_10						
Number of Bursts in Trial: 19						
Burst	Pulses per Burst	Chrip (Hz)	Pulse Width (s)	Pulse 1 to 2 Spacing (s)	Pulse 2 to 3 Spacing (s)	Start Location (s)
1	2	8M	63.8u	1.661m	-	86.75m
2	1	9M	69.9u	-	-	34.87m
3	2	20M	73.5u	1.108m	-	289.6m
4	3	15M	50.1u	1.415m	1.854m	304.0m
5	2	6M	76.5u	1.236m	-	570.2m
6	3	10M	55.2u	1.346m	1.212m	40.77m
7	1	17M	74.8u	-	-	50.11m
8	2	18M	82.2u	1.200m	-	430.8m
9	2	14M	66.8u	1.121m	-	76.06m
10	1	16M	80.0u	-	-	105.0m
11	3	9M	60.6u	1.769m	1.214m	417.9m
12	2	6M	66.1u	1.004m	-	28.34m
13	1	16M	75.1u	-	-	533.8m
14	2	8M	92.1u	1.154m	-	138.0m
15	2	7M	64.1u	1.869m	-	192.0m
16	1	15M	71.7u	-	-	607.4m
17	2	6M	57.0u	1.751m	-	74.28m
18	2	15M	56.4u	1.384m	-	458.1m
19	3	13M	94.4u	1.583m	1.741m	377.3m



Long Pulse Radar Test Signal						
Test Signal Name: LP_Signal_11						
Number of Bursts in Trial: 10						
Burst	Pulses per Burst	Chrip (Hz)	Pulse Width (s)	Pulse 1 to 2 Spacing (s)	Pulse 2 to 3 Spacing (s)	Start Location (s)
1	2	11M	92.8u	1.034m	-	1.018
2	1	7M	98.5u	-	-	678.2m
3	1	6M	59.7u	-	-	527.1m
4	1	16M	59.9u	-	-	43.10m
5	1	5M	62.5u	-	-	941.7m
6	2	12M	68.7u	1.737m	-	612.4m
7	3	20M	89.8u	1.363m	1.082m	174.3m
8	2	8M	83.2u	1.828m	-	455.5m
9	3	19M	71.8u	1.034m	1.344m	52.44m
10	1	7M	84.5u	-	-	581.3m

Long Pulse Radar Test Signal						
Test Signal Name: LP_Signal_12						
Number of Bursts in Trial: 10						
Burst	Pulses per Burst	Chrip (Hz)	Pulse Width (s)	Pulse 1 to 2 Spacing (s)	Pulse 2 to 3 Spacing (s)	Start Location (s)
1	2	14M	61.8u	1.843m	-	734.7m
2	3	13M	78.1u	1.671m	1.013m	712.5m
3	1	19M	88.0u	-	-	590.6m
4	3	6M	82.0u	1.833m	1.447m	918.1m
5	2	20M	55.2u	1.797m	-	389.3m
6	2	11M	60.4u	1.321m	-	799.7m
7	3	14M	94.9u	1.114m	1.231m	514.6m
8	2	6M	79.8u	1.703m	-	424.0m
9	3	15M	75.7u	1.657m	1.862m	1.180
10	2	9M	51.1u	1.004m	-	18.70m

Long Pulse Radar Test Signal						
Test Signal Name: LP_Signal_13						
Number of Bursts in Trial: 13						
Burst	Pulses per Burst	Chrip (Hz)	Pulse Width (s)	Pulse 1 to 2 Spacing (s)	Pulse 2 to 3 Spacing (s)	Start Location (s)
1	1	6M	73.4u	-	-	504.3m
2	2	19M	98.1u	994.9u	-	545.5m
3	1	9M	93.5u	-	-	322.4m
4	1	14M	77.3u	-	-	180.2m
5	1	6M	76.0u	-	-	350.6m
6	2	15M	56.2u	1.416m	-	467.3m
7	1	8M	88.1u	-	-	522.0m
8	3	10M	73.4u	1.053m	1.825m	172.9m
9	2	15M	75.0u	1.232m	-	802.1m
10	1	18M	97.8u	-	-	25.50m
11	2	8M	93.1u	1.807m	-	143.8m
12	2	10M	68.7u	1.591m	-	761.4m
13	2	15M	82.8u	1.258m	-	687.8m

Long Pulse Radar Test Signal						
Test Signal Name: LP_Signal_14						
Number of Bursts in Trial: 14						
Burst	Pulses per Burst	Chrip (Hz)	Pulse Width (s)	Pulse 1 to 2 Spacing (s)	Pulse 2 to 3 Spacing (s)	Start Location (s)
1	1	7M	56.9u	-	-	481.2m
2	3	6M	82.8u	1.716m	1.682m	269.8m
3	2	11M	71.1u	1.766m	-	702.4m
4	2	19M	86.4u	1.320m	-	765.0m
5	3	18M	79.2u	1.262m	1.445m	547.2m
6	3	17M	92.2u	1.672m	1.581m	241.3m
7	3	14M	79.3u	1.430m	1.585m	138.0m
8	3	17M	53.9u	1.293m	947.1u	843.3m
9	1	8M	54.2u	-	-	217.9m
10	2	9M	71.5u	1.347m	-	68.80m
11	2	11M	65.4u	1.467m	-	803.0m
12	1	8M	62.5u	-	-	250.4m
13	2	12M	60.0u	1.119m	-	699.2m
14	2	20M	59.1u	1.772m	-	263.5m

Long Pulse Radar Test Signal						
Test Signal Name: LP_Signal_15						
Number of Bursts in Trial: 17						
Burst	Pulses per Burst	Chrip (Hz)	Pulse Width (s)	Pulse 1 to 2 Spacing (s)	Pulse 2 to 3 Spacing (s)	Start Location (s)
1	2	10M	61.4u	1.925m	-	406.7m
2	2	17M	65.2u	1.930m	-	506.3m
3	2	5M	60.1u	1.225m	-	352.2m
4	2	14M	69.3u	1.628m	-	516.1m
5	1	12M	76.7u	-	-	69.02m
6	2	8M	57.8u	1.232m	-	293.7m
7	1	10M	76.9u	-	-	51.10m
8	2	13M	73.9u	1.390m	-	649.1m
9	2	9M	96.1u	1.023m	-	116.4m
10	3	16M	84.4u	935.6u	1.252m	618.9m
11	1	8M	57.6u	-	-	114.9m
12	2	7M	76.8u	1.252m	-	693.3m
13	2	12M	67.0u	1.358m	-	205.6m
14	2	12M	56.9u	1.727m	-	338.7m
15	2	13M	68.6u	1.723m	-	307.5m
16	2	19M	65.2u	1.584m	-	276.2m
17	1	17M	60.4u	-	-	100.8m

Long Pulse Radar Test Signal						
Test Signal Name: LP_Signal_16						
Number of Bursts in Trial: 10						
Burst	Pulses per Burst	Chrip (Hz)	Pulse Width (s)	Pulse 1 to 2 Spacing (s)	Pulse 2 to 3 Spacing (s)	Start Location (s)
1	3	17M	92.7u	1.327m	1.415m	126.9m
2	3	20M	66.5u	1.708m	1.334m	696.5m
3	2	15M	92.8u	1.617m	-	1.188
4	1	11M	53.6u	-	-	586.6m
5	3	15M	84.0u	1.000m	1.158m	127.9m
6	2	16M	52.4u	1.495m	-	534.9m
7	1	7M	71.1u	-	-	871.5m
8	3	8M	63.9u	1.711m	1.585m	333.7m
9	2	7M	70.7u	1.502m	-	77.02m
10	2	10M	77.2u	1.164m	-	226.4m

Long Pulse Radar Test Signal						
Test Signal Name: LP_Signal_17						
Number of Bursts in Trial: 18						
Burst	Pulses per Burst	Chrip (Hz)	Pulse Width (s)	Pulse 1 to 2 Spacing (s)	Pulse 2 to 3 Spacing (s)	Start Location (s)
1	2	13M	53.0u	1.063m	-	376.6m
2	2	16M	76.6u	1.134m	-	365.2m
3	1	19M	74.2u	-	-	632.6m
4	2	16M	79.6u	1.428m	-	14.43m
5	1	13M	68.1u	-	-	502.7m
6	1	6M	88.3u	-	-	607.1m
7	2	8M	95.8u	1.628m	-	514.6m
8	3	7M	96.4u	1.346m	1.609m	33.40m
9	2	10M	58.3u	990.7u	-	49.06m
10	1	14M	59.0u	-	-	90.22m
11	2	18M	71.3u	1.224m	-	83.70m
12	3	17M	82.1u	1.132m	1.707m	366.2m
13	3	19M	86.6u	1.125m	1.614m	177.7m
14	1	8M	58.1u	-	-	169.5m
15	1	17M	93.6u	-	-	80.21m
16	1	9M	56.3u	-	-	376.6m
17	2	14M	96.1u	1.463m	-	416.0m
18	1	5M	89.1u	-	-	640.9m

Long Pulse Radar Test Signal						
Test Signal Name: LP_Signal_18						
Number of Bursts in Trial: 14						
Burst	Pulses per Burst	Chrip (Hz)	Pulse Width (s)	Pulse 1 to 2 Spacing (s)	Pulse 2 to 3 Spacing (s)	Start Location (s)
1	2	8M	65.5u	1.832m	-	789.4m
2	3	19M	91.5u	1.605m	1.548m	238.0m
3	3	18M	83.3u	1.642m	1.615m	48.26m
4	3	17M	94.6u	932.4u	1.648m	727.5m
5	3	6M	61.7u	1.259m	1.506m	471.0m
6	2	19M	68.2u	1.239m	-	132.6m
7	2	10M	64.9u	1.355m	-	138.8m
8	2	18M	81.0u	1.697m	-	445.2m
9	2	6M	88.3u	1.309m	-	285.2m
10	3	12M	90.9u	1.274m	1.119m	429.4m
11	3	11M	53.0u	948.0u	1.200m	482.1m
12	2	17M	73.5u	1.914m	-	735.5m
13	2	19M	71.7u	1.165m	-	525.5m
14	2	17M	55.9u	1.939m	-	491.3m

Long Pulse Radar Test Signal						
Test Signal Name: LP_Signal_19						
Number of Bursts in Trial: 13						
Burst	Pulses per Burst	Chrip (Hz)	Pulse Width (s)	Pulse 1 to 2 Spacing (s)	Pulse 2 to 3 Spacing (s)	Start Location (s)
1	3	13M	51.9u	1.544m	1.864m	375.1m
2	2	11M	81.5u	1.143m	-	192.7m
3	1	19M	91.3u	-	-	633.2m
4	2	13M	97.6u	1.724m	-	756.5m
5	3	5M	97.2u	1.842m	1.182m	890.8m
6	1	14M	62.6u	-	-	420.7m
7	2	15M	59.3u	1.146m	-	707.2m
8	1	13M	62.5u	-	-	668.1m
9	1	16M	76.1u	-	-	360.0m
10	2	13M	82.1u	1.526m	-	570.7m
11	3	8M	87.5u	1.894m	1.907m	759.4m
12	3	13M	60.4u	1.459m	1.237m	103.4m
13	2	15M	63.9u	1.313m	-	583.3m



Long Pulse Radar Test Signal						
Test Signal Name: LP_Signal_20						
Number of Bursts in Trial: 14						
Burst	Pulses per Burst	Chrip (Hz)	Pulse Width (s)	Pulse 1 to 2 Spacing (s)	Pulse 2 to 3 Spacing (s)	Start Location (s)
1	2	8M	64.0u	1.885m	-	398.6m
2	2	6M	80.1u	1.386m	-	516.7m
3	2	15M	89.2u	1.549m	-	66.33m
4	1	15M	71.7u	-	-	355.1m
5	2	10M	94.9u	1.166m	-	571.5m
6	2	7M	76.0u	1.788m	-	195.6m
7	2	11M	53.3u	1.302m	-	602.4m
8	2	18M	56.3u	1.384m	-	424.1m
9	2	20M	98.6u	1.624m	-	158.0m
10	2	9M	80.9u	1.343m	-	423.4m
11	2	13M	82.2u	1.817m	-	608.6m
12	1	13M	93.2u	-	-	310.3m
13	1	5M	55.8u	-	-	821.3m
14	1	20M	63.0u	-	-	421.6m

Long Pulse Radar Test Signal						
Test Signal Name: LP_Signal_21						
Number of Bursts in Trial: 10						
Burst	Pulses per Burst	Chrip (Hz)	Pulse Width (s)	Pulse 1 to 2 Spacing (s)	Pulse 2 to 3 Spacing (s)	Start Location (s)
1	2	14M	81.2u	1.666m	-	562.9m
2	1	7M	83.7u	-	-	932.9m
3	3	7M	80.2u	1.590m	1.831m	176.9m
4	2	18M	92.0u	1.519m	-	323.6m
5	3	18M	92.6u	1.055m	970.4u	817.2m
6	2	6M	74.2u	926.8u	-	691.5m
7	2	10M	71.2u	1.683m	-	1.054
8	2	5M	61.9u	1.087m	-	838.7m
9	2	8M	68.9u	1.360m	-	414.8m
10	2	10M	71.0u	1.394m	-	775.8m

Long Pulse Radar Test Signal						
Test Signal Name: LP_Signal_22						
Number of Bursts in Trial: 15						
Burst	Pulses per Burst	Chrip (Hz)	Pulse Width (s)	Pulse 1 to 2 Spacing (s)	Pulse 2 to 3 Spacing (s)	Start Location (s)
1	1	6M	89.2u	-	-	343.1m
2	3	9M	71.1u	1.713m	1.792m	238.0m
3	2	18M	78.1u	1.252m	-	342.7m
4	3	13M	66.6u	1.709m	1.755m	446.9m
5	2	14M	50.2u	1.120m	-	165.3m
6	2	20M	82.7u	1.589m	-	513.9m
7	1	18M	69.3u	-	-	343.3m
8	2	16M	75.7u	1.814m	-	701.8m
9	2	14M	50.7u	1.070m	-	754.0m
10	3	5M	87.7u	1.512m	1.442m	100.1m
11	3	20M	51.9u	1.696m	1.681m	96.05m
12	3	18M	73.9u	1.616m	1.166m	368.0m
13	2	7M	97.2u	914.8u	-	298.8m
14	3	5M	75.6u	1.798m	1.175m	511.0m
15	1	7M	60.5u	-	-	656.6m

Long Pulse Radar Test Signal						
Test Signal Name: LP_Signal_23						
Number of Bursts in Trial: 10						
Burst	Pulses per Burst	Chrip (Hz)	Pulse Width (s)	Pulse 1 to 2 Spacing (s)	Pulse 2 to 3 Spacing (s)	Start Location (s)
1	2	8M	98.4u	1.057m	-	804.0m
2	3	11M	60.6u	1.163m	1.594m	514.2m
3	2	17M	71.7u	1.263m	-	460.4m
4	2	18M	58.6u	1.118m	-	333.8m
5	1	12M	71.5u	-	-	196.3m
6	1	20M	86.5u	-	-	480.7m
7	1	6M	82.9u	-	-	701.2m
8	1	16M	73.5u	-	-	1.165
9	3	16M	77.6u	948.4u	1.047m	589.3m
10	3	16M	88.9u	1.304m	1.586m	998.7m

Long Pulse Radar Test Signal						
Test Signal Name: LP_Signal_24						
Number of Bursts in Trial: 18						
Burst	Pulses per Burst	Chrip (Hz)	Pulse Width (s)	Pulse 1 to 2 Spacing (s)	Pulse 2 to 3 Spacing (s)	Start Location (s)
1	1	5M	78.2u	-	-	538.8m
2	1	6M	75.6u	-	-	187.9m
3	1	13M	88.6u	-	-	584.6m
4	1	13M	72.7u	-	-	356.1m
5	2	7M	69.5u	961.5u	-	304.4m
6	2	5M	62.0u	1.691m	-	267.7m
7	1	15M	95.5u	-	-	353.6m
8	3	11M	92.2u	1.844m	1.630m	41.27m
9	2	9M	97.7u	1.446m	-	552.6m
10	3	10M	57.6u	1.621m	1.203m	120.4m
11	1	6M	89.9u	-	-	35.45m
12	1	7M	88.2u	-	-	3.635m
13	2	20M	64.6u	1.541m	-	575.6m
14	2	9M	53.7u	1.100m	-	335.2m
15	2	18M	92.6u	1.104m	-	617.2m
16	1	9M	65.3u	-	-	260.3m
17	1	18M	75.2u	-	-	187.2m
18	1	14M	69.9u	-	-	335.0m

Long Pulse Radar Test Signal						
Test Signal Name: LP_Signal_25						
Number of Bursts in Trial: 17						
Burst	Pulses per Burst	Chrip (Hz)	Pulse Width (s)	Pulse 1 to 2 Spacing (s)	Pulse 2 to 3 Spacing (s)	Start Location (s)
1	2	19M	74.3u	1.849m	-	83.06m
2	2	15M	67.0u	1.333m	-	107.9m
3	1	14M	98.1u	-	-	121.0m
4	2	17M	81.7u	1.444m	-	244.0m
5	2	19M	66.1u	1.689m	-	477.3m
6	2	6M	96.9u	909.1u	-	492.9m
7	2	7M	67.7u	1.375m	-	322.3m
8	2	18M	85.7u	1.112m	-	247.8m
9	1	11M	63.1u	-	-	172.3m
10	1	12M	80.5u	-	-	204.5m
11	3	11M	99.1u	1.124m	1.855m	98.56m
12	2	9M	87.1u	1.271m	-	649.2m
13	1	17M	58.8u	-	-	326.8m
14	2	7M	88.9u	1.003m	-	360.9m
15	1	17M	85.1u	-	-	201.1m
16	2	20M	82.8u	1.511m	-	617.1m
17	2	19M	61.9u	1.657m	-	522.4m

Long Pulse Radar Test Signal						
Test Signal Name: LP_Signal_26						
Number of Bursts in Trial: 12						
Burst	Pulses per Burst	Chrip (Hz)	Pulse Width (s)	Pulse 1 to 2 Spacing (s)	Pulse 2 to 3 Spacing (s)	Start Location (s)
1	2	7M	65.5u	1.429m	-	528.4m
2	2	6M	67.7u	1.925m	-	252.5m
3	1	17M	83.7u	-	-	285.4m
4	1	16M	59.2u	-	-	997.6m
5	2	9M	76.5u	1.161m	-	272.6m
6	2	6M	79.5u	1.873m	-	406.8m
7	1	7M	86.5u	-	-	104.5m
8	1	19M	85.6u	-	-	223.4m
9	1	11M	92.2u	-	-	640.5m
10	2	19M	54.6u	1.308m	-	353.7m
11	2	11M	70.1u	1.599m	-	746.9m
12	3	20M	71.6u	997.4u	1.068m	208.9m

Long Pulse Radar Test Signal						
Test Signal Name: LP_Signal_27						
Number of Bursts in Trial: 17						
Burst	Pulses per Burst	Chrip (Hz)	Pulse Width (s)	Pulse 1 to 2 Spacing (s)	Pulse 2 to 3 Spacing (s)	Start Location (s)
1	2	7M	73.2u	1.141m	-	378.0m
2	1	18M	91.5u	-	-	129.8m
3	2	14M	70.5u	1.723m	-	484.5m
4	2	5M	77.2u	1.621m	-	257.3m
5	3	19M	65.6u	1.689m	1.600m	684.0m
6	3	14M	81.8u	1.783m	1.009m	463.4m
7	3	18M	52.1u	1.574m	1.617m	124.9m
8	2	9M	64.7u	1.617m	-	629.4m
9	2	12M	96.0u	1.437m	-	535.1m
10	1	18M	83.1u	-	-	354.6m
11	1	8M	74.3u	-	-	28.15m
12	1	14M	94.4u	-	-	525.6m
13	3	12M	69.5u	1.452m	1.730m	346.9m
14	2	20M	86.8u	1.054m	-	673.0m
15	2	15M	57.0u	1.236m	-	697.4m
16	2	8M	55.7u	1.378m	-	197.8m
17	2	12M	67.9u	1.630m	-	263.1m



Long Pulse Radar Test Signal						
Test Signal Name: LP_Signal_28						
Number of Bursts in Trial: 16						
Burst	Pulses per Burst	Chrip (Hz)	Pulse Width (s)	Pulse 1 to 2 Spacing (s)	Pulse 2 to 3 Spacing (s)	Start Location (s)
1	2	11M	91.2u	1.196m	-	595.0m
2	3	17M	57.3u	1.641m	1.021m	5.132m
3	1	17M	72.7u	-	-	665.6m
4	2	13M	68.8u	1.231m	-	119.0m
5	3	8M	67.1u	1.603m	1.916m	43.18m
6	1	19M	75.7u	-	-	172.4m
7	1	18M	50.4u	-	-	224.6m
8	3	16M	73.8u	1.285m	1.091m	678.5m
9	2	7M	86.5u	1.003m	-	670.5m
10	1	12M	55.0u	-	-	352.1m
11	2	15M	54.9u	1.687m	-	306.9m
12	1	9M	86.4u	-	-	731.7m
13	1	7M	71.4u	-	-	699.2m
14	1	6M	50.6u	-	-	40.77m
15	3	17M	94.5u	1.110m	1.796m	272.4m
16	1	6M	66.6u	-	-	423.4m

Long Pulse Radar Test Signal

Test Signal Name: LP\_Signal\_29

Number of Bursts in Trial: 13

Burst	Pulses per Burst	Chrip (Hz)	Pulse Width (s)	Pulse 1 to 2 Spacing (s)	Pulse 2 to 3 Spacing (s)	Start Location (s)
1	3	8M	96.8u	1.257m	1.528m	862.3m
2	3	15M	53.3u	1.351m	1.462m	610.2m
3	3	8M	63.9u	1.872m	1.549m	199.9m
4	3	15M	64.2u	1.028m	961.8u	196.7m
5	2	18M	59.0u	1.052m	-	740.8m
6	1	16M	78.3u	-	-	624.1m
7	2	8M	62.5u	954.5u	-	531.3m
8	3	18M	72.5u	1.832m	1.530m	714.7m
9	3	12M	60.7u	965.3u	1.236m	673.5m
10	2	13M	79.6u	1.583m	-	334.2m
11	2	9M	68.8u	1.557m	-	316.9m
12	2	8M	69.4u	947.6u	-	492.5m
13	1	14M	64.5u	-	-	399.5m

Long Pulse Radar Test Signal						
Test Signal Name: LP_Signal_30						
Number of Bursts in Trial: 11						
Burst	Pulses per Burst	Chrip (Hz)	Pulse Width (s)	Pulse 1 to 2 Spacing (s)	Pulse 2 to 3 Spacing (s)	Start Location (s)
1	1	16M	50.2u	-	-	278.4m
2	2	12M	80.7u	1.382m	-	730.0m
3	1	12M	81.1u	-	-	265.9m
4	2	7M	84.2u	1.356m	-	400.6m
5	2	9M	65.9u	1.133m	-	406.3m
6	1	11M	89.9u	-	-	847.0m
7	2	13M	98.9u	1.563m	-	242.1m
8	2	8M	82.2u	1.518m	-	565.1m
9	1	6M	68.9u	-	-	482.4m
10	2	11M	87.1u	1.471m	-	945.3m
11	2	19M	92.9u	1.341m	-	1.012

Type 6 Radar Statistical Performances				
Trial #	Pulses per Burst	Pulse Width (s)	PRI (s)	Detection
1	9	1.0u	333.0u	Yes
2	9	1.0u	333.0u	Yes
3	9	1.0u	333.0u	Yes
4	9	1.0u	333.0u	Yes
5	9	1.0u	333.0u	Yes
6	9	1.0u	333.0u	Yes
7	9	1.0u	333.0u	Yes
8	9	1.0u	333.0u	Yes
9	9	1.0u	333.0u	Yes
10	9	1.0u	333.0u	Yes
11	9	1.0u	333.0u	Yes
12	9	1.0u	333.0u	Yes
13	9	1.0u	333.0u	Yes
14	9	1.0u	333.0u	Yes
15	9	1.0u	333.0u	Yes
16	9	1.0u	333.0u	Yes
17	9	1.0u	333.0u	Yes
18	9	1.0u	333.0u	Yes
19	9	1.0u	333.0u	Yes
20	9	1.0u	333.0u	Yes
21	9	1.0u	333.0u	Yes
22	9	1.0u	333.0u	Yes
23	9	1.0u	333.0u	Yes
24	9	1.0u	333.0u	Yes
25	9	1.0u	333.0u	Yes
26	9	1.0u	333.0u	Yes
27	9	1.0u	333.0u	Yes
28	9	1.0u	333.0u	Yes
29	9	1.0u	333.0u	Yes
30	9	1.0u	333.0u	Yes
				Detection Rate: 100.0 %

Type 6 Radar Statistical Performances		
Trial #	Hopping Frequency Sequence Name	Detection
1	HOP_FREQ_SEQ_01	Yes
2	HOP_FREQ_SEQ_02	Yes
3	HOP_FREQ_SEQ_03	Yes
4	HOP_FREQ_SEQ_04	Yes
5	HOP_FREQ_SEQ_05	Yes
6	HOP_FREQ_SEQ_06	Yes
7	HOP_FREQ_SEQ_07	Yes
8	HOP_FREQ_SEQ_08	Yes
9	HOP_FREQ_SEQ_09	Yes
10	HOP_FREQ_SEQ_10	Yes
11	HOP_FREQ_SEQ_11	Yes
12	HOP_FREQ_SEQ_12	Yes
13	HOP_FREQ_SEQ_13	Yes
14	HOP_FREQ_SEQ_14	Yes
15	HOP_FREQ_SEQ_15	Yes
16	HOP_FREQ_SEQ_16	Yes
17	HOP_FREQ_SEQ_17	Yes
18	HOP_FREQ_SEQ_18	Yes
19	HOP_FREQ_SEQ_19	Yes
20	HOP_FREQ_SEQ_20	Yes
21	HOP_FREQ_SEQ_21	Yes
22	HOP_FREQ_SEQ_22	Yes
23	HOP_FREQ_SEQ_23	Yes
24	HOP_FREQ_SEQ_24	Yes
25	HOP_FREQ_SEQ_25	Yes
26	HOP_FREQ_SEQ_26	Yes
27	HOP_FREQ_SEQ_27	Yes
28	HOP_FREQ_SEQ_28	Yes
29	HOP_FREQ_SEQ_29	Yes
30	HOP_FREQ_SEQ_30	Yes
		Detection Rate: 100.0 %

Hopping Frequency Sequence Name: HOP_FREQ_SEQ_01							
SEQ#	Frequency (Hz)	SEQ#	Frequency (Hz)	SEQ#	Frequency (Hz)	SEQ#	Frequency (Hz)
1	5.630G	2	5.652G	3	5.519G	4	5.646G
5	5.361G	6	5.445G	7	5.540G	8	5.702G
9	5.660G	10	5.672G	11	5.408G	12	5.328G
13	5.501G	14	5.718G	15	5.455G	16	5.677G
17	5.469G	18	5.394G	19	5.532G	20	5.354G
21	5.589G	22	5.326G	23	5.575G	24	5.487G
25	5.357G	26	5.331G	27	5.708G	28	5.458G
29	5.624G	30	5.440G	31	5.459G	32	5.506G
33	5.625G	34	5.473G	35	5.676G	36	5.693G
37	5.687G	38	5.313G	39	5.318G	40	5.711G
41	5.335G	42	5.597G	43	5.692G	44	5.565G
45	5.322G	46	5.463G	47	5.266G	48	5.508G
49	5.713G	50	5.668G	51	5.464G	52	5.701G
53	5.554G	54	5.497G	55	5.273G	56	5.527G
57	5.271G	58	5.647G	59	5.559G	60	5.581G
61	5.615G	62	5.533G	63	5.305G	64	5.275G
65	5.716G	66	5.657G	67	5.319G	68	5.709G
69	5.411G	70	5.579G	71	5.376G	72	5.570G
73	5.332G	74	5.390G	75	5.698G	76	5.301G
77	5.254G	78	5.267G	79	5.432G	80	5.558G
81	5.425G	82	5.655G	83	5.262G	84	5.639G
85	5.457G	86	5.416G	87	5.686G	88	5.621G
89	5.654G	90	5.673G	91	5.528G	92	5.384G
93	5.715G	94	5.358G	95	5.482G	96	5.629G
97	5.400G	98	5.641G	99	5.398G	100	5.389G

Hopping Frequency Sequence Name: HOP_FREQ_SEQ_02							
SEQ#	Frequency (Hz)	SEQ#	Frequency (Hz)	SEQ#	Frequency (Hz)	SEQ#	Frequency (Hz)
1	5.334G	2	5.703G	3	5.718G	4	5.648G
5	5.666G	6	5.634G	7	5.591G	8	5.696G
9	5.400G	10	5.388G	11	5.542G	12	5.344G
13	5.384G	14	5.293G	15	5.278G	16	5.596G
17	5.581G	18	5.585G	19	5.408G	20	5.643G
21	5.626G	22	5.455G	23	5.625G	24	5.317G
25	5.287G	26	5.472G	27	5.276G	28	5.564G
29	5.516G	30	5.629G	31	5.435G	32	5.636G
33	5.430G	34	5.444G	35	5.465G	36	5.618G
37	5.699G	38	5.403G	39	5.691G	40	5.307G
41	5.497G	42	5.414G	43	5.253G	44	5.484G
45	5.371G	46	5.589G	47	5.458G	48	5.482G
49	5.326G	50	5.257G	51	5.551G	52	5.260G
53	5.595G	54	5.577G	55	5.282G	56	5.356G
57	5.258G	58	5.300G	59	5.262G	60	5.306G
61	5.419G	62	5.611G	63	5.720G	64	5.571G
65	5.592G	66	5.480G	67	5.562G	68	5.503G
69	5.486G	70	5.654G	71	5.604G	72	5.566G
73	5.668G	74	5.350G	75	5.723G	76	5.367G
77	5.522G	78	5.443G	79	5.346G	80	5.294G
81	5.710G	82	5.527G	83	5.708G	84	5.633G
85	5.357G	86	5.320G	87	5.719G	88	5.312G
89	5.466G	90	5.507G	91	5.453G	92	5.620G
93	5.268G	94	5.623G	95	5.683G	96	5.301G
97	5.417G	98	5.358G	99	5.682G	100	5.463G

Hopping Frequency Sequence Name: HOP_FREQ_SEQ_03							
SEQ#	Frequency (Hz)	SEQ#	Frequency (Hz)	SEQ#	Frequency (Hz)	SEQ#	Frequency (Hz)
1	5.611G	2	5.330G	3	5.676G	4	5.364G
5	5.283G	6	5.519G	7	5.680G	8	5.433G
9	5.314G	10	5.434G	11	5.697G	12	5.285G
13	5.645G	14	5.344G	15	5.462G	16	5.353G
17	5.253G	18	5.543G	19	5.358G	20	5.361G
21	5.341G	22	5.505G	23	5.545G	24	5.339G
25	5.282G	26	5.568G	27	5.363G	28	5.268G
29	5.557G	30	5.387G	31	5.491G	32	5.286G
33	5.516G	34	5.439G	35	5.492G	36	5.307G
37	5.679G	38	5.690G	39	5.678G	40	5.527G
41	5.401G	42	5.546G	43	5.267G	44	5.459G
45	5.724G	46	5.276G	47	5.467G	48	5.520G
49	5.638G	50	5.541G	51	5.585G	52	5.479G
53	5.325G	54	5.474G	55	5.400G	56	5.296G
57	5.445G	58	5.605G	59	5.351G	60	5.329G
61	5.576G	62	5.463G	63	5.684G	64	5.252G
65	5.320G	66	5.477G	67	5.277G	68	5.336G
69	5.689G	70	5.289G	71	5.264G	72	5.475G
73	5.589G	74	5.619G	75	5.319G	76	5.458G
77	5.349G	78	5.486G	79	5.494G	80	5.550G
81	5.269G	82	5.365G	83	5.377G	84	5.649G
85	5.304G	86	5.656G	87	5.318G	88	5.288G
89	5.525G	90	5.251G	91	5.591G	92	5.627G
93	5.681G	94	5.473G	95	5.384G	96	5.620G
97	5.561G	98	5.390G	99	5.405G	100	5.624G



Hopping Frequency Sequence Name: HOP_FREQ_SEQ_04							
SEQ#	Frequency (Hz)	SEQ#	Frequency (Hz)	SEQ#	Frequency (Hz)	SEQ#	Frequency (Hz)
1	5.325G	2	5.483G	3	5.458G	4	5.475G
5	5.460G	6	5.671G	7	5.610G	8	5.713G
9	5.400G	10	5.464G	11	5.413G	12	5.604G
13	5.387G	14	5.529G	15	5.342G	16	5.459G
17	5.653G	18	5.447G	19	5.509G	20	5.345G
21	5.709G	22	5.463G	23	5.578G	24	5.535G
25	5.719G	26	5.428G	27	5.255G	28	5.519G
29	5.507G	30	5.690G	31	5.660G	32	5.366G
33	5.402G	34	5.619G	35	5.556G	36	5.318G
37	5.461G	38	5.613G	39	5.606G	40	5.624G
41	5.687G	42	5.355G	43	5.683G	44	5.486G
45	5.305G	46	5.331G	47	5.311G	48	5.411G
49	5.291G	50	5.391G	51	5.415G	52	5.335G
53	5.570G	54	5.435G	55	5.384G	56	5.493G
57	5.424G	58	5.261G	59	5.380G	60	5.640G
61	5.303G	62	5.314G	63	5.599G	64	5.517G
65	5.678G	66	5.567G	67	5.672G	68	5.449G
69	5.338G	70	5.392G	71	5.603G	72	5.417G
73	5.440G	74	5.572G	75	5.473G	76	5.542G
77	5.339G	78	5.714G	79	5.478G	80	5.512G
81	5.477G	82	5.307G	83	5.383G	84	5.661G
85	5.476G	86	5.547G	87	5.474G	88	5.348G
89	5.696G	90	5.276G	91	5.574G	92	5.615G
93	5.337G	94	5.523G	95	5.581G	96	5.328G
97	5.496G	98	5.445G	99	5.389G	100	5.378G

Hopping Frequency Sequence Name: HOP_FREQ_SEQ_05							
SEQ#	Frequency (Hz)	SEQ#	Frequency (Hz)	SEQ#	Frequency (Hz)	SEQ#	Frequency (Hz)
1	5.519G	2	5.357G	3	5.550G	4	5.592G
5	5.551G	6	5.665G	7	5.704G	8	5.562G
9	5.323G	10	5.293G	11	5.253G	12	5.299G
13	5.511G	14	5.584G	15	5.560G	16	5.618G
17	5.636G	18	5.394G	19	5.368G	20	5.581G
21	5.275G	22	5.401G	23	5.585G	24	5.361G
25	5.648G	26	5.717G	27	5.419G	28	5.339G
29	5.709G	30	5.641G	31	5.534G	32	5.396G
33	5.679G	34	5.604G	35	5.499G	36	5.705G
37	5.583G	38	5.631G	39	5.619G	40	5.615G
41	5.497G	42	5.262G	43	5.552G	44	5.388G
45	5.685G	46	5.573G	47	5.351G	48	5.382G
49	5.304G	50	5.318G	51	5.626G	52	5.461G
53	5.559G	54	5.500G	55	5.554G	56	5.384G
57	5.288G	58	5.424G	59	5.372G	60	5.256G
61	5.464G	62	5.492G	63	5.466G	64	5.377G
65	5.590G	66	5.276G	67	5.333G	68	5.433G
69	5.292G	70	5.623G	71	5.579G	72	5.431G
73	5.449G	74	5.588G	75	5.516G	76	5.307G
77	5.617G	78	5.259G	79	5.601G	80	5.549G
81	5.556G	82	5.309G	83	5.316G	84	5.576G
85	5.510G	86	5.652G	87	5.313G	88	5.713G
89	5.330G	90	5.463G	91	5.436G	92	5.389G
93	5.312G	94	5.627G	95	5.722G	96	5.467G
97	5.263G	98	5.287G	99	5.393G	100	5.541G

Hopping Frequency Sequence Name: HOP_FREQ_SEQ_06							
SEQ#	Frequency (Hz)	SEQ#	Frequency (Hz)	SEQ#	Frequency (Hz)	SEQ#	Frequency (Hz)
1	5.561G	2	5.602G	3	5.447G	4	5.285G
5	5.411G	6	5.547G	7	5.431G	8	5.430G
9	5.501G	10	5.449G	11	5.717G	12	5.393G
13	5.348G	14	5.521G	15	5.605G	16	5.257G
17	5.255G	18	5.474G	19	5.520G	20	5.288G
21	5.676G	22	5.306G	23	5.265G	24	5.492G
25	5.379G	26	5.343G	27	5.440G	28	5.705G
29	5.567G	30	5.722G	31	5.375G	32	5.258G
33	5.615G	34	5.463G	35	5.260G	36	5.487G
37	5.270G	38	5.569G	39	5.680G	40	5.652G
41	5.346G	42	5.606G	43	5.536G	44	5.563G
45	5.711G	46	5.543G	47	5.338G	48	5.274G
49	5.363G	50	5.553G	51	5.502G	52	5.497G
53	5.309G	54	5.398G	55	5.544G	56	5.488G
57	5.296G	58	5.599G	59	5.261G	60	5.523G
61	5.269G	62	5.372G	63	5.514G	64	5.688G
65	5.417G	66	5.289G	67	5.601G	68	5.301G
69	5.472G	70	5.284G	71	5.443G	72	5.672G
73	5.539G	74	5.613G	75	5.342G	76	5.621G
77	5.685G	78	5.382G	79	5.339G	80	5.623G
81	5.358G	82	5.364G	83	5.349G	84	5.335G
85	5.597G	86	5.494G	87	5.578G	88	5.503G
89	5.496G	90	5.655G	91	5.525G	92	5.281G
93	5.400G	94	5.694G	95	5.640G	96	5.542G
97	5.327G	98	5.686G	99	5.396G	100	5.420G

Hopping Frequency Sequence Name: HOP_FREQ_SEQ_07							
SEQ#	Frequency (Hz)	SEQ#	Frequency (Hz)	SEQ#	Frequency (Hz)	SEQ#	Frequency (Hz)
1	5.463G	2	5.322G	3	5.601G	4	5.286G
5	5.298G	6	5.374G	7	5.364G	8	5.350G
9	5.676G	10	5.424G	11	5.314G	12	5.541G
13	5.469G	14	5.589G	15	5.494G	16	5.700G
17	5.372G	18	5.716G	19	5.419G	20	5.315G
21	5.409G	22	5.694G	23	5.349G	24	5.616G
25	5.408G	26	5.690G	27	5.572G	28	5.712G
29	5.342G	30	5.511G	31	5.631G	32	5.587G
33	5.539G	34	5.470G	35	5.447G	36	5.501G
37	5.296G	38	5.547G	39	5.318G	40	5.590G
41	5.337G	42	5.280G	43	5.525G	44	5.449G
45	5.250G	46	5.426G	47	5.495G	48	5.691G
49	5.478G	50	5.664G	51	5.458G	52	5.317G
53	5.540G	54	5.669G	55	5.645G	56	5.506G
57	5.272G	58	5.479G	59	5.467G	60	5.269G
61	5.659G	62	5.387G	63	5.340G	64	5.401G
65	5.373G	66	5.651G	67	5.487G	68	5.465G
69	5.309G	70	5.574G	71	5.376G	72	5.524G
73	5.416G	74	5.440G	75	5.507G	76	5.394G
77	5.483G	78	5.294G	79	5.480G	80	5.271G
81	5.332G	82	5.642G	83	5.592G	84	5.697G
85	5.617G	86	5.392G	87	5.704G	88	5.306G
89	5.512G	90	5.442G	91	5.560G	92	5.673G
93	5.402G	94	5.412G	95	5.407G	96	5.388G
97	5.405G	98	5.252G	99	5.462G	100	5.310G

Hopping Frequency Sequence Name: HOP_FREQ_SEQ_08							
SEQ#	Frequency (Hz)	SEQ#	Frequency (Hz)	SEQ#	Frequency (Hz)	SEQ#	Frequency (Hz)
1	5.722G	2	5.270G	3	5.595G	4	5.558G
5	5.449G	6	5.515G	7	5.365G	8	5.436G
9	5.614G	10	5.548G	11	5.376G	12	5.580G
13	5.578G	14	5.371G	15	5.377G	16	5.619G
17	5.574G	18	5.340G	19	5.485G	20	5.565G
21	5.646G	22	5.549G	23	5.664G	24	5.337G
25	5.461G	26	5.279G	27	5.338G	28	5.424G
29	5.707G	30	5.491G	31	5.577G	32	5.433G
33	5.516G	34	5.250G	35	5.721G	36	5.396G
37	5.539G	38	5.445G	39	5.505G	40	5.507G
41	5.336G	42	5.384G	43	5.412G	44	5.284G
45	5.354G	46	5.428G	47	5.430G	48	5.720G
49	5.632G	50	5.372G	51	5.459G	52	5.289G
53	5.400G	54	5.689G	55	5.560G	56	5.492G
57	5.652G	58	5.318G	59	5.417G	60	5.600G
61	5.659G	62	5.540G	63	5.585G	64	5.408G
65	5.615G	66	5.277G	67	5.346G	68	5.332G
69	5.582G	70	5.328G	71	5.432G	72	5.388G
73	5.322G	74	5.611G	75	5.678G	76	5.411G
77	5.381G	78	5.567G	79	5.660G	80	5.527G
81	5.261G	82	5.302G	83	5.717G	84	5.661G
85	5.311G	86	5.466G	87	5.512G	88	5.305G
89	5.282G	90	5.537G	91	5.264G	92	5.496G
93	5.339G	94	5.446G	95	5.629G	96	5.688G
97	5.308G	98	5.404G	99	5.625G	100	5.697G

Hopping Frequency Sequence Name: HOP_FREQ_SEQ_09							
SEQ#	Frequency (Hz)	SEQ#	Frequency (Hz)	SEQ#	Frequency (Hz)	SEQ#	Frequency (Hz)
1	5.673G	2	5.442G	3	5.352G	4	5.690G
5	5.327G	6	5.331G	7	5.292G	8	5.718G
9	5.302G	10	5.422G	11	5.469G	12	5.658G
13	5.392G	14	5.340G	15	5.462G	16	5.661G
17	5.476G	18	5.468G	19	5.656G	20	5.420G
21	5.418G	22	5.506G	23	5.363G	24	5.345G
25	5.705G	26	5.330G	27	5.534G	28	5.629G
29	5.581G	30	5.276G	31	5.321G	32	5.689G
33	5.369G	34	5.566G	35	5.495G	36	5.266G
37	5.257G	38	5.572G	39	5.597G	40	5.412G
41	5.542G	42	5.400G	43	5.719G	44	5.382G
45	5.683G	46	5.250G	47	5.606G	48	5.711G
49	5.278G	50	5.701G	51	5.716G	52	5.251G
53	5.452G	54	5.543G	55	5.648G	56	5.367G
57	5.322G	58	5.428G	59	5.273G	60	5.486G
61	5.361G	62	5.309G	63	5.504G	64	5.270G
65	5.602G	66	5.473G	67	5.550G	68	5.535G
69	5.337G	70	5.406G	71	5.589G	72	5.685G
73	5.373G	74	5.328G	75	5.427G	76	5.446G
77	5.282G	78	5.465G	79	5.450G	80	5.402G
81	5.307G	82	5.721G	83	5.262G	84	5.353G
85	5.481G	86	5.356G	87	5.457G	88	5.341G
89	5.632G	90	5.441G	91	5.667G	92	5.498G
93	5.488G	94	5.544G	95	5.443G	96	5.494G
97	5.335G	98	5.715G	99	5.381G	100	5.479G

Hopping Frequency Sequence Name: HOP_FREQ_SEQ_10							
SEQ#	Frequency (Hz)	SEQ#	Frequency (Hz)	SEQ#	Frequency (Hz)	SEQ#	Frequency (Hz)
1	5.721G	2	5.610G	3	5.523G	4	5.356G
5	5.435G	6	5.661G	7	5.480G	8	5.599G
9	5.537G	10	5.709G	11	5.634G	12	5.375G
13	5.586G	14	5.334G	15	5.400G	16	5.698G
17	5.482G	18	5.506G	19	5.310G	20	5.646G
21	5.518G	22	5.604G	23	5.539G	24	5.576G
25	5.391G	26	5.410G	27	5.701G	28	5.643G
29	5.642G	30	5.546G	31	5.431G	32	5.636G
33	5.392G	34	5.488G	35	5.467G	36	5.446G
37	5.703G	38	5.640G	39	5.442G	40	5.339G
41	5.653G	42	5.593G	43	5.674G	44	5.272G
45	5.412G	46	5.495G	47	5.572G	48	5.663G
49	5.483G	50	5.580G	51	5.670G	52	5.284G
53	5.522G	54	5.420G	55	5.378G	56	5.624G
57	5.402G	58	5.261G	59	5.286G	60	5.294G
61	5.366G	62	5.706G	63	5.681G	64	5.405G
65	5.447G	66	5.668G	67	5.386G	68	5.357G
69	5.363G	70	5.566G	71	5.620G	72	5.519G
73	5.665G	74	5.269G	75	5.361G	76	5.513G
77	5.341G	78	5.678G	79	5.617G	80	5.574G
81	5.419G	82	5.690G	83	5.507G	84	5.549G
85	5.713G	86	5.406G	87	5.525G	88	5.630G
89	5.288G	90	5.581G	91	5.307G	92	5.550G
93	5.414G	94	5.421G	95	5.291G	96	5.250G
97	5.512G	98	5.264G	99	5.408G	100	5.516G

Hopping Frequency Sequence Name: HOP_FREQ_SEQ_11							
SEQ#	Frequency (Hz)	SEQ#	Frequency (Hz)	SEQ#	Frequency (Hz)	SEQ#	Frequency (Hz)
1	5.675G	2	5.656G	3	5.250G	4	5.593G
5	5.484G	6	5.447G	7	5.277G	8	5.663G
9	5.451G	10	5.364G	11	5.273G	12	5.609G
13	5.459G	14	5.668G	15	5.550G	16	5.341G
17	5.529G	18	5.435G	19	5.497G	20	5.453G
21	5.260G	22	5.449G	23	5.359G	24	5.452G
25	5.511G	26	5.457G	27	5.430G	28	5.579G
29	5.581G	30	5.291G	31	5.407G	32	5.574G
33	5.315G	34	5.690G	35	5.318G	36	5.323G
37	5.361G	38	5.512G	39	5.358G	40	5.615G
41	5.696G	42	5.276G	43	5.537G	44	5.428G
45	5.705G	46	5.527G	47	5.644G	48	5.280G
49	5.417G	50	5.516G	51	5.319G	52	5.292G
53	5.706G	54	5.598G	55	5.553G	56	5.467G
57	5.563G	58	5.623G	59	5.559G	60	5.371G
61	5.429G	62	5.624G	63	5.470G	64	5.325G
65	5.699G	66	5.658G	67	5.367G	68	5.674G
69	5.575G	70	5.589G	71	5.321G	72	5.680G
73	5.546G	74	5.616G	75	5.356G	76	5.330G
77	5.310G	78	5.693G	79	5.583G	80	5.601G
81	5.667G	82	5.669G	83	5.405G	84	5.700G
85	5.571G	86	5.578G	87	5.720G	88	5.337G
89	5.450G	90	5.255G	91	5.573G	92	5.597G
93	5.261G	94	5.308G	95	5.286G	96	5.303G
97	5.436G	98	5.567G	99	5.455G	100	5.456G



Hopping Frequency Sequence Name: HOP_FREQ_SEQ_12							
SEQ#	Frequency (Hz)	SEQ#	Frequency (Hz)	SEQ#	Frequency (Hz)	SEQ#	Frequency (Hz)
1	5.447G	2	5.637G	3	5.377G	4	5.330G
5	5.717G	6	5.517G	7	5.285G	8	5.603G
9	5.679G	10	5.414G	11	5.345G	12	5.406G
13	5.633G	14	5.560G	15	5.342G	16	5.370G
17	5.496G	18	5.281G	19	5.324G	20	5.461G
21	5.624G	22	5.583G	23	5.519G	24	5.568G
25	5.534G	26	5.453G	27	5.606G	28	5.400G
29	5.674G	30	5.404G	31	5.487G	32	5.658G
33	5.578G	34	5.582G	35	5.385G	36	5.665G
37	5.537G	38	5.318G	39	5.427G	40	5.525G
41	5.267G	42	5.549G	43	5.584G	44	5.446G
45	5.579G	46	5.279G	47	5.677G	48	5.681G
49	5.357G	50	5.663G	51	5.598G	52	5.664G
53	5.452G	54	5.554G	55	5.398G	56	5.349G
57	5.355G	58	5.555G	59	5.540G	60	5.469G
61	5.336G	62	5.659G	63	5.484G	64	5.721G
65	5.259G	66	5.401G	67	5.366G	68	5.431G
69	5.543G	70	5.380G	71	5.419G	72	5.297G
73	5.451G	74	5.566G	75	5.298G	76	5.538G
77	5.369G	78	5.293G	79	5.535G	80	5.332G
81	5.387G	82	5.381G	83	5.252G	84	5.322G
85	5.294G	86	5.673G	87	5.468G	88	5.478G
89	5.264G	90	5.491G	91	5.423G	92	5.426G
93	5.391G	94	5.416G	95	5.661G	96	5.586G
97	5.526G	98	5.256G	99	5.384G	100	5.646G

Hopping Frequency Sequence Name: HOP_FREQ_SEQ_13							
SEQ#	Frequency (Hz)	SEQ#	Frequency (Hz)	SEQ#	Frequency (Hz)	SEQ#	Frequency (Hz)
1	5.653G	2	5.276G	3	5.344G	4	5.687G
5	5.292G	6	5.639G	7	5.679G	8	5.353G
9	5.431G	10	5.337G	11	5.324G	12	5.472G
13	5.339G	14	5.377G	15	5.299G	16	5.570G
17	5.426G	18	5.268G	19	5.445G	20	5.587G
21	5.710G	22	5.664G	23	5.555G	24	5.300G
25	5.681G	26	5.582G	27	5.511G	28	5.654G
29	5.432G	30	5.515G	31	5.506G	32	5.410G
33	5.645G	34	5.579G	35	5.698G	36	5.522G
37	5.371G	38	5.550G	39	5.294G	40	5.610G
41	5.476G	42	5.720G	43	5.517G	44	5.455G
45	5.393G	46	5.391G	47	5.706G	48	5.692G
49	5.289G	50	5.460G	51	5.375G	52	5.643G
53	5.386G	54	5.392G	55	5.447G	56	5.657G
57	5.459G	58	5.647G	59	5.605G	60	5.311G
61	5.642G	62	5.264G	63	5.494G	64	5.501G
65	5.279G	66	5.662G	67	5.497G	68	5.315G
69	5.512G	70	5.414G	71	5.257G	72	5.473G
73	5.507G	74	5.477G	75	5.693G	76	5.670G
77	5.523G	78	5.590G	79	5.607G	80	5.565G
81	5.458G	82	5.283G	83	5.611G	84	5.384G
85	5.446G	86	5.646G	87	5.381G	88	5.388G
89	5.396G	90	5.440G	91	5.413G	92	5.606G
93	5.422G	94	5.412G	95	5.598G	96	5.499G
97	5.601G	98	5.457G	99	5.541G	100	5.438G

Hopping Frequency Sequence Name: HOP_FREQ_SEQ_14							
SEQ#	Frequency (Hz)	SEQ#	Frequency (Hz)	SEQ#	Frequency (Hz)	SEQ#	Frequency (Hz)
1	5.289G	2	5.448G	3	5.306G	4	5.415G
5	5.642G	6	5.482G	7	5.652G	8	5.473G
9	5.523G	10	5.626G	11	5.256G	12	5.292G
13	5.587G	14	5.720G	15	5.722G	16	5.450G
17	5.307G	18	5.562G	19	5.429G	20	5.363G
21	5.371G	22	5.515G	23	5.467G	24	5.672G
25	5.263G	26	5.410G	27	5.403G	28	5.683G
29	5.520G	30	5.708G	31	5.585G	32	5.295G
33	5.283G	34	5.316G	35	5.309G	36	5.364G
37	5.328G	38	5.579G	39	5.315G	40	5.671G
41	5.629G	42	5.649G	43	5.409G	44	5.569G
45	5.511G	46	5.427G	47	5.477G	48	5.428G
49	5.430G	50	5.614G	51	5.329G	52	5.462G
53	5.350G	54	5.286G	55	5.314G	56	5.663G
57	5.632G	58	5.631G	59	5.571G	60	5.555G
61	5.699G	62	5.393G	63	5.648G	64	5.387G
65	5.484G	66	5.298G	67	5.716G	68	5.478G
69	5.445G	70	5.303G	71	5.594G	72	5.667G
73	5.689G	74	5.322G	75	5.421G	76	5.370G
77	5.618G	78	5.334G	79	5.423G	80	5.397G
81	5.604G	82	5.717G	83	5.567G	84	5.485G
85	5.279G	86	5.640G	87	5.673G	88	5.519G
89	5.557G	90	5.491G	91	5.572G	92	5.361G
93	5.617G	94	5.259G	95	5.538G	96	5.422G
97	5.718G	98	5.368G	99	5.318G	100	5.360G

Hopping Frequency Sequence Name: HOP_FREQ_SEQ_15							
SEQ#	Frequency (Hz)	SEQ#	Frequency (Hz)	SEQ#	Frequency (Hz)	SEQ#	Frequency (Hz)
1	5.513G	2	5.252G	3	5.511G	4	5.508G
5	5.512G	6	5.521G	7	5.630G	8	5.308G
9	5.663G	10	5.466G	11	5.608G	12	5.664G
13	5.515G	14	5.410G	15	5.415G	16	5.625G
17	5.337G	18	5.578G	19	5.359G	20	5.251G
21	5.591G	22	5.447G	23	5.427G	24	5.288G
25	5.338G	26	5.366G	27	5.538G	28	5.635G
29	5.720G	30	5.592G	31	5.677G	32	5.429G
33	5.424G	34	5.582G	35	5.268G	36	5.451G
37	5.502G	38	5.454G	39	5.340G	40	5.601G
41	5.575G	42	5.416G	43	5.304G	44	5.654G
45	5.441G	46	5.324G	47	5.265G	48	5.721G
49	5.607G	50	5.568G	51	5.463G	52	5.421G
53	5.388G	54	5.622G	55	5.264G	56	5.351G
57	5.702G	58	5.483G	59	5.315G	60	5.597G
61	5.372G	62	5.648G	63	5.629G	64	5.701G
65	5.542G	66	5.361G	67	5.649G	68	5.673G
69	5.452G	70	5.586G	71	5.500G	72	5.353G
73	5.682G	74	5.708G	75	5.425G	76	5.662G
77	5.718G	78	5.370G	79	5.302G	80	5.646G
81	5.355G	82	5.317G	83	5.318G	84	5.405G
85	5.346G	86	5.266G	87	5.339G	88	5.352G
89	5.350G	90	5.263G	91	5.637G	92	5.254G
93	5.440G	94	5.479G	95	5.507G	96	5.406G
97	5.690G	98	5.448G	99	5.532G	100	5.722G

Hopping Frequency Sequence Name: HOP_FREQ_SEQ_16							
SEQ#	Frequency (Hz)	SEQ#	Frequency (Hz)	SEQ#	Frequency (Hz)	SEQ#	Frequency (Hz)
1	5.498G	2	5.457G	3	5.713G	4	5.642G
5	5.319G	6	5.715G	7	5.648G	8	5.655G
9	5.698G	10	5.486G	11	5.577G	12	5.270G
13	5.363G	14	5.293G	15	5.328G	16	5.494G
17	5.564G	18	5.468G	19	5.285G	20	5.646G
21	5.666G	22	5.438G	23	5.712G	24	5.347G
25	5.587G	26	5.689G	27	5.403G	28	5.318G
29	5.348G	30	5.268G	31	5.284G	32	5.309G
33	5.399G	34	5.307G	35	5.703G	36	5.372G
37	5.430G	38	5.343G	39	5.611G	40	5.700G
41	5.253G	42	5.459G	43	5.452G	44	5.605G
45	5.385G	46	5.639G	47	5.331G	48	5.428G
49	5.602G	50	5.580G	51	5.381G	52	5.429G
53	5.294G	54	5.433G	55	5.636G	56	5.437G
57	5.592G	58	5.714G	59	5.538G	60	5.618G
61	5.654G	62	5.259G	63	5.674G	64	5.316G
65	5.670G	66	5.464G	67	5.576G	68	5.368G
69	5.546G	70	5.695G	71	5.256G	72	5.313G
73	5.453G	74	5.266G	75	5.631G	76	5.528G
77	5.455G	78	5.467G	79	5.699G	80	5.652G
81	5.543G	82	5.369G	83	5.395G	84	5.554G
85	5.325G	86	5.426G	87	5.367G	88	5.377G
89	5.446G	90	5.402G	91	5.427G	92	5.326G
93	5.495G	94	5.311G	95	5.379G	96	5.722G
97	5.491G	98	5.456G	99	5.353G	100	5.568G

Hopping Frequency Sequence Name: HOP_FREQ_SEQ_17							
SEQ#	Frequency (Hz)	SEQ#	Frequency (Hz)	SEQ#	Frequency (Hz)	SEQ#	Frequency (Hz)
1	5.455G	2	5.378G	3	5.571G	4	5.723G
5	5.493G	6	5.458G	7	5.559G	8	5.721G
9	5.400G	10	5.596G	11	5.403G	12	5.476G
13	5.384G	14	5.718G	15	5.684G	16	5.543G
17	5.393G	18	5.682G	19	5.604G	20	5.622G
21	5.626G	22	5.409G	23	5.346G	24	5.372G
25	5.512G	26	5.253G	27	5.715G	28	5.502G
29	5.454G	30	5.610G	31	5.617G	32	5.564G
33	5.250G	34	5.492G	35	5.705G	36	5.273G
37	5.254G	38	5.462G	39	5.485G	40	5.563G
41	5.706G	42	5.664G	43	5.469G	44	5.292G
45	5.352G	46	5.711G	47	5.651G	48	5.464G
49	5.667G	50	5.608G	51	5.401G	52	5.565G
53	5.419G	54	5.277G	55	5.436G	56	5.710G
57	5.286G	58	5.517G	59	5.696G	60	5.349G
61	5.527G	62	5.358G	63	5.680G	64	5.446G
65	5.251G	66	5.518G	67	5.256G	68	5.551G
69	5.297G	70	5.703G	71	5.338G	72	5.294G
73	5.704G	74	5.363G	75	5.709G	76	5.601G
77	5.558G	78	5.406G	79	5.319G	80	5.634G
81	5.598G	82	5.390G	83	5.451G	84	5.411G
85	5.556G	86	5.407G	87	5.461G	88	5.652G
89	5.410G	90	5.348G	91	5.416G	92	5.439G
93	5.616G	94	5.367G	95	5.438G	96	5.435G
97	5.457G	98	5.594G	99	5.371G	100	5.514G

Hopping Frequency Sequence Name: HOP_FREQ_SEQ_18							
SEQ#	Frequency (Hz)	SEQ#	Frequency (Hz)	SEQ#	Frequency (Hz)	SEQ#	Frequency (Hz)
1	5.507G	2	5.598G	3	5.375G	4	5.642G
5	5.488G	6	5.463G	7	5.503G	8	5.628G
9	5.395G	10	5.327G	11	5.499G	12	5.317G
13	5.454G	14	5.309G	15	5.510G	16	5.690G
17	5.693G	18	5.285G	19	5.655G	20	5.609G
21	5.329G	22	5.673G	23	5.724G	24	5.357G
25	5.705G	26	5.646G	27	5.415G	28	5.625G
29	5.668G	30	5.650G	31	5.441G	32	5.387G
33	5.339G	34	5.656G	35	5.711G	36	5.600G
37	5.332G	38	5.424G	39	5.557G	40	5.544G
41	5.345G	42	5.416G	43	5.281G	44	5.679G
45	5.378G	46	5.527G	47	5.495G	48	5.538G
49	5.344G	50	5.637G	51	5.721G	52	5.313G
53	5.289G	54	5.528G	55	5.670G	56	5.537G
57	5.305G	58	5.587G	59	5.654G	60	5.631G
61	5.423G	62	5.465G	63	5.566G	64	5.634G
65	5.472G	66	5.267G	67	5.483G	68	5.622G
69	5.591G	70	5.314G	71	5.439G	72	5.364G
73	5.288G	74	5.615G	75	5.310G	76	5.266G
77	5.349G	78	5.252G	79	5.720G	80	5.608G
81	5.533G	82	5.307G	83	5.253G	84	5.577G
85	5.419G	86	5.599G	87	5.661G	88	5.410G
89	5.263G	90	5.663G	91	5.548G	92	5.343G
93	5.256G	94	5.484G	95	5.297G	96	5.522G
97	5.710G	98	5.470G	99	5.261G	100	5.523G

Hopping Frequency Sequence Name: HOP_FREQ_SEQ_19							
SEQ#	Frequency (Hz)	SEQ#	Frequency (Hz)	SEQ#	Frequency (Hz)	SEQ#	Frequency (Hz)
1	5.527G	2	5.422G	3	5.588G	4	5.545G
5	5.717G	6	5.516G	7	5.595G	8	5.660G
9	5.651G	10	5.443G	11	5.603G	12	5.426G
13	5.472G	14	5.453G	15	5.636G	16	5.298G
17	5.626G	18	5.513G	19	5.356G	20	5.372G
21	5.529G	22	5.369G	23	5.365G	24	5.721G
25	5.286G	26	5.457G	27	5.720G	28	5.625G
29	5.618G	30	5.561G	31	5.574G	32	5.591G
33	5.615G	34	5.710G	35	5.592G	36	5.332G
37	5.550G	38	5.315G	39	5.538G	40	5.495G
41	5.266G	42	5.355G	43	5.650G	44	5.305G
45	5.318G	46	5.382G	47	5.297G	48	5.420G
49	5.670G	50	5.673G	51	5.287G	52	5.544G
53	5.484G	54	5.568G	55	5.392G	56	5.682G
57	5.499G	58	5.273G	59	5.346G	60	5.519G
61	5.290G	62	5.558G	63	5.689G	64	5.692G
65	5.445G	66	5.458G	67	5.500G	68	5.612G
69	5.265G	70	5.352G	71	5.463G	72	5.268G
73	5.362G	74	5.506G	75	5.486G	76	5.540G
77	5.637G	78	5.254G	79	5.683G	80	5.539G
81	5.510G	82	5.436G	83	5.565G	84	5.694G
85	5.303G	86	5.377G	87	5.691G	88	5.423G
89	5.526G	90	5.331G	91	5.504G	92	5.501G
93	5.523G	94	5.716G	95	5.470G	96	5.559G
97	5.375G	98	5.649G	99	5.508G	100	5.590G



Hopping Frequency Sequence Name: HOP_FREQ_SEQ_20							
SEQ#	Frequency (Hz)	SEQ#	Frequency (Hz)	SEQ#	Frequency (Hz)	SEQ#	Frequency (Hz)
1	5.266G	2	5.711G	3	5.343G	4	5.444G
5	5.636G	6	5.553G	7	5.411G	8	5.526G
9	5.708G	10	5.496G	11	5.425G	12	5.453G
13	5.288G	14	5.428G	15	5.528G	16	5.355G
17	5.389G	18	5.463G	19	5.659G	20	5.431G
21	5.583G	22	5.418G	23	5.681G	24	5.275G
25	5.348G	26	5.328G	27	5.547G	28	5.699G
29	5.568G	30	5.265G	31	5.529G	32	5.619G
33	5.406G	34	5.399G	35	5.628G	36	5.252G
37	5.555G	38	5.538G	39	5.264G	40	5.304G
41	5.549G	42	5.443G	43	5.483G	44	5.319G
45	5.270G	46	5.460G	47	5.527G	48	5.589G
49	5.524G	50	5.637G	51	5.457G	52	5.472G
53	5.635G	54	5.491G	55	5.412G	56	5.600G
57	5.623G	58	5.336G	59	5.436G	60	5.710G
61	5.682G	62	5.505G	63	5.294G	64	5.473G
65	5.329G	66	5.624G	67	5.393G	68	5.361G
69	5.478G	70	5.638G	71	5.689G	72	5.385G
73	5.712G	74	5.305G	75	5.449G	76	5.452G
77	5.419G	78	5.686G	79	5.314G	80	5.656G
81	5.666G	82	5.350G	83	5.299G	84	5.434G
85	5.684G	86	5.649G	87	5.308G	88	5.448G
89	5.558G	90	5.537G	91	5.685G	92	5.517G
93	5.438G	94	5.292G	95	5.476G	96	5.486G
97	5.471G	98	5.700G	99	5.474G	100	5.437G

Hopping Frequency Sequence Name: HOP_FREQ_SEQ_21							
SEQ#	Frequency (Hz)	SEQ#	Frequency (Hz)	SEQ#	Frequency (Hz)	SEQ#	Frequency (Hz)
1	5.289G	2	5.417G	3	5.434G	4	5.278G
5	5.447G	6	5.428G	7	5.711G	8	5.478G
9	5.666G	10	5.257G	11	5.362G	12	5.655G
13	5.708G	14	5.693G	15	5.250G	16	5.701G
17	5.593G	18	5.381G	19	5.348G	20	5.321G
21	5.644G	22	5.699G	23	5.445G	24	5.393G
25	5.674G	26	5.685G	27	5.277G	28	5.692G
29	5.252G	30	5.724G	31	5.416G	32	5.604G
33	5.493G	34	5.440G	35	5.451G	36	5.402G
37	5.650G	38	5.374G	39	5.438G	40	5.427G
41	5.535G	42	5.271G	43	5.444G	44	5.634G
45	5.439G	46	5.661G	47	5.599G	48	5.498G
49	5.468G	50	5.572G	51	5.623G	52	5.360G
53	5.410G	54	5.616G	55	5.527G	56	5.541G
57	5.455G	58	5.327G	59	5.310G	60	5.570G
61	5.275G	62	5.466G	63	5.550G	64	5.341G
65	5.304G	66	5.641G	67	5.463G	68	5.580G
69	5.454G	70	5.355G	71	5.594G	72	5.576G
73	5.335G	74	5.436G	75	5.315G	76	5.308G
77	5.397G	78	5.403G	79	5.465G	80	5.456G
81	5.286G	82	5.448G	83	5.721G	84	5.676G
85	5.573G	86	5.450G	87	5.470G	88	5.365G
89	5.723G	90	5.553G	91	5.469G	92	5.624G
93	5.675G	94	5.425G	95	5.376G	96	5.628G
97	5.446G	98	5.526G	99	5.717G	100	5.384G

Hopping Frequency Sequence Name: HOP_FREQ_SEQ_22							
SEQ#	Frequency (Hz)	SEQ#	Frequency (Hz)	SEQ#	Frequency (Hz)	SEQ#	Frequency (Hz)
1	5.459G	2	5.523G	3	5.451G	4	5.702G
5	5.507G	6	5.447G	7	5.605G	8	5.636G
9	5.301G	10	5.441G	11	5.414G	12	5.471G
13	5.272G	14	5.380G	15	5.324G	16	5.688G
17	5.654G	18	5.269G	19	5.573G	20	5.594G
21	5.354G	22	5.664G	23	5.600G	24	5.403G
25	5.575G	26	5.411G	27	5.608G	28	5.658G
29	5.534G	30	5.432G	31	5.524G	32	5.481G
33	5.595G	34	5.443G	35	5.420G	36	5.402G
37	5.696G	38	5.689G	39	5.593G	40	5.622G
41	5.676G	42	5.281G	43	5.719G	44	5.724G
45	5.367G	46	5.386G	47	5.631G	48	5.478G
49	5.518G	50	5.360G	51	5.434G	52	5.685G
53	5.327G	54	5.374G	55	5.343G	56	5.319G
57	5.364G	58	5.546G	59	5.705G	60	5.291G
61	5.467G	62	5.562G	63	5.513G	64	5.543G
65	5.661G	66	5.331G	67	5.709G	68	5.276G
69	5.707G	70	5.537G	71	5.585G	72	5.279G
73	5.358G	74	5.673G	75	5.361G	76	5.398G
77	5.455G	78	5.604G	79	5.582G	80	5.583G
81	5.706G	82	5.286G	83	5.586G	84	5.416G
85	5.297G	86	5.681G	87	5.278G	88	5.378G
89	5.649G	90	5.527G	91	5.722G	92	5.682G
93	5.445G	94	5.557G	95	5.667G	96	5.316G
97	5.473G	98	5.335G	99	5.284G	100	5.382G

Hopping Frequency Sequence Name: HOP_FREQ_SEQ_23							
SEQ#	Frequency (Hz)	SEQ#	Frequency (Hz)	SEQ#	Frequency (Hz)	SEQ#	Frequency (Hz)
1	5.708G	2	5.524G	3	5.365G	4	5.577G
5	5.342G	6	5.572G	7	5.646G	8	5.430G
9	5.663G	10	5.437G	11	5.689G	12	5.534G
13	5.356G	14	5.522G	15	5.505G	16	5.419G
17	5.603G	18	5.332G	19	5.424G	20	5.479G
21	5.261G	22	5.301G	23	5.371G	24	5.607G
25	5.456G	26	5.343G	27	5.350G	28	5.696G
29	5.562G	30	5.500G	31	5.604G	32	5.556G
33	5.587G	34	5.592G	35	5.697G	36	5.340G
37	5.461G	38	5.693G	39	5.580G	40	5.395G
41	5.367G	42	5.575G	43	5.681G	44	5.644G
45	5.598G	46	5.678G	47	5.492G	48	5.516G
49	5.491G	50	5.378G	51	5.471G	52	5.494G
53	5.286G	54	5.277G	55	5.418G	56	5.722G
57	5.251G	58	5.415G	59	5.435G	60	5.554G
61	5.619G	62	5.685G	63	5.408G	64	5.514G
65	5.704G	66	5.583G	67	5.568G	68	5.629G
69	5.336G	70	5.477G	71	5.465G	72	5.279G
73	5.381G	74	5.724G	75	5.428G	76	5.384G
77	5.616G	78	5.386G	79	5.404G	80	5.715G
81	5.711G	82	5.320G	83	5.466G	84	5.366G
85	5.348G	86	5.684G	87	5.656G	88	5.298G
89	5.635G	90	5.537G	91	5.718G	92	5.643G
93	5.660G	94	5.630G	95	5.620G	96	5.538G
97	5.506G	98	5.482G	99	5.518G	100	5.485G

Hopping Frequency Sequence Name: HOP_FREQ_SEQ_24							
SEQ#	Frequency (Hz)	SEQ#	Frequency (Hz)	SEQ#	Frequency (Hz)	SEQ#	Frequency (Hz)
1	5.472G	2	5.528G	3	5.281G	4	5.361G
5	5.520G	6	5.307G	7	5.403G	8	5.716G
9	5.283G	10	5.462G	11	5.548G	12	5.484G
13	5.326G	14	5.610G	15	5.575G	16	5.318G
17	5.599G	18	5.317G	19	5.681G	20	5.542G
21	5.710G	22	5.370G	23	5.527G	24	5.693G
25	5.645G	26	5.585G	27	5.678G	28	5.598G
29	5.649G	30	5.257G	31	5.563G	32	5.501G
33	5.669G	34	5.385G	35	5.522G	36	5.404G
37	5.354G	38	5.432G	39	5.406G	40	5.498G
41	5.471G	42	5.536G	43	5.689G	44	5.446G
45	5.495G	46	5.539G	47	5.424G	48	5.436G
49	5.442G	50	5.431G	51	5.464G	52	5.558G
53	5.300G	54	5.454G	55	5.407G	56	5.504G
57	5.417G	58	5.374G	59	5.319G	60	5.475G
61	5.483G	62	5.345G	63	5.401G	64	5.567G
65	5.487G	66	5.375G	67	5.451G	68	5.409G
69	5.296G	70	5.717G	71	5.637G	72	5.488G
73	5.340G	74	5.386G	75	5.627G	76	5.452G
77	5.660G	78	5.571G	79	5.547G	80	5.711G
81	5.595G	82	5.419G	83	5.719G	84	5.593G
85	5.272G	86	5.584G	87	5.656G	88	5.309G
89	5.305G	90	5.415G	91	5.384G	92	5.670G
93	5.364G	94	5.569G	95	5.632G	96	5.256G
97	5.666G	98	5.275G	99	5.310G	100	5.457G

Hopping Frequency Sequence Name: HOP_FREQ_SEQ_25							
SEQ#	Frequency (Hz)	SEQ#	Frequency (Hz)	SEQ#	Frequency (Hz)	SEQ#	Frequency (Hz)
1	5.517G	2	5.471G	3	5.276G	4	5.688G
5	5.609G	6	5.295G	7	5.657G	8	5.443G
9	5.401G	10	5.648G	11	5.416G	12	5.686G
13	5.376G	14	5.546G	15	5.646G	16	5.599G
17	5.265G	18	5.563G	19	5.522G	20	5.654G
21	5.314G	22	5.710G	23	5.568G	24	5.434G
25	5.346G	26	5.481G	27	5.402G	28	5.463G
29	5.287G	30	5.397G	31	5.583G	32	5.441G
33	5.553G	34	5.330G	35	5.289G	36	5.304G
37	5.394G	38	5.605G	39	5.516G	40	5.627G
41	5.611G	42	5.474G	43	5.576G	44	5.279G
45	5.504G	46	5.392G	47	5.420G	48	5.582G
49	5.479G	50	5.282G	51	5.503G	52	5.293G
53	5.663G	54	5.636G	55	5.272G	56	5.280G
57	5.332G	58	5.506G	59	5.379G	60	5.387G
61	5.422G	62	5.603G	63	5.380G	64	5.396G
65	5.451G	66	5.718G	67	5.525G	68	5.449G
69	5.455G	70	5.693G	71	5.412G	72	5.679G
73	5.381G	74	5.409G	75	5.363G	76	5.261G
77	5.669G	78	5.268G	79	5.635G	80	5.487G
81	5.716G	82	5.259G	83	5.647G	84	5.701G
85	5.634G	86	5.560G	87	5.413G	88	5.476G
89	5.285G	90	5.453G	91	5.336G	92	5.573G
93	5.566G	94	5.290G	95	5.508G	96	5.537G
97	5.464G	98	5.607G	99	5.621G	100	5.700G

Hopping Frequency Sequence Name: HOP_FREQ_SEQ_26							
SEQ#	Frequency (Hz)	SEQ#	Frequency (Hz)	SEQ#	Frequency (Hz)	SEQ#	Frequency (Hz)
1	5.459G	2	5.634G	3	5.275G	4	5.622G
5	5.566G	6	5.670G	7	5.346G	8	5.352G
9	5.373G	10	5.660G	11	5.407G	12	5.704G
13	5.458G	14	5.570G	15	5.290G	16	5.601G
17	5.316G	18	5.568G	19	5.504G	20	5.350G
21	5.557G	22	5.574G	23	5.368G	24	5.525G
25	5.424G	26	5.657G	27	5.337G	28	5.478G
29	5.627G	30	5.310G	31	5.254G	32	5.579G
33	5.263G	34	5.274G	35	5.716G	36	5.623G
37	5.583G	38	5.532G	39	5.329G	40	5.307G
41	5.580G	42	5.433G	43	5.419G	44	5.450G
45	5.449G	46	5.571G	47	5.651G	48	5.652G
49	5.500G	50	5.595G	51	5.323G	52	5.370G
53	5.386G	54	5.518G	55	5.680G	56	5.440G
57	5.470G	58	5.559G	59	5.271G	60	5.600G
61	5.361G	62	5.273G	63	5.416G	64	5.722G
65	5.324G	66	5.480G	67	5.654G	68	5.314G
69	5.413G	70	5.393G	71	5.303G	72	5.396G
73	5.387G	74	5.384G	75	5.681G	76	5.540G
77	5.519G	78	5.718G	79	5.688G	80	5.604G
81	5.400G	82	5.388G	83	5.399G	84	5.472G
85	5.551G	86	5.355G	87	5.685G	88	5.695G
89	5.457G	90	5.327G	91	5.292G	92	5.486G
93	5.322G	94	5.255G	95	5.341G	96	5.508G
97	5.372G	98	5.720G	99	5.708G	100	5.318G

Hopping Frequency Sequence Name: HOP_FREQ_SEQ_27							
SEQ#	Frequency (Hz)	SEQ#	Frequency (Hz)	SEQ#	Frequency (Hz)	SEQ#	Frequency (Hz)
1	5.712G	2	5.268G	3	5.581G	4	5.636G
5	5.372G	6	5.701G	7	5.593G	8	5.703G
9	5.507G	10	5.628G	11	5.673G	12	5.282G
13	5.551G	14	5.609G	15	5.429G	16	5.579G
17	5.395G	18	5.586G	19	5.492G	20	5.328G
21	5.620G	22	5.562G	23	5.384G	24	5.354G
25	5.426G	26	5.537G	27	5.615G	28	5.448G
29	5.546G	30	5.461G	31	5.687G	32	5.456G
33	5.264G	34	5.359G	35	5.329G	36	5.675G
37	5.560G	38	5.471G	39	5.670G	40	5.338G
41	5.683G	42	5.265G	43	5.276G	44	5.296G
45	5.312G	46	5.343G	47	5.502G	48	5.350G
49	5.526G	50	5.331G	51	5.715G	52	5.259G
53	5.645G	54	5.612G	55	5.630G	56	5.299G
57	5.517G	58	5.266G	59	5.404G	60	5.660G
61	5.332G	62	5.402G	63	5.464G	64	5.400G
65	5.419G	66	5.380G	67	5.333G	68	5.698G
69	5.293G	70	5.691G	71	5.553G	72	5.273G
73	5.362G	74	5.424G	75	5.624G	76	5.390G
77	5.515G	78	5.714G	79	5.361G	80	5.705G
81	5.440G	82	5.717G	83	5.616G	84	5.684G
85	5.597G	86	5.631G	87	5.420G	88	5.475G
89	5.435G	90	5.289G	91	5.674G	92	5.257G
93	5.381G	94	5.516G	95	5.483G	96	5.421G
97	5.518G	98	5.602G	99	5.413G	100	5.721G



Hopping Frequency Sequence Name: HOP_FREQ_SEQ_28							
SEQ#	Frequency (Hz)	SEQ#	Frequency (Hz)	SEQ#	Frequency (Hz)	SEQ#	Frequency (Hz)
1	5.505G	2	5.506G	3	5.461G	4	5.639G
5	5.416G	6	5.346G	7	5.691G	8	5.510G
9	5.503G	10	5.383G	11	5.267G	12	5.390G
13	5.641G	14	5.548G	15	5.616G	16	5.335G
17	5.450G	18	5.517G	19	5.667G	20	5.317G
21	5.439G	22	5.567G	23	5.717G	24	5.635G
25	5.418G	26	5.256G	27	5.308G	28	5.511G
29	5.313G	30	5.378G	31	5.705G	32	5.622G
33	5.300G	34	5.539G	35	5.591G	36	5.614G
37	5.576G	38	5.255G	39	5.640G	40	5.606G
41	5.423G	42	5.279G	43	5.481G	44	5.302G
45	5.686G	46	5.422G	47	5.465G	48	5.496G
49	5.703G	50	5.326G	51	5.569G	52	5.405G
53	5.458G	54	5.350G	55	5.626G	56	5.663G
57	5.349G	58	5.580G	59	5.474G	60	5.483G
61	5.453G	62	5.448G	63	5.436G	64	5.720G
65	5.438G	66	5.714G	67	5.582G	68	5.281G
69	5.442G	70	5.638G	71	5.683G	72	5.345G
73	5.264G	74	5.573G	75	5.410G	76	5.332G
77	5.649G	78	5.527G	79	5.324G	80	5.700G
81	5.599G	82	5.630G	83	5.559G	84	5.648G
85	5.702G	86	5.430G	87	5.284G	88	5.404G
89	5.546G	90	5.659G	91	5.723G	92	5.604G
93	5.684G	94	5.338G	95	5.540G	96	5.411G
97	5.696G	98	5.534G	99	5.669G	100	5.671G

Hopping Frequency Sequence Name: HOP_FREQ_SEQ_29							
SEQ#	Frequency (Hz)	SEQ#	Frequency (Hz)	SEQ#	Frequency (Hz)	SEQ#	Frequency (Hz)
1	5.701G	2	5.267G	3	5.540G	4	5.656G
5	5.454G	6	5.361G	7	5.271G	8	5.584G
9	5.507G	10	5.570G	11	5.592G	12	5.591G
13	5.514G	14	5.493G	15	5.532G	16	5.449G
17	5.448G	18	5.304G	19	5.491G	20	5.658G
21	5.441G	22	5.486G	23	5.705G	24	5.718G
25	5.621G	26	5.500G	27	5.422G	28	5.517G
29	5.333G	30	5.506G	31	5.451G	32	5.260G
33	5.281G	34	5.250G	35	5.641G	36	5.307G
37	5.585G	38	5.363G	39	5.699G	40	5.566G
41	5.370G	42	5.586G	43	5.657G	44	5.468G
45	5.353G	46	5.544G	47	5.573G	48	5.452G
49	5.706G	50	5.464G	51	5.365G	52	5.368G
53	5.326G	54	5.289G	55	5.455G	56	5.286G
57	5.308G	58	5.342G	59	5.258G	60	5.668G
61	5.382G	62	5.323G	63	5.693G	64	5.402G
65	5.272G	66	5.707G	67	5.715G	68	5.386G
69	5.415G	70	5.596G	71	5.276G	72	5.580G
73	5.466G	74	5.527G	75	5.503G	76	5.646G
77	5.619G	78	5.350G	79	5.409G	80	5.251G
81	5.485G	82	5.406G	83	5.601G	84	5.330G
85	5.572G	86	5.340G	87	5.435G	88	5.294G
89	5.635G	90	5.322G	91	5.300G	92	5.314G
93	5.651G	94	5.427G	95	5.661G	96	5.548G
97	5.535G	98	5.375G	99	5.721G	100	5.554G

Hopping Frequency Sequence Name: HOP_FREQ_SEQ_30							
SEQ#	Frequency (Hz)	SEQ#	Frequency (Hz)	SEQ#	Frequency (Hz)	SEQ#	Frequency (Hz)
1	5.546G	2	5.418G	3	5.301G	4	5.256G
5	5.722G	6	5.378G	7	5.288G	8	5.714G
9	5.707G	10	5.510G	11	5.692G	12	5.475G
13	5.355G	14	5.305G	15	5.587G	16	5.641G
17	5.404G	18	5.584G	19	5.585G	20	5.713G
21	5.694G	22	5.275G	23	5.654G	24	5.401G
25	5.337G	26	5.426G	27	5.356G	28	5.370G
29	5.644G	30	5.597G	31	5.431G	32	5.708G
33	5.485G	34	5.460G	35	5.705G	36	5.272G
37	5.369G	38	5.655G	39	5.553G	40	5.711G
41	5.511G	42	5.570G	43	5.704G	44	5.352G
45	5.599G	46	5.389G	47	5.590G	48	5.341G
49	5.252G	50	5.410G	51	5.665G	52	5.255G
53	5.659G	54	5.695G	55	5.266G	56	5.628G
57	5.264G	58	5.279G	59	5.311G	60	5.283G
61	5.280G	62	5.408G	63	5.343G	64	5.651G
65	5.514G	66	5.363G	67	5.617G	68	5.688G
69	5.554G	70	5.693G	71	5.715G	72	5.645G
73	5.310G	74	5.494G	75	5.286G	76	5.564G
77	5.336G	78	5.632G	79	5.362G	80	5.524G
81	5.507G	82	5.682G	83	5.574G	84	5.260G
85	5.600G	86	5.515G	87	5.394G	88	5.354G
89	5.470G	90	5.661G	91	5.295G	92	5.254G
93	5.353G	94	5.463G	95	5.499G	96	5.679G
97	5.657G	98	5.481G	99	5.686G	100	5.505G

**IEEE 802.11ac 80MHz**

Type 1 Radar Statistical Performances				
Trial #	Pulses per Burst	Pulse Width (s)	PRI (s)	Detection
1	18	1.0u	1.428m	No
2	18	1.0u	1.428m	Yes
3	18	1.0u	1.428m	Yes
4	18	1.0u	1.428m	Yes
5	18	1.0u	1.428m	Yes
6	18	1.0u	1.428m	Yes
7	18	1.0u	1.428m	Yes
8	18	1.0u	1.428m	Yes
9	18	1.0u	1.428m	Yes
10	18	1.0u	1.428m	Yes
11	18	1.0u	1.428m	Yes
12	18	1.0u	1.428m	Yes
13	18	1.0u	1.428m	Yes
14	18	1.0u	1.428m	Yes
15	18	1.0u	1.428m	Yes
16	18	1.0u	1.428m	Yes
17	18	1.0u	1.428m	Yes
18	18	1.0u	1.428m	Yes
19	18	1.0u	1.428m	Yes
20	18	1.0u	1.428m	Yes
21	18	1.0u	1.428m	Yes
22	18	1.0u	1.428m	Yes
23	18	1.0u	1.428m	Yes
24	18	1.0u	1.428m	Yes
25	18	1.0u	1.428m	Yes
26	18	1.0u	1.428m	Yes
27	18	1.0u	1.428m	Yes
28	18	1.0u	1.428m	Yes
29	18	1.0u	1.428m	Yes
30	18	1.0u	1.428m	Yes
Detection Rate: 96.7 %				

Type 2 Radar Statistical Performances				
Trial #	Pulses per Burst	Pulse Width (s)	PRI (s)	Detection
1	23	2.3u	222.0u	Yes
2	28	1.8u	204.0u	Yes
3	26	1.6u	225.0u	Yes
4	27	3.8u	168.0u	No
5	27	1.1u	227.0u	Yes
6	27	2.6u	166.0u	Yes
7	24	4.7u	161.0u	Yes
8	28	1.9u	180.0u	Yes
9	29	1.3u	176.0u	Yes
10	23	1.8u	170.0u	Yes
11	29	1.4u	195.0u	Yes
12	25	3.4u	228.0u	No
13	26	2.3u	206.0u	Yes
14	27	4.5u	189.0u	Yes
15	25	3.9u	194.0u	Yes
16	25	3.0u	154.0u	Yes
17	23	3.6u	182.0u	No
18	26	3.4u	160.0u	Yes
19	25	3.3u	229.0u	Yes
20	23	1.9u	151.0u	Yes
21	25	1.8u	184.0u	Yes
22	28	2.3u	229.0u	Yes
23	29	1.1u	210.0u	Yes
24	26	2.2u	203.0u	No
25	25	2.9u	222.0u	Yes
26	28	1.4u	220.0u	Yes
27	26	1.8u	155.0u	Yes
28	29	3.4u	155.0u	Yes
29	28	3.1u	204.0u	Yes
30	26	4.4u	176.0u	Yes
				Detection Rate: 86.7 %

Type 3 Radar Statistical Performances				
Trial #	Pulses per Burst	Pulse Width (s)	PRI (s)	Detection
1	18	7.8u	292.0u	Yes
2	18	7.0u	366.0u	Yes
3	18	9.2u	486.0u	Yes
4	17	6.8u	216.0u	Yes
5	18	7.3u	446.0u	Yes
6	16	6.6u	208.0u	Yes
7	17	6.8u	347.0u	No
8	17	9.6u	232.0u	Yes
9	17	6.2u	364.0u	Yes
10	16	7.1u	407.0u	No
11	18	6.6u	458.0u	Yes
12	17	9.1u	226.0u	Yes
13	16	6.9u	297.0u	Yes
14	18	9.8u	463.0u	Yes
15	17	6.1u	329.0u	Yes
16	17	10.0u	333.0u	Yes
17	18	8.5u	399.0u	No
18	17	8.7u	316.0u	Yes
19	16	9.9u	402.0u	Yes
20	17	6.9u	446.0u	No
21	16	6.6u	451.0u	Yes
22	16	8.2u	272.0u	Yes
23	17	8.5u	395.0u	Yes
24	17	8.4u	379.0u	Yes
25	16	7.4u	292.0u	Yes
26	16	9.8u	489.0u	Yes
27	17	7.7u	375.0u	Yes
28	16	7.7u	297.0u	Yes
29	18	9.2u	347.0u	Yes
30	16	6.9u	415.0u	Yes
				Detection Rate: 86.7 %

Type 4 Radar Statistical Performances				
Trial #	Pulses per Burst	Pulse Width (s)	PRI (s)	Detection
1	14	18.2u	402.0u	Yes
2	13	14.5u	226.0u	Yes
3	15	13.7u	340.0u	Yes
4	16	12.2u	469.0u	Yes
5	12	14.6u	220.0u	No
6	15	17.0u	370.0u	Yes
7	15	11.4u	458.0u	No
8	13	11.6u	487.0u	Yes
9	16	16.2u	202.0u	Yes
10	15	19.8u	363.0u	Yes
11	14	11.8u	424.0u	Yes
12	14	18.0u	407.0u	Yes
13	16	17.8u	256.0u	Yes
14	16	13.1u	420.0u	Yes
15	13	18.6u	243.0u	No
16	14	13.4u	284.0u	Yes
17	12	17.7u	410.0u	Yes
18	15	19.3u	234.0u	Yes
19	14	11.9u	411.0u	Yes
20	16	13.4u	420.0u	Yes
21	14	19.2u	235.0u	Yes
22	14	15.2u	406.0u	Yes
23	15	18.7u	408.0u	Yes
24	13	16.1u	366.0u	Yes
25	13	11.3u	369.0u	Yes
26	14	17.1u	284.0u	No
27	13	13.5u	495.0u	Yes
28	15	16.8u	424.0u	Yes
29	14	16.3u	322.0u	Yes
30	13	13.0u	314.0u	Yes
				Detection Rate: 86.7 %

Type 5 Radar Statistical Performances		
Trial #	Test Signal Name	Detection
1	LP_Signal_01	Yes
2	LP_Signal_02	Yes
3	LP_Signal_03	Yes
4	LP_Signal_04	Yes
5	LP_Signal_05	Yes
6	LP_Signal_06	Yes
7	LP_Signal_07	Yes
8	LP_Signal_08	Yes
9	LP_Signal_09	Yes
10	LP_Signal_10	Yes
11	LP_Signal_11	Yes
12	LP_Signal_12	Yes
13	LP_Signal_13	Yes
14	LP_Signal_14	Yes
15	LP_Signal_15	Yes
16	LP_Signal_16	Yes
17	LP_Signal_17	Yes
18	LP_Signal_18	Yes
19	LP_Signal_19	Yes
20	LP_Signal_20	No
21	LP_Signal_21	Yes
22	LP_Signal_22	Yes
23	LP_Signal_23	Yes
24	LP_Signal_24	No
25	LP_Signal_25	Yes
26	LP_Signal_26	No
27	LP_Signal_27	Yes
28	LP_Signal_28	Yes
29	LP_Signal_29	Yes
30	LP_Signal_30	Yes
		Detection Rate: 90.0 %



Long Pulse Radar Test Signal						
Test Signal Name: LP_Signal_01						
Number of Bursts in Trial: 17						
Burst	Pulses per Burst	Chrip (Hz)	Pulse Width (s)	Pulse 1 to 2 Spacing (s)	Pulse 2 to 3 Spacing (s)	Start Location (s)
1	3	12M	79.5u	1.705m	1.445m	362.4m
2	2	18M	69.9u	1.602m	-	523.1m
3	3	18M	70.8u	1.255m	1.794m	353.4m
4	1	11M	86.2u	-	-	401.1m
5	2	19M	92.9u	1.810m	-	119.5m
6	2	12M	55.4u	1.331m	-	323.8m
7	2	9M	96.6u	1.406m	-	284.8m
8	2	12M	74.4u	1.213m	-	30.24m
9	3	17M	74.1u	1.752m	1.858m	98.58m
10	3	20M	96.3u	967.7u	1.566m	391.9m
11	2	7M	66.2u	1.650m	-	503.8m
12	3	8M	65.2u	1.218m	1.706m	286.2m
13	2	9M	81.5u	1.875m	-	288.0m
14	3	12M	63.9u	1.622m	1.383m	103.7m
15	1	17M	82.9u	-	-	530.4m
16	2	9M	72.5u	1.271m	-	172.0m
17	2	19M	99.3u	1.461m	-	132.0m

Long Pulse Radar Test Signal						
Test Signal Name: LP_Signal_02						
Number of Bursts in Trial: 15						
Burst	Pulses per Burst	Chrip (Hz)	Pulse Width (s)	Pulse 1 to 2 Spacing (s)	Pulse 2 to 3 Spacing (s)	Start Location (s)
1	2	12M	63.4u	1.747m	-	402.8m
2	1	11M	92.8u	-	-	680.9m
3	1	8M	51.2u	-	-	480.0m
4	1	6M	69.0u	-	-	394.9m
5	3	20M	85.0u	1.161m	1.795m	365.1m
6	2	18M	73.3u	1.770m	-	84.27m
7	2	9M	72.0u	1.545m	-	419.2m
8	2	12M	90.3u	1.566m	-	287.3m
9	2	6M	83.2u	936.8u	-	460.7m
10	2	15M	56.2u	985.8u	-	356.1m
11	3	18M	56.5u	1.253m	1.256m	746.0m
12	2	19M	68.9u	1.080m	-	197.1m
13	3	18M	83.7u	1.845m	1.883m	393.6m
14	1	14M	66.5u	-	-	434.6m
15	2	8M	80.2u	1.411m	-	391.3m

Long Pulse Radar Test Signal						
Test Signal Name: LP_Signal_03						
Number of Bursts in Trial: 10						
Burst	Pulses per Burst	Chrip (Hz)	Pulse Width (s)	Pulse 1 to 2 Spacing (s)	Pulse 2 to 3 Spacing (s)	Start Location (s)
1	2	8M	84.5u	1.580m	-	330.9m
2	2	15M	58.8u	1.662m	-	984.0m
3	2	7M	85.5u	1.704m	-	786.0m
4	2	11M	95.9u	1.349m	-	65.99m
5	2	19M	85.6u	1.021m	-	1.100
6	1	20M	74.6u	-	-	1.147
7	1	11M	70.5u	-	-	20.10m
8	1	18M	66.9u	-	-	743.3m
9	3	18M	56.1u	1.441m	1.561m	1.071
10	3	14M	69.5u	1.857m	1.765m	542.6m

Long Pulse Radar Test Signal						
Test Signal Name: LP_Signal_04						
Number of Bursts in Trial: 9						
Burst	Pulses per Burst	Chrip (Hz)	Pulse Width (s)	Pulse 1 to 2 Spacing (s)	Pulse 2 to 3 Spacing (s)	Start Location (s)
1	1	12M	56.2u	-	-	597.6m
2	1	15M	50.2u	-	-	58.69m
3	3	18M	83.6u	1.492m	968.4u	378.8m
4	1	13M	67.3u	-	-	316.8m
5	3	10M	63.5u	956.5u	1.896m	151.0m
6	3	16M	51.0u	1.150m	1.515m	177.6m
7	2	11M	73.4u	1.224m	-	363.2m
8	2	13M	84.6u	1.441m	-	559.2m
9	1	12M	98.2u	-	-	975.3m

Long Pulse Radar Test Signal						
Test Signal Name: LP_Signal_05						
Number of Bursts in Trial: 10						
Burst	Pulses per Burst	Chrip (Hz)	Pulse Width (s)	Pulse 1 to 2 Spacing (s)	Pulse 2 to 3 Spacing (s)	Start Location (s)
1	1	12M	91.6u	-	-	83.79m
2	2	13M	98.2u	1.696m	-	728.7m
3	2	15M	94.8u	1.142m	-	721.9m
4	3	16M	97.5u	1.417m	917.5u	1.089
5	2	18M	72.6u	1.577m	-	371.1m
6	2	14M	69.3u	1.314m	-	1.131
7	2	17M	65.5u	1.524m	-	862.1m
8	1	11M	98.5u	-	-	960.9m
9	2	17M	77.2u	1.726m	-	1.178
10	3	16M	83.8u	1.007m	1.499m	969.2m

Long Pulse Radar Test Signal						
Test Signal Name: LP_Signal_06						
Number of Bursts in Trial: 18						
Burst	Pulses per Burst	Chrip (Hz)	Pulse Width (s)	Pulse 1 to 2 Spacing (s)	Pulse 2 to 3 Spacing (s)	Start Location (s)
1	2	7M	63.1u	1.205m	-	543.3m
2	3	9M	89.1u	917.9u	1.824m	233.1m
3	2	14M	79.7u	1.399m	-	518.9m
4	2	7M	78.7u	1.743m	-	263.2m
5	3	19M	81.0u	1.692m	1.356m	631.0m
6	1	10M	73.7u	-	-	164.8m
7	1	13M	66.0u	-	-	203.2m
8	1	5M	66.3u	-	-	585.1m
9	3	12M	65.2u	1.604m	1.707m	37.25m
10	3	19M	85.0u	1.507m	1.715m	268.8m
11	2	19M	78.1u	1.635m	-	662.6m
12	3	6M	54.6u	1.244m	971.4u	570.4m
13	3	16M	89.5u	1.901m	1.486m	363.1m
14	3	10M	54.8u	1.659m	1.558m	340.2m
15	2	12M	69.5u	973.5u	-	361.4m
16	2	12M	96.6u	1.005m	-	613.1m
17	3	9M	64.5u	1.828m	1.587m	499.4m
18	1	10M	86.0u	-	-	392.9m

Long Pulse Radar Test Signal						
Test Signal Name: LP_Signal_07						
Number of Bursts in Trial: 15						
Burst	Pulses per Burst	Chrip (Hz)	Pulse Width (s)	Pulse 1 to 2 Spacing (s)	Pulse 2 to 3 Spacing (s)	Start Location (s)
1	1	19M	68.5u	-	-	234.5m
2	2	14M	83.5u	1.251m	-	33.14m
3	2	14M	54.8u	1.868m	-	759.3m
4	1	15M	53.0u	-	-	482.6m
5	2	12M	88.5u	1.793m	-	85.48m
6	3	12M	81.8u	1.099m	1.165m	107.1m
7	2	11M	85.8u	1.525m	-	420.7m
8	2	6M	80.3u	1.824m	-	569.6m
9	3	20M	68.0u	1.664m	979.0u	606.3m
10	1	12M	84.7u	-	-	600.4m
11	3	5M	78.9u	1.666m	1.092m	700.4m
12	1	18M	50.8u	-	-	277.9m
13	2	15M	99.0u	1.672m	-	402.5m
14	3	11M	75.4u	1.338m	1.162m	371.6m
15	2	9M	52.3u	1.939m	-	217.1m

Long Pulse Radar Test Signal						
Test Signal Name: LP_Signal_08						
Number of Bursts in Trial: 10						
Burst	Pulses per Burst	Chrip (Hz)	Pulse Width (s)	Pulse 1 to 2 Spacing (s)	Pulse 2 to 3 Spacing (s)	Start Location (s)
1	3	18M	51.7u	1.675m	1.840m	844.6m
2	2	16M	52.5u	1.309m	-	371.1m
3	3	17M	53.9u	1.386m	1.436m	351.4m
4	1	8M	64.4u	-	-	205.2m
5	3	15M	89.5u	1.332m	1.846m	532.3m
6	2	12M	87.6u	1.343m	-	598.3m
7	1	16M	72.6u	-	-	856.0m
8	2	14M	99.2u	1.799m	-	1.053
9	1	13M	95.1u	-	-	1.086
10	1	13M	88.4u	-	-	621.7m

Long Pulse Radar Test Signal						
Test Signal Name: LP_Signal_09						
Number of Bursts in Trial: 9						
Burst	Pulses per Burst	Chrip (Hz)	Pulse Width (s)	Pulse 1 to 2 Spacing (s)	Pulse 2 to 3 Spacing (s)	Start Location (s)
1	3	8M	70.3u	1.737m	1.252m	335.6m
2	1	11M	84.7u	-	-	440.9m
3	2	12M	84.2u	1.530m	-	1.207
4	1	8M	93.4u	-	-	363.1m
5	2	9M	97.9u	1.187m	-	529.2m
6	2	14M	53.2u	1.425m	-	1.218
7	2	7M	88.5u	1.373m	-	328.2m
8	2	19M	83.6u	1.112m	-	810.2m
9	1	13M	67.7u	-	-	1.173

Long Pulse Radar Test Signal						
Test Signal Name: LP_Signal_10						
Number of Bursts in Trial: 19						
Burst	Pulses per Burst	Chrip (Hz)	Pulse Width (s)	Pulse 1 to 2 Spacing (s)	Pulse 2 to 3 Spacing (s)	Start Location (s)
1	2	8M	63.8u	1.661m	-	86.75m
2	1	9M	69.9u	-	-	34.87m
3	2	20M	73.5u	1.108m	-	289.6m
4	3	15M	50.1u	1.415m	1.854m	304.0m
5	2	6M	76.5u	1.236m	-	570.2m
6	3	10M	55.2u	1.346m	1.212m	40.77m
7	1	17M	74.8u	-	-	50.11m
8	2	18M	82.2u	1.200m	-	430.8m
9	2	14M	66.8u	1.121m	-	76.06m
10	1	16M	80.0u	-	-	105.0m
11	3	9M	60.6u	1.769m	1.214m	417.9m
12	2	6M	66.1u	1.004m	-	28.34m
13	1	16M	75.1u	-	-	533.8m
14	2	8M	92.1u	1.154m	-	138.0m
15	2	7M	64.1u	1.869m	-	192.0m
16	1	15M	71.7u	-	-	607.4m
17	2	6M	57.0u	1.751m	-	74.28m
18	2	15M	56.4u	1.384m	-	458.1m
19	3	13M	94.4u	1.583m	1.741m	377.3m



Long Pulse Radar Test Signal						
Test Signal Name: LP_Signal_11						
Number of Bursts in Trial: 10						
Burst	Pulses per Burst	Chrip (Hz)	Pulse Width (s)	Pulse 1 to 2 Spacing (s)	Pulse 2 to 3 Spacing (s)	Start Location (s)
1	2	11M	92.8u	1.034m	-	1.018
2	1	7M	98.5u	-	-	678.2m
3	1	6M	59.7u	-	-	527.1m
4	1	16M	59.9u	-	-	43.10m
5	1	5M	62.5u	-	-	941.7m
6	2	12M	68.7u	1.737m	-	612.4m
7	3	20M	89.8u	1.363m	1.082m	174.3m
8	2	8M	83.2u	1.828m	-	455.5m
9	3	19M	71.8u	1.034m	1.344m	52.44m
10	1	7M	84.5u	-	-	581.3m

Long Pulse Radar Test Signal						
Test Signal Name: LP_Signal_12						
Number of Bursts in Trial: 10						
Burst	Pulses per Burst	Chrip (Hz)	Pulse Width (s)	Pulse 1 to 2 Spacing (s)	Pulse 2 to 3 Spacing (s)	Start Location (s)
1	2	14M	61.8u	1.843m	-	734.7m
2	3	13M	78.1u	1.671m	1.013m	712.5m
3	1	19M	88.0u	-	-	590.6m
4	3	6M	82.0u	1.833m	1.447m	918.1m
5	2	20M	55.2u	1.797m	-	389.3m
6	2	11M	60.4u	1.321m	-	799.7m
7	3	14M	94.9u	1.114m	1.231m	514.6m
8	2	6M	79.8u	1.703m	-	424.0m
9	3	15M	75.7u	1.657m	1.862m	1.180
10	2	9M	51.1u	1.004m	-	18.70m

Long Pulse Radar Test Signal						
Test Signal Name: LP_Signal_13						
Number of Bursts in Trial: 13						
Burst	Pulses per Burst	Chrip (Hz)	Pulse Width (s)	Pulse 1 to 2 Spacing (s)	Pulse 2 to 3 Spacing (s)	Start Location (s)
1	1	6M	73.4u	-	-	504.3m
2	2	19M	98.1u	994.9u	-	545.5m
3	1	9M	93.5u	-	-	322.4m
4	1	14M	77.3u	-	-	180.2m
5	1	6M	76.0u	-	-	350.6m
6	2	15M	56.2u	1.416m	-	467.3m
7	1	8M	88.1u	-	-	522.0m
8	3	10M	73.4u	1.053m	1.825m	172.9m
9	2	15M	75.0u	1.232m	-	802.1m
10	1	18M	97.8u	-	-	25.50m
11	2	8M	93.1u	1.807m	-	143.8m
12	2	10M	68.7u	1.591m	-	761.4m
13	2	15M	82.8u	1.258m	-	687.8m

Long Pulse Radar Test Signal						
Test Signal Name: LP_Signal_14						
Number of Bursts in Trial: 14						
Burst	Pulses per Burst	Chrip (Hz)	Pulse Width (s)	Pulse 1 to 2 Spacing (s)	Pulse 2 to 3 Spacing (s)	Start Location (s)
1	1	7M	56.9u	-	-	481.2m
2	3	6M	82.8u	1.716m	1.682m	269.8m
3	2	11M	71.1u	1.766m	-	702.4m
4	2	19M	86.4u	1.320m	-	765.0m
5	3	18M	79.2u	1.262m	1.445m	547.2m
6	3	17M	92.2u	1.672m	1.581m	241.3m
7	3	14M	79.3u	1.430m	1.585m	138.0m
8	3	17M	53.9u	1.293m	947.1u	843.3m
9	1	8M	54.2u	-	-	217.9m
10	2	9M	71.5u	1.347m	-	68.80m
11	2	11M	65.4u	1.467m	-	803.0m
12	1	8M	62.5u	-	-	250.4m
13	2	12M	60.0u	1.119m	-	699.2m
14	2	20M	59.1u	1.772m	-	263.5m

Long Pulse Radar Test Signal						
Test Signal Name: LP_Signal_15						
Number of Bursts in Trial: 17						
Burst	Pulses per Burst	Chrip (Hz)	Pulse Width (s)	Pulse 1 to 2 Spacing (s)	Pulse 2 to 3 Spacing (s)	Start Location (s)
1	2	10M	61.4u	1.925m	-	406.7m
2	2	17M	65.2u	1.930m	-	506.3m
3	2	5M	60.1u	1.225m	-	352.2m
4	2	14M	69.3u	1.628m	-	516.1m
5	1	12M	76.7u	-	-	69.02m
6	2	8M	57.8u	1.232m	-	293.7m
7	1	10M	76.9u	-	-	51.10m
8	2	13M	73.9u	1.390m	-	649.1m
9	2	9M	96.1u	1.023m	-	116.4m
10	3	16M	84.4u	935.6u	1.252m	618.9m
11	1	8M	57.6u	-	-	114.9m
12	2	7M	76.8u	1.252m	-	693.3m
13	2	12M	67.0u	1.358m	-	205.6m
14	2	12M	56.9u	1.727m	-	338.7m
15	2	13M	68.6u	1.723m	-	307.5m
16	2	19M	65.2u	1.584m	-	276.2m
17	1	17M	60.4u	-	-	100.8m

Long Pulse Radar Test Signal						
Test Signal Name: LP_Signal_16						
Number of Bursts in Trial: 10						
Burst	Pulses per Burst	Chrip (Hz)	Pulse Width (s)	Pulse 1 to 2 Spacing (s)	Pulse 2 to 3 Spacing (s)	Start Location (s)
1	3	17M	92.7u	1.327m	1.415m	126.9m
2	3	20M	66.5u	1.708m	1.334m	696.5m
3	2	15M	92.8u	1.617m	-	1.188
4	1	11M	53.6u	-	-	586.6m
5	3	15M	84.0u	1.000m	1.158m	127.9m
6	2	16M	52.4u	1.495m	-	534.9m
7	1	7M	71.1u	-	-	871.5m
8	3	8M	63.9u	1.711m	1.585m	333.7m
9	2	7M	70.7u	1.502m	-	77.02m
10	2	10M	77.2u	1.164m	-	226.4m

Long Pulse Radar Test Signal						
Test Signal Name: LP_Signal_17						
Number of Bursts in Trial: 18						
Burst	Pulses per Burst	Chrip (Hz)	Pulse Width (s)	Pulse 1 to 2 Spacing (s)	Pulse 2 to 3 Spacing (s)	Start Location (s)
1	2	13M	53.0u	1.063m	-	376.6m
2	2	16M	76.6u	1.134m	-	365.2m
3	1	19M	74.2u	-	-	632.6m
4	2	16M	79.6u	1.428m	-	14.43m
5	1	13M	68.1u	-	-	502.7m
6	1	6M	88.3u	-	-	607.1m
7	2	8M	95.8u	1.628m	-	514.6m
8	3	7M	96.4u	1.346m	1.609m	33.40m
9	2	10M	58.3u	990.7u	-	49.06m
10	1	14M	59.0u	-	-	90.22m
11	2	18M	71.3u	1.224m	-	83.70m
12	3	17M	82.1u	1.132m	1.707m	366.2m
13	3	19M	86.6u	1.125m	1.614m	177.7m
14	1	8M	58.1u	-	-	169.5m
15	1	17M	93.6u	-	-	80.21m
16	1	9M	56.3u	-	-	376.6m
17	2	14M	96.1u	1.463m	-	416.0m
18	1	5M	89.1u	-	-	640.9m

Long Pulse Radar Test Signal						
Test Signal Name: LP_Signal_18						
Number of Bursts in Trial: 14						
Burst	Pulses per Burst	Chrip (Hz)	Pulse Width (s)	Pulse 1 to 2 Spacing (s)	Pulse 2 to 3 Spacing (s)	Start Location (s)
1	2	8M	65.5u	1.832m	-	789.4m
2	3	19M	91.5u	1.605m	1.548m	238.0m
3	3	18M	83.3u	1.642m	1.615m	48.26m
4	3	17M	94.6u	932.4u	1.648m	727.5m
5	3	6M	61.7u	1.259m	1.506m	471.0m
6	2	19M	68.2u	1.239m	-	132.6m
7	2	10M	64.9u	1.355m	-	138.8m
8	2	18M	81.0u	1.697m	-	445.2m
9	2	6M	88.3u	1.309m	-	285.2m
10	3	12M	90.9u	1.274m	1.119m	429.4m
11	3	11M	53.0u	948.0u	1.200m	482.1m
12	2	17M	73.5u	1.914m	-	735.5m
13	2	19M	71.7u	1.165m	-	525.5m
14	2	17M	55.9u	1.939m	-	491.3m

Long Pulse Radar Test Signal						
Test Signal Name: LP_Signal_19						
Number of Bursts in Trial: 13						
Burst	Pulses per Burst	Chrip (Hz)	Pulse Width (s)	Pulse 1 to 2 Spacing (s)	Pulse 2 to 3 Spacing (s)	Start Location (s)
1	3	13M	51.9u	1.544m	1.864m	375.1m
2	2	11M	81.5u	1.143m	-	192.7m
3	1	19M	91.3u	-	-	633.2m
4	2	13M	97.6u	1.724m	-	756.5m
5	3	5M	97.2u	1.842m	1.182m	890.8m
6	1	14M	62.6u	-	-	420.7m
7	2	15M	59.3u	1.146m	-	707.2m
8	1	13M	62.5u	-	-	668.1m
9	1	16M	76.1u	-	-	360.0m
10	2	13M	82.1u	1.526m	-	570.7m
11	3	8M	87.5u	1.894m	1.907m	759.4m
12	3	13M	60.4u	1.459m	1.237m	103.4m
13	2	15M	63.9u	1.313m	-	583.3m



Long Pulse Radar Test Signal						
Test Signal Name: LP_Signal_20						
Number of Bursts in Trial: 14						
Burst	Pulses per Burst	Chrip (Hz)	Pulse Width (s)	Pulse 1 to 2 Spacing (s)	Pulse 2 to 3 Spacing (s)	Start Location (s)
1	2	8M	64.0u	1.885m	-	398.6m
2	2	6M	80.1u	1.386m	-	516.7m
3	2	15M	89.2u	1.549m	-	66.33m
4	1	15M	71.7u	-	-	355.1m
5	2	10M	94.9u	1.166m	-	571.5m
6	2	7M	76.0u	1.788m	-	195.6m
7	2	11M	53.3u	1.302m	-	602.4m
8	2	18M	56.3u	1.384m	-	424.1m
9	2	20M	98.6u	1.624m	-	158.0m
10	2	9M	80.9u	1.343m	-	423.4m
11	2	13M	82.2u	1.817m	-	608.6m
12	1	13M	93.2u	-	-	310.3m
13	1	5M	55.8u	-	-	821.3m
14	1	20M	63.0u	-	-	421.6m

Long Pulse Radar Test Signal						
Test Signal Name: LP_Signal_21						
Number of Bursts in Trial: 10						
Burst	Pulses per Burst	Chrip (Hz)	Pulse Width (s)	Pulse 1 to 2 Spacing (s)	Pulse 2 to 3 Spacing (s)	Start Location (s)
1	2	14M	81.2u	1.666m	-	562.9m
2	1	7M	83.7u	-	-	932.9m
3	3	7M	80.2u	1.590m	1.831m	176.9m
4	2	18M	92.0u	1.519m	-	323.6m
5	3	18M	92.6u	1.055m	970.4u	817.2m
6	2	6M	74.2u	926.8u	-	691.5m
7	2	10M	71.2u	1.683m	-	1.054
8	2	5M	61.9u	1.087m	-	838.7m
9	2	8M	68.9u	1.360m	-	414.8m
10	2	10M	71.0u	1.394m	-	775.8m

Long Pulse Radar Test Signal						
Test Signal Name: LP_Signal_22						
Number of Bursts in Trial: 15						
Burst	Pulses per Burst	Chrip (Hz)	Pulse Width (s)	Pulse 1 to 2 Spacing (s)	Pulse 2 to 3 Spacing (s)	Start Location (s)
1	1	6M	89.2u	-	-	343.1m
2	3	9M	71.1u	1.713m	1.792m	238.0m
3	2	18M	78.1u	1.252m	-	342.7m
4	3	13M	66.6u	1.709m	1.755m	446.9m
5	2	14M	50.2u	1.120m	-	165.3m
6	2	20M	82.7u	1.589m	-	513.9m
7	1	18M	69.3u	-	-	343.3m
8	2	16M	75.7u	1.814m	-	701.8m
9	2	14M	50.7u	1.070m	-	754.0m
10	3	5M	87.7u	1.512m	1.442m	100.1m
11	3	20M	51.9u	1.696m	1.681m	96.05m
12	3	18M	73.9u	1.616m	1.166m	368.0m
13	2	7M	97.2u	914.8u	-	298.8m
14	3	5M	75.6u	1.798m	1.175m	511.0m
15	1	7M	60.5u	-	-	656.6m

Long Pulse Radar Test Signal						
Test Signal Name: LP_Signal_23						
Number of Bursts in Trial: 10						
Burst	Pulses per Burst	Chrip (Hz)	Pulse Width (s)	Pulse 1 to 2 Spacing (s)	Pulse 2 to 3 Spacing (s)	Start Location (s)
1	2	8M	98.4u	1.057m	-	804.0m
2	3	11M	60.6u	1.163m	1.594m	514.2m
3	2	17M	71.7u	1.263m	-	460.4m
4	2	18M	58.6u	1.118m	-	333.8m
5	1	12M	71.5u	-	-	196.3m
6	1	20M	86.5u	-	-	480.7m
7	1	6M	82.9u	-	-	701.2m
8	1	16M	73.5u	-	-	1.165
9	3	16M	77.6u	948.4u	1.047m	589.3m
10	3	16M	88.9u	1.304m	1.586m	998.7m

Long Pulse Radar Test Signal						
Test Signal Name: LP_Signal_24						
Number of Bursts in Trial: 18						
Burst	Pulses per Burst	Chrip (Hz)	Pulse Width (s)	Pulse 1 to 2 Spacing (s)	Pulse 2 to 3 Spacing (s)	Start Location (s)
1	1	5M	78.2u	-	-	538.8m
2	1	6M	75.6u	-	-	187.9m
3	1	13M	88.6u	-	-	584.6m
4	1	13M	72.7u	-	-	356.1m
5	2	7M	69.5u	961.5u	-	304.4m
6	2	5M	62.0u	1.691m	-	267.7m
7	1	15M	95.5u	-	-	353.6m
8	3	11M	92.2u	1.844m	1.630m	41.27m
9	2	9M	97.7u	1.446m	-	552.6m
10	3	10M	57.6u	1.621m	1.203m	120.4m
11	1	6M	89.9u	-	-	35.45m
12	1	7M	88.2u	-	-	3.635m
13	2	20M	64.6u	1.541m	-	575.6m
14	2	9M	53.7u	1.100m	-	335.2m
15	2	18M	92.6u	1.104m	-	617.2m
16	1	9M	65.3u	-	-	260.3m
17	1	18M	75.2u	-	-	187.2m
18	1	14M	69.9u	-	-	335.0m

Long Pulse Radar Test Signal						
Test Signal Name: LP_Signal_25						
Number of Bursts in Trial: 17						
Burst	Pulses per Burst	Chrip (Hz)	Pulse Width (s)	Pulse 1 to 2 Spacing (s)	Pulse 2 to 3 Spacing (s)	Start Location (s)
1	2	19M	74.3u	1.849m	-	83.06m
2	2	15M	67.0u	1.333m	-	107.9m
3	1	14M	98.1u	-	-	121.0m
4	2	17M	81.7u	1.444m	-	244.0m
5	2	19M	66.1u	1.689m	-	477.3m
6	2	6M	96.9u	909.1u	-	492.9m
7	2	7M	67.7u	1.375m	-	322.3m
8	2	18M	85.7u	1.112m	-	247.8m
9	1	11M	63.1u	-	-	172.3m
10	1	12M	80.5u	-	-	204.5m
11	3	11M	99.1u	1.124m	1.855m	98.56m
12	2	9M	87.1u	1.271m	-	649.2m
13	1	17M	58.8u	-	-	326.8m
14	2	7M	88.9u	1.003m	-	360.9m
15	1	17M	85.1u	-	-	201.1m
16	2	20M	82.8u	1.511m	-	617.1m
17	2	19M	61.9u	1.657m	-	522.4m

Long Pulse Radar Test Signal						
Test Signal Name: LP_Signal_26						
Number of Bursts in Trial: 12						
Burst	Pulses per Burst	Chrip (Hz)	Pulse Width (s)	Pulse 1 to 2 Spacing (s)	Pulse 2 to 3 Spacing (s)	Start Location (s)
1	2	7M	65.5u	1.429m	-	528.4m
2	2	6M	67.7u	1.925m	-	252.5m
3	1	17M	83.7u	-	-	285.4m
4	1	16M	59.2u	-	-	997.6m
5	2	9M	76.5u	1.161m	-	272.6m
6	2	6M	79.5u	1.873m	-	406.8m
7	1	7M	86.5u	-	-	104.5m
8	1	19M	85.6u	-	-	223.4m
9	1	11M	92.2u	-	-	640.5m
10	2	19M	54.6u	1.308m	-	353.7m
11	2	11M	70.1u	1.599m	-	746.9m
12	3	20M	71.6u	997.4u	1.068m	208.9m

Long Pulse Radar Test Signal						
Test Signal Name: LP_Signal_27						
Number of Bursts in Trial: 17						
Burst	Pulses per Burst	Chrip (Hz)	Pulse Width (s)	Pulse 1 to 2 Spacing (s)	Pulse 2 to 3 Spacing (s)	Start Location (s)
1	2	7M	73.2u	1.141m	-	378.0m
2	1	18M	91.5u	-	-	129.8m
3	2	14M	70.5u	1.723m	-	484.5m
4	2	5M	77.2u	1.621m	-	257.3m
5	3	19M	65.6u	1.689m	1.600m	684.0m
6	3	14M	81.8u	1.783m	1.009m	463.4m
7	3	18M	52.1u	1.574m	1.617m	124.9m
8	2	9M	64.7u	1.617m	-	629.4m
9	2	12M	96.0u	1.437m	-	535.1m
10	1	18M	83.1u	-	-	354.6m
11	1	8M	74.3u	-	-	28.15m
12	1	14M	94.4u	-	-	525.6m
13	3	12M	69.5u	1.452m	1.730m	346.9m
14	2	20M	86.8u	1.054m	-	673.0m
15	2	15M	57.0u	1.236m	-	697.4m
16	2	8M	55.7u	1.378m	-	197.8m
17	2	12M	67.9u	1.630m	-	263.1m



Long Pulse Radar Test Signal						
Test Signal Name: LP_Signal_28						
Number of Bursts in Trial: 16						
Burst	Pulses per Burst	Chrip (Hz)	Pulse Width (s)	Pulse 1 to 2 Spacing (s)	Pulse 2 to 3 Spacing (s)	Start Location (s)
1	2	11M	91.2u	1.196m	-	595.0m
2	3	17M	57.3u	1.641m	1.021m	5.132m
3	1	17M	72.7u	-	-	665.6m
4	2	13M	68.8u	1.231m	-	119.0m
5	3	8M	67.1u	1.603m	1.916m	43.18m
6	1	19M	75.7u	-	-	172.4m
7	1	18M	50.4u	-	-	224.6m
8	3	16M	73.8u	1.285m	1.091m	678.5m
9	2	7M	86.5u	1.003m	-	670.5m
10	1	12M	55.0u	-	-	352.1m
11	2	15M	54.9u	1.687m	-	306.9m
12	1	9M	86.4u	-	-	731.7m
13	1	7M	71.4u	-	-	699.2m
14	1	6M	50.6u	-	-	40.77m
15	3	17M	94.5u	1.110m	1.796m	272.4m
16	1	6M	66.6u	-	-	423.4m

Long Pulse Radar Test Signal						
Test Signal Name: LP_Signal_29						
Number of Bursts in Trial: 13						
Burst	Pulses per Burst	Chrip (Hz)	Pulse Width (s)	Pulse 1 to 2 Spacing (s)	Pulse 2 to 3 Spacing (s)	Start Location (s)
1	3	8M	96.8u	1.257m	1.528m	862.3m
2	3	15M	53.3u	1.351m	1.462m	610.2m
3	3	8M	63.9u	1.872m	1.549m	199.9m
4	3	15M	64.2u	1.028m	961.8u	196.7m
5	2	18M	59.0u	1.052m	-	740.8m
6	1	16M	78.3u	-	-	624.1m
7	2	8M	62.5u	954.5u	-	531.3m
8	3	18M	72.5u	1.832m	1.530m	714.7m
9	3	12M	60.7u	965.3u	1.236m	673.5m
10	2	13M	79.6u	1.583m	-	334.2m
11	2	9M	68.8u	1.557m	-	316.9m
12	2	8M	69.4u	947.6u	-	492.5m
13	1	14M	64.5u	-	-	399.5m

Long Pulse Radar Test Signal						
Test Signal Name: LP_Signal_30						
Number of Bursts in Trial: 11						
Burst	Pulses per Burst	Chrip (Hz)	Pulse Width (s)	Pulse 1 to 2 Spacing (s)	Pulse 2 to 3 Spacing (s)	Start Location (s)
1	1	16M	50.2u	-	-	278.4m
2	2	12M	80.7u	1.382m	-	730.0m
3	1	12M	81.1u	-	-	265.9m
4	2	7M	84.2u	1.356m	-	400.6m
5	2	9M	65.9u	1.133m	-	406.3m
6	1	11M	89.9u	-	-	847.0m
7	2	13M	98.9u	1.563m	-	242.1m
8	2	8M	82.2u	1.518m	-	565.1m
9	1	6M	68.9u	-	-	482.4m
10	2	11M	87.1u	1.471m	-	945.3m
11	2	19M	92.9u	1.341m	-	1.012

Type 6 Radar Statistical Performances				
Trial #	Pulses per Burst	Pulse Width (s)	PRI (s)	Detection
1	9	1.0u	333.0u	Yes
2	9	1.0u	333.0u	Yes
3	9	1.0u	333.0u	Yes
4	9	1.0u	333.0u	Yes
5	9	1.0u	333.0u	Yes
6	9	1.0u	333.0u	Yes
7	9	1.0u	333.0u	Yes
8	9	1.0u	333.0u	No
9	9	1.0u	333.0u	Yes
10	9	1.0u	333.0u	Yes
11	9	1.0u	333.0u	Yes
12	9	1.0u	333.0u	Yes
13	9	1.0u	333.0u	No
14	9	1.0u	333.0u	Yes
15	9	1.0u	333.0u	Yes
16	9	1.0u	333.0u	Yes
17	9	1.0u	333.0u	Yes
18	9	1.0u	333.0u	Yes
19	9	1.0u	333.0u	Yes
20	9	1.0u	333.0u	Yes
21	9	1.0u	333.0u	Yes
22	9	1.0u	333.0u	Yes
23	9	1.0u	333.0u	Yes
24	9	1.0u	333.0u	Yes
25	9	1.0u	333.0u	Yes
26	9	1.0u	333.0u	Yes
27	9	1.0u	333.0u	Yes
28	9	1.0u	333.0u	Yes
29	9	1.0u	333.0u	Yes
30	9	1.0u	333.0u	Yes
				Detection Rate: 93.3 %

Type 6 Radar Statistical Performances		
Trial #	Hopping Frequency Sequence Name	Detection
1	HOP_FREQ_SEQ_01	Yes
2	HOP_FREQ_SEQ_02	Yes
3	HOP_FREQ_SEQ_03	Yes
4	HOP_FREQ_SEQ_04	Yes
5	HOP_FREQ_SEQ_05	Yes
6	HOP_FREQ_SEQ_06	Yes
7	HOP_FREQ_SEQ_07	Yes
8	HOP_FREQ_SEQ_08	No
9	HOP_FREQ_SEQ_09	Yes
10	HOP_FREQ_SEQ_10	Yes
11	HOP_FREQ_SEQ_11	Yes
12	HOP_FREQ_SEQ_12	Yes
13	HOP_FREQ_SEQ_13	No
14	HOP_FREQ_SEQ_14	Yes
15	HOP_FREQ_SEQ_15	Yes
16	HOP_FREQ_SEQ_16	Yes
17	HOP_FREQ_SEQ_17	Yes
18	HOP_FREQ_SEQ_18	Yes
19	HOP_FREQ_SEQ_19	Yes
20	HOP_FREQ_SEQ_20	Yes
21	HOP_FREQ_SEQ_21	Yes
22	HOP_FREQ_SEQ_22	Yes
23	HOP_FREQ_SEQ_23	Yes
24	HOP_FREQ_SEQ_24	Yes
25	HOP_FREQ_SEQ_25	Yes
26	HOP_FREQ_SEQ_26	Yes
27	HOP_FREQ_SEQ_27	Yes
28	HOP_FREQ_SEQ_28	Yes
29	HOP_FREQ_SEQ_29	Yes
30	HOP_FREQ_SEQ_30	Yes
		Detection Rate: 93.3 %

Hopping Frequency Sequence Name: HOP_FREQ_SEQ_01							
SEQ#	Frequency (Hz)	SEQ#	Frequency (Hz)	SEQ#	Frequency (Hz)	SEQ#	Frequency (Hz)
1	5.556G	2	5.528G	3	5.666G	4	5.721G
5	5.262G	6	5.659G	7	5.268G	8	5.405G
9	5.252G	10	5.343G	11	5.463G	12	5.536G
13	5.660G	14	5.460G	15	5.281G	16	5.315G
17	5.329G	18	5.580G	19	5.345G	20	5.691G
21	5.443G	22	5.347G	23	5.330G	24	5.291G
25	5.511G	26	5.502G	27	5.657G	28	5.297G
29	5.275G	30	5.474G	31	5.625G	32	5.438G
33	5.614G	34	5.723G	35	5.683G	36	5.479G
37	5.605G	38	5.584G	39	5.514G	40	5.374G
41	5.277G	42	5.641G	43	5.634G	44	5.269G
45	5.454G	46	5.546G	47	5.535G	48	5.403G
49	5.616G	50	5.418G	51	5.462G	52	5.257G
53	5.645G	54	5.553G	55	5.285G	56	5.545G
57	5.668G	58	5.396G	59	5.295G	60	5.346G
61	5.562G	62	5.470G	63	5.387G	64	5.326G
65	5.339G	66	5.627G	67	5.638G	68	5.432G
69	5.670G	70	5.523G	71	5.359G	72	5.531G
73	5.509G	74	5.402G	75	5.404G	76	5.319G
77	5.620G	78	5.708G	79	5.655G	80	5.251G
81	5.649G	82	5.698G	83	5.710G	84	5.585G
85	5.513G	86	5.377G	87	5.427G	88	5.685G
89	5.270G	90	5.442G	91	5.406G	92	5.628G
93	5.534G	94	5.372G	95	5.320G	96	5.365G
97	5.370G	98	5.436G	99	5.388G	100	5.677G

Hopping Frequency Sequence Name: HOP_FREQ_SEQ_02							
SEQ#	Frequency (Hz)	SEQ#	Frequency (Hz)	SEQ#	Frequency (Hz)	SEQ#	Frequency (Hz)
1	5.365G	2	5.348G	3	5.432G	4	5.447G
5	5.591G	6	5.295G	7	5.680G	8	5.620G
9	5.656G	10	5.351G	11	5.566G	12	5.421G
13	5.720G	14	5.322G	15	5.319G	16	5.270G
17	5.361G	18	5.274G	19	5.370G	20	5.640G
21	5.548G	22	5.311G	23	5.363G	24	5.462G
25	5.530G	26	5.271G	27	5.585G	28	5.578G
29	5.657G	30	5.278G	31	5.461G	32	5.307G
33	5.325G	34	5.724G	35	5.422G	36	5.376G
37	5.541G	38	5.469G	39	5.697G	40	5.589G
41	5.301G	42	5.474G	43	5.277G	44	5.327G
45	5.415G	46	5.647G	47	5.636G	48	5.315G
49	5.261G	50	5.655G	51	5.587G	52	5.554G
53	5.648G	54	5.523G	55	5.687G	56	5.257G
57	5.717G	58	5.694G	59	5.334G	60	5.471G
61	5.558G	62	5.452G	63	5.481G	64	5.573G
65	5.684G	66	5.344G	67	5.715G	68	5.466G
69	5.457G	70	5.606G	71	5.517G	72	5.630G
73	5.562G	74	5.382G	75	5.287G	76	5.601G
77	5.336G	78	5.691G	79	5.599G	80	5.671G
81	5.561G	82	5.626G	83	5.596G	84	5.677G
85	5.276G	86	5.436G	87	5.298G	88	5.392G
89	5.357G	90	5.505G	91	5.333G	92	5.409G
93	5.521G	94	5.700G	95	5.569G	96	5.563G
97	5.313G	98	5.529G	99	5.446G	100	5.397G

Hopping Frequency Sequence Name: HOP_FREQ_SEQ_03							
SEQ#	Frequency (Hz)	SEQ#	Frequency (Hz)	SEQ#	Frequency (Hz)	SEQ#	Frequency (Hz)
1	5.348G	2	5.328G	3	5.530G	4	5.721G
5	5.688G	6	5.449G	7	5.329G	8	5.667G
9	5.584G	10	5.661G	11	5.355G	12	5.476G
13	5.478G	14	5.529G	15	5.358G	16	5.520G
17	5.341G	18	5.370G	19	5.405G	20	5.646G
21	5.380G	22	5.609G	23	5.305G	24	5.577G
25	5.523G	26	5.525G	27	5.263G	28	5.313G
29	5.716G	30	5.280G	31	5.642G	32	5.662G
33	5.502G	34	5.475G	35	5.512G	36	5.260G
37	5.307G	38	5.391G	39	5.482G	40	5.408G
41	5.327G	42	5.424G	43	5.506G	44	5.524G
45	5.416G	46	5.572G	47	5.393G	48	5.311G
49	5.480G	50	5.622G	51	5.715G	52	5.556G
53	5.308G	54	5.374G	55	5.541G	56	5.568G
57	5.254G	58	5.270G	59	5.268G	60	5.671G
61	5.596G	62	5.423G	63	5.399G	64	5.501G
65	5.339G	66	5.585G	67	5.383G	68	5.259G
69	5.706G	70	5.255G	71	5.340G	72	5.456G
73	5.615G	74	5.573G	75	5.678G	76	5.317G
77	5.587G	78	5.698G	79	5.657G	80	5.296G
81	5.668G	82	5.625G	83	5.630G	84	5.349G
85	5.503G	86	5.432G	87	5.396G	88	5.680G
89	5.617G	90	5.536G	91	5.392G	92	5.266G
93	5.290G	94	5.652G	95	5.522G	96	5.468G
97	5.631G	98	5.457G	99	5.256G	100	5.578G



Hopping Frequency Sequence Name: HOP_FREQ_SEQ_04							
SEQ#	Frequency (Hz)	SEQ#	Frequency (Hz)	SEQ#	Frequency (Hz)	SEQ#	Frequency (Hz)
1	5.390G	2	5.612G	3	5.396G	4	5.512G
5	5.424G	6	5.401G	7	5.499G	8	5.661G
9	5.609G	10	5.572G	11	5.376G	12	5.496G
13	5.561G	14	5.541G	15	5.514G	16	5.431G
17	5.476G	18	5.309G	19	5.586G	20	5.283G
21	5.371G	22	5.380G	23	5.543G	24	5.423G
25	5.641G	26	5.611G	27	5.720G	28	5.634G
29	5.650G	30	5.304G	31	5.619G	32	5.275G
33	5.362G	34	5.629G	35	5.411G	36	5.627G
37	5.389G	38	5.356G	39	5.384G	40	5.553G
41	5.330G	42	5.682G	43	5.584G	44	5.574G
45	5.328G	46	5.658G	47	5.620G	48	5.535G
49	5.434G	50	5.550G	51	5.339G	52	5.454G
53	5.559G	54	5.274G	55	5.486G	56	5.461G
57	5.381G	58	5.529G	59	5.669G	60	5.647G
61	5.440G	62	5.532G	63	5.601G	64	5.322G
65	5.519G	66	5.708G	67	5.549G	68	5.332G
69	5.251G	70	5.460G	71	5.665G	72	5.477G
73	5.545G	74	5.637G	75	5.692G	76	5.590G
77	5.667G	78	5.592G	79	5.438G	80	5.678G
81	5.418G	82	5.482G	83	5.363G	84	5.522G
85	5.433G	86	5.607G	87	5.475G	88	5.358G
89	5.388G	90	5.557G	91	5.521G	92	5.655G
93	5.672G	94	5.628G	95	5.652G	96	5.261G
97	5.448G	98	5.654G	99	5.591G	100	5.469G

Hopping Frequency Sequence Name: HOP_FREQ_SEQ_05							
SEQ#	Frequency (Hz)	SEQ#	Frequency (Hz)	SEQ#	Frequency (Hz)	SEQ#	Frequency (Hz)
1	5.442G	2	5.528G	3	5.562G	4	5.354G
5	5.554G	6	5.682G	7	5.545G	8	5.581G
9	5.345G	10	5.599G	11	5.478G	12	5.634G
13	5.444G	14	5.344G	15	5.435G	16	5.717G
17	5.671G	18	5.472G	19	5.327G	20	5.378G
21	5.462G	22	5.450G	23	5.416G	24	5.505G
25	5.483G	26	5.637G	27	5.720G	28	5.598G
29	5.297G	30	5.386G	31	5.361G	32	5.560G
33	5.459G	34	5.614G	35	5.526G	36	5.269G
37	5.430G	38	5.451G	39	5.482G	40	5.557G
41	5.543G	42	5.359G	43	5.700G	44	5.659G
45	5.550G	46	5.415G	47	5.713G	48	5.348G
49	5.600G	50	5.609G	51	5.307G	52	5.616G
53	5.497G	54	5.426G	55	5.493G	56	5.664G
57	5.363G	58	5.519G	59	5.573G	60	5.328G
61	5.667G	62	5.625G	63	5.503G	64	5.699G
65	5.693G	66	5.326G	67	5.585G	68	5.281G
69	5.547G	70	5.369G	71	5.380G	72	5.421G
73	5.577G	74	5.529G	75	5.690G	76	5.410G
77	5.405G	78	5.653G	79	5.303G	80	5.373G
81	5.349G	82	5.530G	83	5.578G	84	5.622G
85	5.639G	86	5.377G	87	5.397G	88	5.533G
89	5.523G	90	5.456G	91	5.681G	92	5.424G
93	5.670G	94	5.650G	95	5.517G	96	5.488G
97	5.582G	98	5.468G	99	5.275G	100	5.685G

Hopping Frequency Sequence Name: HOP_FREQ_SEQ_06							
SEQ#	Frequency (Hz)	SEQ#	Frequency (Hz)	SEQ#	Frequency (Hz)	SEQ#	Frequency (Hz)
1	5.357G	2	5.355G	3	5.724G	4	5.291G
5	5.334G	6	5.452G	7	5.605G	8	5.549G
9	5.348G	10	5.407G	11	5.286G	12	5.628G
13	5.296G	14	5.371G	15	5.528G	16	5.669G
17	5.255G	18	5.503G	19	5.271G	20	5.514G
21	5.397G	22	5.712G	23	5.330G	24	5.326G
25	5.687G	26	5.606G	27	5.554G	28	5.450G
29	5.708G	30	5.500G	31	5.688G	32	5.448G
33	5.711G	34	5.471G	35	5.386G	36	5.372G
37	5.642G	38	5.473G	39	5.598G	40	5.284G
41	5.356G	42	5.385G	43	5.567G	44	5.352G
45	5.678G	46	5.463G	47	5.611G	48	5.579G
49	5.662G	50	5.699G	51	5.445G	52	5.476G
53	5.657G	54	5.569G	55	5.440G	56	5.279G
57	5.707G	58	5.308G	59	5.376G	60	5.313G
61	5.396G	62	5.717G	63	5.482G	64	5.437G
65	5.340G	66	5.599G	67	5.672G	68	5.676G
69	5.513G	70	5.686G	71	5.301G	72	5.601G
73	5.568G	74	5.379G	75	5.259G	76	5.323G
77	5.270G	78	5.335G	79	5.690G	80	5.461G
81	5.333G	82	5.316G	83	5.416G	84	5.555G
85	5.647G	86	5.544G	87	5.720G	88	5.585G
89	5.600G	90	5.406G	91	5.312G	92	5.656G
93	5.483G	94	5.328G	95	5.574G	96	5.392G
97	5.655G	98	5.413G	99	5.321G	100	5.349G

Hopping Frequency Sequence Name: HOP_FREQ_SEQ_07							
SEQ#	Frequency (Hz)	SEQ#	Frequency (Hz)	SEQ#	Frequency (Hz)	SEQ#	Frequency (Hz)
1	5.658G	2	5.549G	3	5.644G	4	5.466G
5	5.263G	6	5.333G	7	5.480G	8	5.722G
9	5.620G	10	5.702G	11	5.511G	12	5.314G
13	5.264G	14	5.545G	15	5.548G	16	5.359G
17	5.510G	18	5.398G	19	5.596G	20	5.512G
21	5.505G	22	5.456G	23	5.556G	24	5.592G
25	5.585G	26	5.469G	27	5.697G	28	5.724G
29	5.664G	30	5.580G	31	5.302G	32	5.476G
33	5.345G	34	5.415G	35	5.654G	36	5.373G
37	5.573G	38	5.330G	39	5.515G	40	5.300G
41	5.601G	42	5.315G	43	5.371G	44	5.649G
45	5.555G	46	5.431G	47	5.708G	48	5.417G
49	5.280G	50	5.434G	51	5.344G	52	5.587G
53	5.685G	54	5.645G	55	5.543G	56	5.716G
57	5.340G	58	5.525G	59	5.713G	60	5.301G
61	5.623G	62	5.418G	63	5.394G	64	5.377G
65	5.397G	66	5.468G	67	5.659G	68	5.364G
69	5.499G	70	5.262G	71	5.435G	72	5.502G
73	5.387G	74	5.608G	75	5.383G	76	5.442G
77	5.357G	78	5.399G	79	5.550G	80	5.355G
81	5.679G	82	5.366G	83	5.428G	84	5.589G
85	5.611G	86	5.493G	87	5.513G	88	5.690G
89	5.405G	90	5.706G	91	5.501G	92	5.667G
93	5.328G	94	5.640G	95	5.669G	96	5.700G
97	5.349G	98	5.687G	99	5.597G	100	5.320G

Hopping Frequency Sequence Name: HOP_FREQ_SEQ_08							
SEQ#	Frequency (Hz)	SEQ#	Frequency (Hz)	SEQ#	Frequency (Hz)	SEQ#	Frequency (Hz)
1	5.293G	2	5.413G	3	5.376G	4	5.552G
5	5.301G	6	5.526G	7	5.714G	8	5.450G
9	5.317G	10	5.667G	11	5.395G	12	5.305G
13	5.393G	14	5.630G	15	5.512G	16	5.562G
17	5.458G	18	5.529G	19	5.452G	20	5.660G
21	5.697G	22	5.718G	23	5.664G	24	5.655G
25	5.343G	26	5.676G	27	5.342G	28	5.621G
29	5.253G	30	5.493G	31	5.442G	32	5.544G
33	5.705G	34	5.685G	35	5.534G	36	5.611G
37	5.646G	38	5.460G	39	5.479G	40	5.281G
41	5.656G	42	5.464G	43	5.311G	44	5.328G
45	5.724G	46	5.631G	47	5.500G	48	5.410G
49	5.456G	50	5.616G	51	5.661G	52	5.314G
53	5.673G	54	5.618G	55	5.402G	56	5.521G
57	5.453G	58	5.437G	59	5.382G	60	5.649G
61	5.473G	62	5.308G	63	5.579G	64	5.401G
65	5.359G	66	5.287G	67	5.671G	68	5.622G
69	5.507G	70	5.438G	71	5.338G	72	5.361G
73	5.451G	74	5.623G	75	5.532G	76	5.542G
77	5.404G	78	5.565G	79	5.608G	80	5.390G
81	5.632G	82	5.669G	83	5.439G	84	5.556G
85	5.535G	86	5.471G	87	5.339G	88	5.516G
89	5.584G	90	5.297G	91	5.266G	92	5.495G
93	5.716G	94	5.426G	95	5.462G	96	5.400G
97	5.427G	98	5.609G	99	5.418G	100	5.719G

Hopping Frequency Sequence Name: HOP_FREQ_SEQ_09							
SEQ#	Frequency (Hz)	SEQ#	Frequency (Hz)	SEQ#	Frequency (Hz)	SEQ#	Frequency (Hz)
1	5.695G	2	5.630G	3	5.432G	4	5.684G
5	5.344G	6	5.528G	7	5.280G	8	5.669G
9	5.404G	10	5.709G	11	5.551G	12	5.397G
13	5.265G	14	5.479G	15	5.569G	16	5.718G
17	5.555G	18	5.426G	19	5.509G	20	5.420G
21	5.553G	22	5.441G	23	5.317G	24	5.299G
25	5.716G	26	5.253G	27	5.331G	28	5.442G
29	5.355G	30	5.415G	31	5.504G	32	5.604G
33	5.428G	34	5.424G	35	5.388G	36	5.318G
37	5.475G	38	5.566G	39	5.633G	40	5.408G
41	5.595G	42	5.641G	43	5.403G	44	5.302G
45	5.456G	46	5.298G	47	5.341G	48	5.505G
49	5.486G	50	5.314G	51	5.677G	52	5.255G
53	5.645G	54	5.531G	55	5.254G	56	5.429G
57	5.527G	58	5.334G	59	5.252G	60	5.708G
61	5.651G	62	5.580G	63	5.439G	64	5.330G
65	5.377G	66	5.406G	67	5.713G	68	5.627G
69	5.286G	70	5.288G	71	5.476G	72	5.626G
73	5.337G	74	5.515G	75	5.592G	76	5.667G
77	5.290G	78	5.405G	79	5.521G	80	5.481G
81	5.550G	82	5.591G	83	5.458G	84	5.609G
85	5.523G	86	5.575G	87	5.611G	88	5.663G
89	5.660G	90	5.628G	91	5.409G	92	5.342G
93	5.263G	94	5.322G	95	5.483G	96	5.351G
97	5.391G	98	5.526G	99	5.562G	100	5.650G

Hopping Frequency Sequence Name: HOP_FREQ_SEQ_10							
SEQ#	Frequency (Hz)	SEQ#	Frequency (Hz)	SEQ#	Frequency (Hz)	SEQ#	Frequency (Hz)
1	5.419G	2	5.475G	3	5.376G	4	5.255G
5	5.605G	6	5.624G	7	5.537G	8	5.359G
9	5.720G	10	5.697G	11	5.302G	12	5.262G
13	5.511G	14	5.657G	15	5.631G	16	5.444G
17	5.538G	18	5.658G	19	5.261G	20	5.268G
21	5.533G	22	5.563G	23	5.619G	24	5.539G
25	5.253G	26	5.467G	27	5.662G	28	5.316G
29	5.389G	30	5.311G	31	5.527G	32	5.387G
33	5.423G	34	5.250G	35	5.600G	36	5.574G
37	5.544G	38	5.304G	39	5.654G	40	5.617G
41	5.497G	42	5.602G	43	5.410G	44	5.722G
45	5.670G	46	5.340G	47	5.462G	48	5.478G
49	5.354G	50	5.333G	51	5.568G	52	5.381G
53	5.440G	54	5.407G	55	5.622G	56	5.251G
57	5.578G	58	5.342G	59	5.286G	60	5.312G
61	5.392G	62	5.453G	63	5.416G	64	5.603G
65	5.534G	66	5.580G	67	5.451G	68	5.548G
69	5.421G	70	5.682G	71	5.723G	72	5.454G
73	5.458G	74	5.307G	75	5.335G	76	5.710G
77	5.586G	78	5.536G	79	5.525G	80	5.446G
81	5.569G	82	5.360G	83	5.431G	84	5.337G
85	5.325G	86	5.299G	87	5.385G	88	5.339G
89	5.349G	90	5.346G	91	5.455G	92	5.364G
93	5.395G	94	5.696G	95	5.394G	96	5.529G
97	5.351G	98	5.471G	99	5.685G	100	5.485G

Hopping Frequency Sequence Name: HOP_FREQ_SEQ_11							
SEQ#	Frequency (Hz)	SEQ#	Frequency (Hz)	SEQ#	Frequency (Hz)	SEQ#	Frequency (Hz)
1	5.306G	2	5.343G	3	5.269G	4	5.300G
5	5.613G	6	5.553G	7	5.575G	8	5.626G
9	5.337G	10	5.516G	11	5.360G	12	5.650G
13	5.618G	14	5.582G	15	5.533G	16	5.675G
17	5.520G	18	5.643G	19	5.584G	20	5.548G
21	5.396G	22	5.434G	23	5.435G	24	5.713G
25	5.349G	26	5.641G	27	5.622G	28	5.262G
29	5.550G	30	5.688G	31	5.347G	32	5.473G
33	5.691G	34	5.690G	35	5.407G	36	5.444G
37	5.501G	38	5.549G	39	5.545G	40	5.672G
41	5.640G	42	5.251G	43	5.464G	44	5.315G
45	5.505G	46	5.438G	47	5.557G	48	5.620G
49	5.630G	50	5.486G	51	5.487G	52	5.718G
53	5.297G	54	5.492G	55	5.314G	56	5.441G
57	5.290G	58	5.674G	59	5.703G	60	5.367G
61	5.474G	62	5.362G	63	5.576G	64	5.648G
65	5.299G	66	5.646G	67	5.400G	68	5.288G
69	5.707G	70	5.705G	71	5.351G	72	5.700G
73	5.614G	74	5.392G	75	5.491G	76	5.466G
77	5.450G	78	5.627G	79	5.710G	80	5.461G
81	5.642G	82	5.600G	83	5.478G	84	5.341G
85	5.471G	86	5.452G	87	5.517G	88	5.482G
89	5.436G	90	5.479G	91	5.544G	92	5.657G
93	5.295G	94	5.587G	95	5.340G	96	5.390G
97	5.254G	98	5.495G	99	5.285G	100	5.318G



Hopping Frequency Sequence Name: HOP_FREQ_SEQ_12							
SEQ#	Frequency (Hz)	SEQ#	Frequency (Hz)	SEQ#	Frequency (Hz)	SEQ#	Frequency (Hz)
1	5.646G	2	5.417G	3	5.687G	4	5.454G
5	5.506G	6	5.622G	7	5.644G	8	5.721G
9	5.470G	10	5.678G	11	5.275G	12	5.429G
13	5.541G	14	5.523G	15	5.666G	16	5.516G
17	5.598G	18	5.305G	19	5.663G	20	5.521G
21	5.469G	22	5.642G	23	5.267G	24	5.561G
25	5.372G	26	5.709G	27	5.265G	28	5.427G
29	5.569G	30	5.568G	31	5.395G	32	5.445G
33	5.375G	34	5.293G	35	5.456G	36	5.653G
37	5.443G	38	5.359G	39	5.407G	40	5.314G
41	5.269G	42	5.295G	43	5.606G	44	5.261G
45	5.546G	46	5.273G	47	5.259G	48	5.272G
49	5.310G	50	5.517G	51	5.620G	52	5.589G
53	5.425G	54	5.475G	55	5.593G	56	5.555G
57	5.717G	58	5.302G	59	5.435G	60	5.418G
61	5.643G	62	5.507G	63	5.648G	64	5.253G
65	5.480G	66	5.383G	67	5.423G	68	5.611G
69	5.288G	70	5.343G	71	5.513G	72	5.483G
73	5.557G	74	5.444G	75	5.307G	76	5.519G
77	5.548G	78	5.698G	79	5.284G	80	5.391G
81	5.385G	82	5.351G	83	5.504G	84	5.583G
85	5.704G	86	5.468G	87	5.487G	88	5.572G
89	5.529G	90	5.348G	91	5.421G	92	5.388G
93	5.367G	94	5.329G	95	5.503G	96	5.582G
97	5.577G	98	5.544G	99	5.322G	100	5.438G

Hopping Frequency Sequence Name: HOP_FREQ_SEQ_13							
SEQ#	Frequency (Hz)	SEQ#	Frequency (Hz)	SEQ#	Frequency (Hz)	SEQ#	Frequency (Hz)
1	5.451G	2	5.579G	3	5.443G	4	5.558G
5	5.414G	6	5.484G	7	5.617G	8	5.441G
9	5.396G	10	5.462G	11	5.686G	12	5.694G
13	5.642G	14	5.345G	15	5.510G	16	5.597G
17	5.681G	18	5.672G	19	5.655G	20	5.578G
21	5.298G	22	5.600G	23	5.696G	24	5.385G
25	5.287G	26	5.658G	27	5.376G	28	5.393G
29	5.428G	30	5.676G	31	5.455G	32	5.318G
33	5.503G	34	5.472G	35	5.549G	36	5.654G
37	5.580G	38	5.700G	39	5.612G	40	5.714G
41	5.667G	42	5.542G	43	5.543G	44	5.316G
45	5.557G	46	5.689G	47	5.263G	48	5.721G
49	5.406G	50	5.509G	51	5.346G	52	5.352G
53	5.435G	54	5.534G	55	5.494G	56	5.408G
57	5.289G	58	5.614G	59	5.469G	60	5.334G
61	5.468G	62	5.457G	63	5.383G	64	5.596G
65	5.288G	66	5.306G	67	5.588G	68	5.636G
69	5.675G	70	5.261G	71	5.668G	72	5.438G
73	5.260G	74	5.264G	75	5.473G	76	5.446G
77	5.629G	78	5.340G	79	5.419G	80	5.477G
81	5.423G	82	5.410G	83	5.404G	84	5.620G
85	5.475G	86	5.426G	87	5.357G	88	5.407G
89	5.535G	90	5.372G	91	5.391G	92	5.344G
93	5.269G	94	5.608G	95	5.563G	96	5.715G
97	5.266G	98	5.265G	99	5.551G	100	5.387G

Hopping Frequency Sequence Name: HOP_FREQ_SEQ_14							
SEQ#	Frequency (Hz)	SEQ#	Frequency (Hz)	SEQ#	Frequency (Hz)	SEQ#	Frequency (Hz)
1	5.279G	2	5.594G	3	5.543G	4	5.477G
5	5.597G	6	5.395G	7	5.255G	8	5.681G
9	5.397G	10	5.410G	11	5.616G	12	5.546G
13	5.412G	14	5.644G	15	5.631G	16	5.504G
17	5.375G	18	5.560G	19	5.719G	20	5.371G
21	5.598G	22	5.636G	23	5.599G	24	5.587G
25	5.531G	26	5.500G	27	5.266G	28	5.557G
29	5.706G	30	5.391G	31	5.562G	32	5.357G
33	5.658G	34	5.354G	35	5.486G	36	5.259G
37	5.637G	38	5.400G	39	5.593G	40	5.267G
41	5.606G	42	5.558G	43	5.457G	44	5.505G
45	5.664G	46	5.508G	47	5.509G	48	5.549G
49	5.304G	50	5.692G	51	5.633G	52	5.291G
53	5.705G	54	5.425G	55	5.440G	56	5.554G
57	5.553G	58	5.701G	59	5.575G	60	5.407G
61	5.716G	62	5.673G	63	5.478G	64	5.511G
65	5.717G	66	5.601G	67	5.321G	68	5.339G
69	5.341G	70	5.466G	71	5.551G	72	5.308G
73	5.653G	74	5.660G	75	5.363G	76	5.367G
77	5.361G	78	5.417G	79	5.643G	80	5.280G
81	5.513G	82	5.694G	83	5.431G	84	5.640G
85	5.588G	86	5.413G	87	5.288G	88	5.675G
89	5.265G	90	5.630G	91	5.454G	92	5.348G
93	5.318G	94	5.495G	95	5.585G	96	5.634G
97	5.514G	98	5.684G	99	5.310G	100	5.260G

Hopping Frequency Sequence Name: HOP_FREQ_SEQ_15							
SEQ#	Frequency (Hz)	SEQ#	Frequency (Hz)	SEQ#	Frequency (Hz)	SEQ#	Frequency (Hz)
1	5.644G	2	5.696G	3	5.651G	4	5.455G
5	5.631G	6	5.724G	7	5.320G	8	5.558G
9	5.516G	10	5.667G	11	5.709G	12	5.280G
13	5.339G	14	5.443G	15	5.430G	16	5.259G
17	5.682G	18	5.646G	19	5.250G	20	5.414G
21	5.404G	22	5.470G	23	5.479G	24	5.424G
25	5.585G	26	5.672G	27	5.601G	28	5.342G
29	5.472G	30	5.343G	31	5.274G	32	5.596G
33	5.378G	34	5.391G	35	5.477G	36	5.332G
37	5.441G	38	5.480G	39	5.691G	40	5.535G
41	5.493G	42	5.607G	43	5.698G	44	5.273G
45	5.275G	46	5.515G	47	5.305G	48	5.409G
49	5.552G	50	5.400G	51	5.606G	52	5.600G
53	5.504G	54	5.416G	55	5.723G	56	5.525G
57	5.594G	58	5.349G	59	5.616G	60	5.653G
61	5.718G	62	5.512G	63	5.664G	64	5.316G
65	5.360G	66	5.528G	67	5.703G	68	5.678G
69	5.549G	70	5.708G	71	5.555G	72	5.645G
73	5.461G	74	5.679G	75	5.580G	76	5.352G
77	5.562G	78	5.380G	79	5.518G	80	5.714G
81	5.325G	82	5.487G	83	5.573G	84	5.433G
85	5.647G	86	5.629G	87	5.312G	88	5.467G
89	5.717G	90	5.451G	91	5.537G	92	5.622G
93	5.620G	94	5.595G	95	5.499G	96	5.641G
97	5.608G	98	5.435G	99	5.255G	100	5.266G

Hopping Frequency Sequence Name: HOP_FREQ_SEQ_16							
SEQ#	Frequency (Hz)	SEQ#	Frequency (Hz)	SEQ#	Frequency (Hz)	SEQ#	Frequency (Hz)
1	5.287G	2	5.496G	3	5.609G	4	5.328G
5	5.481G	6	5.392G	7	5.659G	8	5.321G
9	5.435G	10	5.627G	11	5.429G	12	5.336G
13	5.683G	14	5.562G	15	5.545G	16	5.657G
17	5.337G	18	5.652G	19	5.408G	20	5.499G
21	5.522G	22	5.568G	23	5.411G	24	5.704G
25	5.300G	26	5.591G	27	5.505G	28	5.356G
29	5.691G	30	5.626G	31	5.468G	32	5.378G
33	5.665G	34	5.460G	35	5.507G	36	5.503G
37	5.587G	38	5.257G	39	5.403G	40	5.513G
41	5.304G	42	5.296G	43	5.483G	44	5.694G
45	5.397G	46	5.316G	47	5.533G	48	5.486G
49	5.309G	50	5.543G	51	5.669G	52	5.449G
53	5.393G	54	5.559G	55	5.305G	56	5.656G
57	5.475G	58	5.590G	59	5.377G	60	5.474G
61	5.711G	62	5.492G	63	5.667G	64	5.534G
65	5.703G	66	5.426G	67	5.325G	68	5.256G
69	5.255G	70	5.320G	71	5.699G	72	5.702G
73	5.398G	74	5.407G	75	5.684G	76	5.352G
77	5.433G	78	5.274G	79	5.323G	80	5.424G
81	5.286G	82	5.472G	83	5.283G	84	5.551G
85	5.353G	86	5.284G	87	5.601G	88	5.277G
89	5.592G	90	5.279G	91	5.289G	92	5.446G
93	5.285G	94	5.618G	95	5.620G	96	5.527G
97	5.389G	98	5.644G	99	5.509G	100	5.417G

Hopping Frequency Sequence Name: HOP_FREQ_SEQ_17							
SEQ#	Frequency (Hz)	SEQ#	Frequency (Hz)	SEQ#	Frequency (Hz)	SEQ#	Frequency (Hz)
1	5.252G	2	5.669G	3	5.387G	4	5.434G
5	5.501G	6	5.299G	7	5.253G	8	5.526G
9	5.521G	10	5.478G	11	5.467G	12	5.543G
13	5.442G	14	5.421G	15	5.513G	16	5.724G
17	5.383G	18	5.313G	19	5.374G	20	5.568G
21	5.295G	22	5.677G	23	5.610G	24	5.350G
25	5.577G	26	5.438G	27	5.321G	28	5.440G
29	5.569G	30	5.430G	31	5.263G	32	5.717G
33	5.475G	34	5.301G	35	5.668G	36	5.591G
37	5.696G	38	5.552G	39	5.258G	40	5.634G
41	5.561G	42	5.536G	43	5.269G	44	5.656G
45	5.632G	46	5.448G	47	5.657G	48	5.450G
49	5.408G	50	5.671G	51	5.279G	52	5.593G
53	5.406G	54	5.680G	55	5.581G	56	5.449G
57	5.481G	58	5.720G	59	5.297G	60	5.548G
61	5.711G	62	5.562G	63	5.709G	64	5.642G
65	5.285G	66	5.510G	67	5.645G	68	5.689G
69	5.444G	70	5.439G	71	5.337G	72	5.403G
73	5.514G	74	5.499G	75	5.410G	76	5.630G
77	5.589G	78	5.588G	79	5.650G	80	5.497G
81	5.564G	82	5.259G	83	5.684G	84	5.692G
85	5.493G	86	5.555G	87	5.356G	88	5.635G
89	5.367G	90	5.703G	91	5.382G	92	5.722G
93	5.546G	94	5.291G	95	5.463G	96	5.676G
97	5.498G	98	5.653G	99	5.614G	100	5.346G

Hopping Frequency Sequence Name: HOP_FREQ_SEQ_18							
SEQ#	Frequency (Hz)	SEQ#	Frequency (Hz)	SEQ#	Frequency (Hz)	SEQ#	Frequency (Hz)
1	5.301G	2	5.269G	3	5.681G	4	5.357G
5	5.286G	6	5.399G	7	5.609G	8	5.709G
9	5.252G	10	5.696G	11	5.724G	12	5.660G
13	5.462G	14	5.282G	15	5.629G	16	5.679G
17	5.389G	18	5.722G	19	5.512G	20	5.555G
21	5.455G	22	5.637G	23	5.698G	24	5.308G
25	5.671G	26	5.710G	27	5.513G	28	5.415G
29	5.720G	30	5.446G	31	5.605G	32	5.384G
33	5.475G	34	5.717G	35	5.299G	36	5.314G
37	5.350G	38	5.659G	39	5.335G	40	5.486G
41	5.257G	42	5.497G	43	5.416G	44	5.615G
45	5.408G	46	5.518G	47	5.349G	48	5.371G
49	5.347G	50	5.448G	51	5.303G	52	5.370G
53	5.427G	54	5.443G	55	5.716G	56	5.431G
57	5.641G	58	5.537G	59	5.267G	60	5.364G
61	5.578G	62	5.561G	63	5.680G	64	5.306G
65	5.393G	66	5.279G	67	5.277G	68	5.409G
69	5.386G	70	5.638G	71	5.396G	72	5.520G
73	5.264G	74	5.723G	75	5.285G	76	5.700G
77	5.292G	78	5.276G	79	5.413G	80	5.406G
81	5.587G	82	5.283G	83	5.387G	84	5.595G
85	5.586G	86	5.483G	87	5.703G	88	5.691G
89	5.529G	90	5.327G	91	5.697G	92	5.582G
93	5.332G	94	5.631G	95	5.345G	96	5.493G
97	5.664G	98	5.665G	99	5.458G	100	5.648G

Hopping Frequency Sequence Name: HOP_FREQ_SEQ_19							
SEQ#	Frequency (Hz)	SEQ#	Frequency (Hz)	SEQ#	Frequency (Hz)	SEQ#	Frequency (Hz)
1	5.396G	2	5.647G	3	5.534G	4	5.434G
5	5.338G	6	5.523G	7	5.282G	8	5.430G
9	5.379G	10	5.252G	11	5.715G	12	5.578G
13	5.500G	14	5.253G	15	5.273G	16	5.553G
17	5.507G	18	5.342G	19	5.660G	20	5.677G
21	5.461G	22	5.713G	23	5.335G	24	5.707G
25	5.445G	26	5.429G	27	5.698G	28	5.334G
29	5.414G	30	5.630G	31	5.555G	32	5.632G
33	5.611G	34	5.387G	35	5.678G	36	5.609G
37	5.384G	38	5.517G	39	5.407G	40	5.450G
41	5.618G	42	5.263G	43	5.724G	44	5.706G
45	5.509G	46	5.409G	47	5.408G	48	5.699G
49	5.531G	50	5.307G	51	5.437G	52	5.302G
53	5.323G	54	5.520G	55	5.369G	56	5.293G
57	5.452G	58	5.376G	59	5.277G	60	5.427G
61	5.602G	62	5.305G	63	5.378G	64	5.413G
65	5.377G	66	5.601G	67	5.289G	68	5.650G
69	5.262G	70	5.484G	71	5.310G	72	5.581G
73	5.708G	74	5.549G	75	5.275G	76	5.638G
77	5.322G	78	5.476G	79	5.410G	80	5.596G
81	5.661G	82	5.634G	83	5.658G	84	5.627G
85	5.501G	86	5.433G	87	5.703G	88	5.512G
89	5.388G	90	5.690G	91	5.691G	92	5.423G
93	5.256G	94	5.296G	95	5.393G	96	5.589G
97	5.485G	98	5.681G	99	5.644G	100	5.568G



Hopping Frequency Sequence Name: HOP_FREQ_SEQ_20							
SEQ#	Frequency (Hz)	SEQ#	Frequency (Hz)	SEQ#	Frequency (Hz)	SEQ#	Frequency (Hz)
1	5.496G	2	5.322G	3	5.373G	4	5.433G
5	5.305G	6	5.417G	7	5.483G	8	5.255G
9	5.484G	10	5.468G	11	5.700G	12	5.448G
13	5.435G	14	5.545G	15	5.470G	16	5.471G
17	5.695G	18	5.371G	19	5.532G	20	5.425G
21	5.375G	22	5.613G	23	5.397G	24	5.595G
25	5.673G	26	5.561G	27	5.321G	28	5.721G
29	5.386G	30	5.259G	31	5.621G	32	5.253G
33	5.515G	34	5.579G	35	5.449G	36	5.412G
37	5.699G	38	5.497G	39	5.564G	40	5.539G
41	5.434G	42	5.421G	43	5.452G	44	5.366G
45	5.600G	46	5.500G	47	5.618G	48	5.682G
49	5.457G	50	5.339G	51	5.535G	52	5.390G
53	5.698G	54	5.608G	55	5.306G	56	5.283G
57	5.540G	58	5.586G	59	5.477G	60	5.430G
61	5.432G	62	5.290G	63	5.475G	64	5.558G
65	5.328G	66	5.460G	67	5.278G	68	5.544G
69	5.605G	70	5.364G	71	5.646G	72	5.588G
73	5.675G	74	5.282G	75	5.405G	76	5.628G
77	5.396G	78	5.347G	79	5.693G	80	5.362G
81	5.369G	82	5.553G	83	5.299G	84	5.383G
85	5.291G	86	5.604G	87	5.592G	88	5.659G
89	5.411G	90	5.407G	91	5.591G	92	5.307G
93	5.261G	94	5.582G	95	5.676G	96	5.549G
97	5.640G	98	5.684G	99	5.719G	100	5.599G

Hopping Frequency Sequence Name: HOP_FREQ_SEQ_21							
SEQ#	Frequency (Hz)	SEQ#	Frequency (Hz)	SEQ#	Frequency (Hz)	SEQ#	Frequency (Hz)
1	5.327G	2	5.648G	3	5.533G	4	5.371G
5	5.675G	6	5.347G	7	5.506G	8	5.373G
9	5.492G	10	5.502G	11	5.711G	12	5.522G
13	5.424G	14	5.518G	15	5.500G	16	5.608G
17	5.618G	18	5.636G	19	5.383G	20	5.363G
21	5.717G	22	5.582G	23	5.289G	24	5.460G
25	5.513G	26	5.712G	27	5.625G	28	5.655G
29	5.434G	30	5.280G	31	5.351G	32	5.251G
33	5.601G	34	5.370G	35	5.544G	36	5.590G
37	5.558G	38	5.334G	39	5.385G	40	5.605G
41	5.692G	42	5.674G	43	5.483G	44	5.268G
45	5.638G	46	5.485G	47	5.342G	48	5.481G
49	5.611G	50	5.704G	51	5.392G	52	5.715G
53	5.445G	54	5.364G	55	5.503G	56	5.315G
57	5.359G	58	5.494G	59	5.321G	60	5.343G
61	5.472G	62	5.594G	63	5.461G	64	5.353G
65	5.344G	66	5.600G	67	5.469G	68	5.453G
69	5.682G	70	5.423G	71	5.458G	72	5.610G
73	5.270G	74	5.496G	75	5.651G	76	5.539G
77	5.419G	78	5.295G	79	5.589G	80	5.578G
81	5.436G	82	5.710G	83	5.258G	84	5.305G
85	5.627G	86	5.318G	87	5.393G	88	5.348G
89	5.380G	90	5.673G	91	5.309G	92	5.658G
93	5.639G	94	5.569G	95	5.663G	96	5.322G
97	5.501G	98	5.484G	99	5.542G	100	5.387G

Hopping Frequency Sequence Name: HOP_FREQ_SEQ_22							
SEQ#	Frequency (Hz)	SEQ#	Frequency (Hz)	SEQ#	Frequency (Hz)	SEQ#	Frequency (Hz)
1	5.712G	2	5.415G	3	5.356G	4	5.488G
5	5.639G	6	5.418G	7	5.673G	8	5.301G
9	5.638G	10	5.289G	11	5.308G	12	5.300G
13	5.551G	14	5.691G	15	5.538G	16	5.428G
17	5.580G	18	5.630G	19	5.506G	20	5.545G
21	5.427G	22	5.522G	23	5.446G	24	5.594G
25	5.295G	26	5.689G	27	5.687G	28	5.675G
29	5.304G	30	5.647G	31	5.286G	32	5.601G
33	5.302G	34	5.321G	35	5.285G	36	5.572G
37	5.636G	38	5.723G	39	5.484G	40	5.568G
41	5.451G	42	5.438G	43	5.371G	44	5.409G
45	5.435G	46	5.702G	47	5.562G	48	5.710G
49	5.408G	50	5.472G	51	5.373G	52	5.510G
53	5.412G	54	5.261G	55	5.462G	56	5.540G
57	5.389G	58	5.424G	59	5.698G	60	5.649G
61	5.650G	62	5.360G	63	5.585G	64	5.688G
65	5.350G	66	5.508G	67	5.507G	68	5.255G
69	5.479G	70	5.543G	71	5.575G	72	5.517G
73	5.516G	74	5.608G	75	5.672G	76	5.692G
77	5.563G	78	5.644G	79	5.588G	80	5.399G
81	5.677G	82	5.431G	83	5.707G	84	5.344G
85	5.296G	86	5.465G	87	5.681G	88	5.716G
89	5.535G	90	5.316G	91	5.463G	92	5.337G
93	5.645G	94	5.680G	95	5.271G	96	5.666G
97	5.573G	98	5.422G	99	5.436G	100	5.656G

Hopping Frequency Sequence Name: HOP_FREQ_SEQ_23							
SEQ#	Frequency (Hz)	SEQ#	Frequency (Hz)	SEQ#	Frequency (Hz)	SEQ#	Frequency (Hz)
1	5.530G	2	5.546G	3	5.706G	4	5.276G
5	5.606G	6	5.268G	7	5.608G	8	5.494G
9	5.617G	10	5.284G	11	5.610G	12	5.392G
13	5.528G	14	5.374G	15	5.252G	16	5.418G
17	5.334G	18	5.313G	19	5.628G	20	5.381G
21	5.467G	22	5.504G	23	5.428G	24	5.416G
25	5.718G	26	5.696G	27	5.382G	28	5.384G
29	5.532G	30	5.266G	31	5.399G	32	5.534G
33	5.326G	34	5.321G	35	5.689G	36	5.676G
37	5.371G	38	5.567G	39	5.666G	40	5.673G
41	5.378G	42	5.622G	43	5.468G	44	5.370G
45	5.437G	46	5.255G	47	5.339G	48	5.615G
49	5.375G	50	5.623G	51	5.335G	52	5.307G
53	5.412G	54	5.274G	55	5.700G	56	5.720G
57	5.415G	58	5.509G	59	5.425G	60	5.447G
61	5.431G	62	5.464G	63	5.357G	64	5.380G
65	5.645G	66	5.656G	67	5.253G	68	5.641G
69	5.651G	70	5.295G	71	5.560G	72	5.547G
73	5.609G	74	5.400G	75	5.292G	76	5.540G
77	5.516G	78	5.492G	79	5.265G	80	5.259G
81	5.340G	82	5.376G	83	5.607G	84	5.330G
85	5.454G	86	5.262G	87	5.383G	88	5.685G
89	5.285G	90	5.424G	91	5.485G	92	5.678G
93	5.496G	94	5.683G	95	5.640G	96	5.438G
97	5.358G	98	5.677G	99	5.395G	100	5.612G

Hopping Frequency Sequence Name: HOP_FREQ_SEQ_24							
SEQ#	Frequency (Hz)	SEQ#	Frequency (Hz)	SEQ#	Frequency (Hz)	SEQ#	Frequency (Hz)
1	5.553G	2	5.678G	3	5.323G	4	5.293G
5	5.283G	6	5.699G	7	5.528G	8	5.339G
9	5.295G	10	5.341G	11	5.487G	12	5.683G
13	5.264G	14	5.636G	15	5.717G	16	5.455G
17	5.491G	18	5.507G	19	5.706G	20	5.694G
21	5.576G	22	5.673G	23	5.587G	24	5.282G
25	5.627G	26	5.356G	27	5.387G	28	5.638G
29	5.418G	30	5.384G	31	5.664G	32	5.252G
33	5.670G	34	5.495G	35	5.479G	36	5.562G
37	5.254G	38	5.429G	39	5.645G	40	5.498G
41	5.710G	42	5.431G	43	5.526G	44	5.406G
45	5.272G	46	5.721G	47	5.413G	48	5.426G
49	5.257G	50	5.359G	51	5.369G	52	5.510G
53	5.421G	54	5.649G	55	5.317G	56	5.616G
57	5.322G	58	5.668G	59	5.458G	60	5.449G
61	5.379G	62	5.697G	63	5.485G	64	5.712G
65	5.367G	66	5.337G	67	5.305G	68	5.657G
69	5.615G	70	5.604G	71	5.350G	72	5.390G
73	5.611G	74	5.493G	75	5.309G	76	5.531G
77	5.681G	78	5.347G	79	5.298G	80	5.643G
81	5.550G	82	5.361G	83	5.292G	84	5.586G
85	5.687G	86	5.435G	87	5.402G	88	5.338G
89	5.266G	90	5.630G	91	5.539G	92	5.549G
93	5.250G	94	5.620G	95	5.417G	96	5.513G
97	5.519G	98	5.352G	99	5.597G	100	5.709G

Hopping Frequency Sequence Name: HOP_FREQ_SEQ_25							
SEQ#	Frequency (Hz)	SEQ#	Frequency (Hz)	SEQ#	Frequency (Hz)	SEQ#	Frequency (Hz)
1	5.426G	2	5.367G	3	5.572G	4	5.539G
5	5.389G	6	5.381G	7	5.315G	8	5.258G
9	5.478G	10	5.543G	11	5.556G	12	5.594G
13	5.610G	14	5.555G	15	5.484G	16	5.391G
17	5.477G	18	5.677G	19	5.611G	20	5.421G
21	5.350G	22	5.281G	23	5.448G	24	5.286G
25	5.713G	26	5.636G	27	5.329G	28	5.282G
29	5.453G	30	5.658G	31	5.427G	32	5.563G
33	5.299G	34	5.601G	35	5.263G	36	5.459G
37	5.515G	38	5.373G	39	5.625G	40	5.369G
41	5.322G	42	5.467G	43	5.509G	44	5.492G
45	5.510G	46	5.644G	47	5.606G	48	5.549G
49	5.649G	50	5.438G	51	5.703G	52	5.648G
53	5.583G	54	5.700G	55	5.551G	56	5.415G
57	5.461G	58	5.680G	59	5.665G	60	5.672G
61	5.432G	62	5.487G	63	5.675G	64	5.257G
65	5.276G	66	5.499G	67	5.527G	68	5.494G
69	5.597G	70	5.615G	71	5.717G	72	5.348G
73	5.707G	74	5.500G	75	5.387G	76	5.557G
77	5.385G	78	5.454G	79	5.674G	80	5.569G
81	5.325G	82	5.252G	83	5.260G	84	5.349G
85	5.502G	86	5.302G	87	5.360G	88	5.542G
89	5.434G	90	5.679G	91	5.702G	92	5.497G
93	5.377G	94	5.704G	95	5.699G	96	5.296G
97	5.433G	98	5.462G	99	5.330G	100	5.429G

Hopping Frequency Sequence Name: HOP_FREQ_SEQ_26							
SEQ#	Frequency (Hz)	SEQ#	Frequency (Hz)	SEQ#	Frequency (Hz)	SEQ#	Frequency (Hz)
1	5.506G	2	5.300G	3	5.393G	4	5.640G
5	5.708G	6	5.305G	7	5.646G	8	5.638G
9	5.654G	10	5.445G	11	5.656G	12	5.485G
13	5.595G	14	5.332G	15	5.498G	16	5.411G
17	5.319G	18	5.525G	19	5.377G	20	5.324G
21	5.624G	22	5.286G	23	5.495G	24	5.699G
25	5.648G	26	5.509G	27	5.316G	28	5.392G
29	5.632G	30	5.398G	31	5.612G	32	5.698G
33	5.352G	34	5.679G	35	5.710G	36	5.582G
37	5.564G	38	5.455G	39	5.330G	40	5.540G
41	5.302G	42	5.408G	43	5.537G	44	5.590G
45	5.523G	46	5.261G	47	5.270G	48	5.644G
49	5.569G	50	5.567G	51	5.326G	52	5.426G
53	5.431G	54	5.616G	55	5.573G	56	5.716G
57	5.592G	58	5.425G	59	5.355G	60	5.721G
61	5.609G	62	5.546G	63	5.467G	64	5.416G
65	5.508G	66	5.441G	67	5.602G	68	5.572G
69	5.382G	70	5.579G	71	5.348G	72	5.313G
73	5.474G	74	5.586G	75	5.694G	76	5.321G
77	5.719G	78	5.461G	79	5.465G	80	5.298G
81	5.594G	82	5.519G	83	5.289G	84	5.282G
85	5.340G	86	5.415G	87	5.559G	88	5.631G
89	5.296G	90	5.545G	91	5.417G	92	5.292G
93	5.442G	94	5.597G	95	5.715G	96	5.577G
97	5.600G	98	5.436G	99	5.310G	100	5.328G

Hopping Frequency Sequence Name: HOP_FREQ_SEQ_27							
SEQ#	Frequency (Hz)	SEQ#	Frequency (Hz)	SEQ#	Frequency (Hz)	SEQ#	Frequency (Hz)
1	5.467G	2	5.503G	3	5.450G	4	5.626G
5	5.352G	6	5.586G	7	5.429G	8	5.525G
9	5.426G	10	5.452G	11	5.675G	12	5.418G
13	5.669G	14	5.530G	15	5.363G	16	5.343G
17	5.475G	18	5.447G	19	5.585G	20	5.338G
21	5.407G	22	5.709G	23	5.607G	24	5.651G
25	5.515G	26	5.333G	27	5.611G	28	5.250G
29	5.491G	30	5.508G	31	5.451G	32	5.266G
33	5.662G	34	5.688G	35	5.710G	36	5.267G
37	5.474G	38	5.488G	39	5.356G	40	5.541G
41	5.357G	42	5.389G	43	5.466G	44	5.584G
45	5.653G	46	5.559G	47	5.561G	48	5.481G
49	5.292G	50	5.521G	51	5.535G	52	5.678G
53	5.630G	54	5.299G	55	5.336G	56	5.422G
57	5.348G	58	5.624G	59	5.698G	60	5.658G
61	5.275G	62	5.287G	63	5.353G	64	5.647G
65	5.312G	66	5.661G	67	5.705G	68	5.563G
69	5.604G	70	5.502G	71	5.595G	72	5.608G
73	5.640G	74	5.270G	75	5.677G	76	5.682G
77	5.690G	78	5.282G	79	5.596G	80	5.649G
81	5.694G	82	5.681G	83	5.372G	84	5.499G
85	5.340G	86	5.364G	87	5.265G	88	5.609G
89	5.713G	90	5.714G	91	5.300G	92	5.519G
93	5.411G	94	5.456G	95	5.673G	96	5.264G
97	5.351G	98	5.457G	99	5.614G	100	5.453G



Hopping Frequency Sequence Name: HOP_FREQ_SEQ_28							
SEQ#	Frequency (Hz)	SEQ#	Frequency (Hz)	SEQ#	Frequency (Hz)	SEQ#	Frequency (Hz)
1	5.417G	2	5.718G	3	5.356G	4	5.275G
5	5.409G	6	5.704G	7	5.315G	8	5.422G
9	5.338G	10	5.464G	11	5.371G	12	5.625G
13	5.647G	14	5.441G	15	5.517G	16	5.397G
17	5.330G	18	5.491G	19	5.380G	20	5.285G
21	5.277G	22	5.713G	23	5.476G	24	5.484G
25	5.516G	26	5.666G	27	5.295G	28	5.313G
29	5.521G	30	5.402G	31	5.327G	32	5.293G
33	5.592G	34	5.446G	35	5.606G	36	5.324G
37	5.573G	38	5.707G	39	5.253G	40	5.415G
41	5.693G	42	5.426G	43	5.582G	44	5.535G
45	5.471G	46	5.256G	47	5.572G	48	5.512G
49	5.691G	50	5.680G	51	5.634G	52	5.716G
53	5.679G	54	5.708G	55	5.414G	56	5.629G
57	5.667G	58	5.437G	59	5.396G	60	5.447G
61	5.509G	62	5.278G	63	5.472G	64	5.542G
65	5.540G	66	5.668G	67	5.351G	68	5.333G
69	5.642G	70	5.251G	71	5.406G	72	5.280G
73	5.263G	74	5.700G	75	5.326G	76	5.258G
77	5.534G	78	5.617G	79	5.527G	80	5.694G
81	5.536G	82	5.539G	83	5.329G	84	5.580G
85	5.382G	86	5.497G	87	5.502G	88	5.418G
89	5.413G	90	5.385G	91	5.404G	92	5.551G
93	5.624G	94	5.607G	95	5.393G	96	5.596G
97	5.421G	98	5.337G	99	5.298G	100	5.643G

Hopping Frequency Sequence Name: HOP_FREQ_SEQ_29							
SEQ#	Frequency (Hz)	SEQ#	Frequency (Hz)	SEQ#	Frequency (Hz)	SEQ#	Frequency (Hz)
1	5.526G	2	5.573G	3	5.283G	4	5.444G
5	5.491G	6	5.365G	7	5.626G	8	5.538G
9	5.438G	10	5.272G	11	5.343G	12	5.322G
13	5.593G	14	5.567G	15	5.629G	16	5.509G
17	5.364G	18	5.638G	19	5.528G	20	5.448G
21	5.611G	22	5.550G	23	5.311G	24	5.383G
25	5.352G	26	5.723G	27	5.659G	28	5.340G
29	5.342G	30	5.583G	31	5.388G	32	5.269G
33	5.298G	34	5.613G	35	5.484G	36	5.532G
37	5.420G	38	5.261G	39	5.669G	40	5.319G
41	5.312G	42	5.451G	43	5.347G	44	5.596G
45	5.323G	46	5.543G	47	5.695G	48	5.472G
49	5.533G	50	5.310G	51	5.577G	52	5.716G
53	5.579G	54	5.482G	55	5.305G	56	5.302G
57	5.485G	58	5.648G	59	5.339G	60	5.591G
61	5.359G	62	5.622G	63	5.710G	64	5.721G
65	5.508G	66	5.422G	67	5.523G	68	5.504G
69	5.569G	70	5.674G	71	5.257G	72	5.262G
73	5.393G	74	5.712G	75	5.266G	76	5.386G
77	5.387G	78	5.418G	79	5.621G	80	5.275G
81	5.353G	82	5.709G	83	5.445G	84	5.551G
85	5.702G	86	5.557G	87	5.501G	88	5.556G
89	5.256G	90	5.454G	91	5.462G	92	5.620G
93	5.529G	94	5.692G	95	5.291G	96	5.612G
97	5.488G	98	5.677G	99	5.446G	100	5.369G

Hopping Frequency Sequence Name: HOP_FREQ_SEQ_30							
SEQ#	Frequency (Hz)	SEQ#	Frequency (Hz)	SEQ#	Frequency (Hz)	SEQ#	Frequency (Hz)
1	5.445G	2	5.440G	3	5.388G	4	5.454G
5	5.310G	6	5.351G	7	5.348G	8	5.282G
9	5.552G	10	5.600G	11	5.516G	12	5.574G
13	5.634G	14	5.257G	15	5.693G	16	5.332G
17	5.458G	18	5.625G	19	5.639G	20	5.320G
21	5.543G	22	5.274G	23	5.400G	24	5.288G
25	5.724G	26	5.712G	27	5.279G	28	5.260G
29	5.477G	30	5.262G	31	5.293G	32	5.592G
33	5.323G	34	5.578G	35	5.313G	36	5.396G
37	5.633G	38	5.534G	39	5.582G	40	5.485G
41	5.519G	42	5.721G	43	5.525G	44	5.665G
45	5.304G	46	5.720G	47	5.453G	48	5.413G
49	5.538G	50	5.294G	51	5.334G	52	5.567G
53	5.460G	54	5.682G	55	5.648G	56	5.342G
57	5.631G	58	5.346G	59	5.503G	60	5.376G
61	5.480G	62	5.659G	63	5.568G	64	5.443G
65	5.524G	66	5.250G	67	5.500G	68	5.505G
69	5.537G	70	5.283G	71	5.493G	72	5.287G
73	5.499G	74	5.455G	75	5.327G	76	5.658G
77	5.667G	78	5.399G	79	5.612G	80	5.606G
81	5.532G	82	5.511G	83	5.284G	84	5.583G
85	5.371G	86	5.422G	87	5.341G	88	5.561G
89	5.278G	90	5.468G	91	5.546G	92	5.647G
93	5.619G	94	5.699G	95	5.307G	96	5.628G
97	5.273G	98	5.614G	99	5.661G	100	5.481G