

FCC Test Report

Report No.: RF141227C17A

FCC ID: 2ACTO-AP100C

Test Model: AP 100C

Received Date: Dec. 27, 2014

Test Date: Jan. 23 ~ May 27, 2015

Issued Date: May 27, 2015

Applicant: Sophos Ltd

Address: The Pentagon, Abingdon, OX14 3YP, United Kingdom

Issued By: Bureau Veritas Consumer Products Services (H.K.) Ltd., Taoyuan Branch

Lab Address: No. 47-2, 14th Ling, Chia Pau Vil., Lin Kou Dist., New Taipei City, Taiwan

Test Location: No. 19, Hwa Ya 2nd Rd., Wen Hwa Vil., Kwei Shan Dist., Taoyuan City 33383, TAIWAN (R.O.C.)



This report is for your exclusive use. Any copying or replication of this report to or for any other person or entity, or use of our name or trademark, is permitted only with our prior written permission. This report sets forth our findings solely with respect to the test samples identified herein. The results set forth in this report are not indicative or representative of the quality or characteristics of the lot from which a test sample was taken or any similar or identical product unless specifically and expressly noted. Our report includes all of the tests requested by you and the results thereof based upon the information that you provided to us. You have 60 days from date of issuance of this report to notify us of any material error or omission caused by our negligence, provided, however, that such notice shall be in writing and shall specifically address the issue you wish to raise. A failure to raise such issue within the prescribed time shall constitute your unqualified acceptance of the completeness of this report, the tests conducted and the correctness of the report contents. Unless specifically mentioned, the uncertainty of measurement has been explicitly taken into account to declare the compliance or non-compliance to the specification. The report must not be used by the client to claim product certification, approval, or endorsement by TAF or any government agencies.



Table of Contents

Release Control Record	4
1 Certificate of Conformity	5
2 Summary of Test Results	6
2.1 Measurement Uncertainty	6
2.2 Modification Record	6
3 General Information	7
3.1 General Description of EUT	7
3.2 Description of Test Modes	10
3.2.1 Test Mode Applicability and Tested Channel Detail.....	11
3.3 Duty Cycle of Test Signal	14
3.4 Description of Support Units	16
3.4.1 Configuration of System under Test	17
3.5 General Description of Applied Standard.....	18
4 Test Types and Results	19
4.1 Radiated Emission and Bandedge Measurement.....	19
4.1.1 Limits of Radiated Emission and Bandedge Measurement	19
4.1.2 Test Instruments	20
4.1.3 Test Procedure	21
4.1.4 Deviation from Test Standard	21
4.1.5 Test Setup.....	22
4.1.6 EUT Operating Condition	22
4.1.7 Test Results	23
4.2 Conducted Emission Measurement	79
4.2.1 Limits of Conducted Emission Measurement	79
4.2.2 Test Instruments	79
4.2.3 Test Procedure	80
4.2.4 Deviation from Test Standard	80
4.2.5 Test Setup.....	80
4.2.6 EUT Operating Condition	80
4.2.7 Test Results	81
4.3 Transmit Power Measurement	85
4.3.1 Limits of Transmit Power Measurement	85
4.3.2 Test Setup.....	85
4.3.3 Test Instruments	85
4.3.4 Test Procedure	86
4.3.5 Deviation from Test Standard	86
4.3.6 EUT Operating Conditions.....	86
4.3.7 Test Result.....	87
4.4 Peak Power Spectral Density Measurement	105
4.4.1 Limits of Peak Power Spectral Density Measurement	105
4.4.2 Test Setup.....	105
4.4.3 Test Instruments	105
4.4.4 Test Procedure	105
4.4.5 Deviation from Test Standard	105
4.4.6 EUT Operating Condition	105
4.4.7 Test Results	106
4.5 Frequency Stability Measurement	113
4.5.1 Limits of Frequency Stability Measurement	113
4.5.2 Test Setup.....	113
4.5.3 Test Instruments	113
4.5.4 Test Procedure	113
4.5.5 Deviation from Test Standard	113
4.5.6 EUT Operating Condition	113



4.5.7 Test Results 114

5 Pictures of Test Arrangements.....115

Appendix – Information on the Testing Laboratories116



A D T

Release Control Record

Issue No.	Description	Date Issued
RF141227C17A	Original release.	May 27, 2015

1 Certificate of Conformity

Product: Sophos wireless Access Point AP 100C

Brand: Sophos

Test Model: AP 100C

Sample Status: Engineering sample

Applicant: Sophos Ltd

Test Date: Jan. 23 ~ May 27, 2015

Standard: 47 CFR FCC Part 15, Subpart E (Section 15.407)
ANSI C63.10:2009

The above equipment has been tested by **Bureau Veritas Consumer Products Services (H.K.) Ltd., Taoyuan Branch**, and found compliance with the requirement of the above standards. The test record, data evaluation & Equipment Under Test (EUT) configurations represented herein are true and accurate accounts of the measurements of the sample's EMC characteristics under the conditions specified in this report.

Prepared by :  _____, **Date:** _____ May 27, 2015
Pettie Chen / Senior Specialist

Approved by :  _____, **Date:** _____ May 27, 2015
Ken Liu / Senior Manager

2 Summary of Test Results

47 CFR FCC Part 15, Subpart E (SECTION 15.407)			
FCC Clause	Test Item	Result	Remarks
15.407(b)(6)	AC Power Conducted Emissions	PASS	Meet the requirement of limit. Minimum passing margin is -15.73dB at 0.49735MHz.
15.407(b) (1/2/3/4/6)	Radiated Emissions & Band Edge Measurement	PASS	Meet the requirement of limit. Minimum passing margin is -1.0dB at 5350.00, 5470.00, 11000.00, 11160.00MHz.
15.407(a)(1/2 /3)	Max Average Transmit Power	PASS	Meet the requirement of limit.
15.407(a)(1/2 /3)	Peak Power Spectral Density	PASS	Meet the requirement of limit.
15.407(g)	Frequency Stability	PASS	Meet the requirement of limit.
15.203	Antenna Requirement	PASS	Ant. D, E: No antenna connector is used. Ant. F: Antenna connector is I-PEX not a standard connector.

2.1 Measurement Uncertainty

Where relevant, the following measurement uncertainty levels have been estimated for tests performed on the EUT as specified in CISPR 16-4-2:

Measurement	Frequency	Expanded Uncertainty (k=2) (±)
Conducted Emissions at mains ports	150kHz ~ 30MHz	2.44 dB
Radiated Emissions up to 1 GHz	30MHz ~ 200MHz	3.63 dB
	200MHz ~ 1000MHz	3.64 dB
Radiated Emissions above 1 GHz	1GHz ~ 18GHz	2.29 dB
	18GHz ~ 40GHz	2.29 dB

2.2 Modification Record

There were no modifications required for compliance.

3 General Information

3.1 General Description of EUT

Product	Sophos wireless Access Point AP 100C
Brand	Sophos
Test Model	AP 100C
Status of EUT	Engineering sample
Power Supply Rating	12Vdc (adapter) 55Vdc (PoE)
Modulation Type	256QAM, 64QAM, 16QAM, QPSK, BPSK
Modulation Technology	OFDM
Transfer Rate	802.11a: 54.0/ 48.0/ 36.0/ 24.0/ 18.0/ 12.0/ 9.0/ 6.0Mbps 802.11n: up to 450.0Mbps 802.11ac: up to 1300Mbps
Operating Frequency	5260 ~ 5320MHz & 5500 ~ 5700MHz
Number of Channel	5260 ~ 5320MHz: 4 for 802.11a, 802.11n (HT20), 802.11ac (VHT20) 2 for 802.11n (HT40), 802.11ac (VHT40) 1 for 802.11ac (VHT80) 5500 ~ 5700MHz: 8 for 802.11a, 802.11n (HT20), 802.11ac (VHT20) 3 for 802.11n (HT40), 802.11ac (VHT40) 1 for 802.11ac (VHT80)
Output Power	1TX: 802.11a: 5260 ~ 5320MHz: 238.232mW 5500 ~ 5700MHz: 131.522mW 2TX: 802.11n (HT20): 5260 ~ 5320MHz: 231.677mW 5500 ~ 5700MHz: 235.271mW 802.11n (HT40): 5260 ~ 5320MHz: 200.234mW 5500 ~ 5700MHz: 214.161mW 802.11ac (VHT20): 5260 ~ 5320MHz: 229.147mW 5500 ~ 5700MHz: 239.777mW 802.11ac (VHT40): 5260 ~ 5320MHz: 200.237mW 5500 ~ 5700MHz: 215.108mW 802.11ac (VHT80): 5260 ~ 5320MHz: 128.982mW 5500 ~ 5700MHz: 76.715mW

Output Power	3TX: 802.11n (HT20): 5260 ~ 5320MHz: 101.608mW 5500 ~ 5700MHz: 101.902mW 802.11n (HT40): 5260 ~ 5320MHz: 199.282mW 5500 ~ 5700MHz: 191.394mW 802.11ac (VHT20): 5260 ~ 5320MHz: 98.321mW 5500 ~ 5700MHz: 102.578mW 802.11ac (VHT40): 5260 ~ 5320MHz: 196.299mW 5500 ~ 5700MHz: 194.075mW 802.11ac (VHT80): 5260 ~ 5320MHz: 83.442mW 5500 ~ 5700MHz: 66.455mW
Antenna Type	Refer to Note
Antenna Connector	Refer to Note
Accessory Device	NA
Data Cable Supplied	NA

Note:

- This report is prepared for FCC class II permissive change. This report is issued as a supplementary report to BV ADT report no. RF141227C17-1. Differences compared with the original report are adding 5260~5320MHz and 5500~5700MHz band and a PoE for support unit. Therefore, the EUT was re-tested and presented in the test report.
- The EUT incorporates a MIMO function. Physically, the EUT provides 3 completed transmitters and 3 receivers.

Modulation Mode	TX FUNCTION
802.11a	1TX (Ant. D)
802.11n (HT20)	2TX/3TX
802.11n (HT40)	2TX/3TX
802.11ac (VHT20)	2TX/3TX
802.11ac (VHT40)	2TX/3TX
802.11ac (VHT80)	2TX/3TX

*The EUT doesn't support diversity function in 802.11a and 2TX of 802.11n (HT20), 802.11n (HT40), 802.11ac (VHT20), 802.11ac (VHT40) & 802.11ac (VHT80).

*For 802.11a was fixed in Antenna D.

*For 2TX of 802.11n (HT20), 802.11n (HT40), 802.11ac (VHT20), 802.11ac (VHT40) & 802.11ac (VHT80) were fixed in Antenna D & E

*The EUT doesn't support beamforming function.

- The EUT uses following adapter and PoE.

Adapter (Support unit only)	
Brand	Asian Power Devices Inc.
Model	WA-18Q12R
Input Power	100-240Vac ~50-60Hz 0.5A Max.
Output Power	12Vdc / 1.5A
Power Line	1.5m cable without core

PoE (Support unit only)	
Brand	PowerDesine
Model	PD-9001GR/AC
Input Power	100-240Vac~50-60Hz, 0.67A
Output Power	55Vdc, 0.6A

4. The following antennas were provided to the EUT.

Antenna Type	P/N	Gain (dBi)	Antenna Connector
Ant. D	RFMTA100800NN5B001	6.13	NA
Ant. E	RFMTA100800NN5B002	5.96	NA
Ant. F	RFMTA150719IM5B301	6.27	I-PEX

5. The above EUT information is declared by manufacturer and for more detailed features description, please refer to the manufacturer's specifications or user's manual.

3.2 Description of Test Modes

FOR 5260 ~ 5320MHz

4 channels are provided for 802.11a, 802.11n (HT20), 802.11ac (VHT20):

Channel	Frequency	Channel	Frequency
52	5260 MHz	60	5300 MHz
56	5280 MHz	64	5320 MHz

2 channels are provided for 802.11n (HT40), 802.11ac (VHT40):

Channel	Frequency	Channel	Frequency
54	5270 MHz	62	5310 MHz

1 channel is provided for 802.11ac (VHT80):

Channel	Frequency
58	5290MHz

FOR 5500 ~ 5700MHz

8 channels are provided for 802.11a, 802.11n (HT20), 802.11ac (VHT20):

Channel	Frequency	Channel	Frequency
100	5500 MHz	116	5580 MHz
104	5520 MHz	132	5660 MHz
108	5540 MHz	136	5680 MHz
112	5560 MHz	140	5700 MHz

3 channels are provided for 802.11n (HT40), 802.11ac (VHT40):

Channel	Frequency	Channel	Frequency
102	5510 MHz	134	5670 MHz
110	5550 MHz		

1 channel is provided for 802.11ac (VHT80):

Channel	Frequency
106	5530MHz

3.2.1 Test Mode Applicability and Tested Channel Detail

EUT CONFIGURE MODE	APPLICABLE TO				DESCRIPTION
	RE \geq 1G	RE $<$ 1G	PLC	APCM	
A	√	√	√	√	Power from Adapter
B	-	√	√	-	Power from PoE

Where **RE \geq 1G**: Radiated Emission above 1GHz **RE $<$ 1G**: Radiated Emission below 1GHz
PLC: Power Line Conducted Emission **APCM**: Antenna Port Conducted Measurement

Note: 1. The EUT had been pre-tested on the positioned of each 3 axis. The worst case was found when positioned on **Z-plane**.
 2. "-" means no effect.

Radiated Emission Test (Above 1GHz):

- Pre-Scan has been conducted to determine the worst-case mode from all possible combinations between available modulations, data rates and antenna ports (if EUT with antenna diversity architecture).
- Following channel(s) was (were) selected for the final test as listed below.

EUT CONFIGURE MODE	MODE	FREQ. BAND (MHz)	AVAILABLE CHANNEL	TESTED CHANNEL	MODULATION TECHNOLOGY	MODULATION TYPE	DATA RATE (Mbps)	TX FUNCTION
A	802.11a	5260-5320	52 to 64	52, 60, 64	OFDM	BPSK	6.0	1TX
A	802.11n (HT20)		52 to 64	52, 60, 64	OFDM	BPSK	6.5	2TX/3TX
A	802.11n (HT40)		54 to 62	54, 62	OFDM	BPSK	13.5	2TX/3TX
A	802.11ac (VHT20)		52 to 64	52, 60, 64	OFDM	BPSK	13.0	2TX
A			52 to 64	52, 60, 64	OFDM	BPSK	19.5	3TX
A	802.11ac (VHT40)		54 to 62	54, 62	OFDM	BPSK	27.0	2TX
A			54 to 62	54, 62	OFDM	BPSK	40.5	3TX
A	802.11ac (VHT80)		58	58	OFDM	BPSK	58.5	2TX
A			58	58	OFDM	BPSK	87.5	3TX
A	802.11a		5500-5700	100 to 140	100, 116, 140	OFDM	BPSK	6.0
A	802.11n (HT20)	100 to 140		100, 116, 140	OFDM	BPSK	6.5	2TX/3TX
A	802.11n (HT40)	102 to 134		102, 110, 134	OFDM	BPSK	13.5	2TX/3TX
A	802.11ac (VHT20)	100 to 140		100, 116, 140	OFDM	BPSK	13.0	2TX
A		100 to 140		100, 116, 140	OFDM	BPSK	19.5	3TX
A	802.11ac (VHT40)	102 to 134		102, 110, 134	OFDM	BPSK	27.0	2TX
A		102 to 134		102, 110, 134	OFDM	BPSK	40.5	3TX
A	802.11ac (VHT80)	106		106	OFDM	BPSK	58.5	2TX
A		106		106	OFDM	BPSK	87.5	3TX

Radiated Emission Test (Below 1GHz):

- Pre-Scan has been conducted to determine the worst-case mode from all possible combinations between available modulations, data rates and antenna ports (if EUT with antenna diversity architecture).
- Following channel(s) was (were) selected for the final test as listed below.

EUT CONFIGURE MODE	MODE	FREQ. BAND (MHz)	AVAILABLE CHANNEL	TESTED CHANNEL	MODULATION TECHNOLOGY	MODULATION TYPE	DATA RATE (Mbps)	TX FUNCTION
A, B	802.11a	5260-5320	52 to 64	64	OFDM	BPSK	6.0	1TX
	802.11a	5500-5700	100 to 140		OFDM	BPSK	6.0	1TX

Power Line Conducted Emission Test:

- Pre-Scan has been conducted to determine the worst-case mode from all possible combinations between available modulations, data rates and antenna ports (if EUT with antenna diversity architecture).
- Following channel(s) was (were) selected for the final test as listed below.

EUT CONFIGURE MODE	MODE	FREQ. BAND (MHz)	AVAILABLE CHANNEL	TESTED CHANNEL	MODULATION TECHNOLOGY	MODULATION TYPE	DATA RATE (Mbps)	TX FUNCTION
A, B	802.11a	5260-5320	52 to 64	64	OFDM	BPSK	6.0	1TX
	802.11a	5500-5700	100 to 140		OFDM	BPSK	6.0	1TX

Antenna Port Conducted Measurement:

- This item includes all test value of each mode, but only includes spectrum plot of worst value of each mode.
- Pre-Scan has been conducted to determine the worst-case mode from all possible combinations between available modulations, data rates and antenna ports (if EUT with antenna diversity architecture).
- Following channel(s) was (were) selected for the final test as listed below.

EUT CONFIGURE MODE	MODE	FREQ. BAND (MHz)	AVAILABLE CHANNEL	TESTED CHANNEL	MODULATION TECHNOLOGY	MODULATION TYPE	DATA RATE (Mbps)	TX FUNCTION
A	802.11a	5260-5320	52 to 64	52, 60, 64	OFDM	BPSK	6.0	1TX
A	802.11n (HT20)		52 to 64	52, 60, 64	OFDM	BPSK	6.5	2TX/3TX
A	802.11n (HT40)		54 to 62	54, 62	OFDM	BPSK	13.5	2TX/3TX
A	802.11ac (VHT20)		52 to 64	52, 60, 64	OFDM	BPSK	13.0	2TX
A			52 to 64	52, 60, 64	OFDM	BPSK	19.5	3TX
A	802.11ac (VHT40)		54 to 62	54, 62	OFDM	BPSK	27.0	2TX
A			54 to 62	54, 62	OFDM	BPSK	40.5	3TX
A	802.11ac (VHT80)		58	58	OFDM	BPSK	58.5	2TX
A			58	58	OFDM	BPSK	87.5	3TX
A	802.11a		5500-5700	100 to 140	100, 116, 140	OFDM	BPSK	6.0
A	802.11n (HT20)	100 to 140		100, 116, 140	OFDM	BPSK	6.5	2TX/3TX
A	802.11n (HT40)	102 to 134		102, 110, 134	OFDM	BPSK	13.5	2TX/3TX
A	802.11ac (VHT20)	100 to 140		100, 116, 140	OFDM	BPSK	13.0	2TX
A		100 to 140		100, 116, 140	OFDM	BPSK	19.5	3TX
A	802.11ac (VHT40)	102 to 134		102, 110, 134	OFDM	BPSK	27.0	2TX
A		102 to 134		102, 110, 134	OFDM	BPSK	40.5	3TX
A	802.11ac (VHT80)	106		106	OFDM	BPSK	58.5	2TX
A		106		106	OFDM	BPSK	87.5	3TX

Test Condition:

APPLICABLE TO	ENVIRONMENTAL CONDITIONS	INPUT POWER	TESTED BY
RE≥1G	25deg. C, 60%RH	120Vac, 60Hz	Tank Wu
RE<1G	25deg. C, 60%RH	120Vac, 60Hz 55Vdc	Match Tsui
PLC	25deg. C, 64%RH	120Vac, 60Hz 55Vdc	Match Tsui
APCM	25deg. C, 60%RH	120Vac, 60Hz	Antony Lee

3.3 Duty Cycle of Test Signal

Duty cycle of test signal is $\geq 98\%$, duty factor is not required.

- 802.11a_1TX: Duty cycle = $23.987/24.087 = 0.996$
- 802.11n (HT20)_2TX: Duty cycle = $23.799/23.912 = 0.995$
- 802.11n (HT40)_2TX: Duty cycle = $23.862/23.974 = 0.995$
- 802.11ac (VHT20)_2TX: Duty cycle = $23.949/24.037 = 0.996$
- 802.11ac (VHT40)_2TX: Duty cycle = $23.9/24.012 = 0.995$
- 802.11ac (VHT80)_2TX: Duty cycle = $23.937/24.074 = 0.994$
- 802.11n (HT20)_3TX: Duty cycle = $23.875/23.962 = 0.996$
- 802.11n (HT40)_3TX: Duty cycle = $23.863/23.975 = 0.995$
- 802.11ac (VHT20)_3TX: Duty cycle = $23.9/23.987 = 0.996$
- 802.11ac (VHT40)_3TX: Duty cycle = $23.888/23.988 = 0.996$
- 802.11ac (VHT80)_3TX: Duty cycle = $23.787/23.962 = 0.993$

802.11a_1TX **802.11n (HT20)_2TX**

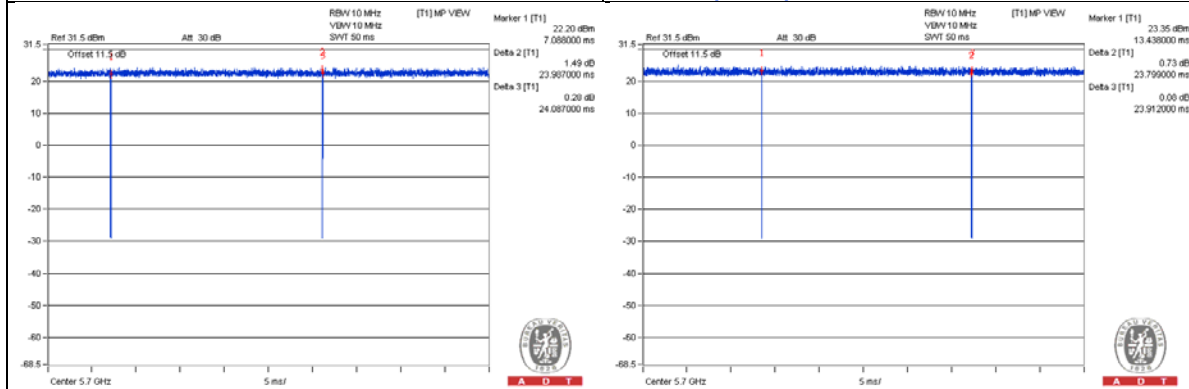

802.11n (HT40)_2TX **802.11ac (VHT20)_2TX**

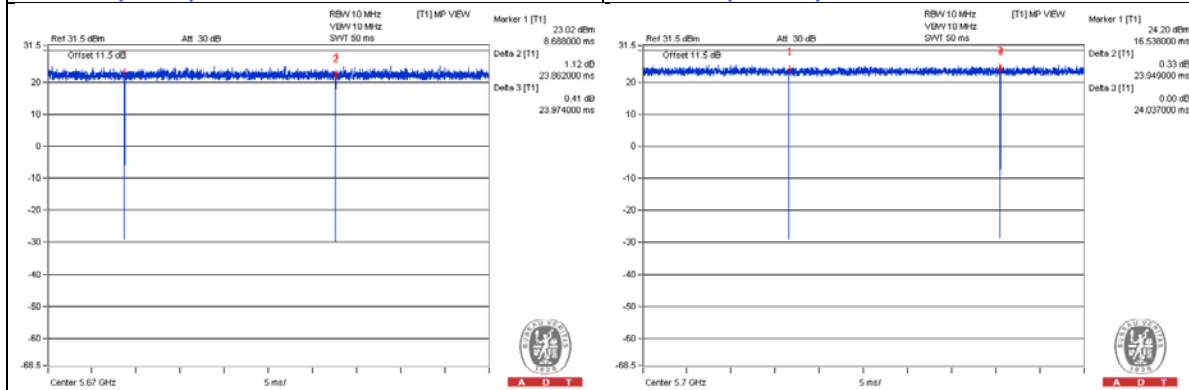

802.11ac (VHT40)_2TX **802.11ac (VHT80)_2TX**

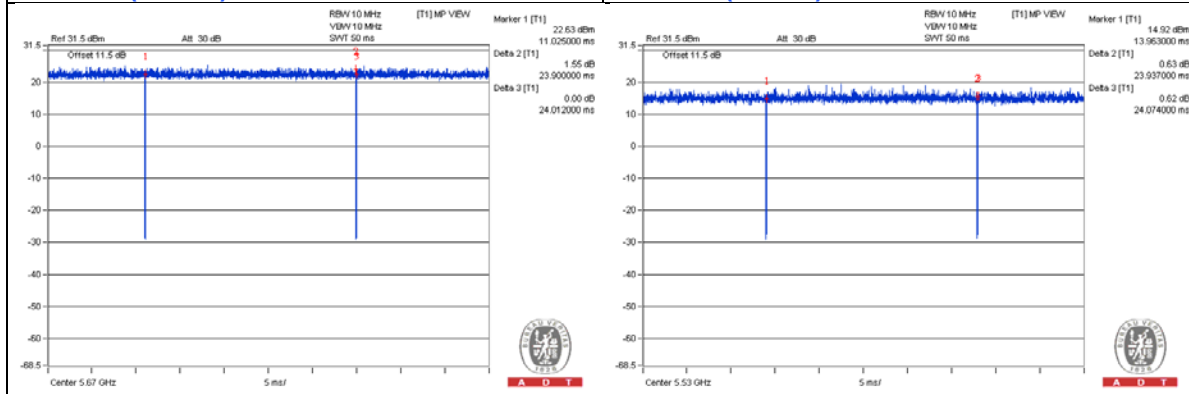

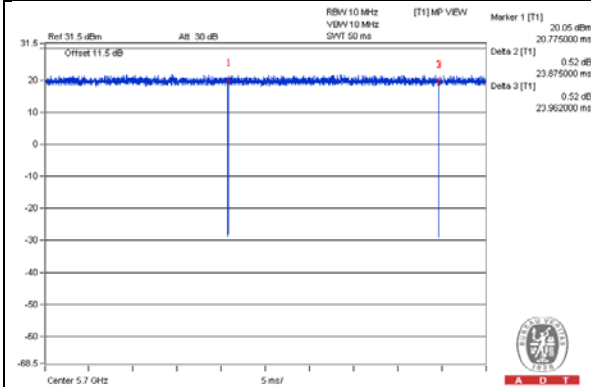
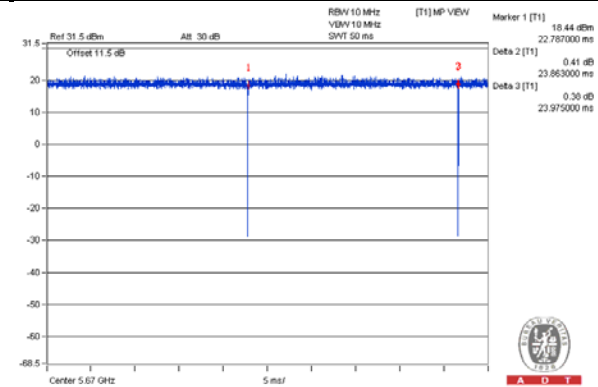
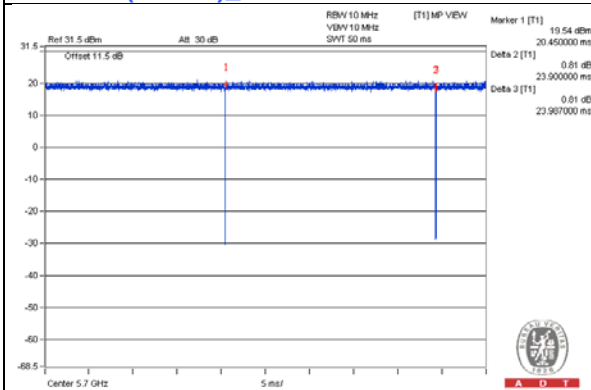
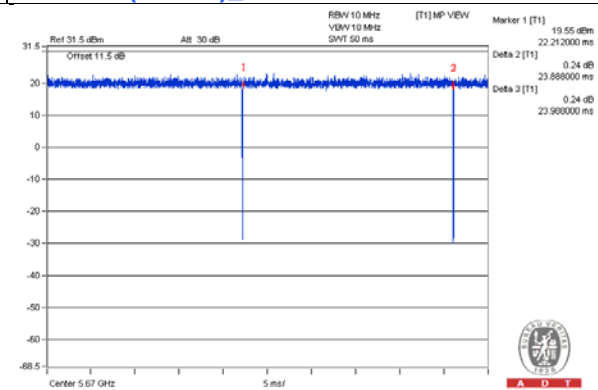
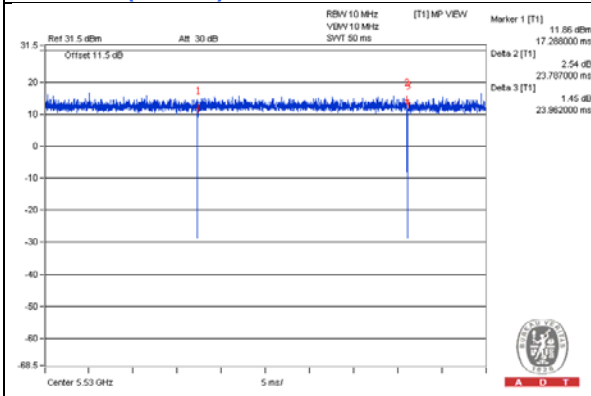
802.11n (HT20)_3TX**802.11n (HT40)_3TX****802.11ac (VHT20)_3TX****802.11ac (VHT40)_3TX****802.11ac (VHT80)_3TX**

3.4 Description of Support Units

The EUT has been tested as an independent unit together with other necessary accessories or support units. The following support units or accessories were used to form a representative test configuration during the tests.

ID	Product	Brand	Model No.	Serial No.	FCC ID	Remarks
A.	Notebook	DELL	E5410	1HC2XM1	FCC DoC Approved	-
B.	Adapter	Asian Power Devices Inc.	WA-18Q12R	NA	NA	Provided by client.

Note:

1. All power cords of the above support units are non-shielded (1.8m).
2. Item A acted as communication partners to transfer data.

ID	Descriptions	Qty.	Length (m)	Shielding (Yes/No)	Cores (Qty.)	Remarks
1.	RJ 45 cable	1	10	N	0	-

Note: The core(s) is(are) originally attached to the cable(s).

3.4.1 Configuration of System under Test

Test Mode A

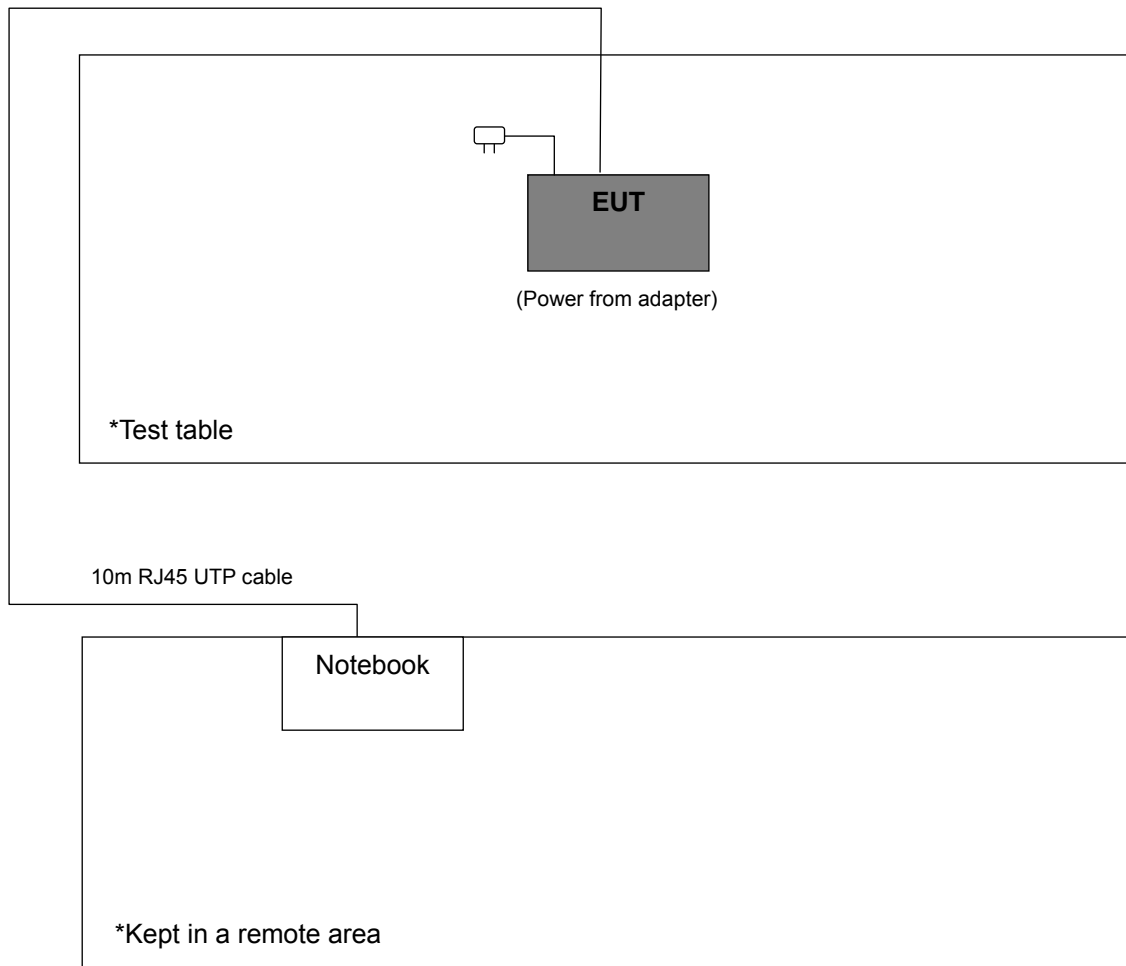

Test Mode B

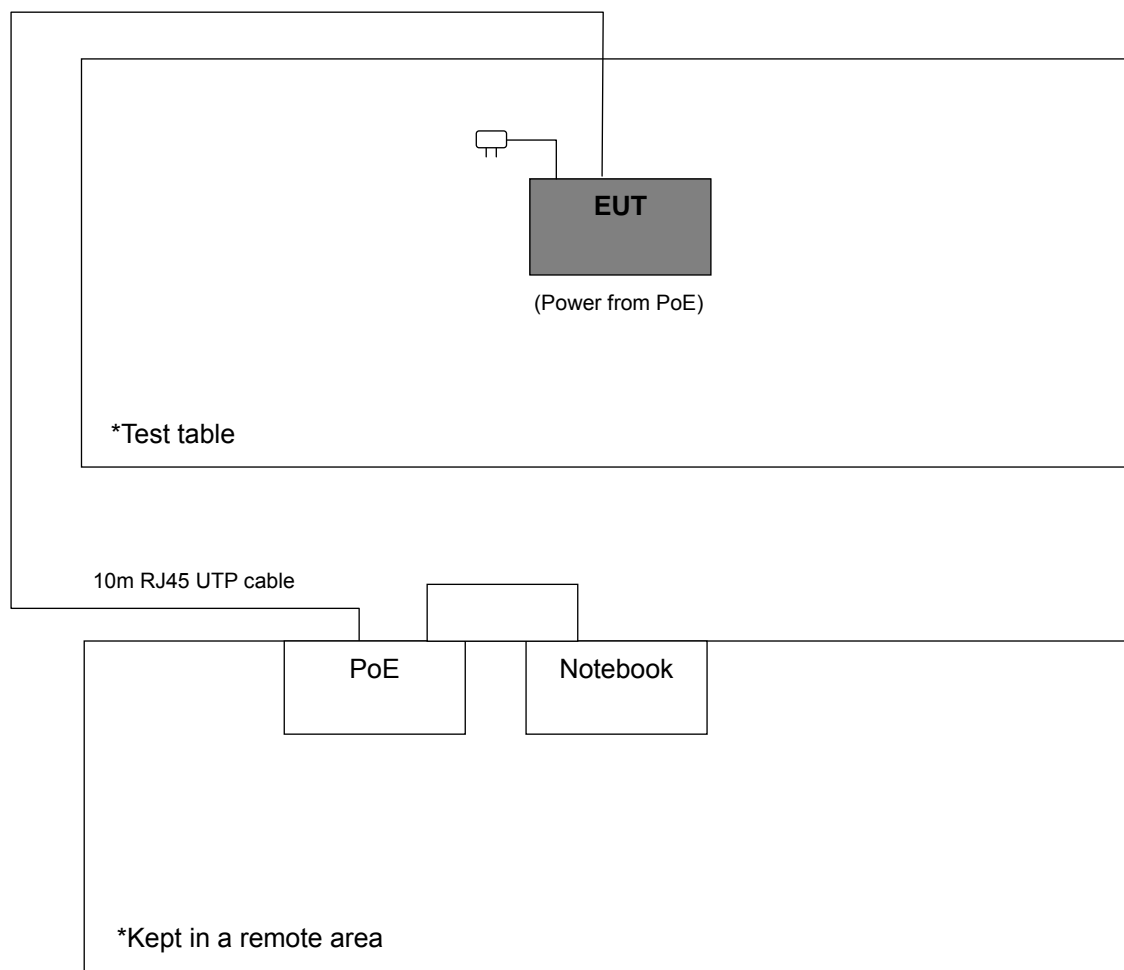

3.5 General Description of Applied Standard

The EUT is a RF Product. According to the specifications of the manufacturer, it must comply with the requirements of the following standards:

FCC Part 15, Subpart E (15.407)
789033 D02 General UNII Test Procedure New Rules v01
662911 D01 Multiple Transmitter Output v02r01
ANSI C63.10-2009

All test items have been performed and recorded as per the above standards.

NOTE: The EUT is also considered as a kind of computer peripheral, because the connection to computer is necessary for typical use. It has been verified to comply with the requirements of FCC Part 15, Subpart B, Class B (DoC). The test report has been issued separately.

4 Test Types and Results

4.1 Radiated Emission and Bandedge Measurement

4.1.1 Limits of Radiated Emission and Bandedge Measurement

Radiated emissions which fall in the restricted bands must comply with the radiated emission limits specified as below table.

Frequencies (MHz)	Field Strength (microvolts/meter)	Measurement Distance (meters)
0.009 ~ 0.490	2400/F(kHz)	300
0.490 ~ 1.705	24000/F(kHz)	30
1.705 ~ 30.0	30	30
30 ~ 88	100	3
88 ~ 216	150	3
216 ~ 960	200	3
Above 960	500	3

NOTE:

1. The lower limit shall apply at the transition frequencies.
2. Emission level (dBuV/m) = 20 log Emission level (uV/m).
3. For frequencies above 1000MHz, the field strength limits are based on average detector, however, the peak field strength of any emission shall not exceed the maximum permitted average limits, specified above by more than 20dB under any condition of modulation.

LIMITS OF UNWANTED EMISSION OUT OF THE RESTRICTED BANDS

APPLICABLE TO	LIMIT	
789033 D02 General UNII Test Procedure New Rules v01	FIELD STRENGTH AT 3m	
	PK:74 (dBuV/m)	AV:54 (dBuV/m)
APPLICABLE TO	EIRP LIMIT	EQUIVALENT FIELD STRENGTH AT 3m
15.407(b)(1)	PK:-27 (dBm/MHz)	PK:68.2(dBuV/m)
15.407(b)(2)		
15.407(b)(3)		
15.407(b)(4)	PK:-27 (dBm/MHz) ^{*1} PK:-17 (dBm/MHz) ^{*2}	PK: 68.2(dBuV/m) ^{*1} PK:78.2 (dBuV/m) ^{*2}

NOTE: The following formula is used to convert the equipment isotropic radiated power (eirp) to field strength:

$$E = \frac{1000000\sqrt{30P}}{3} \mu\text{V/m, where } P \text{ is the eirp (Watts).}$$

4.1.2 Test Instruments

Description & Manufacturer	Model No.	Serial No.	Date Of Calibration	Due Date Of Calibration
Test Receiver ROHDE & SCHWARZ	ESCS30	100289	Dec. 01, 2014	Nov. 30, 2015
Spectrum Analyzer ROHDE & SCHWARZ	E4446A	MY51100039	Aug. 18, 2014	Aug. 17, 2015
BILOG Antenna SCHWARZBECK	VULB9168	9168-156	Feb. 27, 2014	Feb. 26, 2015
			Feb. 06, 2015	Feb. 05, 2016
HORN Antenna SCHWARZBECK	BBHA 9120 D	9120D-1169	Aug. 26, 2014	Feb. 08, 2016
			Feb. 09, 2015	Feb. 08, 2016
HORN Antenna SCHWARZBECK	BBHA 9170	BBHA9170241	Feb. 17, 2014	Feb. 16, 2015
			Feb. 09, 2015	Feb. 08, 2016
Preamplifier Agilent	8449B	3008A01911	Aug. 09, 2014	Aug. 08, 2015
Preamplifier Agilent	8447D	2944A10638	Aug. 09, 2014	Aug. 08, 2015
RF signal cable HUBER+SUHNNER	SUCOFLEX 104	248780/4 309222/4 274092/4	Aug. 09, 2014	Aug. 08, 2015
RF signal cable Worken	8D-FB	Cable-CH9-01	Aug. 11, 2014	Aug. 10, 2015
Software BV ADT	ADT_Radiated_ V7.6.15.9.4	NA	NA	NA
Antenna Tower EMCO	2070/2080	512.835.4684	NA	NA
Turn Table EMCO	2087-2.03	NA	NA	NA
Antenna Tower & Turn Table Controller EMCO	2090	NA	NA	NA
High Speed Peak Power Meter	ML2495A	0824011	Jul. 26, 2014	Jul. 25, 2015
Power Sensor	MA2411B	0738171	Jul. 26, 2014	Jul. 25, 2015
WIT Standard Temperature And Humidity Chamber	TH-4S-C	W981030	Jun. 09, 2014	Jun. 08, 2015

- NOTE: 1. The calibration interval of the above test instruments is 12 months and the calibrations are traceable to NML/ROC and NIST/USA.
2. The test was performed in HwaYa Chamber 9.
3. The horn antenna and HP preamplifier (model: 8449B) are used only for the measurement of emission frequency above 1GHz if tested.
4. The FCC Site Registration No. is 215374.
5. The IC Site Registration No. is IC 7450F-9.

4.1.3 Test Procedure

- a. The EUT was placed on the top of a rotating table 0.8 meters above the ground at 3 meter chamber room for test. The table was rotated 360 degrees to determine the position of the highest radiation.
- b. The EUT was set 3 meters away from the interference-receiving antenna, which was mounted on the top of a variable-height antenna tower.
- c. The height of antenna is varied from one meter to four meters above the ground to determine the maximum value of the field strength. Both horizontal and vertical polarizations of the antenna are set to make the measurement.
- d. For each suspected emission, the EUT was arranged to its worst case and then the antenna was tuned to heights from 1 meter to 4 meters and the rotatable table was turned from 0 degrees to 360 degrees to find the maximum reading.
- e. The test-receiver system was set to quasi-peak detect function and specified bandwidth with maximum hold mode when the test frequency is below 1 GHz.
- f. The test-receiver system was set to peak and average detect function and specified bandwidth with maximum hold mode when the test frequency is above 1 GHz. If the peak reading value also meets average limit, measurement with the average detector is unnecessary.

Note:

1. The resolution bandwidth and video bandwidth of test receiver/spectrum analyzer is 120kHz for Quasi-peak detection (QP) at frequency below 1GHz.
2. The resolution bandwidth of test receiver/spectrum analyzer is 1 MHz and the video bandwidth is 3 MHz for Peak detection (PK) at frequency above 1GHz.
3. The resolution bandwidth of test receiver/spectrum analyzer is 1MHz and the video bandwidth is 3MHz for RMS Average (Duty cycle < 98%) for Average detection (AV) at frequency above 1GHz, then the measurement results was added to a correction factor ($10 \log(1/\text{duty cycle})$).
4. The resolution bandwidth of test receiver/spectrum analyzer is 1MHz and the video bandwidth is 10Hz (Duty cycle $\geq 98\%$) for Average detection (AV) at frequency above 1GHz.
5. All modes of operation were investigated and the worst-case emissions are reported.

4.1.4 Deviation from Test Standard

No deviation.

4.1.5 Test Setup

<Frequency Range below 1GHz>

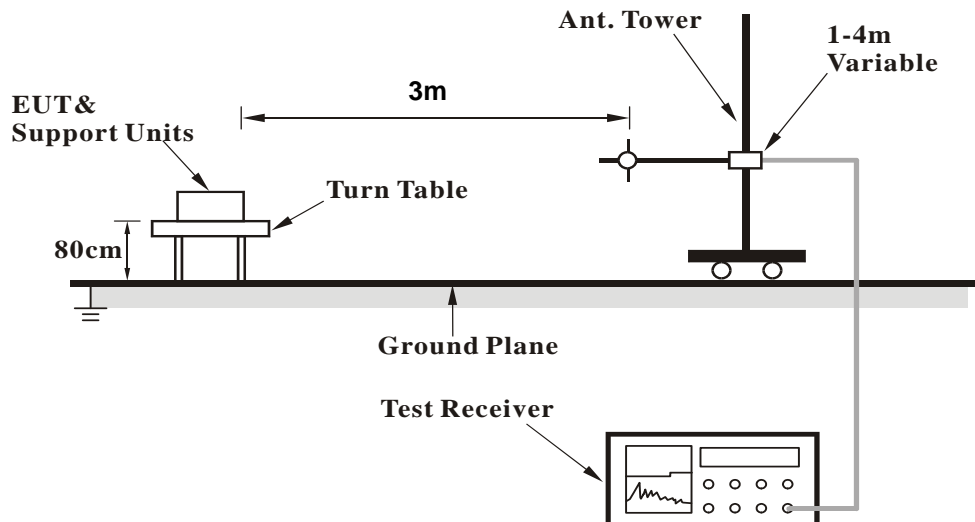

<Frequency Range above 1GHz>

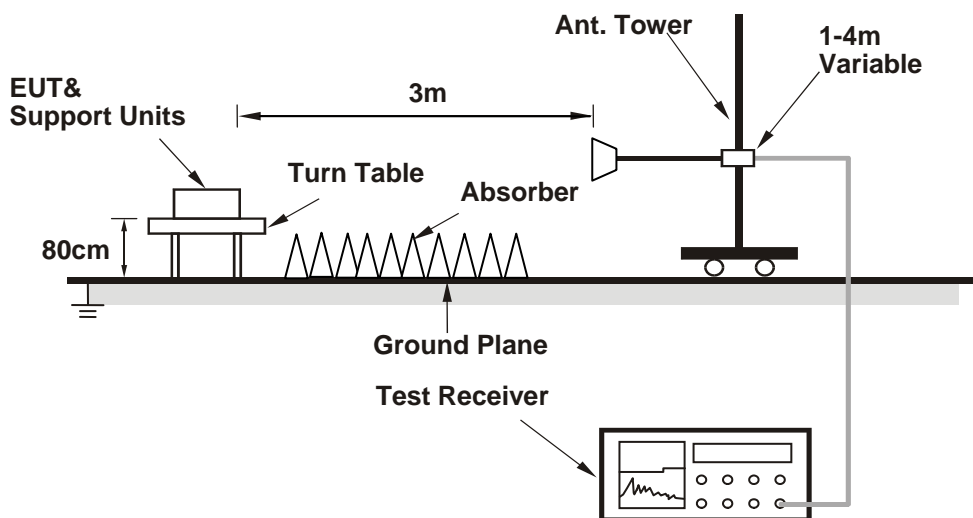

For the actual test configuration, please refer to the attached file (Test Setup Photo).

4.1.6 EUT Operating Condition

- Placed the EUT on the testing table.
- Prepared notebooks to act as communication partner and placed it outside of testing area.
- The communication partner connected with EUT via a RJ45 cable and ran a test program (provided by manufacturer) to enable EUT under transmission condition continuously at specific channel frequency.
- The communication partner sent data to EUT by command "PING".
- The necessary accessories enable the system in full functions.

4.1.7 Test Results
ABOVE 1GHz DATA :
802.11a_1TX

CHANNEL	TX Channel 52	DETECTOR FUNCTION	Peak (PK)
FREQUENCY RANGE	1GHz ~ 40GHz		Average (AV)

ANTENNA POLARITY & TEST DISTANCE: HORIZONTAL AT 3 M

NO.	FREQ. (MHz)	EMISSION LEVEL (dBuV/m)	LIMIT (dBuV/m)	MARGIN (dB)	ANTENNA HEIGHT (m)	TABLE ANGLE (Degree)	RAW VALUE (dBuV)	CORRECTION FACTOR (dB/m)
1	#3506.00	47.8 PK	74.0	-26.2	1.00 H	352	49.60	-1.80
2	#3506.00	42.8 AV	54.0	-11.2	1.00 H	352	44.60	-1.80
3	5150.00	60.5 PK	74.0	-13.5	1.15 H	74	58.50	2.00
4	5150.00	47.6 AV	54.0	-6.4	1.15 H	74	45.60	2.00
5	*5260.00	115.7 PK			1.15 H	74	75.60	40.10
6	*5260.00	105.2 AV			1.15 H	74	65.10	40.10
7	#10520.00	59.6 PK	74.0	-14.4	1.00 H	9	44.30	15.30
8	#10520.00	46.6 AV	54.0	-7.4	1.00 H	9	31.30	15.30
9	15780.00	63.1 PK	74.0	-10.9	1.07 H	23	48.30	14.80
10	15780.00	49.0 AV	54.0	-5.0	1.07 H	23	34.20	14.80

ANTENNA POLARITY & TEST DISTANCE: VERTICAL AT 3 M

NO.	FREQ. (MHz)	EMISSION LEVEL (dBuV/m)	LIMIT (dBuV/m)	MARGIN (dB)	ANTENNA HEIGHT (m)	TABLE ANGLE (Degree)	RAW VALUE (dBuV)	CORRECTION FACTOR (dB/m)
1	#3506.00	47.6 PK	74.0	-26.4	1.06 V	37	49.40	-1.80
2	#3506.00	41.5 AV	54.0	-12.5	1.06 V	37	43.30	-1.80
3	5150.00	59.0 PK	74.0	-15.0	1.00 V	34	57.00	2.00
4	5150.00	46.0 AV	54.0	-8.0	1.00 V	34	44.00	2.00
5	*5260.00	115.7 PK			1.00 V	34	75.60	40.10
6	*5260.00	105.5 AV			1.00 V	34	65.40	40.10
7	#10520.00	62.8 PK	74.0	-11.2	1.25 V	18	47.50	15.30
8	#10520.00	49.6 AV	54.0	-4.4	1.25 V	18	34.30	15.30
9	15780.00	66.7 PK	74.0	-7.3	1.01 V	30	51.90	14.80
10	15780.00	52.3 AV	54.0	-1.7	1.01 V	30	37.50	14.80

REMARKS:

1. Emission Level(dBuV/m) = Raw Value(dBuV) + Correction Factor(dB/m)
2. Correction Factor(dB/m) = Antenna Factor(dB/m) + Cable Factor(dB)
3. The other emission levels were very low against the limit.
4. Margin value = Emission Level – Limit value
5. " * ": Fundamental frequency.
6. " # ": The radiated frequency is out of the restricted band.



CHANNEL	TX Channel 60	DETECTOR FUNCTION	Peak (PK)
FREQUENCY RANGE	1GHz ~ 40GHz		Average (AV)

ANTENNA POLARITY & TEST DISTANCE: HORIZONTAL AT 3 M

NO.	FREQ. (MHz)	EMISSION LEVEL (dBuV/m)	LIMIT (dBuV/m)	MARGIN (dB)	ANTENNA HEIGHT (m)	TABLE ANGLE (Degree)	RAW VALUE (dBuV)	CORRECTION FACTOR (dB/m)
1	#3533.00	48.6 PK	74.0	-25.4	1.25 H	346	50.30	-1.70
2	#3533.00	43.4 AV	54.0	-10.6	1.25 H	346	45.10	-1.70
3	*5300.00	116.0 PK			1.01 H	46	75.90	40.10
4	*5300.00	105.8 AV			1.01 H	46	65.70	40.10
5	10600.00	60.6 PK	74.0	-13.4	1.00 H	322	44.40	16.20
6	10600.00	47.5 AV	54.0	-6.5	1.00 H	322	31.30	16.20
7	15900.00	69.1 PK	74.0	-4.9	1.05 H	23	54.20	14.90
8	15900.00	52.9 AV	54.0	-1.1	1.05 H	23	38.00	14.90

ANTENNA POLARITY & TEST DISTANCE: VERTICAL AT 3 M

NO.	FREQ. (MHz)	EMISSION LEVEL (dBuV/m)	LIMIT (dBuV/m)	MARGIN (dB)	ANTENNA HEIGHT (m)	TABLE ANGLE (Degree)	RAW VALUE (dBuV)	CORRECTION FACTOR (dB/m)
1	#3533.00	48.5 PK	74.0	-25.5	1.02 V	344	50.20	-1.70
2	#3533.00	43.4 AV	54.0	-10.6	1.02 V	344	45.10	-1.70
3	*5300.00	114.7 PK			1.18 V	36	74.60	40.10
4	*5300.00	104.8 AV			1.18 V	36	64.70	40.10
5	10600.00	63.8 PK	74.0	-10.2	1.31 V	17	47.60	16.20
6	10600.00	50.6 AV	54.0	-3.4	1.31 V	17	34.40	16.20
7	15900.00	69.5 PK	74.0	-4.5	1.00 V	30	54.60	14.90
8	15900.00	52.4 AV	54.0	-1.6	1.00 V	30	37.50	14.90

REMARKS:

1. Emission Level(dBuV/m) = Raw Value(dBuV) + Correction Factor(dB/m)
2. Correction Factor(dB/m) = Antenna Factor(dB/m) + Cable Factor(dB)
3. The other emission levels were very low against the limit.
4. Margin value = Emission Level – Limit value
5. " * ": Fundamental frequency.
6. " # ": The radiated frequency is out of the restricted band.

CHANNEL	TX Channel 64	DETECTOR FUNCTION	Peak (PK)
FREQUENCY RANGE	1GHz ~ 40GHz		Average (AV)

ANTENNA POLARITY & TEST DISTANCE: HORIZONTAL AT 3 M

NO.	FREQ. (MHz)	EMISSION LEVEL (dBuV/m)	LIMIT (dBuV/m)	MARGIN (dB)	ANTENNA HEIGHT (m)	TABLE ANGLE (Degree)	RAW VALUE (dBuV)	CORRECTION FACTOR (dB/m)
1	#3546.00	46.6 PK	74.0	-27.4	1.00 H	287	48.40	-1.80
2	#3546.00	38.6 AV	54.0	-15.4	1.00 H	287	40.40	-1.80
3	*5320.00	114.8 PK			1.00 H	351	74.60	40.20
4	*5320.00	104.8 AV			1.00 H	351	64.60	40.20
5	5350.00	65.7 PK	74.0	-8.3	1.00 H	351	63.70	2.00
6	5350.00	50.1 AV	54.0	-3.9	1.00 H	351	48.10	2.00
7	10640.00	59.5 PK	74.0	-14.5	1.00 H	322	43.20	16.30
8	10640.00	48.7 AV	54.0	-5.3	1.00 H	322	32.40	16.30
9	15960.00	65.0 PK	74.0	-9.0	1.05 H	23	50.30	14.70
10	15960.00	50.4 AV	54.0	-3.6	1.05 H	23	35.70	14.70

ANTENNA POLARITY & TEST DISTANCE: VERTICAL AT 3 M

NO.	FREQ. (MHz)	EMISSION LEVEL (dBuV/m)	LIMIT (dBuV/m)	MARGIN (dB)	ANTENNA HEIGHT (m)	TABLE ANGLE (Degree)	RAW VALUE (dBuV)	CORRECTION FACTOR (dB/m)
1	#3546.00	48.1 PK	74.0	-25.9	1.02 V	344	49.90	-1.80
2	#3546.00	43.4 AV	54.0	-10.6	1.02 V	344	45.20	-1.80
3	*5320.00	114.8 PK			1.07 V	32	74.60	40.20
4	*5320.00	103.9 AV			1.07 V	32	63.70	40.20
5	5350.00	67.5 PK	74.0	-6.5	1.07 V	32	65.50	2.00
6	5350.00	50.2 AV	54.0	-3.8	1.07 V	32	48.20	2.00
7	10640.00	61.7 PK	74.0	-12.3	1.24 V	16	45.40	16.30
8	10640.00	48.5 AV	54.0	-5.5	1.24 V	16	32.20	16.30
9	15960.00	63.5 PK	74.0	-10.5	1.04 V	14	48.80	14.70
10	15960.00	49.8 AV	54.0	-4.2	1.04 V	14	35.10	14.70

REMARKS:

1. Emission Level(dBuV/m) = Raw Value(dBuV) + Correction Factor(dB/m)
2. Correction Factor(dB/m) = Antenna Factor(dB/m) + Cable Factor(dB)
3. The other emission levels were very low against the limit.
4. Margin value = Emission Level – Limit value
5. " * ": Fundamental frequency.
6. " # ": The radiated frequency is out of the restricted band.

CHANNEL	TX Channel 100	DETECTOR FUNCTION	Peak (PK)
FREQUENCY RANGE	1GHz ~ 40GHz		Average (AV)

ANTENNA POLARITY & TEST DISTANCE: HORIZONTAL AT 3 M

NO.	FREQ. (MHz)	EMISSION LEVEL (dBuV/m)	LIMIT (dBuV/m)	MARGIN (dB)	ANTENNA HEIGHT (m)	TABLE ANGLE (Degree)	RAW VALUE (dBuV)	CORRECTION FACTOR (dB/m)
1	3666.00	49.4 PK	74.0	-24.6	1.33 H	356	50.70	-1.30
2	3666.00	44.8 AV	54.0	-9.2	1.33 H	356	46.10	-1.30
3	5460.00	64.1 PK	74.0	-9.9	1.18 H	57	62.00	2.10
4	5460.00	48.8 AV	54.0	-5.2	1.18 H	57	46.70	2.10
5	#5470.00	68.7 PK	74.0	-5.3	1.18 H	57	66.50	2.20
6	#5470.00	52.6 AV	54.0	-1.4	1.18 H	57	50.40	2.20
7	*5500.00	115.0 PK			1.18 H	57	74.70	40.30
8	*5500.00	104.5 AV			1.18 H	57	64.20	40.30
9	11000.00	64.2 PK	74.0	-9.8	1.00 H	126	46.50	17.70
10	11000.00	50.7 AV	54.0	-3.3	1.00 H	126	33.00	17.70
11	#16500.00	63.9 PK	74.0	-10.1	1.00 H	94	47.60	16.30
12	#16500.00	50.5 AV	54.0	-3.5	1.00 H	94	34.20	16.30

ANTENNA POLARITY & TEST DISTANCE: VERTICAL AT 3 M

NO.	FREQ. (MHz)	EMISSION LEVEL (dBuV/m)	LIMIT (dBuV/m)	MARGIN (dB)	ANTENNA HEIGHT (m)	TABLE ANGLE (Degree)	RAW VALUE (dBuV)	CORRECTION FACTOR (dB/m)
1	3666.00	51.7 PK	74.0	-22.3	1.00 V	0	53.00	-1.30
2	3666.00	48.6 AV	54.0	-5.4	1.00 V	0	49.90	-1.30
3	5460.00	62.2 PK	74.0	-11.8	1.08 V	15	60.10	2.10
4	5460.00	46.7 AV	54.0	-7.3	1.08 V	15	44.60	2.10
5	#5470.00	66.9 PK	74.0	-7.1	1.07 V	13	64.70	2.20
6	#5470.00	51.1 AV	54.0	-2.9	1.07 V	13	48.90	2.20
7	*5500.00	112.5 PK			1.05 V	13	72.20	40.30
8	*5500.00	102.1 AV			1.05 V	13	61.80	40.30
9	11000.00	65.6 PK	74.0	-8.4	1.35 V	24	47.90	17.70
10	11000.00	51.7 AV	54.0	-2.3	1.35 V	24	34.00	17.70
11	#16500.00	63.3 PK	74.0	-10.7	1.00 V	282	47.00	16.30
12	#16500.00	50.7 AV	54.0	-3.3	1.00 V	282	34.40	16.30

REMARKS:

1. Emission Level(dBuV/m) = Raw Value(dBuV) + Correction Factor(dB/m)
2. Correction Factor(dB/m) = Antenna Factor(dB/m) + Cable Factor(dB)
3. The other emission levels were very low against the limit.
4. Margin value = Emission Level – Limit value
5. " * ": Fundamental frequency.
6. " # ": The radiated frequency is out of the restricted band.



CHANNEL	TX Channel 116	DETECTOR FUNCTION	Peak (PK)
FREQUENCY RANGE	1GHz ~ 40GHz		Average (AV)

ANTENNA POLARITY & TEST DISTANCE: HORIZONTAL AT 3 M

NO.	FREQ. (MHz)	EMISSION LEVEL (dBuV/m)	LIMIT (dBuV/m)	MARGIN (dB)	ANTENNA HEIGHT (m)	TABLE ANGLE (Degree)	RAW VALUE (dBuV)	CORRECTION FACTOR (dB/m)
1	3720.00	46.3 PK	74.0	-27.7	1.00 H	275	47.20	-0.90
2	3720.00	37.1 AV	54.0	-16.9	1.00 H	275	38.00	-0.90
3	*5580.00	113.3 PK			1.04 H	61	72.80	40.50
4	*5580.00	103.7 AV			1.04 H	61	63.20	40.50
5	11160.00	62.1 PK	74.0	-11.9	1.00 H	70	45.70	16.40
6	11160.00	49.4 AV	54.0	-4.6	1.00 H	70	33.00	16.40
7	#16740.00	66.2 PK	74.0	-7.8	1.00 H	62	47.10	19.10
8	#16740.00	52.8 AV	54.0	-1.2	1.00 H	62	33.70	19.10

ANTENNA POLARITY & TEST DISTANCE: VERTICAL AT 3 M

NO.	FREQ. (MHz)	EMISSION LEVEL (dBuV/m)	LIMIT (dBuV/m)	MARGIN (dB)	ANTENNA HEIGHT (m)	TABLE ANGLE (Degree)	RAW VALUE (dBuV)	CORRECTION FACTOR (dB/m)
1	3720.00	45.8 PK	74.0	-28.2	1.00 V	21	46.70	-0.90
2	3720.00	35.2 AV	54.0	-18.8	1.00 V	21	36.10	-0.90
3	*5580.00	112.6 PK			1.00 V	20	72.10	40.50
4	*5580.00	102.4 AV			1.00 V	20	61.90	40.50
5	11160.00	69.3 PK	74.0	-4.7	1.00 V	26	52.90	16.40
6	11160.00	53.0 AV	54.0	-1.0	1.00 V	26	36.60	16.40
7	#16740.00	65.7 PK	74.0	-8.3	1.00 V	357	46.60	19.10
8	#16740.00	52.1 AV	54.0	-1.9	1.00 V	357	33.00	19.10

REMARKS:

1. Emission Level(dBuV/m) = Raw Value(dBuV) + Correction Factor(dB/m)
2. Correction Factor(dB/m) = Antenna Factor(dB/m) + Cable Factor(dB)
3. The other emission levels were very low against the limit.
4. Margin value = Emission Level – Limit value
5. " * ": Fundamental frequency.
6. " # ": The radiated frequency is out of the restricted band.



CHANNEL	TX Channel 140	DETECTOR FUNCTION	Peak (PK)
FREQUENCY RANGE	1GHz ~ 40GHz		Average (AV)

ANTENNA POLARITY & TEST DISTANCE: HORIZONTAL AT 3 M

NO.	FREQ. (MHz)	EMISSION LEVEL (dBuV/m)	LIMIT (dBuV/m)	MARGIN (dB)	ANTENNA HEIGHT (m)	TABLE ANGLE (Degree)	RAW VALUE (dBuV)	CORRECTION FACTOR (dB/m)
1	3800.00	44.4 PK	74.0	-29.6	1.00 H	15	45.10	-0.70
2	3800.00	35.3 AV	54.0	-18.7	1.00 H	15	36.00	-0.70
3	*5700.00	109.5 PK			1.00 H	80	68.70	40.80
4	*5700.00	98.4 AV			1.00 H	80	57.60	40.80
5	#5725.00	64.2 PK	74.0	-9.8	1.00 H	80	61.60	2.60
6	#5725.00	49.9 AV	54.0	-4.1	1.00 H	80	47.30	2.60
7	11400.00	64.0 PK	74.0	-10.0	1.00 H	353	47.80	16.20
8	11400.00	50.3 AV	54.0	-3.7	1.00 H	353	34.10	16.20

ANTENNA POLARITY & TEST DISTANCE: VERTICAL AT 3 M

NO.	FREQ. (MHz)	EMISSION LEVEL (dBuV/m)	LIMIT (dBuV/m)	MARGIN (dB)	ANTENNA HEIGHT (m)	TABLE ANGLE (Degree)	RAW VALUE (dBuV)	CORRECTION FACTOR (dB/m)
1	3800.00	44.3 PK	74.0	-29.7	1.00 V	73	45.00	-0.70
2	3800.00	35.8 AV	54.0	-18.2	1.00 V	73	36.50	-0.70
3	*5700.00	109.0 PK			1.02 V	89	68.20	40.80
4	*5700.00	98.5 AV			1.02 V	89	57.70	40.80
5	#5725.00	64.0 PK	74.0	-10.0	1.02 V	89	61.40	2.60
6	#5725.00	50.5 AV	54.0	-3.5	1.02 V	89	47.90	2.60
7	11400.00	67.9 PK	74.0	-6.1	1.28 V	28	51.70	16.20
8	11400.00	52.9 AV	54.0	-1.1	1.28 V	28	36.70	16.20

REMARKS:

1. Emission Level(dBuV/m) = Raw Value(dBuV) + Correction Factor(dB/m)
2. Correction Factor(dB/m) = Antenna Factor(dB/m) + Cable Factor(dB)
3. The other emission levels were very low against the limit.
4. Margin value = Emission Level – Limit value
5. " * ": Fundamental frequency.
6. " # ": The radiated frequency is out of the restricted band.

802.11n (HT20)_2TX

CHANNEL	TX Channel 52	DETECTOR FUNCTION	Peak (PK)
FREQUENCY RANGE	1GHz ~ 40GHz		Average (AV)

ANTENNA POLARITY & TEST DISTANCE: HORIZONTAL AT 3 M

NO.	FREQ. (MHz)	EMISSION LEVEL (dBuV/m)	LIMIT (dBuV/m)	MARGIN (dB)	ANTENNA HEIGHT (m)	TABLE ANGLE (Degree)	RAW VALUE (dBuV)	CORRECTION FACTOR (dB/m)
1	5100.00	59.0 PK	74.0	-15.0	1.05 H	288	57.10	1.90
2	5100.00	46.6 AV	54.0	-7.4	1.05 H	288	44.70	1.90
3	*5260.00	114.4 PK			1.02 H	64	74.30	40.10
4	*5260.00	102.9 AV			1.02 H	64	62.80	40.10
5	5460.00	59.7 PK	74.0	-14.3	1.52 H	35	57.60	2.10
6	5460.00	47.1 AV	54.0	-6.9	1.52 H	35	45.00	2.10
7	#10520.00	61.0 PK	74.0	-13.0	1.02 H	34	45.70	15.30
8	#10520.00	47.8 AV	54.0	-6.2	1.02 H	34	32.50	15.30

ANTENNA POLARITY & TEST DISTANCE: VERTICAL AT 3 M

NO.	FREQ. (MHz)	EMISSION LEVEL (dBuV/m)	LIMIT (dBuV/m)	MARGIN (dB)	ANTENNA HEIGHT (m)	TABLE ANGLE (Degree)	RAW VALUE (dBuV)	CORRECTION FACTOR (dB/m)
1	5150.00	57.4 PK	74.0	-16.6	1.02 V	6	55.40	2.00
2	5150.00	44.5 AV	54.0	-9.5	1.02 V	6	42.50	2.00
3	*5260.00	114.1 PK			1.01 V	46	74.00	40.10
4	*5260.00	104.1 AV			1.01 V	46	64.00	40.10
5	5460.00	59.3 PK	74.0	-14.7	1.01 V	5	57.20	2.10
6	5460.00	46.5 AV	54.0	-7.5	1.01 V	5	44.40	2.10
7	#10520.00	61.3 PK	74.0	-12.7	1.05 V	34	46.00	15.30
8	#10520.00	48.5 AV	54.0	-5.5	1.05 V	34	33.20	15.30

REMARKS:

1. Emission Level(dBuV/m) = Raw Value(dBuV) + Correction Factor(dB/m)
2. Correction Factor(dB/m) = Antenna Factor(dB/m) + Cable Factor(dB)
3. The other emission levels were very low against the limit.
4. Margin value = Emission Level – Limit value
5. " * ": Fundamental frequency.
6. " # ": The radiated frequency is out of the restricted band.

CHANNEL	TX Channel 60	DETECTOR FUNCTION	Peak (PK)
FREQUENCY RANGE	1GHz ~ 40GHz		Average (AV)

ANTENNA POLARITY & TEST DISTANCE: HORIZONTAL AT 3 M

NO.	FREQ. (MHz)	EMISSION LEVEL (dBuV/m)	LIMIT (dBuV/m)	MARGIN (dB)	ANTENNA HEIGHT (m)	TABLE ANGLE (Degree)	RAW VALUE (dBuV)	CORRECTION FACTOR (dB/m)
1	*5300.00	114.0 PK			1.01 H	333	73.90	40.10
2	*5300.00	103.7 AV			1.01 H	333	63.60	40.10
3	10600.00	62.2 PK	74.0	-11.8	1.02 H	63	46.00	16.20
4	10600.00	48.4 AV	54.0	-5.6	1.02 H	63	32.20	16.20
5	15900.00	65.7 PK	74.0	-8.3	1.00 H	29	50.80	14.90
6	15900.00	50.5 AV	54.0	-3.5	1.00 H	29	35.60	14.90

ANTENNA POLARITY & TEST DISTANCE: VERTICAL AT 3 M

NO.	FREQ. (MHz)	EMISSION LEVEL (dBuV/m)	LIMIT (dBuV/m)	MARGIN (dB)	ANTENNA HEIGHT (m)	TABLE ANGLE (Degree)	RAW VALUE (dBuV)	CORRECTION FACTOR (dB/m)
1	*5300.00	114.1 PK			1.00 V	293	74.00	40.10
2	*5300.00	103.8 AV			1.00 V	293	63.70	40.10
3	10600.00	62.8 PK	74.0	-11.2	1.05 V	35	46.60	16.20
4	10600.00	49.7 AV	54.0	-4.3	1.05 V	35	33.50	16.20
5	15900.00	66.2 PK	74.0	-7.8	1.03 V	27	51.30	14.90
6	15900.00	50.6 AV	54.0	-3.4	1.03 V	27	35.70	14.90

REMARKS:

1. Emission Level(dBuV/m) = Raw Value(dBuV) + Correction Factor(dB/m)
2. Correction Factor(dB/m) = Antenna Factor(dB/m) + Cable Factor(dB)
3. The other emission levels were very low against the limit.
4. Margin value = Emission Level – Limit value
5. " * ": Fundamental frequency.

CHANNEL	TX Channel 64	DETECTOR FUNCTION	Peak (PK)
FREQUENCY RANGE	1GHz ~ 40GHz		Average (AV)

ANTENNA POLARITY & TEST DISTANCE: HORIZONTAL AT 3 M

NO.	FREQ. (MHz)	EMISSION LEVEL (dBuV/m)	LIMIT (dBuV/m)	MARGIN (dB)	ANTENNA HEIGHT (m)	TABLE ANGLE (Degree)	RAW VALUE (dBuV)	CORRECTION FACTOR (dB/m)
1	*5320.00	114.1 PK			1.00 H	332	73.90	40.20
2	*5320.00	103.6 AV			1.00 H	332	63.40	40.20
3	5350.00	61.4 PK	74.0	-12.6	1.17 H	20	59.40	2.00
4	5350.00	49.2 AV	54.0	-4.8	1.17 H	20	47.20	2.00
5	10640.00	62.2 PK	74.0	-11.8	1.54 H	88	45.90	16.30
6	10640.00	48.5 AV	54.0	-5.5	1.54 H	88	32.20	16.30
7	15960.00	63.2 PK	74.0	-10.8	1.00 H	28	48.50	14.70
8	15960.00	49.7 AV	54.0	-4.3	1.00 H	28	35.00	14.70

ANTENNA POLARITY & TEST DISTANCE: VERTICAL AT 3 M

NO.	FREQ. (MHz)	EMISSION LEVEL (dBuV/m)	LIMIT (dBuV/m)	MARGIN (dB)	ANTENNA HEIGHT (m)	TABLE ANGLE (Degree)	RAW VALUE (dBuV)	CORRECTION FACTOR (dB/m)
1	*5320.00	114.9 PK			1.00 V	300	74.70	40.20
2	*5320.00	104.2 AV			1.00 V	300	64.00	40.20
3	5350.00	64.1 PK	74.0	-9.9	1.00 V	302	62.10	2.00
4	5350.00	49.9 AV	54.0	-4.1	1.00 V	302	47.90	2.00
5	10640.00	62.1 PK	74.0	-11.9	1.05 V	64	45.80	16.30
6	10640.00	48.5 AV	54.0	-5.5	1.05 V	64	32.20	16.30
7	15960.00	64.7 PK	74.0	-9.3	1.03 V	27	50.00	14.70
8	15960.00	49.5 AV	54.0	-4.5	1.03 V	27	34.80	14.70

REMARKS:

1. Emission Level(dBuV/m) = Raw Value(dBuV) + Correction Factor(dB/m)
2. Correction Factor(dB/m) = Antenna Factor(dB/m) + Cable Factor(dB)
3. The other emission levels were very low against the limit.
4. Margin value = Emission Level – Limit value
5. " * ": Fundamental frequency.



CHANNEL	TX Channel 100	DETECTOR FUNCTION	Peak (PK)
FREQUENCY RANGE	1GHz ~ 40GHz		Average (AV)

ANTENNA POLARITY & TEST DISTANCE: HORIZONTAL AT 3 M

NO.	FREQ. (MHz)	EMISSION LEVEL (dBuV/m)	LIMIT (dBuV/m)	MARGIN (dB)	ANTENNA HEIGHT (m)	TABLE ANGLE (Degree)	RAW VALUE (dBuV)	CORRECTION FACTOR (dB/m)
1	5460.00	58.0 PK	74.0	-16.0	1.16 H	17	55.90	2.10
2	5460.00	44.9 AV	54.0	-9.1	1.16 H	17	42.80	2.10
3	#5470.00	59.9 PK	74.0	-14.1	1.16 H	17	57.70	2.20
4	#5470.00	46.1 AV	54.0	-7.9	1.16 H	17	43.90	2.20
5	*5500.00	113.7 PK			1.06 H	56	73.40	40.30
6	*5500.00	103.2 AV			1.06 H	56	62.90	40.30
7	11000.00	63.2 PK	74.0	-10.8	1.00 H	330	45.50	17.70
8	11000.00	49.5 AV	54.0	-4.5	1.00 H	330	31.80	17.70

ANTENNA POLARITY & TEST DISTANCE: VERTICAL AT 3 M

NO.	FREQ. (MHz)	EMISSION LEVEL (dBuV/m)	LIMIT (dBuV/m)	MARGIN (dB)	ANTENNA HEIGHT (m)	TABLE ANGLE (Degree)	RAW VALUE (dBuV)	CORRECTION FACTOR (dB/m)
1	5460.00	59.1 PK	74.0	-14.9	1.00 V	7	57.00	2.10
2	5460.00	46.6 AV	54.0	-7.4	1.00 V	7	44.50	2.10
3	#5470.00	66.4 PK	74.0	-7.6	1.00 V	7	64.20	2.20
4	#5470.00	51.2 AV	54.0	-2.8	1.00 V	7	49.00	2.20
5	*5500.00	116.5 PK			1.00 V	5	76.20	40.30
6	*5500.00	106.2 AV			1.00 V	5	65.90	40.30
7	11000.00	66.2 PK	74.0	-7.8	1.35 V	15	48.50	17.70
8	11000.00	51.0 AV	54.0	-3.0	1.35 V	15	33.30	17.70

REMARKS:

1. Emission Level(dBuV/m) = Raw Value(dBuV) + Correction Factor(dB/m)
2. Correction Factor(dB/m) = Antenna Factor(dB/m) + Cable Factor(dB)
3. The other emission levels were very low against the limit.
4. Margin value = Emission Level – Limit value
5. " * ": Fundamental frequency.
6. " # ": The radiated frequency is out of the restricted band.



CHANNEL	TX Channel 116	DETECTOR FUNCTION	Peak (PK)
FREQUENCY RANGE	1GHz ~ 40GHz		Average (AV)

ANTENNA POLARITY & TEST DISTANCE: HORIZONTAL AT 3 M

NO.	FREQ. (MHz)	EMISSION LEVEL (dBuV/m)	LIMIT (dBuV/m)	MARGIN (dB)	ANTENNA HEIGHT (m)	TABLE ANGLE (Degree)	RAW VALUE (dBuV)	CORRECTION FACTOR (dB/m)
1	*5580.00	110.0 PK			1.06 H	12	69.50	40.50
2	*5580.00	99.9 AV			1.06 H	12	59.40	40.50
3	11160.00	64.3 PK	74.0	-9.7	1.02 H	351	47.90	16.40
4	11160.00	48.5 AV	54.0	-5.5	1.02 H	351	32.10	16.40

ANTENNA POLARITY & TEST DISTANCE: VERTICAL AT 3 M

NO.	FREQ. (MHz)	EMISSION LEVEL (dBuV/m)	LIMIT (dBuV/m)	MARGIN (dB)	ANTENNA HEIGHT (m)	TABLE ANGLE (Degree)	RAW VALUE (dBuV)	CORRECTION FACTOR (dB/m)
1	*5580.00	114.9 PK			1.00 V	9	74.40	40.50
2	*5580.00	104.4 AV			1.00 V	9	63.90	40.50
3	11160.00	65.1 PK	74.0	-8.9	1.31 V	22	48.70	16.40
4	11160.00	49.9 AV	54.0	-4.1	1.31 V	22	33.50	16.40

REMARKS:

1. Emission Level(dBuV/m) = Raw Value(dBuV) + Correction Factor(dB/m)
2. Correction Factor(dB/m) = Antenna Factor(dB/m) + Cable Factor(dB)
3. The other emission levels were very low against the limit.
4. Margin value = Emission Level – Limit value
5. " * ": Fundamental frequency.

CHANNEL	TX Channel 140	DETECTOR FUNCTION	Peak (PK)
FREQUENCY RANGE	1GHz ~ 40GHz		Average (AV)

ANTENNA POLARITY & TEST DISTANCE: HORIZONTAL AT 3 M

NO.	FREQ. (MHz)	EMISSION LEVEL (dBuV/m)	LIMIT (dBuV/m)	MARGIN (dB)	ANTENNA HEIGHT (m)	TABLE ANGLE (Degree)	RAW VALUE (dBuV)	CORRECTION FACTOR (dB/m)
1	*5700.00	110.6 PK			1.52 H	74	69.80	40.80
2	*5700.00	100.2 AV			1.52 H	74	59.40	40.80
3	#5725.00	59.9 PK	74.0	-14.1	1.59 H	74	57.30	2.60
4	#5725.00	48.0 AV	54.0	-6.0	1.59 H	74	45.40	2.60
5	11400.00	64.0 PK	74.0	-10.0	1.35 H	357	47.80	16.20
6	11400.00	49.4 AV	54.0	-4.6	1.35 H	357	33.20	16.20

ANTENNA POLARITY & TEST DISTANCE: VERTICAL AT 3 M

NO.	FREQ. (MHz)	EMISSION LEVEL (dBuV/m)	LIMIT (dBuV/m)	MARGIN (dB)	ANTENNA HEIGHT (m)	TABLE ANGLE (Degree)	RAW VALUE (dBuV)	CORRECTION FACTOR (dB/m)
1	*5700.00	109.9 PK			1.14 V	40	69.10	40.80
2	*5700.00	99.1 AV			1.14 V	40	58.30	40.80
3	#5725.00	62.5 PK	74.0	-11.5	1.24 V	152	59.90	2.60
4	#5725.00	48.0 AV	54.0	-6.0	1.24 V	152	45.40	2.60
5	11400.00	67.8 PK	74.0	-6.2	1.23 V	25	51.60	16.20
6	11400.00	52.7 AV	54.0	-1.3	1.23 V	25	36.50	16.20

REMARKS:

1. Emission Level(dBuV/m) = Raw Value(dBuV) + Correction Factor(dB/m)
2. Correction Factor(dB/m) = Antenna Factor(dB/m) + Cable Factor(dB)
3. The other emission levels were very low against the limit.
4. Margin value = Emission Level – Limit value
5. " * ": Fundamental frequency.
6. " # ": The radiated frequency is out of the restricted band.

802.11n (HT40)_2TX

CHANNEL	TX Channel 54	DETECTOR FUNCTION	Peak (PK)
FREQUENCY RANGE	1GHz ~ 40GHz		Average (AV)

ANTENNA POLARITY & TEST DISTANCE: HORIZONTAL AT 3 M								
NO.	FREQ. (MHz)	EMISSION LEVEL (dBuV/m)	LIMIT (dBuV/m)	MARGIN (dB)	ANTENNA HEIGHT (m)	TABLE ANGLE (Degree)	RAW VALUE (dBuV)	CORRECTION FACTOR (dB/m)
1	5150.00	56.6 PK	74.0	-17.4	1.56 H	66	54.60	2.00
2	5150.00	44.0 AV	54.0	-10.0	1.56 H	66	42.00	2.00
3	*5270.00	107.3 PK			1.12 H	333	67.20	40.10
4	*5270.00	97.5 AV			1.12 H	333	57.40	40.10
5	#10540.00	60.8 PK	74.0	-13.2	1.41 H	99	45.20	15.60
6	#10540.00	47.8 AV	54.0	-6.2	1.41 H	99	32.20	15.60

ANTENNA POLARITY & TEST DISTANCE: VERTICAL AT 3 M								
NO.	FREQ. (MHz)	EMISSION LEVEL (dBuV/m)	LIMIT (dBuV/m)	MARGIN (dB)	ANTENNA HEIGHT (m)	TABLE ANGLE (Degree)	RAW VALUE (dBuV)	CORRECTION FACTOR (dB/m)
1	5150.00	57.0 PK	74.0	-17.0	1.02 V	94	55.00	2.00
2	5150.00	44.3 AV	54.0	-9.7	1.02 V	94	42.30	2.00
3	*5270.00	110.9 PK			1.00 V	35	70.80	40.10
4	*5270.00	100.6 AV			1.00 V	35	60.50	40.10
5	#10540.00	61.6 PK	74.0	-12.4	1.00 V	24	46.00	15.60
6	#10540.00	48.8 AV	54.0	-5.2	1.00 V	24	33.20	15.60

REMARKS:

1. Emission Level(dBuV/m) = Raw Value(dBuV) + Correction Factor(dB/m)
2. Correction Factor(dB/m) = Antenna Factor(dB/m) + Cable Factor(dB)
3. The other emission levels were very low against the limit.
4. Margin value = Emission Level – Limit value
5. " * ": Fundamental frequency.
6. " # ": The radiated frequency is out of the restricted band.

CHANNEL	TX Channel 62	DETECTOR FUNCTION	Peak (PK)
FREQUENCY RANGE	1GHz ~ 40GHz		Average (AV)

ANTENNA POLARITY & TEST DISTANCE: HORIZONTAL AT 3 M

NO.	FREQ. (MHz)	EMISSION LEVEL (dBuV/m)	LIMIT (dBuV/m)	MARGIN (dB)	ANTENNA HEIGHT (m)	TABLE ANGLE (Degree)	RAW VALUE (dBuV)	CORRECTION FACTOR (dB/m)
1	*5310.00	106.8 PK			1.13 H	332	66.70	40.10
2	*5310.00	96.4 AV			1.13 H	332	56.30	40.10
3	5350.00	61.3 PK	74.0	-12.7	1.21 H	19	59.30	2.00
4	5350.00	48.4 AV	54.0	-5.6	1.21 H	19	46.40	2.00
5	10620.00	61.4 PK	74.0	-12.6	1.58 H	89	45.20	16.20
6	10620.00	47.7 AV	54.0	-6.3	1.58 H	89	31.50	16.20

ANTENNA POLARITY & TEST DISTANCE: VERTICAL AT 3 M

NO.	FREQ. (MHz)	EMISSION LEVEL (dBuV/m)	LIMIT (dBuV/m)	MARGIN (dB)	ANTENNA HEIGHT (m)	TABLE ANGLE (Degree)	RAW VALUE (dBuV)	CORRECTION FACTOR (dB/m)
1	*5310.00	110.2 PK			1.00 V	33	70.10	40.10
2	*5310.00	100.3 AV			1.00 V	33	60.20	40.10
3	5350.00	64.1 PK	74.0	-9.9	1.00 V	8	62.10	2.00
4	5350.00	51.5 AV	54.0	-2.5	1.00 V	8	49.50	2.00
5	10620.00	62.1 PK	74.0	-11.9	1.02 V	85	45.90	16.20
6	10620.00	48.7 AV	54.0	-5.3	1.02 V	85	32.50	16.20

REMARKS:

1. Emission Level(dBuV/m) = Raw Value(dBuV) + Correction Factor(dB/m)
2. Correction Factor(dB/m) = Antenna Factor(dB/m) + Cable Factor(dB)
3. The other emission levels were very low against the limit.
4. Margin value = Emission Level – Limit value
5. " * ": Fundamental frequency.



CHANNEL	TX Channel 102	DETECTOR FUNCTION	Peak (PK)
FREQUENCY RANGE	1GHz ~ 40GHz		Average (AV)

ANTENNA POLARITY & TEST DISTANCE: HORIZONTAL AT 3 M

NO.	FREQ. (MHz)	EMISSION LEVEL (dBuV/m)	LIMIT (dBuV/m)	MARGIN (dB)	ANTENNA HEIGHT (m)	TABLE ANGLE (Degree)	RAW VALUE (dBuV)	CORRECTION FACTOR (dB/m)
1	5460.00	58.9 PK	74.0	-15.1	1.03 H	16	56.80	2.10
2	5460.00	46.3 AV	54.0	-7.7	1.03 H	16	44.20	2.10
3	#5470.00	61.8 PK	74.0	-12.2	1.03 H	16	59.60	2.20
4	#5470.00	48.0 AV	54.0	-6.0	1.03 H	16	45.80	2.20
5	*5510.00	104.8 PK			1.34 H	297	64.50	40.30
6	*5510.00	94.5 AV			1.34 H	297	54.20	40.30
7	11020.00	62.7 PK	74.0	-11.3	1.37 H	330	45.30	17.40
8	11020.00	48.6 AV	54.0	-5.4	1.37 H	330	31.20	17.40

ANTENNA POLARITY & TEST DISTANCE: VERTICAL AT 3 M

NO.	FREQ. (MHz)	EMISSION LEVEL (dBuV/m)	LIMIT (dBuV/m)	MARGIN (dB)	ANTENNA HEIGHT (m)	TABLE ANGLE (Degree)	RAW VALUE (dBuV)	CORRECTION FACTOR (dB/m)
1	5460.00	62.5 PK	74.0	-11.5	1.00 V	6	60.40	2.10
2	5460.00	49.8 AV	54.0	-4.2	1.00 V	6	47.70	2.10
3	#5470.00	67.9 PK	74.0	-6.1	1.00 V	6	65.70	2.20
4	#5470.00	52.6 AV	54.0	-1.4	1.00 V	6	50.40	2.20
5	*5510.00	109.8 PK			1.00 V	5	69.50	40.30
6	*5510.00	98.8 AV			1.00 V	5	58.50	40.30
7	11020.00	64.9 PK	74.0	-9.1	1.45 V	17	47.50	17.40
8	11020.00	51.2 AV	54.0	-2.8	1.45 V	17	33.80	17.40

REMARKS:

1. Emission Level(dBuV/m) = Raw Value(dBuV) + Correction Factor(dB/m)
2. Correction Factor(dB/m) = Antenna Factor(dB/m) + Cable Factor(dB)
3. The other emission levels were very low against the limit.
4. Margin value = Emission Level – Limit value
5. " * ": Fundamental frequency.
6. " # ": The radiated frequency is out of the restricted band.



CHANNEL	TX Channel 110	DETECTOR FUNCTION	Peak (PK)
FREQUENCY RANGE	1GHz ~ 40GHz		Average (AV)

ANTENNA POLARITY & TEST DISTANCE: HORIZONTAL AT 3 M

NO.	FREQ. (MHz)	EMISSION LEVEL (dBuV/m)	LIMIT (dBuV/m)	MARGIN (dB)	ANTENNA HEIGHT (m)	TABLE ANGLE (Degree)	RAW VALUE (dBuV)	CORRECTION FACTOR (dB/m)
1	#5470.00	58.7 PK	74.0	-15.3	1.05 H	247	56.50	2.20
2	#5470.00	44.7 AV	54.0	-9.3	1.05 H	247	42.50	2.20
3	*5550.00	103.7 PK			1.00 H	11	63.30	40.40
4	*5550.00	93.3 AV			1.00 H	11	52.90	40.40
5	11100.00	63.3 PK	74.0	-10.7	1.00 H	56	46.70	16.60
6	11100.00	50.2 AV	54.0	-3.8	1.00 H	56	33.60	16.60

ANTENNA POLARITY & TEST DISTANCE: VERTICAL AT 3 M

NO.	FREQ. (MHz)	EMISSION LEVEL (dBuV/m)	LIMIT (dBuV/m)	MARGIN (dB)	ANTENNA HEIGHT (m)	TABLE ANGLE (Degree)	RAW VALUE (dBuV)	CORRECTION FACTOR (dB/m)
1	#5470.00	59.6 PK	74.0	-14.4	1.00 V	6	57.40	2.20
2	#5470.00	45.9 AV	54.0	-8.1	1.00 V	6	43.70	2.20
3	*5550.00	110.4 PK			1.00 V	5	70.00	40.40
4	*5550.00	99.7 AV			1.00 V	5	59.30	40.40
5	11100.00	68.3 PK	74.0	-5.7	1.40 V	17	51.70	16.60
6	11100.00	52.8 AV	54.0	-1.2	1.40 V	17	36.20	16.60

REMARKS:

1. Emission Level(dBuV/m) = Raw Value(dBuV) + Correction Factor(dB/m)
2. Correction Factor(dB/m) = Antenna Factor(dB/m) + Cable Factor(dB)
3. The other emission levels were very low against the limit.
4. Margin value = Emission Level – Limit value
5. " * ": Fundamental frequency.
6. " # ": The radiated frequency is out of the restricted band.



CHANNEL	TX Channel 134	DETECTOR FUNCTION	Peak (PK)
FREQUENCY RANGE	1GHz ~ 40GHz		Average (AV)

ANTENNA POLARITY & TEST DISTANCE: HORIZONTAL AT 3 M

NO.	FREQ. (MHz)	EMISSION LEVEL (dBuV/m)	LIMIT (dBuV/m)	MARGIN (dB)	ANTENNA HEIGHT (m)	TABLE ANGLE (Degree)	RAW VALUE (dBuV)	CORRECTION FACTOR (dB/m)
1	*5670.00	103.4 PK			1.14 H	12	62.70	40.70
2	*5670.00	92.7 AV			1.14 H	12	52.00	40.70
3	#5725.00	57.4 PK	74.0	-16.6	1.00 H	10	54.80	2.60
4	#5725.00	44.7 AV	54.0	-9.3	1.00 H	10	42.10	2.60
5	11340.00	65.5 PK	74.0	-8.5	1.05 H	353	49.00	16.50
6	11340.00	51.9 AV	54.0	-2.1	1.05 H	353	35.40	16.50

ANTENNA POLARITY & TEST DISTANCE: VERTICAL AT 3 M

NO.	FREQ. (MHz)	EMISSION LEVEL (dBuV/m)	LIMIT (dBuV/m)	MARGIN (dB)	ANTENNA HEIGHT (m)	TABLE ANGLE (Degree)	RAW VALUE (dBuV)	CORRECTION FACTOR (dB/m)
1	*5670.00	106.2 PK			1.00 V	3	65.50	40.70
2	*5670.00	95.7 AV			1.00 V	3	55.00	40.70
3	#5725.00	57.3 PK	74.0	-16.7	1.00 V	286	54.70	2.60
4	#5725.00	44.9 AV	54.0	-9.1	1.00 V	286	42.30	2.60
5	11340.00	67.1 PK	74.0	-6.9	1.26 V	12	50.60	16.50
6	11340.00	52.7 AV	54.0	-1.3	1.26 V	12	36.20	16.50

REMARKS:

1. Emission Level(dBuV/m) = Raw Value(dBuV) + Correction Factor(dB/m)
2. Correction Factor(dB/m) = Antenna Factor(dB/m) + Cable Factor(dB)
3. The other emission levels were very low against the limit.
4. Margin value = Emission Level – Limit value
5. " * ": Fundamental frequency.
6. " # ": The radiated frequency is out of the restricted band.

802.11ac (HT20)_2TX

CHANNEL	TX Channel 52	DETECTOR FUNCTION	Peak (PK)
FREQUENCY RANGE	1GHz ~ 40GHz		Average (AV)

ANTENNA POLARITY & TEST DISTANCE: HORIZONTAL AT 3 M								
NO.	FREQ. (MHz)	EMISSION LEVEL (dBuV/m)	LIMIT (dBuV/m)	MARGIN (dB)	ANTENNA HEIGHT (m)	TABLE ANGLE (Degree)	RAW VALUE (dBuV)	CORRECTION FACTOR (dB/m)
1	5150.00	58.8 PK	74.0	-15.2	1.05 H	224	56.80	2.00
2	5150.00	46.4 AV	54.0	-7.6	1.05 H	224	44.40	2.00
3	*5260.00	114.1 PK			1.38 H	46	74.00	40.10
4	*5260.00	102.6 AV			1.38 H	46	62.50	40.10
5	5460.00	59.6 PK	74.0	-14.4	1.02 H	35	57.50	2.10
6	5460.00	47.0 AV	54.0	-7.0	1.02 H	35	44.90	2.10
7	#10520.00	61.0 PK	74.0	-13.0	1.47 H	88	45.70	15.30
8	#10520.00	47.5 AV	54.0	-6.5	1.47 H	88	32.20	15.30

ANTENNA POLARITY & TEST DISTANCE: VERTICAL AT 3 M								
NO.	FREQ. (MHz)	EMISSION LEVEL (dBuV/m)	LIMIT (dBuV/m)	MARGIN (dB)	ANTENNA HEIGHT (m)	TABLE ANGLE (Degree)	RAW VALUE (dBuV)	CORRECTION FACTOR (dB/m)
1	5150.00	57.1 PK	74.0	-16.9	1.02 V	64	55.10	2.00
2	5150.00	44.3 AV	54.0	-9.7	1.02 V	64	42.30	2.00
3	*5260.00	113.8 PK			1.02 V	45	73.70	40.10
4	*5260.00	103.9 AV			1.02 V	45	63.80	40.10
5	5460.00	59.6 PK	74.0	-14.4	1.01 V	5	57.50	2.10
6	5460.00	46.3 AV	54.0	-7.7	1.01 V	5	44.20	2.10
7	#10520.00	60.9 PK	74.0	-13.1	1.52 V	66	45.60	15.30
8	#10520.00	48.4 AV	54.0	-5.6	1.52 V	66	33.10	15.30

REMARKS:

1. Emission Level(dBuV/m) = Raw Value(dBuV) + Correction Factor(dB/m)
2. Correction Factor(dB/m) = Antenna Factor(dB/m) + Cable Factor(dB)
3. The other emission levels were very low against the limit.
4. Margin value = Emission Level – Limit value
5. " * ": Fundamental frequency.
6. " # ": The radiated frequency is out of the restricted band.

CHANNEL	TX Channel 60	DETECTOR FUNCTION	Peak (PK)
FREQUENCY RANGE	1GHz ~ 40GHz		Average (AV)

ANTENNA POLARITY & TEST DISTANCE: HORIZONTAL AT 3 M

NO.	FREQ. (MHz)	EMISSION LEVEL (dBuV/m)	LIMIT (dBuV/m)	MARGIN (dB)	ANTENNA HEIGHT (m)	TABLE ANGLE (Degree)	RAW VALUE (dBuV)	CORRECTION FACTOR (dB/m)
1	*5300.00	113.8 PK			1.01 H	334	73.70	40.10
2	*5300.00	103.5 AV			1.01 H	334	63.40	40.10
3	10600.00	62.0 PK	74.0	-12.0	1.05 H	84	45.80	16.20
4	10600.00	48.3 AV	54.0	-5.7	1.05 H	84	32.10	16.20
5	15900.00	65.4 PK	74.0	-8.6	1.26 H	96	50.50	14.90
6	15900.00	50.4 AV	54.0	-3.6	1.26 H	96	35.50	14.90

ANTENNA POLARITY & TEST DISTANCE: VERTICAL AT 3 M

NO.	FREQ. (MHz)	EMISSION LEVEL (dBuV/m)	LIMIT (dBuV/m)	MARGIN (dB)	ANTENNA HEIGHT (m)	TABLE ANGLE (Degree)	RAW VALUE (dBuV)	CORRECTION FACTOR (dB/m)
1	*5300.00	113.8 PK			1.00 V	295	73.70	40.10
2	*5300.00	103.6 AV			1.00 V	295	63.50	40.10
3	10600.00	62.1 PK	74.0	-11.9	1.52 V	95	45.90	16.20
4	10600.00	49.4 AV	54.0	-4.6	1.52 V	95	33.20	16.20
5	15900.00	66.3 PK	74.0	-7.7	1.03 V	28	51.40	14.90
6	15900.00	50.7 AV	54.0	-3.3	1.03 V	28	35.80	14.90

REMARKS:

1. Emission Level(dBuV/m) = Raw Value(dBuV) + Correction Factor(dB/m)
2. Correction Factor(dB/m) = Antenna Factor(dB/m) + Cable Factor(dB)
3. The other emission levels were very low against the limit.
4. Margin value = Emission Level – Limit value
5. " * ": Fundamental frequency.



CHANNEL	TX Channel 64	DETECTOR FUNCTION	Peak (PK)
FREQUENCY RANGE	1GHz ~ 40GHz		Average (AV)

ANTENNA POLARITY & TEST DISTANCE: HORIZONTAL AT 3 M

NO.	FREQ. (MHz)	EMISSION LEVEL (dBuV/m)	LIMIT (dBuV/m)	MARGIN (dB)	ANTENNA HEIGHT (m)	TABLE ANGLE (Degree)	RAW VALUE (dBuV)	CORRECTION FACTOR (dB/m)
1	*5320.00	113.8 PK			1.02 H	65	73.60	40.20
2	*5320.00	103.4 AV			1.02 H	65	63.20	40.20
3	5350.00	61.3 PK	74.0	-12.7	1.05 H	84	59.30	2.00
4	5350.00	49.3 AV	54.0	-4.7	1.05 H	84	47.30	2.00
5	10640.00	61.5 PK	74.0	-12.5	1.01 H	54	45.20	16.30
6	10640.00	48.4 AV	54.0	-5.6	1.01 H	54	32.10	16.30
7	15960.00	63.1 PK	74.0	-10.9	1.05 H	88	48.40	14.70
8	15960.00	49.5 AV	54.0	-4.5	1.05 H	88	34.80	14.70

ANTENNA POLARITY & TEST DISTANCE: VERTICAL AT 3 M

NO.	FREQ. (MHz)	EMISSION LEVEL (dBuV/m)	LIMIT (dBuV/m)	MARGIN (dB)	ANTENNA HEIGHT (m)	TABLE ANGLE (Degree)	RAW VALUE (dBuV)	CORRECTION FACTOR (dB/m)
1	*5320.00	114.7 PK			1.05 V	21	74.50	40.20
2	*5320.00	103.9 AV			1.05 V	21	63.70	40.20
3	5350.00	63.8 PK	74.0	-10.2	1.02 V	33	61.80	2.00
4	5350.00	49.5 AV	54.0	-4.5	1.02 V	33	47.50	2.00
5	10640.00	61.9 PK	74.0	-12.1	1.41 V	51	45.60	16.30
6	10640.00	48.5 AV	54.0	-5.5	1.41 V	51	32.20	16.30
7	15960.00	64.8 PK	74.0	-9.2	1.02 V	32	50.10	14.70
8	15960.00	49.4 AV	54.0	-4.6	1.02 V	32	34.70	14.70

REMARKS:

1. Emission Level(dBuV/m) = Raw Value(dBuV) + Correction Factor(dB/m)
2. Correction Factor(dB/m) = Antenna Factor(dB/m) + Cable Factor(dB)
3. The other emission levels were very low against the limit.
4. Margin value = Emission Level – Limit value
5. " * ": Fundamental frequency.



CHANNEL	TX Channel 100	DETECTOR FUNCTION	Peak (PK)
FREQUENCY RANGE	1GHz ~ 40GHz		Average (AV)

ANTENNA POLARITY & TEST DISTANCE: HORIZONTAL AT 3 M

NO.	FREQ. (MHz)	EMISSION LEVEL (dBuV/m)	LIMIT (dBuV/m)	MARGIN (dB)	ANTENNA HEIGHT (m)	TABLE ANGLE (Degree)	RAW VALUE (dBuV)	CORRECTION FACTOR (dB/m)
1	5460.00	57.9 PK	74.0	-16.1	1.15 H	18	55.80	2.10
2	5460.00	44.8 AV	54.0	-9.2	1.15 H	18	42.70	2.10
3	#5470.00	59.7 PK	74.0	-14.3	1.17 H	18	57.50	2.20
4	#5470.00	45.7 AV	54.0	-8.3	1.17 H	18	43.50	2.20
5	*5500.00	113.5 PK			1.33 H	285	73.20	40.30
6	*5500.00	103.0 AV			1.33 H	285	62.70	40.30
7	11000.00	63.5 PK	74.0	-10.5	1.25 H	65	45.80	17.70
8	11000.00	49.6 AV	54.0	-4.4	1.25 H	65	31.90	17.70

ANTENNA POLARITY & TEST DISTANCE: VERTICAL AT 3 M

NO.	FREQ. (MHz)	EMISSION LEVEL (dBuV/m)	LIMIT (dBuV/m)	MARGIN (dB)	ANTENNA HEIGHT (m)	TABLE ANGLE (Degree)	RAW VALUE (dBuV)	CORRECTION FACTOR (dB/m)
1	5460.00	58.9 PK	74.0	-15.1	1.00 V	8	56.80	2.10
2	5460.00	46.4 AV	54.0	-7.6	1.00 V	8	44.30	2.10
3	#5470.00	66.3 PK	74.0	-7.7	1.00 V	8	64.10	2.20
4	#5470.00	50.9 AV	54.0	-3.1	1.00 V	8	48.70	2.20
5	*5500.00	116.3 PK			1.00 V	5	76.00	40.30
6	*5500.00	105.9 AV			1.00 V	5	65.60	40.30
7	11000.00	65.9 PK	74.0	-8.1	1.38 V	95	48.20	17.70
8	11000.00	50.8 AV	54.0	-3.2	1.38 V	95	33.10	17.70

REMARKS:

1. Emission Level(dBuV/m) = Raw Value(dBuV) + Correction Factor(dB/m)
2. Correction Factor(dB/m) = Antenna Factor(dB/m) + Cable Factor(dB)
3. The other emission levels were very low against the limit.
4. Margin value = Emission Level – Limit value
5. " * ": Fundamental frequency.
6. " # ": The radiated frequency is out of the restricted band.

CHANNEL	TX Channel 116	DETECTOR FUNCTION	Peak (PK)
FREQUENCY RANGE	1GHz ~ 40GHz		Average (AV)

ANTENNA POLARITY & TEST DISTANCE: HORIZONTAL AT 3 M

NO.	FREQ. (MHz)	EMISSION LEVEL (dBuV/m)	LIMIT (dBuV/m)	MARGIN (dB)	ANTENNA HEIGHT (m)	TABLE ANGLE (Degree)	RAW VALUE (dBuV)	CORRECTION FACTOR (dB/m)
1	*5580.00	109.7 PK			1.06 H	13	69.20	40.50
2	*5580.00	99.7 AV			1.06 H	13	59.20	40.50
3	11160.00	64.1 PK	74.0	-9.9	1.03 H	352	47.70	16.40
4	11160.00	50.4 AV	54.0	-3.6	1.03 H	352	34.00	16.40

ANTENNA POLARITY & TEST DISTANCE: VERTICAL AT 3 M

NO.	FREQ. (MHz)	EMISSION LEVEL (dBuV/m)	LIMIT (dBuV/m)	MARGIN (dB)	ANTENNA HEIGHT (m)	TABLE ANGLE (Degree)	RAW VALUE (dBuV)	CORRECTION FACTOR (dB/m)
1	*5580.00	114.6 PK			1.00 V	10	74.10	40.50
2	*5580.00	104.2 AV			1.00 V	10	63.70	40.50
3	11160.00	68.5 PK	74.0	-5.5	1.32 V	23	52.10	16.40
4	11160.00	49.6 AV	54.0	-4.4	1.32 V	23	33.20	16.40

REMARKS:

1. Emission Level(dBuV/m) = Raw Value(dBuV) + Correction Factor(dB/m)
2. Correction Factor(dB/m) = Antenna Factor(dB/m) + Cable Factor(dB)
3. The other emission levels were very low against the limit.
4. Margin value = Emission Level – Limit value
5. " * ": Fundamental frequency.

CHANNEL	TX Channel 140	DETECTOR FUNCTION	Peak (PK)
FREQUENCY RANGE	1GHz ~ 40GHz		Average (AV)

ANTENNA POLARITY & TEST DISTANCE: HORIZONTAL AT 3 M

NO.	FREQ. (MHz)	EMISSION LEVEL (dBuV/m)	LIMIT (dBuV/m)	MARGIN (dB)	ANTENNA HEIGHT (m)	TABLE ANGLE (Degree)	RAW VALUE (dBuV)	CORRECTION FACTOR (dB/m)
1	*5700.00	110.4 PK			1.00 H	55	69.60	40.80
2	*5700.00	99.9 AV			1.00 H	55	59.10	40.80
3	#5725.00	57.4 PK	74.0	-16.6	1.03 H	65	54.80	2.60
4	#5725.00	47.6 AV	54.0	-6.4	1.03 H	65	45.00	2.60
5	11400.00	63.7 PK	74.0	-10.3	1.02 H	95	47.50	16.20
6	11400.00	49.3 AV	54.0	-4.7	1.02 H	95	33.10	16.20

ANTENNA POLARITY & TEST DISTANCE: VERTICAL AT 3 M

NO.	FREQ. (MHz)	EMISSION LEVEL (dBuV/m)	LIMIT (dBuV/m)	MARGIN (dB)	ANTENNA HEIGHT (m)	TABLE ANGLE (Degree)	RAW VALUE (dBuV)	CORRECTION FACTOR (dB/m)
1	*5700.00	109.6 PK			1.02 V	41	68.80	40.80
2	*5700.00	98.8 AV			1.02 V	41	58.00	40.80
3	#5725.00	57.8 PK	74.0	-16.2	1.41 V	59	55.20	2.60
4	#5725.00	44.7 AV	54.0	-9.3	1.41 V	59	42.10	2.60
5	11400.00	67.0 PK	74.0	-7.0	1.23 V	24	50.80	16.20
6	11400.00	52.6 AV	54.0	-1.4	1.23 V	24	36.40	16.20

REMARKS:

1. Emission Level(dBuV/m) = Raw Value(dBuV) + Correction Factor(dB/m)
2. Correction Factor(dB/m) = Antenna Factor(dB/m) + Cable Factor(dB)
3. The other emission levels were very low against the limit.
4. Margin value = Emission Level – Limit value
5. " * ": Fundamental frequency.
6. " # ": The radiated frequency is out of the restricted band.

802.11ac (VHT40)_2TX

CHANNEL	TX Channel 54	DETECTOR FUNCTION	Peak (PK)
FREQUENCY RANGE	1GHz ~ 40GHz		Average (AV)

ANTENNA POLARITY & TEST DISTANCE: HORIZONTAL AT 3 M

NO.	FREQ. (MHz)	EMISSION LEVEL (dBuV/m)	LIMIT (dBuV/m)	MARGIN (dB)	ANTENNA HEIGHT (m)	TABLE ANGLE (Degree)	RAW VALUE (dBuV)	CORRECTION FACTOR (dB/m)
1	5150.00	56.5 PK	74.0	-17.5	1.57 H	65	54.50	2.00
2	5150.00	43.7 AV	54.0	-10.3	1.57 H	65	41.70	2.00
3	*5270.00	107.1 PK			1.05 H	98	67.00	40.10
4	*5270.00	97.1 AV			1.05 H	98	57.00	40.10
5	#10540.00	60.6 PK	74.0	-13.4	1.42 H	100	45.00	15.60
6	#10540.00	47.7 AV	54.0	-6.3	1.42 H	100	32.10	15.60

ANTENNA POLARITY & TEST DISTANCE: VERTICAL AT 3 M

NO.	FREQ. (MHz)	EMISSION LEVEL (dBuV/m)	LIMIT (dBuV/m)	MARGIN (dB)	ANTENNA HEIGHT (m)	TABLE ANGLE (Degree)	RAW VALUE (dBuV)	CORRECTION FACTOR (dB/m)
1	5150.00	56.9 PK	74.0	-17.1	1.03 V	95	54.90	2.00
2	5150.00	44.1 AV	54.0	-9.9	1.03 V	95	42.10	2.00
3	*5270.00	110.6 PK			1.01 V	45	70.50	40.10
4	*5270.00	100.4 AV			1.01 V	45	60.30	40.10
5	#10540.00	61.4 PK	74.0	-12.6	1.00 V	25	45.80	15.60
6	#10540.00	48.7 AV	54.0	-5.3	1.00 V	25	33.10	15.60

REMARKS:

1. Emission Level(dBuV/m) = Raw Value(dBuV) + Correction Factor(dB/m)
2. Correction Factor(dB/m) = Antenna Factor(dB/m) + Cable Factor(dB)
3. The other emission levels were very low against the limit.
4. Margin value = Emission Level – Limit value
5. " * ": Fundamental frequency.
6. " # ": The radiated frequency is out of the restricted band.

CHANNEL	TX Channel 62	DETECTOR FUNCTION	Peak (PK)
FREQUENCY RANGE	1GHz ~ 40GHz		Average (AV)

ANTENNA POLARITY & TEST DISTANCE: HORIZONTAL AT 3 M

NO.	FREQ. (MHz)	EMISSION LEVEL (dBuV/m)	LIMIT (dBuV/m)	MARGIN (dB)	ANTENNA HEIGHT (m)	TABLE ANGLE (Degree)	RAW VALUE (dBuV)	CORRECTION FACTOR (dB/m)
1	*5310.00	106.6 PK			1.15 H	333	66.50	40.10
2	*5310.00	96.1 AV			1.15 H	333	56.00	40.10
3	5350.00	61.0 PK	74.0	-13.0	1.22 H	21	59.00	2.00
4	5350.00	48.2 AV	54.0	-5.8	1.22 H	21	46.20	2.00
5	10620.00	61.3 PK	74.0	-12.7	1.05 H	96	45.10	16.20
6	10620.00	47.4 AV	54.0	-6.6	1.05 H	96	31.20	16.20

ANTENNA POLARITY & TEST DISTANCE: VERTICAL AT 3 M

NO.	FREQ. (MHz)	EMISSION LEVEL (dBuV/m)	LIMIT (dBuV/m)	MARGIN (dB)	ANTENNA HEIGHT (m)	TABLE ANGLE (Degree)	RAW VALUE (dBuV)	CORRECTION FACTOR (dB/m)
1	*5310.00	109.9 PK			1.00 V	47	69.80	40.10
2	*5310.00	100.1 AV			1.00 V	47	60.00	40.10
3	5350.00	63.8 PK	74.0	-10.2	1.00 V	43	61.80	2.00
4	5350.00	51.3 AV	54.0	-2.7	1.00 V	43	49.30	2.00
5	10620.00	61.9 PK	74.0	-12.1	1.03 V	89	45.70	16.20
6	10620.00	48.4 AV	54.0	-5.6	1.03 V	89	32.20	16.20

REMARKS:

1. Emission Level(dBuV/m) = Raw Value(dBuV) + Correction Factor(dB/m)
2. Correction Factor(dB/m) = Antenna Factor(dB/m) + Cable Factor(dB)
3. The other emission levels were very low against the limit.
4. Margin value = Emission Level – Limit value
5. " * ": Fundamental frequency.

CHANNEL	TX Channel 102	DETECTOR FUNCTION	Peak (PK)
FREQUENCY RANGE	1GHz ~ 40GHz		Average (AV)

ANTENNA POLARITY & TEST DISTANCE: HORIZONTAL AT 3 M

NO.	FREQ. (MHz)	EMISSION LEVEL (dBuV/m)	LIMIT (dBuV/m)	MARGIN (dB)	ANTENNA HEIGHT (m)	TABLE ANGLE (Degree)	RAW VALUE (dBuV)	CORRECTION FACTOR (dB/m)
1	5460.00	58.6 PK	74.0	-15.4	1.03 H	15	56.50	2.10
2	5460.00	46.1 AV	54.0	-7.9	1.03 H	15	44.00	2.10
3	#5470.00	61.7 PK	74.0	-12.3	1.03 H	15	59.50	2.20
4	#5470.00	47.9 AV	54.0	-6.1	1.03 H	15	45.70	2.20
5	*5510.00	104.5 PK			1.35 H	299	64.20	40.30
6	*5510.00	94.3 AV			1.35 H	299	54.00	40.30
7	11020.00	62.4 PK	74.0	-11.6	1.05 H	84	45.00	17.40
8	11020.00	48.6 AV	54.0	-5.4	1.05 H	84	31.20	17.40

ANTENNA POLARITY & TEST DISTANCE: VERTICAL AT 3 M

NO.	FREQ. (MHz)	EMISSION LEVEL (dBuV/m)	LIMIT (dBuV/m)	MARGIN (dB)	ANTENNA HEIGHT (m)	TABLE ANGLE (Degree)	RAW VALUE (dBuV)	CORRECTION FACTOR (dB/m)
1	5460.00	62.4 PK	74.0	-11.6	1.00 V	5	60.30	2.10
2	5460.00	49.6 AV	54.0	-4.4	1.00 V	5	47.50	2.10
3	#5470.00	67.7 PK	74.0	-6.3	1.00 V	5	65.50	2.20
4	#5470.00	52.7 AV	54.0	-1.3	1.00 V	5	50.50	2.20
5	*5510.00	109.6 PK			1.00 V	7	69.30	40.30
6	*5510.00	98.6 AV			1.00 V	7	58.30	40.30
7	11020.00	64.7 PK	74.0	-9.3	1.45 V	18	47.30	17.40
8	11020.00	50.9 AV	54.0	-3.1	1.45 V	18	33.50	17.40

REMARKS:

1. Emission Level(dBuV/m) = Raw Value(dBuV) + Correction Factor(dB/m)
2. Correction Factor(dB/m) = Antenna Factor(dB/m) + Cable Factor(dB)
3. The other emission levels were very low against the limit.
4. Margin value = Emission Level – Limit value
5. " * ": Fundamental frequency.
6. " # ": The radiated frequency is out of the restricted band.



CHANNEL	TX Channel 110	DETECTOR FUNCTION	Peak (PK)
FREQUENCY RANGE	1GHz ~ 40GHz		Average (AV)

ANTENNA POLARITY & TEST DISTANCE: HORIZONTAL AT 3 M

NO.	FREQ. (MHz)	EMISSION LEVEL (dBuV/m)	LIMIT (dBuV/m)	MARGIN (dB)	ANTENNA HEIGHT (m)	TABLE ANGLE (Degree)	RAW VALUE (dBuV)	CORRECTION FACTOR (dB/m)
1	#5470.00	58.5 PK	74.0	-15.5	1.06 H	248	56.30	2.20
2	#5470.00	44.4 AV	54.0	-9.6	1.06 H	248	42.20	2.20
3	*5550.00	93.5 PK			1.00 H	12	53.10	40.40
4	*5550.00	93.1 AV			1.00 H	12	52.70	40.40
5	11100.00	62.5 PK	74.0	-11.5	1.05 H	9	45.90	16.60
6	11100.00	49.8 AV	54.0	-4.2	1.05 H	9	33.20	16.60

ANTENNA POLARITY & TEST DISTANCE: VERTICAL AT 3 M

NO.	FREQ. (MHz)	EMISSION LEVEL (dBuV/m)	LIMIT (dBuV/m)	MARGIN (dB)	ANTENNA HEIGHT (m)	TABLE ANGLE (Degree)	RAW VALUE (dBuV)	CORRECTION FACTOR (dB/m)
1	#5470.00	59.4 PK	74.0	-14.6	1.00 V	5	57.20	2.20
2	#5470.00	45.7 AV	54.0	-8.3	1.00 V	5	43.50	2.20
3	*5550.00	110.2 PK			1.00 V	6	69.80	40.40
4	*5550.00	99.5 AV			1.00 V	6	59.10	40.40
5	11100.00	67.9 PK	74.0	-6.1	1.41 V	18	51.30	16.60
6	11100.00	52.7 AV	54.0	-1.3	1.41 V	18	36.10	16.60

REMARKS:

1. Emission Level(dBuV/m) = Raw Value(dBuV) + Correction Factor(dB/m)
2. Correction Factor(dB/m) = Antenna Factor(dB/m) + Cable Factor(dB)
3. The other emission levels were very low against the limit.
4. Margin value = Emission Level – Limit value
5. " * ": Fundamental frequency.
6. " # ": The radiated frequency is out of the restricted band.

CHANNEL	TX Channel 134	DETECTOR FUNCTION	Peak (PK)
FREQUENCY RANGE	1GHz ~ 40GHz		Average (AV)

ANTENNA POLARITY & TEST DISTANCE: HORIZONTAL AT 3 M

NO.	FREQ. (MHz)	EMISSION LEVEL (dBuV/m)	LIMIT (dBuV/m)	MARGIN (dB)	ANTENNA HEIGHT (m)	TABLE ANGLE (Degree)	RAW VALUE (dBuV)	CORRECTION FACTOR (dB/m)
1	*5670.00	103.2 PK			1.15 H	13	62.50	40.70
2	*5670.00	92.4 AV			1.15 H	13	51.70	40.70
3	#5725.00	57.2 PK	74.0	-16.8	1.00 H	12	54.60	2.60
4	#5725.00	44.6 AV	54.0	-9.4	1.00 H	12	42.00	2.60
5	11340.00	65.3 PK	74.0	-8.7	1.05 H	355	48.80	16.50
6	11340.00	51.7 AV	54.0	-2.3	1.05 H	355	35.20	16.50

ANTENNA POLARITY & TEST DISTANCE: VERTICAL AT 3 M

NO.	FREQ. (MHz)	EMISSION LEVEL (dBuV/m)	LIMIT (dBuV/m)	MARGIN (dB)	ANTENNA HEIGHT (m)	TABLE ANGLE (Degree)	RAW VALUE (dBuV)	CORRECTION FACTOR (dB/m)
1	*5670.00	105.9 PK			1.00 V	5	65.20	40.70
2	*5670.00	95.4 AV			1.00 V	5	54.70	40.70
3	#5725.00	57.1 PK	74.0	-16.9	1.00 V	288	54.50	2.60
4	#5725.00	44.7 AV	54.0	-9.3	1.00 V	288	42.10	2.60
5	11340.00	67.0 PK	74.0	-7.0	1.25 V	13	50.50	16.50
6	11340.00	52.5 AV	54.0	-1.5	1.25 V	13	36.00	16.50

REMARKS:

1. Emission Level(dBuV/m) = Raw Value(dBuV) + Correction Factor(dB/m)
2. Correction Factor(dB/m) = Antenna Factor(dB/m) + Cable Factor(dB)
3. The other emission levels were very low against the limit.
4. Margin value = Emission Level – Limit value
5. " * ": Fundamental frequency.
6. " # ": The radiated frequency is out of the restricted band.

802.11ac (VHT80)_2TX

CHANNEL	TX Channel 58	DETECTOR FUNCTION	Peak (PK)
FREQUENCY RANGE	1GHz ~ 40GHz		Average (AV)

ANTENNA POLARITY & TEST DISTANCE: HORIZONTAL AT 3 M

NO.	FREQ. (MHz)	EMISSION LEVEL (dBuV/m)	LIMIT (dBuV/m)	MARGIN (dB)	ANTENNA HEIGHT (m)	TABLE ANGLE (Degree)	RAW VALUE (dBuV)	CORRECTION FACTOR (dB/m)
1	*5290.00	105.3 PK			1.65 H	54	65.20	40.10
2	*5290.00	94.7 AV			1.65 H	54	54.60	40.10
3	5350.00	65.3 PK	74.0	-8.7	1.77 H	34	63.30	2.00
4	5350.00	51.7 AV	54.0	-2.3	1.77 H	34	49.70	2.00
5	#10580.00	59.9 PK	74.0	-14.1	1.49 H	170	44.00	15.90
6	#10580.00	47.0 AV	54.0	-7.0	1.49 H	170	31.10	15.90

ANTENNA POLARITY & TEST DISTANCE: VERTICAL AT 3 M

NO.	FREQ. (MHz)	EMISSION LEVEL (dBuV/m)	LIMIT (dBuV/m)	MARGIN (dB)	ANTENNA HEIGHT (m)	TABLE ANGLE (Degree)	RAW VALUE (dBuV)	CORRECTION FACTOR (dB/m)
1	*5290.00	105.4 PK			1.88 V	27	65.30	40.10
2	*5290.00	95.7 AV			1.88 V	27	55.60	40.10
3	5350.00	68.1 PK	74.0	-5.9	1.66 V	354	66.10	2.00
4	5350.00	53.0 AV	54.0	-1.0	1.66 V	354	51.00	2.00
5	#10580.00	60.1 PK	74.0	-13.9	1.59 V	100	44.20	15.90
6	#10580.00	46.9 AV	54.0	-7.1	1.59 V	100	31.00	15.90

REMARKS:

1. Emission Level(dBuV/m) = Raw Value(dBuV) + Correction Factor(dB/m)
2. Correction Factor(dB/m) = Antenna Factor(dB/m) + Cable Factor(dB)
3. The other emission levels were very low against the limit.
4. Margin value = Emission Level – Limit value
5. " * ": Fundamental frequency.
6. " # ": The radiated frequency is out of the restricted band.



CHANNEL	TX Channel 106	DETECTOR FUNCTION	Peak (PK)
FREQUENCY RANGE	1GHz ~ 40GHz		Average (AV)

ANTENNA POLARITY & TEST DISTANCE: HORIZONTAL AT 3 M

NO.	FREQ. (MHz)	EMISSION LEVEL (dBuV/m)	LIMIT (dBuV/m)	MARGIN (dB)	ANTENNA HEIGHT (m)	TABLE ANGLE (Degree)	RAW VALUE (dBuV)	CORRECTION FACTOR (dB/m)
1	5460.00	61.5 PK	74.0	-12.5	1.75 H	37	59.40	2.10
2	5460.00	49.1 AV	54.0	-4.9	1.75 H	37	47.00	2.10
3	#5470.00	64.9 PK	74.0	-9.1	1.76 H	37	62.70	2.20
4	#5470.00	52.2 AV	54.0	-1.8	1.76 H	37	50.00	2.20
5	*5530.00	101.5 PK			1.64 H	36	61.10	40.40
6	*5530.00	91.9 AV			1.64 H	36	51.50	40.40
7	11060.00	60.1 PK	74.0	-13.9	1.50 H	178	43.00	17.10
8	11060.00	47.1 AV	54.0	-6.9	1.50 H	178	30.00	17.10

ANTENNA POLARITY & TEST DISTANCE: VERTICAL AT 3 M

NO.	FREQ. (MHz)	EMISSION LEVEL (dBuV/m)	LIMIT (dBuV/m)	MARGIN (dB)	ANTENNA HEIGHT (m)	TABLE ANGLE (Degree)	RAW VALUE (dBuV)	CORRECTION FACTOR (dB/m)
1	5460.00	61.7 PK	74.0	-12.3	1.83 V	30	59.60	2.10
2	5460.00	48.7 AV	54.0	-5.3	1.83 V	30	46.60	2.10
3	#5470.00	66.2 PK	74.0	-7.8	1.84 V	27	64.00	2.20
4	#5470.00	52.6 AV	54.0	-1.4	1.84 V	27	50.40	2.20
5	*5530.00	101.8 PK			1.86 V	48	61.40	40.40
6	*5530.00	91.8 AV			1.86 V	48	51.40	40.40
7	11060.00	60.9 PK	74.0	-13.1	1.60 V	108	43.80	17.10
8	11060.00	47.8 AV	54.0	-6.2	1.60 V	108	30.70	17.10

REMARKS:

1. Emission Level(dBuV/m) = Raw Value(dBuV) + Correction Factor(dB/m)
2. Correction Factor(dB/m) = Antenna Factor(dB/m) + Cable Factor(dB)
3. The other emission levels were very low against the limit.
4. Margin value = Emission Level – Limit value
5. " * ": Fundamental frequency.
6. " # ": The radiated frequency is out of the restricted band.

802.11n (HT20)_3TX

CHANNEL	TX Channel 52	DETECTOR FUNCTION	Peak (PK)
FREQUENCY RANGE	1GHz ~ 40GHz		Average (AV)

ANTENNA POLARITY & TEST DISTANCE: HORIZONTAL AT 3 M

NO.	FREQ. (MHz)	EMISSION LEVEL (dBuV/m)	LIMIT (dBuV/m)	MARGIN (dB)	ANTENNA HEIGHT (m)	TABLE ANGLE (Degree)	RAW VALUE (dBuV)	CORRECTION FACTOR (dB/m)
1	#3506.00	46.6 PK	74.0	-27.4	1.00 H	261	48.40	-1.80
2	#3506.00	38.4 AV	54.0	-15.6	1.00 H	261	40.20	-1.80
3	5150.00	59.6 PK	74.0	-14.4	1.67 H	79	57.60	2.00
4	5150.00	47.8 AV	54.0	-6.2	1.67 H	79	45.80	2.00
5	*5260.00	114.9 PK			1.03 H	55	74.80	40.10
6	*5260.00	105.2 AV			1.03 H	55	65.10	40.10
7	#10520.00	60.5 PK	74.0	-13.5	1.00 H	316	45.20	15.30
8	#10520.00	47.4 AV	54.0	-6.6	1.00 H	316	32.10	15.30

ANTENNA POLARITY & TEST DISTANCE: VERTICAL AT 3 M

NO.	FREQ. (MHz)	EMISSION LEVEL (dBuV/m)	LIMIT (dBuV/m)	MARGIN (dB)	ANTENNA HEIGHT (m)	TABLE ANGLE (Degree)	RAW VALUE (dBuV)	CORRECTION FACTOR (dB/m)
1	#3506.00	47.9 PK	74.0	-26.1	1.03 V	341	49.70	-1.80
2	#3506.00	40.6 AV	54.0	-13.4	1.03 V	341	42.40	-1.80
3	5150.00	59.3 PK	74.0	-14.7	1.11 V	347	57.30	2.00
4	5150.00	47.3 AV	54.0	-6.7	1.11 V	347	45.30	2.00
5	*5260.00	114.9 PK			1.00 V	25	74.80	40.10
6	*5260.00	105.0 AV			1.00 V	25	64.90	40.10
7	#10520.00	59.7 PK	74.0	-14.3	1.00 V	87	44.40	15.30
8	#10520.00	47.5 AV	54.0	-6.5	1.00 V	87	32.20	15.30

REMARKS:

1. Emission Level(dBuV/m) = Raw Value(dBuV) + Correction Factor(dB/m)
2. Correction Factor(dB/m) = Antenna Factor(dB/m) + Cable Factor(dB)
3. The other emission levels were very low against the limit.
4. Margin value = Emission Level – Limit value
5. " * ": Fundamental frequency.
6. " # ": The radiated frequency is out of the restricted band.

CHANNEL	TX Channel 60	DETECTOR FUNCTION	Peak (PK)
FREQUENCY RANGE	1GHz ~ 40GHz		Average (AV)

ANTENNA POLARITY & TEST DISTANCE: HORIZONTAL AT 3 M

NO.	FREQ. (MHz)	EMISSION LEVEL (dBuV/m)	LIMIT (dBuV/m)	MARGIN (dB)	ANTENNA HEIGHT (m)	TABLE ANGLE (Degree)	RAW VALUE (dBuV)	CORRECTION FACTOR (dB/m)
1	#3533.00	48.0 PK	74.0	-26.0	1.54 H	321	49.70	-1.70
2	#3533.00	41.3 AV	54.0	-12.7	1.54 H	321	43.00	-1.70
3	*5300.00	114.2 PK			1.00 H	46	74.10	40.10
4	*5300.00	104.6 AV			1.00 H	46	64.50	40.10
5	10600.00	61.6 PK	74.0	-12.4	1.00 H	49	45.40	16.20
6	10600.00	48.8 AV	54.0	-5.2	1.00 H	49	32.60	16.20

ANTENNA POLARITY & TEST DISTANCE: VERTICAL AT 3 M

NO.	FREQ. (MHz)	EMISSION LEVEL (dBuV/m)	LIMIT (dBuV/m)	MARGIN (dB)	ANTENNA HEIGHT (m)	TABLE ANGLE (Degree)	RAW VALUE (dBuV)	CORRECTION FACTOR (dB/m)
1	#3533.00	48.1 PK	74.0	-25.9	1.03 V	16	49.80	-1.70
2	#3533.00	41.5 AV	54.0	-12.5	1.03 V	16	43.20	-1.70
3	*5300.00	116.4 PK			1.00 V	33	76.30	40.10
4	*5300.00	106.1 AV			1.00 V	33	66.00	40.10
5	10600.00	64.2 PK	74.0	-9.8	1.17 V	27	48.00	16.20
6	10600.00	50.4 AV	54.0	-3.6	1.17 V	27	34.20	16.20

REMARKS:

1. Emission Level(dBuV/m) = Raw Value(dBuV) + Correction Factor(dB/m)
2. Correction Factor(dB/m) = Antenna Factor(dB/m) + Cable Factor(dB)
3. The other emission levels were very low against the limit.
4. Margin value = Emission Level – Limit value
5. " * ": Fundamental frequency.
6. " # ": The radiated frequency is out of the restricted band.

CHANNEL	TX Channel 64	DETECTOR FUNCTION	Peak (PK)
FREQUENCY RANGE	1GHz ~ 40GHz		Average (AV)

ANTENNA POLARITY & TEST DISTANCE: HORIZONTAL AT 3 M

NO.	FREQ. (MHz)	EMISSION LEVEL (dBuV/m)	LIMIT (dBuV/m)	MARGIN (dB)	ANTENNA HEIGHT (m)	TABLE ANGLE (Degree)	RAW VALUE (dBuV)	CORRECTION FACTOR (dB/m)
1	#3546.00	45.5 PK	74.0	-28.5	1.00 H	285	47.30	-1.80
2	#3546.00	38.2 AV	54.0	-15.8	1.00 H	285	40.00	-1.80
3	*5320.00	111.9 PK			1.00 H	343	71.70	40.20
4	*5320.00	103.0 AV			1.00 H	343	62.80	40.20
5	5350.00	61.3 PK	74.0	-12.7	1.00 H	38	59.30	2.00
6	5350.00	48.0 AV	54.0	-6.0	1.00 H	38	46.00	2.00
7	10640.00	59.9 PK	74.0	-14.1	1.00 H	323	43.60	16.30
8	10640.00	46.8 AV	54.0	-7.2	1.00 H	323	30.50	16.30

ANTENNA POLARITY & TEST DISTANCE: VERTICAL AT 3 M

NO.	FREQ. (MHz)	EMISSION LEVEL (dBuV/m)	LIMIT (dBuV/m)	MARGIN (dB)	ANTENNA HEIGHT (m)	TABLE ANGLE (Degree)	RAW VALUE (dBuV)	CORRECTION FACTOR (dB/m)
1	#3546.00	47.1 PK	74.0	-26.9	1.05 V	34	48.90	-1.80
2	#3546.00	41.0 AV	54.0	-13.0	1.05 V	34	42.80	-1.80
3	*5320.00	115.2 PK			1.00 V	41	75.00	40.20
4	*5320.00	105.2 AV			1.00 V	41	65.00	40.20
5	5350.00	63.1 PK	74.0	-10.9	1.08 V	44	61.10	2.00
6	5350.00	48.4 AV	54.0	-5.6	1.08 V	44	46.40	2.00
7	10640.00	61.2 PK	74.0	-12.8	1.28 V	16	44.90	16.30
8	10640.00	48.2 AV	54.0	-5.8	1.28 V	16	31.90	16.30

REMARKS:

1. Emission Level(dBuV/m) = Raw Value(dBuV) + Correction Factor(dB/m)
2. Correction Factor(dB/m) = Antenna Factor(dB/m) + Cable Factor(dB)
3. The other emission levels were very low against the limit.
4. Margin value = Emission Level – Limit value
5. " * ": Fundamental frequency.
6. " # ": The radiated frequency is out of the restricted band.



CHANNEL	TX Channel 100	DETECTOR FUNCTION	Peak (PK)
FREQUENCY RANGE	1GHz ~ 40GHz		Average (AV)

ANTENNA POLARITY & TEST DISTANCE: HORIZONTAL AT 3 M

NO.	FREQ. (MHz)	EMISSION LEVEL (dBuV/m)	LIMIT (dBuV/m)	MARGIN (dB)	ANTENNA HEIGHT (m)	TABLE ANGLE (Degree)	RAW VALUE (dBuV)	CORRECTION FACTOR (dB/m)
1	3666.00	46.8 PK	74.0	-27.2	1.00 H	280	48.10	-1.30
2	3666.00	36.9 AV	54.0	-17.1	1.00 H	280	38.20	-1.30
3	5460.00	59.4 PK	74.0	-14.6	1.00 H	30	57.30	2.10
4	5460.00	46.0 AV	54.0	-8.0	1.00 H	30	43.90	2.10
5	#5470.00	61.0 PK	74.0	-13.0	1.00 H	31	58.80	2.20
6	#5470.00	46.5 AV	54.0	-7.5	1.00 H	31	44.30	2.20
7	*5500.00	110.8 PK			1.00 H	26	70.50	40.30
8	*5500.00	100.8 AV			1.00 H	26	60.50	40.30
9	11000.00	64.3 PK	74.0	-9.7	1.00 H	8	46.60	17.70
10	11000.00	50.9 AV	54.0	-3.1	1.00 H	8	33.20	17.70

ANTENNA POLARITY & TEST DISTANCE: VERTICAL AT 3 M

NO.	FREQ. (MHz)	EMISSION LEVEL (dBuV/m)	LIMIT (dBuV/m)	MARGIN (dB)	ANTENNA HEIGHT (m)	TABLE ANGLE (Degree)	RAW VALUE (dBuV)	CORRECTION FACTOR (dB/m)
1	3666.00	46.2 PK	74.0	-27.8	1.00 V	7	47.50	-1.30
2	3666.00	36.7 AV	54.0	-17.3	1.00 V	7	38.00	-1.30
3	5460.00	59.2 PK	74.0	-14.8	1.00 V	4	57.10	2.10
4	5460.00	46.8 AV	54.0	-7.2	1.00 V	4	44.70	2.10
5	#5470.00	60.7 PK	74.0	-13.3	1.00 V	7	58.50	2.20
6	#5470.00	47.5 AV	54.0	-6.5	1.00 V	7	45.30	2.20
7	*5500.00	114.2 PK			1.32 V	29	73.90	40.30
8	*5500.00	104.0 AV			1.32 V	29	63.70	40.30
9	11000.00	68.5 PK	74.0	-5.5	1.24 V	23	50.80	17.70
10	11000.00	53.0 AV	54.0	-1.0	1.24 V	23	35.30	17.70

REMARKS:

1. Emission Level(dBuV/m) = Raw Value(dBuV) + Correction Factor(dB/m)
2. Correction Factor(dB/m) = Antenna Factor(dB/m) + Cable Factor(dB)
3. The other emission levels were very low against the limit.
4. Margin value = Emission Level – Limit value

CHANNEL	TX Channel 116	DETECTOR FUNCTION	Peak (PK)
FREQUENCY RANGE	1GHz ~ 40GHz		Average (AV)

ANTENNA POLARITY & TEST DISTANCE: HORIZONTAL AT 3 M

NO.	FREQ. (MHz)	EMISSION LEVEL (dBuV/m)	LIMIT (dBuV/m)	MARGIN (dB)	ANTENNA HEIGHT (m)	TABLE ANGLE (Degree)	RAW VALUE (dBuV)	CORRECTION FACTOR (dB/m)
1	#3720.00	45.4 PK	74.0	-28.6	1.00 H	92	46.30	-0.90
2	#3720.00	35.7 AV	54.0	-18.3	1.00 H	92	36.60	-0.90
3	*5580.00	111.4 PK			1.05 H	46	70.90	40.50
4	*5580.00	101.3 AV			1.05 H	46	60.80	40.50
5	#11160.00	64.2 PK	74.0	-9.8	1.00 H	51	47.80	16.40
6	#11160.00	50.0 AV	54.0	-4.0	1.00 H	51	33.60	16.40

ANTENNA POLARITY & TEST DISTANCE: VERTICAL AT 3 M

NO.	FREQ. (MHz)	EMISSION LEVEL (dBuV/m)	LIMIT (dBuV/m)	MARGIN (dB)	ANTENNA HEIGHT (m)	TABLE ANGLE (Degree)	RAW VALUE (dBuV)	CORRECTION FACTOR (dB/m)
1	#3720.00	44.8 PK	74.0	-29.2	1.00 V	1	45.70	-0.90
2	#3720.00	35.1 AV	54.0	-18.9	1.00 V	1	36.00	-0.90
3	*5580.00	115.1 PK			1.00 V	19	74.60	40.50
4	*5580.00	105.2 AV			1.00 V	19	64.70	40.50
5	#11160.00	67.7 PK	74.0	-6.3	1.36 V	23	51.30	16.40
6	#11160.00	53.0 AV	54.0	-1.0	1.36 V	23	36.60	16.40

REMARKS:

1. Emission Level(dBuV/m) = Raw Value(dBuV) + Correction Factor(dB/m)
2. Correction Factor(dB/m) = Antenna Factor(dB/m) + Cable Factor(dB)
3. The other emission levels were very low against the limit.
4. Margin value = Emission Level – Limit value

CHANNEL	TX Channel 140	DETECTOR FUNCTION	Peak (PK)
FREQUENCY RANGE	1GHz ~ 40GHz		Average (AV)

ANTENNA POLARITY & TEST DISTANCE: HORIZONTAL AT 3 M

NO.	FREQ. (MHz)	EMISSION LEVEL (dBuV/m)	LIMIT (dBuV/m)	MARGIN (dB)	ANTENNA HEIGHT (m)	TABLE ANGLE (Degree)	RAW VALUE (dBuV)	CORRECTION FACTOR (dB/m)
1	#3800.00	45.1 PK	74.0	-28.9	1.00 H	13	45.80	-0.70
2	#3800.00	35.3 AV	54.0	-18.7	1.00 H	13	36.00	-0.70
3	*5700.00	110.4 PK			1.50 H	72	69.60	40.80
4	*5700.00	99.9 AV			1.50 H	72	59.10	40.80
5	#5725.00	60.5 PK	74.0	-13.5	1.00 H	337	57.90	2.60
6	#5725.00	46.8 AV	54.0	-7.2	1.00 H	337	44.20	2.60
7	#11400.00	65.5 PK	74.0	-8.5	1.34 H	336	49.30	16.20
8	#11400.00	51.6 AV	54.0	-2.4	1.34 H	336	35.40	16.20

ANTENNA POLARITY & TEST DISTANCE: VERTICAL AT 3 M

NO.	FREQ. (MHz)	EMISSION LEVEL (dBuV/m)	LIMIT (dBuV/m)	MARGIN (dB)	ANTENNA HEIGHT (m)	TABLE ANGLE (Degree)	RAW VALUE (dBuV)	CORRECTION FACTOR (dB/m)
1	#3800.00	45.2 PK	74.0	-28.8	1.00 V	74	45.90	-0.70
2	#3800.00	34.8 AV	54.0	-19.2	1.00 V	74	35.50	-0.70
3	*5700.00	109.1 PK			1.02 V	44	68.30	40.80
4	*5700.00	98.9 AV			1.02 V	44	58.10	40.80
5	#5725.00	59.8 PK	74.0	-14.2	1.00 V	82	57.20	2.60
6	#5725.00	46.5 AV	54.0	-7.5	1.00 V	82	43.90	2.60
7	#11400.00	67.7 PK	74.0	-6.3	1.02 V	28	51.50	16.20
8	#11400.00	52.9 AV	54.0	-1.1	1.02 V	28	36.70	16.20

REMARKS:

1. Emission Level(dBuV/m) = Raw Value(dBuV) + Correction Factor(dB/m)
2. Correction Factor(dB/m) = Antenna Factor(dB/m) + Cable Factor(dB)
3. The other emission levels were very low against the limit.
4. Margin value = Emission Level – Limit value

802.11n (HT40)_3TX

CHANNEL	TX Channel 54	DETECTOR FUNCTION	Peak (PK)
FREQUENCY RANGE	1GHz ~ 40GHz		Average (AV)

ANTENNA POLARITY & TEST DISTANCE: HORIZONTAL AT 3 M

NO.	FREQ. (MHz)	EMISSION LEVEL (dBuV/m)	LIMIT (dBuV/m)	MARGIN (dB)	ANTENNA HEIGHT (m)	TABLE ANGLE (Degree)	RAW VALUE (dBuV)	CORRECTION FACTOR (dB/m)
1	#3513.00	47.1 PK	74.0	-26.9	1.00 H	121	48.80	-1.70
2	#3513.00	38.8 AV	54.0	-15.2	1.00 H	121	40.50	-1.70
3	#5150.00	59.7 PK	74.0	-14.3	1.50 H	166	57.70	2.00
4	#5150.00	47.1 AV	54.0	-6.9	1.50 H	166	45.10	2.00
5	*5270.00	112.6 PK			1.10 H	140	72.50	40.10
6	*5270.00	102.3 AV			1.10 H	140	62.20	40.10
7	#10540.00	60.0 PK	74.0	-14.0	1.00 H	300	44.40	15.60
8	#10540.00	47.9 AV	54.0	-6.1	1.00 H	300	32.30	15.60

ANTENNA POLARITY & TEST DISTANCE: VERTICAL AT 3 M

NO.	FREQ. (MHz)	EMISSION LEVEL (dBuV/m)	LIMIT (dBuV/m)	MARGIN (dB)	ANTENNA HEIGHT (m)	TABLE ANGLE (Degree)	RAW VALUE (dBuV)	CORRECTION FACTOR (dB/m)
1	#3513.00	47.6 PK	74.0	-26.4	1.00 V	190	49.30	-1.70
2	#3513.00	40.1 AV	54.0	-13.9	1.00 V	190	41.80	-1.70
3	#5150.00	58.8 PK	74.0	-15.2	1.20 V	137	56.80	2.00
4	#5150.00	46.2 AV	54.0	-7.8	1.20 V	137	44.20	2.00
5	*5270.00	113.9 PK			1.00 V	122	73.80	40.10
6	*5270.00	103.4 AV			1.00 V	122	63.30	40.10
7	#10540.00	62.9 PK	74.0	-11.1	1.10 V	18	47.30	15.60
8	#10540.00	49.0 AV	54.0	-5.0	1.10 V	18	33.40	15.60

REMARKS:

1. Emission Level(dBuV/m) = Raw Value(dBuV) + Correction Factor(dB/m)
2. Correction Factor(dB/m) = Antenna Factor(dB/m) + Cable Factor(dB)
3. The other emission levels were very low against the limit.
4. Margin value = Emission Level – Limit value
5. " * ": Fundamental frequency.

CHANNEL	TX Channel 62	DETECTOR FUNCTION	Peak (PK)
FREQUENCY RANGE	1GHz ~ 40GHz		Average (AV)

ANTENNA POLARITY & TEST DISTANCE: HORIZONTAL AT 3 M

NO.	FREQ. (MHz)	EMISSION LEVEL (dBuV/m)	LIMIT (dBuV/m)	MARGIN (dB)	ANTENNA HEIGHT (m)	TABLE ANGLE (Degree)	RAW VALUE (dBuV)	CORRECTION FACTOR (dB/m)
1	#3540.00	48.1 PK	74.0	-25.9	1.19 H	300	49.90	-1.80
2	#3540.00	42.5 AV	54.0	-11.5	1.19 H	300	44.30	-1.80
3	*5310.00	113.0 PK			1.01 H	70	72.90	40.10
4	*5310.00	103.1 AV			1.01 H	75	63.00	40.10
5	#5350.00	64.2 PK	74.0	-9.8	1.01 H	75	62.20	2.00
6	#5350.00	51.7 AV	54.0	-2.3	1.01 H	75	49.70	2.00
7	#10620.00	60.4 PK	74.0	-13.6	1.00 H	120	44.20	16.20
8	#10620.00	47.9 AV	54.0	-6.1	1.00 H	120	31.70	16.20

ANTENNA POLARITY & TEST DISTANCE: VERTICAL AT 3 M

NO.	FREQ. (MHz)	EMISSION LEVEL (dBuV/m)	LIMIT (dBuV/m)	MARGIN (dB)	ANTENNA HEIGHT (m)	TABLE ANGLE (Degree)	RAW VALUE (dBuV)	CORRECTION FACTOR (dB/m)
1	#3540.00	48.6 PK	74.0	-25.4	1.00 V	100	50.40	-1.80
2	#3540.00	42.3 AV	54.0	-11.7	1.00 V	100	44.10	-1.80
3	*5310.00	114.2 PK			1.05 V	45	74.10	40.10
4	*5310.00	104.7 AV			1.05 V	45	64.60	40.10
5	#5350.00	64.0 PK	74.0	-10.0	1.05 V	40	62.00	2.00
6	#5350.00	51.6 AV	54.0	-2.4	1.05 V	40	49.60	2.00
7	#10620.00	62.1 PK	74.0	-11.9	1.00 V	21	45.90	16.20
8	#10620.00	49.3 AV	54.0	-4.7	1.00 V	21	33.10	16.20

REMARKS:

1. Emission Level(dBuV/m) = Raw Value(dBuV) + Correction Factor(dB/m)
2. Correction Factor(dB/m) = Antenna Factor(dB/m) + Cable Factor(dB)
3. The other emission levels were very low against the limit.
4. Margin value = Emission Level – Limit value
5. " * ": Fundamental frequency.

CHANNEL	TX Channel 102	DETECTOR FUNCTION	Peak (PK)
FREQUENCY RANGE	1GHz ~ 40GHz		Average (AV)

ANTENNA POLARITY & TEST DISTANCE: HORIZONTAL AT 3 M

NO.	FREQ. (MHz)	EMISSION LEVEL (dBuV/m)	LIMIT (dBuV/m)	MARGIN (dB)	ANTENNA HEIGHT (m)	TABLE ANGLE (Degree)	RAW VALUE (dBuV)	CORRECTION FACTOR (dB/m)
1	#3673.00	44.8 PK	74.0	-29.2	1.00 H	82	46.10	-1.30
2	#3673.00	35.7 AV	54.0	-18.3	1.00 H	82	37.00	-1.30
3	#5460.00	61.9 PK	74.0	-12.1	1.06 H	77	59.80	2.10
4	#5460.00	47.7 AV	54.0	-6.3	1.06 H	77	45.60	2.10
5	#5470.00	65.0 PK	74.0	-9.0	1.07 H	61	62.80	2.20
6	#5470.00	50.0 AV	54.0	-4.0	1.07 H	61	47.80	2.20
7	*5510.00	107.3 PK			1.00 H	26	67.00	40.30
8	*5510.00	97.7 AV			1.00 H	26	57.40	40.30
9	#11020.00	62.4 PK	74.0	-11.6	1.02 H	7	45.00	17.40
10	#11020.00	49.2 AV	54.0	-4.8	1.02 H	7	31.80	17.40

ANTENNA POLARITY & TEST DISTANCE: VERTICAL AT 3 M

NO.	FREQ. (MHz)	EMISSION LEVEL (dBuV/m)	LIMIT (dBuV/m)	MARGIN (dB)	ANTENNA HEIGHT (m)	TABLE ANGLE (Degree)	RAW VALUE (dBuV)	CORRECTION FACTOR (dB/m)
1	#3673.00	47.3 PK	74.0	-26.7	1.00 V	2	48.60	-1.30
2	#3673.00	37.6 AV	54.0	-16.4	1.00 V	2	38.90	-1.30
3	#5460.00	62.6 PK	74.0	-11.4	1.13 V	18	60.50	2.10
4	#5460.00	49.3 AV	54.0	-4.7	1.13 V	18	47.20	2.10
5	#5470.00	68.8 PK	74.0	-5.2	1.10 V	28	66.60	2.20
6	#5470.00	53.0 AV	54.0	-1.0	1.10 V	28	50.80	2.20
7	*5510.00	110.1 PK			1.00 V	22	69.80	40.30
8	*5510.00	100.8 AV			1.00 V	22	60.50	40.30
9	#11020.00	66.7 PK	74.0	-7.3	1.17 V	25	49.30	17.40
10	#11020.00	51.6 AV	54.0	-2.4	1.17 V	25	34.20	17.40

REMARKS:

1. Emission Level(dBuV/m) = Raw Value(dBuV) + Correction Factor(dB/m)
2. Correction Factor(dB/m) = Antenna Factor(dB/m) + Cable Factor(dB)
3. The other emission levels were very low against the limit.
4. Margin value = Emission Level – Limit value
5. " * ": Fundamental frequency.

CHANNEL	TX Channel 110	DETECTOR FUNCTION	Peak (PK)
FREQUENCY RANGE	1GHz ~ 40GHz		Average (AV)

ANTENNA POLARITY & TEST DISTANCE: HORIZONTAL AT 3 M

NO.	FREQ. (MHz)	EMISSION LEVEL (dBuV/m)	LIMIT (dBuV/m)	MARGIN (dB)	ANTENNA HEIGHT (m)	TABLE ANGLE (Degree)	RAW VALUE (dBuV)	CORRECTION FACTOR (dB/m)
1	3700.00	44.5 PK	74.0	-29.5	1.00 H	328	45.50	-1.00
2	3700.00	33.2 AV	54.0	-20.8	1.00 H	328	34.20	-1.00
3	*5550.00	110.2 PK			1.00 H	350	69.80	40.40
4	*5550.00	100.5 AV			1.00 H	350	60.10	40.40
5	11100.00	62.5 PK	74.0	-11.5	1.40 H	8	45.90	16.60
6	11100.00	49.6 AV	54.0	-4.4	1.40 H	8	33.00	16.60

ANTENNA POLARITY & TEST DISTANCE: VERTICAL AT 3 M

NO.	FREQ. (MHz)	EMISSION LEVEL (dBuV/m)	LIMIT (dBuV/m)	MARGIN (dB)	ANTENNA HEIGHT (m)	TABLE ANGLE (Degree)	RAW VALUE (dBuV)	CORRECTION FACTOR (dB/m)
1	3700.00	45.7 PK	74.0	-28.3	1.12 V	336	46.70	-1.00
2	3700.00	33.6 AV	54.0	-20.4	1.12 V	336	34.60	-1.00
3	*5550.00	112.0 PK			1.00 V	28	71.60	40.40
4	*5550.00	101.4 AV			1.00 V	28	61.00	40.40
5	11100.00	64.0 PK	74.0	-10.0	1.45 V	21	47.40	16.60
6	11100.00	51.6 AV	54.0	-2.4	1.45 V	21	35.00	16.60

REMARKS:

1. Emission Level(dBuV/m) = Raw Value(dBuV) + Correction Factor(dB/m)
2. Correction Factor(dB/m) = Antenna Factor(dB/m) + Cable Factor(dB)
3. The other emission levels were very low against the limit.
4. Margin value = Emission Level – Limit value
5. " * ": Fundamental frequency.

CHANNEL	TX Channel 134	DETECTOR FUNCTION	Peak (PK)
FREQUENCY RANGE	1GHz ~ 40GHz		Average (AV)

ANTENNA POLARITY & TEST DISTANCE: HORIZONTAL AT 3 M

NO.	FREQ. (MHz)	EMISSION LEVEL (dBuV/m)	LIMIT (dBuV/m)	MARGIN (dB)	ANTENNA HEIGHT (m)	TABLE ANGLE (Degree)	RAW VALUE (dBuV)	CORRECTION FACTOR (dB/m)
1	3780.00	44.8 PK	74.0	-29.2	1.14 H	81	45.50	-0.70
2	3780.00	34.5 AV	54.0	-19.5	1.14 H	81	35.20	-0.70
3	*5670.00	106.0 PK			1.00 H	340	65.30	40.70
4	*5670.00	96.7 AV			1.00 H	340	56.00	40.70
5	#5725.00	58.9 PK	74.0	-15.1	1.00 H	82	56.30	2.60
6	#5725.00	46.6 AV	54.0	-7.4	1.00 H	82	44.00	2.60
7	11340.00	62.3 PK	74.0	-11.7	1.12 H	71	45.80	16.50
8	11340.00	50.0 AV	54.0	-4.0	1.12 H	71	33.50	16.50

ANTENNA POLARITY & TEST DISTANCE: VERTICAL AT 3 M

NO.	FREQ. (MHz)	EMISSION LEVEL (dBuV/m)	LIMIT (dBuV/m)	MARGIN (dB)	ANTENNA HEIGHT (m)	TABLE ANGLE (Degree)	RAW VALUE (dBuV)	CORRECTION FACTOR (dB/m)
1	3780.00	44.8 PK	74.0	-29.2	1.01 V	73	45.50	-0.70
2	3780.00	35.2 AV	54.0	-18.8	1.01 V	73	35.90	-0.70
3	*5670.00	108.8 PK			1.00 V	354	68.10	40.70
4	*5670.00	99.0 AV			1.00 V	354	58.30	40.70
5	#5725.00	58.9 PK	74.0	-15.1	1.00 V	39	56.30	2.60
6	#5725.00	46.6 AV	54.0	-7.4	1.00 V	39	44.00	2.60
7	11340.00	66.8 PK	74.0	-7.2	1.35 V	24	50.30	16.50
8	11340.00	52.9 AV	54.0	-1.1	1.35 V	24	36.40	16.50

REMARKS:

1. Emission Level(dBuV/m) = Raw Value(dBuV) + Correction Factor(dB/m)
2. Correction Factor(dB/m) = Antenna Factor(dB/m) + Cable Factor(dB)
3. The other emission levels were very low against the limit.
4. Margin value = Emission Level – Limit value
5. " * ": Fundamental frequency.
6. " # ": The radiated frequency is out of the restricted band.

802.11ac (VHT20)_3TX

CHANNEL	TX Channel 52	DETECTOR FUNCTION	Peak (PK)
FREQUENCY RANGE	1GHz ~ 40GHz		Average (AV)

ANTENNA POLARITY & TEST DISTANCE: HORIZONTAL AT 3 M								
NO.	FREQ. (MHz)	EMISSION LEVEL (dBuV/m)	LIMIT (dBuV/m)	MARGIN (dB)	ANTENNA HEIGHT (m)	TABLE ANGLE (Degree)	RAW VALUE (dBuV)	CORRECTION FACTOR (dB/m)
1	#3506.00	45.4 PK	74.0	-28.6	1.23 H	278	47.20	-1.80
2	#3506.00	36.5 AV	54.0	-17.5	1.23 H	278	38.30	-1.80
3	5150.00	59.0 PK	74.0	-15.0	1.20 H	72	57.00	2.00
4	5150.00	46.5 AV	54.0	-7.5	1.20 H	72	44.50	2.00
5	*5260.00	116.1 PK			1.01 H	65	76.00	40.10
6	*5260.00	106.2 AV			1.01 H	65	66.10	40.10
7	#10520.00	60.2 PK	74.0	-13.8	1.00 H	318	44.90	15.30
8	#10520.00	47.2 AV	54.0	-6.8	1.00 H	318	31.90	15.30

ANTENNA POLARITY & TEST DISTANCE: VERTICAL AT 3 M								
NO.	FREQ. (MHz)	EMISSION LEVEL (dBuV/m)	LIMIT (dBuV/m)	MARGIN (dB)	ANTENNA HEIGHT (m)	TABLE ANGLE (Degree)	RAW VALUE (dBuV)	CORRECTION FACTOR (dB/m)
1	#3506.00	47.7 PK	74.0	-26.3	1.01 V	321	49.50	-1.80
2	#3506.00	40.3 AV	54.0	-13.7	1.01 V	321	42.10	-1.80
3	5150.00	59.2 PK	74.0	-14.8	1.09 V	349	57.20	2.00
4	5150.00	46.9 AV	54.0	-7.1	1.09 V	349	44.90	2.00
5	*5260.00	116.9 PK			1.00 V	27	76.80	40.10
6	*5260.00	106.9 AV			1.00 V	27	66.80	40.10
7	#10520.00	59.8 PK	74.0	-14.2	1.00 V	93	44.50	15.30
8	#10520.00	47.6 AV	54.0	-6.4	1.00 V	93	32.30	15.30

REMARKS:

1. Emission Level(dBuV/m) = Raw Value(dBuV) + Correction Factor(dB/m)
2. Correction Factor(dB/m) = Antenna Factor(dB/m) + Cable Factor(dB)
3. The other emission levels were very low against the limit.
4. Margin value = Emission Level – Limit value
5. " * ": Fundamental frequency.
6. " # ": The radiated frequency is out of the restricted band.

CHANNEL	TX Channel 60	DETECTOR FUNCTION	Peak (PK)
FREQUENCY RANGE	1GHz ~ 40GHz		Average (AV)

ANTENNA POLARITY & TEST DISTANCE: HORIZONTAL AT 3 M

NO.	FREQ. (MHz)	EMISSION LEVEL (dBuV/m)	LIMIT (dBuV/m)	MARGIN (dB)	ANTENNA HEIGHT (m)	TABLE ANGLE (Degree)	RAW VALUE (dBuV)	CORRECTION FACTOR (dB/m)
1	#3533.00	48.1 PK	74.0	-25.9	1.46 H	316	49.80	-1.70
2	#3533.00	41.4 AV	54.0	-12.6	1.46 H	316	43.10	-1.70
3	*5300.00	115.3 PK			1.00 H	68	75.20	40.10
4	*5300.00	105.8 AV			1.00 H	68	65.70	40.10
5	10600.00	61.5 PK	74.0	-12.5	1.00 H	52	45.30	16.20
6	10600.00	48.7 AV	54.0	-5.3	1.00 H	52	32.50	16.20

ANTENNA POLARITY & TEST DISTANCE: VERTICAL AT 3 M

NO.	FREQ. (MHz)	EMISSION LEVEL (dBuV/m)	LIMIT (dBuV/m)	MARGIN (dB)	ANTENNA HEIGHT (m)	TABLE ANGLE (Degree)	RAW VALUE (dBuV)	CORRECTION FACTOR (dB/m)
1	#3533.00	47.9 PK	74.0	-26.1	1.01 V	18	49.60	-1.70
2	#3533.00	41.4 AV	54.0	-12.6	1.01 V	18	43.10	-1.70
3	*5300.00	116.9 PK			1.00 V	18	76.80	40.10
4	*5300.00	106.3 AV			1.00 V	18	66.20	40.10
5	10600.00	64.5 PK	74.0	-9.5	1.16 V	29	48.30	16.20
6	10600.00	50.8 AV	54.0	-3.2	1.16 V	29	34.60	16.20

REMARKS:

1. Emission Level(dBuV/m) = Raw Value(dBuV) + Correction Factor(dB/m)
2. Correction Factor(dB/m) = Antenna Factor(dB/m) + Cable Factor(dB)
3. The other emission levels were very low against the limit.
4. Margin value = Emission Level – Limit value
5. " * ": Fundamental frequency.
6. " # ": The radiated frequency is out of the restricted band.



CHANNEL	TX Channel 64	DETECTOR FUNCTION	Peak (PK)
FREQUENCY RANGE	1GHz ~ 40GHz		Average (AV)

ANTENNA POLARITY & TEST DISTANCE: HORIZONTAL AT 3 M

NO.	FREQ. (MHz)	EMISSION LEVEL (dBuV/m)	LIMIT (dBuV/m)	MARGIN (dB)	ANTENNA HEIGHT (m)	TABLE ANGLE (Degree)	RAW VALUE (dBuV)	CORRECTION FACTOR (dB/m)
1	#3546.00	46.1 PK	74.0	-27.9	1.01 H	282	47.90	-1.80
2	#3546.00	36.9 AV	54.0	-17.1	1.01 H	282	38.70	-1.80
3	*5320.00	115.5 PK			1.00 H	65	75.30	40.20
4	*5320.00	105.0 AV			1.00 H	65	64.80	40.20
5	5350.00	65.6 PK	74.0	-8.4	1.25 H	296	63.60	2.00
6	5350.00	49.9 AV	54.0	-4.1	1.25 H	296	47.90	2.00
7	10640.00	59.1 PK	74.0	-14.9	1.00 H	332	42.80	16.30
8	10640.00	46.0 AV	54.0	-8.0	1.00 H	332	29.70	16.30

ANTENNA POLARITY & TEST DISTANCE: VERTICAL AT 3 M

NO.	FREQ. (MHz)	EMISSION LEVEL (dBuV/m)	LIMIT (dBuV/m)	MARGIN (dB)	ANTENNA HEIGHT (m)	TABLE ANGLE (Degree)	RAW VALUE (dBuV)	CORRECTION FACTOR (dB/m)
1	#3546.00	47.0 PK	74.0	-27.0	1.04 V	33	48.80	-1.80
2	#3546.00	40.8 AV	54.0	-13.2	1.04 V	33	42.60	-1.80
3	*5320.00	116.3 PK			1.00 V	48	76.10	40.20
4	*5320.00	105.8 AV			1.00 V	48	65.60	40.20
5	5350.00	65.2 PK	74.0	-8.8	1.00 V	50	63.20	2.00
6	5350.00	49.9 AV	54.0	-4.1	1.00 V	50	47.90	2.00
7	10640.00	61.4 PK	74.0	-12.6	1.16 V	13	45.10	16.30
8	10640.00	48.4 AV	54.0	-5.6	1.16 V	13	32.10	16.30

REMARKS:

1. Emission Level(dBuV/m) = Raw Value(dBuV) + Correction Factor(dB/m)
2. Correction Factor(dB/m) = Antenna Factor(dB/m) + Cable Factor(dB)
3. The other emission levels were very low against the limit.
4. Margin value = Emission Level – Limit value
5. " * ": Fundamental frequency.
6. " # ": The radiated frequency is out of the restricted band.

CHANNEL	TX Channel 100	DETECTOR FUNCTION	Peak (PK)
FREQUENCY RANGE	1GHz ~ 40GHz		Average (AV)

ANTENNA POLARITY & TEST DISTANCE: HORIZONTAL AT 3 M

NO.	FREQ. (MHz)	EMISSION LEVEL (dBuV/m)	LIMIT (dBuV/m)	MARGIN (dB)	ANTENNA HEIGHT (m)	TABLE ANGLE (Degree)	RAW VALUE (dBuV)	CORRECTION FACTOR (dB/m)
1	3666.00	46.9 PK	74.0	-27.1	1.00 H	274	48.20	-1.30
2	3666.00	37.1 AV	54.0	-16.9	1.00 H	274	38.40	-1.30
3	5460.00	59.3 PK	74.0	-14.7	1.00 H	31	57.20	2.10
4	5460.00	45.9 AV	54.0	-8.1	1.00 H	31	43.80	2.10
5	#5470.00	60.9 PK	74.0	-13.1	1.00 H	29	58.70	2.20
6	#5470.00	46.4 AV	54.0	-7.6	1.00 H	29	44.20	2.20
7	*5500.00	74.9 PK			1.00 H	40	72.60	2.30
8	*5500.00	64.5 AV			1.00 H	40	62.20	2.30
9	11000.00	64.0 PK	74.0	-10.0	1.00 H	33	46.30	17.70
10	11000.00	51.4 AV	54.0	-2.6	1.00 H	33	33.70	17.70

ANTENNA POLARITY & TEST DISTANCE: VERTICAL AT 3 M

NO.	FREQ. (MHz)	EMISSION LEVEL (dBuV/m)	LIMIT (dBuV/m)	MARGIN (dB)	ANTENNA HEIGHT (m)	TABLE ANGLE (Degree)	RAW VALUE (dBuV)	CORRECTION FACTOR (dB/m)
1	3666.00	46.3 PK	74.0	-27.7	1.00 V	10	47.60	-1.30
2	3666.00	36.9 AV	54.0	-17.1	1.00 V	10	38.20	-1.30
3	5460.00	59.8 PK	74.0	-14.2	1.00 V	6	57.70	2.10
4	5460.00	46.9 AV	54.0	-7.1	1.00 V	6	44.80	2.10
5	#5470.00	60.6 PK	74.0	-13.4	1.00 V	7	58.40	2.20
6	#5470.00	46.9 AV	54.0	-7.1	1.00 V	7	44.70	2.20
7	*5500.00	114.2 PK			1.00 V	25	73.90	40.30
8	*5500.00	103.8 AV			1.00 V	25	63.50	40.30
9	11000.00	66.4 PK	74.0	-7.6	1.13 V	25	48.70	17.70
10	11000.00	52.7 AV	54.0	-1.3	1.13 V	25	35.00	17.70

REMARKS:

1. Emission Level(dBuV/m) = Raw Value(dBuV) + Correction Factor(dB/m)
2. Correction Factor(dB/m) = Antenna Factor(dB/m) + Cable Factor(dB)
3. The other emission levels were very low against the limit.
4. Margin value = Emission Level – Limit value
5. " * ": Fundamental frequency.
6. " # ": The radiated frequency is out of the restricted band.

CHANNEL	TX Channel 116	DETECTOR FUNCTION	Peak (PK)
FREQUENCY RANGE	1GHz ~ 40GHz		Average (AV)

ANTENNA POLARITY & TEST DISTANCE: HORIZONTAL AT 3 M

NO.	FREQ. (MHz)	EMISSION LEVEL (dBuV/m)	LIMIT (dBuV/m)	MARGIN (dB)	ANTENNA HEIGHT (m)	TABLE ANGLE (Degree)	RAW VALUE (dBuV)	CORRECTION FACTOR (dB/m)
1	3720.00	45.3 PK	74.0	-28.7	1.00 H	101	46.20	-0.90
2	3720.00	35.5 AV	54.0	-18.5	1.00 H	101	36.40	-0.90
3	*5580.00	113.5 PK			1.02 H	82	73.00	40.50
4	*5580.00	103.3 AV			1.02 H	82	62.80	40.50
5	11160.00	63.9 PK	74.0	-10.1	1.00 H	55	47.50	16.40
6	11160.00	49.6 AV	54.0	-4.4	1.00 H	55	33.20	16.40

ANTENNA POLARITY & TEST DISTANCE: VERTICAL AT 3 M

NO.	FREQ. (MHz)	EMISSION LEVEL (dBuV/m)	LIMIT (dBuV/m)	MARGIN (dB)	ANTENNA HEIGHT (m)	TABLE ANGLE (Degree)	RAW VALUE (dBuV)	CORRECTION FACTOR (dB/m)
1	3720.00	44.4 PK	74.0	-29.6	1.00 V	13	45.30	-0.90
2	3720.00	34.9 AV	54.0	-19.1	1.00 V	13	35.80	-0.90
3	*5580.00	113.9 PK			1.00 V	357	73.40	40.50
4	*5580.00	103.7 AV			1.00 V	357	63.20	40.50
5	11160.00	64.7 PK	74.0	-9.3	1.38 V	23	48.30	16.40
6	11160.00	52.5 AV	54.0	-1.5	1.38 V	23	36.10	16.40

REMARKS:

1. Emission Level(dBuV/m) = Raw Value(dBuV) + Correction Factor(dB/m)
2. Correction Factor(dB/m) = Antenna Factor(dB/m) + Cable Factor(dB)
3. The other emission levels were very low against the limit.
4. Margin value = Emission Level – Limit value
5. " * " : Fundamental frequency.



CHANNEL	TX Channel 140	DETECTOR FUNCTION	Peak (PK)
FREQUENCY RANGE	1GHz ~ 40GHz		Average (AV)

ANTENNA POLARITY & TEST DISTANCE: HORIZONTAL AT 3 M

NO.	FREQ. (MHz)	EMISSION LEVEL (dBuV/m)	LIMIT (dBuV/m)	MARGIN (dB)	ANTENNA HEIGHT (m)	TABLE ANGLE (Degree)	RAW VALUE (dBuV)	CORRECTION FACTOR (dB/m)
1	3800.00	45.0 PK	74.0	-29.0	1.00 H	21	45.70	-0.70
2	3800.00	35.2 AV	54.0	-18.8	1.00 H	21	35.90	-0.70
3	*5700.00	110.0 PK			1.05 H	77	69.20	40.80
4	*5700.00	99.6 AV			1.05 H	77	58.80	40.80
5	#5725.00	60.2 PK	74.0	-13.8	1.00 H	321	57.60	2.60
6	#5725.00	46.7 AV	54.0	-7.3	1.00 H	321	44.10	2.60
7	11400.00	65.3 PK	74.0	-8.7	1.33 H	321	49.10	16.20
8	11400.00	51.4 AV	54.0	-2.6	1.33 H	321	35.20	16.20

ANTENNA POLARITY & TEST DISTANCE: VERTICAL AT 3 M

NO.	FREQ. (MHz)	EMISSION LEVEL (dBuV/m)	LIMIT (dBuV/m)	MARGIN (dB)	ANTENNA HEIGHT (m)	TABLE ANGLE (Degree)	RAW VALUE (dBuV)	CORRECTION FACTOR (dB/m)
1	3800.00	44.6 PK	74.0	-29.4	1.00 V	63	45.30	-0.70
2	3800.00	34.4 AV	54.0	-19.6	1.00 V	63	35.10	-0.70
3	*5700.00	110.8 PK			1.03 V	39	70.00	40.80
4	*5700.00	99.7 AV			1.03 V	39	58.90	40.80
5	#5725.00	59.5 PK	74.0	-14.5	1.00 V	88	56.90	2.60
6	#5725.00	46.1 AV	54.0	-7.9	1.00 V	88	43.50	2.60
7	11400.00	67.3 PK	74.0	-6.7	1.09 V	10	51.10	16.20
8	11400.00	52.6 AV	54.0	-1.4	1.09 V	10	36.40	16.20

REMARKS:

1. Emission Level(dBuV/m) = Raw Value(dBuV) + Correction Factor(dB/m)
2. Correction Factor(dB/m) = Antenna Factor(dB/m) + Cable Factor(dB)
3. The other emission levels were very low against the limit.
4. Margin value = Emission Level – Limit value
5. " * ": Fundamental frequency.
6. " # ": The radiated frequency is out of the restricted band.

802.11ac (VHT40)_3TX

CHANNEL	TX Channel 54	DETECTOR FUNCTION	Peak (PK)
FREQUENCY RANGE	1GHz ~ 40GHz		Average (AV)

ANTENNA POLARITY & TEST DISTANCE: HORIZONTAL AT 3 M								
NO.	FREQ. (MHz)	EMISSION LEVEL (dBuV/m)	LIMIT (dBuV/m)	MARGIN (dB)	ANTENNA HEIGHT (m)	TABLE ANGLE (Degree)	RAW VALUE (dBuV)	CORRECTION FACTOR (dB/m)
1	#3513.00	46.9 PK	74.0	-27.1	1.00 H	321	48.60	-1.70
2	#3513.00	39.0 AV	54.0	-15.0	1.00 H	321	40.70	-1.70
3	5150.00	59.1 PK	74.0	-14.9	1.49 H	66	57.10	2.00
4	5150.00	46.8 AV	54.0	-7.2	1.49 H	66	44.80	2.00
5	*5270.00	112.3 PK			1.10 H	73	72.20	40.10
6	*5270.00	101.9 AV			1.10 H	73	61.80	40.10
7	#10540.00	59.9 PK	74.0	-14.1	1.00 H	164	44.30	15.60
8	#10540.00	47.1 AV	54.0	-6.9	1.00 H	164	31.50	15.60

ANTENNA POLARITY & TEST DISTANCE: VERTICAL AT 3 M								
NO.	FREQ. (MHz)	EMISSION LEVEL (dBuV/m)	LIMIT (dBuV/m)	MARGIN (dB)	ANTENNA HEIGHT (m)	TABLE ANGLE (Degree)	RAW VALUE (dBuV)	CORRECTION FACTOR (dB/m)
1	#3513.00	47.5 PK	74.0	-26.5	1.00 V	312	49.20	-1.70
2	#3513.00	39.8 AV	54.0	-14.2	1.00 V	312	41.50	-1.70
3	5150.00	58.7 PK	74.0	-15.3	1.15 V	37	56.70	2.00
4	5150.00	45.9 AV	54.0	-8.1	1.15 V	37	43.90	2.00
5	*5270.00	113.7 PK			1.00 V	32	73.60	40.10
6	*5270.00	102.9 AV			1.00 V	32	62.80	40.10
7	#10540.00	62.7 PK	74.0	-11.3	1.23 V	18	47.10	15.60
8	#10540.00	48.8 AV	54.0	-5.2	1.23 V	18	33.20	15.60

REMARKS:

1. Emission Level(dBuV/m) = Raw Value(dBuV) + Correction Factor(dB/m)
2. Correction Factor(dB/m) = Antenna Factor(dB/m) + Cable Factor(dB)
3. The other emission levels were very low against the limit.
4. Margin value = Emission Level – Limit value
5. " * ": Fundamental frequency.
6. " # ": The radiated frequency is out of the restricted band.



CHANNEL	TX Channel 62	DETECTOR FUNCTION	Peak (PK)
FREQUENCY RANGE	1GHz ~ 40GHz		Average (AV)

ANTENNA POLARITY & TEST DISTANCE: HORIZONTAL AT 3 M

NO.	FREQ. (MHz)	EMISSION LEVEL (dBuV/m)	LIMIT (dBuV/m)	MARGIN (dB)	ANTENNA HEIGHT (m)	TABLE ANGLE (Degree)	RAW VALUE (dBuV)	CORRECTION FACTOR (dB/m)
1	#3540.00	48.0 PK	74.0	-26.0	1.32 H	312	49.80	-1.80
2	#3540.00	42.3 AV	54.0	-11.7	1.32 H	312	44.10	-1.80
3	*5310.00	112.7 PK			1.00 H	65	72.60	40.10
4	*5310.00	102.8 AV			1.00 H	65	62.70	40.10
5	5350.00	64.7 PK	74.0	-9.3	1.00 H	59	62.70	2.00
6	5350.00	51.9 AV	54.0	-2.1	1.00 H	59	49.90	2.00
7	10620.00	59.8 PK	74.0	-14.2	1.00 H	59	43.60	16.20
8	10620.00	47.7 AV	54.0	-6.3	1.00 H	59	31.50	16.20

ANTENNA POLARITY & TEST DISTANCE: VERTICAL AT 3 M

NO.	FREQ. (MHz)	EMISSION LEVEL (dBuV/m)	LIMIT (dBuV/m)	MARGIN (dB)	ANTENNA HEIGHT (m)	TABLE ANGLE (Degree)	RAW VALUE (dBuV)	CORRECTION FACTOR (dB/m)
1	#3540.00	48.0 PK	74.0	-26.0	1.02 V	19	49.80	-1.80
2	#3540.00	42.0 AV	54.0	-12.0	1.02 V	19	43.80	-1.80
3	*5310.00	113.8 PK			1.00 V	25	73.70	40.10
4	*5310.00	104.5 AV			1.00 V	25	64.40	40.10
5	5350.00	63.7 PK	74.0	-10.3	1.00 V	38	61.70	2.00
6	5350.00	51.3 AV	54.0	-2.7	1.00 V	38	49.30	2.00
7	10620.00	61.8 PK	74.0	-12.2	1.00 V	19	45.60	16.20
8	10620.00	49.1 AV	54.0	-4.9	1.00 V	19	32.90	16.20

REMARKS:

1. Emission Level(dBuV/m) = Raw Value(dBuV) + Correction Factor(dB/m)
2. Correction Factor(dB/m) = Antenna Factor(dB/m) + Cable Factor(dB)
3. The other emission levels were very low against the limit.
4. Margin value = Emission Level – Limit value
5. " * ": Fundamental frequency.
6. " # ": The radiated frequency is out of the restricted band.

CHANNEL	TX Channel 102	DETECTOR FUNCTION	Peak (PK)
FREQUENCY RANGE	1GHz ~ 40GHz		Average (AV)

ANTENNA POLARITY & TEST DISTANCE: HORIZONTAL AT 3 M

NO.	FREQ. (MHz)	EMISSION LEVEL (dBuV/m)	LIMIT (dBuV/m)	MARGIN (dB)	ANTENNA HEIGHT (m)	TABLE ANGLE (Degree)	RAW VALUE (dBuV)	CORRECTION FACTOR (dB/m)
1	3673.00	45.2 PK	74.0	-28.8	1.00 H	89	46.50	-1.30
2	3673.00	35.9 AV	54.0	-18.1	1.00 H	89	37.20	-1.30
3	5460.00	61.7 PK	74.0	-12.3	1.00 H	46	59.60	2.10
4	5460.00	47.6 AV	54.0	-6.4	1.00 H	46	45.50	2.10
5	#5470.00	64.0 PK	74.0	-10.0	1.00 H	40	61.80	2.20
6	#5470.00	49.8 AV	54.0	-4.2	1.00 H	40	47.60	2.20
7	*5510.00	109.9 PK			1.06 H	54	69.60	40.30
8	*5510.00	99.8 AV			1.06 H	54	59.50	40.30
9	11020.00	62.3 PK	74.0	-11.7	1.00 H	16	44.90	17.40
10	11020.00	48.7 AV	54.0	-5.3	1.00 H	16	31.30	17.40

ANTENNA POLARITY & TEST DISTANCE: VERTICAL AT 3 M

NO.	FREQ. (MHz)	EMISSION LEVEL (dBuV/m)	LIMIT (dBuV/m)	MARGIN (dB)	ANTENNA HEIGHT (m)	TABLE ANGLE (Degree)	RAW VALUE (dBuV)	CORRECTION FACTOR (dB/m)
1	3673.00	46.9 PK	74.0	-27.1	1.00 V	6	48.20	-1.30
2	3673.00	37.2 AV	54.0	-16.8	1.00 V	6	38.50	-1.30
3	5460.00	60.0 PK	74.0	-14.0	1.44 V	12	57.90	2.10
4	5460.00	47.5 AV	54.0	-6.5	1.44 V	12	45.40	2.10
5	#5470.00	67.9 PK	74.0	-6.1	1.33 V	27	65.70	2.20
6	#5470.00	52.5 AV	54.0	-1.5	1.33 V	27	50.30	2.20
7	*5510.00	110.6 PK			1.31 V	26	70.30	40.30
8	*5510.00	100.6 AV			1.31 V	26	60.30	40.30
9	11020.00	65.5 PK	74.0	-8.5	1.07 V	20	48.10	17.40
10	11020.00	50.0 AV	54.0	-4.0	1.07 V	20	32.60	17.40

REMARKS:

1. Emission Level(dBuV/m) = Raw Value(dBuV) + Correction Factor(dB/m)
2. Correction Factor(dB/m) = Antenna Factor(dB/m) + Cable Factor(dB)
3. The other emission levels were very low against the limit.
4. Margin value = Emission Level – Limit value
5. " * ": Fundamental frequency.
6. " # ": The radiated frequency is out of the restricted band.

CHANNEL	TX Channel 110	DETECTOR FUNCTION	Peak (PK)
FREQUENCY RANGE	1GHz ~ 40GHz		Average (AV)

ANTENNA POLARITY & TEST DISTANCE: HORIZONTAL AT 3 M

NO.	FREQ. (MHz)	EMISSION LEVEL (dBuV/m)	LIMIT (dBuV/m)	MARGIN (dB)	ANTENNA HEIGHT (m)	TABLE ANGLE (Degree)	RAW VALUE (dBuV)	CORRECTION FACTOR (dB/m)
1	3700.00	44.2 PK	74.0	-29.8	1.00 H	322	45.20	-1.00
2	3700.00	33.2 AV	54.0	-20.8	1.00 H	322	34.20	-1.00
3	*5550.00	110.0 PK			1.05 H	59	69.60	40.40
4	*5550.00	100.2 AV			1.05 H	59	59.80	40.40
5	11100.00	62.1 PK	74.0	-11.9	1.32 H	10	45.50	16.60
6	11100.00	49.1 AV	54.0	-4.9	1.32 H	10	32.50	16.60

ANTENNA POLARITY & TEST DISTANCE: VERTICAL AT 3 M

NO.	FREQ. (MHz)	EMISSION LEVEL (dBuV/m)	LIMIT (dBuV/m)	MARGIN (dB)	ANTENNA HEIGHT (m)	TABLE ANGLE (Degree)	RAW VALUE (dBuV)	CORRECTION FACTOR (dB/m)
1	3700.00	45.5 PK	74.0	-28.5	1.10 V	326	46.50	-1.00
2	3700.00	33.1 AV	54.0	-20.9	1.10 V	326	34.10	-1.00
3	*5550.00	110.5 PK			1.08 V	28	70.10	40.40
4	*5550.00	100.0 AV			1.08 V	28	59.60	40.40
5	11100.00	63.3 PK	74.0	-10.7	1.36 V	25	46.70	16.60
6	11100.00	50.6 AV	54.0	-3.4	1.36 V	25	34.00	16.60

REMARKS:

1. Emission Level(dBuV/m) = Raw Value(dBuV) + Correction Factor(dB/m)
2. Correction Factor(dB/m) = Antenna Factor(dB/m) + Cable Factor(dB)
3. The other emission levels were very low against the limit.
4. Margin value = Emission Level – Limit value
5. " * " : Fundamental frequency.



CHANNEL	TX Channel 134	DETECTOR FUNCTION	Peak (PK)
FREQUENCY RANGE	1GHz ~ 40GHz		Average (AV)

ANTENNA POLARITY & TEST DISTANCE: HORIZONTAL AT 3 M

NO.	FREQ. (MHz)	EMISSION LEVEL (dBuV/m)	LIMIT (dBuV/m)	MARGIN (dB)	ANTENNA HEIGHT (m)	TABLE ANGLE (Degree)	RAW VALUE (dBuV)	CORRECTION FACTOR (dB/m)
1	3780.00	44.6 PK	74.0	-29.4	1.13 H	86	45.30	-0.70
2	3780.00	34.3 AV	54.0	-19.7	1.13 H	86	35.00	-0.70
3	*5670.00	107.0 PK			1.02 H	45	66.30	40.70
4	*5670.00	96.4 AV			1.02 H	45	55.70	40.70
5	#5725.00	58.8 PK	74.0	-15.2	1.00 H	76	56.20	2.60
6	#5725.00	46.5 AV	54.0	-7.5	1.00 H	76	43.90	2.60
7	11340.00	62.2 PK	74.0	-11.8	1.10 H	70	45.70	16.50
8	11340.00	49.9 AV	54.0	-4.1	1.10 H	70	33.40	16.50

ANTENNA POLARITY & TEST DISTANCE: VERTICAL AT 3 M

NO.	FREQ. (MHz)	EMISSION LEVEL (dBuV/m)	LIMIT (dBuV/m)	MARGIN (dB)	ANTENNA HEIGHT (m)	TABLE ANGLE (Degree)	RAW VALUE (dBuV)	CORRECTION FACTOR (dB/m)
1	3780.00	44.6 PK	74.0	-29.4	1.00 V	77	45.30	-0.70
2	3780.00	35.1 AV	54.0	-18.9	1.00 V	77	35.80	-0.70
3	*5670.00	107.8 PK			1.00 V	354	67.10	40.70
4	*5670.00	97.6 AV			1.00 V	354	56.90	40.70
5	#5725.00	58.7 PK	74.0	-15.3	1.00 V	36	56.10	2.60
6	#5725.00	46.4 AV	54.0	-7.6	1.00 V	36	43.80	2.60
7	11340.00	66.1 PK	74.0	-7.9	1.36 V	20	49.60	16.50
8	11340.00	52.7 AV	54.0	-1.3	1.36 V	20	36.20	16.50

REMARKS:

1. Emission Level(dBuV/m) = Raw Value(dBuV) + Correction Factor(dB/m)
2. Correction Factor(dB/m) = Antenna Factor(dB/m) + Cable Factor(dB)
3. The other emission levels were very low against the limit.
4. Margin value = Emission Level – Limit value
5. " * ": Fundamental frequency.
6. " # ": The radiated frequency is out of the restricted band.

802.11ac (VHT80)_3TX

CHANNEL	TX Channel 58	DETECTOR FUNCTION	Peak (PK)
FREQUENCY RANGE	1GHz ~ 40GHz		Average (AV)

ANTENNA POLARITY & TEST DISTANCE: HORIZONTAL AT 3 M

NO.	FREQ. (MHz)	EMISSION LEVEL (dBuV/m)	LIMIT (dBuV/m)	MARGIN (dB)	ANTENNA HEIGHT (m)	TABLE ANGLE (Degree)	RAW VALUE (dBuV)	CORRECTION FACTOR (dB/m)
1	#3526.00	48.1 PK	74.0	-25.9	1.05 H	323	49.80	-1.70
2	#3526.00	41.9 AV	54.0	-12.1	1.05 H	323	43.60	-1.70
3	*5290.00	105.4 PK			1.00 H	64	65.30	40.10
4	*5290.00	95.3 AV			1.00 H	64	55.20	40.10
5	5350.00	67.2 PK	74.0	-6.8	1.00 H	60	65.20	2.00
6	5350.00	52.7 AV	54.0	-1.3	1.00 H	60	50.70	2.00
7	#10580.00	61.6 PK	74.0	-12.4	1.00 H	106	45.70	15.90
8	#10580.00	47.7 AV	54.0	-6.3	1.00 H	106	31.80	15.90

ANTENNA POLARITY & TEST DISTANCE: VERTICAL AT 3 M

NO.	FREQ. (MHz)	EMISSION LEVEL (dBuV/m)	LIMIT (dBuV/m)	MARGIN (dB)	ANTENNA HEIGHT (m)	TABLE ANGLE (Degree)	RAW VALUE (dBuV)	CORRECTION FACTOR (dB/m)
1	#3526.00	47.8 PK	74.0	-26.2	1.05 V	16	49.50	-1.70
2	#3526.00	41.7 AV	54.0	-12.3	1.05 V	16	43.40	-1.70
3	*5290.00	106.4 PK			1.00 V	32	66.30	40.10
4	*5290.00	96.8 AV			1.00 V	32	56.70	40.10
5	5350.00	66.6 PK	74.0	-7.4	1.01 V	42	64.60	2.00
6	5350.00	53.0 AV	54.0	-1.0	1.01 V	42	51.00	2.00
7	#10580.00	61.4 PK	74.0	-12.6	1.00 V	311	45.50	15.90
8	#10580.00	48.1 AV	54.0	-5.9	1.00 V	311	32.20	15.90

REMARKS:

1. Emission Level(dBuV/m) = Raw Value(dBuV) + Correction Factor(dB/m)
2. Correction Factor(dB/m) = Antenna Factor(dB/m) + Cable Factor(dB)
3. The other emission levels were very low against the limit.
4. Margin value = Emission Level – Limit value
5. " * ": Fundamental frequency.
6. " # ": The radiated frequency is out of the restricted band.

CHANNEL	TX Channel 106	DETECTOR FUNCTION	Peak (PK)
FREQUENCY RANGE	1GHz ~ 40GHz		Average (AV)

ANTENNA POLARITY & TEST DISTANCE: HORIZONTAL AT 3 M

NO.	FREQ. (MHz)	EMISSION LEVEL (dBuV/m)	LIMIT (dBuV/m)	MARGIN (dB)	ANTENNA HEIGHT (m)	TABLE ANGLE (Degree)	RAW VALUE (dBuV)	CORRECTION FACTOR (dB/m)
1	3686.00	45.6 PK	74.0	-28.4	1.00 H	85	46.80	-1.20
2	3686.00	36.9 AV	54.0	-17.1	1.00 H	85	38.10	-1.20
3	5460.00	62.3 PK	74.0	-11.7	1.00 H	59	60.20	2.10
4	5460.00	48.1 AV	54.0	-5.9	1.00 H	59	46.00	2.10
5	#5470.00	66.9 PK	74.0	-7.1	1.00 H	32	64.70	2.20
6	#5470.00	51.3 AV	54.0	-2.7	1.00 H	32	49.10	2.20
7	*5530.00	101.0 PK			1.00 H	23	60.60	40.40
8	*5530.00	91.3 AV			1.00 H	23	50.90	40.40
9	11060.00	61.3 PK	74.0	-12.7	1.00 H	264	44.20	17.10
10	11060.00	48.5 AV	54.0	-5.5	1.00 H	264	31.40	17.10

ANTENNA POLARITY & TEST DISTANCE: VERTICAL AT 3 M

NO.	FREQ. (MHz)	EMISSION LEVEL (dBuV/m)	LIMIT (dBuV/m)	MARGIN (dB)	ANTENNA HEIGHT (m)	TABLE ANGLE (Degree)	RAW VALUE (dBuV)	CORRECTION FACTOR (dB/m)
1	3686.00	45.6 PK	74.0	-28.4	1.00 V	8	46.80	-1.20
2	3686.00	37.4 AV	54.0	-16.6	1.00 V	8	38.60	-1.20
3	5460.00	64.2 PK	74.0	-9.8	1.10 V	28	62.10	2.10
4	5460.00	51.8 AV	54.0	-2.2	1.10 V	28	49.70	2.10
5	#5470.00	70.2 PK	74.0	-3.8	1.01 V	24	68.00	2.20
6	#5470.00	53.0 AV	54.0	-1.0	1.01 V	24	50.80	2.20
7	*5530.00	103.8 PK			1.00 V	20	63.40	40.40
8	*5530.00	94.3 AV			1.00 V	20	53.90	40.40
9	11060.00	64.0 PK	74.0	-10.0	1.16 V	29	46.90	17.10
10	11060.00	50.9 AV	54.0	-3.1	1.16 V	29	33.80	17.10

REMARKS:

1. Emission Level(dBuV/m) = Raw Value(dBuV) + Correction Factor(dB/m)
2. Correction Factor(dB/m) = Antenna Factor(dB/m) + Cable Factor(dB)
3. The other emission levels were very low against the limit.
4. Margin value = Emission Level – Limit value
5. " * ": Fundamental frequency.
6. " # ": The radiated frequency is out of the restricted band.

Below 1GHz Data

802.11a

CHANNEL	TX Channel 64	DETECTOR FUNCTION	Quasi-Peak (QP)
FREQUENCY RANGE	30MHz ~ 1GHz		
TEST MODE	A		

ANTENNA POLARITY & TEST DISTANCE: HORIZONTAL AT 3 M

NO.	FREQ. (MHz)	EMISSION LEVEL (dBuV/m)	LIMIT (dBuV/m)	MARGIN (dB)	ANTENNA HEIGHT (m)	TABLE ANGLE (Degree)	RAW VALUE (dBuV)	CORRECTION FACTOR (dB/m)
1	80.96	22.9 QP	40.0	-17.1	1.75 H	132	41.70	-18.80
2	120.08	23.1 QP	43.5	-20.4	1.50 H	333	39.80	-16.70
3	155.87	26.8 QP	43.5	-16.7	2.00 H	108	40.70	-13.90
4	250.08	33.9 QP	46.0	-12.1	1.50 H	310	48.40	-14.50
5	524.17	34.4 QP	46.0	-11.6	1.25 H	350	42.60	-8.20
6	900.78	34.3 QP	46.0	-11.7	1.00 H	144	35.60	-1.30

ANTENNA POLARITY & TEST DISTANCE: VERTICAL AT 3 M

NO.	FREQ. (MHz)	EMISSION LEVEL (dBuV/m)	LIMIT (dBuV/m)	MARGIN (dB)	ANTENNA HEIGHT (m)	TABLE ANGLE (Degree)	RAW VALUE (dBuV)	CORRECTION FACTOR (dB/m)
1	33.68	29.6 QP	40.0	-10.4	1.10 V	60	45.40	-15.80
2	50.07	29.0 QP	40.0	-11.0	1.00 V	310	43.40	-14.40
3	129.08	32.5 QP	43.5	-11.0	1.00 V	210	48.00	-15.50
4	250.05	32.7 QP	46.0	-13.3	2.10 V	180	47.20	-14.50
5	525.14	36.1 QP	46.0	-9.9	1.00 V	211	44.30	-8.20
6	900.04	39.0 QP	46.0	-7.0	1.00 V	139	40.30	-1.30

Remarks:

1. Emission Level(dBuV/m) = Raw Value(dBuV) + Correction Factor(dB/m)
2. Correction Factor(dB/m) = Antenna Factor(dB/m) + Cable Factor(dB)
3. The other emission levels were very low against the limit.
4. Margin value = Emission Level – Limit value

CHANNEL	TX Channel 64	DETECTOR FUNCTION	Quasi-Peak (QP)
FREQUENCY RANGE	30MHz ~ 1GHz		
TEST MODE	B		

ANTENNA POLARITY & TEST DISTANCE: HORIZONTAL AT 3 M

NO.	FREQ. (MHz)	EMISSION LEVEL (dBuV/m)	LIMIT (dBuV/m)	MARGIN (dB)	ANTENNA HEIGHT (m)	TABLE ANGLE (Degree)	RAW VALUE (dBuV)	CORRECTION FACTOR (dB/m)
1	57.12	30.9 QP	40.0	-9.1	1.99 H	92	45.50	-14.60
2	88.23	26.9 QP	43.5	-16.6	1.99 H	219	46.60	-19.70
3	138.78	30.0 QP	43.5	-13.5	1.99 H	231	44.80	-14.80
4	300.16	36.0 QP	46.0	-10.0	1.99 H	115	48.40	-12.40
5	428.48	34.7 QP	46.0	-11.3	1.99 H	39	44.50	-9.80
6	840.67	39.7 QP	46.0	-6.3	1.00 H	162	41.50	-1.80

ANTENNA POLARITY & TEST DISTANCE: VERTICAL AT 3 M

NO.	FREQ. (MHz)	EMISSION LEVEL (dBuV/m)	LIMIT (dBuV/m)	MARGIN (dB)	ANTENNA HEIGHT (m)	TABLE ANGLE (Degree)	RAW VALUE (dBuV)	CORRECTION FACTOR (dB/m)
1	35.73	34.5 QP	40.0	-5.5	1.00 V	3	50.10	-15.60
2	66.84	32.8 QP	40.0	-7.2	1.00 V	170	48.50	-15.70
3	292.38	40.0 QP	46.0	-6.0	1.50 V	16	52.70	-12.70
4	300.16	43.6 QP	46.0	-2.4	1.50 V	153	56.00	-12.40
5	422.65	32.0 QP	46.0	-14.0	1.50 V	289	42.00	-10.00
6	840.67	44.1 QP	46.0	-1.9	1.00 V	115	45.90	-1.80

Remarks:

1. Emission Level(dBuV/m) = Raw Value(dBuV) + Correction Factor(dB/m)
2. Correction Factor(dB/m) = Antenna Factor(dB/m) + Cable Factor(dB)
3. The other emission levels were very low against the limit.
4. Margin value = Emission Level – Limit value

4.2 Conducted Emission Measurement

4.2.1 Limits of Conducted Emission Measurement

Frequency (MHz)	Conducted Limit (dBuV)	
	Quasi-peak	Average
0.15 - 0.5	66 - 56	56 - 46
0.50 - 5.0	56	46
5.0 - 30.0	60	50

Note: 1. The lower limit shall apply at the transition frequencies.

2. The limit decreases in line with the logarithm of the frequency in the range of 0.15 to 0.50MHz.

3. All emanations from a class A/B digital device or system, including any network of conductors and apparatus connected thereto, shall not exceed the level of field strengths specified above.

4.2.2 Test Instruments

Description & Manufacturer	Model No.	Serial No.	Date Of Calibration	Due Date Of Calibration
Test Receiver ROHDE & SCHWARZ	ESCI	100613	Nov. 11, 2014	Nov. 10, 2015
RF signal cable Woken	5D-FB	Cable-HYC01-01	Dec. 26, 2014	Dec. 25, 2015
LISN ROHDE & SCHWARZ (EUT)	ESH3-Z5	835239/001	Mar. 02, 2015	Mar. 01, 2016
LISN ROHDE & SCHWARZ (Peripheral)	ESH3-Z5	100311	Jul. 21, 2014	Jul. 20, 2015
Software ADT	BV ADT_Cond_ V7.3.7.3	NA	NA	NA

Notes 1. The calibration interval of the above test instruments is 12 months and the calibrations are traceable to NML/ROC and NIST/USA.

2. The test was performed in HwaYa Shielded Room 1.

3. The VCCI Site Registration No. is C-2040.

4.2.3 Test Procedure

- a. The EUT was placed 0.4 meters from the conducting wall of the shielded room with EUT being connected to the power mains through a line impedance stabilization network (LISN). Other support units were connected to the power mains through another LISN. The two LISNs provide 50 ohm/ 50uH of coupling impedance for the measuring instrument.
- b. Both lines of the power mains connected to the EUT were checked for maximum conducted interference.
- c. The frequency range from 150kHz to 30MHz was searched. Emission levels under (Limit – 20dB) was not recorded.

NOTE: The resolution bandwidth and video bandwidth of test receiver is 9kHz for quasi-peak detection (QP) and average detection (AV) at frequency 0.15MHz-30MHz.

4.2.4 Deviation from Test Standard

No deviation.

4.2.5 Test Setup

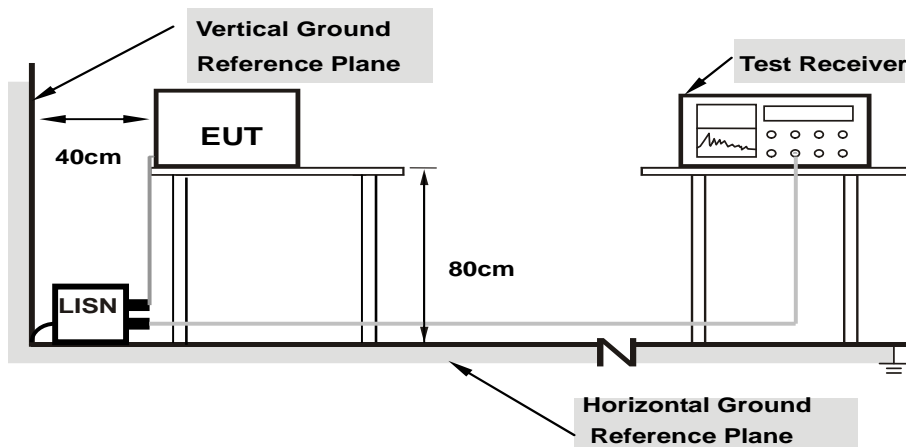

Note: 1.Support units were connected to second LISN.

2.Both of LISNs (AMN) are 80 cm from EUT and at least 80 from other units and other metal planes

For the actual test configuration, please refer to the attached file (Test Setup Photo).

4.2.6 EUT Operating Condition

Same as 4.1.6.

4.2.7 Test Results

Phase	Line (L)	Detector Function	Quasi-Peak (QP) / Average (AV)
Test Mode	A		

No	Freq. [MHz]	Corr. Factor (dB)	Reading Value [dB (uV)]		Emission Level [dB (uV)]		Limit [dB (uV)]		Margin (dB)	
			Q.P.	AV.	Q.P.	AV.	Q.P.	AV.	Q.P.	AV.
			1	0.16951	0.05	37.57	23.14	37.62	23.19	64.98
2	0.28275	0.06	29.06	18.15	29.12	18.21	60.73	50.73	-31.61	-32.52
3	0.49735	0.06	38.27	30.25	38.33	30.31	56.04	46.04	-17.71	-15.73
4	0.84917	0.07	24.20	16.07	24.27	16.14	56.00	46.00	-31.73	-29.86
5	1.40578	0.10	25.23	17.41	25.33	17.51	56.00	46.00	-30.67	-28.49
6	6.28137	0.29	24.14	17.31	24.43	17.60	60.00	50.00	-35.57	-32.40

Remarks:

1. Q.P. and AV. are abbreviations of quasi-peak and average individually.
2. The emission levels of other frequencies were very low against the limit.
3. Margin value = Emission level - Limit value
4. Correction factor = Insertion loss + Cable loss
5. Emission Level = Correction Factor + Reading Value.

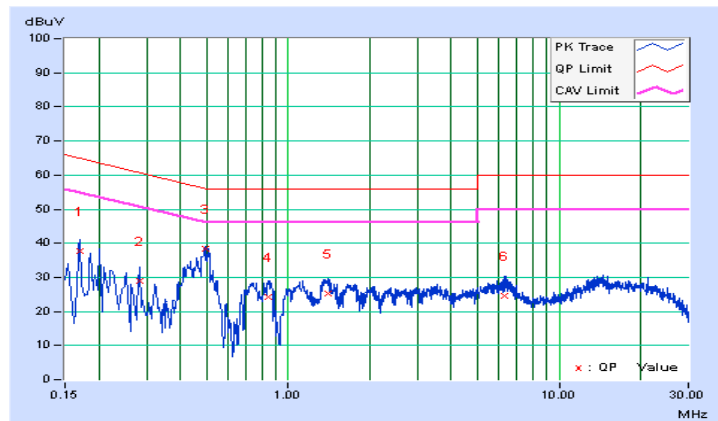

Phase	Neutral (N)	Detector Function	Quasi-Peak (QP) / Average (AV)
Test Mode	A		

No	Freq. [MHz]	Corr. Factor (dB)	Reading Value [dB (uV)]		Emission Level [dB (uV)]		Limit [dB (uV)]		Margin (dB)	
			Q.P.	AV.	Q.P.	AV.	Q.P.	AV.	Q.P.	AV.
			1	0.15384	0.05	39.67	21.49	39.72	21.54	65.79
2	0.19367	0.05	37.09	19.42	37.14	19.47	63.88	53.88	-26.74	-34.41
3	0.22895	0.05	26.08	19.45	26.13	19.50	62.49	52.49	-36.36	-32.99
4	0.49509	0.06	35.47	22.58	35.53	22.64	56.08	46.08	-20.55	-23.44
5	0.83146	0.07	18.69	10.63	18.76	10.70	56.00	46.00	-37.24	-35.30
6	3.52459	0.17	17.78	10.33	17.95	10.50	56.00	46.00	-38.05	-35.50

Remarks:

1. Q.P. and AV. are abbreviations of quasi-peak and average individually.
2. The emission levels of other frequencies were very low against the limit.
3. Margin value = Emission level - Limit value
4. Correction factor = Insertion loss + Cable loss
5. Emission Level = Correction Factor + Reading Value.

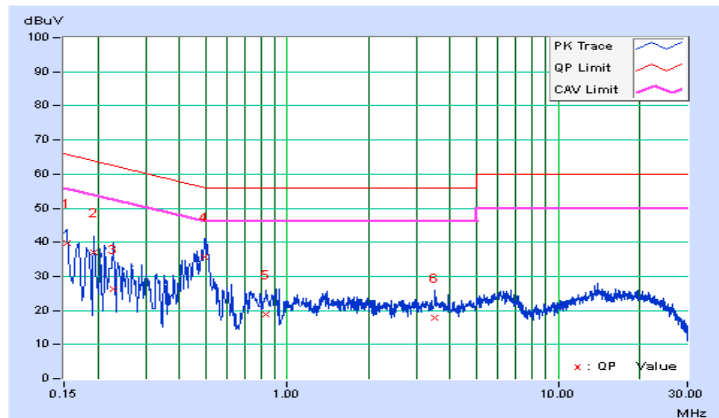

Phase	Line (L)	Detector Function	Quasi-Peak (QP) / Average (AV)
Test Mode	B		

No	Freq. [MHz]	Corr. Factor (dB)	Reading Value [dB (uV)]		Emission Level [dB (uV)]		Limit [dB (uV)]		Margin (dB)	
			Q.P.	AV.	Q.P.	AV.	Q.P.	AV.	Q.P.	AV.
			1	0.15000	0.05	32.24	23.53	32.29	23.58	66.00
2	0.43122	0.06	44.96	35.45	45.02	35.51	57.23	47.23	-12.21	-11.72
3	0.76789	0.07	32.86	26.05	32.93	26.12	56.00	46.00	-23.07	-19.88
4	1.12359	0.08	29.65	22.58	29.73	22.66	56.00	46.00	-26.27	-23.34
5	10.30818	0.46	28.37	23.13	28.83	23.59	60.00	50.00	-31.17	-26.41
6	20.13010	0.90	27.79	21.44	28.69	22.34	60.00	50.00	-31.31	-27.66

Remarks:

1. Q.P. and AV. are abbreviations of quasi-peak and average individually.
2. The emission levels of other frequencies were very low against the limit.
3. Margin value = Emission level - Limit value
4. Correction factor = Insertion loss + Cable loss
5. Emission Level = Correction Factor + Reading Value.

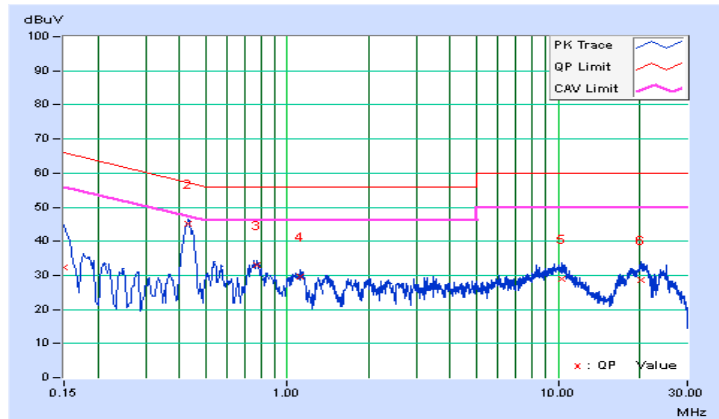

Phase	Neutral (N)	Detector Function	Quasi-Peak (QP) / Average (AV)
Test Mode	B		

No	Freq. [MHz]	Corr. Factor (dB)	Reading Value [dB (uV)]		Emission Level [dB (uV)]		Limit [dB (uV)]		Margin (dB)	
			Q.P.	AV.	Q.P.	AV.	Q.P.	AV.	Q.P.	AV.
			1	0.16173	0.05	37.81	24.85	37.86	24.90	65.37
2	0.43924	0.06	43.70	36.07	43.76	36.13	57.08	47.08	-13.31	-10.94
3	0.54089	0.06	31.16	22.54	31.22	22.60	56.00	46.00	-24.78	-23.40
4	0.75984	0.07	32.20	25.15	32.27	25.22	56.00	46.00	-23.73	-20.78
5	10.04621	0.42	27.28	21.76	27.70	22.18	60.00	50.00	-32.30	-27.82
6	22.85146	0.77	28.11	22.95	28.88	23.72	60.00	50.00	-31.12	-26.28

Remarks:

1. Q.P. and AV. are abbreviations of quasi-peak and average individually.
2. The emission levels of other frequencies were very low against the limit.
3. Margin value = Emission level - Limit value
4. Correction factor = Insertion loss + Cable loss
5. Emission Level = Correction Factor + Reading Value.

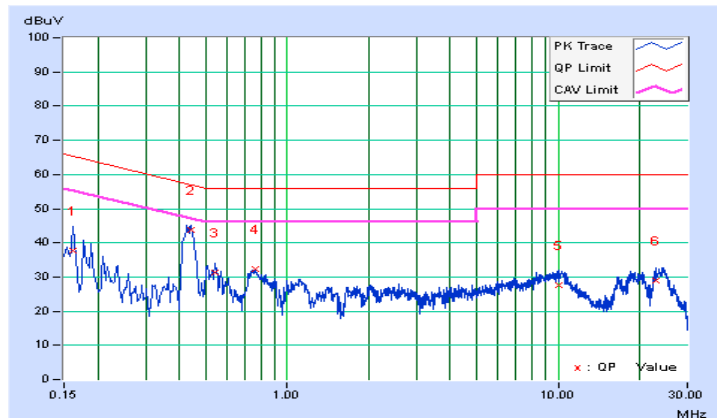

4.3 Transmit Power Measurement

4.3.1 Limits of Transmit Power Measurement

Operation Band	EUT Category		LIMIT
U-NII-1	---	Outdoor Access Point	1 Watt (30 dBm) (Max. e.i.r.p \leq 125mW(21 dBm) at any elevation angle above 30 degrees as measured from the horizon)
	---	Fixed point-to-point Access Point	1 Watt (30 dBm)
	---	Indoor Access Point	1 Watt (30 dBm)
	---	Mobile and Portable client device	250mW (24 dBm)
U-NII-2A	√		250mW (24 dBm) or 11 dBm+10 log B*
U-NII-2C	√		250mW (24 dBm) or 11 dBm+10 log B*
U-NII-3	---		1 Watt (30 dBm)

*B is the 26 dB emission bandwidth in megahertz

Per KDB 662911 Method of conducted output power measurement on IEEE 802.11 devices,

Array Gain = 0 dB (i.e., no array gain) for $N_{ANT} \leq 4$;

Array Gain = 0 dB (i.e., no array gain) for channel widths ≥ 40 MHz for any N_{ANT} ;

Array Gain = $5 \log(N_{ANT}/N_{SS})$ dB or 3 dB, whichever is less for 20-MHz channel widths with $N_{ANT} \geq 5$.

For power measurements on all other devices: Array Gain = $10 \log(N_{ANT}/N_{SS})$ dB.

4.3.2 Test Setup

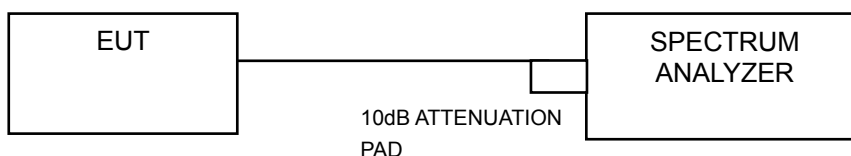
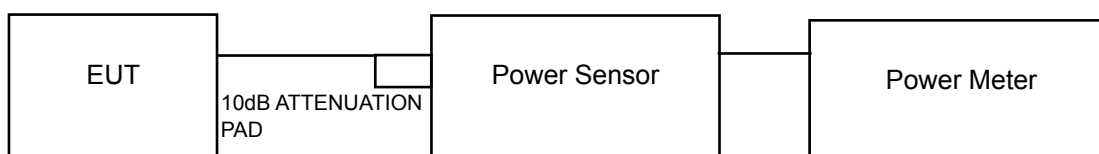

4.3.3 Test Instruments

Refer to section 4.1.2 to get information of above instrument.

4.3.4 Test Procedure

FOR AVERAGE POWER MEASUREMENT

For 802.11a, 802.11n (HT20), 802.11n (HT40), 802.11ac (VHT20), 802.11ac (VHT40)

Method PM is used to perform output power measurement, trigger and gating function of wide band power meter is enabled to measure max output power of TX on burst. Duty factor is not added to measured value.

For 802.11ac (VHT80)

- 1) Set span to encompass the entire 26 dB EBW (or, alternatively, the entire 99% occupied bandwidth) of the signal.
- 2) Set sweep trigger to "free run".
- 3) Set RBW = 1 MHz.
- 4) Set VBW \geq 3 MHz
- 5) Number of points in sweep \geq 2 Span / RBW.
- 6) Sweep time \leq (number of points in sweep) * T
- 7) Detector = RMS.
- 8) Trace mode = max hold.
- 9) Allow max hold to run for at least 60 seconds, or longer as needed to allow the trace to stabilize.

4.3.5 Deviation from Test Standard

No deviation.

4.3.6 EUT Operating Conditions

The software provided by client to enable the EUT under transmission Condition continuously at lowest, middle and highest channel frequencies individually.

4.3.7 Test Result

POWER OUTPUT:

802.11a_1TX

Channel	Channel Frequency (MHz)	Maximum Conducted Power (mW)	Maximum Conducted Power (dBm)	Power Limit (dBm)	Pass/Fail
52	5260	116.950	20.68	23.87	Pass
60	5300	178.238	22.51	23.87	Pass
64	5320	238.232	23.77	23.87	Pass
100	5500	115.611	20.63	23.87	Pass
116	5580	131.522	21.19	23.87	Pass
140	5700	69.984	18.45	23.87	Pass

*Gain=6.13dBi > 6dBi, so the limit shall be reduced to 24-(6.13-6) = 23.87dBm.

NOTE:

1. 11dBm + 10log(22.56) = 24.53 dBm > 23.87dBm.
2. 11dBm + 10log(23.00) = 24.62 dBm > 23.87dBm.
3. 11dBm + 10log(24.32) = 24.86 dBm > 23.87dBm.
4. 11dBm + 10log(22.54) = 24.53 dBm > 23.87dBm.
5. 11dBm + 10log(21.77) = 24.38 dBm > 23.87dBm.
6. 11dBm + 10log(22.63) = 24.55 dBm > 23.87dBm.

802.11n (HT20)_2TX

Chan.	Chan. Freq. (MHz)	Maximum Conducted Power (dBm)		Total Power (mW)	Total Power (dBm)	Power Limit (dBm)	Pass / Fail
		Chain 0	Chain 1				
52	5260	20.37	20.56	222.656	23.48	23.87	Pass
60	5300	20.25	20.75	224.775	23.52	23.87	Pass
64	5320	20.46	20.81	231.677	23.65	23.87	Pass
100	5500	20.21	21.15	235.271	23.72	23.87	Pass
116	5580	20.14	20.31	210.675	23.24	23.87	Pass
140	5700	18.56	18.33	139.856	21.46	23.87	Pass

*Max. Gain=6.13dBi > 6dBi, so the limit shall be reduced to 24-(6.13-6) = 23.87dBm.

NOTE:
CHAIN 0

1. 11dBm + 10log(23.26) = 24.67 dBm > 23.87dBm.
2. 11dBm + 10log(23.58) = 24.73 dBm > 23.87dBm.
3. 11dBm + 10log(23.81) = 24.77 dBm > 23.87dBm.
4. 11dBm + 10log(22.98) = 24.61 dBm > 23.87dBm.
5. 11dBm + 10log(23.37) = 24.69 dBm > 23.87dBm.
6. 11dBm + 10log(22.96) = 24.61 dBm > 23.87dBm.

CHAIN 1

1. 11dBm + 10log(23.94) = 24.79 dBm > 23.87dBm.
2. 11dBm + 10log(23.45) = 24.70 dBm > 23.87dBm.
3. 11dBm + 10log(23.96) = 24.79 dBm > 23.87dBm.
4. 11dBm + 10log(23.70) = 24.75 dBm > 23.87dBm.
5. 11dBm + 10log(23.60) = 24.73 dBm > 23.87dBm.
6. 11dBm + 10log(23.33) = 24.68 dBm > 23.87dBm.

802.11n (HT40)_2TX

Chan.	Chan. Freq. (MHz)	Maximum Conducted Power (dBm)		Total Power (mW)	Total Power (dBm)	Power Limit (dBm)	Pass / Fail
		Chain 0	Chain 1				
54	5270	19.89	20.06	198.890	22.99	23.87	Pass
62	5310	19.98	20.03	200.234	23.02	23.87	Pass
102	5510	19.06	19.58	171.320	22.34	23.87	Pass
110	5550	20.16	20.43	214.161	23.31	23.87	Pass
134	5670	20.14	19.73	197.248	22.95	23.87	Pass

*Max. Gain=6.13dBi > 6dBi, so the limit shall be reduced to $24-(6.13-6) = 23.87\text{dBm}$.

NOTE:
CHAIN 0

1. $11\text{dBm} + 10\log(47.12) = 27.73\text{ dBm} > 23.87\text{dBm}$.
2. $11\text{dBm} + 10\log(46.55) = 27.68\text{ dBm} > 23.87\text{dBm}$.
3. $11\text{dBm} + 10\log(46.88) = 27.71\text{ dBm} > 23.87\text{dBm}$.
4. $11\text{dBm} + 10\log(46.62) = 27.69\text{ dBm} > 23.87\text{dBm}$.
5. $11\text{dBm} + 10\log(45.99) = 27.63\text{ dBm} > 23.87\text{dBm}$.

CHAIN 1

1. $11\text{dBm} + 10\log(45.66) = 27.60\text{ dBm} > 23.87\text{dBm}$.
2. $11\text{dBm} + 10\log(45.11) = 27.54\text{ dBm} > 23.87\text{dBm}$.
3. $11\text{dBm} + 10\log(45.77) = 27.61\text{ dBm} > 23.87\text{dBm}$.
4. $11\text{dBm} + 10\log(45.34) = 27.56\text{ dBm} > 23.87\text{dBm}$.
5. $11\text{dBm} + 10\log(46.38) = 27.66\text{ dBm} > 23.87\text{dBm}$.

802.11ac (VHT20)_2TX

Chan.	Chan. Freq. (MHz)	Maximum Conducted Power (dBm)		Total Power (mW)	Total Power (dBm)	Power Limit (dBm)	Pass / Fail
		Chain 0	Chain 1				
52	5260	20.52	20.51	225.180	23.53	23.87	Pass
60	5300	20.36	20.81	229.147	23.60	23.87	Pass
64	5320	20.21	20.83	226.014	23.54	23.87	Pass
100	5500	20.32	21.21	239.777	23.80	23.87	Pass
116	5580	20.34	20.78	227.817	23.58	23.87	Pass
140	5700	18.51	18.55	142.572	21.54	23.87	Pass

*Max. Gain=6.13dBi > 6dBi, so the limit shall be reduced to 24-(6.13-6) = 23.87dBm.

NOTE:
CHAIN 0

1. 11dBm + 10log(22.94) = 24.61 dBm > 23.87dBm.
2. 11dBm + 10log(23.11) = 24.64 dBm > 23.87dBm.
3. 11dBm + 10log(23.72) = 24.75 dBm > 23.87dBm.
4. 11dBm + 10log(23.19) = 24.65 dBm > 23.87dBm.
5. 11dBm + 10log(23.20) = 24.65 dBm > 23.87dBm.
6. 11dBm + 10log(22.60) = 24.54 dBm > 23.87dBm.

CHAIN 1

1. 11dBm + 10log(23.52) = 24.71 dBm > 23.87dBm.
2. 11dBm + 10log(23.04) = 24.62 dBm > 23.87dBm.
3. 11dBm + 10log(23.19) = 24.65 dBm > 23.87dBm.
4. 11dBm + 10log(23.15) = 24.65 dBm > 23.87dBm.
5. 11dBm + 10log(24.19) = 24.84 dBm > 23.87dBm.
6. 11dBm + 10log(23.89) = 24.78 dBm > 23.87dBm.

802.11ac (VHT40)_2TX

Chan.	Chan. Freq. (MHz)	Maximum Conducted Power (dBm)		Total Power (mW)	Total Power (dBm)	Power Limit (dBm)	Pass / Fail
		Chain 0	Chain 1				
54	5270	20.06	19.74	195.580	22.91	23.87	Pass
62	5310	19.97	20.04	200.237	23.02	23.87	Pass
102	5510	19.01	19.54	169.566	22.29	23.87	Pass
110	5550	20.21	20.42	215.108	23.33	23.87	Pass
134	5670	20.12	19.78	197.862	22.96	23.87	Pass

*Max. Gain=6.13dBi > 6dBi, so the limit shall be reduced to $24-(6.13-6) = 23.87\text{dBm}$.

NOTE:
CHAIN 0

1. $11\text{dBm} + 10\log(46.14) = 27.64\text{dBm} > 23.87\text{dBm}$.
2. $11\text{dBm} + 10\log(46.27) = 27.65\text{dBm} > 23.87\text{dBm}$.
3. $11\text{dBm} + 10\log(46.42) = 27.67\text{dBm} > 23.87\text{dBm}$.
4. $11\text{dBm} + 10\log(46.13) = 27.64\text{dBm} > 23.87\text{dBm}$.
5. $11\text{dBm} + 10\log(45.98) = 27.63\text{dBm} > 23.87\text{dBm}$.

CHAIN 1

1. $11\text{dBm} + 10\log(46.53) = 27.68\text{dBm} > 23.87\text{dBm}$.
2. $11\text{dBm} + 10\log(46.49) = 27.67\text{dBm} > 23.87\text{dBm}$.
3. $11\text{dBm} + 10\log(45.79) = 27.61\text{dBm} > 23.87\text{dBm}$.
4. $11\text{dBm} + 10\log(45.98) = 27.63\text{dBm} > 23.87\text{dBm}$.
5. $11\text{dBm} + 10\log(44.99) = 27.53\text{dBm} > 23.87\text{dBm}$.

802.11ac (VHT80)_2TX

Chan.	Chan. Freq. (MHz)	Maximum Conducted Power (dBm)		Total Power (mW)	Total Power (dBm)	Power Limit (dBm)	Pass / Fail
		Chain 0	Chain 1				
58	5290	18.10	18.09	128.982	21.11	23.87	Pass
106	5530	15.66	16.01	76.715	18.85	23.87	Pass

*Max. Gain=6.13dBi > 6dBi, so the limit shall be reduced to $24-(6.13-6) = 23.87\text{dBm}$.

NOTE:
CHAIN 0

1. $11\text{dBm} + 10\log(89.11) = 30.50\text{dBm} > 23.87\text{dBm}$.
2. $11\text{dBm} + 10\log(89.27) = 30.51\text{dBm} > 23.87\text{dBm}$.

CHAIN 1

1. $11\text{dBm} + 10\log(89.67) = 30.53\text{dBm} > 23.87\text{dBm}$.
2. $11\text{dBm} + 10\log(86.76) = 30.38\text{dBm} > 23.87\text{dBm}$.

802.11n (HT20)_3TX

Chan.	Chan. Freq. (MHz)	Maximum Conducted Power (dBm)			Total Power (mW)	Total Power (dBm)	Power Limit (dBm)	Pass / Fail
		Chain 0	Chain 1	Chain 2				
52	5260	15.26	15.16	14.73	96.101	19.83	23.73	Pass
60	5300	15.37	15.37	14.86	99.490	19.98	23.73	Pass
64	5320	15.64	15.42	14.79	101.608	20.07	23.73	Pass
100	5500	15.29	15.11	14.63	95.280	19.79	23.73	Pass
116	5580	15.66	15.64	14.54	101.902	20.08	23.73	Pass
140	5700	15.13	14.84	13.42	85.042	19.30	23.73	Pass

*Max. Gain=6.27dBi > 6dBi, so the limit shall be reduced to 24-(6.27-6) = 23.73dBm.

NOTE:
CHAIN 0

1. 11dBm + 10log(23.51) = 24.71 dBm > 23.73dBm.
2. 11dBm + 10log(24.09) = 24.82 dBm > 23.73dBm.
3. 11dBm + 10log(23.69) = 24.75 dBm > 23.73dBm.
4. 11dBm + 10log(23.23) = 24.66 dBm > 23.73dBm.
5. 11dBm + 10log(23.32) = 24.68 dBm > 23.73dBm.
6. 11dBm + 10log(23.69) = 24.75 dBm > 23.73dBm.

CHAIN 1

1. 11dBm + 10log(23.62) = 24.73 dBm > 23.73dBm.
2. 11dBm + 10log(23.75) = 24.76 dBm > 23.73dBm.
3. 11dBm + 10log(23.22) = 24.66 dBm > 23.73dBm.
4. 11dBm + 10log(23.59) = 24.73 dBm > 23.73dBm.
5. 11dBm + 10log(23.34) = 24.68 dBm > 23.73dBm.
6. 11dBm + 10log(23.97) = 24.80 dBm > 23.73dBm.

CHAIN 2

1. 11dBm + 10log(23.75) = 24.76 dBm > 23.73dBm.
2. 11dBm + 10log(23.28) = 24.67 dBm > 23.73dBm.
3. 11dBm + 10log(23.48) = 24.71 dBm > 23.73dBm.
4. 11dBm + 10log(23.70) = 24.75 dBm > 23.73dBm.
5. 11dBm + 10log(23.43) = 24.70 dBm > 23.73dBm.
6. 11dBm + 10log(23.76) = 24.76 dBm > 23.73dBm.

802.11n (HT40)_3TX

Chan.	Chan. Freq. (MHz)	Maximum Conducted Power (dBm)			Total Power (mW)	Total Power (dBm)	Power Limit (dBm)	Pass / Fail
		Chain 0	Chain 1	Chain 2				
54	5270	18.57	18.25	17.53	195.403	22.91	23.73	Pass
62	5310	18.42	18.43	17.79	199.282	22.99	23.73	Pass
102	5510	17.01	17.22	17.13	154.599	21.89	23.73	Pass
110	5550	18.23	18.14	17.76	191.394	22.82	23.73	Pass
134	5670	16.94	16.42	15.23	126.627	21.03	23.73	Pass

*Max. Gain=6.27dBi > 6dBi, so the limit shall be reduced to 24-(6.27-6) = 23.73dBm.

NOTE:

CHAIN 0

1. 11dBm + 10log(45.76) = 27.60 dBm > 23.73dBm.
2. 11dBm + 10log(45.40) = 27.57 dBm > 23.73dBm.
3. 11dBm + 10log(45.38) = 27.57 dBm > 23.73dBm.
4. 11dBm + 10log(45.06) = 27.54 dBm > 23.73dBm.
5. 11dBm + 10log(45.63) = 27.59 dBm > 23.73dBm.

CHAIN 1

1. 11dBm + 10log(45.47) = 27.58 dBm > 23.73dBm.
2. 11dBm + 10log(45.20) = 27.55 dBm > 23.73dBm.
3. 11dBm + 10log(45.04) = 27.54 dBm > 23.73dBm.
4. 11dBm + 10log(45.07) = 27.54 dBm > 23.73dBm.
5. 11dBm + 10log(45.72) = 27.60 dBm > 23.73dBm.

CHAIN 2

1. 11dBm + 10log(46.97) = 27.72 dBm > 23.73dBm.
2. 11dBm + 10log(46.08) = 27.64 dBm > 23.73dBm.
3. 11dBm + 10log(45.99) = 27.63 dBm > 23.73dBm.
4. 11dBm + 10log(45.18) = 27.55 dBm > 23.73dBm.
5. 11dBm + 10log(46.06) = 27.63 dBm > 23.73dBm.

802.11ac (VHT20)_3TX

Chan.	Chan. Freq. (MHz)	Maximum Conducted Power (dBm)			Total Power (mW)	Total Power (dBm)	Power Limit (dBm)	Pass / Fail
		Chain 0	Chain 1	Chain 2				
52	5260	15.37	15.22	14.86	98.321	19.93	23.73	Pass
60	5300	15.42	15.31	14.69	98.241	19.92	23.73	Pass
64	5320	15.53	15.29	14.57	98.175	19.92	23.73	Pass
100	5500	15.55	15.36	14.26	96.917	19.86	23.73	Pass
116	5580	15.65	15.84	14.39	102.578	20.11	23.73	Pass
140	5700	15.26	14.95	13.31	86.264	19.36	23.73	Pass

*Max. Gain=6.27dBi > 6dBi, so the limit shall be reduced to 24-(6.27-6) = 23.73dBm.

NOTE:
CHAIN 0

1. 11dBm + 10log(23.81) = 24.77 dBm > 23.73dBm.
2. 11dBm + 10log(23.63) = 24.73 dBm > 23.73dBm.
3. 11dBm + 10log(23.68) = 24.74 dBm > 23.73dBm.
4. 11dBm + 10log(23.94) = 24.79 dBm > 23.73dBm.
5. 11dBm + 10log(23.80) = 24.77 dBm > 23.73dBm.
6. 11dBm + 10log(23.61) = 24.73 dBm > 23.73dBm.

CHAIN 1

1. 11dBm + 10log(24.71) = 24.93 dBm > 23.73dBm.
2. 11dBm + 10log(24.96) = 24.97 dBm > 23.73dBm.
3. 11dBm + 10log(23.95) = 24.79 dBm > 23.73dBm.
4. 11dBm + 10log(23.47) = 24.71 dBm > 23.73dBm.
5. 11dBm + 10log(23.01) = 24.62 dBm > 23.73dBm.
6. 11dBm + 10log(23.83) = 24.77 dBm > 23.73dBm.

CHAIN 2

1. 11dBm + 10log(23.26) = 24.67 dBm > 23.73dBm.
2. 11dBm + 10log(23.79) = 24.76 dBm > 23.73dBm.
3. 11dBm + 10log(23.70) = 24.75 dBm > 23.73dBm.
4. 11dBm + 10log(23.11) = 24.64 dBm > 23.73dBm.
5. 11dBm + 10log(22.99) = 24.62 dBm > 23.73dBm.
6. 11dBm + 10log(23.59) = 24.73 dBm > 23.73dBm.

802.11ac (VHT40)_3TX

Chan.	Chan. Freq. (MHz)	Maximum Conducted Power (dBm)			Total Power (mW)	Total Power (dBm)	Power Limit (dBm)	Pass / Fail
		Chain 0	Chain 1	Chain 2				
54	5270	18.45	18.12	17.55	191.732	22.83	23.73	Pass
62	5310	18.46	18.33	17.64	196.299	22.93	23.73	Pass
102	5510	17.74	18.02	17.73	182.109	22.60	23.73	Pass
110	5550	18.16	18.33	17.82	194.075	22.88	23.73	Pass
134	5670	17.63	17.31	15.62	148.245	21.71	23.73	Pass

*Max. Gain=6.27dBi > 6dBi, so the limit shall be reduced to 24-(6.27-6) = 23.73dBm.

NOTE:
CHAIN 0

1. 11dBm + 10log(45.80) = 27.61 dBm > 23.73dBm.
2. 11dBm + 10log(45.11) = 27.54 dBm > 23.73dBm.
3. 11dBm + 10log(45.91) = 27.62 dBm > 23.73dBm.
4. 11dBm + 10log(45.30) = 27.56 dBm > 23.73dBm.
5. 11dBm + 10log(45.42) = 27.57 dBm > 23.73dBm.

CHAIN 1

1. 11dBm + 10log(45.89) = 27.62 dBm > 23.73dBm.
2. 11dBm + 10log(45.81) = 27.61 dBm > 23.73dBm.
3. 11dBm + 10log(45.36) = 27.57 dBm > 23.73dBm.
4. 11dBm + 10log(45.18) = 27.55 dBm > 23.73dBm.
5. 11dBm + 10log(45.73) = 27.60 dBm > 23.73dBm.

CHAIN 2

1. 11dBm + 10log(46.30) = 27.66 dBm > 23.73dBm.
2. 11dBm + 10log(46.25) = 27.65 dBm > 23.73dBm.
3. 11dBm + 10log(45.62) = 27.59 dBm > 23.73dBm.
4. 11dBm + 10log(45.30) = 27.56 dBm > 23.73dBm.
5. 11dBm + 10log(46.04) = 27.63 dBm > 23.73dBm.

802.11ac (VHT80)_3TX

Chan.	Chan. Freq. (MHz)	Maximum Conducted Power (dBm)			Total Power (mW)	Total Power (dBm)	Power Limit (dBm)	Pass / Fail
		Chain 0	Chain 1	Chain 2				
58	5290	14.62	14.71	13.96	83.442	19.21	23.73	Pass
106	5530	13.21	13.67	13.47	66.455	18.23	23.73	Pass

*Max. Gain=6.27dBi > 6dBi, so the limit shall be reduced to 24-(6.27-6) = 23.73dBm.

NOTE:
CHAIN 0

1. 11dBm + 10log(88.96) = 30.49 dBm > 23.73dBm.
2. 11dBm + 10log(89.32) = 30.51 dBm > 23.73dBm.

CHAIN 1

1. 11dBm + 10log(88.47) = 30.47 dBm > 23.73dBm.
2. 11dBm + 10log(92.56) = 30.66 dBm > 23.73dBm.

CHAIN 2

1. 11dBm + 10log(89.07) = 30.50 dBm > 23.73dBm.
2. 11dBm + 10log(87.72) = 30.43 dBm > 23.73dBm.

26dB BANDWIDTH:
802.11a_1TX

Channel	Channel Frequency (MHz)	26dBc Bandwidth (MHz)	Pass / Fail
52	5260	22.56	PASS
60	5300	23.00	PASS
64	5320	24.32	PASS
100	5500	22.54	PASS
116	5580	21.77	PASS
140	5700	22.63	PASS

802.11n (HT20)_2TX

Channel	Channel Frequency (MHz)	26dBc Bandwidth (MHz)		Pass / Fail
		Chain 0	Chain 1	
52	5260	23.26	23.94	PASS
60	5300	23.58	23.45	PASS
64	5320	23.81	23.96	PASS
100	5500	22.98	23.70	PASS
116	5580	23.37	23.60	PASS
140	5700	22.96	23.33	PASS

802.11n (HT40)_2TX

Channel	Channel Frequency (MHz)	26dBc Bandwidth (MHz)		Pass / Fail
		Chain 0	Chain 1	
54	5270	47.12	45.66	PASS
62	5310	46.55	45.11	PASS
102	5510	46.88	45.77	PASS
110	5550	46.62	45.34	PASS
134	5670	45.99	46.38	PASS
140	5700	47.12	45.66	PASS

802.11ac (VHT20)_2TX

Channel	Channel Frequency (MHz)	26dBc Bandwidth (MHz)		Pass / Fail
		Chain 0	Chain 1	
52	5260	22.94	23.52	PASS
60	5300	23.11	23.04	PASS
64	5320	23.72	23.19	PASS
100	5500	23.19	23.15	PASS
116	5580	23.20	24.19	PASS
140	5700	22.60	23.89	PASS

802.11ac (VHT40)_2TX

Channel	Channel Frequency (MHz)	26dBc Bandwidth (MHz)		Pass / Fail
		Chain 0	Chain 1	
54	5270	46.14	46.53	PASS
62	5310	46.27	46.49	PASS
102	5510	46.42	45.79	PASS
110	5550	46.13	45.98	PASS
134	5670	45.98	44.99	PASS

802.11ac (HT80)_2TX

Channel	Channel Frequency (MHz)	26dBc Bandwidth (MHz)		Pass / Fail
		Chain 0	Chain 1	
58	5290	89.11	89.67	PASS
106	5530	89.27	86.76	PASS

802.11n (HT20)_3TX

Channel	Channel Frequency (MHz)	26dBc Bandwidth (MHz)			Pass / Fail
		Chain 0	Chain 1	Chain 2	
52	5260	23.51	23.62	23.75	PASS
60	5300	24.09	23.75	23.28	PASS
64	5320	23.69	23.22	23.48	PASS
100	5500	23.23	23.59	23.70	PASS
116	5580	23.32	23.34	23.43	PASS
140	5700	23.69	23.97	23.76	PASS

802.11n (HT40)_3TX

Channel	Channel Frequency (MHz)	26dBc Bandwidth (MHz)			Pass / Fail
		Chain 0	Chain 1	Chain 2	
54	5270	45.76	45.47	46.97	PASS
62	5310	45.40	45.20	46.08	PASS
102	5510	45.38	45.04	45.99	PASS
110	5550	45.06	45.07	45.18	PASS
134	5670	45.63	45.72	46.06	PASS

802.11ac (VHT20)_3TX

Channel	Channel Frequency (MHz)	26dBc Bandwidth (MHz)			Pass / Fail
		Chain 0	Chain 1	Chain 2	
52	5260	23.81	24.71	23.26	PASS
60	5300	23.63	24.96	23.79	PASS
64	5320	23.68	23.95	23.70	PASS
100	5500	23.94	23.47	23.11	PASS
116	5580	23.80	23.01	22.99	PASS
140	5700	23.61	23.83	23.59	PASS

802.11ac (VHT40)_3TX

Channel	Channel Frequency (MHz)	26dBc Bandwidth (MHz)			Pass / Fail
		Chain 0	Chain 1	Chain 2	
54	5270	45.80	45.89	46.30	PASS
62	5310	45.11	45.81	46.25	PASS
102	5510	45.91	45.36	45.62	PASS
110	5550	45.30	45.18	45.30	PASS
134	5670	45.42	45.73	46.04	PASS



802.11ac (VHT80)_3TX

Channel	Channel Frequency (MHz)	26dBc Bandwidth (MHz)			Pass / Fail
		Chain 0	Chain 1	Chain 2	
58	5290	88.96	88.47	89.07	PASS
106	5530	89.32	92.56	87.72	PASS

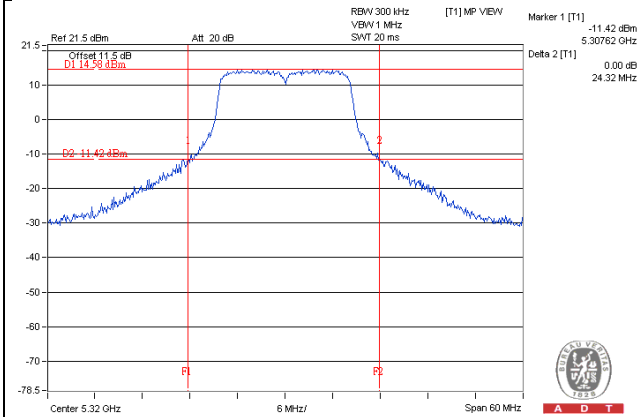
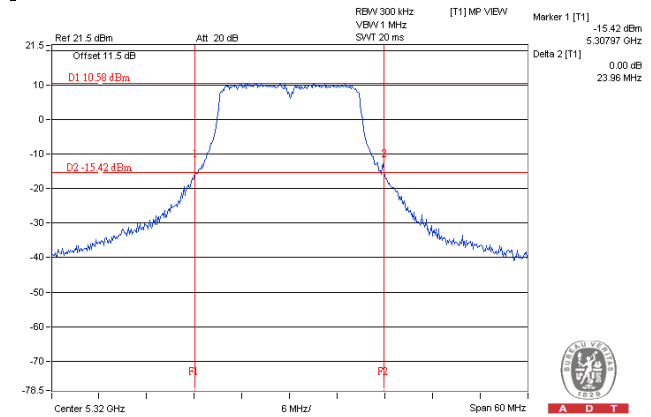
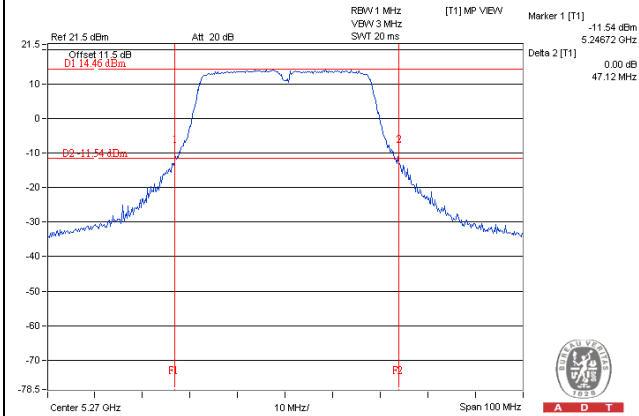
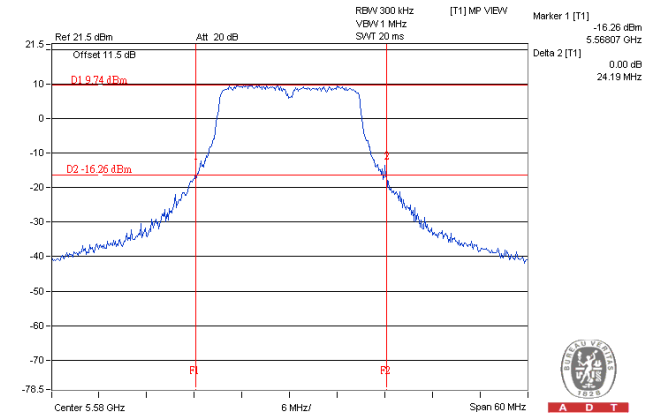
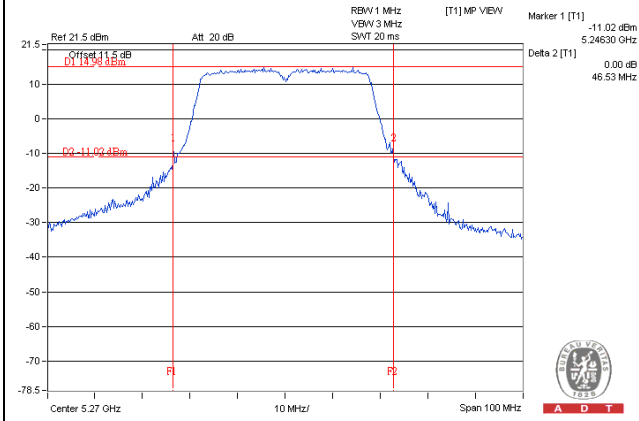
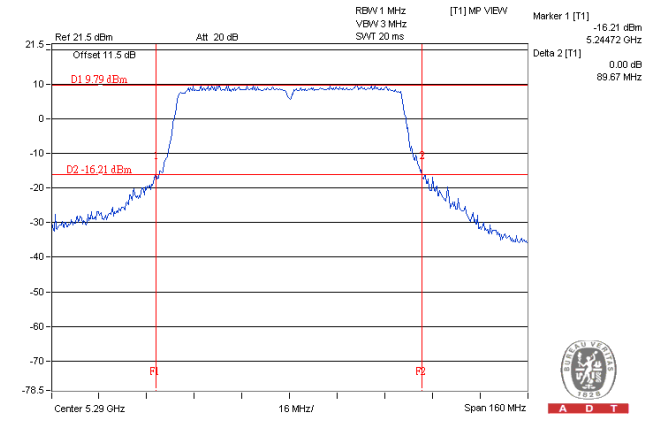
SPECTRUM PLOT OF WORST VALUE**802.11a_1TX****802.11n (HT20)_2TX****802.11n (HT40)_2TX****802.11ac (VHT20)_2TX****802.11ac (VHT40)_2TX****802.11ac (VHT80)_2TX**

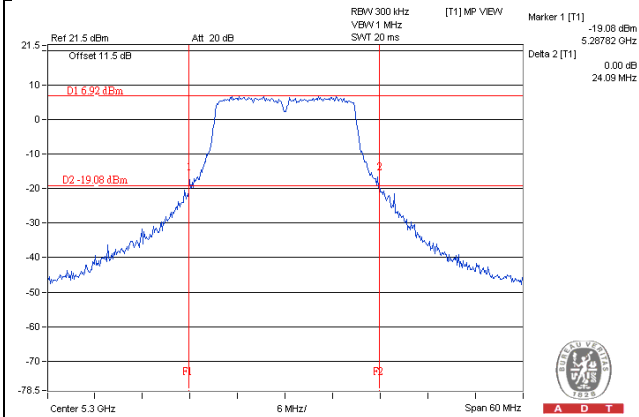
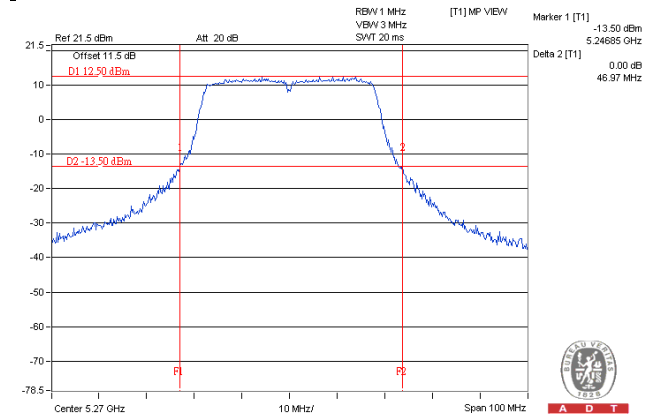
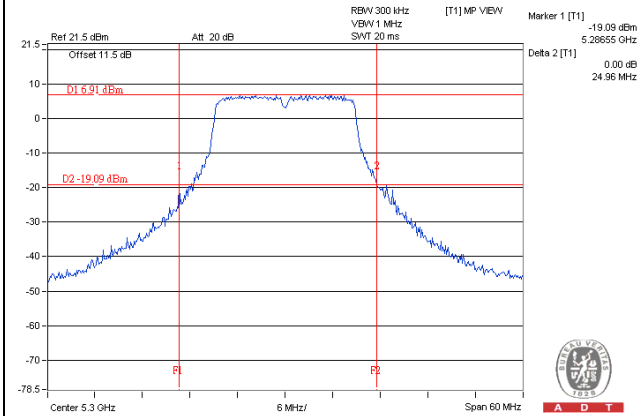
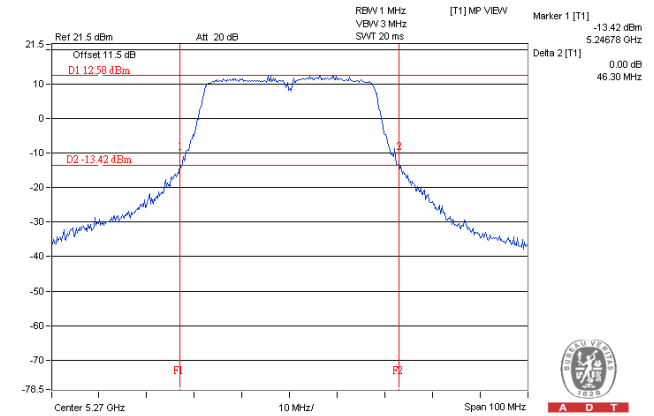
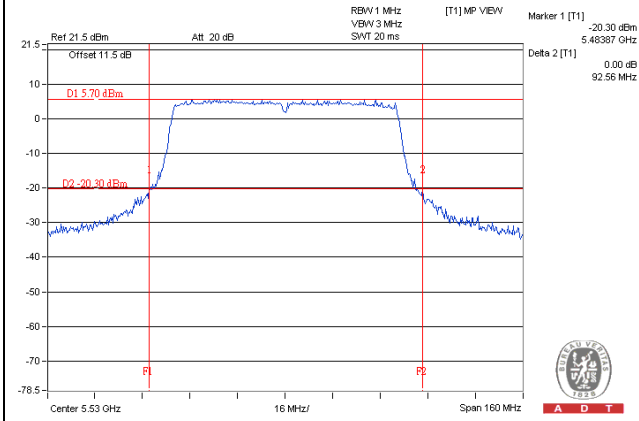
SPECTRUM PLOT OF WORST VALUE**802.11n (HT20)_3TX****802.11n (HT40)_3TX****802.11ac (VHT20)_3TX****802.11ac (VHT40)_3TX****802.11ac (VHT80)_3TX**

EUT MAXIMUM CONDUCTED POWER
802.11a

Frequency Band (MHz)	Max. Power	
	Output Power (mW)	Output Power (dBm)
5250~5350	238.232	23.77
5470~5725	131.522	21.19

NOTE: Manufacturer provides Transmit Power Control description to meet this requirement.

802.11n (HT20)_2TX

Frequency Band (MHz)	Max. Power	
	Output Power (mW)	Output Power (dBm)
5250~5350	231.677	23.65
5470~5725	235.271	23.72

NOTE: Manufacturer provides Transmit Power Control description to meet this requirement.

802.11n (HT40)_2TX

Frequency Band (MHz)	Max. Power	
	Output Power (mW)	Output Power (dBm)
5250~5350	200.234	23.02
5470~5725	214.161	23.31

NOTE: Manufacturer provides Transmit Power Control description to meet this requirement.

802.11ac (VHT20)_2TX

Frequency Band (MHz)	Max. Power	
	Output Power (mW)	Output Power (dBm)
5250~5350	229.147	23.60
5470~5725	239.777	23.80

NOTE: Manufacturer provides Transmit Power Control description to meet this requirement.

802.11ac (VHT40)_2TX

Frequency Band (MHz)	Max. Power	
	Output Power (mW)	Output Power (dBm)
5250~5350	200.237	23.02
5470~5725	215.108	23.33

NOTE: Manufacturer provides Transmit Power Control description to meet this requirement.

802.11ac (VHT80)_2TX

Frequency Band (MHz)	Max. Power	
	Output Power (mW)	Output Power (dBm)
5250~5350	128.982	21.11
5470~5725	76.715	18.85

NOTE: Manufacturer provides Transmit Power Control description to meet this requirement.

802.11n (HT20)_3TX

Frequency Band (MHz)	Max. Power	
	Output Power (mW)	Output Power (dBm)
5250~5350	101.608	20.07
5470~5725	101.902	20.08

NOTE: Manufacturer provides Transmit Power Control description to meet this requirement.

802.11n (HT40)_3TX

Frequency Band (MHz)	Max. Power	
	Output Power (mW)	Output Power (dBm)
5250~5350	199.282	22.99
5470~5725	191.394	22.82

NOTE: Manufacturer provides Transmit Power Control description to meet this requirement.

802.11ac (VHT20)_3TX

Frequency Band (MHz)	Max. Power	
	Output Power (mW)	Output Power (dBm)
5250~5350	98.321	19.93
5470~5725	102.578	20.11

NOTE: Manufacturer provides Transmit Power Control description to meet this requirement.

802.11ac (VHT40)_3TX

Frequency Band (MHz)	Max. Power	
	Output Power (mW)	Output Power (dBm)
5250~5350	196.299	22.93
5470~5725	194.075	22.88

NOTE: Manufacturer provides Transmit Power Control description to meet this requirement.

802.11ac (VHT80)_3TX

Frequency Band (MHz)	Max. Power	
	Output Power (mW)	Output Power (dBm)
5250~5350	83.442	19.21
5470~5725	66.455	18.23

NOTE: Manufacturer provides Transmit Power Control description to meet this requirement.

4.4 Peak Power Spectral Density Measurement

4.4.1 Limits of Peak Power Spectral Density Measurement

Operation Band	EUT Category		LIMIT
U-NII-1	---	Outdoor Access Point	17dBm/ MHz
	---	Fixed point-to-point Access Point	
	---	Indoor Access Point	
	---	Mobile and Portable client device	11dBm/ MHz
U-NII-2A	√		11dBm/ MHz
U-NII-2C	√		11dBm/ MHz
U-NII-3	---		30dBm/ 500kHz

4.4.2 Test Setup

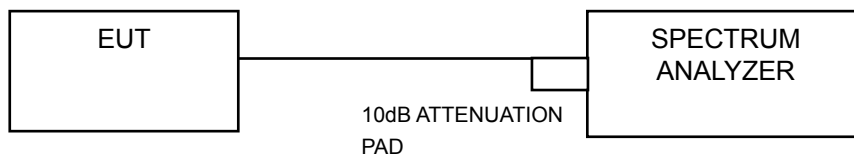

4.4.3 Test Instruments

Refer to section 4.1.2 to get information of above instrument.

4.4.4 Test Procedure

Using method SA-1

- 1) Set span to encompass the entire emission bandwidth (EBW) of the signal.
- 2) Set RBW = 30 kHz, Set VBW ≥ 1 MHz, Detector = RMS
- 3) Set Channel power measure = 1MHz
- 4) Sweep time = auto, trigger set to “free run”.
- 5) Trace average at least 100 traces in power averaging mode.
- 6) Record the max value

4.4.5 Deviation from Test Standard

No deviation.

4.4.6 EUT Operating Condition

Same as Item 4.3.6.

4.4.7 Test Results

802.11a_1TX

Channel	Frequency (MHz)	PSD (dBm)	Maximum Limit (dBm)	Pass/Fail
52	5260	6.49	10.87	Pass
60	5300	8.32	10.87	Pass
64	5320	9.10	10.87	Pass
100	5500	6.38	10.87	Pass
116	5580	6.94	10.87	Pass
140	5700	4.20	10.87	Pass

NOTE: 1. Method 1 of power density measurement of KDB 662911 is using for calculating total power density. Total power density is summing entire spectra across corresponding frequency bins on the various outputs by computer.

2. Gain = 6.13 dBi > 6dBi, so the power density limit shall be reduced to 11-(6.13-6) = 10.87dBm.

802.11n (HT20)_2TX

Chan.	Chan. Freq. (MHz)	PSD (dBm)		Total Power Density (dBm)	Max. Limit (dBm)	Pass/Fail
		Chain 0	Chain 1			
52	5260	4.24	4.42	7.34	7.94	Pass
60	5300	4.77	4.97	7.88	7.94	Pass
64	5320	4.51	5.10	7.83	7.94	Pass
100	5500	4.76	5.08	7.93	7.94	Pass
116	5580	4.58	5.14	7.88	7.94	Pass
140	5700	4.96	4.68	7.83	7.94	Pass

NOTE: 1. Method 1 of power density measurement of KDB 662911 is using for calculating total power density. Total power density is summing entire spectra across corresponding frequency bins on the various outputs by computer.

2. Directional gain = $10 \log[(10^{G1/20} + 10^{G2/20} + \dots + 10^{GN/20})^2/2]$ = 9.06 dBi > 6dBi, so the power density limit shall be reduced to 11-(9.06-6) = 7.94dBm.

802.11n (HT40)_2TX

Chan.	Chan. Freq. (MHz)	PSD (dBm)		Total Power Density (dBm)	Max. Limit (dBm)	Pass/Fail
		Chain 0	Chain 1			
54	5270	2.77	2.69	5.74	7.94	Pass
62	5310	2.82	3.07	5.96	7.94	Pass
102	5510	1.87	2.94	5.45	7.94	Pass
110	5550	3.20	3.89	6.57	7.94	Pass
134	5670	3.35	3.17	6.27	7.94	Pass

- NOTE:** 1. Method 1 of power density measurement of KDB 662911 is using for calculating total power density. Total power density is summing entire spectra across corresponding frequency bins on the various outputs by computer.
2. Directional gain = $10 \log[(10^{G1/20} + 10^{G2/20} + \dots + 10^{GN/20})^2/2] = 9.06 \text{ dBi} > 6\text{dBi}$, so the power density limit shall be reduced to $11-(9.06-6) = 7.94\text{dBm}$.

802.11ac (VHT20)_2TX

Chan.	Chan. Freq. (MHz)	PSD (dBm)		Total Power Density (dBm)	Max. Limit (dBm)	Pass/Fail
		Chain 0	Chain 1			
52	5260	4.54	5.04	7.81	7.94	Pass
60	5300	4.59	5.07	7.85	7.94	Pass
64	5320	4.46	5.12	7.81	7.94	Pass
100	5500	4.35	5.00	7.70	7.94	Pass
116	5580	4.69	4.46	7.59	7.94	Pass
140	5700	5.03	4.67	7.86	7.94	Pass

- NOTE:** 1. Method 1 of power density measurement of KDB 662911 is using for calculating total power density. Total power density is summing entire spectra across corresponding frequency bins on the various outputs by computer.
2. Directional gain = $10 \log[(10^{G1/20} + 10^{G2/20} + \dots + 10^{GN/20})^2/2] = 9.06 \text{ dBi} > 6\text{dBi}$, so the power density limit shall be reduced to $11-(9.06-6) = 7.94\text{dBm}$.

802.11ac (VHT40)_2TX

Chan.	Chan. Freq. (MHz)	PSD (dBm)		Total Power Density (dBm)	Max. Limit (dBm)	Pass/Fail
		Chain 0	Chain 1			
54	5270	2.64	2.70	5.68	7.94	Pass
62	5310	2.70	3.09	5.91	7.94	Pass
102	5510	2.05	2.89	5.50	7.94	Pass
110	5550	3.17	3.70	6.45	7.94	Pass
134	5670	3.48	3.06	6.29	7.94	Pass

- NOTE:** 1. Method 1 of power density measurement of KDB 662911 is using for calculating total power density. Total power density is summing entire spectra across corresponding frequency bins on the various outputs by computer.
2. Directional gain = $10 \log[(10^{G1/20} + 10^{G2/20} + \dots + 10^{GN/20})^2/2] = 9.06 \text{ dBi} > 6\text{dBi}$, so the power density limit shall be reduced to $11-(9.06-6) = 7.94\text{dBm}$.

802.11ac (VHT80)_2TX

Chan.	Chan. Freq. (MHz)	PSD (dBm)		Total Power Density (dBm)	Max. Limit (dBm)	Pass/Fail
		Chain 0	Chain 1			
58	5290	-2.42	-2.17	0.72	7.94	Pass
106	5530	-4.63	-3.96	-1.27	7.94	Pass

- NOTE:** 1. Method 1 of power density measurement of KDB 662911 is using for calculating total power density. Total power density is summing entire spectra across corresponding frequency bins on the various outputs by computer.
2. Directional gain = $10 \log[(10^{G1/20} + 10^{G2/20} + \dots + 10^{GN/20})^2/2] = 9.06 \text{ dBi} > 6\text{dBi}$, so the power density limit shall be reduced to $11-(9.06-6) = 7.94\text{dBm}$.

802.11n (HT20)_3TX

Chan.	Chan. Freq. (MHz)	PSD (dBm)			Total Power Density (dBm)	Max. Limit (dBm)	Pass/Fail
		Chain 0	Chain 1	Chain 2			
52	5260	1.33	1.12	1.03	5.93	6.11	Pass
60	5300	1.36	1.62	0.48	5.95	6.11	Pass
64	5320	1.17	1.66	0.36	5.87	6.11	Pass
100	5500	1.07	1.32	0.51	5.75	6.11	Pass
116	5580	1.35	1.17	0.66	5.84	6.11	Pass
140	5700	1.64	1.35	0.78	6.04	6.11	Pass

- NOTE:** 1. Method 1 of power density measurement of KDB 662911 is using for calculating total power density. Total power density is summing entire spectra across corresponding frequency bins on the various outputs by computer.
2. Directional gain = $10 \log[(10^{G1/20} + 10^{G2/20} + \dots + 10^{GN/20})^2/3]$ = 10.89 dBi > 6dBi , so the power density limit shall be reduced to $11-(10.89-6) = 6.11$ dBm.

802.11n (HT40)_3TX

Chan.	Chan. Freq. (MHz)	PSD (dBm)			Total Power Density (dBm)	Max. Limit (dBm)	Pass/Fail
		Chain 0	Chain 1	Chain 2			
54	5270	1.07	1.04	0.40	5.62	6.11	Pass
62	5310	1.74	-0.12	0.75	5.63	6.11	Pass
102	5510	0.71	1.38	0.94	5.79	6.11	Pass
110	5550	1.28	1.35	0.57	5.85	6.11	Pass
134	5670	0.54	0.44	0.30	5.20	6.11	Pass

- NOTE:** 1. Method 1 of power density measurement of KDB 662911 is using for calculating total power density. Total power density is summing entire spectra across corresponding frequency bins on the various outputs by computer.
2. Directional gain = $10 \log[(10^{G1/20} + 10^{G2/20} + \dots + 10^{GN/20})^2/3]$ = 10.89 dBi > 6dBi , so the power density limit shall be reduced to $11-(10.89-6) = 6.11$ dBm.

802.11ac (VHT20)_3TX

Chan.	Chan. Freq. (MHz)	PSD (dBm)			Total Power Density (dBm)	Max. Limit (dBm)	Pass/Fail
		Chain 0	Chain 1	Chain 2			
52	5260	1.07	0.91	0.59	5.63	6.11	Pass
60	5300	1.41	1.44	0.64	5.95	6.11	Pass
64	5320	1.53	1.35	0.42	5.90	6.11	Pass
100	5500	1.26	1.37	0.35	5.79	6.11	Pass
116	5580	1.45	1.29	0.62	5.91	6.11	Pass
140	5700	1.26	0.92	0.30	5.62	6.11	Pass

- NOTE:** 1. Method 1 of power density measurement of KDB 662911 is using for calculating total power density. Total power density is summing entire spectra across corresponding frequency bins on the various outputs by computer.
2. Directional gain = $10 \log[(10^{G1/20} + 10^{G2/20} + \dots + 10^{GN/20})^2/3]$ = 10.89 dBi > 6dBi , so the power density limit shall be reduced to $11-(10.89-6) = 6.11$ dBm.

802.11ac (VHT40)_3TX

Chan.	Chan. Freq. (MHz)	PSD (dBm)			Total Power Density (dBm)	Max. Limit (dBm)	Pass/Fail
		Chain 0	Chain 1	Chain 2			
54	5270	1.47	1.13	0.56	5.84	6.11	Pass
62	5310	0.91	1.19	1.03	5.82	6.11	Pass
102	5510	1.06	1.23	0.60	5.74	6.11	Pass
110	5550	0.82	0.78	0.72	5.54	6.11	Pass
134	5670	0.82	0.65	0.42	5.40	6.11	Pass

- NOTE:** 1. Method 1 of power density measurement of KDB 662911 is using for calculating total power density. Total power density is summing entire spectra across corresponding frequency bins on the various outputs by computer.
2. Directional gain = $10 \log[(10^{G1/20} + 10^{G2/20} + \dots + 10^{GN/20})^2/3]$ = 10.89 dBi > 6dBi , so the power density limit shall be reduced to $11-(10.89-6) = 6.11$ dBm.

802.11ac (VHT80)_3TX

Chan.	Chan. Freq. (MHz)	PSD (dBm)			Total Power Density (dBm)	Max. Limit (dBm)	Pass/Fail
		Chain 0	Chain 1	Chain 2			
58	5290	-5.61	-5.63	-5.71	-0.88	6.11	Pass
106	5530	-6.15	-5.91	-5.80	-1.18	6.11	Pass

- NOTE:** 1. Method 1 of power density measurement of KDB 662911 is using for calculating total power density. Total power density is summing entire spectra across corresponding frequency bins on the various outputs by computer.
2. Directional gain = $10 \log[(10^{G1/20} + 10^{G2/20} + \dots + 10^{GN/20})^2/3]$ = 10.89 dBi > 6dBi , so the power density limit shall be reduced to $11-(10.89-6) = 6.11$ dBm.

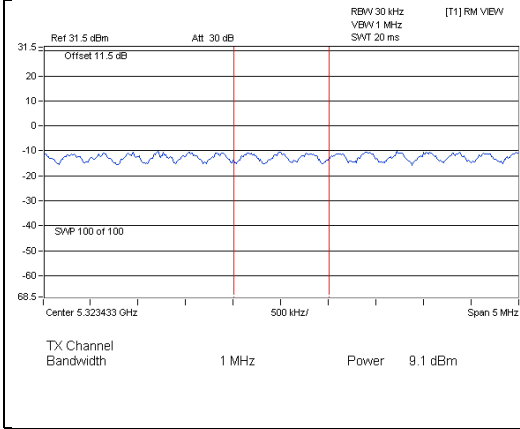
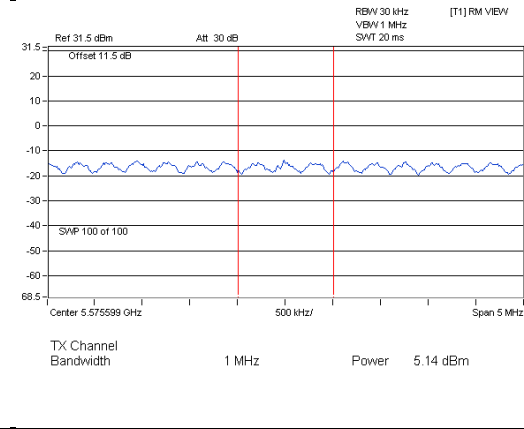
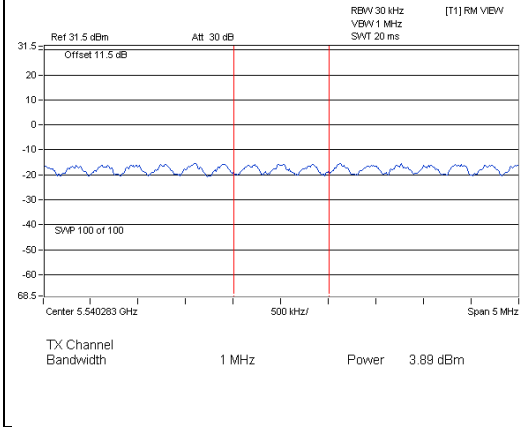
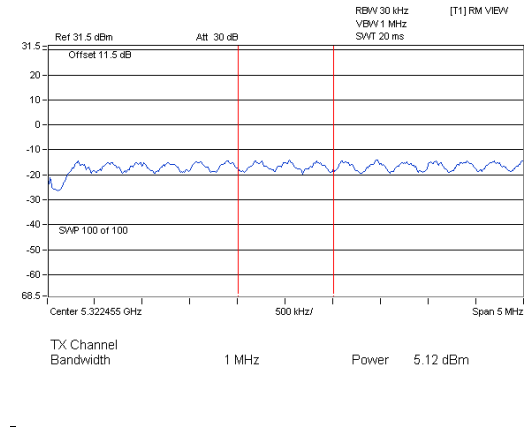
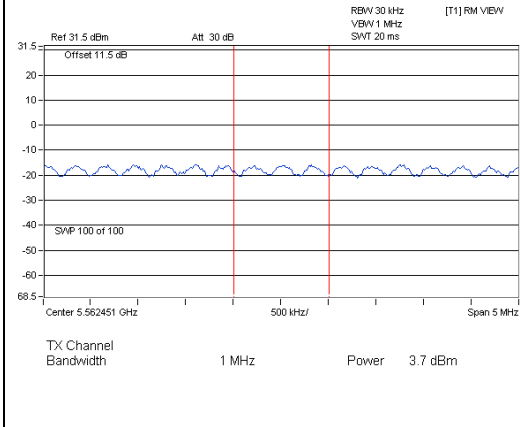
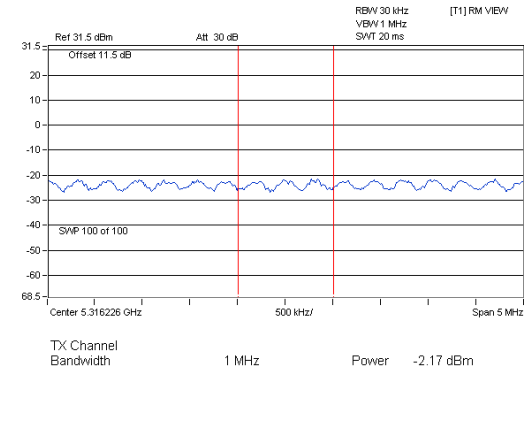
SPECTRUM PLOT OF WORST VALUE**802.11a_1TX****802.11n (HT20)_2TX****802.11n (HT40)_2TX****802.11ac (VHT20)_2TX****802.11ac (VHT40)_2TX****802.11ac (VHT80)_2TX**

SPECTRUM PLOT OF WORST VALUE

802.11n (HT20)_3TX

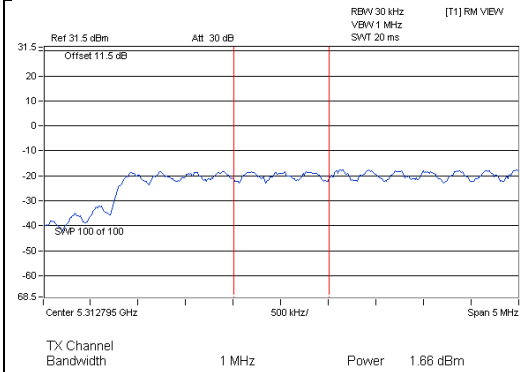

802.11n (HT40)_3TX

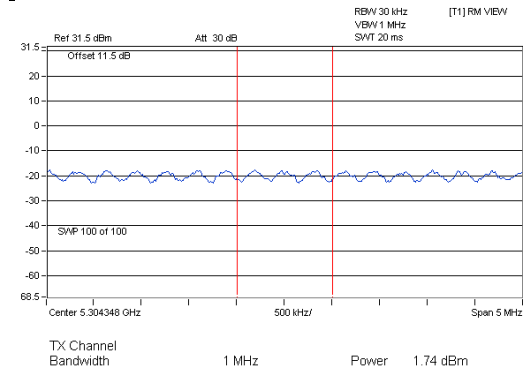

802.11ac (VHT20)_3TX

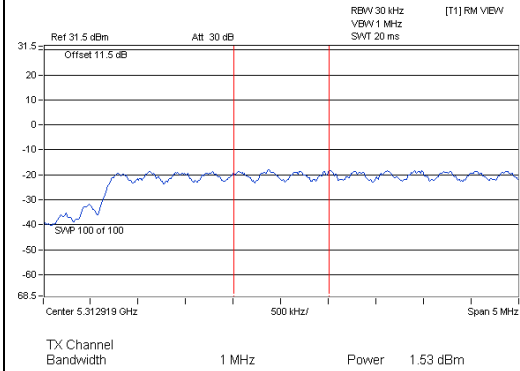

802.11ac (VHT40)_3TX

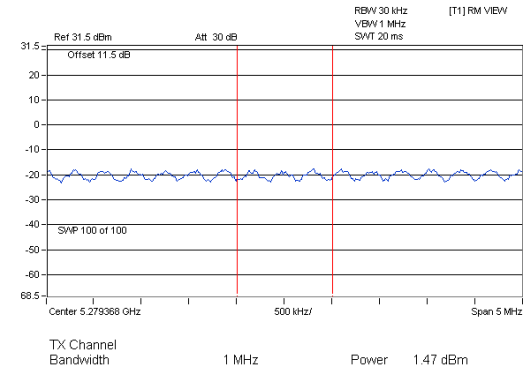

802.11ac (VHT80)_3TX

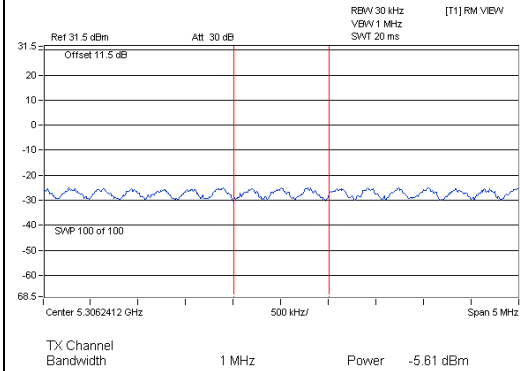

4.5 Frequency Stability Measurement

4.5.1 Limits of Frequency Stability Measurement

The frequency of the carrier signal shall be maintained within band of operation

4.5.2 Test Setup

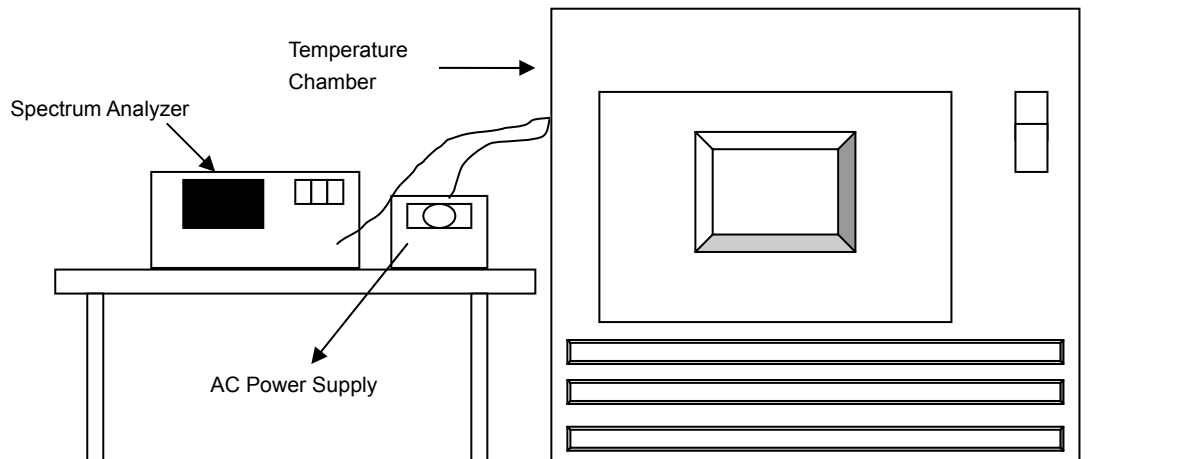

4.5.3 Test Instruments

Refer to section 4.1.2 to get information of above instrument.

4.5.4 Test Procedure

- The EUT was placed inside the environmental test chamber and powered by nominal AC voltage.
- Turn the EUT on and couple its output to a spectrum analyzer.
- Turn the EUT off and set the chamber to the highest temperature specified.
- Allow sufficient time (approximately 30 min) for the temperature of the chamber to stabilize, turn the EUT on and measure the operating frequency after 2, 5, and 10 minutes.
- Repeat step 2 and 3 with the temperature chamber set to the lowest temperature.
- The test chamber was allowed to stabilize at +20 degree C for a minimum of 30 minutes. The supply voltage was then adjusted on the EUT from 85% to 115% and the frequency record.

4.5.5 Deviation from Test Standard

No deviation.

4.5.6 EUT Operating Condition

Set the EUT transmit at un-modulation mode to test frequency stability.

4.5.7 Test Results

FREQUENCY STABILITY VERSUS TEMP.									
OPERATING FREQUENCY: 5320MHz									
TEMP. (°C)	POWER SUPPLY (Vac)	0 MINUTE		2 MINUTE		5 MINUTE		10 MINUTE	
		Measured Frequency (MHz)	Frequency Drift (%)	Measured Frequency (MHz)	Frequency Drift (%)	Measured Frequency (MHz)	Frequency Drift (%)	Measured Frequency (MHz)	Frequency Drift (%)
50	120	5319.9923	-0.00014	5319.9941	-0.00011	5319.992	-0.00015	5319.9922	-0.00015
40	120	5320.0000	0.00000	5319.9984	-0.00003	5319.9983	-0.00003	5320.0028	0.00005
30	120	5319.9785	-0.00040	5319.9771	-0.00043	5319.9761	-0.00045	5319.9796	-0.00038
20	120	5320.0268	0.00050	5320.0252	0.00047	5320.0257	0.00048	5320.0233	0.00044
10	120	5320.0163	0.00031	5320.014	0.00026	5320.0164	0.00031	5320.0157	0.00030
0	120	5319.9954	-0.00009	5319.995	-0.00009	5319.9934	-0.00012	5319.9908	-0.00017

FREQUENCY STABILITY VERSUS VOLTAGE									
OPERATING FREQUENCY: 5320MHz									
TEMP. (°C)	POWER SUPPLY (Vac)	0 MINUTE		2 MINUTE		5 MINUTE		10 MINUTE	
		Measured Frequency (MHz)	Frequency Drift (%)	Measured Frequency (MHz)	Frequency Drift (%)	Measured Frequency (MHz)	Frequency Drift (%)	Measured Frequency (MHz)	Frequency Drift (%)
20	138	5320.0271	0.00051	5320.0247	0.00046	5320.0266	0.00050	5320.0242	0.00045
	120	5320.0268	0.00050	5320.0252	0.00047	5320.0257	0.00048	5320.0233	0.00044
	102	5320.0258	0.00048	5320.0261	0.00049	5320.0251	0.00047	5320.0238	0.00045



5 Pictures of Test Arrangements

Please refer to the attached file (Test Setup Photo).



Appendix – Information on the Testing Laboratories

We, Bureau Veritas Consumer Products Services (H.K.) Ltd., Taoyuan Branch, were founded in 1988 to provide our best service in EMC, Radio, Telecom and Safety consultation. Our laboratories are accredited and approved according to ISO/IEC 17025.

If you have any comments, please feel free to contact us at the following:

Linko EMC/RF Lab

Tel: 886-2-26052180

Fax: 886-2-26051924

Hsin Chu EMC/RF Lab/Telecom Lab

Tel: 886-3-5935343

Fax: 886-3-5935342

Hwa Ya EMC/RF/Safety

Tel: 886-3-3183232

Fax: 886-3-3270892

Email: service.adt@tw.bureauveritas.com

Web Site: www.bureauveritas-adt.com

The address and road map of all our labs can be found in our web site also.

--- END ---