

FCC Test Report

Report No.: RF141227C17-1

FCC ID: 2ACTO-AP100C

Test Model: AP 100C

Received Date: Dec. 27, 2014

Test Date: Jan. 20 ~ Mar. 05, 2015

Issued Date: Mar. 12, 2015

Applicant: Sophos Ltd

Address: The Pentagon, Abingdon, OX14 3YP, United Kingdom

Issued By: Bureau Veritas Consumer Products Services (H.K.) Ltd., Taoyuan Branch

Lab Address: No. 47-2, 14th Ling, Chia Pau Vil., Lin Kou Dist., New Taipei City, Taiwan

Test Location: No. 19, Hwa Ya 2nd Rd., Wen Hwa Vil., Kwei Shan Dist., Taoyuan City
33383, TAIWAN (R.O.C.)



This report is for your exclusive use. Any copying or replication of this report to or for any other person or entity, or use of our name or trademark, is permitted only with our prior written permission. This report sets forth our findings solely with respect to the test samples identified herein. The results set forth in this report are not indicative or representative of the quality or characteristics of the lot from which a test sample was taken or any similar or identical product unless specifically and expressly noted. Our report includes all of the tests requested by you and the results thereof based upon the information that you provided to us. You have 60 days from date of issuance of this report to notify us of any material error or omission caused by our negligence, provided, however, that such notice shall be in writing and shall specifically address the issue you wish to raise. A failure to raise such issue within the prescribed time shall constitute your unqualified acceptance of the completeness of this report, the tests conducted and the correctness of the report contents. Unless specific mention, the uncertainty of measurement has been explicitly taken into account to declare the compliance or non-compliance to the specification. The report must not be used by the client to claim product certification, approval, or endorsement by TAF or any government agencies.

Table of Contents

Release Control Record	4
1 Certificate of Conformity	5
2 Summary of Test Results	6
2.1 Measurement Uncertainty.....	6
2.2 Modification Record.....	6
3 General Information	7
3.1 General Description of EUT.....	7
3.2 Description of Test Modes.....	9
3.2.1 Test Mode Applicability and Tested Channel Detail.....	10
3.3 Duty Cycle of Test Signal.....	13
3.4 Description of Support Units.....	15
3.4.1 Configuration of System under Test.....	15
3.5 General Description of Applied Standard.....	16
4 Test Types and Results	17
4.1 Radiated Emission and Bandedge Measurement.....	17
4.1.1 Limits of Radiated Emission and Bandedge Measurement.....	17
4.1.2 Test Instruments.....	18
4.1.3 Test Procedure.....	19
4.1.4 Deviation from Test Standard.....	19
4.1.5 Test Setup.....	20
4.1.6 EUT Operating Conditions.....	21
4.1.7 Test Results.....	22
4.2 Conducted Emission Measurement.....	73
4.2.1 Limits of Conducted Emission Measurement.....	73
4.2.2 Test Instruments.....	73
4.2.3 Test Procedure.....	74
4.2.4 Deviation from Test Standard.....	74
4.2.5 Test Setup.....	74
4.2.6 EUT Operating Conditions.....	74
4.2.7 Test Results.....	75
4.3 Transmit Power Measurement.....	77
4.3.1 Limits of Transmit Power Measurement.....	77
4.3.2 Test Setup.....	77
4.3.3 Test Instruments.....	77
4.3.4 Test Procedure.....	78
4.3.5 Deviation from Test Standard.....	78
4.3.6 EUT Operating Conditions.....	78
4.3.7 Test Result.....	79
4.4 Peak Power Spectral Density Measurement.....	88
4.4.1 Limits of Peak Power Spectral Density Measurement.....	88
4.4.2 Test Setup.....	88
4.4.3 Test Instruments.....	88
4.4.4 Test Procedure.....	88
4.4.5 Deviation from Test Standard.....	89
4.4.6 EUT Operating Condition.....	89
4.4.7 Test Results.....	90
4.5 Frequency Stability.....	102
4.5.1 Limits of Frequency Stability Measurement.....	102
4.5.2 Test Setup.....	102
4.5.3 Test Instruments.....	102
4.5.4 Test Procedure.....	102
4.5.5 Deviation from Test Standard.....	102
4.5.6 EUT Operating Condition.....	102



4.5.7 Test Results	103
4.6 6dB Bandwidth Measurement	104
4.6.1 Limits of 6dB Bandwidth Measurement	104
4.6.2 Test Setup	104
4.6.3 Test Instruments	104
4.6.4 Test Procedure	104
4.6.5 Deviation from Test Standard	104
4.6.6 EUT Operating Condition	104
4.6.7 Test Results	105
5 Pictures of Test Arrangements	110
Appendix – Information on the Testing Laboratories	111



Release Control Record

Issue No.	Description	Date Issued
RF141227C17-1	Original release.	Mar. 12, 2015

1 Certificate of Conformity

Product: Sophos wireless Access Point AP 100C

Brand: Sophos

Test Model: AP 100C

Sample Status: Engineering sample

Applicant: Sophos Ltd

Test Date: Jan. 20 ~ Mar. 05, 2015

Standard: 47 CFR FCC Part 15, Subpart E (Section 15.407)
ANSI C63.10:2009

The above equipment has been tested by **Bureau Veritas Consumer Products Services (H.K.) Ltd., Taoyuan Branch**, and found compliance with the requirement of the above standards. The test record, data evaluation & Equipment Under Test (EUT) configurations represented herein are true and accurate accounts of the measurements of the sample's EMC characteristics under the Conditions specified in this report.

Prepared by : , **Date:** Mar. 12, 2015
Pettie Chen / Senior Specialist

Approved by : , **Date:** Mar. 12, 2015
Ken Liu / Senior Manager

2 Summary of Test Results

47 CFR FCC Part 15, Subpart E (SECTION 15.407)			
FCC Clause	Test Item	Result	Remarks
15.407(b)(6)	AC Power Conducted Emissions	PASS	Meet the requirement of limit. Minimum passing margin is -16.17dB at 0.48041MHz.
15.407(b)(1/2/3/4/6)	Radiated Emissions & Band Edge Measurement	PASS	Meet the requirement of limit. Minimum passing margin is -1.0dB at 5150.00, 5714.90, 11490.00, 11510.00, 11570.00, 15600.00, 16500.00MHz.
15.407(a)(1/2/3)	Max Average Transmit Power	PASS	Meet the requirement of limit.
15.407(a)(1/2/3)	Peak Power Spectral Density	PASS	Meet the requirement of limit.
15.407(e)	6dB bandwidth	PASS	Meet the requirement of limit. (U-NII-3 Band only)
15.407(g)	Frequency Stability	PASS	Meet the requirement of limit.
15.203	Antenna Requirement	PASS	Ant. D, E: No antenna connector is used. Ant. F: Antenna connector is I-PEX not a standard connector.

2.1 Measurement Uncertainty

Where relevant, the following measurement uncertainty levels have been estimated for tests performed on the EUT as specified in CISPR 16-4-2:

Measurement	Frequency	Expanded Uncertainty (k=2) (±)
Conducted Emissions at mains ports	150kHz ~ 30MHz	2.44 dB
Radiated Emissions up to 1 GHz	30MHz ~ 200MHz	3.63 dB
	200MHz ~ 1000MHz	3.64 dB
Radiated Emissions above 1 GHz	1GHz ~ 18GHz	2.29 dB
	18GHz ~ 40GHz	2.29 dB

2.2 Modification Record

There were no modifications required for compliance.

3 General Information

3.1 General Description of EUT

Product	Sophos wireless Access Point AP 100C
Brand	Sophos
Test Model	AP 100C
Status of EUT	Engineering sample
Power Supply Rating	12Vdc (adapter)
Modulation Type	64QAM, 16QAM, QPSK, BPSK
Modulation Technology	OFDM
Transfer Rate	802.11a: 54.0/ 48.0/ 36.0/ 24.0/ 18.0/ 12.0/ 9.0/ 6.0Mbps 802.11n: up to 450.0Mbps 802.11ac: up to 1300Mbps
Operating Frequency	5180 ~ 5240MHz & 5745 ~ 5825MHz
Number of Channel	5180 ~ 5240MHz: 4 for 802.11a, 802.11n (HT20), 802.11ac (VHT20) 2 for 802.11n (HT40), 802.11ac (VHT40) 1 for 802.11ac (VHT80) 5745 ~ 5825MHz: 5 for 802.11a, 802.11n (HT20), 802.11ac (VHT20) 2 for 802.11n (HT40), 802.11ac (VHT40) 1 for 802.11ac (VHT80)
Output Power	1TX: 802.11a: 5180 ~ 5240MHz: 214.783mW 5745 ~ 5825MHz: 76.208mW 2TX: 802.11n (HT20): 5180 ~ 5240MHz: 406.704mW 5745 ~ 5825MHz: 67.560 mW 802.11n (HT40): 5180 ~ 5240MHz: 453.974mW 5745 ~ 5825MHz: 97.895mW 802.11ac (VHT20): 5180 ~ 5240MHz: 414.934mW 5745 ~ 5825MHz: 66.705mW 802.11ac (VHT40): 5180 ~ 5240MHz: 467.769mW 5745 ~ 5825MHz: 96.038mW 802.11ac (VHT80): 5180 ~ 5240MHz: 82.421mW 5745 ~ 5825MHz: 66.716mW

Output Power	3TX: 802.11n (HT20): 5180 ~ 5240MHz: 386.333mW 5745 ~ 5825MHz: 88.595mW 802.11n (HT40): 5180 ~ 5240MHz: 647.225mW 5745 ~ 5825MHz: 120.565mW 802.11ac (VHT20): 5180 ~ 5240MHz: 378.003mW 5745 ~ 5825MHz: 89.898mW 802.11ac (VHT40): 5180 ~ 5240MHz: 641.813mW 5745 ~ 5825MHz: 118.867mW 802.11ac (VHT80): 5180 ~ 5240MHz: 96.617mW 5745 ~ 5825MHz: 86.153mW
Antenna Type	Refer to Note
Antenna Connector	Refer to Note
Accessory Device	NA
Data Cable Supplied	NA

Note:

- The EUT incorporates a MIMO function. Physically, the EUT provides 3 completed transmitters and 3 receivers.

Modulation Mode	TX FUNCTION
802.11a	1TX (Ant. D)
802.11n (HT20)	2TX/3TX
802.11n (HT40)	2TX/3TX
802.11ac (VHT20)	2TX/3TX
802.11ac (VHT40)	2TX/3TX
802.11ac (VHT80)	2TX/3TX

*The EUT doesn't support diversity function in 802.11a and 2TX of 802.11n (HT20), 802.11n (HT40), 802.11ac (VHT20), 802.11ac (VHT40) & 802.11ac (VHT80).

*For 802.11a was fixed in Antenna D.

*For 2TX of 802.11n (HT20), 802.11n (HT40), 802.11ac (VHT20), 802.11ac (VHT40) & 802.11ac (VHT80) were fixed in Antenna D & E

*The EUT doesn't support beamforming function.

- The EUT uses following adapter. (Support unit only)

Brand	Asian Power Devices Inc.
Model	WA-18Q12R
Input Power	100-240Vac ~50-60Hz 0.5A Max.
Output Power	12Vdc / 1.5A
Power Line	1.5m cable without core

- The following antennas were provided to the EUT.

Antenna Type	PIFA	P/N	Gain (dBi)	Antenna Connector
Ant. D		RFMTA100800NN5B001	6.13	NA
Ant. E		RFMTA100800NN5B002	5.96	NA
Ant. F		RFMTA150719IM5B301	6.27	I-PEX

4. The above EUT information is declared by manufacturer and for more detailed features description, please refer to the manufacturer's specifications or user's manual.

3.2 Description of Test Modes

FOR 5180 ~ 5240MHz

4 channels are provided for 802.11a, 802.11n (HT20), 802.11ac (VHT20):

Channel	Frequency	Channel	Frequency
36	5180 MHz	44	5220 MHz
40	5200 MHz	48	5240 MHz

2 channels are provided for 802.11n (HT40), 802.11ac (40MHz):

Channel	Frequency	Channel	Frequency
38	5190 MHz	46	5230 MHz

1 channel is provided for 802.11ac (VHT80):

Channel	Frequency
42	5210MHz

FOR 5745 ~ 5825MHz:

5 channels are provided for 802.11a, 802.11n (HT20), 802.11ac (VHT20):

Channel	Frequency	Channel	Frequency
149	5745MHz	161	5805MHz
153	5765MHz	165	5825MHz
157	5785MHz		

2 channels are provided for 802.11n (HT40), 802.11ac (VHT40):

Channel	Frequency	Channel	Frequency
151	5755MHz	159	5795MHz

1 channel is provided for 802.11ac (VHT80):

Channel	Frequency
155	5775MHz

3.2.1 Test Mode Applicability and Tested Channel Detail

EUT CONFIGURE MODE	APPLICABLE TO				DESCRIPTION
	RE≥1G	RE<1G	PLC	APCM	
-	√	√	√	√	-

Where **RE≥1G**: Radiated Emission above 1GHz **RE<1G**: Radiated Emission below 1GHz
PLC: Power Line Conducted Emission **APCM**: Antenna Port Conducted Measurement

NOTE:

1. The EUT had been pre-tested on the positioned of each 3 axis. The worst case was found when positioned on **Z-plane**.

Radiated Emission Test (Above 1GHz):

- Pre-Scan has been conducted to determine the worst-case mode from all possible combinations between available modulations, data rates and antenna ports (if EUT with antenna diversity architecture).
- Following channel(s) was (were) selected for the final test as listed below.

EUT CONFIGURE MODE	MODE	FREQ. BAND (MHz)	AVAILABLE CHANNEL	TESTED CHANNEL	MODULATION TECHNOLOGY	MODULATION TYPE	DATA RATE (Mbps)	TX FUNCTION
-	802.11a	5180-5240	36 to 48	36, 40, 48	OFDM	BPSK	6.0	1TX
-	802.11n (HT20)		36 to 48	36, 40, 48	OFDM	BPSK	6.5	2TX/3TX
-	802.11n (HT40)		38 to 46	38, 46	OFDM	BPSK	13.5	2TX/3TX
-	802.11ac (VHT20)		36 to 48	36, 40, 48	OFDM	BPSK	13.0	2TX
-			36 to 48	36, 40, 48	OFDM	BPSK	19.5	3TX
-	802.11ac (VHT40)		38 to 46	38, 46	OFDM	BPSK	27.0	2TX
-			38 to 46	38, 46	OFDM	BPSK	40.5	3TX
-	802.11ac (VHT80)		42	42	OFDM	BPSK	58.5	2TX
-			42	42	OFDM	BPSK	87.5	3TX
-	802.11a		5745-5825	149 to 165	149, 157, 165	OFDM	BPSK	6.0
-	802.11n (HT20)	149 to 165		149, 157, 165	OFDM	BPSK	6.5	2TX/3TX
-	802.11n (HT40)	151 to 159		151, 159	OFDM	BPSK	13.5	2TX/3TX
-	802.11ac (VHT20)	149 to 165		149, 157, 165	OFDM	BPSK	13.0	2TX
-		149 to 165		149, 157, 165	OFDM	BPSK	19.5	3TX
-	802.11ac (VHT40)	151 to 159		151, 159	OFDM	BPSK	27.0	2TX
-		151 to 159		151, 159	OFDM	BPSK	40.5	3TX
-	802.11ac (VHT80)	155		155	OFDM	BPSK	58.5	2TX
-		155		155	OFDM	BPSK	87.5	3TX

Radiated Emission Test (Below 1GHz):

- Pre-Scan has been conducted to determine the worst-case mode from all possible combinations between available modulations, data rates and antenna ports (if EUT with antenna diversity architecture).
- Following channel(s) was (were) selected for the final test as listed below.

EUT CONFIGURE MODE	MODE	FREQ. BAND (MHz)	AVAILABLE CHANNEL	TESTED CHANNEL	MODULATION TECHNOLOGY	MODULATION TYPE	DATA RATE (Mbps)	TX FUNCTION
-	802.11ac (VHT20)	5180-5320 5745-5825	36 to 64 149 to 165	40	OFDM	BPSK	13.0	2TX

Power Line Conducted Emission Test:

- Pre-Scan has been conducted to determine the worst-case mode from all possible combinations between available modulations, data rates and antenna ports (if EUT with antenna diversity architecture).
- Following channel(s) was (were) selected for the final test as listed below.

EUT CONFIGURE MODE	MODE	FREQ. BAND (MHz)	AVAILABLE CHANNEL	TESTED CHANNEL	MODULATION TECHNOLOGY	MODULATION TYPE	DATA RATE (Mbps)	TX FUNCTION
-	802.11ac (VHT20)	5180-5320 5745-5825	36 to 64 149 to 165	40	OFDM	BPSK	13.0	2TX

Antenna Port Conducted Measurement:

- This item includes all test value of each mode, but only includes spectrum plot of worst value of each mode.
- Pre-Scan has been conducted to determine the worst-case mode from all possible combinations between available modulations, data rates and antenna ports (if EUT with antenna diversity architecture).
- Following channel(s) was (were) selected for the final test as listed below.

EUT CONFIGURE MODE	MODE	FREQ. BAND (MHz)	AVAILABLE CHANNEL	TESTED CHANNEL	MODULATION TECHNOLOGY	MODULATION TYPE	DATA RATE (Mbps)	TX FUNCTION
-	802.11a	5180-5240	36 to 48	36, 40, 48	OFDM	BPSK	6.0	1TX
-	802.11n (HT20)		36 to 48	36, 40, 48	OFDM	BPSK	6.5	2TX/3TX
-	802.11n (HT40)		38 to 46	38, 46	OFDM	BPSK	13.5	2TX/3TX
-	802.11ac (VHT20)		36 to 48	36, 40, 48	OFDM	BPSK	13.0	2TX
-			36 to 48	36, 40, 48	OFDM	BPSK	19.5	3TX
-	802.11ac (VHT40)		38 to 46	38, 46	OFDM	BPSK	27.0	2TX
-			38 to 46	38, 46	OFDM	BPSK	40.5	3TX
-	802.11ac (VHT80)		42	42	OFDM	BPSK	58.5	2TX
-			42	42	OFDM	BPSK	87.5	3TX
-	802.11a		5745-5825	149 to 165	149, 157, 165	OFDM	BPSK	6.0
-	802.11n (HT20)	149 to 165		149, 157, 165	OFDM	BPSK	6.5	2TX/3TX
-	802.11n (HT40)	151 to 159		151, 159	OFDM	BPSK	13.5	2TX/3TX
-	802.11ac (VHT20)	149 to 165		149, 157, 165	OFDM	BPSK	13.0	2TX
-		149 to 165		149, 157, 165	OFDM	BPSK	19.5	3TX
-	802.11ac (VHT40)	151 to 159		151, 159	OFDM	BPSK	27.0	2TX
-		151 to 159		151, 159	OFDM	BPSK	40.5	3TX
-	802.11ac (VHT80)	155		155	OFDM	BPSK	58.5	2TX
-		155		155	OFDM	BPSK	87.5	3TX

Test Condition:

APPLICABLE TO	ENVIRONMENTAL CONDITIONS	INPUT POWER	TESTED BY
RE \geq 1G	25deg. C, 60%RH	120Vac, 60Hz	Tank Wu
RE $<$ 1G	25deg. C, 60%RH	120Vac, 60Hz	Tank Wu
PLC	25deg. C, 60%RH	120Vac, 60Hz	Tank Wu
APCM	25deg. C, 60%RH	120Vac, 60Hz	Nick Chen

3.3 Duty Cycle of Test Signal

Duty cycle of test signal is $\geq 98\%$, duty factor is not required.

- 802.11a_1TX: Duty cycle = $23.8/24.05 = 0.99$
- 802.11n (HT20)_2TX: Duty cycle = $23.925/24.025 = 0.996$
- 802.11n (HT40)_2TX: Duty cycle = $23.925/24.05 = 0.995$
- 802.11ac (VHT20)_2TX: Duty cycle = $23.875/24 = 0.995$
- 802.11ac (VHT40)_2TX: Duty cycle = $23.925/24.125 = 0.992$
- 802.11ac (VHT80)_2TX: Duty cycle = $23.825/24.05 = 0.991$
- 802.11n (HT20)_3TX: Duty cycle = $23.825/24.125 = 0.988$
- 802.11n (HT40)_3TX: Duty cycle = $23.9/24.075 = 0.993$
- 802.11ac (VHT20)_3TX: Duty cycle = $23.875/23.975 = 0.996$
- 802.11ac (VHT40)_3TX: Duty cycle = $23.775/23.975 = 0.992$
- 802.11ac (VHT80)_3TX: Duty cycle = $23.9/24.05 = 0.994$

802.11a_1TX

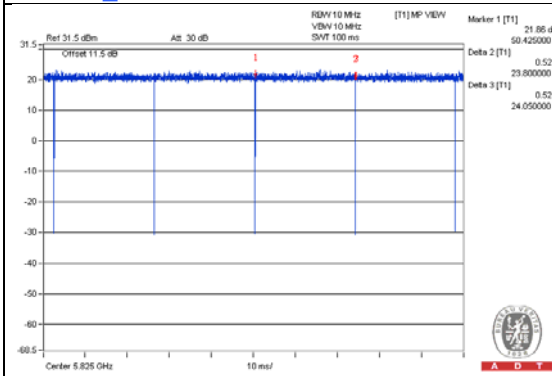

802.11n (HT20)_2TX

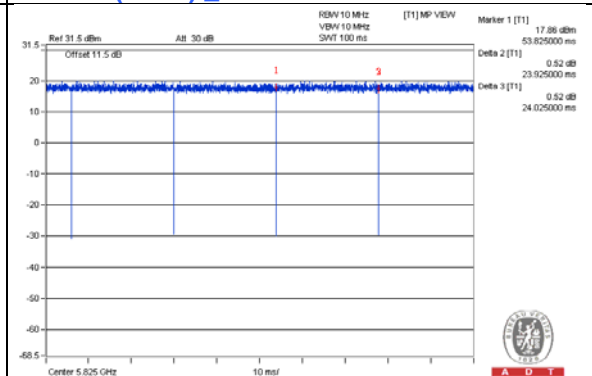

802.11n (HT40)_2TX

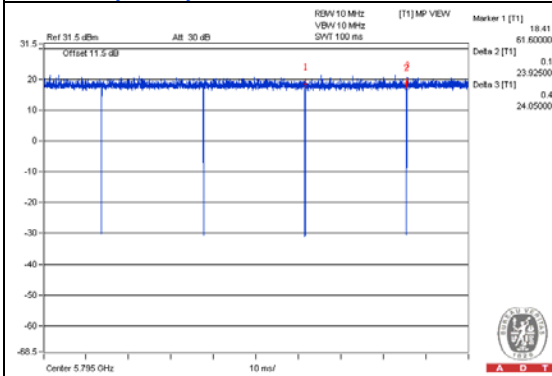

802.11ac (VHT20)_2TX

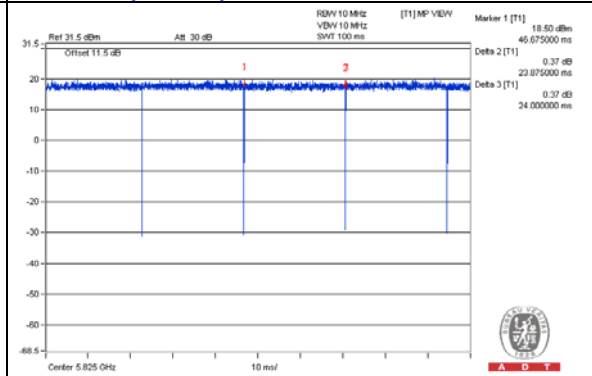

802.11ac (VHT40)_2TX

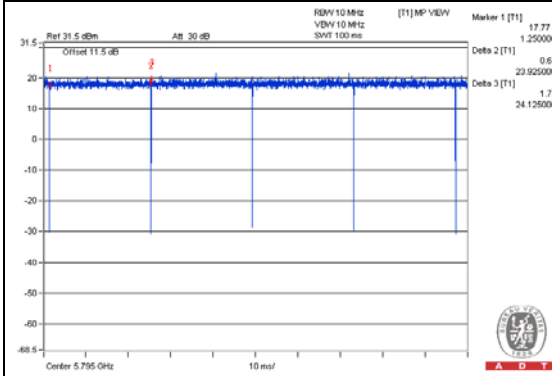

802.11ac (VHT80)_2TX

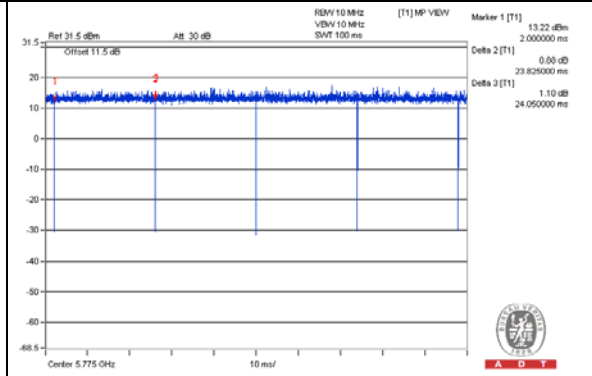

802.11n (HT20)_3TX

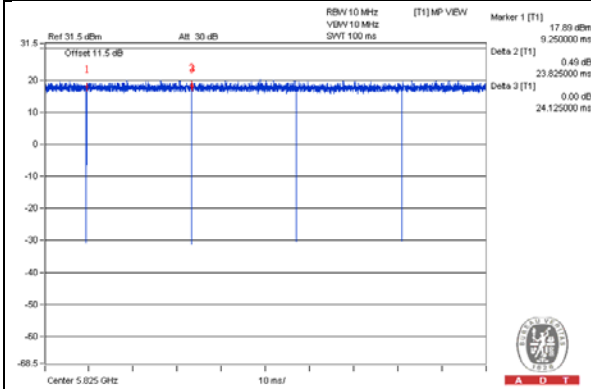

802.11n (HT40)_3TX

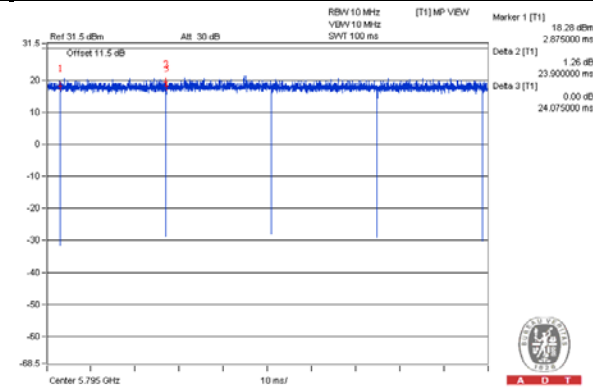

802.11ac (VHT20)_3TX

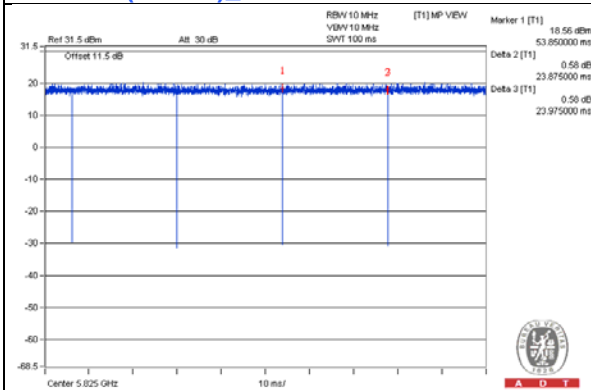

802.11ac (VHT40)_3TX

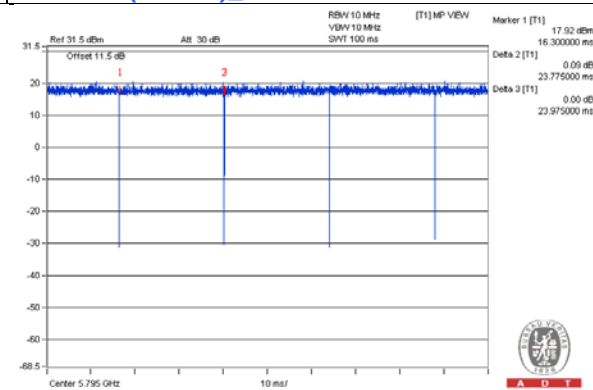

802.11ac (VHT80)_3TX

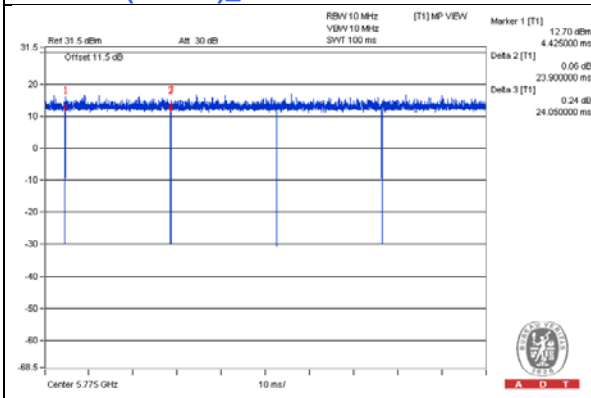

3.4 Description of Support Units

The EUT has been tested as an independent unit together with other necessary accessories or support units. The following support units or accessories were used to form a representative test configuration during the tests.

ID	Product	Brand	Model No.	Serial No.	FCC ID	Remarks
A.	Notebook	DELL	E5410	1HC2XM1	FCC DoC Approved	-
B.	Adapter	Asian Power Devices Inc.	WA-18Q12R	NA	NA	Provided by client.

Note:

1. All power cords of the above support units are non-shielded (1.8m).
2. Item A acted as communication partners to transfer data.

ID	Descriptions	Qty.	Length (m)	Shielding (Yes/No)	Cores (Qty.)	Remarks
1.	RJ 45 cable	1	10	N	0	-

Note: The core(s) is(are) originally attached to the cable(s).

3.4.1 Configuration of System under Test

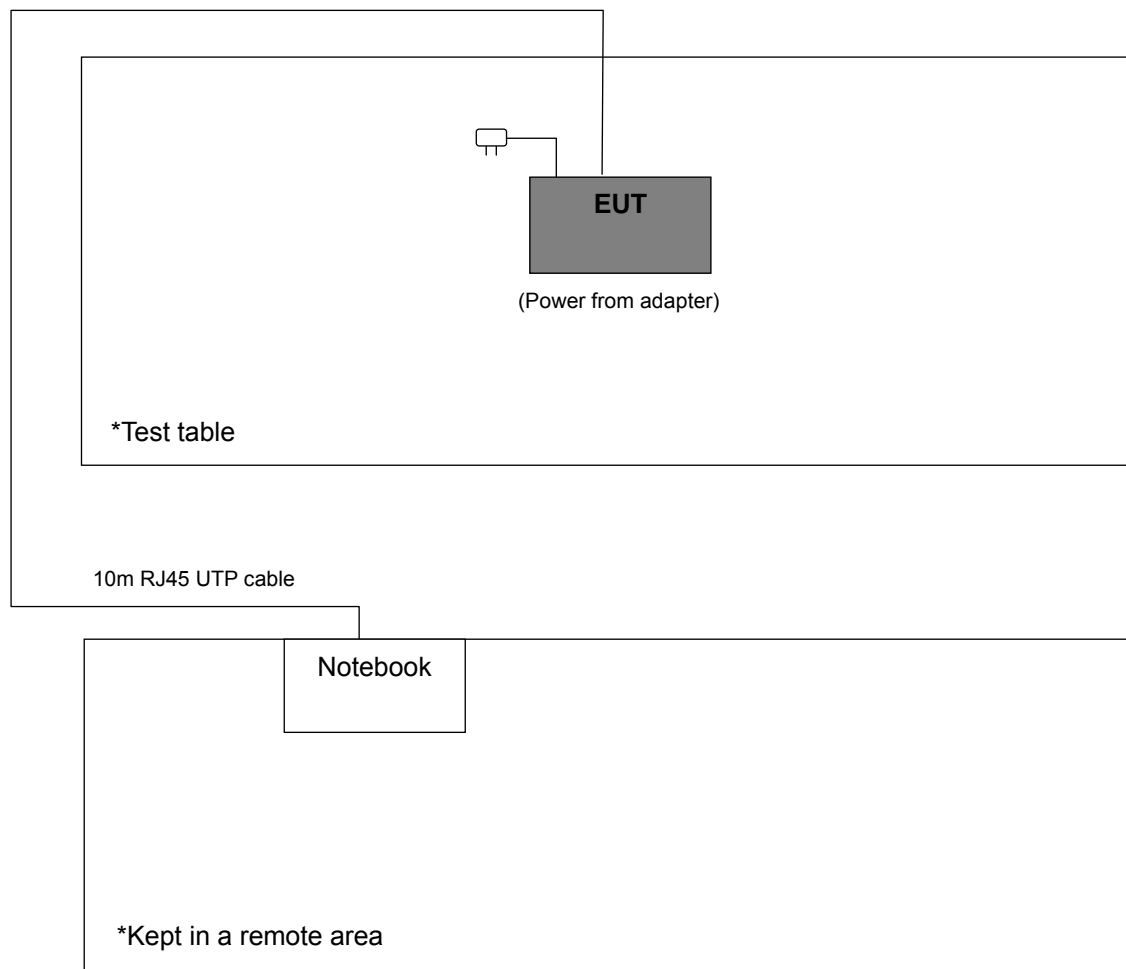

3.5 General Description of Applied Standard

The EUT is a RF Product. According to the specifications of the manufacturer, it must comply with the requirements of the following standards:

FCC Part 15, Subpart E (15.407)
789033 D02 General UNII Test Procedure New Rules v01
662911 D01 Multiple Transmitter Output v02r01
ANSI C63.10-2009

All test items have been performed and recorded as per the above standards.

NOTE: The EUT is also considered as a kind of computer peripheral, because the connection to computer is necessary for typical use. It has been verified to comply with the requirements of FCC Part 15, Subpart B, Class B (DoC). The test report has been issued separately.

4 Test Types and Results

4.1 Radiated Emission and Bandedge Measurement

4.1.1 Limits of Radiated Emission and Bandedge Measurement

Radiated emissions which fall in the restricted bands must comply with the radiated emission limits specified as below table.

Frequencies (MHz)	Field Strength (microvolts/meter)	Measurement Distance (meters)
0.009 ~ 0.490	2400/F(kHz)	300
0.490 ~ 1.705	24000/F(kHz)	30
1.705 ~ 30.0	30	30
30 ~ 88	100	3
88 ~ 216	150	3
216 ~ 960	200	3
Above 960	500	3

NOTE:

1. The lower limit shall apply at the transition frequencies.
2. Emission level (dBuV/m) = 20 log Emission level (uV/m).
3. For frequencies above 1000MHz, the field strength limits are based on average detector, however, the peak field strength of any emission shall not exceed the maximum permitted average limits, specified above by more than 20dB under any Condition of modulation.

LIMITS OF UNWANTED EMISSION OUT OF THE RESTRICTED BANDS

APPLICABLE TO	LIMIT	
789033 D02 General UNII Test Procedure New Rules v01	FIELD STRENGTH AT 3m	
	PK:74 (dBuV/m)	AV:54 (dBuV/m)
APPLICABLE TO	EIRP LIMIT	EQUIVALENT FIELD STRENGTH AT 3m
15.407(b)(1)	PK:-27 (dBm/MHz)	PK:68.2(dBuV/m)
15.407(b)(2)		
15.407(b)(3)		
15.407(b)(4)	PK:-27 (dBm/MHz) ^{*1} PK:-17 (dBm/MHz) ^{*2}	PK: 68.2(dBuV/m) ^{*1} PK:78.2 (dBuV/m) ^{*2}

NOTE: ^{*1} beyond 10MHz of the band edge ^{*2} within 10 MHz of band edge

The following formula is used to convert the equipment isotropic radiated power (eirp) to field strength:

$$E = \frac{1000000\sqrt{30P}}{3} \mu\text{V/m, where P is the eirp (Watts).}$$

4.1.2 Test Instruments

Description & Manufacturer	Model No.	Serial No.	Date Of Calibration	Due Date Of Calibration
Test Receiver ROHDE & SCHWARZ	ESCS30	100289	Dec. 01, 2014	Nov. 30, 2015
Spectrum Analyzer ROHDE & SCHWARZ	E4446A	MY51100039	Aug. 18, 2014	Aug. 17, 2015
BILOG Antenna SCHWARZBECK	VULB9168	9168-156	Feb. 27, 2014	Feb. 26, 2015
			Feb. 06, 2015	Feb. 05, 2016
HORN Antenna SCHWARZBECK	BBHA 9120 D	9120D-1169	Aug. 26, 2014	Feb. 08, 2016
			Feb. 09, 2015	Feb. 08, 2016
HORN Antenna SCHWARZBECK	BBHA 9170	BBHA9170241	Feb. 17, 2014	Feb. 16, 2015
			Feb. 09, 2015	Feb. 08, 2016
Preamplifier Agilent	8449B	3008A01911	Aug. 09, 2014	Aug. 08, 2015
Preamplifier Agilent	8447D	2944A10638	Aug. 09, 2014	Aug. 08, 2015
RF signal cable HUBER+SUHNNER	SUCOFLEX 104	248780/4 309222/4 274092/4	Aug. 09, 2014	Aug. 08, 2015
RF signal cable Worken	8D-FB	Cable-CH9-01	Aug. 11, 2014	Aug. 10, 2015
Software BV ADT	ADT_Radiated_ V7.6.15.9.4	NA	NA	NA
Antenna Tower EMCO	2070/2080	512.835.4684	NA	NA
Turn Table EMCO	2087-2.03	NA	NA	NA
Antenna Tower & Turn Table Controller EMCO	2090	NA	NA	NA
High Speed Peak Power Meter	ML2495A	0824011	Jul. 26, 2014	Jul. 25, 2015
Power Sensor	MA2411B	0738171	Jul. 26, 2014	Jul. 25, 2015
WIT Standard Temperature And Humidity Chamber	TH-4S-C	W981030	Jun. 09, 2014	Jun. 08, 2015

- NOTE: 1. The calibration interval of the above test instruments is 12 months and the calibrations are traceable to NML/ROC and NIST/USA.
2. The test was performed in HwaYa Chamber 9.
3. The horn antenna and HP preamplifier (model: 8449B) are used only for the measurement of emission frequency above 1GHz if tested.
4. The FCC Site Registration No. is 215374.
5. The IC Site Registration No. is IC 7450F-9.

4.1.3 Test Procedure

- a. The EUT was placed on the top of a rotating table 0.8 meters above the ground at 3 meter chamber room for test. The table was rotated 360 degrees to determine the position of the highest radiation.
- b. The EUT was set 3 meters away from the interference-receiving antenna, which was mounted on the top of a variable-height antenna tower.
- c. The height of antenna is varied from one meter to four meters above the ground to determine the maximum value of the field strength. Both horizontal and vertical polarizations of the antenna are set to make the measurement.
- d. For each suspected emission, the EUT was arranged to its worst case and then the antenna was tuned to heights from 1 meter to 4 meters and the rotatable table was turned from 0 degrees to 360 degrees to find the maximum reading.
- e. The test-receiver system was set to quasi-peak detect function and specified bandwidth with maximum hold mode when the test frequency is below 1 GHz.
- f. The test-receiver system was set to peak and average detect function and specified bandwidth with maximum hold mode when the test frequency is above 1 GHz. If the peak reading value also meets average limit, measurement with the average detector is unnecessary.

Note:

1. The resolution bandwidth and video bandwidth of test receiver/spectrum analyzer is 120kHz for Quasi-peak detection (QP) at frequency below 1GHz.
2. The resolution bandwidth of test receiver/spectrum analyzer is 1 MHz and the video bandwidth is 3 MHz for Peak detection (PK) at frequency above 1GHz.
3. The resolution bandwidth of test receiver/spectrum analyzer is 1MHz and the video bandwidth is 3MHz for RMS Average (Duty cycle < 98%) for Average detection (AV) at frequency above 1GHz, then the measurement results was added to a correction factor ($10 \log(1/\text{duty cycle})$).
4. The resolution bandwidth of test receiver/spectrum analyzer is 1MHz and the video bandwidth is 10Hz (Duty cycle $\geq 98\%$) for Average detection (AV) at frequency above 1GHz.
5. All modes of operation were investigated and the worst-case emissions are reported.

4.1.4 Deviation from Test Standard

No deviation.

4.1.5 Test Setup

<Frequency Range below 1GHz>

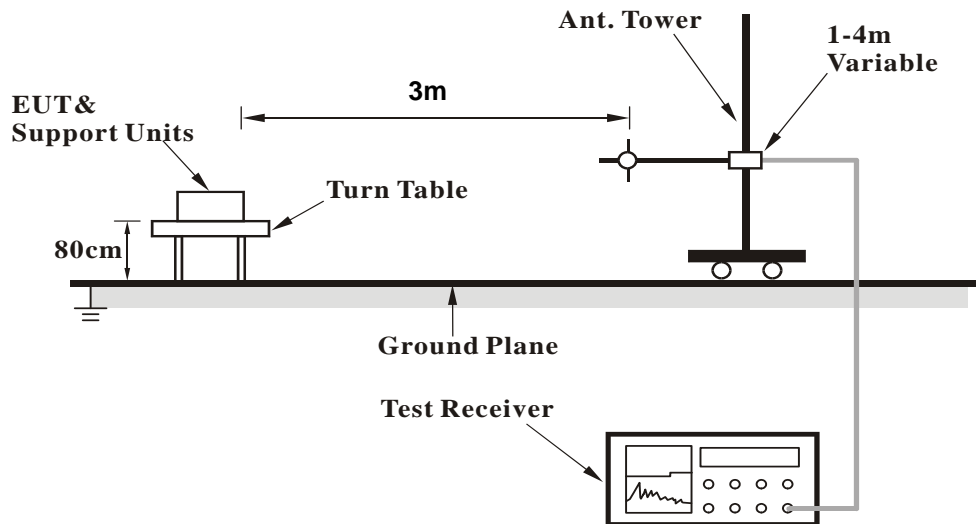

<Frequency Range above 1GHz>

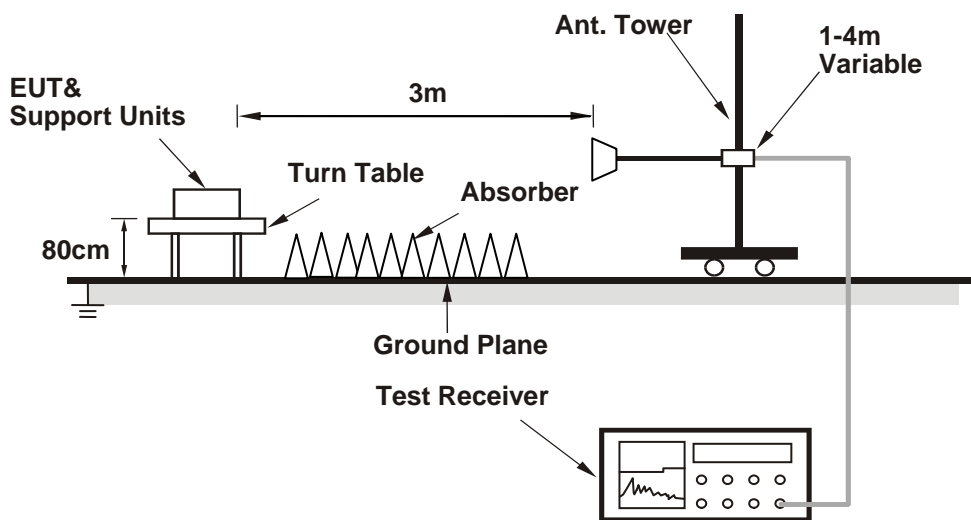

For the actual test configuration, please refer to the attached file (Test Setup Photo).

4.1.6 EUT Operating Conditions

- a. Placed the EUT on the testing table.
- b. Prepared notebooks to act as communication partner and placed it outside of testing area.
- c. The communication partner connected with EUT via a RJ45 cable and ran a test program (provided by manufacturer) to enable EUT under transmission condition continuously at specific channel frequency.
- d. The communication partner sent data to EUT by command "PING".
- e. The necessary accessories enable the system in full functions.

4.1.7 Test Results
ABOVE 1GHz DATA :
802.11a_1TX

CHANNEL	TX Channel 36	DETECTOR FUNCTION	Peak (PK)
FREQUENCY RANGE	1GHz ~ 40GHz		Average (AV)

ANTENNA POLARITY & TEST DISTANCE: HORIZONTAL AT 3 M

NO.	FREQ. (MHz)	EMISSION LEVEL (dBuV/m)	LIMIT (dBuV/m)	MARGIN (dB)	ANTENNA HEIGHT (m)	TABLE ANGLE (Degree)	RAW VALUE (dBuV)	CORRECTION FACTOR (dB/m)
1	#3453.00	48.5 PK	74.0	-25.5	1.06 H	326	50.30	-1.80
2	#3453.00	44.1 AV	54.0	-9.9	1.06 H	326	45.90	-1.80
3	5150.00	65.8 PK	74.0	-8.2	1.14 H	74	63.80	2.00
4	5150.00	52.4 AV	54.0	-1.6	1.14 H	74	50.40	2.00
5	*5180.00	114.2 PK			1.13 H	69	74.20	40.00
6	*5180.00	103.4 AV			1.13 H	69	63.40	40.00
7	#10360.00	61.2 PK	74.0	-12.8	1.23 H	341	46.20	15.00
8	#10360.00	47.1 AV	54.0	-6.9	1.23 H	341	32.10	15.00
9	15540.00	63.5 PK	74.0	-10.5	1.00 H	61	47.60	15.90
10	15540.00	50.3 AV	54.0	-3.7	1.00 H	61	34.40	15.90

ANTENNA POLARITY & TEST DISTANCE: VERTICAL AT 3 M

NO.	FREQ. (MHz)	EMISSION LEVEL (dBuV/m)	LIMIT (dBuV/m)	MARGIN (dB)	ANTENNA HEIGHT (m)	TABLE ANGLE (Degree)	RAW VALUE (dBuV)	CORRECTION FACTOR (dB/m)
1	#3453.00	47.0 PK	74.0	-27.0	1.21 V	32	48.80	-1.80
2	#3453.00	39.1 AV	54.0	-14.9	1.21 V	32	40.90	-1.80
3	5150.00	65.0 PK	74.0	-9.0	1.00 V	30	63.00	2.00
4	5150.00	50.1 AV	54.0	-3.9	1.00 V	30	48.10	2.00
5	*5180.00	112.7 PK			1.00 V	30	72.70	40.00
6	*5180.00	102.5 AV			1.00 V	30	62.50	40.00
7	#10360.00	61.4 PK	74.0	-12.6	1.16 V	18	46.40	15.00
8	#10360.00	47.3 AV	54.0	-6.7	1.16 V	18	32.30	15.00
9	15540.00	63.4 PK	74.0	-10.6	1.00 V	45	47.50	15.90
10	15540.00	50.6 AV	54.0	-3.4	1.00 V	45	34.70	15.90

REMARKS:

1. Emission Level(dBuV/m) = Raw Value(dBuV) + Correction Factor(dB/m)
2. Correction Factor(dB/m) = Antenna Factor(dB/m) + Cable Factor(dB)
3. The other emission levels were very low against the limit.
4. Margin value = Emission Level – Limit value
5. " * ": Fundamental frequency.
6. " # ": The radiated frequency is out of the restricted band.

CHANNEL	TX Channel 40	DETECTOR FUNCTION	Peak (PK)
FREQUENCY RANGE	1GHz ~ 40GHz		Average (AV)

ANTENNA POLARITY & TEST DISTANCE: HORIZONTAL AT 3 M

NO.	FREQ. (MHz)	EMISSION LEVEL (dBuV/m)	LIMIT (dBuV/m)	MARGIN (dB)	ANTENNA HEIGHT (m)	TABLE ANGLE (Degree)	RAW VALUE (dBuV)	CORRECTION FACTOR (dB/m)
1	#3466.00	47.1 PK	74.0	-26.9	1.02 H	263	48.90	-1.80
2	#3466.00	39.0 AV	54.0	-15.0	1.02 H	263	40.80	-1.80
3	*5200.00	114.3 PK			1.01 H	69	74.20	40.10
4	*5200.00	103.8 AV			1.01 H	69	63.70	40.10
5	#10400.00	65.0 PK	74.0	-9.0	1.02 H	18	50.00	15.00
6	#10400.00	50.7 AV	54.0	-3.3	1.02 H	18	35.70	15.00
7	15600.00	64.0 PK	74.0	-10.0	1.00 H	18	48.50	15.50
8	15600.00	51.0 AV	54.0	-3.0	1.00 H	18	35.50	15.50

ANTENNA POLARITY & TEST DISTANCE: VERTICAL AT 3 M

NO.	FREQ. (MHz)	EMISSION LEVEL (dBuV/m)	LIMIT (dBuV/m)	MARGIN (dB)	ANTENNA HEIGHT (m)	TABLE ANGLE (Degree)	RAW VALUE (dBuV)	CORRECTION FACTOR (dB/m)
1	#3466.00	46.4 PK	74.0	-27.6	1.02 V	40	48.20	-1.80
2	#3466.00	38.6 AV	54.0	-15.4	1.02 V	40	40.40	-1.80
3	*5200.00	114.8 PK			1.00 V	32	74.70	40.10
4	*5200.00	103.9 AV			1.00 V	32	63.80	40.10
5	#10400.00	59.5 PK	74.0	-14.5	1.00 V	299	44.50	15.00
6	#10400.00	46.8 AV	54.0	-7.2	1.00 V	299	31.80	15.00
7	15600.00	70.0 PK	74.0	-4.0	1.01 V	34	54.50	15.50
8	15600.00	52.6 AV	54.0	-1.4	1.01 V	34	37.10	15.50

REMARKS:

1. Emission Level(dBuV/m) = Raw Value(dBuV) + Correction Factor(dB/m)
2. Correction Factor(dB/m) = Antenna Factor(dB/m) + Cable Factor(dB)
3. The other emission levels were very low against the limit.
4. Margin value = Emission Level – Limit value
5. " * ": Fundamental frequency.
6. " # ": The radiated frequency is out of the restricted band.

CHANNEL	TX Channel 48	DETECTOR FUNCTION	Peak (PK)
FREQUENCY RANGE	1GHz ~ 40GHz		Average (AV)

ANTENNA POLARITY & TEST DISTANCE: HORIZONTAL AT 3 M

NO.	FREQ. (MHz)	EMISSION LEVEL (dBuV/m)	LIMIT (dBuV/m)	MARGIN (dB)	ANTENNA HEIGHT (m)	TABLE ANGLE (Degree)	RAW VALUE (dBuV)	CORRECTION FACTOR (dB/m)
1	#3493.00	49.1 PK	74.0	-24.9	1.23 H	344	50.90	-1.80
2	#3493.00	43.4 AV	54.0	-10.6	1.23 H	344	45.20	-1.80
3	*5240.00	115.8 PK			1.01 H	61	75.70	40.10
4	*5240.00	105.1 AV			1.01 H	61	65.00	40.10
5	5350.00	57.9 PK	74.0	-16.1	1.01 H	61	55.90	2.00
6	5350.00	45.5 AV	54.0	-8.5	1.01 H	61	43.50	2.00
7	#10480.00	60.0 PK	74.0	-14.0	1.00 H	136	44.90	15.10
8	#10480.00	46.9 AV	54.0	-7.1	1.00 H	136	31.80	15.10
9	15720.00	62.0 PK	74.0	-12.0	1.19 H	80	47.10	14.90
10	15720.00	49.7 AV	54.0	-4.3	1.19 H	80	34.80	14.90

ANTENNA POLARITY & TEST DISTANCE: VERTICAL AT 3 M

NO.	FREQ. (MHz)	EMISSION LEVEL (dBuV/m)	LIMIT (dBuV/m)	MARGIN (dB)	ANTENNA HEIGHT (m)	TABLE ANGLE (Degree)	RAW VALUE (dBuV)	CORRECTION FACTOR (dB/m)
1	#3493.00	49.5 PK	74.0	-24.5	1.00 V	310	51.30	-1.80
2	#3493.00	43.3 AV	54.0	-10.7	1.00 V	310	45.10	-1.80
3	*5240.00	114.3 PK			1.00 V	32	74.20	40.10
4	*5240.00	103.4 AV			1.00 V	32	63.30	40.10
5	5350.00	58.3 PK	74.0	-15.7	1.15 V	34	56.30	2.00
6	5350.00	45.2 AV	54.0	-8.8	1.15 V	34	43.20	2.00
7	#10480.00	59.8 PK	74.0	-14.2	1.00 V	139	44.70	15.10
8	#10480.00	46.8 AV	54.0	-7.2	1.00 V	139	31.70	15.10
9	15720.00	66.3 PK	74.0	-7.7	1.04 V	29	51.40	14.90
10	15720.00	52.4 AV	54.0	-1.6	1.04 V	29	37.50	14.90

REMARKS:

1. Emission Level(dBuV/m) = Raw Value(dBuV) + Correction Factor(dB/m)
2. Correction Factor(dB/m) = Antenna Factor(dB/m) + Cable Factor(dB)
3. The other emission levels were very low against the limit.
4. Margin value = Emission Level – Limit value
5. " * ": Fundamental frequency.
6. " # ": The radiated frequency is out of the restricted band.

802.11n (HT20)_2TX

CHANNEL	TX Channel 36	DETECTOR FUNCTION	Peak (PK)
FREQUENCY RANGE	1GHz ~ 40GHz		Average (AV)

ANTENNA POLARITY & TEST DISTANCE: HORIZONTAL AT 3 M

NO.	FREQ. (MHz)	EMISSION LEVEL (dBuV/m)	LIMIT (dBuV/m)	MARGIN (dB)	ANTENNA HEIGHT (m)	TABLE ANGLE (Degree)	RAW VALUE (dBuV)	CORRECTION FACTOR (dB/m)
1	#3453.00	44.9 PK	74.0	-29.1	1.12 H	326	46.70	-1.80
2	#3453.00	34.2 AV	54.0	-19.8	1.12 H	326	36.00	-1.80
3	5150.00	66.4 PK	74.0	-7.6	1.25 H	310	64.40	2.00
4	5150.00	51.1 AV	54.0	-2.9	1.25 H	310	49.10	2.00
5	*5180.00	114.2 PK			1.04 H	58	74.20	40.00
6	*5180.00	104.0 AV			1.04 H	58	64.00	40.00
7	#10360.00	59.7 PK	74.0	-14.3	1.00 H	193	44.70	15.00
8	#10360.00	46.7 AV	54.0	-7.3	1.00 H	193	31.70	15.00

ANTENNA POLARITY & TEST DISTANCE: VERTICAL AT 3 M

NO.	FREQ. (MHz)	EMISSION LEVEL (dBuV/m)	LIMIT (dBuV/m)	MARGIN (dB)	ANTENNA HEIGHT (m)	TABLE ANGLE (Degree)	RAW VALUE (dBuV)	CORRECTION FACTOR (dB/m)
1	#3453.00	46.5 PK	74.0	-27.5	1.01 V	36	48.30	-1.80
2	#3453.00	37.6 AV	54.0	-16.4	1.01 V	36	39.40	-1.80
3	5150.00	66.0 PK	74.0	-8.0	1.23 V	70	64.00	2.00
4	5150.00	52.4 AV	54.0	-1.6	1.23 V	70	50.40	2.00
5	*5180.00	115.3 PK			1.01 V	35	75.30	40.00
6	*5180.00	105.5 AV			1.01 V	35	65.50	40.00
7	#10360.00	59.7 PK	74.0	-14.3	1.00 V	132	44.70	15.00
8	#10360.00	47.3 AV	54.0	-6.7	1.00 V	132	32.30	15.00

REMARKS:

1. Emission Level(dBuV/m) = Raw Value(dBuV) + Correction Factor(dB/m)
2. Correction Factor(dB/m) = Antenna Factor(dB/m) + Cable Factor(dB)
3. The other emission levels were very low against the limit.
4. Margin value = Emission Level – Limit value
5. " * ": Fundamental frequency.
6. " # ": The radiated frequency is out of the restricted band.



CHANNEL	TX Channel 40	DETECTOR FUNCTION	Peak (PK)
FREQUENCY RANGE	1GHz ~ 40GHz		Average (AV)

ANTENNA POLARITY & TEST DISTANCE: HORIZONTAL AT 3 M

NO.	FREQ. (MHz)	EMISSION LEVEL (dBuV/m)	LIMIT (dBuV/m)	MARGIN (dB)	ANTENNA HEIGHT (m)	TABLE ANGLE (Degree)	RAW VALUE (dBuV)	CORRECTION FACTOR (dB/m)
1	#3466.00	45.4 PK	74.0	-28.6	1.08 H	339	47.20	-1.80
2	#3466.00	34.0 AV	54.0	-20.0	1.08 H	339	35.80	-1.80
3	*5200.00	117.5 PK			1.03 H	58	77.40	40.10
4	*5200.00	106.8 AV			1.03 H	58	66.70	40.10
5	#10400.00	60.8 PK	74.0	-13.2	1.00 H	316	45.80	15.00
6	#10400.00	47.3 AV	54.0	-6.7	1.00 H	316	32.30	15.00
7	15600.00	65.4 PK	74.0	-8.6	1.00 H	18	49.90	15.50
8	15600.00	51.0 AV	54.0	-3.0	1.00 H	18	35.50	15.50

ANTENNA POLARITY & TEST DISTANCE: VERTICAL AT 3 M

NO.	FREQ. (MHz)	EMISSION LEVEL (dBuV/m)	LIMIT (dBuV/m)	MARGIN (dB)	ANTENNA HEIGHT (m)	TABLE ANGLE (Degree)	RAW VALUE (dBuV)	CORRECTION FACTOR (dB/m)
1	#3466.00	47.8 PK	74.0	-26.2	1.00 V	41	49.60	-1.80
2	#3466.00	37.4 AV	54.0	-16.6	1.00 V	41	39.20	-1.80
3	*5200.00	119.5 PK			1.13 V	34	79.40	40.10
4	*5200.00	108.9 AV			1.13 V	34	68.80	40.10
5	#10400.00	60.2 PK	74.0	-13.8	1.00 V	163	45.20	15.00
6	#10400.00	47.2 AV	54.0	-6.8	1.00 V	163	32.20	15.00
7	15600.00	67.8 PK	74.0	-6.2	1.09 V	28	52.30	15.50
8	15600.00	52.9 AV	54.0	-1.1	1.09 V	28	37.40	15.50

REMARKS:

1. Emission Level(dBuV/m) = Raw Value(dBuV) + Correction Factor(dB/m)
2. Correction Factor(dB/m) = Antenna Factor(dB/m) + Cable Factor(dB)
3. The other emission levels were very low against the limit.
4. Margin value = Emission Level – Limit value
5. " * ": Fundamental frequency.
6. " # ": The radiated frequency is out of the restricted band.

CHANNEL	TX Channel 48	DETECTOR FUNCTION	Peak (PK)
FREQUENCY RANGE	1GHz ~ 40GHz		Average (AV)

ANTENNA POLARITY & TEST DISTANCE: HORIZONTAL AT 3 M

NO.	FREQ. (MHz)	EMISSION LEVEL (dBuV/m)	LIMIT (dBuV/m)	MARGIN (dB)	ANTENNA HEIGHT (m)	TABLE ANGLE (Degree)	RAW VALUE (dBuV)	CORRECTION FACTOR (dB/m)
1	#3493.00	45.1 PK	74.0	-28.9	1.33 H	261	46.90	-1.80
2	#3493.00	33.9 AV	54.0	-20.1	1.33 H	261	35.70	-1.80
3	*5240.00	117.3 PK			1.01 H	59	77.20	40.10
4	*5240.00	107.3 AV			1.01 H	59	67.20	40.10
5	5350.00	58.7 PK	74.0	-15.3	1.15 H	347	56.70	2.00
6	5350.00	45.2 AV	54.0	-8.8	1.15 H	347	43.20	2.00
7	#10480.00	60.0 PK	74.0	-14.0	1.00 H	142	44.90	15.10
8	#10480.00	47.2 AV	54.0	-6.8	1.00 H	142	32.10	15.10
9	15720.00	63.7 PK	74.0	-10.3	1.00 H	19	48.80	14.90
10	15720.00	49.8 AV	54.0	-4.2	1.00 H	19	34.90	14.90

ANTENNA POLARITY & TEST DISTANCE: VERTICAL AT 3 M

NO.	FREQ. (MHz)	EMISSION LEVEL (dBuV/m)	LIMIT (dBuV/m)	MARGIN (dB)	ANTENNA HEIGHT (m)	TABLE ANGLE (Degree)	RAW VALUE (dBuV)	CORRECTION FACTOR (dB/m)
1	#3493.00	45.8 PK	74.0	-28.2	1.00 V	30	47.60	-1.80
2	#3493.00	37.4 AV	54.0	-16.6	1.00 V	30	39.20	-1.80
3	*5240.00	119.0 PK			1.00 V	32	78.90	40.10
4	*5240.00	108.6 AV			1.00 V	32	68.50	40.10
5	5350.00	59.0 PK	74.0	-15.0	1.00 V	6	57.00	2.00
6	5350.00	46.5 AV	54.0	-7.5	1.00 V	6	44.50	2.00
7	#10480.00	60.1 PK	74.0	-13.9	1.00 V	79	45.00	15.10
8	#10480.00	46.8 AV	54.0	-7.2	1.00 V	79	31.70	15.10
9	15720.00	67.7 PK	74.0	-6.3	1.08 V	28	52.80	14.90
10	15720.00	52.2 AV	54.0	-1.8	1.08 V	28	37.30	14.90

REMARKS:

1. Emission Level(dBuV/m) = Raw Value(dBuV) + Correction Factor(dB/m)
2. Correction Factor(dB/m) = Antenna Factor(dB/m) + Cable Factor(dB)
3. The other emission levels were very low against the limit.
4. Margin value = Emission Level – Limit value
5. " * ": Fundamental frequency.
6. " # ": The radiated frequency is out of the restricted band.

802.11n (HT40)_2TX

CHANNEL	TX Channel 38	DETECTOR FUNCTION	Peak (PK)
FREQUENCY RANGE	1GHz ~ 40GHz		Average (AV)

ANTENNA POLARITY & TEST DISTANCE: HORIZONTAL AT 3 M

NO.	FREQ. (MHz)	EMISSION LEVEL (dBuV/m)	LIMIT (dBuV/m)	MARGIN (dB)	ANTENNA HEIGHT (m)	TABLE ANGLE (Degree)	RAW VALUE (dBuV)	CORRECTION FACTOR (dB/m)
1	5150.00	68.9 PK	74.0	-5.1	1.26 H	306	66.90	2.00
2	5150.00	53.0 AV	54.0	-1.0	1.26 H	306	51.00	2.00
3	*5190.00	110.8 PK			1.04 H	54	70.80	40.00
4	*5190.00	100.5 AV			1.04 H	54	60.50	40.00
5	#10380.00	61.0 PK	74.0	-13.0	1.02 H	34	46.00	15.00
6	#10380.00	47.6 AV	54.0	-6.4	1.02 H	34	32.60	15.00

ANTENNA POLARITY & TEST DISTANCE: VERTICAL AT 3 M

NO.	FREQ. (MHz)	EMISSION LEVEL (dBuV/m)	LIMIT (dBuV/m)	MARGIN (dB)	ANTENNA HEIGHT (m)	TABLE ANGLE (Degree)	RAW VALUE (dBuV)	CORRECTION FACTOR (dB/m)
1	5150.00	66.8 PK	74.0	-7.2	1.24 V	71	64.80	2.00
2	5150.00	52.2 AV	54.0	-1.8	1.24 V	71	50.20	2.00
3	*5190.00	111.0 PK			1.00 V	32	71.00	40.00
4	*5190.00	101.3 AV			1.00 V	32	61.30	40.00
5	#10380.00	60.7 PK	74.0	-13.3	1.02 V	64	45.70	15.00
6	#10380.00	47.5 AV	54.0	-6.5	1.02 V	64	32.50	15.00

REMARKS:

1. Emission Level(dBuV/m) = Raw Value(dBuV) + Correction Factor(dB/m)
2. Correction Factor(dB/m) = Antenna Factor(dB/m) + Cable Factor(dB)
3. The other emission levels were very low against the limit.
4. Margin value = Emission Level – Limit value
5. " * ": Fundamental frequency.
6. " # ": The radiated frequency is out of the restricted band.

CHANNEL	TX Channel 46	DETECTOR FUNCTION	Peak (PK)
FREQUENCY RANGE	1GHz ~ 40GHz		Average (AV)

ANTENNA POLARITY & TEST DISTANCE: HORIZONTAL AT 3 M

NO.	FREQ. (MHz)	EMISSION LEVEL (dBuV/m)	LIMIT (dBuV/m)	MARGIN (dB)	ANTENNA HEIGHT (m)	TABLE ANGLE (Degree)	RAW VALUE (dBuV)	CORRECTION FACTOR (dB/m)
1	5150.00	70.3 PK	74.0	-3.7	1.18 H	52	68.30	2.00
2	5150.00	52.5 AV	54.0	-1.5	1.18 H	52	50.50	2.00
3	*5230.00	115.3 PK			1.02 H	57	75.20	40.10
4	*5230.00	105.4 AV			1.02 H	57	65.30	40.10
5	5350.00	58.9 PK	74.0	-15.1	1.00 H	39	56.90	2.00
6	5350.00	45.3 AV	54.0	-8.7	1.00 H	39	43.30	2.00
7	#10460.00	60.5 PK	74.0	-13.5	1.02 H	54	45.50	15.00
8	#10460.00	47.2 AV	54.0	-6.8	1.02 H	54	32.20	15.00
9	15690.00	62.8 PK	74.0	-11.2	1.00 H	18	47.80	15.00
10	15690.00	49.5 AV	54.0	-4.5	1.00 H	18	34.50	15.00

ANTENNA POLARITY & TEST DISTANCE: VERTICAL AT 3 M

NO.	FREQ. (MHz)	EMISSION LEVEL (dBuV/m)	LIMIT (dBuV/m)	MARGIN (dB)	ANTENNA HEIGHT (m)	TABLE ANGLE (Degree)	RAW VALUE (dBuV)	CORRECTION FACTOR (dB/m)
1	5150.00	67.4 PK	74.0	-6.6	1.00 V	64	65.40	2.00
2	5150.00	52.8 AV	54.0	-1.2	1.00 V	64	50.80	2.00
3	*5230.00	116.4 PK			1.00 V	32	76.30	40.10
4	*5230.00	106.1 AV			1.00 V	32	66.00	40.10
5	5350.00	60.0 PK	74.0	-14.0	1.00 V	49	58.00	2.00
6	5350.00	46.7 AV	54.0	-7.3	1.00 V	49	44.70	2.00
7	#10460.00	60.6 PK	74.0	-13.4	1.02 V	48	45.60	15.00
8	#10460.00	47.5 AV	54.0	-6.5	1.02 V	48	32.50	15.00
9	15690.00	66.9 PK	74.0	-7.1	1.08 V	27	51.90	15.00
10	15690.00	50.9 AV	54.0	-3.1	1.08 V	27	35.90	15.00

REMARKS:

1. Emission Level(dBuV/m) = Raw Value(dBuV) + Correction Factor(dB/m)
2. Correction Factor(dB/m) = Antenna Factor(dB/m) + Cable Factor(dB)
3. The other emission levels were very low against the limit.
4. Margin value = Emission Level – Limit value
5. " * ": Fundamental frequency.
6. " # ": The radiated frequency is out of the restricted band.

802.11ac (VHT20)_2TX

CHANNEL	TX Channel 36	DETECTOR FUNCTION	Peak (PK)
FREQUENCY RANGE	1GHz ~ 40GHz		Average (AV)

ANTENNA POLARITY & TEST DISTANCE: HORIZONTAL AT 3 M

NO.	FREQ. (MHz)	EMISSION LEVEL (dBuV/m)	LIMIT (dBuV/m)	MARGIN (dB)	ANTENNA HEIGHT (m)	TABLE ANGLE (Degree)	RAW VALUE (dBuV)	CORRECTION FACTOR (dB/m)
1	5150.00	67.6 PK	74.0	-6.4	1.30 H	305	65.60	2.00
2	5150.00	52.7 AV	54.0	-1.3	1.30 H	305	50.70	2.00
3	*5180.00	114.2 PK			1.03 H	60	74.20	40.00
4	*5180.00	103.9 AV			1.03 H	60	63.90	40.00
5	#10360.00	60.1 PK	74.0	-13.9	1.02 H	54	45.10	15.00
6	#10360.00	47.2 AV	54.0	-6.8	1.02 H	54	32.20	15.00

ANTENNA POLARITY & TEST DISTANCE: VERTICAL AT 3 M

NO.	FREQ. (MHz)	EMISSION LEVEL (dBuV/m)	LIMIT (dBuV/m)	MARGIN (dB)	ANTENNA HEIGHT (m)	TABLE ANGLE (Degree)	RAW VALUE (dBuV)	CORRECTION FACTOR (dB/m)
1	5150.00	68.1 PK	74.0	-5.9	1.11 V	67	66.10	2.00
2	5150.00	52.5 AV	54.0	-1.5	1.11 V	67	50.50	2.00
3	*5180.00	116.2 PK			1.01 V	31	76.20	40.00
4	*5180.00	105.9 AV			1.01 V	31	65.90	40.00
5	#10360.00	61.0 PK	74.0	-13.0	1.02 V	65	46.00	15.00
6	#10360.00	47.5 AV	54.0	-6.5	1.02 V	65	32.50	15.00

REMARKS:

1. Emission Level(dBuV/m) = Raw Value(dBuV) + Correction Factor(dB/m)
2. Correction Factor(dB/m) = Antenna Factor(dB/m) + Cable Factor(dB)
3. The other emission levels were very low against the limit.
4. Margin value = Emission Level – Limit value
5. " * ": Fundamental frequency.
6. " # ": The radiated frequency is out of the restricted band.

CHANNEL	TX Channel 40	DETECTOR FUNCTION	Peak (PK)
FREQUENCY RANGE	1GHz ~ 40GHz		Average (AV)

ANTENNA POLARITY & TEST DISTANCE: HORIZONTAL AT 3 M

NO.	FREQ. (MHz)	EMISSION LEVEL (dBuV/m)	LIMIT (dBuV/m)	MARGIN (dB)	ANTENNA HEIGHT (m)	TABLE ANGLE (Degree)	RAW VALUE (dBuV)	CORRECTION FACTOR (dB/m)
1	*5200.00	117.8 PK			1.03 H	59	77.70	40.10
2	*5200.00	107.4 AV			1.03 H	59	67.30	40.10
3	#10400.00	60.3 PK	74.0	-13.7	1.02 H	35	45.30	15.00
4	#10400.00	47.5 AV	54.0	-6.5	1.02 H	35	32.50	15.00
5	15600.00	69.7 PK	74.0	-4.3	1.01 H	17	54.20	15.50
6	15600.00	51.4 AV	54.0	-2.6	1.01 H	17	35.90	15.50

ANTENNA POLARITY & TEST DISTANCE: VERTICAL AT 3 M

NO.	FREQ. (MHz)	EMISSION LEVEL (dBuV/m)	LIMIT (dBuV/m)	MARGIN (dB)	ANTENNA HEIGHT (m)	TABLE ANGLE (Degree)	RAW VALUE (dBuV)	CORRECTION FACTOR (dB/m)
1	*5200.00	118.8 PK			1.00 V	32	78.70	40.10
2	*5200.00	108.5 AV			1.00 V	32	68.40	40.10
3	#10400.00	62.0 PK	74.0	-12.0	1.02 V	34	47.00	15.00
4	#10400.00	48.2 AV	54.0	-5.8	1.02 V	34	33.20	15.00
5	15600.00	67.5 PK	74.0	-6.5	1.05 V	31	52.00	15.50
6	15600.00	52.6 AV	54.0	-1.4	1.05 V	31	37.10	15.50

REMARKS:

1. Emission Level(dBuV/m) = Raw Value(dBuV) + Correction Factor(dB/m)
2. Correction Factor(dB/m) = Antenna Factor(dB/m) + Cable Factor(dB)
3. The other emission levels were very low against the limit.
4. Margin value = Emission Level – Limit value
5. " * ": Fundamental frequency.
6. " # ": The radiated frequency is out of the restricted band.



CHANNEL	TX Channel 48	DETECTOR FUNCTION	Peak (PK)
FREQUENCY RANGE	1GHz ~ 40GHz		Average (AV)

ANTENNA POLARITY & TEST DISTANCE: HORIZONTAL AT 3 M

NO.	FREQ. (MHz)	EMISSION LEVEL (dBuV/m)	LIMIT (dBuV/m)	MARGIN (dB)	ANTENNA HEIGHT (m)	TABLE ANGLE (Degree)	RAW VALUE (dBuV)	CORRECTION FACTOR (dB/m)
1	*5240.00	117.9 PK			1.02 H	54	77.80	40.10
2	*5240.00	107.7 AV			1.02 H	54	67.60	40.10
3	5350.00	58.7 PK	74.0	-15.3	1.00 H	50	56.70	2.00
4	5350.00	46.3 AV	54.0	-7.7	1.00 H	50	44.30	2.00
5	#10480.00	60.8 PK	74.0	-13.2	1.02 H	34	45.70	15.10
6	#10480.00	47.3 AV	54.0	-6.7	1.02 H	34	32.20	15.10
7	15720.00	64.0 PK	74.0	-10.0	1.07 H	32	49.10	14.90
8	15720.00	49.1 AV	54.0	-4.9	1.07 H	32	34.20	14.90

ANTENNA POLARITY & TEST DISTANCE: VERTICAL AT 3 M

NO.	FREQ. (MHz)	EMISSION LEVEL (dBuV/m)	LIMIT (dBuV/m)	MARGIN (dB)	ANTENNA HEIGHT (m)	TABLE ANGLE (Degree)	RAW VALUE (dBuV)	CORRECTION FACTOR (dB/m)
1	*5240.00	118.9 PK			1.00 V	30	78.80	40.10
2	*5240.00	108.5 AV			1.00 V	30	68.40	40.10
3	5350.00	59.5 PK	74.0	-14.5	1.01 V	9	57.50	2.00
4	5350.00	46.3 AV	54.0	-7.7	1.01 V	9	44.30	2.00
5	#10480.00	61.0 PK	74.0	-13.0	1.55 V	102	45.90	15.10
6	#10480.00	47.6 AV	54.0	-6.4	1.55 V	102	32.50	15.10
7	15720.00	67.6 PK	74.0	-6.4	1.08 V	29	52.70	14.90
8	15720.00	52.4 AV	54.0	-1.6	1.08 V	29	37.50	14.90

REMARKS:

1. Emission Level(dBuV/m) = Raw Value(dBuV) + Correction Factor(dB/m)
2. Correction Factor(dB/m) = Antenna Factor(dB/m) + Cable Factor(dB)
3. The other emission levels were very low against the limit.
4. Margin value = Emission Level – Limit value
5. " * ": Fundamental frequency.
6. " # ": The radiated frequency is out of the restricted band.

802.11ac (VHT40)_2TX

CHANNEL	TX Channel 38	DETECTOR FUNCTION	Peak (PK)
FREQUENCY RANGE	1GHz ~ 40GHz		Average (AV)

ANTENNA POLARITY & TEST DISTANCE: HORIZONTAL AT 3 M

NO.	FREQ. (MHz)	EMISSION LEVEL (dBuV/m)	LIMIT (dBuV/m)	MARGIN (dB)	ANTENNA HEIGHT (m)	TABLE ANGLE (Degree)	RAW VALUE (dBuV)	CORRECTION FACTOR (dB/m)
1	5150.00	68.7 PK	74.0	-5.3	1.24 H	86	66.70	2.00
2	5150.00	52.8 AV	54.0	-1.2	1.24 H	86	50.80	2.00
3	*5190.00	110.3 PK			1.02 H	251	70.30	40.00
4	*5190.00	100.0 AV			1.02 H	251	60.00	40.00
5	#10380.00	60.6 PK	74.0	-13.4	1.25 H	66	45.60	15.00
6	#10380.00	47.4 AV	54.0	-6.6	1.25 H	66	32.40	15.00

ANTENNA POLARITY & TEST DISTANCE: VERTICAL AT 3 M

NO.	FREQ. (MHz)	EMISSION LEVEL (dBuV/m)	LIMIT (dBuV/m)	MARGIN (dB)	ANTENNA HEIGHT (m)	TABLE ANGLE (Degree)	RAW VALUE (dBuV)	CORRECTION FACTOR (dB/m)
1	5150.00	66.5 PK	74.0	-7.5	1.22 V	58	64.50	2.00
2	5150.00	52.0 AV	54.0	-2.0	1.22 V	58	50.00	2.00
3	*5190.00	110.8 PK			1.02 V	355	70.80	40.00
4	*5190.00	101.0 AV			1.02 V	355	61.00	40.00
5	#10380.00	60.3 PK	74.0	-13.7	1.02 V	65	45.30	15.00
6	#10380.00	47.2 AV	54.0	-6.8	1.02 V	65	32.20	15.00

REMARKS:

1. Emission Level(dBuV/m) = Raw Value(dBuV) + Correction Factor(dB/m)
2. Correction Factor(dB/m) = Antenna Factor(dB/m) + Cable Factor(dB)
3. The other emission levels were very low against the limit.
4. Margin value = Emission Level – Limit value
5. " * ": Fundamental frequency.
6. " # ": The radiated frequency is out of the restricted band.

CHANNEL	TX Channel 46	DETECTOR FUNCTION	Peak (PK)
FREQUENCY RANGE	1GHz ~ 40GHz		Average (AV)

ANTENNA POLARITY & TEST DISTANCE: HORIZONTAL AT 3 M

NO.	FREQ. (MHz)	EMISSION LEVEL (dBuV/m)	LIMIT (dBuV/m)	MARGIN (dB)	ANTENNA HEIGHT (m)	TABLE ANGLE (Degree)	RAW VALUE (dBuV)	CORRECTION FACTOR (dB/m)
1	5150.00	70.0 PK	74.0	-4.0	1.21 H	58	68.00	2.00
2	5150.00	52.4 AV	54.0	-1.6	1.21 H	58	50.40	2.00
3	*5230.00	115.1 PK			1.00 H	63	75.00	40.10
4	*5230.00	105.2 AV			1.00 H	63	65.10	40.10
5	5350.00	58.5 PK	74.0	-15.5	1.02 H	351	56.50	2.00
6	5350.00	45.1 AV	54.0	-8.9	1.02 H	351	43.10	2.00
7	#10460.00	60.3 PK	74.0	-13.7	1.02 H	54	45.30	15.00
8	#10460.00	47.2 AV	54.0	-6.8	1.02 H	54	32.20	15.00
9	15690.00	62.2 PK	74.0	-11.8	1.00 H	299	47.20	15.00
10	15690.00	49.2 AV	54.0	-4.8	1.00 H	299	34.20	15.00

ANTENNA POLARITY & TEST DISTANCE: VERTICAL AT 3 M

NO.	FREQ. (MHz)	EMISSION LEVEL (dBuV/m)	LIMIT (dBuV/m)	MARGIN (dB)	ANTENNA HEIGHT (m)	TABLE ANGLE (Degree)	RAW VALUE (dBuV)	CORRECTION FACTOR (dB/m)
1	#5150.00	67.2 PK	74.0	-6.8	1.05 V	24	65.20	2.00
2	#5150.00	52.6 AV	54.0	-1.4	1.05 V	24	50.60	2.00
3	*5230.00	116.1 PK			1.52 V	44	76.00	40.10
4	*5230.00	95.8 AV			1.52 V	44	55.70	40.10
5	#5350.00	59.6 PK	74.0	-14.4	1.22 V	65	57.60	2.00
6	#5350.00	49.5 AV	54.0	-4.5	1.22 V	65	47.50	2.00
7	#10460.00	60.6 PK	74.0	-13.4	1.55 V	99	45.60	15.00
8	#10460.00	47.2 AV	54.0	-6.8	1.55 V	99	32.20	15.00
9	#15690.00	65.5 PK	74.0	-8.5	1.04 V	74	50.50	15.00
10	#15690.00	50.2 AV	54.0	-3.8	1.04 V	74	35.20	15.00

REMARKS:

1. Emission Level(dBuV/m) = Raw Value(dBuV) + Correction Factor(dB/m)
2. Correction Factor(dB/m) = Antenna Factor(dB/m) + Cable Factor(dB)
3. The other emission levels were very low against the limit.
4. Margin value = Emission Level – Limit value
5. " * ": Fundamental frequency.
6. " # ": The radiated frequency is out of the restricted band.

802.11ac (VHT80)_2TX

CHANNEL	TX Channel 42	DETECTOR FUNCTION	Peak (PK)
FREQUENCY RANGE	1GHz ~ 40GHz		Average (AV)

ANTENNA POLARITY & TEST DISTANCE: HORIZONTAL AT 3 M								
NO.	FREQ. (MHz)	EMISSION LEVEL (dBuV/m)	LIMIT (dBuV/m)	MARGIN (dB)	ANTENNA HEIGHT (m)	TABLE ANGLE (Degree)	RAW VALUE (dBuV)	CORRECTION FACTOR (dB/m)
1	5150.00	66.2 PK	74.0	-7.8	1.26 H	53	64.20	2.00
2	5150.00	51.6 AV	54.0	-2.4	1.26 H	53	49.60	2.00
3	*5210.00	104.1 PK			1.02 H	58	64.00	40.10
4	*5210.00	94.3 AV			1.02 H	58	54.20	40.10
5	#10420.00	61.0 PK	74.0	-13.0	1.05 H	34	46.00	15.00
6	#10420.00	47.2 AV	54.0	-6.8	1.05 H	34	32.20	15.00

ANTENNA POLARITY & TEST DISTANCE: VERTICAL AT 3 M								
NO.	FREQ. (MHz)	EMISSION LEVEL (dBuV/m)	LIMIT (dBuV/m)	MARGIN (dB)	ANTENNA HEIGHT (m)	TABLE ANGLE (Degree)	RAW VALUE (dBuV)	CORRECTION FACTOR (dB/m)
1	5150.00	66.8 PK	74.0	-7.2	1.18 V	32	64.80	2.00
2	5150.00	52.6 AV	54.0	-1.4	1.18 V	32	50.60	2.00
3	*5210.00	105.6 PK			1.00 V	31	65.50	40.10
4	*5210.00	95.5 AV			1.00 V	31	55.40	40.10
5	#10420.00	60.2 PK	74.0	-13.8	1.00 V	62	45.20	15.00
6	#10420.00	48.2 AV	54.0	-5.8	1.00 V	62	33.20	15.00

REMARKS:

1. Emission Level(dBuV/m) = Raw Value(dBuV) + Correction Factor(dB/m)
2. Correction Factor(dB/m) = Antenna Factor(dB/m) + Cable Factor(dB)
3. The other emission levels were very low against the limit.
4. Margin value = Emission Level – Limit value
5. " * ": Fundamental frequency.
6. " # ": The radiated frequency is out of the restricted band.

802.11n (HT20)_3TX

CHANNEL	TX Channel 36	DETECTOR FUNCTION	Peak (PK)
FREQUENCY RANGE	1GHz ~ 40GHz		Average (AV)

ANTENNA POLARITY & TEST DISTANCE: HORIZONTAL AT 3 M

NO.	FREQ. (MHz)	EMISSION LEVEL (dBuV/m)	LIMIT (dBuV/m)	MARGIN (dB)	ANTENNA HEIGHT (m)	TABLE ANGLE (Degree)	RAW VALUE (dBuV)	CORRECTION FACTOR (dB/m)
1	5150.00	65.7 PK	74.0	-8.3	1.30 H	301	63.70	2.00
2	5150.00	51.3 AV	54.0	-2.7	1.30 H	301	49.30	2.00
3	*5180.00	115.5 PK			1.03 H	62	75.50	40.00
4	*5180.00	105.7 AV			1.03 H	62	65.70	40.00
5	#10360.00	61.0 PK	74.0	-13.0	1.05 H	35	46.00	15.00
6	#10360.00	47.5 AV	54.0	-6.5	1.05 H	35	32.50	15.00

ANTENNA POLARITY & TEST DISTANCE: VERTICAL AT 3 M

NO.	FREQ. (MHz)	EMISSION LEVEL (dBuV/m)	LIMIT (dBuV/m)	MARGIN (dB)	ANTENNA HEIGHT (m)	TABLE ANGLE (Degree)	RAW VALUE (dBuV)	CORRECTION FACTOR (dB/m)
1	5150.00	67.3 PK	74.0	-6.7	1.02 V	42	65.30	2.00
2	5150.00	52.9 AV	54.0	-1.1	1.02 V	42	50.90	2.00
3	*5180.00	118.0 PK			1.03 V	37	78.00	40.00
4	*5180.00	107.2 AV			1.03 V	37	67.20	40.00
5	#10360.00	61.5 PK	74.0	-12.5	1.52 V	66	46.50	15.00
6	#10360.00	48.5 AV	54.0	-5.5	1.52 V	66	33.50	15.00

REMARKS:

1. Emission Level(dBuV/m) = Raw Value(dBuV) + Correction Factor(dB/m)
2. Correction Factor(dB/m) = Antenna Factor(dB/m) + Cable Factor(dB)
3. The other emission levels were very low against the limit.
4. Margin value = Emission Level – Limit value
5. " * ": Fundamental frequency.
6. " # ": The radiated frequency is out of the restricted band.

CHANNEL	TX Channel 40	DETECTOR FUNCTION	Peak (PK)
FREQUENCY RANGE	1GHz ~ 40GHz		Average (AV)

ANTENNA POLARITY & TEST DISTANCE: HORIZONTAL AT 3 M

NO.	FREQ. (MHz)	EMISSION LEVEL (dBuV/m)	LIMIT (dBuV/m)	MARGIN (dB)	ANTENNA HEIGHT (m)	TABLE ANGLE (Degree)	RAW VALUE (dBuV)	CORRECTION FACTOR (dB/m)
1	*5200.00	117.2 PK			1.02 H	64	77.10	40.10
2	*5200.00	107.0 AV			1.02 H	64	66.90	40.10
3	#10400.00	60.7 PK	74.0	-13.3	1.02 H	59	45.70	15.00
4	#10400.00	47.5 AV	54.0	-6.5	1.02 H	59	32.50	15.00
5	15600.00	65.3 PK	74.0	-8.7	1.00 H	37	49.80	15.50
6	15600.00	50.9 AV	54.0	-3.1	1.00 H	37	35.40	15.50

ANTENNA POLARITY & TEST DISTANCE: VERTICAL AT 3 M

NO.	FREQ. (MHz)	EMISSION LEVEL (dBuV/m)	LIMIT (dBuV/m)	MARGIN (dB)	ANTENNA HEIGHT (m)	TABLE ANGLE (Degree)	RAW VALUE (dBuV)	CORRECTION FACTOR (dB/m)
1	*5200.00	118.4 PK			1.02 V	38	78.30	40.10
2	*5200.00	108.6 AV			1.02 V	38	68.50	40.10
3	#10400.00	60.4 PK	74.0	-13.6	1.03 V	4	45.40	15.00
4	#10400.00	47.6 AV	54.0	-6.4	1.03 V	4	32.60	15.00
5	15600.00	67.2 PK	74.0	-6.8	1.01 V	2	51.70	15.50
6	15600.00	53.0 AV	54.0	-1.0	1.01 V	2	37.50	15.50

REMARKS:

1. Emission Level(dBuV/m) = Raw Value(dBuV) + Correction Factor(dB/m)
2. Correction Factor(dB/m) = Antenna Factor(dB/m) + Cable Factor(dB)
3. The other emission levels were very low against the limit.
4. Margin value = Emission Level – Limit value
5. " * ": Fundamental frequency.
6. " # ": The radiated frequency is out of the restricted band.

CHANNEL	TX Channel 48	DETECTOR FUNCTION	Peak (PK)
FREQUENCY RANGE	1GHz ~ 40GHz		Average (AV)

ANTENNA POLARITY & TEST DISTANCE: HORIZONTAL AT 3 M

NO.	FREQ. (MHz)	EMISSION LEVEL (dBuV/m)	LIMIT (dBuV/m)	MARGIN (dB)	ANTENNA HEIGHT (m)	TABLE ANGLE (Degree)	RAW VALUE (dBuV)	CORRECTION FACTOR (dB/m)
1	*5240.00	119.5 PK			1.03 H	60	79.40	40.10
2	*5240.00	109.3 AV			1.03 H	60	69.20	40.10
3	5350.00	57.0 PK	74.0	-17.0	1.05 H	94	55.00	2.00
4	5350.00	45.6 AV	54.0	-8.4	1.05 H	94	43.60	2.00
5	#10480.00	61.0 PK	74.0	-13.0	1.41 H	58	45.90	15.10
6	#10480.00	47.3 AV	54.0	-6.7	1.41 H	58	32.20	15.10
7	15720.00	67.4 PK	74.0	-6.6	1.03 H	36	52.50	14.90
8	15720.00	51.4 AV	54.0	-2.6	1.03 H	36	36.50	14.90

ANTENNA POLARITY & TEST DISTANCE: VERTICAL AT 3 M

NO.	FREQ. (MHz)	EMISSION LEVEL (dBuV/m)	LIMIT (dBuV/m)	MARGIN (dB)	ANTENNA HEIGHT (m)	TABLE ANGLE (Degree)	RAW VALUE (dBuV)	CORRECTION FACTOR (dB/m)
1	*5240.00	119.9 PK			1.00 V	39	79.80	40.10
2	*5240.00	109.6 AV			1.00 V	39	69.50	40.10
3	5350.00	57.8 PK	74.0	-16.2	1.02 V	65	55.80	2.00
4	5350.00	47.2 AV	54.0	-6.8	1.02 V	65	45.20	2.00
5	#10480.00	61.1 PK	74.0	-12.9	1.05 V	34	46.00	15.10
6	#10480.00	47.6 AV	54.0	-6.4	1.05 V	34	32.50	15.10
7	15720.00	69.5 PK	74.0	-4.5	1.08 V	29	54.60	14.90
8	15720.00	52.4 AV	54.0	-1.6	1.08 V	29	37.50	14.90

REMARKS:

1. Emission Level(dBuV/m) = Raw Value(dBuV) + Correction Factor(dB/m)
2. Correction Factor(dB/m) = Antenna Factor(dB/m) + Cable Factor(dB)
3. The other emission levels were very low against the limit.
4. Margin value = Emission Level – Limit value
5. " * ": Fundamental frequency.
6. " # ": The radiated frequency is out of the restricted band.

802.11n (HT40)_3TX

CHANNEL	TX Channel 38	DETECTOR FUNCTION	Peak (PK)
FREQUENCY RANGE	1GHz ~ 40GHz		Average (AV)

ANTENNA POLARITY & TEST DISTANCE: HORIZONTAL AT 3 M

NO.	FREQ. (MHz)	EMISSION LEVEL (dBuV/m)	LIMIT (dBuV/m)	MARGIN (dB)	ANTENNA HEIGHT (m)	TABLE ANGLE (Degree)	RAW VALUE (dBuV)	CORRECTION FACTOR (dB/m)
1	5150.00	63.7 PK	74.0	-10.3	1.32 H	307	61.70	2.00
2	5150.00	51.1 AV	54.0	-2.9	1.32 H	307	49.10	2.00
3	*5190.00	110.5 PK			1.13 H	72	70.50	40.00
4	*5190.00	100.5 AV			1.13 H	72	60.50	40.00
5	#10380.00	59.5 PK	74.0	-14.5	1.00 H	184	44.50	15.00
6	#10380.00	47.0 AV	54.0	-7.0	1.00 H	184	32.00	15.00

ANTENNA POLARITY & TEST DISTANCE: VERTICAL AT 3 M

NO.	FREQ. (MHz)	EMISSION LEVEL (dBuV/m)	LIMIT (dBuV/m)	MARGIN (dB)	ANTENNA HEIGHT (m)	TABLE ANGLE (Degree)	RAW VALUE (dBuV)	CORRECTION FACTOR (dB/m)
1	5150.00	66.7 PK	74.0	-7.3	1.16 V	26	64.70	2.00
2	5150.00	53.0 AV	54.0	-1.0	1.16 V	26	51.00	2.00
3	*5190.00	111.2 PK			1.01 V	37	71.20	40.00
4	*5190.00	100.9 AV			1.01 V	37	60.90	40.00
5	#10380.00	59.8 PK	74.0	-14.2	1.00 V	269	44.80	15.00
6	#10380.00	46.9 AV	54.0	-7.1	1.00 V	269	31.90	15.00

REMARKS:

1. Emission Level(dBuV/m) = Raw Value(dBuV) + Correction Factor(dB/m)
2. Correction Factor(dB/m) = Antenna Factor(dB/m) + Cable Factor(dB)
3. The other emission levels were very low against the limit.
4. Margin value = Emission Level – Limit value
5. " * ": Fundamental frequency.
6. " # ": The radiated frequency is out of the restricted band.

CHANNEL	TX Channel 46	DETECTOR FUNCTION	Peak (PK)
FREQUENCY RANGE	1GHz ~ 40GHz		Average (AV)

ANTENNA POLARITY & TEST DISTANCE: HORIZONTAL AT 3 M

NO.	FREQ. (MHz)	EMISSION LEVEL (dBuV/m)	LIMIT (dBuV/m)	MARGIN (dB)	ANTENNA HEIGHT (m)	TABLE ANGLE (Degree)	RAW VALUE (dBuV)	CORRECTION FACTOR (dB/m)
1	5150.00	64.6 PK	74.0	-9.4	1.22 H	302	62.60	2.00
2	5150.00	50.2 AV	54.0	-3.8	1.22 H	302	48.20	2.00
3	*5230.00	115.9 PK			1.36 H	67	75.80	40.10
4	*5230.00	105.6 AV			1.36 H	67	65.50	40.10
5	5350.00	58.4 PK	74.0	-15.6	1.00 H	292	56.40	2.00
6	5350.00	45.2 AV	54.0	-8.8	1.00 H	292	43.20	2.00
7	#10460.00	60.2 PK	74.0	-13.8	1.00 H	63	45.20	15.00
8	#10460.00	46.8 AV	54.0	-7.2	1.00 H	63	31.80	15.00
9	15690.00	65.1 PK	74.0	-8.9	1.08 H	32	50.10	15.00
10	15690.00	51.1 AV	54.0	-2.9	1.08 H	32	36.10	15.00

ANTENNA POLARITY & TEST DISTANCE: VERTICAL AT 3 M

NO.	FREQ. (MHz)	EMISSION LEVEL (dBuV/m)	LIMIT (dBuV/m)	MARGIN (dB)	ANTENNA HEIGHT (m)	TABLE ANGLE (Degree)	RAW VALUE (dBuV)	CORRECTION FACTOR (dB/m)
1	5150.00	65.6 PK	74.0	-8.4	1.29 V	17	63.60	2.00
2	5150.00	52.8 AV	54.0	-1.2	1.29 V	17	50.80	2.00
3	*5230.00	116.8 PK			1.00 V	31	76.70	40.10
4	*5230.00	106.6 AV			1.00 V	31	66.50	40.10
5	5350.00	58.8 PK	74.0	-15.2	1.36 V	3	56.80	2.00
6	5350.00	45.9 AV	54.0	-8.1	1.36 V	3	43.90	2.00
7	#10460.00	60.4 PK	74.0	-13.6	1.00 V	257	45.40	15.00
8	#10460.00	47.2 AV	54.0	-6.8	1.00 V	257	32.20	15.00
9	15690.00	66.2 PK	74.0	-7.8	1.05 V	26	51.20	15.00
10	15690.00	50.9 AV	54.0	-3.1	1.05 V	26	35.90	15.00

REMARKS:

1. Emission Level(dBuV/m) = Raw Value(dBuV) + Correction Factor(dB/m)
2. Correction Factor(dB/m) = Antenna Factor(dB/m) + Cable Factor(dB)
3. The other emission levels were very low against the limit.
4. Margin value = Emission Level – Limit value
5. " * ": Fundamental frequency.
6. " # ": The radiated frequency is out of the restricted band.

802.11ac (VHT20)_3TX

CHANNEL	TX Channel 36	DETECTOR FUNCTION	Peak (PK)
FREQUENCY RANGE	1GHz ~ 40GHz		Average (AV)

ANTENNA POLARITY & TEST DISTANCE: HORIZONTAL AT 3 M

NO.	FREQ. (MHz)	EMISSION LEVEL (dBuV/m)	LIMIT (dBuV/m)	MARGIN (dB)	ANTENNA HEIGHT (m)	TABLE ANGLE (Degree)	RAW VALUE (dBuV)	CORRECTION FACTOR (dB/m)
1	5150.00	65.5 PK	74.0	-8.5	1.31 H	302	63.50	2.00
2	5150.00	51.3 AV	54.0	-2.7	1.31 H	302	49.30	2.00
3	*5180.00	115.3 PK			1.05 H	84	75.30	40.00
4	*5180.00	105.5 AV			1.05 H	84	65.50	40.00
5	#10360.00	60.9 PK	74.0	-13.1	1.52 H	22	45.90	15.00
6	#10360.00	47.2 AV	54.0	-6.8	1.52 H	22	32.20	15.00

ANTENNA POLARITY & TEST DISTANCE: VERTICAL AT 3 M

NO.	FREQ. (MHz)	EMISSION LEVEL (dBuV/m)	LIMIT (dBuV/m)	MARGIN (dB)	ANTENNA HEIGHT (m)	TABLE ANGLE (Degree)	RAW VALUE (dBuV)	CORRECTION FACTOR (dB/m)
1	5150.00	67.2 PK	74.0	-6.8	1.02 V	43	65.20	2.00
2	5150.00	52.0 AV	54.0	-2.0	1.02 V	43	50.00	2.00
3	*5180.00	117.8 PK			1.00 V	35	77.80	40.00
4	*5180.00	107.0 AV			1.00 V	35	67.00	40.00
5	#10360.00	61.0 PK	74.0	-13.0	1.52 V	99	46.00	15.00
6	#10360.00	48.2 AV	54.0	-5.8	1.52 V	99	33.20	15.00

REMARKS:

1. Emission Level(dBuV/m) = Raw Value(dBuV) + Correction Factor(dB/m)
2. Correction Factor(dB/m) = Antenna Factor(dB/m) + Cable Factor(dB)
3. The other emission levels were very low against the limit.
4. Margin value = Emission Level – Limit value
5. " * ": Fundamental frequency.
6. " # ": The radiated frequency is out of the restricted band.

CHANNEL	TX Channel 40	DETECTOR FUNCTION	Peak (PK)
FREQUENCY RANGE	1GHz ~ 40GHz		Average (AV)

ANTENNA POLARITY & TEST DISTANCE: HORIZONTAL AT 3 M

NO.	FREQ. (MHz)	EMISSION LEVEL (dBuV/m)	LIMIT (dBuV/m)	MARGIN (dB)	ANTENNA HEIGHT (m)	TABLE ANGLE (Degree)	RAW VALUE (dBuV)	CORRECTION FACTOR (dB/m)
1	*5200.00	117.1 PK			1.52 H	96	77.00	40.10
2	*5200.00	106.8 AV			1.52 H	96	66.70	40.10
3	#10400.00	58.6 PK	74.0	-15.4	1.51 H	221	43.60	15.00
4	#10400.00	47.2 AV	54.0	-6.8	1.51 H	221	32.20	15.00
5	15600.00	65.0 PK	74.0	-9.0	1.52 H	354	49.50	15.50
6	15600.00	50.6 AV	54.0	-3.4	1.52 H	354	35.10	15.50

ANTENNA POLARITY & TEST DISTANCE: VERTICAL AT 3 M

NO.	FREQ. (MHz)	EMISSION LEVEL (dBuV/m)	LIMIT (dBuV/m)	MARGIN (dB)	ANTENNA HEIGHT (m)	TABLE ANGLE (Degree)	RAW VALUE (dBuV)	CORRECTION FACTOR (dB/m)
1	*5200.00	118.2 PK			1.00 V	55	78.10	40.10
2	*5200.00	105.4 AV			1.00 V	55	65.30	40.10
3	#10400.00	60.9 PK	74.0	-13.1	1.05 V	95	45.90	15.00
4	#10400.00	47.5 AV	54.0	-6.5	1.05 V	95	32.50	15.00
5	15600.00	67.4 PK	74.0	-6.6	1.52 V	78	51.90	15.50
6	15600.00	52.1 AV	54.0	-1.9	1.52 V	78	36.60	15.50

REMARKS:

1. Emission Level(dBuV/m) = Raw Value(dBuV) + Correction Factor(dB/m)
2. Correction Factor(dB/m) = Antenna Factor(dB/m) + Cable Factor(dB)
3. The other emission levels were very low against the limit.
4. Margin value = Emission Level – Limit value
5. " * ": Fundamental frequency.
6. " # ": The radiated frequency is out of the restricted band.

CHANNEL	TX Channel 48	DETECTOR FUNCTION	Peak (PK)
FREQUENCY RANGE	1GHz ~ 40GHz		Average (AV)

ANTENNA POLARITY & TEST DISTANCE: HORIZONTAL AT 3 M

NO.	FREQ. (MHz)	EMISSION LEVEL (dBuV/m)	LIMIT (dBuV/m)	MARGIN (dB)	ANTENNA HEIGHT (m)	TABLE ANGLE (Degree)	RAW VALUE (dBuV)	CORRECTION FACTOR (dB/m)
1	*5240.00	119.1 PK			1.05 H	225	79.00	40.10
2	*5240.00	109.2 AV			1.05 H	225	69.10	40.10
3	5350.00	58.6 PK	74.0	-15.4	1.52 H	88	56.60	2.00
4	5350.00	45.5 AV	54.0	-8.5	1.52 H	88	43.50	2.00
5	#10480.00	60.8 PK	74.0	-13.2	1.00 H	335	45.70	15.10
6	#10480.00	47.4 AV	54.0	-6.6	1.00 H	335	32.30	15.10
7	15720.00	67.3 PK	74.0	-6.7	1.02 H	24	52.40	14.90
8	15720.00	51.2 AV	54.0	-2.8	1.02 H	24	36.30	14.90

ANTENNA POLARITY & TEST DISTANCE: VERTICAL AT 3 M

NO.	FREQ. (MHz)	EMISSION LEVEL (dBuV/m)	LIMIT (dBuV/m)	MARGIN (dB)	ANTENNA HEIGHT (m)	TABLE ANGLE (Degree)	RAW VALUE (dBuV)	CORRECTION FACTOR (dB/m)
1	*5240.00	119.8 PK			1.05 V	74	79.70	40.10
2	*5240.00	105.4 AV			1.05 V	74	65.30	40.10
3	5350.00	57.1 PK	74.0	-16.9	1.52 V	221	55.10	2.00
4	5350.00	47.1 AV	54.0	-6.9	1.52 V	221	45.10	2.00
5	#10480.00	60.4 PK	74.0	-13.6	1.54 V	99	45.30	15.10
6	#10480.00	47.4 AV	54.0	-6.6	1.54 V	99	32.30	15.10
7	15720.00	69.2 PK	74.0	-4.8	1.84 V	69	54.30	14.90
8	15720.00	52.3 AV	54.0	-1.7	1.84 V	69	37.40	14.90

REMARKS:

1. Emission Level(dBuV/m) = Raw Value(dBuV) + Correction Factor(dB/m)
2. Correction Factor(dB/m) = Antenna Factor(dB/m) + Cable Factor(dB)
3. The other emission levels were very low against the limit.
4. Margin value = Emission Level – Limit value
5. " * ": Fundamental frequency.
6. " # ": The radiated frequency is out of the restricted band.

802.11ac (VHT40)_3TX

CHANNEL	TX Channel 38	DETECTOR FUNCTION	Peak (PK)
FREQUENCY RANGE	1GHz ~ 40GHz		Average (AV)

ANTENNA POLARITY & TEST DISTANCE: HORIZONTAL AT 3 M

NO.	FREQ. (MHz)	EMISSION LEVEL (dBuV/m)	LIMIT (dBuV/m)	MARGIN (dB)	ANTENNA HEIGHT (m)	TABLE ANGLE (Degree)	RAW VALUE (dBuV)	CORRECTION FACTOR (dB/m)
1	5150.00	65.1 PK	74.0	-8.9	1.31 H	307	63.10	2.00
2	5150.00	51.6 AV	54.0	-2.4	1.31 H	307	49.60	2.00
3	*5190.00	110.4 PK			1.13 H	73	70.40	40.00
4	*5190.00	100.3 AV			1.13 H	73	60.30	40.00
5	#10380.00	59.6 PK	74.0	-14.4	1.00 H	179	44.60	15.00
6	#10380.00	47.1 AV	54.0	-6.9	1.00 H	179	32.10	15.00

ANTENNA POLARITY & TEST DISTANCE: VERTICAL AT 3 M

NO.	FREQ. (MHz)	EMISSION LEVEL (dBuV/m)	LIMIT (dBuV/m)	MARGIN (dB)	ANTENNA HEIGHT (m)	TABLE ANGLE (Degree)	RAW VALUE (dBuV)	CORRECTION FACTOR (dB/m)
1	5150.00	66.6 PK	74.0	-7.4	1.15 V	28	64.60	2.00
2	5150.00	52.9 AV	54.0	-1.1	1.15 V	28	50.90	2.00
3	*5190.00	104.5 PK			1.15 V	27	64.50	40.00
4	*5190.00	92.8 AV			1.15 V	27	52.80	40.00
5	#10380.00	59.9 PK	74.0	-14.1	1.00 V	259	44.90	15.00
6	#10380.00	47.0 AV	54.0	-7.0	1.00 V	259	32.00	15.00

REMARKS:

1. Emission Level(dBuV/m) = Raw Value(dBuV) + Correction Factor(dB/m)
2. Correction Factor(dB/m) = Antenna Factor(dB/m) + Cable Factor(dB)
3. The other emission levels were very low against the limit.
4. Margin value = Emission Level – Limit value
5. " * ": Fundamental frequency.
6. " # ": The radiated frequency is out of the restricted band.

CHANNEL	TX Channel 46	DETECTOR FUNCTION	Peak (PK)
FREQUENCY RANGE	1GHz ~ 40GHz		Average (AV)

ANTENNA POLARITY & TEST DISTANCE: HORIZONTAL AT 3 M

NO.	FREQ. (MHz)	EMISSION LEVEL (dBuV/m)	LIMIT (dBuV/m)	MARGIN (dB)	ANTENNA HEIGHT (m)	TABLE ANGLE (Degree)	RAW VALUE (dBuV)	CORRECTION FACTOR (dB/m)
1	5150.00	64.5 PK	74.0	-9.5	1.21 H	312	62.50	2.00
2	5150.00	50.1 AV	54.0	-3.9	1.21 H	312	48.10	2.00
3	*5230.00	115.7 PK			1.35 H	66	75.60	40.10
4	*5230.00	105.4 AV			1.35 H	66	65.30	40.10
5	5350.00	58.5 PK	74.0	-15.5	1.00 H	296	56.50	2.00
6	5350.00	45.3 AV	54.0	-8.7	1.00 H	296	43.30	2.00
7	#10460.00	60.6 PK	74.0	-13.4	1.00 H	66	45.60	15.00
8	#10460.00	47.1 AV	54.0	-6.9	1.00 H	66	32.10	15.00
9	15690.00	65.2 PK	74.0	-8.8	1.07 H	33	50.20	15.00
10	15690.00	51.3 AV	54.0	-2.7	1.07 H	33	36.30	15.00

ANTENNA POLARITY & TEST DISTANCE: VERTICAL AT 3 M

NO.	FREQ. (MHz)	EMISSION LEVEL (dBuV/m)	LIMIT (dBuV/m)	MARGIN (dB)	ANTENNA HEIGHT (m)	TABLE ANGLE (Degree)	RAW VALUE (dBuV)	CORRECTION FACTOR (dB/m)
1	5150.00	66.4 PK	74.0	-7.6	1.30 V	19	64.40	2.00
2	5150.00	52.7 AV	54.0	-1.3	1.30 V	19	50.70	2.00
3	*5230.00	116.5 PK			1.00 V	33	76.40	40.10
4	*5230.00	106.3 AV			1.00 V	33	66.20	40.10
5	5350.00	58.7 PK	74.0	-15.3	1.33 V	10	56.70	2.00
6	5350.00	46.1 AV	54.0	-7.9	1.33 V	10	44.10	2.00
7	#10460.00	60.5 PK	74.0	-13.5	1.00 V	259	45.50	15.00
8	#10460.00	47.4 AV	54.0	-6.6	1.00 V	259	32.40	15.00
9	15690.00	66.3 PK	74.0	-7.7	1.03 V	27	51.30	15.00
10	15690.00	50.8 AV	54.0	-3.2	1.03 V	27	35.80	15.00

REMARKS:

1. Emission Level(dBuV/m) = Raw Value(dBuV) + Correction Factor(dB/m)
2. Correction Factor(dB/m) = Antenna Factor(dB/m) + Cable Factor(dB)
3. The other emission levels were very low against the limit.
4. Margin value = Emission Level – Limit value
5. " * ": Fundamental frequency.
6. " # ": The radiated frequency is out of the restricted band.

802.11ac (VHT80)_3TX

CHANNEL	TX Channel 42	DETECTOR FUNCTION	Peak (PK)
FREQUENCY RANGE	1GHz ~ 40GHz		Average (AV)

ANTENNA POLARITY & TEST DISTANCE: HORIZONTAL AT 3 M

NO.	FREQ. (MHz)	EMISSION LEVEL (dBuV/m)	LIMIT (dBuV/m)	MARGIN (dB)	ANTENNA HEIGHT (m)	TABLE ANGLE (Degree)	RAW VALUE (dBuV)	CORRECTION FACTOR (dB/m)
1	5150.00	64.4 PK	74.0	-9.6	1.23 H	300	62.40	2.00
2	5150.00	49.9 AV	54.0	-4.1	1.23 H	300	47.90	2.00
3	*5210.00	105.0 PK			1.38 H	63	64.90	40.10
4	*5210.00	94.9 AV			1.38 H	63	54.80	40.10
5	#10420.00	59.8 PK	74.0	-14.2	1.03 H	36	44.80	15.00
6	#10420.00	46.6 AV	54.0	-7.4	1.03 H	36	31.60	15.00

ANTENNA POLARITY & TEST DISTANCE: VERTICAL AT 3 M

NO.	FREQ. (MHz)	EMISSION LEVEL (dBuV/m)	LIMIT (dBuV/m)	MARGIN (dB)	ANTENNA HEIGHT (m)	TABLE ANGLE (Degree)	RAW VALUE (dBuV)	CORRECTION FACTOR (dB/m)
1	5150.00	67.0 PK	74.0	-7.0	1.28 V	16	65.00	2.00
2	5150.00	52.4 AV	54.0	-1.6	1.28 V	16	50.40	2.00
3	*5210.00	105.3 PK			1.00 V	31	65.20	40.10
4	*5210.00	95.8 AV			1.00 V	31	55.70	40.10
5	#10420.00	59.2 PK	74.0	-14.8	1.12 V	110	44.20	15.00
6	#10420.00	45.6 AV	54.0	-8.4	1.12 V	110	30.60	15.00

REMARKS:

1. Emission Level(dBuV/m) = Raw Value(dBuV) + Correction Factor(dB/m)
2. Correction Factor(dB/m) = Antenna Factor(dB/m) + Cable Factor(dB)
3. The other emission levels were very low against the limit.
4. Margin value = Emission Level – Limit value
5. " * ": Fundamental frequency.
6. " # ": The radiated frequency is out of the restricted band.

802.11a_1TX

CHANNEL	TX Channel 149	DETECTOR FUNCTION	Peak (PK)
FREQUENCY RANGE	1GHz ~ 40GHz		Average (AV)

ANTENNA POLARITY & TEST DISTANCE: HORIZONTAL AT 3 M

NO.	FREQ. (MHz)	EMISSION LEVEL (dBuV/m)	LIMIT (dBuV/m)	MARGIN (dB)	ANTENNA HEIGHT (m)	TABLE ANGLE (Degree)	RAW VALUE (dBuV)	CORRECTION FACTOR (dB/m)
1	3830.00	45.8 PK	74.0	-28.2	1.00 H	13	46.50	-0.70
2	3830.00	36.8 AV	54.0	-17.2	1.00 H	13	37.50	-0.70
3	#5714.90	61.9 PK	74.0	-12.1	1.00 H	89	59.30	2.60
4	#5714.90	46.5 AV	54.0	-7.5	1.00 H	89	43.90	2.60
5	#5722.90	65.2 PK	78.2	-13.0	1.00 H	86	62.60	2.60
6	#5725.00	52.9 PK	78.2	-25.3	1.00 H	78	50.30	2.60
7	*5745.00	108.9 PK			1.00 H	78	67.90	41.00
8	*5745.00	98.3 AV			1.00 H	78	57.30	41.00
9	11490.00	64.1 PK	74.0	-9.9	1.00 H	353	48.20	15.90
10	11490.00	50.8 AV	54.0	-3.2	1.00 H	353	34.90	15.90

ANTENNA POLARITY & TEST DISTANCE: VERTICAL AT 3 M

NO.	FREQ. (MHz)	EMISSION LEVEL (dBuV/m)	LIMIT (dBuV/m)	MARGIN (dB)	ANTENNA HEIGHT (m)	TABLE ANGLE (Degree)	RAW VALUE (dBuV)	CORRECTION FACTOR (dB/m)
1	3830.00	46.3 PK	74.0	-27.7	1.00 V	76	47.00	-0.70
2	3830.00	37.1 AV	54.0	-16.9	1.00 V	76	37.80	-0.70
3	#5714.90	61.1 PK	74.0	-12.9	1.00 V	92	58.50	2.60
4	#5714.90	46.3 AV	54.0	-7.7	1.00 V	92	43.70	2.60
5	#5722.90	67.0 PK	78.2	-11.2	1.00 V	90	64.40	2.60
6	#5725.00	52.2 PK	78.2	-26.0	1.00 V	89	49.60	2.60
7	*5745.00	109.2 PK			1.00 V	89	68.20	41.00
8	*5745.00	99.0 AV			1.00 V	89	58.00	41.00
9	11490.00	67.5 PK	74.0	-6.5	1.01 V	88	51.60	15.90
10	11490.00	52.8 AV	54.0	-1.2	1.01 V	88	36.90	15.90

REMARKS:

1. Emission Level(dBuV/m) = Raw Value(dBuV) + Correction Factor(dB/m)
2. Correction Factor(dB/m) = Antenna Factor(dB/m) + Cable Factor(dB)
3. The other emission levels were very low against the limit.
4. Margin value = Emission Level – Limit value
5. " * ": Fundamental frequency.
6. " # ": The radiated frequency is out of the restricted band.

CHANNEL	TX Channel 157	DETECTOR FUNCTION	Peak (PK)
FREQUENCY RANGE	1GHz ~ 40GHz		Average (AV)

ANTENNA POLARITY & TEST DISTANCE: HORIZONTAL AT 3 M

NO.	FREQ. (MHz)	EMISSION LEVEL (dBuV/m)	LIMIT (dBuV/m)	MARGIN (dB)	ANTENNA HEIGHT (m)	TABLE ANGLE (Degree)	RAW VALUE (dBuV)	CORRECTION FACTOR (dB/m)
1	3856.00	46.4 PK	74.0	-27.6	1.00 H	13	47.00	-0.60
2	3856.00	38.3 AV	54.0	-15.7	1.00 H	13	38.90	-0.60
3	*5785.00	110.5 PK			1.00 H	81	69.40	41.10
4	*5785.00	100.2 AV			1.00 H	81	59.10	41.10
5	11570.00	64.3 PK	74.0	-9.7	1.00 H	316	48.70	15.60
6	11570.00	51.2 AV	54.0	-2.8	1.00 H	316	35.60	15.60

ANTENNA POLARITY & TEST DISTANCE: VERTICAL AT 3 M

NO.	FREQ. (MHz)	EMISSION LEVEL (dBuV/m)	LIMIT (dBuV/m)	MARGIN (dB)	ANTENNA HEIGHT (m)	TABLE ANGLE (Degree)	RAW VALUE (dBuV)	CORRECTION FACTOR (dB/m)
1	3856.00	47.1 PK	74.0	-26.9	1.00 V	75	47.70	-0.60
2	3856.00	39.5 AV	54.0	-14.5	1.00 V	75	40.10	-0.60
3	*5785.00	110.6 PK			1.00 V	89	69.50	41.10
4	*5785.00	100.4 AV			1.00 V	89	59.30	41.10
5	11570.00	67.6 PK	74.0	-6.4	1.00 V	45	52.00	15.60
6	11570.00	52.9 AV	54.0	-1.1	1.00 V	45	37.30	15.60

REMARKS:

1. Emission Level(dBuV/m) = Raw Value(dBuV) + Correction Factor(dB/m)
2. Correction Factor(dB/m) = Antenna Factor(dB/m) + Cable Factor(dB)
3. The other emission levels were very low against the limit.
4. Margin value = Emission Level – Limit value
5. " * ": Fundamental frequency.

CHANNEL	TX Channel 165	DETECTOR FUNCTION	Peak (PK)
FREQUENCY RANGE	1GHz ~ 40GHz		Average (AV)

ANTENNA POLARITY & TEST DISTANCE: HORIZONTAL AT 3 M

NO.	FREQ. (MHz)	EMISSION LEVEL (dBuV/m)	LIMIT (dBuV/m)	MARGIN (dB)	ANTENNA HEIGHT (m)	TABLE ANGLE (Degree)	RAW VALUE (dBuV)	CORRECTION FACTOR (dB/m)
1	3883.00	46.0 PK	74.0	-28.0	1.00 H	10	46.70	-0.70
2	3883.00	38.0 AV	54.0	-16.0	1.00 H	10	38.70	-0.70
3	*5825.00	107.1 PK			1.00 H	80	66.00	41.10
4	*5825.00	97.2 AV			1.00 H	80	56.10	41.10
5	#5850.00	51.0 PK	78.2	-27.2	1.00 H	80	48.00	3.00
6	#5852.10	62.9 PK	78.2	-15.3	1.00 H	81	59.90	3.00
7	#5860.10	58.4 PK	74.0	-15.6	1.00 H	82	55.40	3.00
8	#5860.10	45.0 AV	54.0	-9.0	1.00 H	82	42.00	3.00
9	11650.00	63.4 PK	74.0	-10.6	1.00 H	316	47.80	15.60
10	11650.00	50.2 AV	54.0	-3.8	1.00 H	316	34.60	15.60

ANTENNA POLARITY & TEST DISTANCE: VERTICAL AT 3 M

NO.	FREQ. (MHz)	EMISSION LEVEL (dBuV/m)	LIMIT (dBuV/m)	MARGIN (dB)	ANTENNA HEIGHT (m)	TABLE ANGLE (Degree)	RAW VALUE (dBuV)	CORRECTION FACTOR (dB/m)
1	3883.00	46.5 PK	74.0	-27.5	1.00 V	73	47.20	-0.70
2	3883.00	40.0 AV	54.0	-14.0	1.00 V	73	40.70	-0.70
3	*5825.00	107.9 PK			1.00 V	88	66.80	41.10
4	*5825.00	97.2 AV			1.00 V	88	56.10	41.10
5	#5850.00	49.6 PK	78.2	-28.6	1.00 V	85	46.60	3.00
6	#5852.10	64.3 PK	78.2	-13.9	1.00 V	84	61.30	3.00
7	#5860.10	58.0 PK	74.0	-16.0	1.00 V	88	55.00	3.00
8	#5860.10	45.0 AV	54.0	-9.0	1.00 V	88	42.00	3.00
9	11650.00	69.1 PK	74.0	-4.9	1.47 V	40	53.50	15.60
10	11650.00	53.0 AV	54.0	-1.0	1.47 V	40	37.40	15.60

REMARKS:

1. Emission Level(dBuV/m) = Raw Value(dBuV) + Correction Factor(dB/m)
2. Correction Factor(dB/m) = Antenna Factor(dB/m) + Cable Factor(dB)
3. The other emission levels were very low against the limit.
4. Margin value = Emission Level – Limit value
5. " * ": Fundamental frequency.
6. " # ": The radiated frequency is out of the restricted band.

802.11n (HT20)_2TX

CHANNEL	TX Channel 149	DETECTOR FUNCTION	Peak (PK)
FREQUENCY RANGE	1GHz ~ 40GHz		Average (AV)

ANTENNA POLARITY & TEST DISTANCE: HORIZONTAL AT 3 M

NO.	FREQ. (MHz)	EMISSION LEVEL (dBuV/m)	LIMIT (dBuV/m)	MARGIN (dB)	ANTENNA HEIGHT (m)	TABLE ANGLE (Degree)	RAW VALUE (dBuV)	CORRECTION FACTOR (dB/m)
1	3830.00	46.3 PK	74.0	-27.7	1.00 H	16	47.00	-0.70
2	3830.00	37.1 AV	54.0	-16.9	1.00 H	16	37.80	-0.70
3	#5714.90	58.5 PK	74.0	-15.5	1.00 H	323	55.90	2.60
4	#5714.90	45.4 AV	54.0	-8.6	1.00 H	323	42.80	2.60
5	#5722.90	63.3 PK	78.2	-14.9	1.01 H	330	60.70	2.60
6	#5725.00	50.9 PK	78.2	-27.3	1.06 H	339	48.30	2.60
7	*5745.00	110.3 PK			1.17 H	342	69.30	41.00
8	*5745.00	100.1 AV			1.17 H	342	59.10	41.00
9	11490.00	61.9 PK	74.0	-12.1	1.31 H	343	46.00	15.90
10	11490.00	48.8 AV	54.0	-5.2	1.31 H	343	32.90	15.90

ANTENNA POLARITY & TEST DISTANCE: VERTICAL AT 3 M

NO.	FREQ. (MHz)	EMISSION LEVEL (dBuV/m)	LIMIT (dBuV/m)	MARGIN (dB)	ANTENNA HEIGHT (m)	TABLE ANGLE (Degree)	RAW VALUE (dBuV)	CORRECTION FACTOR (dB/m)
1	3830.00	46.6 PK	74.0	-27.4	1.01 V	76	47.30	-0.70
2	3830.00	36.5 AV	54.0	-17.5	1.01 V	76	37.20	-0.70
3	#5714.90	58.4 PK	74.0	-15.6	1.24 V	29	55.80	2.60
4	#5714.90	45.9 AV	54.0	-8.1	1.24 V	29	43.30	2.60
5	#5722.90	62.1 PK	78.2	-16.1	1.10 V	66	59.50	2.60
6	#5725.00	49.4 PK	78.2	-28.8	1.25 V	69	46.80	2.60
7	*5745.00	107.0 PK			1.24 V	64	66.00	41.00
8	*5745.00	96.8 AV			1.24 V	64	55.80	41.00
9	11490.00	66.3 PK	74.0	-7.7	1.28 V	21	50.40	15.90
10	11490.00	52.8 AV	54.0	-1.2	1.28 V	21	36.90	15.90

REMARKS:

1. Emission Level(dBuV/m) = Raw Value(dBuV) + Correction Factor(dB/m)
2. Correction Factor(dB/m) = Antenna Factor(dB/m) + Cable Factor(dB)
3. The other emission levels were very low against the limit.
4. Margin value = Emission Level – Limit value
5. " * ": Fundamental frequency.
6. " # ": The radiated frequency is out of the restricted band.

CHANNEL	TX Channel 157	DETECTOR FUNCTION	Peak (PK)
FREQUENCY RANGE	1GHz ~ 40GHz		Average (AV)

ANTENNA POLARITY & TEST DISTANCE: HORIZONTAL AT 3 M

NO.	FREQ. (MHz)	EMISSION LEVEL (dBuV/m)	LIMIT (dBuV/m)	MARGIN (dB)	ANTENNA HEIGHT (m)	TABLE ANGLE (Degree)	RAW VALUE (dBuV)	CORRECTION FACTOR (dB/m)
1	3856.00	47.2 PK	74.0	-26.8	1.00 H	33	47.80	-0.60
2	3856.00	37.6 AV	54.0	-16.4	1.00 H	33	38.20	-0.60
3	*5785.00	110.1 PK			1.03 H	345	69.00	41.10
4	*5785.00	99.7 AV			1.03 H	345	58.60	41.10
5	11570.00	60.9 PK	74.0	-13.1	1.02 H	315	45.30	15.60
6	11570.00	48.1 AV	54.0	-5.9	1.02 H	315	32.50	15.60

ANTENNA POLARITY & TEST DISTANCE: VERTICAL AT 3 M

NO.	FREQ. (MHz)	EMISSION LEVEL (dBuV/m)	LIMIT (dBuV/m)	MARGIN (dB)	ANTENNA HEIGHT (m)	TABLE ANGLE (Degree)	RAW VALUE (dBuV)	CORRECTION FACTOR (dB/m)
1	3856.00	46.9 PK	74.0	-27.1	1.03 V	301	47.50	-0.60
2	3856.00	38.5 AV	54.0	-15.5	1.03 V	301	39.10	-0.60
3	*5785.00	108.6 PK			1.13 V	36	67.50	41.10
4	*5785.00	98.6 AV			1.13 V	36	57.50	41.10
5	11570.00	67.2 PK	74.0	-6.8	1.23 V	21	51.60	15.60
6	11570.00	53.0 AV	54.0	-1.0	1.23 V	21	37.40	15.60

REMARKS:

1. Emission Level(dBuV/m) = Raw Value(dBuV) + Correction Factor(dB/m)
2. Correction Factor(dB/m) = Antenna Factor(dB/m) + Cable Factor(dB)
3. The other emission levels were very low against the limit.
4. Margin value = Emission Level – Limit value
5. " * ": Fundamental frequency.

CHANNEL	TX Channel 165	DETECTOR FUNCTION	Peak (PK)
FREQUENCY RANGE	1GHz ~ 40GHz		Average (AV)

ANTENNA POLARITY & TEST DISTANCE: HORIZONTAL AT 3 M

NO.	FREQ. (MHz)	EMISSION LEVEL (dBuV/m)	LIMIT (dBuV/m)	MARGIN (dB)	ANTENNA HEIGHT (m)	TABLE ANGLE (Degree)	RAW VALUE (dBuV)	CORRECTION FACTOR (dB/m)
1	3883.00	45.8 PK	74.0	-28.2	1.00 H	15	46.50	-0.70
2	3883.00	36.4 AV	54.0	-17.6	1.00 H	15	37.10	-0.70
3	*5825.00	108.0 PK			1.13 H	344	66.90	41.10
4	*5825.00	97.9 AV			1.13 H	344	56.80	41.10
5	#5850.00	48.7 PK	78.2	-29.5	1.00 H	66	45.70	3.00
6	#5852.10	62.8 PK	78.2	-15.4	1.00 H	77	59.80	3.00
7	#5860.10	58.9 PK	74.0	-15.1	1.00 H	72	55.90	3.00
8	#5860.10	45.8 AV	54.0	-8.2	1.00 H	72	42.80	3.00
9	11650.00	61.8 PK	74.0	-12.2	1.00 H	353	46.20	15.60
10	11650.00	48.2 AV	54.0	-5.8	1.00 H	353	32.60	15.60

ANTENNA POLARITY & TEST DISTANCE: VERTICAL AT 3 M

NO.	FREQ. (MHz)	EMISSION LEVEL (dBuV/m)	LIMIT (dBuV/m)	MARGIN (dB)	ANTENNA HEIGHT (m)	TABLE ANGLE (Degree)	RAW VALUE (dBuV)	CORRECTION FACTOR (dB/m)
1	3883.00	46.9 PK	74.0	-27.1	1.00 V	75	47.60	-0.70
2	3883.00	39.1 AV	54.0	-14.9	1.00 V	75	39.80	-0.70
3	*5825.00	106.5 PK			1.13 V	37	65.40	41.10
4	*5825.00	96.5 AV			1.13 V	37	55.40	41.10
5	#5850.00	48.6 PK	78.2	-29.6	1.02 V	34	45.60	3.00
6	#5852.10	59.9 PK	78.2	-18.3	1.00 V	33	56.90	3.00
7	#5860.10	58.1 PK	74.0	-15.9	1.00 V	41	55.10	3.00
8	#5860.10	44.6 AV	54.0	-9.4	1.00 V	41	41.60	3.00
9	11650.00	67.1 PK	74.0	-6.9	1.16 V	24	51.50	15.60
10	11650.00	52.9 AV	54.0	-1.1	1.16 V	24	37.30	15.60

REMARKS:

1. Emission Level(dBuV/m) = Raw Value(dBuV) + Correction Factor(dB/m)
2. Correction Factor(dB/m) = Antenna Factor(dB/m) + Cable Factor(dB)
3. The other emission levels were very low against the limit.
4. Margin value = Emission Level – Limit value
5. " * ": Fundamental frequency.
6. " # ": The radiated frequency is out of the restricted band.

802.11n (HT40)_2TX

CHANNEL	TX Channel 151	DETECTOR FUNCTION	Peak (PK)
FREQUENCY RANGE	1GHz ~ 40GHz		Average (AV)

ANTENNA POLARITY & TEST DISTANCE: HORIZONTAL AT 3 M

NO.	FREQ. (MHz)	EMISSION LEVEL (dBuV/m)	LIMIT (dBuV/m)	MARGIN (dB)	ANTENNA HEIGHT (m)	TABLE ANGLE (Degree)	RAW VALUE (dBuV)	CORRECTION FACTOR (dB/m)
1	3836.00	45.7 PK	74.0	-28.3	1.00 H	57	46.40	-0.70
2	3836.00	35.5 AV	54.0	-18.5	1.00 H	57	36.20	-0.70
3	#5714.90	60.9 PK	74.0	-13.1	1.00 H	87	58.30	2.60
4	#5714.90	48.5 AV	54.0	-5.5	1.00 H	87	45.90	2.60
5	#5722.90	67.9 PK	78.2	-10.3	1.00 H	72	65.30	2.60
6	#5725.00	55.9 PK	78.2	-22.3	1.00 H	69	53.30	2.60
7	*5755.00	107.7 PK			1.18 H	341	66.70	41.00
8	*5755.00	97.6 AV			1.18 H	341	56.60	41.00
9	11510.00	61.1 PK	74.0	-12.9	1.27 H	55	45.40	15.70
10	11510.00	47.4 AV	54.0	-6.6	1.27 H	55	31.70	15.70

ANTENNA POLARITY & TEST DISTANCE: VERTICAL AT 3 M

NO.	FREQ. (MHz)	EMISSION LEVEL (dBuV/m)	LIMIT (dBuV/m)	MARGIN (dB)	ANTENNA HEIGHT (m)	TABLE ANGLE (Degree)	RAW VALUE (dBuV)	CORRECTION FACTOR (dB/m)
1	3836.00	47.2 PK	74.0	-26.8	1.00 V	76	47.90	-0.70
2	3836.00	38.4 AV	54.0	-15.6	1.00 V	76	39.10	-0.70
3	#5714.90	60.8 PK	74.0	-13.2	1.00 V	72	58.20	2.60
4	#5714.90	49.3 AV	54.0	-4.7	1.00 V	72	46.70	2.60
5	#5722.90	66.4 PK	78.2	-11.8	1.00 V	59	63.80	2.60
6	#5725.00	55.5 PK	78.2	-22.7	1.00 V	60	52.90	2.60
7	*5755.00	104.2 PK			1.25 V	67	63.20	41.00
8	*5755.00	94.4 AV			1.25 V	67	53.40	41.00
9	11510.00	65.2 PK	74.0	-8.8	1.13 V	21	49.50	15.70
10	11510.00	52.5 AV	54.0	-1.5	1.13 V	21	36.80	15.70

REMARKS:

1. Emission Level(dBuV/m) = Raw Value(dBuV) + Correction Factor(dB/m)
2. Correction Factor(dB/m) = Antenna Factor(dB/m) + Cable Factor(dB)
3. The other emission levels were very low against the limit.
4. Margin value = Emission Level – Limit value
5. " * ": Fundamental frequency.
6. " # ": The radiated frequency is out of the restricted band.

CHANNEL	TX Channel 159	DETECTOR FUNCTION	Peak (PK)
FREQUENCY RANGE	1GHz ~ 40GHz		Average (AV)

ANTENNA POLARITY & TEST DISTANCE: HORIZONTAL AT 3 M

NO.	FREQ. (MHz)	EMISSION LEVEL (dBuV/m)	LIMIT (dBuV/m)	MARGIN (dB)	ANTENNA HEIGHT (m)	TABLE ANGLE (Degree)	RAW VALUE (dBuV)	CORRECTION FACTOR (dB/m)
1	3863.00	46.2 PK	74.0	-27.8	1.00 H	10	46.80	-0.60
2	3863.00	36.7 AV	54.0	-17.3	1.00 H	10	37.30	-0.60
3	*5795.00	107.4 PK			1.03 H	345	66.30	41.10
4	*5795.00	97.4 AV			1.03 H	345	56.30	41.10
5	#5850.00	47.6 PK	78.2	-30.6	1.00 H	54	44.60	3.00
6	#5852.10	59.3 PK	78.2	-18.9	1.00 H	91	56.30	3.00
7	#5860.10	58.1 PK	74.0	-15.9	1.00 H	72	55.10	3.00
8	#5860.10	45.0 AV	54.0	-9.0	1.00 H	72	42.00	3.00
9	11590.00	64.2 PK	74.0	-9.8	1.00 H	316	48.60	15.60
10	11590.00	49.9 AV	54.0	-4.1	1.00 H	316	34.30	15.60

ANTENNA POLARITY & TEST DISTANCE: VERTICAL AT 3 M

NO.	FREQ. (MHz)	EMISSION LEVEL (dBuV/m)	LIMIT (dBuV/m)	MARGIN (dB)	ANTENNA HEIGHT (m)	TABLE ANGLE (Degree)	RAW VALUE (dBuV)	CORRECTION FACTOR (dB/m)
1	3863.00	46.6 PK	74.0	-27.4	1.00 V	75	47.20	-0.60
2	3863.00	37.3 AV	54.0	-16.7	1.00 V	75	37.90	-0.60
3	*5795.00	105.9 PK			1.13 V	34	64.80	41.10
4	*5795.00	96.4 AV			1.13 V	34	55.30	41.10
5	#5850.00	46.6 PK	78.2	-31.6	1.00 V	38	43.60	3.00
6	#5852.10	58.6 PK	78.2	-19.6	1.00 V	35	55.60	3.00
7	#5860.10	57.9 PK	74.0	-16.1	1.00 V	41	54.90	3.00
8	#5860.10	44.9 AV	54.0	-9.1	1.00 V	41	41.90	3.00
9	11590.00	65.0 PK	74.0	-9.0	1.23 V	24	49.40	15.60
10	11590.00	52.6 AV	54.0	-1.4	1.23 V	24	37.00	15.60

REMARKS:

1. Emission Level(dBuV/m) = Raw Value(dBuV) + Correction Factor(dB/m)
2. Correction Factor(dB/m) = Antenna Factor(dB/m) + Cable Factor(dB)
3. The other emission levels were very low against the limit.
4. Margin value = Emission Level – Limit value
5. " * ": Fundamental frequency.
6. " # ": The radiated frequency is out of the restricted band.

802.11ac (VHT20)_2TX

CHANNEL	TX Channel 149	DETECTOR FUNCTION	Peak (PK)
FREQUENCY RANGE	1GHz ~ 40GHz		Average (AV)

ANTENNA POLARITY & TEST DISTANCE: HORIZONTAL AT 3 M

NO.	FREQ. (MHz)	EMISSION LEVEL (dBuV/m)	LIMIT (dBuV/m)	MARGIN (dB)	ANTENNA HEIGHT (m)	TABLE ANGLE (Degree)	RAW VALUE (dBuV)	CORRECTION FACTOR (dB/m)
1	3830.00	46.4 PK	74.0	-27.6	1.00 H	17	47.10	-0.70
2	3830.00	37.2 AV	54.0	-16.8	1.00 H	17	37.90	-0.70
3	#5714.90	58.7 PK	74.0	-15.3	1.00 H	337	56.10	2.60
4	#5714.90	45.8 AV	54.0	-8.2	1.00 H	337	43.20	2.60
5	#5722.90	63.6 PK	78.2	-14.6	1.00 H	298	61.00	2.60
6	#5725.00	51.1 PK	78.2	-27.1	1.05 H	341	48.50	2.60
7	*5745.00	109.8 PK			1.03 H	340	68.80	41.00
8	*5745.00	99.7 AV			1.03 H	340	58.70	41.00
9	11490.00	62.1 PK	74.0	-11.9	1.30 H	331	46.20	15.90
10	11490.00	49.0 AV	54.0	-5.0	1.30 H	331	33.10	15.90

ANTENNA POLARITY & TEST DISTANCE: VERTICAL AT 3 M

NO.	FREQ. (MHz)	EMISSION LEVEL (dBuV/m)	LIMIT (dBuV/m)	MARGIN (dB)	ANTENNA HEIGHT (m)	TABLE ANGLE (Degree)	RAW VALUE (dBuV)	CORRECTION FACTOR (dB/m)
1	3830.00	46.8 PK	74.0	-27.2	1.00 V	77	47.50	-0.70
2	3830.00	36.8 AV	54.0	-17.2	1.00 V	77	37.50	-0.70
3	#5714.90	58.5 PK	74.0	-15.5	1.24 V	28	55.90	2.60
4	#5714.90	46.1 AV	54.0	-7.9	1.24 V	28	43.50	2.60
5	#5722.90	62.4 PK	78.2	-15.8	1.09 V	62	59.80	2.60
6	#5725.00	49.5 PK	78.2	-28.7	1.22 V	65	46.90	2.60
7	*5745.00	107.8 PK			1.00 V	62	66.80	41.00
8	*5745.00	98.0 AV			1.00 V	62	57.00	41.00
9	11490.00	66.8 PK	74.0	-7.2	1.24 V	22	50.90	15.90
10	11490.00	53.0 AV	54.0	-1.0	1.24 V	22	37.10	15.90

REMARKS:

1. Emission Level(dBuV/m) = Raw Value(dBuV) + Correction Factor(dB/m)
2. Correction Factor(dB/m) = Antenna Factor(dB/m) + Cable Factor(dB)
3. The other emission levels were very low against the limit.
4. Margin value = Emission Level – Limit value
5. " * ": Fundamental frequency.
6. " # ": The radiated frequency is out of the restricted band.

CHANNEL	TX Channel 157	DETECTOR FUNCTION	Peak (PK)
FREQUENCY RANGE	1GHz ~ 40GHz		Average (AV)

ANTENNA POLARITY & TEST DISTANCE: HORIZONTAL AT 3 M

NO.	FREQ. (MHz)	EMISSION LEVEL (dBuV/m)	LIMIT (dBuV/m)	MARGIN (dB)	ANTENNA HEIGHT (m)	TABLE ANGLE (Degree)	RAW VALUE (dBuV)	CORRECTION FACTOR (dB/m)
1	3856.00	47.3 PK	74.0	-26.7	1.00 H	32	47.90	-0.60
2	3856.00	37.7 AV	54.0	-16.3	1.00 H	32	38.30	-0.60
3	*5785.00	109.4 PK			1.14 H	346	68.30	41.10
4	*5785.00	99.2 AV			1.14 H	346	58.10	41.10
5	11570.00	61.0 PK	74.0	-13.0	1.00 H	311	45.40	15.60
6	11570.00	48.0 AV	54.0	-6.0	1.00 H	311	32.40	15.60

ANTENNA POLARITY & TEST DISTANCE: VERTICAL AT 3 M

NO.	FREQ. (MHz)	EMISSION LEVEL (dBuV/m)	LIMIT (dBuV/m)	MARGIN (dB)	ANTENNA HEIGHT (m)	TABLE ANGLE (Degree)	RAW VALUE (dBuV)	CORRECTION FACTOR (dB/m)
1	3856.00	46.9 PK	74.0	-27.1	1.02 V	299	47.50	-0.60
2	3856.00	38.6 AV	54.0	-15.4	1.02 V	299	39.20	-0.60
3	*5785.00	108.9 PK			1.14 V	35	67.80	41.10
4	*5785.00	98.6 AV			1.14 V	35	57.50	41.10
5	11570.00	66.3 PK	74.0	-7.7	1.28 V	20	50.70	15.60
6	11570.00	52.7 AV	54.0	-1.3	1.28 V	20	37.10	15.60

REMARKS:

1. Emission Level(dBuV/m) = Raw Value(dBuV) + Correction Factor(dB/m)
2. Correction Factor(dB/m) = Antenna Factor(dB/m) + Cable Factor(dB)
3. The other emission levels were very low against the limit.
4. Margin value = Emission Level – Limit value
5. " * ": Fundamental frequency.

CHANNEL	TX Channel 165	DETECTOR FUNCTION	Peak (PK)
FREQUENCY RANGE	1GHz ~ 40GHz		Average (AV)

ANTENNA POLARITY & TEST DISTANCE: HORIZONTAL AT 3 M

NO.	FREQ. (MHz)	EMISSION LEVEL (dBuV/m)	LIMIT (dBuV/m)	MARGIN (dB)	ANTENNA HEIGHT (m)	TABLE ANGLE (Degree)	RAW VALUE (dBuV)	CORRECTION FACTOR (dB/m)
1	3883.00	45.5 PK	74.0	-28.5	1.00 H	10	46.20	-0.70
2	3883.00	35.9 AV	54.0	-18.1	1.00 H	10	36.60	-0.70
3	*5825.00	108.1 PK			1.14 H	342	67.00	41.10
4	*5825.00	98.0 AV			1.14 H	342	56.90	41.10
5	#5850.00	48.9 PK	78.2	-29.3	1.00 H	71	45.90	3.00
6	#5852.10	63.1 PK	78.2	-15.1	1.00 H	60	60.10	3.00
7	#5860.10	59.2 PK	74.0	-14.8	1.00 H	62	56.20	3.00
8	#5860.10	46.6 AV	54.0	-7.4	1.00 H	62	43.60	3.00
9	11650.00	62.1 PK	74.0	-11.9	1.00 H	351	46.50	15.60
10	11650.00	48.4 AV	54.0	-5.6	1.00 H	351	32.80	15.60

ANTENNA POLARITY & TEST DISTANCE: VERTICAL AT 3 M

NO.	FREQ. (MHz)	EMISSION LEVEL (dBuV/m)	LIMIT (dBuV/m)	MARGIN (dB)	ANTENNA HEIGHT (m)	TABLE ANGLE (Degree)	RAW VALUE (dBuV)	CORRECTION FACTOR (dB/m)
1	3883.00	47.2 PK	74.0	-26.8	1.00 V	69	47.90	-0.70
2	3883.00	39.4 AV	54.0	-14.6	1.00 V	69	40.10	-0.70
3	*5825.00	107.6 PK			1.13 V	34	66.50	41.10
4	*5825.00	97.1 AV			1.13 V	34	56.00	41.10
5	#5850.00	48.9 PK	78.2	-29.3	1.01 V	39	45.90	3.00
6	#5852.10	60.1 PK	78.2	-18.1	1.00 V	36	57.10	3.00
7	#5860.10	58.4 PK	74.0	-15.6	1.00 V	40	55.40	3.00
8	#5860.10	44.9 AV	54.0	-9.1	1.00 V	40	41.90	3.00
9	11650.00	66.8 PK	74.0	-7.2	1.11 V	23	51.20	15.60
10	11650.00	52.7 AV	54.0	-1.3	1.11 V	23	37.10	15.60

REMARKS:

1. Emission Level(dBuV/m) = Raw Value(dBuV) + Correction Factor(dB/m)
2. Correction Factor(dB/m) = Antenna Factor(dB/m) + Cable Factor(dB)
3. The other emission levels were very low against the limit.
4. Margin value = Emission Level – Limit value
5. " * ": Fundamental frequency.
6. " # ": The radiated frequency is out of the restricted band.

802.11ac (VHT40)_2TX

CHANNEL	TX Channel 151	DETECTOR FUNCTION	Peak (PK)
FREQUENCY RANGE	1GHz ~ 40GHz		Average (AV)

ANTENNA POLARITY & TEST DISTANCE: HORIZONTAL AT 3 M

NO.	FREQ. (MHz)	EMISSION LEVEL (dBuV/m)	LIMIT (dBuV/m)	MARGIN (dB)	ANTENNA HEIGHT (m)	TABLE ANGLE (Degree)	RAW VALUE (dBuV)	CORRECTION FACTOR (dB/m)
1	3836.00	45.1 PK	74.0	-28.9	1.00 H	66	45.80	-0.70
2	3836.00	35.6 AV	54.0	-18.4	1.00 H	66	36.30	-0.70
3	#5714.90	60.8 PK	74.0	-13.2	1.00 H	79	58.20	2.60
4	#5714.90	48.2 AV	54.0	-5.8	1.00 H	79	45.60	2.60
5	#5722.90	67.7 PK	78.2	-10.5	1.00 H	80	65.10	2.60
6	#5725.00	56.1 PK	78.2	-22.1	1.00 H	62	53.50	2.60
7	*5755.00	107.9 PK			1.21 H	340	66.90	41.00
8	*5755.00	97.9 AV			1.21 H	340	56.90	41.00
9	11510.00	61.3 PK	74.0	-12.7	1.22 H	58	45.60	15.70
10	11510.00	47.6 AV	54.0	-6.4	1.22 H	58	31.90	15.70

ANTENNA POLARITY & TEST DISTANCE: VERTICAL AT 3 M

NO.	FREQ. (MHz)	EMISSION LEVEL (dBuV/m)	LIMIT (dBuV/m)	MARGIN (dB)	ANTENNA HEIGHT (m)	TABLE ANGLE (Degree)	RAW VALUE (dBuV)	CORRECTION FACTOR (dB/m)
1	3836.00	47.1 PK	74.0	-26.9	1.00 V	86	47.80	-0.70
2	3836.00	38.2 AV	54.0	-15.8	1.00 V	86	38.90	-0.70
3	#5714.90	60.7 PK	74.0	-13.3	1.00 V	73	58.10	2.60
4	#5714.90	48.8 AV	54.0	-5.2	1.00 V	73	46.20	2.60
5	#5722.90	66.1 PK	78.2	-12.1	1.00 V	63	63.50	2.60
6	#5725.00	55.4 PK	78.2	-22.8	1.00 V	70	52.80	2.60
7	*5755.00	104.3 PK			1.09 V	66	63.30	41.00
8	*5755.00	94.4 AV			1.09 V	66	53.40	41.00
9	11510.00	65.5 PK	74.0	-8.5	1.10 V	32	49.80	15.70
10	11510.00	52.6 AV	54.0	-1.4	1.10 V	32	36.90	15.70

REMARKS:

1. Emission Level(dBuV/m) = Raw Value(dBuV) + Correction Factor(dB/m)
2. Correction Factor(dB/m) = Antenna Factor(dB/m) + Cable Factor(dB)
3. The other emission levels were very low against the limit.
4. Margin value = Emission Level – Limit value
5. " * ": Fundamental frequency.
6. " # ": The radiated frequency is out of the restricted band.

CHANNEL	TX Channel 159	DETECTOR FUNCTION	Peak (PK)
FREQUENCY RANGE	1GHz ~ 40GHz		Average (AV)

ANTENNA POLARITY & TEST DISTANCE: HORIZONTAL AT 3 M

NO.	FREQ. (MHz)	EMISSION LEVEL (dBuV/m)	LIMIT (dBuV/m)	MARGIN (dB)	ANTENNA HEIGHT (m)	TABLE ANGLE (Degree)	RAW VALUE (dBuV)	CORRECTION FACTOR (dB/m)
1	3863.00	46.3 PK	74.0	-27.7	1.00 H	33	46.90	-0.60
2	3863.00	36.8 AV	54.0	-17.2	1.00 H	33	37.40	-0.60
3	*5795.00	107.7 PK			1.02 H	344	66.60	41.10
4	*5795.00	97.5 AV			1.02 H	344	56.40	41.10
5	#5850.00	47.9 PK	78.2	-30.3	1.00 H	63	44.90	3.00
6	#5852.10	59.8 PK	78.2	-18.4	1.00 H	77	56.80	3.00
7	#5860.10	58.6 PK	74.0	-15.4	1.00 H	86	55.60	3.00
8	#5860.10	45.8 AV	54.0	-8.2	1.00 H	86	42.80	3.00
9	11590.00	64.4 PK	74.0	-9.6	1.00 H	322	48.80	15.60
10	11590.00	50.2 AV	54.0	-3.8	1.00 H	322	34.60	15.60

ANTENNA POLARITY & TEST DISTANCE: VERTICAL AT 3 M

NO.	FREQ. (MHz)	EMISSION LEVEL (dBuV/m)	LIMIT (dBuV/m)	MARGIN (dB)	ANTENNA HEIGHT (m)	TABLE ANGLE (Degree)	RAW VALUE (dBuV)	CORRECTION FACTOR (dB/m)
1	3863.00	46.9 PK	74.0	-27.1	1.00 V	93	47.50	-0.60
2	3863.00	37.6 AV	54.0	-16.4	1.00 V	93	38.20	-0.60
3	*5795.00	106.2 PK			1.12 V	41	65.10	41.10
4	*5795.00	93.9 AV			1.12 V	41	52.80	41.10
5	#5850.00	46.9 PK	78.2	-31.3	1.00 V	33	43.90	3.00
6	#5852.10	58.9 PK	78.2	-19.3	1.00 V	49	55.90	3.00
7	#5860.10	58.2 PK	74.0	-15.8	1.00 V	51	55.20	3.00
8	#5860.10	45.3 AV	54.0	-8.7	1.00 V	51	42.30	3.00
9	11590.00	65.1 PK	74.0	-8.9	1.22 V	26	49.50	15.60
10	11590.00	52.7 AV	54.0	-1.3	1.22 V	26	37.10	15.60

REMARKS:

1. Emission Level(dBuV/m) = Raw Value(dBuV) + Correction Factor(dB/m)
2. Correction Factor(dB/m) = Antenna Factor(dB/m) + Cable Factor(dB)
3. The other emission levels were very low against the limit.
4. Margin value = Emission Level – Limit value
5. " * ": Fundamental frequency.
6. " # ": The radiated frequency is out of the restricted band.

802.11ac (VHT80)_2TX

CHANNEL	TX Channel 155	DETECTOR FUNCTION	Peak (PK)
FREQUENCY RANGE	1GHz ~ 40GHz		Average (AV)

ANTENNA POLARITY & TEST DISTANCE: HORIZONTAL AT 3 M

NO.	FREQ. (MHz)	EMISSION LEVEL (dBuV/m)	LIMIT (dBuV/m)	MARGIN (dB)	ANTENNA HEIGHT (m)	TABLE ANGLE (Degree)	RAW VALUE (dBuV)	CORRECTION FACTOR (dB/m)
1	3850.00	45.8 PK	74.0	-28.2	1.00 H	102	46.50	-0.70
2	3850.00	36.6 AV	54.0	-17.4	1.00 H	102	37.30	-0.70
3	#5714.90	68.9 PK	74.0	-5.1	1.08 H	338	66.30	2.60
4	#5714.90	53.0 AV	54.0	-1.0	1.08 H	338	50.40	2.60
5	#5722.90	71.9 PK	78.2	-6.3	1.00 H	327	69.30	2.60
6	#5725.00	57.4 PK	78.2	-20.8	1.00 H	323	54.80	2.60
7	*5775.00	104.3 PK			1.17 H	343	63.30	41.00
8	*5775.00	93.9 AV			1.17 H	343	52.90	41.00
9	#5850.00	63.2 PK	78.2	-15.0	1.00 H	329	60.20	3.00
10	#5860.10	58.1 PK	74.0	-15.9	1.00 H	335	55.10	3.00
11	#5860.10	45.9 AV	54.0	-8.1	1.00 H	335	42.90	3.00
12	11550.00	59.8 PK	74.0	-14.2	1.00 H	201	44.20	15.60
13	11550.00	47.4 AV	54.0	-6.6	1.00 H	201	31.80	15.60

ANTENNA POLARITY & TEST DISTANCE: VERTICAL AT 3 M

NO.	FREQ. (MHz)	EMISSION LEVEL (dBuV/m)	LIMIT (dBuV/m)	MARGIN (dB)	ANTENNA HEIGHT (m)	TABLE ANGLE (Degree)	RAW VALUE (dBuV)	CORRECTION FACTOR (dB/m)
1	3850.00	46.1 PK	74.0	-27.9	1.00 V	102	46.80	-0.70
2	3850.00	38.5 AV	54.0	-15.5	1.00 V	102	39.20	-0.70
3	#5714.90	62.3 PK	74.0	-11.7	1.00 V	65	59.70	2.60
4	#5714.90	49.0 AV	54.0	-5.0	1.00 V	65	46.40	2.60
5	#5722.90	68.1 PK	78.2	-10.1	1.12 V	45	65.50	2.60
6	#5725.00	54.8 PK	78.2	-23.4	1.13 V	39	52.20	2.60
7	*5775.00	100.2 PK			1.25 V	65	59.20	41.00
8	*5775.00	89.7 AV			1.25 V	65	48.70	41.00
9	#5850.00	60.5 PK	78.2	-17.7	1.03 V	38	57.50	3.00
10	#5860.10	59.0 PK	74.0	-15.0	1.00 V	44	56.00	3.00
11	#5860.10	45.4 AV	54.0	-8.6	1.00 V	44	42.40	3.00
12	11500.00	63.3 PK	74.0	-10.7	1.02 V	65	47.60	15.70
13	11500.00	49.5 AV	54.0	-4.5	1.02 V	65	33.80	15.70

REMARKS:

1. Emission Level(dBuV/m) = Raw Value(dBuV) + Correction Factor(dB/m)
2. Correction Factor(dB/m) = Antenna Factor(dB/m) + Cable Factor(dB)
3. The other emission levels were very low against the limit.
4. Margin value = Emission Level – Limit value
5. " * ": Fundamental frequency.
6. " # ": The radiated frequency is out of the restricted band.

802.11n (HT20)_3TX

CHANNEL	TX Channel 149	DETECTOR FUNCTION	Peak (PK)
FREQUENCY RANGE	1GHz ~ 40GHz		Average (AV)

ANTENNA POLARITY & TEST DISTANCE: HORIZONTAL AT 3 M

NO.	FREQ. (MHz)	EMISSION LEVEL (dBuV/m)	LIMIT (dBuV/m)	MARGIN (dB)	ANTENNA HEIGHT (m)	TABLE ANGLE (Degree)	RAW VALUE (dBuV)	CORRECTION FACTOR (dB/m)
1	#3830.00	46.2 PK	74.0	-27.8	1.00 H	10	46.90	-0.70
2	#3830.00	37.1 AV	54.0	-16.9	1.00 H	10	37.80	-0.70
3	#5714.90	57.8 PK	74.0	-16.2	1.13 H	352	55.20	2.60
4	#5714.90	45.3 AV	54.0	-8.7	1.13 H	352	42.70	2.60
5	#5722.90	66.0 PK	78.2	-12.2	1.13 H	352	63.40	2.60
6	#5725.00	50.4 PK	78.2	-27.8	1.13 H	347	47.80	2.60
7	*5745.00	110.3 PK			1.00 H	76	69.30	41.00
8	*5745.00	100.3 AV			1.00 H	76	59.30	41.00
9	#11490.00	64.0 PK	74.0	-10.0	1.38 H	337	48.10	15.90
10	#11490.00	50.8 AV	54.0	-3.2	1.38 H	337	34.90	15.90

ANTENNA POLARITY & TEST DISTANCE: VERTICAL AT 3 M

NO.	FREQ. (MHz)	EMISSION LEVEL (dBuV/m)	LIMIT (dBuV/m)	MARGIN (dB)	ANTENNA HEIGHT (m)	TABLE ANGLE (Degree)	RAW VALUE (dBuV)	CORRECTION FACTOR (dB/m)
1	#3830.00	47.1 PK	74.0	-26.9	1.30 V	71	47.80	-0.70
2	#3830.00	36.7 AV	54.0	-17.3	1.30 V	71	37.40	-0.70
3	#5714.90	58.2 PK	74.0	-15.8	1.00 V	88	55.60	2.60
4	#5714.90	45.7 AV	54.0	-8.3	1.00 V	88	43.10	2.60
5	#5722.90	63.7 PK	78.2	-14.5	1.00 V	93	61.10	2.60
6	#5725.00	50.8 PK	78.2	-27.4	1.13 V	94	48.20	2.60
7	*5745.00	108.0 PK			1.01 V	59	67.00	41.00
8	*5745.00	98.2 AV			1.01 V	59	57.20	41.00
9	#11490.00	68.0 PK	74.0	-6.0	1.40 V	18	52.10	15.90
10	#11490.00	52.9 AV	54.0	-1.1	1.40 V	18	37.00	15.90

REMARKS:

1. Emission Level(dBuV/m) = Raw Value(dBuV) + Correction Factor(dB/m)
2. Correction Factor(dB/m) = Antenna Factor(dB/m) + Cable Factor(dB)
3. The other emission levels were very low against the limit.
4. Margin value = Emission Level – Limit value
5. " * ": Fundamental frequency.
6. " # ": The radiated frequency is out of the restricted band.

CHANNEL	TX Channel 157	DETECTOR FUNCTION	Peak (PK)
FREQUENCY RANGE	1GHz ~ 40GHz		Average (AV)

ANTENNA POLARITY & TEST DISTANCE: HORIZONTAL AT 3 M

NO.	FREQ. (MHz)	EMISSION LEVEL (dBuV/m)	LIMIT (dBuV/m)	MARGIN (dB)	ANTENNA HEIGHT (m)	TABLE ANGLE (Degree)	RAW VALUE (dBuV)	CORRECTION FACTOR (dB/m)
1	#3856.00	46.8 PK	74.0	-27.2	1.00 H	12	47.40	-0.60
2	#3856.00	37.1 AV	54.0	-16.9	1.00 H	12	37.70	-0.60
3	*5785.00	108.6 PK			1.00 H	82	67.50	41.10
4	*5785.00	99.4 AV			1.00 H	82	58.30	41.10
5	#11570.00	63.9 PK	74.0	-10.1	1.00 H	314	48.30	15.60
6	#11570.00	50.6 AV	54.0	-3.4	1.00 H	314	35.00	15.60

ANTENNA POLARITY & TEST DISTANCE: VERTICAL AT 3 M

NO.	FREQ. (MHz)	EMISSION LEVEL (dBuV/m)	LIMIT (dBuV/m)	MARGIN (dB)	ANTENNA HEIGHT (m)	TABLE ANGLE (Degree)	RAW VALUE (dBuV)	CORRECTION FACTOR (dB/m)
1	#3856.00	47.2 PK	74.0	-26.8	1.04 V	315	47.80	-0.60
2	#3856.00	38.6 AV	54.0	-15.4	1.04 V	315	39.20	-0.60
3	*5785.00	110.4 PK			1.02 V	33	69.30	41.10
4	*5785.00	100.4 AV			1.02 V	33	59.30	41.10
5	#11570.00	66.7 PK	74.0	-7.3	1.37 V	35	51.10	15.60
6	#11570.00	52.7 AV	54.0	-1.3	1.37 V	35	37.10	15.60

REMARKS:

1. Emission Level(dBuV/m) = Raw Value(dBuV) + Correction Factor(dB/m)
2. Correction Factor(dB/m) = Antenna Factor(dB/m) + Cable Factor(dB)
3. The other emission levels were very low against the limit.
4. Margin value = Emission Level – Limit value
5. " * ": Fundamental frequency.
6. " # ": The radiated frequency is out of the restricted band.

CHANNEL	TX Channel 165	DETECTOR FUNCTION	Peak (PK)
FREQUENCY RANGE	1GHz ~ 40GHz		Average (AV)

ANTENNA POLARITY & TEST DISTANCE: HORIZONTAL AT 3 M

NO.	FREQ. (MHz)	EMISSION LEVEL (dBuV/m)	LIMIT (dBuV/m)	MARGIN (dB)	ANTENNA HEIGHT (m)	TABLE ANGLE (Degree)	RAW VALUE (dBuV)	CORRECTION FACTOR (dB/m)
1	#3883.00	45.8 PK	74.0	-28.2	1.00 H	7	46.50	-0.70
2	#3883.00	36.4 AV	54.0	-17.6	1.00 H	7	37.10	-0.70
3	*5825.00	109.1 PK			1.00 H	72	68.00	41.10
4	*5825.00	99.0 AV			1.00 H	72	57.90	41.10
5	#5850.00	48.2 PK	78.2	-30.0	1.00 H	82	45.20	3.00
6	#5852.10	63.1 PK	78.2	-15.1	1.00 H	81	60.10	3.00
7	#5860.10	58.5 PK	74.0	-15.5	1.00 H	75	55.50	3.00
8	#5860.10	45.1 AV	54.0	-8.9	1.00 H	75	42.10	3.00
9	#11650.00	62.5 PK	74.0	-11.5	1.21 H	358	46.90	15.60
10	#11650.00	49.7 AV	54.0	-4.3	1.21 H	358	34.10	15.60

ANTENNA POLARITY & TEST DISTANCE: VERTICAL AT 3 M

NO.	FREQ. (MHz)	EMISSION LEVEL (dBuV/m)	LIMIT (dBuV/m)	MARGIN (dB)	ANTENNA HEIGHT (m)	TABLE ANGLE (Degree)	RAW VALUE (dBuV)	CORRECTION FACTOR (dB/m)
1	#3883.00	47.5 PK	74.0	-26.5	1.29 V	73	48.20	-0.70
2	#3883.00	40.8 AV	54.0	-13.2	1.29 V	73	41.50	-0.70
3	*5825.00	108.9 PK			1.00 V	35	67.80	41.10
4	*5825.00	98.6 AV			1.00 V	35	57.50	41.10
5	#5850.00	48.1 PK	78.2	-30.1	1.00 V	79	45.10	3.00
6	#5852.10	59.0 PK	78.2	-19.2	1.00 V	101	56.00	3.00
7	#5860.10	57.2 PK	74.0	-16.8	1.00 V	71	54.20	3.00
8	#5860.10	44.5 AV	54.0	-9.5	1.00 V	71	41.50	3.00
9	#11650.00	67.8 PK	74.0	-6.2	1.11 V	22	52.20	15.60
10	#11650.00	52.6 AV	54.0	-1.4	1.11 V	22	37.00	15.60

REMARKS:

1. Emission Level(dBuV/m) = Raw Value(dBuV) + Correction Factor(dB/m)
2. Correction Factor(dB/m) = Antenna Factor(dB/m) + Cable Factor(dB)
3. The other emission levels were very low against the limit.
4. Margin value = Emission Level – Limit value
5. " * ": Fundamental frequency.
6. " # ": The radiated frequency is out of the restricted band.

802.11n (HT40)_3TX

CHANNEL	TX Channel 151	DETECTOR FUNCTION	Peak (PK)
FREQUENCY RANGE	1GHz ~ 40GHz		Average (AV)

ANTENNA POLARITY & TEST DISTANCE: HORIZONTAL AT 3 M

NO.	FREQ. (MHz)	EMISSION LEVEL (dBuV/m)	LIMIT (dBuV/m)	MARGIN (dB)	ANTENNA HEIGHT (m)	TABLE ANGLE (Degree)	RAW VALUE (dBuV)	CORRECTION FACTOR (dB/m)
1	3836.00	46.4 PK	74.0	-27.6	1.00 H	13	47.10	-0.70
2	3836.00	37.3 AV	54.0	-16.7	1.00 H	13	38.00	-0.70
3	#5714.90	64.2 PK	74.0	-9.8	1.00 H	83	61.60	2.60
4	#5714.90	51.1 AV	54.0	-2.9	1.00 H	83	48.50	2.60
5	#5722.90	69.6 PK	78.2	-8.6	1.00 H	72	67.00	2.60
6	#5725.00	56.4 PK	78.2	-21.8	1.01 H	77	53.80	2.60
7	*5755.00	108.0 PK			1.00 H	86	67.00	41.00
8	*5755.00	98.6 AV			1.00 H	86	57.60	41.00
9	11510.00	62.9 PK	74.0	-11.1	1.00 H	354	47.20	15.70
10	11510.00	49.3 AV	54.0	-4.7	1.00 H	354	33.60	15.70

ANTENNA POLARITY & TEST DISTANCE: VERTICAL AT 3 M

NO.	FREQ. (MHz)	EMISSION LEVEL (dBuV/m)	LIMIT (dBuV/m)	MARGIN (dB)	ANTENNA HEIGHT (m)	TABLE ANGLE (Degree)	RAW VALUE (dBuV)	CORRECTION FACTOR (dB/m)
1	3836.00	47.2 PK	74.0	-26.8	1.00 V	79	47.90	-0.70
2	3836.00	38.1 AV	54.0	-15.9	1.00 V	79	38.80	-0.70
3	#5714.90	60.8 PK	74.0	-13.2	1.00 V	93	58.20	2.60
4	#5714.90	49.2 AV	54.0	-4.8	1.00 V	93	46.60	2.60
5	#5722.90	67.2 PK	78.2	-11.0	1.02 V	94	64.60	2.60
6	#5725.00	55.1 PK	78.2	-23.1	1.01 V	89	52.50	2.60
7	*5755.00	108.5 PK			1.03 V	34	67.50	41.00
8	*5755.00	98.2 AV			1.03 V	34	57.20	41.00
9	11510.00	66.1 PK	74.0	-7.9	1.32 V	26	50.40	15.70
10	11510.00	53.0 AV	54.0	-1.0	1.32 V	26	37.30	15.70

REMARKS:

1. Emission Level(dBuV/m) = Raw Value(dBuV) + Correction Factor(dB/m)
2. Correction Factor(dB/m) = Antenna Factor(dB/m) + Cable Factor(dB)
3. The other emission levels were very low against the limit.
4. Margin value = Emission Level – Limit value
5. " * ": Fundamental frequency.
6. " # ": The radiated frequency is out of the restricted band.

CHANNEL	TX Channel 159	DETECTOR FUNCTION	Peak (PK)
FREQUENCY RANGE	1GHz ~ 40GHz		Average (AV)

ANTENNA POLARITY & TEST DISTANCE: HORIZONTAL AT 3 M

NO.	FREQ. (MHz)	EMISSION LEVEL (dBuV/m)	LIMIT (dBuV/m)	MARGIN (dB)	ANTENNA HEIGHT (m)	TABLE ANGLE (Degree)	RAW VALUE (dBuV)	CORRECTION FACTOR (dB/m)
1	3863.00	46.3 PK	74.0	-27.7	1.00 H	14	46.90	-0.60
2	3863.00	37.4 AV	54.0	-16.6	1.00 H	14	38.00	-0.60
3	*5795.00	108.2 PK			1.00 H	78	67.10	41.10
4	*5795.00	98.3 AV			1.00 H	78	57.20	41.10
5	#5850.00	47.4 PK	78.2	-30.8	1.00 H	84	44.40	3.00
6	#5852.10	59.2 PK	78.2	-19.0	1.18 H	84	56.20	3.00
7	#5860.10	57.8 PK	74.0	-16.2	1.24 H	76	54.80	3.00
8	#5860.10	44.7 AV	54.0	-9.3	1.24 H	76	41.70	3.00
9	11590.00	64.2 PK	74.0	-9.8	1.00 H	317	48.60	15.60
10	11590.00	50.4 AV	54.0	-3.6	1.00 H	317	34.80	15.60

ANTENNA POLARITY & TEST DISTANCE: VERTICAL AT 3 M

NO.	FREQ. (MHz)	EMISSION LEVEL (dBuV/m)	LIMIT (dBuV/m)	MARGIN (dB)	ANTENNA HEIGHT (m)	TABLE ANGLE (Degree)	RAW VALUE (dBuV)	CORRECTION FACTOR (dB/m)
1	3863.00	47.6 PK	74.0	-26.4	1.00 V	76	48.20	-0.60
2	3863.00	40.2 AV	54.0	-13.8	1.00 V	76	40.80	-0.60
3	*5795.00	104.3 PK			1.00 V	39	63.20	41.10
4	*5795.00	94.2 AV			1.00 V	39	53.10	41.10
5	#5850.00	45.9 PK	78.2	-32.3	1.00 V	89	42.90	3.00
6	#5852.10	58.1 PK	78.2	-20.1	1.00 V	89	55.10	3.00
7	#5860.10	57.9 PK	74.0	-16.1	1.00 V	85	54.90	3.00
8	#5860.10	44.6 AV	54.0	-9.4	1.00 V	85	41.60	3.00
9	11590.00	67.4 PK	74.0	-6.6	1.06 V	30	51.80	15.60
10	11590.00	52.9 AV	54.0	-1.1	1.06 V	30	37.30	15.60

REMARKS:

1. Emission Level(dBuV/m) = Raw Value(dBuV) + Correction Factor(dB/m)
2. Correction Factor(dB/m) = Antenna Factor(dB/m) + Cable Factor(dB)
3. The other emission levels were very low against the limit.
4. Margin value = Emission Level – Limit value
5. " * ": Fundamental frequency.
6. " # ": The radiated frequency is out of the restricted band.

802.11ac (VHT20)_3TX

CHANNEL	TX Channel 149	DETECTOR FUNCTION	Peak (PK)
FREQUENCY RANGE	1GHz ~ 40GHz		Average (AV)

ANTENNA POLARITY & TEST DISTANCE: HORIZONTAL AT 3 M

NO.	FREQ. (MHz)	EMISSION LEVEL (dBuV/m)	LIMIT (dBuV/m)	MARGIN (dB)	ANTENNA HEIGHT (m)	TABLE ANGLE (Degree)	RAW VALUE (dBuV)	CORRECTION FACTOR (dB/m)
1	3830.00	46.4 PK	74.0	-27.6	1.00 H	13	47.10	-0.70
2	3830.00	37.2 AV	54.0	-16.8	1.00 H	13	37.90	-0.70
3	#5714.90	58.4 PK	74.0	-15.6	1.00 H	344	55.80	2.60
4	#5714.90	45.1 AV	54.0	-8.9	1.00 H	344	42.50	2.60
5	#5722.90	65.8 PK	78.2	-12.4	1.00 H	75	63.20	2.60
6	#5725.00	50.7 PK	78.2	-27.5	1.06 H	332	48.10	2.60
7	*5745.00	111.4 PK			1.00 H	79	70.40	41.00
8	*5745.00	100.9 AV			1.00 H	79	59.90	41.00
9	11490.00	64.2 PK	74.0	-9.8	1.32 H	319	48.30	15.90
10	11490.00	51.2 AV	54.0	-2.8	1.32 H	319	35.30	15.90

ANTENNA POLARITY & TEST DISTANCE: VERTICAL AT 3 M

NO.	FREQ. (MHz)	EMISSION LEVEL (dBuV/m)	LIMIT (dBuV/m)	MARGIN (dB)	ANTENNA HEIGHT (m)	TABLE ANGLE (Degree)	RAW VALUE (dBuV)	CORRECTION FACTOR (dB/m)
1	3830.00	46.6 PK	74.0	-27.4	1.02 V	76	47.30	-0.70
2	3830.00	36.2 AV	54.0	-17.8	1.02 V	76	36.90	-0.70
3	#5714.90	59.4 PK	74.0	-14.6	1.00 V	76	56.80	2.60
4	#5714.90	46.7 AV	54.0	-7.3	1.00 V	76	44.10	2.60
5	#5722.90	64.1 PK	78.2	-14.1	1.00 V	43	61.50	2.60
6	#5725.00	50.3 PK	78.2	-27.9	1.00 V	94	47.70	2.60
7	*5745.00	107.8 PK			1.13 V	18	66.80	41.00
8	*5745.00	97.5 AV			1.13 V	18	56.50	41.00
9	11490.00	67.2 PK	74.0	-6.8	1.02 V	28	51.30	15.90
10	11490.00	53.0 AV	54.0	-1.0	1.02 V	28	37.10	15.90

REMARKS:

1. Emission Level(dBuV/m) = Raw Value(dBuV) + Correction Factor(dB/m)
2. Correction Factor(dB/m) = Antenna Factor(dB/m) + Cable Factor(dB)
3. The other emission levels were very low against the limit.
4. Margin value = Emission Level – Limit value
5. " * ": Fundamental frequency.
6. " # ": The radiated frequency is out of the restricted band.

CHANNEL	TX Channel 157	DETECTOR FUNCTION	Peak (PK)
FREQUENCY RANGE	1GHz ~ 40GHz		Average (AV)

ANTENNA POLARITY & TEST DISTANCE: HORIZONTAL AT 3 M

NO.	FREQ. (MHz)	EMISSION LEVEL (dBuV/m)	LIMIT (dBuV/m)	MARGIN (dB)	ANTENNA HEIGHT (m)	TABLE ANGLE (Degree)	RAW VALUE (dBuV)	CORRECTION FACTOR (dB/m)
1	3856.00	46.9 PK	74.0	-27.1	1.00 H	29	47.50	-0.60
2	3856.00	37.3 AV	54.0	-16.7	1.00 H	29	37.90	-0.60
3	*5785.00	110.0 PK			1.00 H	78	68.90	41.10
4	*5785.00	100.0 AV			1.00 H	78	58.90	41.10
5	11570.00	63.8 PK	74.0	-10.2	1.00 H	304	48.20	15.60
6	11570.00	50.7 AV	54.0	-3.3	1.00 H	304	35.10	15.60

ANTENNA POLARITY & TEST DISTANCE: VERTICAL AT 3 M

NO.	FREQ. (MHz)	EMISSION LEVEL (dBuV/m)	LIMIT (dBuV/m)	MARGIN (dB)	ANTENNA HEIGHT (m)	TABLE ANGLE (Degree)	RAW VALUE (dBuV)	CORRECTION FACTOR (dB/m)
1	3856.00	46.6 PK	74.0	-27.4	1.03 V	306	47.20	-0.60
2	3856.00	37.9 AV	54.0	-16.1	1.03 V	306	38.50	-0.60
3	*5785.00	108.4 PK			1.02 V	32	67.30	41.10
4	*5785.00	98.5 AV			1.02 V	32	57.40	41.10
5	11570.00	67.3 PK	74.0	-6.7	1.06 V	22	51.70	15.60
6	11570.00	52.8 AV	54.0	-1.2	1.06 V	22	37.20	15.60

REMARKS:

1. Emission Level(dBuV/m) = Raw Value(dBuV) + Correction Factor(dB/m)
2. Correction Factor(dB/m) = Antenna Factor(dB/m) + Cable Factor(dB)
3. The other emission levels were very low against the limit.
4. Margin value = Emission Level – Limit value
5. " * " : Fundamental frequency.

CHANNEL	TX Channel 165	DETECTOR FUNCTION	Peak (PK)
FREQUENCY RANGE	1GHz ~ 40GHz		Average (AV)

ANTENNA POLARITY & TEST DISTANCE: HORIZONTAL AT 3 M

NO.	FREQ. (MHz)	EMISSION LEVEL (dBuV/m)	LIMIT (dBuV/m)	MARGIN (dB)	ANTENNA HEIGHT (m)	TABLE ANGLE (Degree)	RAW VALUE (dBuV)	CORRECTION FACTOR (dB/m)
1	3883.00	45.7 PK	74.0	-28.3	1.00 H	10	46.40	-0.70
2	3883.00	36.2 AV	54.0	-17.8	1.00 H	10	36.90	-0.70
3	*5825.00	109.3 PK			1.00 H	89	68.20	41.10
4	*5825.00	98.9 AV			1.00 H	89	57.80	41.10
5	#5850.00	48.3 PK	78.2	-29.9	1.00 H	73	45.30	3.00
6	#5852.10	63.2 PK	78.2	-15.0	1.00 H	69	60.20	3.00
7	#5860.10	58.6 PK	74.0	-15.4	1.00 H	77	55.60	3.00
8	#5860.10	45.3 AV	54.0	-8.7	1.00 H	77	42.30	3.00
9	11650.00	62.4 PK	74.0	-11.6	1.19 H	344	46.80	15.60
10	11650.00	49.5 AV	54.0	-4.5	1.19 H	344	33.90	15.60

ANTENNA POLARITY & TEST DISTANCE: VERTICAL AT 3 M

NO.	FREQ. (MHz)	EMISSION LEVEL (dBuV/m)	LIMIT (dBuV/m)	MARGIN (dB)	ANTENNA HEIGHT (m)	TABLE ANGLE (Degree)	RAW VALUE (dBuV)	CORRECTION FACTOR (dB/m)
1	3883.00	47.4 PK	74.0	-26.6	1.22 V	70	48.10	-0.70
2	3883.00	40.6 AV	54.0	-13.4	1.22 V	70	41.30	-0.70
3	*5825.00	108.5 PK			1.01 V	37	67.40	41.10
4	*5825.00	98.5 AV			1.01 V	37	57.40	41.10
5	#5850.00	48.2 PK	78.2	-30.0	1.00 V	56	45.20	3.00
6	#5852.10	59.1 PK	78.2	-19.1	1.00 V	99	56.10	3.00
7	#5860.10	57.1 PK	74.0	-16.9	1.00 V	77	54.10	3.00
8	#5860.10	44.6 AV	54.0	-9.4	1.00 V	77	41.60	3.00
9	11650.00	67.1 PK	74.0	-6.9	1.16 V	24	51.50	15.60
10	11650.00	52.8 AV	54.0	-1.2	1.16 V	24	37.20	15.60

REMARKS:

1. Emission Level(dBuV/m) = Raw Value(dBuV) + Correction Factor(dB/m)
2. Correction Factor(dB/m) = Antenna Factor(dB/m) + Cable Factor(dB)
3. The other emission levels were very low against the limit.
4. Margin value = Emission Level – Limit value
5. " * ": Fundamental frequency.
6. " # ": The radiated frequency is out of the restricted band.

802.11ac (VHT40)_3TX

CHANNEL	TX Channel 151	DETECTOR FUNCTION	Peak (PK)
FREQUENCY RANGE	1GHz ~ 40GHz		Average (AV)

ANTENNA POLARITY & TEST DISTANCE: HORIZONTAL AT 3 M

NO.	FREQ. (MHz)	EMISSION LEVEL (dBuV/m)	LIMIT (dBuV/m)	MARGIN (dB)	ANTENNA HEIGHT (m)	TABLE ANGLE (Degree)	RAW VALUE (dBuV)	CORRECTION FACTOR (dB/m)
1	3836.00	46.2 PK	74.0	-27.8	1.00 H	10	46.90	-0.70
2	3836.00	37.1 AV	54.0	-16.9	1.00 H	10	37.80	-0.70
3	#5714.90	64.1 PK	74.0	-9.9	1.00 H	88	61.50	2.60
4	#5714.90	50.8 AV	54.0	-3.2	1.00 H	88	48.20	2.60
5	#5722.90	69.4 PK	78.2	-8.8	1.00 H	65	66.80	2.60
6	#5725.00	56.2 PK	78.2	-22.0	1.00 H	71	53.60	2.60
7	*5755.00	108.1 PK			1.00 H	73	67.10	41.00
8	*5755.00	98.1 AV			1.00 H	73	57.10	41.00
9	11510.00	62.6 PK	74.0	-11.4	1.00 H	339	46.90	15.70
10	11510.00	49.2 AV	54.0	-4.8	1.00 H	339	33.50	15.70

ANTENNA POLARITY & TEST DISTANCE: VERTICAL AT 3 M

NO.	FREQ. (MHz)	EMISSION LEVEL (dBuV/m)	LIMIT (dBuV/m)	MARGIN (dB)	ANTENNA HEIGHT (m)	TABLE ANGLE (Degree)	RAW VALUE (dBuV)	CORRECTION FACTOR (dB/m)
1	3836.00	47.0 PK	74.0	-27.0	1.00 V	77	47.70	-0.70
2	3836.00	38.2 AV	54.0	-15.8	1.00 V	77	38.90	-0.70
3	#5714.90	60.7 PK	74.0	-13.3	1.00 V	73	58.10	2.60
4	#5714.90	49.1 AV	54.0	-4.9	1.00 V	73	46.50	2.60
5	#5722.90	66.3 PK	78.2	-11.9	1.00 V	63	63.70	2.60
6	#5725.00	55.0 PK	78.2	-23.2	1.00 V	61	52.40	2.60
7	*5755.00	105.3 PK			1.00 V	64	64.30	41.00
8	*5755.00	95.8 AV			1.00 V	64	54.80	41.00
9	11510.00	65.0 PK	74.0	-9.0	1.07 V	20	49.30	15.70
10	11510.00	52.6 AV	54.0	-1.4	1.07 V	20	36.90	15.70

REMARKS:

1. Emission Level(dBuV/m) = Raw Value(dBuV) + Correction Factor(dB/m)
2. Correction Factor(dB/m) = Antenna Factor(dB/m) + Cable Factor(dB)
3. The other emission levels were very low against the limit.
4. Margin value = Emission Level – Limit value
5. " * ": Fundamental frequency.
6. " # ": The radiated frequency is out of the restricted band.

CHANNEL	TX Channel 159	DETECTOR FUNCTION	Peak (PK)
FREQUENCY RANGE	1GHz ~ 40GHz		Average (AV)

ANTENNA POLARITY & TEST DISTANCE: HORIZONTAL AT 3 M

NO.	FREQ. (MHz)	EMISSION LEVEL (dBuV/m)	LIMIT (dBuV/m)	MARGIN (dB)	ANTENNA HEIGHT (m)	TABLE ANGLE (Degree)	RAW VALUE (dBuV)	CORRECTION FACTOR (dB/m)
1	3863.00	45.9 PK	74.0	-28.1	1.00 H	16	46.50	-0.60
2	3863.00	36.6 AV	54.0	-17.4	1.00 H	16	37.20	-0.60
3	*5795.00	108.0 PK			1.00 H	85	66.90	41.10
4	*5795.00	98.1 AV			1.00 H	85	57.00	41.10
5	#5850.00	47.3 PK	78.2	-30.9	1.08 H	7	44.30	3.00
6	#5852.10	59.0 PK	78.2	-19.2	1.00 H	31	56.00	3.00
7	#5860.10	57.7 PK	74.0	-16.3	1.00 H	32	54.70	3.00
8	#5860.10	44.6 AV	54.0	-9.4	1.00 H	32	41.60	3.00
9	11590.00	64.1 PK	74.0	-9.9	1.00 H	311	48.50	15.60
10	11590.00	50.5 AV	54.0	-3.5	1.00 H	311	34.90	15.60

ANTENNA POLARITY & TEST DISTANCE: VERTICAL AT 3 M

NO.	FREQ. (MHz)	EMISSION LEVEL (dBuV/m)	LIMIT (dBuV/m)	MARGIN (dB)	ANTENNA HEIGHT (m)	TABLE ANGLE (Degree)	RAW VALUE (dBuV)	CORRECTION FACTOR (dB/m)
1	3863.00	46.1 PK	74.0	-27.9	1.00 V	73	46.70	-0.60
2	3863.00	35.9 AV	54.0	-18.1	1.00 V	73	36.50	-0.60
3	*5795.00	104.2 PK			1.23 V	14	63.10	41.10
4	*5795.00	94.0 AV			1.23 V	14	52.90	41.10
5	#5850.00	45.8 PK	78.2	-32.4	1.00 V	31	42.80	3.00
6	#5852.10	58.0 PK	78.2	-20.2	1.00 V	33	55.00	3.00
7	#5860.10	57.8 PK	74.0	-16.2	1.00 V	86	54.80	3.00
8	#5860.10	44.5 AV	54.0	-9.5	1.00 V	86	41.50	3.00
9	11590.00	67.3 PK	74.0	-6.7	1.22 V	22	51.70	15.60
10	11590.00	52.8 AV	54.0	-1.2	1.22 V	22	37.20	15.60

REMARKS:

1. Emission Level(dBuV/m) = Raw Value(dBuV) + Correction Factor(dB/m)
2. Correction Factor(dB/m) = Antenna Factor(dB/m) + Cable Factor(dB)
3. The other emission levels were very low against the limit.
4. Margin value = Emission Level – Limit value
5. " * ": Fundamental frequency.
6. " # ": The radiated frequency is out of the restricted band.

802.11ac (VHT80)_3TX

CHANNEL	TX Channel 155	DETECTOR FUNCTION	Peak (PK)
FREQUENCY RANGE	1GHz ~ 40GHz		Average (AV)

ANTENNA POLARITY & TEST DISTANCE: HORIZONTAL AT 3 M

NO.	FREQ. (MHz)	EMISSION LEVEL (dBuV/m)	LIMIT (dBuV/m)	MARGIN (dB)	ANTENNA HEIGHT (m)	TABLE ANGLE (Degree)	RAW VALUE (dBuV)	CORRECTION FACTOR (dB/m)
1	3850.00	46.5 PK	74.0	-27.5	1.00 H	12	47.20	-0.70
2	3850.00	37.2 AV	54.0	-16.8	1.00 H	12	37.90	-0.70
3	#5714.90	68.6 PK	74.0	-5.4	1.00 H	71	66.00	2.60
4	#5714.90	52.6 AV	54.0	-1.4	1.00 H	71	50.00	2.60
5	#5722.90	73.8 PK	78.2	-4.4	1.00 H	84	71.20	2.60
6	#5725.00	60.0 PK	78.2	-18.2	1.00 H	79	57.40	2.60
7	*5775.00	103.9 PK			1.00 H	85	62.90	41.00
8	*5775.00	94.4 AV			1.00 H	85	53.40	41.00
9	#5850.00	65.3 PK	78.2	-12.9	1.00 H	71	62.30	3.00
10	#5860.10	63.9 PK	74.0	-10.1	1.00 H	83	60.90	3.00
11	#5860.10	49.7 AV	54.0	-4.3	1.00 H	83	46.70	3.00
12	11550.00	59.9 PK	74.0	-14.1	1.00 H	199	44.30	15.60
13	11550.00	46.9 AV	54.0	-7.1	1.00 H	199	31.30	15.60

ANTENNA POLARITY & TEST DISTANCE: VERTICAL AT 3 M

NO.	FREQ. (MHz)	EMISSION LEVEL (dBuV/m)	LIMIT (dBuV/m)	MARGIN (dB)	ANTENNA HEIGHT (m)	TABLE ANGLE (Degree)	RAW VALUE (dBuV)	CORRECTION FACTOR (dB/m)
1	3850.00	46.5 PK	74.0	-27.5	1.00 V	73	47.20	-0.70
2	3850.00	39.1 AV	54.0	-14.9	1.00 V	73	39.80	-0.70
3	#5714.90	69.7 PK	74.0	-4.3	1.01 V	37	67.10	2.60
4	#5714.90	52.6 AV	54.0	-1.4	1.01 V	37	50.00	2.60
5	#5722.90	76.0 PK	78.2	-2.2	1.15 V	18	73.40	2.60
6	#5725.00	60.8 PK	78.2	-17.4	1.26 V	20	58.20	2.60
7	*5775.00	103.5 PK			1.14 V	35	62.50	41.00
8	*5775.00	93.4 AV			1.14 V	35	52.40	41.00
9	#5850.00	62.7 PK	78.2	-15.5	1.00 V	34	59.70	3.00
10	#5860.10	61.7 PK	74.0	-12.3	1.11 V	35	58.70	3.00
11	#5860.10	49.0 AV	54.0	-5.0	1.11 V	35	46.00	3.00
12	11500.00	63.4 PK	74.0	-10.6	1.32 V	29	47.70	15.70
13	11500.00	49.8 AV	54.0	-4.2	1.32 V	29	34.10	15.70

REMARKS:

1. Emission Level(dBuV/m) = Raw Value(dBuV) + Correction Factor(dB/m)
2. Correction Factor(dB/m) = Antenna Factor(dB/m) + Cable Factor(dB)
3. The other emission levels were very low against the limit.
4. Margin value = Emission Level – Limit value
5. " * ": Fundamental frequency.
6. " # ": The radiated frequency is out of the restricted band.

BELOW 1GHz WORST-CASE DATA
802.11ac (VHT20)_2TX

CHANNEL	TX Channel 40	DETECTOR FUNCTION	Quasi-Peak (QP)
FREQUENCY RANGE	30MHz ~ 1GHz		

ANTENNA POLARITY & TEST DISTANCE: HORIZONTAL AT 3 M

NO.	FREQ. (MHz)	EMISSION LEVEL (dBuV/m)	LIMIT (dBuV/m)	MARGIN (dB)	ANTENNA HEIGHT (m)	TABLE ANGLE (Degree)	RAW VALUE (dBuV)	CORRECTION FACTOR (dB/m)
1	80.44	23.3 QP	40.0	-16.7	2.00 H	253	42.00	-18.70
2	119.24	24.9 QP	43.5	-18.6	1.51 H	291	41.60	-16.70
3	156.10	27.9 QP	43.5	-15.6	2.00 H	111	41.80	-13.90
4	249.22	34.3 QP	46.0	-11.7	1.01 H	119	48.80	-14.50
5	524.70	34.6 QP	46.0	-11.4	1.51 H	235	42.80	-8.20
6	901.06	35.3 QP	46.0	-10.7	1.01 H	175	36.60	-1.30

ANTENNA POLARITY & TEST DISTANCE: VERTICAL AT 3 M

NO.	FREQ. (MHz)	EMISSION LEVEL (dBuV/m)	LIMIT (dBuV/m)	MARGIN (dB)	ANTENNA HEIGHT (m)	TABLE ANGLE (Degree)	RAW VALUE (dBuV)	CORRECTION FACTOR (dB/m)
1	33.45	30.7 QP	40.0	-9.3	1.00 V	94	46.50	-15.80
2	49.40	30.4 QP	40.0	-9.6	1.00 V	303	44.90	-14.50
3	107.60	30.7 QP	43.5	-12.8	1.00 V	283	48.30	-17.60
4	249.22	31.4 QP	46.0	-14.6	2.00 V	197	45.90	-14.50
5	524.70	34.2 QP	46.0	-11.8	1.00 V	180	42.40	-8.20
6	895.24	40.7 QP	46.0	-5.3	1.50 V	260	42.10	-1.40

REMARKS:

1. Emission Level(dBuV/m) = Raw Value(dBuV) + Correction Factor(dB/m)
2. Correction Factor(dB/m) = Antenna Factor(dB/m) + Cable Factor(dB)
3. The other emission levels were very low against the limit.
4. Margin value = Emission Level – Limit value

4.2 Conducted Emission Measurement

4.2.1 Limits of Conducted Emission Measurement

Frequency (MHz)	Conducted Limit (dBuV)	
	Quasi-peak	Average
0.15 - 0.5	66 - 56	56 - 46
0.50 - 5.0	56	46
5.0 - 30.0	60	50

Note: 1. The lower limit shall apply at the transition frequencies.

2. The limit decreases in line with the logarithm of the frequency in the range of 0.15 to 0.50MHz.

4.2.2 Test Instruments

Description & Manufacturer	Model No.	Serial No.	Date Of Calibration	Due Date Of Calibration
Test Receiver ROHDE & SCHWARZ	ESCI	100612	Sep. 30, 2014	Sep. 29, 2015
RF signal cable Woken	5D-FB	Cable-HYC01-01	Dec. 26, 2014	Dec. 25, 2015
LISN ROHDE & SCHWARZ (EUT)	ESH3-Z5	847265/023	Oct. 21, 2014	Oct. 20, 2015
LISN ROHDE & SCHWARZ (Peripheral)	ESH3-Z5	100311	Jul. 21, 2014	Jul. 20, 2015
Software ADT	BV ADT_Cond_ V7.3.7.3	NA	NA	NA

NOTE: 1. The calibration interval of the above test instruments is 12 months and the calibrations are traceable to NML/ROC and NIST/USA.

2. The test was performed in HwaYa Shielded Room 1.

3. The VCCI Site Registration No. is C-2040.

4.2.3 Test Procedure

- a. The EUT was placed 0.4 meters from the conducting wall of the shielded room with EUT being connected to the power mains through a line impedance stabilization network (LISN). Other support units were connected to the power mains through another LISN. The two LISNs provide 50 ohm/ 50uH of coupling impedance for the measuring instrument.
- b. Both lines of the power mains connected to the EUT were checked for maximum conducted interference.
- c. The frequency range from 150kHz to 30MHz was searched. Emission levels under (Limit - 20dB) was not recorded.

NOTE: The resolution bandwidth and video bandwidth of test receiver is 9kHz for quasi-peak detection (QP) and average detection (AV) at frequency 0.15MHz-30MHz.

4.2.4 Deviation from Test Standard

No deviation.

4.2.5 Test Setup

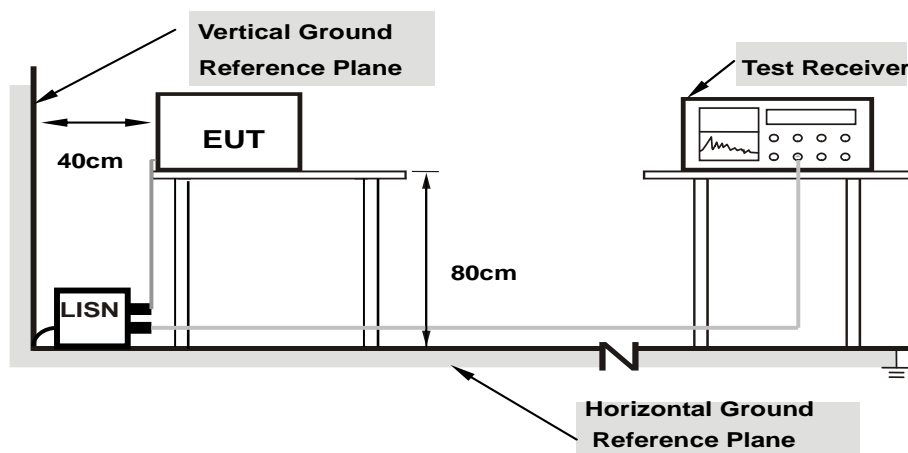

Note: 1.Support units were connected to second LISN.

2.Both of LISNs (AMN) are 80 cm from EUT and at least 80 from other units and other metal planes

For the actual test configuration, please refer to the attached file (Test Setup Photo).

4.2.6 EUT Operating Conditions

Same as 4.1.6.

4.2.7 Test Results

802.11ac (VHT20) 2TX

Phase	Line (L)	Detector Function	Quasi-Peak (QP) / Average (AV)
-------	----------	-------------------	--------------------------------

No	Freq. [MHz]	Corr. Factor (dB)	Reading Value [dB (uV)]		Emission Level [dB (uV)]		Limit [dB (uV)]		Margin (dB)	
			Q.P.	AV.	Q.P.	AV.	Q.P.	AV.	Q.P.	AV.
			1	0.16564	0.08	38.28	20.06	38.36	20.14	65.18
2	0.25166	0.07	33.31	22.29	33.38	22.36	61.70	51.70	-28.32	-29.34
3	0.48041	0.08	37.20	30.08	37.28	30.16	56.33	46.33	-19.05	-16.17
4	0.91616	0.11	27.55	19.77	27.66	19.88	56.00	46.00	-28.34	-26.12
5	1.38557	0.13	17.23	9.10	17.36	9.23	56.00	46.00	-38.64	-36.77
6	16.15754	0.84	24.14	16.56	24.98	17.40	60.00	50.00	-35.02	-32.60

REMARKS:

1. Q.P. and AV. are abbreviations of quasi-peak and average individually.
2. The emission levels of other frequencies were very low against the limit.
3. Margin value = Emission level - Limit value
4. Correction factor = Insertion loss + Cable loss
5. Emission Level = Correction Factor + Reading Value.

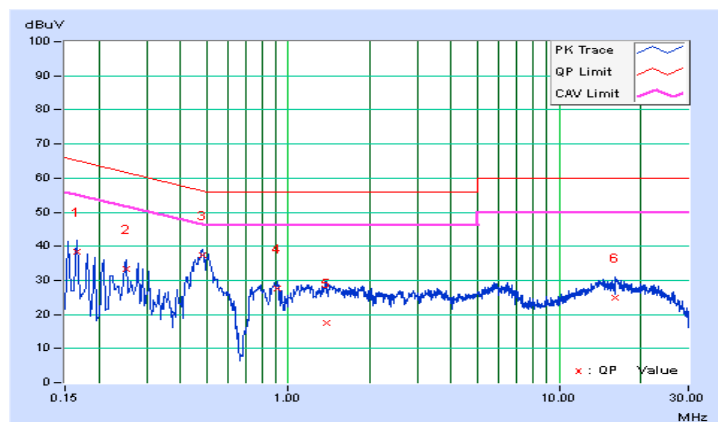

Phase	Neutral (N)	Detector Function	Quasi-Peak (QP) / Average (AV)
-------	-------------	-------------------	--------------------------------

No	Freq. [MHz]	Corr. Factor (dB)	Reading Value		Emission Level		Limit		Margin	
			[dB (uV)]		[dB (uV)]		[dB (uV)]		(dB)	
			Q.P.	AV.	Q.P.	AV.	Q.P.	AV.	Q.P.	AV.
1	0.15391	0.05	39.77	22.88	39.82	22.93	65.79	55.79	-25.97	-32.86
2	0.19301	0.05	37.09	19.50	37.14	19.55	63.91	53.91	-26.77	-34.36
3	0.22820	0.05	36.18	19.45	36.23	19.50	62.51	52.51	-26.28	-33.01
4	0.49408	0.07	35.64	23.28	35.71	23.35	56.10	46.10	-20.39	-22.75
5	0.83034	0.08	18.47	9.61	18.55	9.69	56.00	46.00	-37.45	-36.31
6	3.52433	0.19	17.77	10.18	17.96	10.37	56.00	46.00	-38.04	-35.63

REMARKS:

1. Q.P. and AV. are abbreviations of quasi-peak and average individually.
2. The emission levels of other frequencies were very low against the limit.
3. Margin value = Emission level - Limit value
4. Correction factor = Insertion loss + Cable loss
5. Emission Level = Correction Factor + Reading Value.

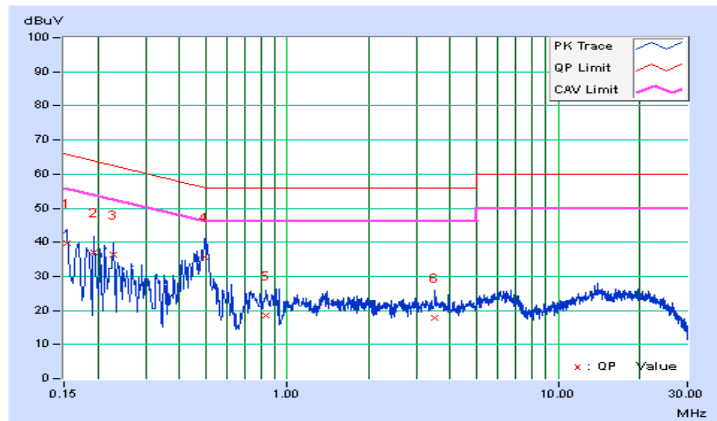

4.3 Transmit Power Measurement

4.3.1 Limits of Transmit Power Measurement

Operation Band	EUT Category		LIMIT
U-NII-1		Outdoor Access Point	1 Watt (30 dBm) (Max. e.i.r.p \leq 125mW(21 dBm) at any elevation angle above 30 degrees as measured from the horizon)
		Fixed point-to-point Access Point	1 Watt (30 dBm)
	√	Indoor Access Point	1 Watt (30 dBm)
		Mobile and Portable client device	250mW (24 dBm)
U-NII-2A	---		250mW (24 dBm) or 11 dBm+10 log B*
U-NII-2C	---		250mW (24 dBm) or 11 dBm+10 log B*
U-NII-3	√		1 Watt (30 dBm)

*B is the 26 dB emission bandwidth in megahertz

Per KDB 662911 Method of conducted output power measurement on IEEE 802.11 devices,

Array Gain = 0 dB (i.e., no array gain) for $N_{ANT} \leq 4$;

Array Gain = 0 dB (i.e., no array gain) for channel widths ≥ 40 MHz for any N_{ANT} ;

Array Gain = $5 \log(N_{ANT}/N_{SS})$ dB or 3 dB, whichever is less for 20-MHz channel widths with $N_{ANT} \geq 5$.

For power measurements on all other devices: Array Gain = $10 \log(N_{ANT}/N_{SS})$ dB.

4.3.2 Test Setup

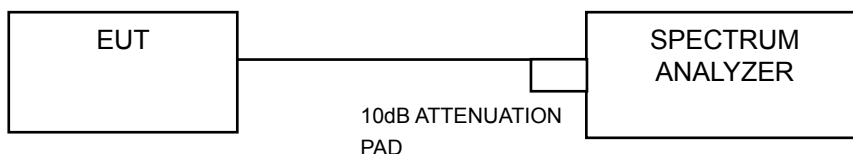
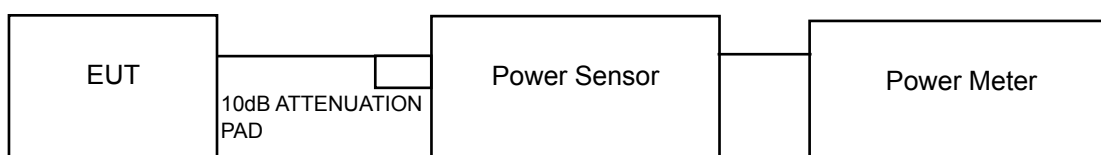

4.3.3 Test Instruments

Refer to section 4.1.2 to get information of above instrument.

4.3.4 Test Procedure

FOR AVERAGE POWER MEASUREMENT

For 802.11a, 802.11n (HT20), 802.11n (HT40), 802.11ac (VHT20), 802.11ac (VHT40)

Method PM is used to perform output power measurement, trigger and gating function of wide band power meter is enabled to measure max output power of TX on burst. Duty factor is not added to measured value.

For 802.11ac (VHT80)

- 1) Set span to encompass the entire 26 dB EBW (or, alternatively, the entire 99% occupied bandwidth) of the signal.
- 2) Set sweep trigger to "free run".
- 3) Set RBW = 1 MHz.
- 4) Set VBW \geq 3 MHz
- 5) Number of points in sweep \geq 2 Span / RBW.
- 6) Sweep time \leq (number of points in sweep) * T
- 7) Using emission bandwidth to determine the frequency span for integration the channel bandwidth.
- 8) Detector = RMS.
- 9) Trace mode = max hold.
- 10) Allow max hold to run for at least 60 seconds, or longer as needed to allow the trace to stabilize.

4.3.5 Deviation from Test Standard

No deviation.

4.3.6 EUT Operating Conditions

The software provided by client to enable the EUT under transmission Condition continuously at lowest, middle and highest channel frequencies individually.

4.3.7 Test Result

POWER OUTPUT:

802.11a_1TX

Channel	Channel Frequency (MHz)	Maximum Conducted Power (mW)	Maximum Conducted Power (dBm)	Power Limit (dBm)	Pass/Fail
36	5180	184.927	22.67	29.87	Pass
40	5200	210.863	23.24	29.87	Pass
48	5240	214.783	23.32	29.87	Pass
149	5745	58.749	17.69	29.87	Pass
157	5785	76.208	18.82	29.87	Pass
165	5825	47.424	16.76	29.87	Pass

*Gain=6.13dBi > 6dBi, so the limit shall be reduced to $30-(6.13-6) = 29.87$ dBm.

802.11n (HT20)_2TX

Chan.	Chan. Freq. (MHz)	Maximum Conducted Power (dBm)		Total Power (mW)	Total Power (dBm)	Power Limit (dBm)	Pass / Fail
		Chain 0	Chain 1				
36	5180	21.00	21.50	267.147	24.27	29.87	Pass
40	5200	22.82	23.33	406.704	26.09	29.87	Pass
48	5240	22.80	22.88	384.635	25.85	29.87	Pass
149	5745	15.52	15.04	67.560	18.30	29.87	Pass
157	5785	15.19	14.66	62.279	17.94	29.87	Pass
165	5825	14.17	14.30	53.037	17.25	29.87	Pass

*Max. Gain=6.13dBi > 6dBi, so the limit shall be reduced to $30-(6.13-6) = 29.87$ dBm.

802.11n (HT40)_2TX

Chan.	Chan. Freq. (MHz)	Maximum Conducted Power (dBm)		Total Power (mW)	Total Power (dBm)	Power Limit (dBm)	Pass / Fail
		Chain 0	Chain 1				
38	5190	18.69	18.81	149.994	21.76	29.87	Pass
46	5230	23.55	23.57	453.974	26.57	29.87	Pass
151	5755	16.98	15.65	86.616	19.38	29.87	Pass
159	5795	17.43	16.29	97.895	19.91	29.87	Pass

*Max. Gain=6.13dBi > 6dBi, so the limit shall be reduced to $30-(6.13-6) = 29.87$ dBm.

802.11ac (VHT20)_2TX

Chan.	Chan. Freq. (MHz)	Maximum Conducted Power (dBm)		Total Power (mW)	Total Power (dBm)	Power Limit (dBm)	Pass / Fail
		Chain 0	Chain 1				
36	5180	21.06	21.51	269.223	24.30	29.87	Pass
40	5200	22.80	23.51	414.934	26.18	29.87	Pass
48	5240	22.81	22.98	389.594	25.91	29.87	Pass
149	5745	15.64	14.78	66.705	18.24	29.87	Pass
157	5785	15.21	15.05	65.178	18.14	29.87	Pass
165	5825	14.16	14.28	52.854	17.23	29.87	Pass

*Max. Gain=6.13dBi > 6dBi, so the limit shall be reduced to $30-(6.13-6) = 29.87$ dBm.

802.11ac (VHT40)_2TX

Chan.	Chan. Freq. (MHz)	Maximum Conducted Power (dBm)		Total Power (mW)	Total Power (dBm)	Power Limit (dBm)	Pass / Fail
		Chain 0	Chain 1				
38	5190	18.76	18.81	151.195	21.80	29.87	Pass
46	5230	23.70	23.68	467.769	26.70	29.87	Pass
151	5755	17.11	15.59	87.628	19.43	29.87	Pass
159	5795	17.39	16.15	96.038	19.82	29.87	Pass

*Max. Gain=6.13dBi > 6dBi, so the limit shall be reduced to $30-(6.13-6) = 29.87$ dBm.

802.11ac (VHT80)_2TX

Chan.	Chan. Freq. (MHz)	Maximum Conducted Power (dBm)		Total Power (mW)	Total Power (dBm)	Power Limit (dBm)	Pass / Fail
		Chain 0	Chain 1				
42	5210	16.12	16.18	82.421	19.16	29.87	Pass
155	5775	15.93	14.40	66.716	18.24	29.87	Pass

*Max. Gain=6.13dBi > 6dBi, so the limit shall be reduced to $30-(6.13-6) = 29.87$ dBm.

802.11n (HT20)_3TX

Chan.	Chan. Freq. (MHz)	Maximum Conducted Power (dBm)			Total Power (mW)	Total Power (dBm)	Power Limit (dBm)	Pass / Fail
		Chain 0	Chain 1	Chain 2				
36	5180	20.31	21.10	20.78	355.898	25.51	29.73	Pass
40	5200	20.35	21.07	20.85	357.950	25.54	29.73	Pass
48	5240	20.83	21.46	20.98	386.333	25.87	29.73	Pass
149	5745	15.66	14.75	13.41	88.595	19.47	29.73	Pass
157	5785	15.28	14.82	12.16	80.512	19.06	29.73	Pass
165	5825	14.27	14.35	12.62	72.238	18.59	29.73	Pass

*Max. Gain=6.27dBi > 6dBi, so the limit shall be reduced to $30-(6.27-6) = 29.73$ dBm.

802.11n (HT40)_3TX

Chan.	Chan. Freq. (MHz)	Maximum Conducted Power (dBm)			Total Power (mW)	Total Power (dBm)	Power Limit (dBm)	Pass / Fail
		Chain 0	Chain 1	Chain 2				
38	5190	18.31	18.46	18.03	201.443	23.04	29.73	Pass
46	5230	23.44	23.45	23.12	647.225	28.11	29.73	Pass
151	5755	17.24	15.80	14.71	120.565	20.81	29.73	Pass
159	5795	17.03	15.78	13.83	112.465	20.51	29.73	Pass

*Max. Gain=6.27dBi > 6dBi, so the limit shall be reduced to $30-(6.27-6) = 29.73$ dBm.

802.11ac (VHT20)_3TX

Chan.	Chan. Freq. (MHz)	Maximum Conducted Power (dBm)			Total Power (mW)	Total Power (dBm)	Power Limit (dBm)	Pass / Fail
		Chain 0	Chain 1	Chain 2				
36	5180	20.53	21.30	20.84	369.215	25.67	29.73	Pass
40	5200	20.48	21.40	20.87	371.904	25.70	29.73	Pass
48	5240	20.74	21.33	20.92	378.003	25.77	29.73	Pass
149	5745	15.62	14.86	13.58	89.898	19.54	29.73	Pass
157	5785	14.66	14.01	11.76	69.416	18.41	29.73	Pass
165	5825	14.21	14.29	12.72	71.923	18.57	29.73	Pass

*Max. Gain=6.27dBi > 6dBi, so the limit shall be reduced to $30-(6.27-6) = 29.73$ dBm.

802.11ac (VHT40)_3TX

Chan.	Chan. Freq. (MHz)	Maximum Conducted Power (dBm)			Total Power (mW)	Total Power (dBm)	Power Limit (dBm)	Pass / Fail
		Chain 0	Chain 1	Chain 2				
38	5190	18.29	18.52	18.10	203.139	23.08	29.73	Pass
46	5230	23.22	23.52	23.16	641.813	28.07	29.73	Pass
151	5755	17.24	15.72	14.56	118.867	20.75	29.73	Pass
159	5795	16.81	15.80	13.88	110.426	20.43	29.73	Pass

*Max. Gain=6.27dBi > 6dBi, so the limit shall be reduced to $30-(6.27-6) = 29.73$ dBm.

802.11ac (VHT80)_3TX

Chan.	Chan. Freq. (MHz)	Maximum Conducted Power (dBm)			Total Power (mW)	Total Power (dBm)	Power Limit (dBm)	Pass / Fail
		Chain 0	Chain 1	Chain 2				
42	5210	15.14	15.38	14.69	96.617	19.85	29.73	Pass
155	5775	16.04	14.37	12.70	86.153	19.35	29.73	Pass

*Max. Gain=6.27dBi > 6dBi, so the limit shall be reduced to $30-(6.27-6) = 29.73$ dBm.



A D T

SPECTRUM PLOT OF WORST VALUE

802.11ac (VHT80)_2TX

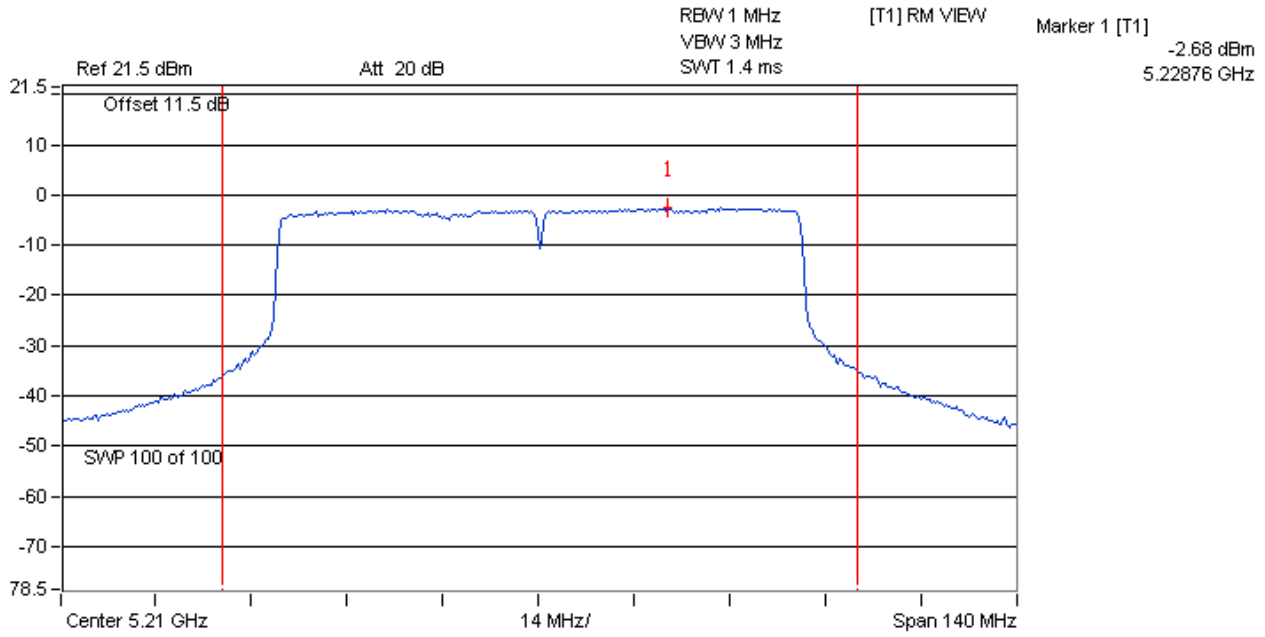

TX Channel
Bandwidth

93.28 MHz

Power 16.18 dBm



A D T

26dB BANDWIDTH:
802.11a_1TX

Channel	Channel Frequency (MHz)	26dBc Bandwidth (MHz)	Pass / Fail
36	5180	26.00	PASS
40	5200	28.28	PASS
48	5240	28.53	PASS

802.11n (HT20)_2TX

Channel	Channel Frequency (MHz)	26dBc Bandwidth (MHz)		Pass / Fail
		Chain 0	Chain 1	
36	5180	23.19	23.40	PASS
40	5200	28.01	25.97	PASS
48	5240	28.02	25.31	PASS

802.11n (HT40)_2TX

Channel	Channel Frequency (MHz)	26dBc Bandwidth (MHz)		Pass / Fail
		Chain 0	Chain 1	
38	5190	46.85	46.14	PASS
46	5230	70.22	50.98	PASS

802.11ac (VHT20)_2TX

Channel	Channel Frequency (MHz)	26dBc Bandwidth (MHz)		Pass / Fail
		Chain 0	Chain 1	
36	5180	23.35	24.19	PASS
40	5200	29.03	27.14	PASS
48	5240	27.30	25.21	PASS

802.11ac (VHT40)_2TX

Channel	Channel Frequency (MHz)	26dBc Bandwidth (MHz)		Pass / Fail
		Chain 0	Chain 1	
38	5190	45.68	46.37	PASS
46	5230	66.50	54.64	PASS

802.11ac (HT80)_2TX

Channel	Channel Frequency (MHz)	26dBc Bandwidth (MHz)		Pass / Fail
		Chain 0	Chain 1	
42	5210	89.43	93.28	PASS

802.11n (HT20)_3TX

Channel	Channel Frequency (MHz)	26dBc Bandwidth (MHz)			Pass / Fail
		Chain 0	Chain 1	Chain 2	
36	5180	23.51	22.86	22.97	PASS
40	5200	25.24	24.22	22.94	PASS
48	5240	26.71	25.24	23.90	PASS

802.11n (HT40)_3TX

Channel	Channel Frequency (MHz)	26dBc Bandwidth (MHz)			Pass / Fail
		Chain 0	Chain 1	Chain 2	
38	5190	46.52	45.23	45.94	PASS
46	5230	69.50	49.23	46.10	PASS

802.11ac (VHT20)_3TX

Channel	Channel Frequency (MHz)	26dBc Bandwidth (MHz)			Pass / Fail
		Chain 0	Chain 1	Chain 2	
36	5180	23.59	23.25	23.07	PASS
40	5200	24.68	24.91	23.14	PASS
48	5240	26.60	26.34	23.24	PASS

802.11ac (VHT40)_3TX

Channel	Channel Frequency (MHz)	26dBc Bandwidth (MHz)			Pass / Fail
		Chain 0	Chain 1	Chain 2	
38	5190	46.38	46.04	44.95	PASS
46	5230	65.91	52.51	48.88	PASS

802.11ac (VHT80)_3TX

Channel	Channel Frequency (MHz)	26dBc Bandwidth (MHz)			Pass / Fail
		Chain 0	Chain 1	Chain 2	
42	5210	89.83	89.34	87.99	PASS

SPECTRUM PLOT OF WORST VALUE

802.11a_1TX

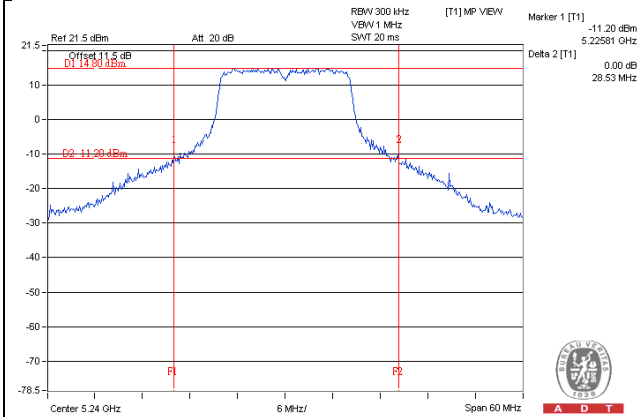

802.11n (HT20)_2TX

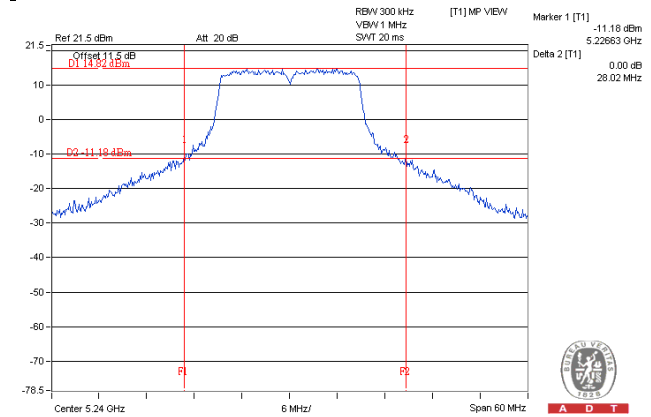

802.11n (HT40)_2TX

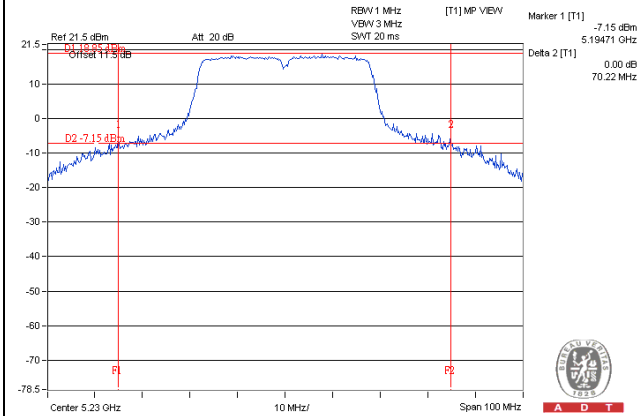

802.11ac (VHT20)_2TX

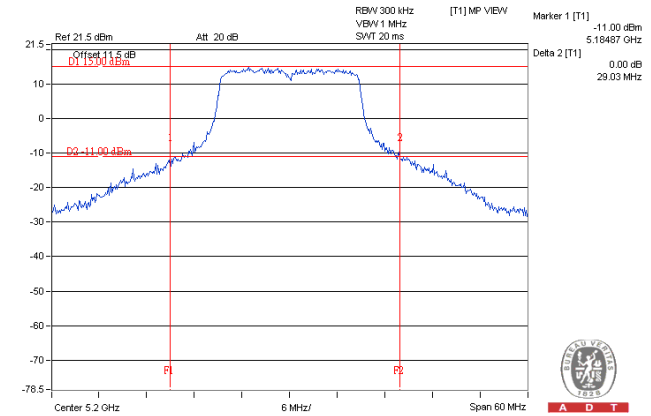

802.11ac (VHT40)_2TX

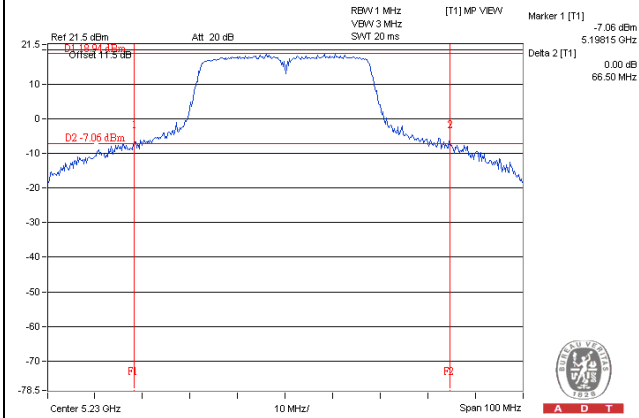

802.11ac (VHT80)_2TX

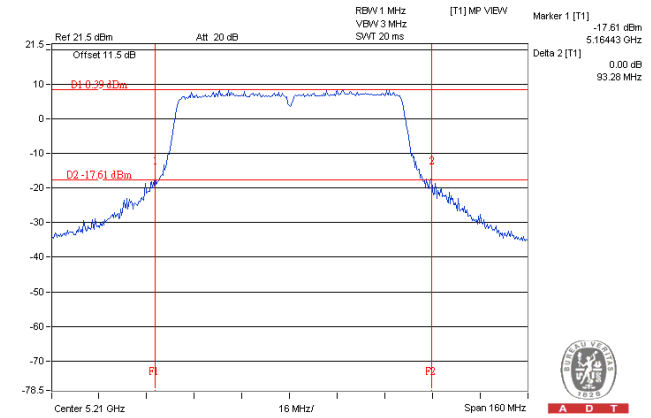

SPECTRUM PLOT OF WORST VALUE

802.11n (HT20)_3TX

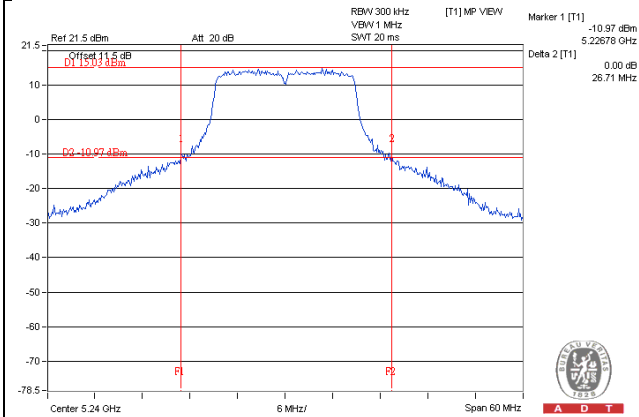

802.11n (HT40)_3TX

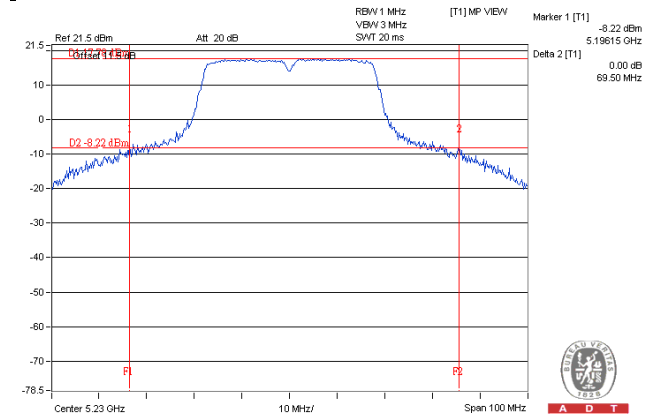

802.11ac (VHT20)_3TX

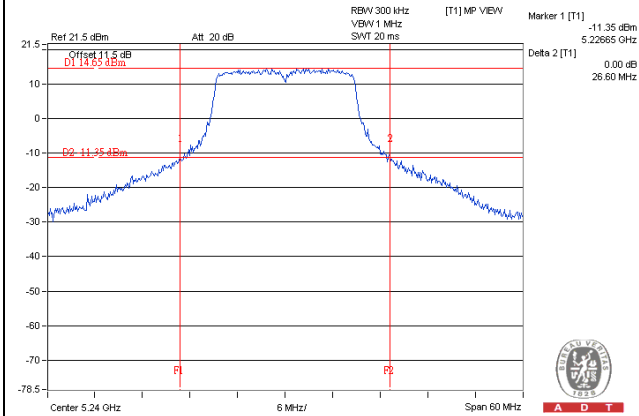

802.11ac (VHT40)_3TX

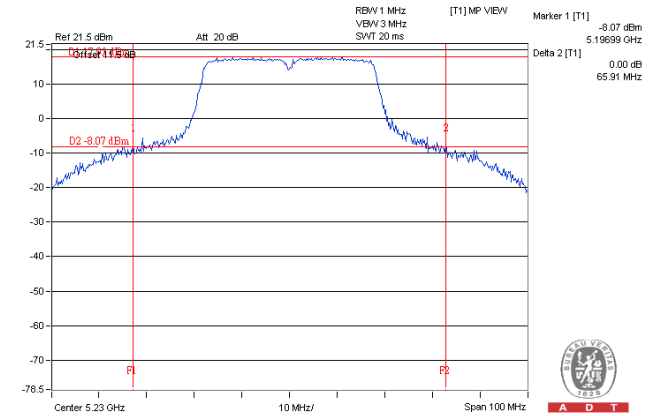

802.11ac (VHT80)_3TX

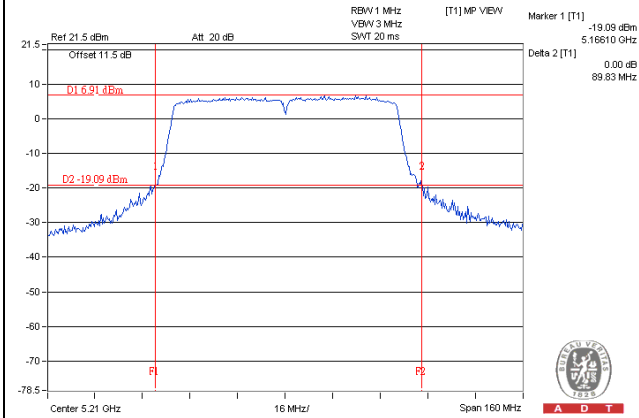

4.4 Peak Power Spectral Density Measurement

4.4.1 Limits of Peak Power Spectral Density Measurement

Operation Band	EUT Category		LIMIT
U-NII-1		Outdoor Access Point	17dBm/ MHz
		Fixed point-to-point Access Point	
	√	Indoor Access Point	
		Mobile and Portable client device	11dBm/ MHz
U-NII-2A	---		11dBm/ MHz
U-NII-2C	---		11dBm/ MHz
U-NII-3	√		30dBm/ 500kHz

4.4.2 Test Setup

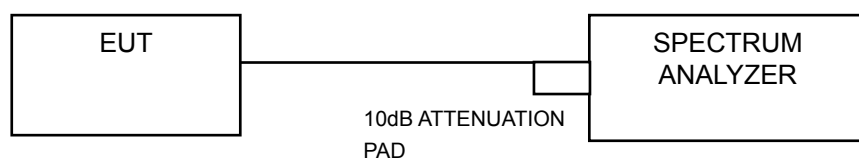

4.4.3 Test Instruments

Refer to section 4.1.2 to get information of above instrument.

4.4.4 Test Procedure

For U-NII-1 band:

Using method SA-1

- 1) Set span to encompass the entire emission bandwidth (EBW) of the signal.
- 2) Set RBW = 30 kHz, Set VBW ≥ 1 MHz, Detector = RMS
- 3) Set Channel power measure = 1MHz
- 4) Sweep time = auto, trigger set to “free run”.
- 5) Trace average at least 100 traces in power averaging mode.
- 6) Record the max value

For U-NII-3 band:

- 1) Set span to encompass the entire emission bandwidth (EBW) of the signal.
- 2) Set RBW = 500 kHz, Set VBW ≥ 3 RBW, Detector = RMS
- 3) Sweep time = auto, trigger set to “free run”.
- 4) Trace average at least 100 traces in power averaging mode.
- 5) Record the max value and add $10 \log(1/\text{duty cycle})$
- 6) Scale the observed power level to an equivalent value in 500 kHz by adjusting (reducing) the measured power by a bandwidth correction factor (BWCF) where $BWCF = 10 \log(500\text{kHz}/300\text{kHz})$

4.4.5 Deviation from Test Standard

No deviation.

4.4.6 EUT Operating Condition

Same as Item 4.3.6.

4.4.7 Test Results

For U-NII-1 Band

802.11a_1TX

Channel	Frequency (MHz)	PSD (dBm)	Maximum Limit (dBm)	Pass/Fail
36	5180	9.01	16.87	Pass
40	5200	9.46	16.87	Pass
48	5240	9.56	16.87	Pass

NOTE: 1. Method 1 of power density measurement of KDB 662911 is using for calculating total power density. Total power density is summing entire spectra across corresponding frequency bins on the various outputs by computer.

2. For U-NII-1 Band:

Gain = 6.13 dBi > 6dBi, so the power density limit shall be reduced to $17-(6.13-6) = 16.87\text{dBm}$.

802.11n (HT20)_2TX

Chan.	Chan. Freq. (MHz)	PSD (dBm)		Total Power Density (dBm)	Max. Limit (dBm)	Pass/Fail
		Chain 0	Chain 1			
36	5180	7.48	8.24	10.89	13.94	Pass
40	5200	9.49	10.16	12.85	13.94	Pass
48	5240	9.17	9.56	12.38	13.94	Pass

NOTE: 1. Method 1 of power density measurement of KDB 662911 is using for calculating total power density. Total power density is summing entire spectra across corresponding frequency bins on the various outputs by computer.

2. For U-NII-1 Band:

Directional gain = $10 \log[(10^{G1/20} + 10^{G2/20} + \dots + 10^{GN/20})^2/2] = 9.06 \text{ dBi} > 6\text{dBi}$, so the power density limit shall be reduced to $17-(9.06-6) = 13.94\text{dBm}$.

802.11n (HT40)_2TX

Chan.	Chan. Freq. (MHz)	PSD (dBm)		Total Power Density (dBm)	Max. Limit (dBm)	Pass/Fail
		Chain 0	Chain 1			
38	5190	2.03	2.34	5.20	13.94	Pass
46	5230	6.90	7.24	10.08	13.94	Pass

NOTE: 1. Method 1 of power density measurement of KDB 662911 is using for calculating total power density. Total power density is summing entire spectra across corresponding frequency bins on the various outputs by computer.

2. For U-NII-1 Band:

Directional gain = $10 \log[(10^{G1/20} + 10^{G2/20} + \dots + 10^{GN/20})^2/2] = 9.06 \text{ dBi} > 6\text{dBi}$, so the power density limit shall be reduced to $17-(9.06-6) = 13.94\text{dBm}$.

802.11ac (VHT20)_2TX

Chan.	Chan. Freq. (MHz)	PSD (dBm)		Total Power Density (dBm)	Max. Limit (dBm)	Pass/Fail
		Chain 0	Chain 1			
36	5180	7.07	7.83	10.48	13.94	Pass
40	5200	9.20	10.13	12.70	13.94	Pass
48	5240	9.30	9.81	12.57	13.94	Pass

NOTE: 1. Method 1 of power density measurement of KDB 662911 is using for calculating total power density. Total power density is summing entire spectra across corresponding frequency bins on the various outputs by computer.

2. For U-NII-1 Band:

Directional gain = $10 \log[(10^{G1/20} + 10^{G2/20} + \dots + 10^{GN/20})^2/2]$ = 9.06 dBi > 6dBi, so the power density limit shall be reduced to $17-(9.06-6) = 13.94$ dBm.

802.11ac (VHT40)_2TX

Chan.	Chan. Freq. (MHz)	PSD (dBm)		Total Power Density (dBm)	Max. Limit (dBm)	Pass/Fail
		Chain 0	Chain 1			
38	5190	1.93	2.39	5.18	13.94	Pass
46	5230	6.74	7.03	9.90	13.94	Pass

NOTE: 1. Method 1 of power density measurement of KDB 662911 is using for calculating total power density. Total power density is summing entire spectra across corresponding frequency bins on the various outputs by computer.

2. For U-NII-1 Band:

Directional gain = $10 \log[(10^{G1/20} + 10^{G2/20} + \dots + 10^{GN/20})^2/2]$ = 9.06 dBi > 6dBi, so the power density limit shall be reduced to $17-(9.06-6) = 13.94$ dBm.

802.11ac (VHT80)_2TX

Chan.	Chan. Freq. (MHz)	PSD (dBm)		Total Power Density (dBm)	Max. Limit (dBm)	Pass/Fail
		Chain 0	Chain 1			
42	5210	-4.03	-3.51	-0.75	13.94	Pass

NOTE: 1. Method 1 of power density measurement of KDB 662911 is using for calculating total power density. Total power density is summing entire spectra across corresponding frequency bins on the various outputs by computer.

2. For U-NII-1 Band:

Directional gain = $10 \log[(10^{G1/20} + 10^{G2/20} + \dots + 10^{GN/20})^2/2]$ = 9.06 dBi > 6dBi, so the power density limit shall be reduced to $17-(9.06-6) = 13.94$ dBm.

802.11n (HT20)_3TX

Chan.	Chan. Freq. (MHz)	PSD (dBm)			Total Power Density (dBm)	Max. Limit (dBm)	Pass/Fail
		Chain 0	Chain 1	Chain 2			
36	5180	7.01	7.02	6.52	11.63	12.11	Pass
40	5200	7.36	7.03	7.25	11.99	12.11	Pass
48	5240	7.62	7.09	7.21	12.08	12.11	Pass

NOTE: 1. Method 1 of power density measurement of KDB 662911 is using for calculating total power density. Total power density is summing entire spectra across corresponding frequency bins on the various outputs by computer.

2. For U-NII-1 Band:

Directional gain = $10 \log[(10^{G1/20} + 10^{G2/20} + \dots + 10^{GN/20})^2/3]$ = 10.89 dBi > 6dBi , so the power density limit shall be reduced to $17-(10.89-6) = 12.11$ dBm.

802.11n (HT40)_3TX

Chan.	Chan. Freq. (MHz)	PSD (dBm)			Total Power Density (dBm)	Max. Limit (dBm)	Pass/Fail
		Chain 0	Chain 1	Chain 2			
38	5190	1.53	1.65	0.77	6.11	12.11	Pass
46	5230	6.61	6.78	6.23	11.32	12.11	Pass

NOTE: 1. Method 1 of power density measurement of KDB 662911 is using for calculating total power density. Total power density is summing entire spectra across corresponding frequency bins on the various outputs by computer.

2. For U-NII-1 Band:

Directional gain = $10 \log[(10^{G1/20} + 10^{G2/20} + \dots + 10^{GN/20})^2/3]$ = 10.89 dBi > 6dBi , so the power density limit shall be reduced to $17-(10.89-6) = 12.11$ dBm.

802.11ac (VHT20)_3TX

Chan.	Chan. Freq. (MHz)	PSD (dBm)			Total Power Density (dBm)	Max. Limit (dBm)	Pass/Fail
		Chain 0	Chain 1	Chain 2			
36	5180	6.84	7.82	6.78	11.94	12.11	Pass
40	5200	6.85	7.87	6.67	11.93	12.11	Pass
48	5240	6.88	7.77	6.90	11.97	12.11	Pass

NOTE: 1. Method 1 of power density measurement of KDB 662911 is using for calculating total power density. Total power density is summing entire spectra across corresponding frequency bins on the various outputs by computer.

2. For U-NII-1 Band:

Directional gain = $10 \log[(10^{G1/20} + 10^{G2/20} + \dots + 10^{GN/20})^2/3]$ = 10.89 dBi > 6dBi , so the power density limit shall be reduced to $17-(10.89-6) = 12.11$ dBm.

802.11ac (VHT40)_3TX

Chan.	Chan. Freq. (MHz)	PSD (dBm)			Total Power Density (dBm)	Max. Limit (dBm)	Pass/Fail
		Chain 0	Chain 1	Chain 2			
38	5190	1.54	2.08	1.02	6.34	12.11	Pass
46	5230	6.35	6.89	6.48	11.35	12.11	Pass

NOTE: 1. Method 1 of power density measurement of KDB 662911 is using for calculating total power density. Total power density is summing entire spectra across corresponding frequency bins on the various outputs by computer.

2. For U-NII-1 Band:

Directional gain = $10 \log[(10^{G1/20} + 10^{G2/20} + \dots + 10^{GN/20})^2/3]$ = 10.89 dBi > 6dBi , so the power density limit shall be reduced to $17-(10.89-6) = 12.11$ dBm.

802.11n (VHT80)_3TX

Chan.	Chan. Freq. (MHz)	PSD (dBm)			Total Power Density (dBm)	Max. Limit (dBm)	Pass/Fail
		Chain 0	Chain 1	Chain 2			
42	5210	-4.89	-4.49	-5.26	-0.10	12.11	Pass

NOTE: 1. Method 1 of power density measurement of KDB 662911 is using for calculating total power density. Total power density is summing entire spectra across corresponding frequency bins on the various outputs by computer.

2. For U-NII-1 Band:

Directional gain = $10 \log[(10^{G1/20} + 10^{G2/20} + \dots + 10^{GN/20})^2/3]$ = 10.89 dBi > 6dBi , so the power density limit shall be reduced to $17-(10.89-6) = 12.11$ dBm.

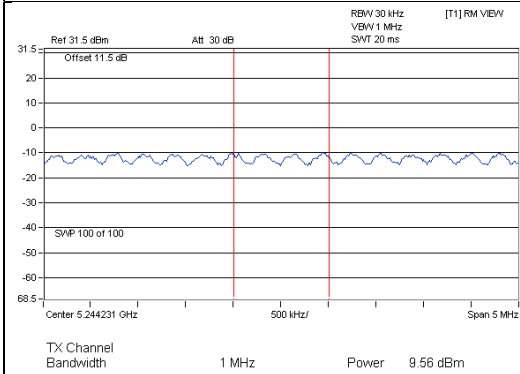
SPECTRUM PLOT OF WORST VALUE**802.11a_1TX**

A D T

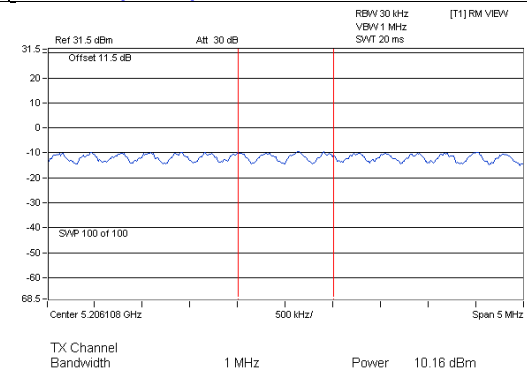
802.11n (HT20)_2TX

A D T

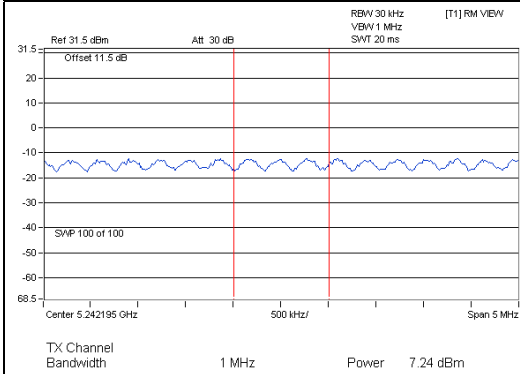
802.11n (HT40)_2TX

A D T

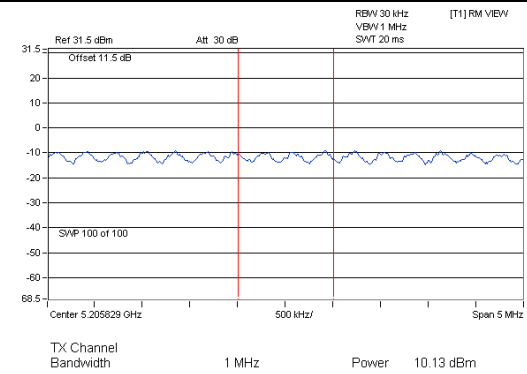
802.11ac (VHT20)_2TX

A D T

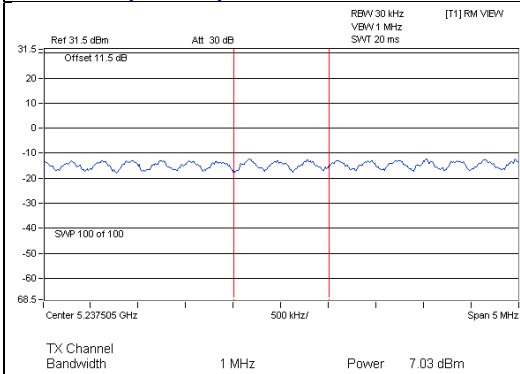
802.11ac (VHT40)_2TX

A D T

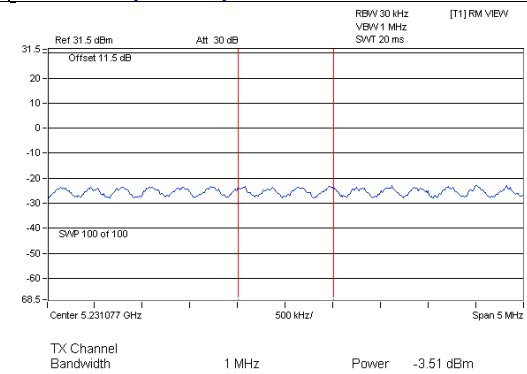
802.11ac (VHT80)_2TX

A D T

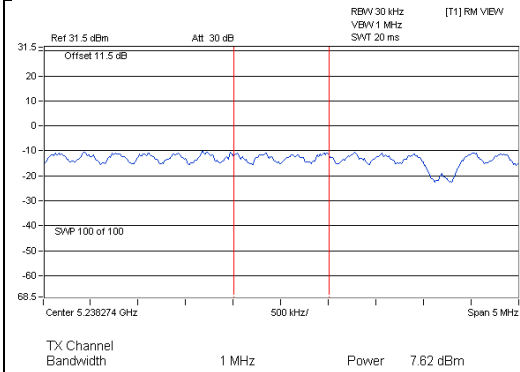
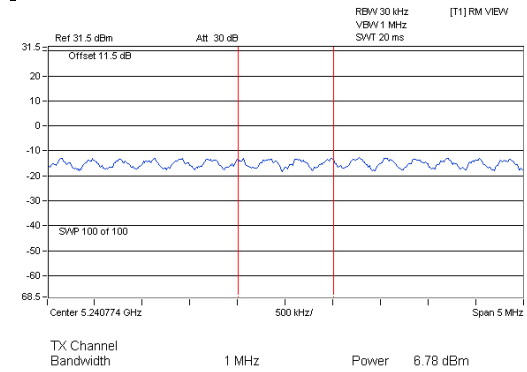
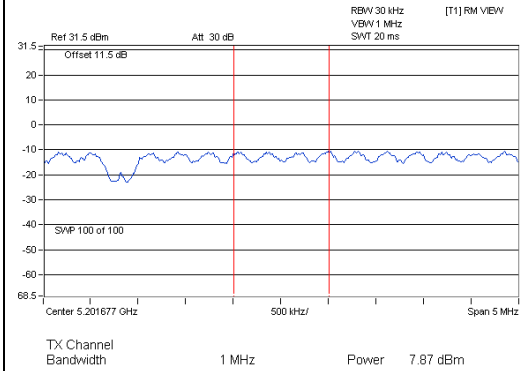
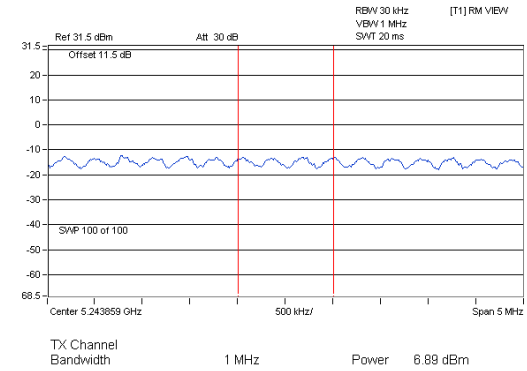
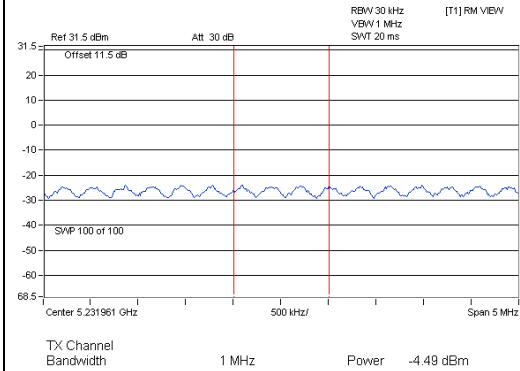
SPECTRUM PLOT OF WORST VALUE**802.11n (HT20)_3TX****802.11n (HT40)_3TX****802.11ac (VHT20)_3TX****802.11ac (VHT40)_3TX****802.11ac (VHT80)_3TX**

For U-NII-3 Band

802.11a_1TX

Channel	Freq. (MHz)	PSD (dBm/300kHz)	PSD (dBm/500kHz)	Limit (dBm/500kHz)	Pass /Fail
149	5745	-3.56	-1.34	29.87	Pass
157	5785	-2.48	-0.26	29.87	Pass
165	5825	-4.46	-2.24	29.87	Pass

* Gain = 6.13 dBi > 6dBi, so the power density limit shall be reduced to $30-(6.13-6) = 29.87\text{dBm}$.

802.11n (HT20)_2TX

TX chain	Channel	Freq. (MHz)	PSD (dBm/300k Hz)	PSD (dBm/500k Hz)	10 log (N=2) dB	Total PSD (dBm/500k Hz)	Limit (dBm/500k Hz)	Pass /Fail
0	149	5745	-6.01	-3.79	3.01	-0.78	26.94	Pass
	157	5785	-6.33	-4.11	3.01	-1.10	26.94	Pass
	165	5825	-7.66	-5.44	3.01	-2.43	26.94	Pass
1	149	5745	-6.39	-4.17	3.01	-1.16	26.94	Pass
	157	5785	-6.73	-4.51	3.01	-1.50	26.94	Pass
	165	5825	-7.00	-4.78	3.01	-1.77	26.94	Pass

NOTE: Directional gain = $10 \log[(10^{G1/20} + 10^{G2/20} + \dots + 10^{GN/20})^2/2] = 9.06 \text{ dBi} > 6\text{dBi}$, so the power density limit shall be reduced to $30-(9.06-6) = 26.94\text{dBm}$.

802.11n (HT40)_2TX

TX chain	Channel	Freq. (MHz)	PSD (dBm/300k Hz)	PSD (dBm/500k Hz)	10 log (N=2) dB	Total PSD (dBm/500k Hz)	Limit (dBm/500k Hz)	Pass /Fail
0	151	5755	-7.68	-5.46	3.01	-2.45	26.94	Pass
	159	5795	-7.48	-5.26	3.01	-2.25	26.94	Pass
1	151	5755	-9.03	-6.81	3.01	-3.80	26.94	Pass
	159	5795	-8.37	-6.15	3.01	-3.14	26.94	Pass

NOTE: Directional gain = $10 \log[(10^{G1/20} + 10^{G2/20} + \dots + 10^{GN/20})^2/2] = 9.06 \text{ dBi} > 6\text{dBi}$, so the power density limit shall be reduced to $30-(9.06-6) = 26.94\text{dBm}$.

802.11ac (VHT20)_2TX

TX chain	Channel	Freq. (MHz)	PSD (dBm/300k Hz)	PSD (dBm/500k Hz)	10 log (N=2) dB	Total PSD (dBm/500k Hz)	Limit (dBm/500k Hz)	Pass /Fail
0	149	5745	-5.93	-3.71	3.01	-0.70	26.94	Pass
	157	5785	-6.44	-4.22	3.01	-1.21	26.94	Pass
	165	5825	-7.27	-5.05	3.01	-2.04	26.94	Pass
1	149	5745	-6.33	-4.11	3.01	-1.10	26.94	Pass
	157	5785	-6.97	-4.75	3.01	-1.74	26.94	Pass
	165	5825	-7.08	-4.86	3.01	-1.85	26.94	Pass

NOTE: Directional gain = $10 \log[(10^{G1/20} + 10^{G2/20} + \dots + 10^{GN/20})^2/2] = 9.06 \text{ dBi} > 6\text{dBi}$, so the power density limit shall be reduced to $30-(9.06-6) = 26.94\text{dBm}$.

802.11ac (VHT40)_2TX

TX chain	Channel	Freq. (MHz)	PSD (dBm/300k Hz)	PSD (dBm/500k Hz)	10 log (N=2) dB	Total PSD (dBm/500k Hz)	Limit (dBm/500k Hz)	Pass /Fail
0	151	5755	-7.59	-5.37	3.01	-2.36	26.94	Pass
	159	5795	-7.43	-5.21	3.01	-2.20	26.94	Pass
1	151	5755	-9.06	-6.84	3.01	-3.83	26.94	Pass
	159	5795	-8.68	-6.46	3.01	-3.45	26.94	Pass

NOTE: Directional gain = $10 \log[(10^{G1/20} + 10^{G2/20} + \dots + 10^{GN/20})^2/2] = 9.06 \text{ dBi} > 6\text{dBi}$, so the power density limit shall be reduced to $30-(9.06-6) = 26.94\text{dBm}$.

802.11ac (VHT80)_2TX

TX chain	Channel	Freq. (MHz)	PSD (dBm/300k Hz)	PSD (dBm/500k Hz)	10 log (N=2) dB	Total PSD (dBm/500k Hz)	Limit (dBm/500k Hz)	Pass /Fail
0	155	5775	-12.35	-10.13	3.01	-7.12	26.94	Pass
1	155	5775	-13.14	-10.92	3.01	-7.91	26.94	Pass

NOTE: Directional gain = $10 \log[(10^{G1/20} + 10^{G2/20} + \dots + 10^{GN/20})^2/2] = 9.06 \text{ dBi} > 6\text{dBi}$, so the power density limit shall be reduced to $30-(9.06-6) = 26.94\text{dBm}$.

802.11n (HT20)_3TX

TX chain	Channel	Freq. (MHz)	PSD (dBm/300k Hz)	PSD (dBm/500k Hz)	10 log (N=3) dB	Total PSD (dBm/500k Hz)	Limit (dBm/500k Hz)	Pass /Fail
0	149	5745	-5.98	-3.76	4.77	1.01	25.11	Pass
	157	5785	-6.21	-3.99	4.77	0.78	25.11	Pass
	165	5825	-7.12	-4.90	4.77	-0.13	25.11	Pass
1	149	5745	-6.08	-3.86	4.77	0.91	25.11	Pass
	157	5785	-6.30	-4.08	4.77	0.69	25.11	Pass
	165	5825	-7.27	-5.05	4.77	-0.28	25.11	Pass
2	149	5745	-7.81	-5.59	4.77	-0.82	25.11	Pass
	157	5785	-9.30	-7.08	4.77	-2.31	25.11	Pass
	165	5825	-8.76	-6.54	4.77	-1.77	25.11	Pass

NOTE: Directional gain = $10 \log[(10^{G1/20} + 10^{G2/20} + \dots + 10^{GN/20})^2/3] = 10.89 \text{ dBi} > 6 \text{ dBi}$, so the power density limit shall be reduced to $30 - (10.89 - 6) = 25.11 \text{ dBm}$.

802.11n (HT40)_3TX

TX chain	Channel	Freq. (MHz)	PSD (dBm/300k Hz)	PSD (dBm/500k Hz)	10 log (N=3) dB	Total PSD (dBm/500k Hz)	Limit (dBm/500k Hz)	Pass /Fail
0	151	5755	-7.49	-5.27	4.77	-0.50	25.11	Pass
	159	5795	-7.89	-5.67	4.77	-0.90	25.11	Pass
1	151	5755	-8.44	-6.22	4.77	-1.45	25.11	Pass
	159	5795	-8.76	-6.54	4.77	-1.77	25.11	Pass
2	151	5755	-10.22	-8.00	4.77	-3.23	25.11	Pass
	159	5795	-10.57	-8.35	4.77	-3.58	25.11	Pass

NOTE: Directional gain = $10 \log[(10^{G1/20} + 10^{G2/20} + \dots + 10^{GN/20})^2/3] = 10.89 \text{ dBi} > 6 \text{ dBi}$, so the power density limit shall be reduced to $30 - (10.89 - 6) = 25.11 \text{ dBm}$.

802.11ac (VHT20)_3TX

TX chain	Channel	Freq. (MHz)	PSD (dBm/300k Hz)	PSD (dBm/500k Hz)	10 log (N=3) dB	Total PSD (dBm/500k Hz)	Limit (dBm/500k Hz)	Pass /Fail
0	149	5745	-5.43	-3.21	4.77	1.56	25.11	Pass
	157	5785	-6.56	-4.34	4.77	0.43	25.11	Pass
	165	5825	-7.44	-5.22	4.77	-0.45	25.11	Pass
1	149	5745	-5.93	-3.71	4.77	1.06	25.11	Pass
	157	5785	-6.78	-4.56	4.77	0.21	25.11	Pass
	165	5825	-7.01	-4.79	4.77	-0.02	25.11	Pass
2	149	5745	-7.87	-5.65	4.77	-0.88	25.11	Pass
	157	5785	-9.49	-7.27	4.77	-2.50	25.11	Pass
	165	5825	-8.35	-6.13	4.77	-1.36	25.11	Pass

NOTE: Directional gain = $10 \log[(10^{G1/20} + 10^{G2/20} + \dots + 10^{GN/20})^2/3] = 10.89 \text{ dBi} > 6 \text{ dBi}$, so the power density limit shall be reduced to $30 - (10.89 - 6) = 25.11 \text{ dBm}$.

802.11ac (VHT40)_3TX

TX chain	Channel	Freq. (MHz)	PSD (dBm/300k Hz)	PSD (dBm/500k Hz)	10 log (N=3) dB	Total PSD (dBm/500k Hz)	Limit (dBm/500k Hz)	Pass /Fail
0	151	5755	-7.52	-5.30	4.77	-0.53	25.11	Pass
	159	5795	-7.65	-5.43	4.77	-0.66	25.11	Pass
1	151	5755	-8.48	-6.26	4.77	-1.49	25.11	Pass
	159	5795	-9.05	-6.83	4.77	-2.06	25.11	Pass
2	151	5755	-9.84	-7.62	4.77	-2.85	25.11	Pass
	159	5795	-10.79	-8.57	4.77	-3.80	25.11	Pass

NOTE: Directional gain = $10 \log[(10^{G1/20} + 10^{G2/20} + \dots + 10^{GN/20})^2/3] = 10.89 \text{ dBi} > 6 \text{ dBi}$, so the power density limit shall be reduced to $30 - (10.89 - 6) = 25.11 \text{ dBm}$.

802.11ac (VHT80)_3TX

TX chain	Channel	Freq. (MHz)	PSD (dBm/300k Hz)	PSD (dBm/500k Hz)	10 log (N=3) dB	Total PSD (dBm/500k Hz)	Limit (dBm/500k Hz)	Pass /Fail
0	155	5775	-12.25	-10.03	4.77	-5.26	25.11	Pass
1	155	5775	-13.23	-11.01	4.77	-6.24	25.11	Pass
2	155	5775	-14.83	-12.61	4.77	-7.84	25.11	Pass

NOTE: Directional gain = $10 \log[(10^{G1/20} + 10^{G2/20} + \dots + 10^{GN/20})^2/3] = 10.89 \text{ dBi} > 6 \text{ dBi}$, so the power density limit shall be reduced to $30 - (10.89 - 6) = 25.11 \text{ dBm}$.

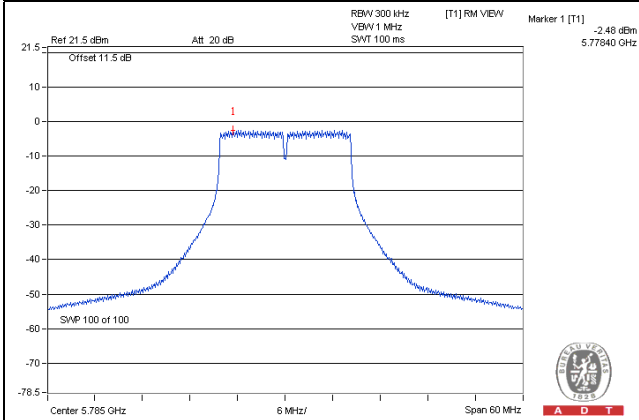
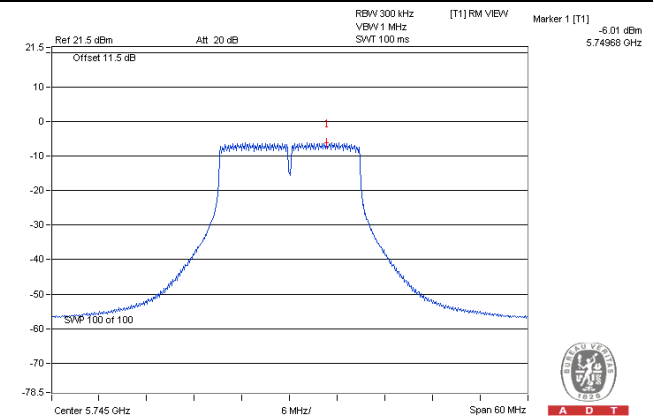
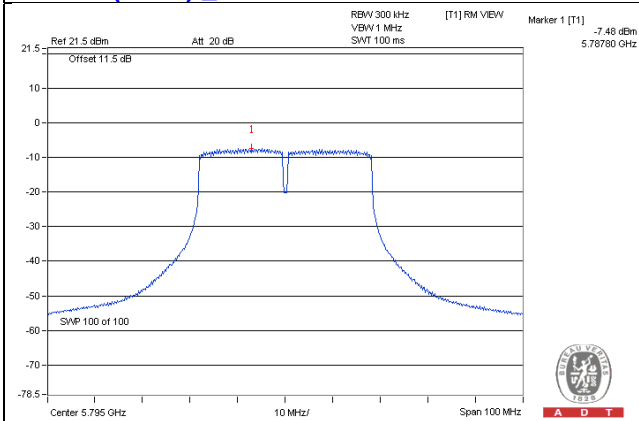
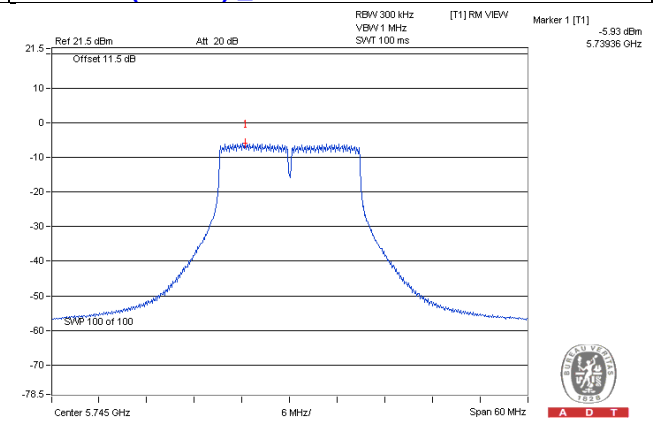
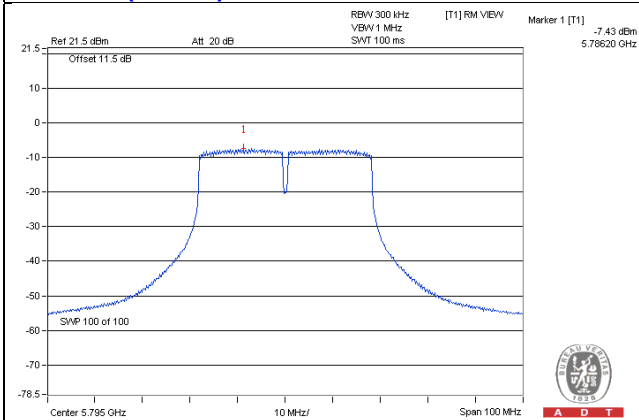
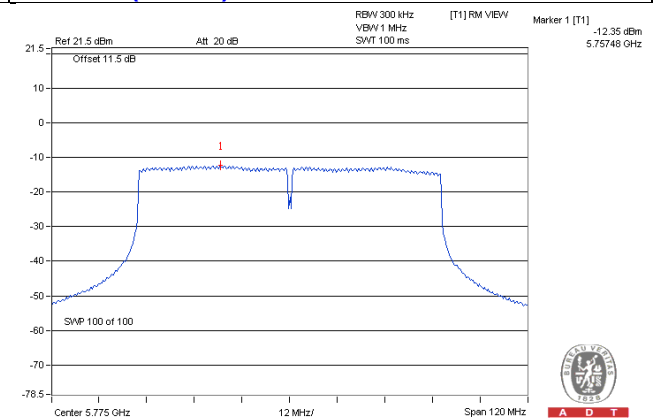
SPECTRUM PLOT OF WORST VALUE**802.11a_1TX****802.11n (HT20)_2TX****802.11n (HT40)_2TX****802.11ac (VHT20)_2TX****802.11ac (VHT40)_2TX****802.11ac (VHT80)_2TX**

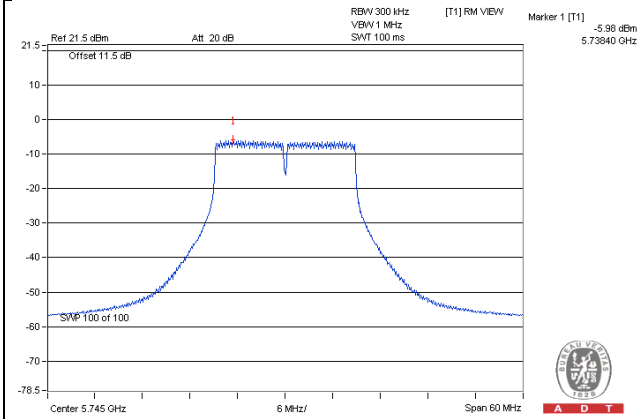
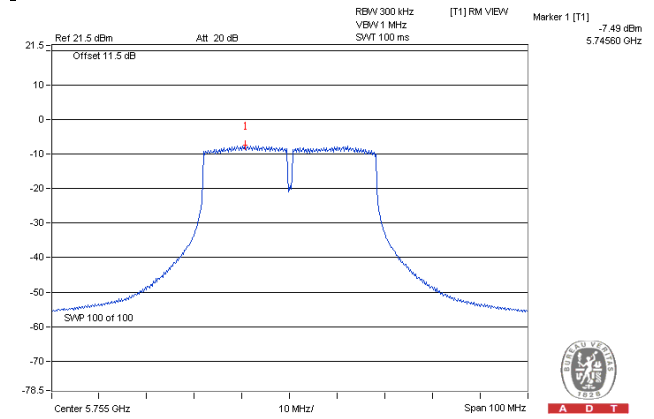
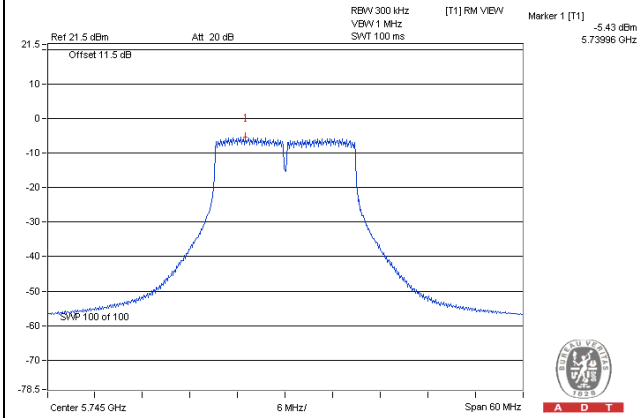
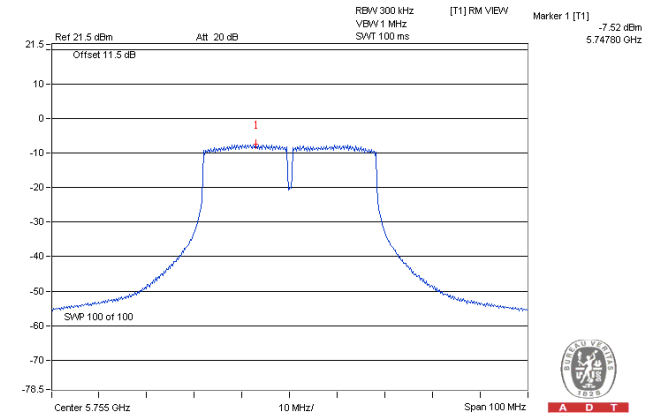
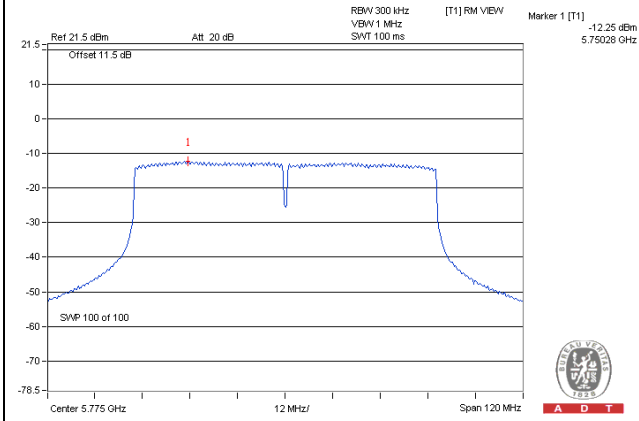
SPECTRUM PLOT OF WORST VALUE**802.11n (HT20)_3TX****802.11n (HT40)_3TX****802.11ac (VHT20)_3TX****802.11ac (VHT40)_3TX****802.11ac (VHT80)_3TX**

4.5 Frequency Stability

4.5.1 Limits of Frequency Stability Measurement

The frequency of the carrier signal shall be maintained within band of operation

4.5.2 Test Setup

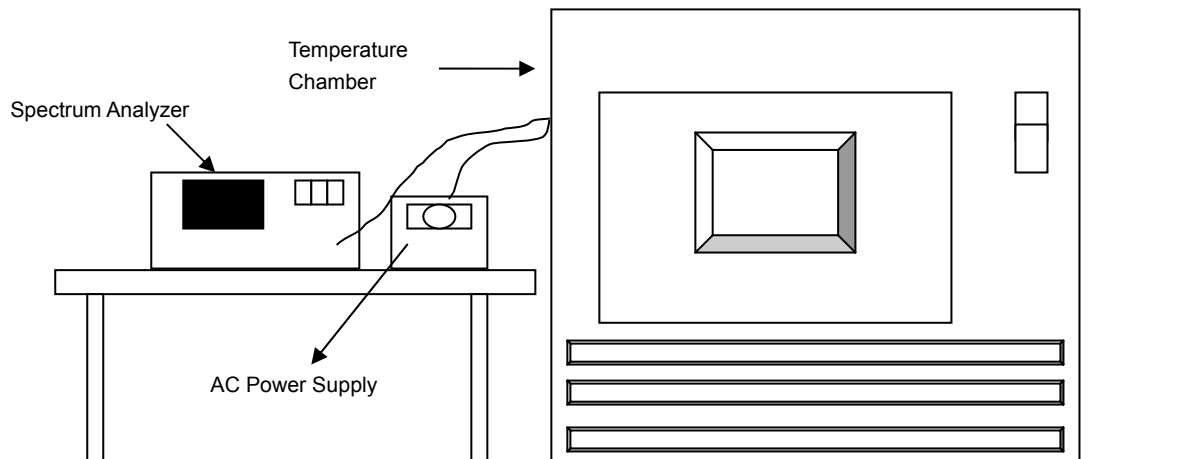

4.5.3 Test Instruments

Refer to section 4.1.2 to get information of above instrument.

4.5.4 Test Procedure

- The EUT was placed inside the environmental test chamber and powered by nominal AC voltage.
- Turn the EUT on and couple its output to a spectrum analyzer.
- Turn the EUT off and set the chamber to the highest temperature specified.
- Allow sufficient time (approximately 30 min) for the temperature of the chamber to stabilize, turn the EUT on and measure the operating frequency after 2, 5, and 10 minutes.
- Repeat step 2 and 3 with the temperature chamber set to the lowest temperature.
- The test chamber was allowed to stabilize at +20 degree C for a minimum of 30 minutes. The supply voltage was then adjusted on the EUT from 85% to 115% and the frequency record.

4.5.5 Deviation from Test Standard

No deviation.

4.5.6 EUT Operating Condition

Set the EUT transmit at un-modulation mode to test frequency stability.

4.5.7 Test Results

FREQUENCY STABILITY VERSUS TEMP.									
OPERATING FREQUENCY: 5240MHz									
TEMP. (°C)	POWER SUPPLY (Vac)	0 MINUTE		2 MINUTE		5 MINUTE		10 MINUTE	
		Measured Frequency (MHz)	Frequency Drift (%)	Measured Frequency (MHz)	Frequency Drift (%)	Measured Frequency (MHz)	Frequency Drift (%)	Measured Frequency (MHz)	Frequency Drift (%)
50	120	5239.9842	-0.00030	5239.9805	-0.00037	5239.9831	-0.00032	5239.9837	-0.00031
40	120	5239.9906	-0.00018	5239.9928	-0.00014	5239.9905	-0.00018	5239.9899	-0.00019
30	120	5239.9856	-0.00027	5239.9868	-0.00025	5239.9873	-0.00024	5239.9851	-0.00028
20	120	5239.9998	0.00000	5239.9993	-0.00001	5240.0005	0.00001	5240.0001	0.00000
10	120	5240.0004	0.00001	5239.9995	-0.00001	5240.0017	0.00003	5240.0003	0.00001
0	120	5239.9809	-0.00036	5239.9843	-0.00030	5239.9803	-0.00038	5239.9838	-0.00031
-10	120	5240.0159	0.00030	5240.0161	0.00031	5240.0165	0.00031	5240.0131	0.00025
-20	120	5240.0048	0.00009	5240.0017	0.00003	5240.0038	0.00007	5240.0006	0.00001
-30	120	5240.0152	0.00029	5240.0173	0.00033	5240.0156	0.00030	5240.0158	0.00030

FREQUENCY STABILITY VERSUS TEMP.									
OPERATING FREQUENCY: 5240MHz									
TEMP. (°C)	POWER SUPPLY (Vac)	0 MINUTE		2 MINUTE		5 MINUTE		10 MINUTE	
		Measured Frequency (MHz)	Frequency Drift (%)	Measured Frequency (MHz)	Frequency Drift (%)	Measured Frequency (MHz)	Frequency Drift (%)	Measured Frequency (MHz)	Frequency Drift (%)
20	138	5239.9995	-0.00001	5239.9986	-0.00003	5240.0009	0.00002	5240.0001	0.00000
	120	5239.9998	0.00000	5239.9993	-0.00001	5240.0005	0.00001	5240.0001	0.00000
	102	5239.9998	0.00000	5239.9988	-0.00002	5240.0004	0.00001	5239.9992	-0.00002

4.6 6dB Bandwidth Measurement

4.6.1 Limits of 6dB Bandwidth Measurement

The minimum of 6dB Bandwidth Measurement is 0.5MHz.

4.6.2 Test Setup

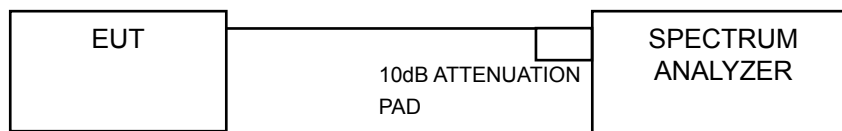

4.6.3 Test Instruments

Refer to section 4.1.2 to get information of above instrument.

4.6.4 Test Procedure

MEASUREMENT PROCEDURE REF

- Set resolution bandwidth (RBW) = 100kHz
- Set the video bandwidth (VBW) $\geq 3 \times$ RBW, Detector = Peak.
- Trace mode = max hold.
- Sweep = auto couple.
- Measure the maximum width of the emission that is constrained by the frequencies associated with the two amplitude points (upper and lower) that are attenuated by 6 dB relative to the maximum level measured in the fundamental emission

4.6.5 Deviation from Test Standard

No deviation.

4.6.6 EUT Operating Condition

The software provided by client to enable the EUT under transmission Condition continuously at lowest, middle and highest channel frequencies individually.

4.6.7 Test Results

802.11a_1TX

Channel	Frequency (MHz)	6dB Bandwidth (MHz)	Minimum Limit (MHz)	Pass / Fail
149	5745	16.44	0.5	PASS
157	5785	16.47	0.5	PASS
165	5825	16.46	0.5	PASS

802.11n (HT20)_2TX

Channel	Frequency (MHz)	6dB Bandwidth (MHz)		Minimum Limit (MHz)	Pass / Fail
		Chain 0	Chain 1		
149	5745	17.66	17.68	0.5	PASS
157	5785	17.70	17.69	0.5	PASS
165	5825	17.65	17.63	0.5	PASS

802.11n (HT40)_2TX

Channel	Frequency (MHz)	6dB Bandwidth (MHz)		Minimum Limit (MHz)	Pass / Fail
		Chain 0	Chain 1		
151	5755	36.50	36.53	0.5	PASS
159	5795	36.52	36.43	0.5	PASS

802.11ac (VHT20)_2TX

Channel	Frequency (MHz)	6dB Bandwidth (MHz)		Minimum Limit (MHz)	Pass / Fail
		Chain 0	Chain 1		
149	5745	17.65	17.67	0.5	PASS
157	5785	17.66	17.70	0.5	PASS
165	5825	17.68	17.64	0.5	PASS

802.11ac (VHT40)_2TX

Channel	Frequency (MHz)	6dB Bandwidth (MHz)		Minimum Limit (MHz)	Pass / Fail
		Chain 0	Chain 1		
151	5755	36.48	36.48	0.5	PASS
159	5795	36.57	36.53	0.5	PASS

802.11ac (VHT80)_2TX

Channel	Frequency (MHz)	6dB Bandwidth (MHz)		Minimum Limit (MHz)	Pass / Fail
		Chain 0	Chain 1		
155	5775	76.47	76.56	0.5	PASS

802.11n (HT20)_3TX

Channel	Frequency (MHz)	6dB Bandwidth (MHz)			Minimum Limit (MHz)	Pass / Fail
		Chain 0	Chain 1	Chain 2		
149	5745	17.73	17.69	17.71	0.5	PASS
157	5785	17.65	17.67	17.66	0.5	PASS
165	5825	17.65	17.65	17.64	0.5	PASS

802.11n (HT40)_3TX

Channel	Frequency (MHz)	6dB Bandwidth (MHz)			Minimum Limit (MHz)	Pass / Fail
		Chain 0	Chain 1	Chain 2		
151	5755	36.47	36.51	36.49	0.5	PASS
159	5795	36.57	36.43	36.44	0.5	PASS

802.11ac (VHT20)_3TX

Channel	Frequency (MHz)	6dB Bandwidth (MHz)			Minimum Limit (MHz)	Pass / Fail
		Chain 0	Chain 1	Chain 2		
149	5745	17.69	17.68	17.66	0.5	PASS
157	5785	17.66	17.66	17.73	0.5	PASS
165	5825	17.64	17.69	17.71	0.5	PASS

802.11ac (VHT40)_3TX

Channel	Frequency (MHz)	6dB Bandwidth (MHz)			Minimum Limit (MHz)	Pass / Fail
		Chain 0	Chain 1	Chain 2		
151	5755	36.56	36.51	36.49	0.5	PASS
159	5795	36.54	36.56	36.47	0.5	PASS

802.11ac (VHT80)_3TX

Channel	Frequency (MHz)	6dB Bandwidth (MHz)			Minimum Limit (MHz)	Pass / Fail
		Chain 0	Chain 1	Chain 2		
155	5775	76.55	76.55	75.88	0.5	PASS

SPECTRUM PLOT OF WORST VALUE

802.11a_1TX

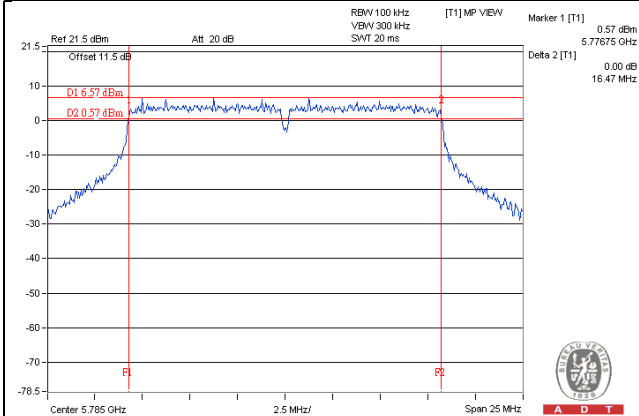

802.11n (HT20)_2TX

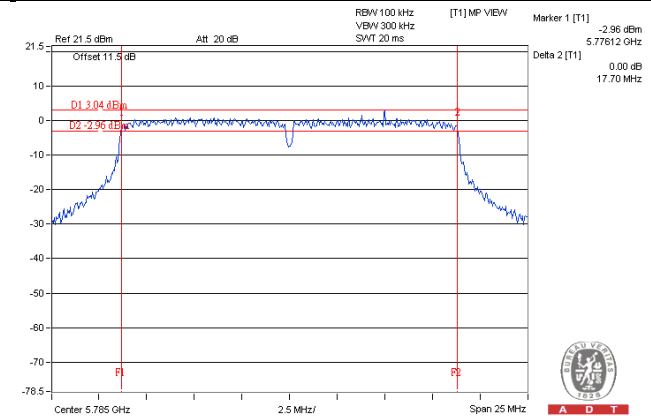

802.11n (HT40)_2TX

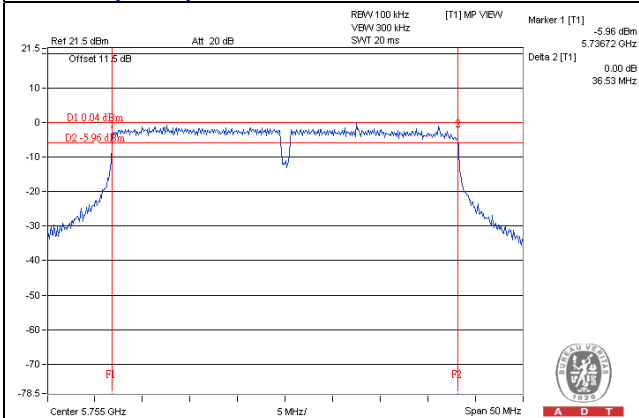

802.11ac (VHT20)_2TX

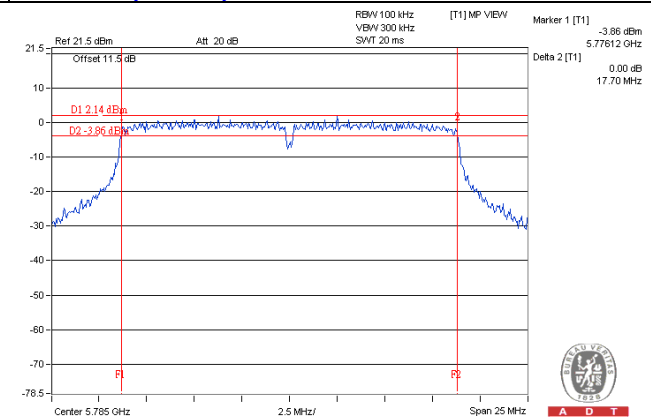

802.11ac (VHT40)_2TX

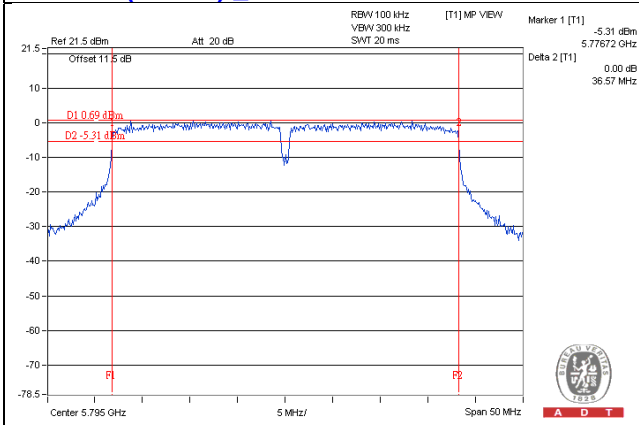

802.11ac (VHT80)_2TX

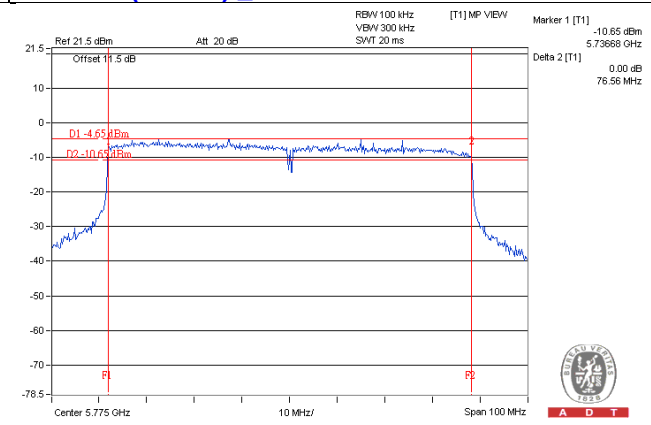

SPECTRUM PLOT OF WORST VALUE

802.11n (HT20)_3TX

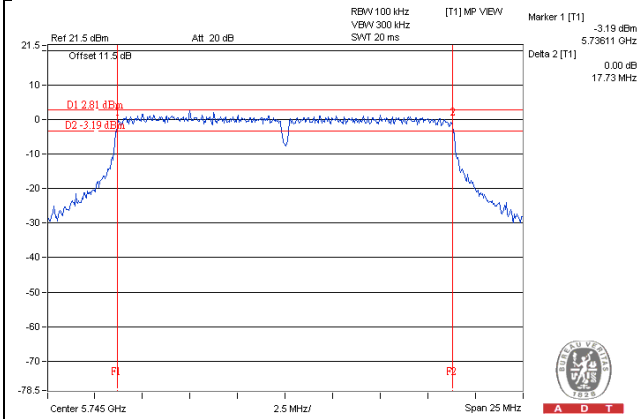

802.11n (HT40)_3TX

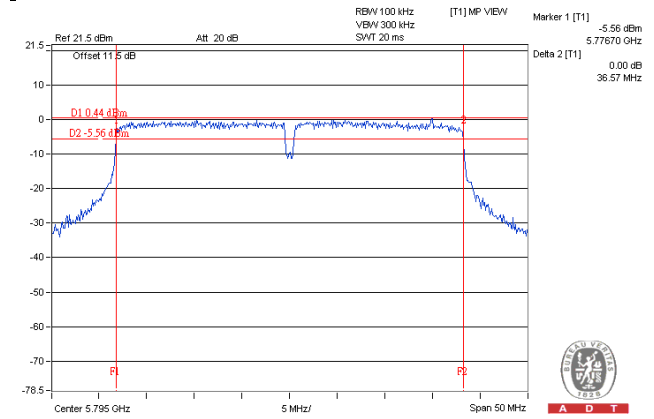

802.11ac (VHT20)_3TX

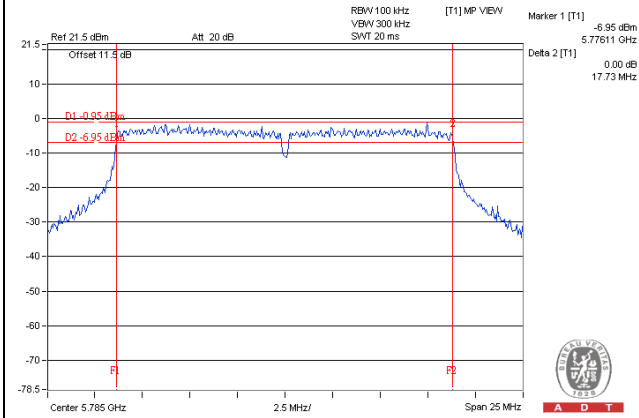

802.11ac (VHT40)_3TX

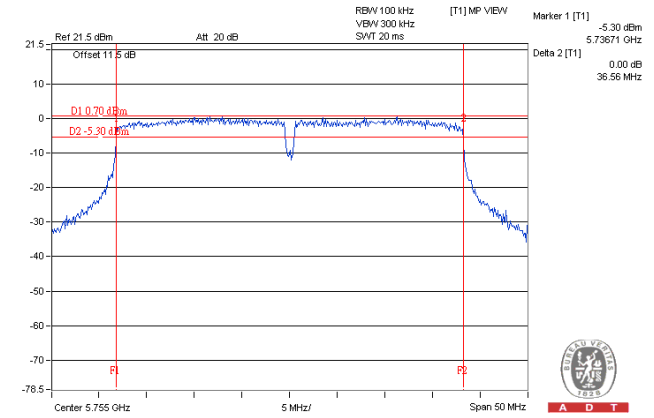

802.11ac (VHT80)_3TX

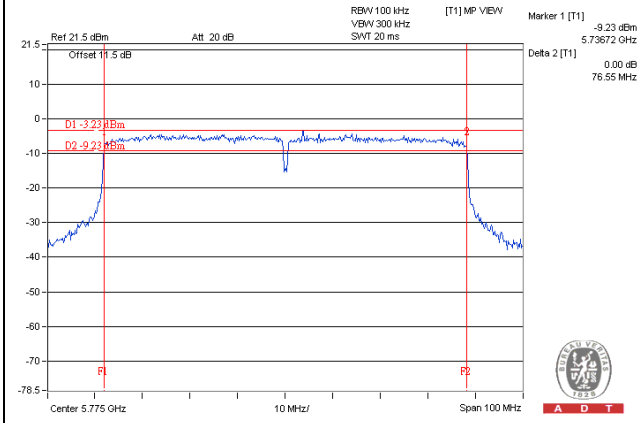

5 Pictures of Test Arrangements

Please refer to the attached file (Test Setup Photo).

Appendix – Information on the Testing Laboratories

We, Bureau Veritas Consumer Products Services (H.K.) Ltd., Taoyuan Branch, were founded in 1988 to provide our best service in EMC, Radio, Telecom and Safety consultation. Our laboratories are accredited and approved according to ISO/IEC 17025.

If you have any comments, please feel free to contact us at the following:

Linko EMC/RF Lab

Tel: 886-2-26052180

Fax: 886-2-26051924

Hsin Chu EMC/RF Lab/Telecom Lab

Tel: 886-3-5935343

Fax: 886-3-5935342

Hwa Ya EMC/RF/Safety

Tel: 886-3-3183232

Fax: 886-3-3270892

Email: service.adt@tw.bureauveritas.com

Web Site: www.bureauveritas-adt.com

The address and road map of all our labs can be found in our web site also.

--- END ---