

## FCC Test Report

**Report No.:** RF170731C03-1

**FCC ID:** 2ACTO-7933DMC

**Test Model:** 7933DMC

**Received Date:** Sep. 08, 2017

**Test Date:** Nov. 06 ~ Dec. 01, 2017

**Issued Date:** Dec. 12, 2017

**Applicant:** Sophos Ltd

**Address:** The Pentagon, Abingdon, OX14 3YP, United Kingdom

**Issued By:** Bureau Veritas Consumer Products Services (H.K.) Ltd., Taoyuan Branch

**Lab Address:** No. 47-2, 14th Ling, Chia Pau Vil., Lin Kou Dist., New Taipei City, Taiwan (R.O.C.)

**Test Location:** No. 19, Hwa Ya 2nd Rd., Wen Hwa Vil., Kwei Shan Dist., Taoyuan City 33383, TAIWAN (R.O.C.)

**FCC Registration /  
Designation Number:** 788550 / TW0003



This report is for your exclusive use. Any copying or replication of this report to or for any other person or entity, or use of our name or trademark, is permitted only with our prior written permission. This report sets forth our findings solely with respect to the test samples identified herein. The results set forth in this report are not indicative or representative of the quality or characteristics of the lot from which a test sample was taken or any similar or identical product unless specifically and expressly noted. Our report includes all of the tests requested by you and the results thereof based upon the information that you provided to us. You have 60 days from date of issuance of this report to notify us of any material error or omission caused by our negligence, provided, however, that such notice shall be in writing and shall specifically address the issue you wish to raise. A failure to raise such issue within the prescribed time shall constitute your unqualified acceptance of the completeness of this report, the tests conducted and the correctness of the report contents. Unless specific mention, the uncertainty of measurement has been explicitly taken into account to declare the compliance or non-compliance to the specification. The report must not be used by the client to claim product certification, approval, or endorsement by TAF or any government agencies.

## Table of Contents

<b>Release Control Record</b> .....	<b>4</b>
<b>1 Certificate of Conformity</b> .....	<b>5</b>
<b>2 Summary of Test Results</b> .....	<b>6</b>
2.1 Measurement Uncertainty .....	6
2.2 Modification Record .....	6
<b>3 General Information</b> .....	<b>7</b>
3.1 General Description of EUT .....	7
3.2 Description of Test Modes .....	8
3.2.1 Test Mode Applicability and Tested Channel Detail .....	9
3.3 Duty Cycle of Test Signal .....	11
3.4 Description of Support Units .....	12
3.4.1 Configuration of System under Test .....	12
3.5 General Description of Applied Standards .....	12
<b>4 Test Types and Results</b> .....	<b>13</b>
4.1 Radiated Emission and Bandedge Measurement.....	13
4.1.1 Limits of Radiated Emission and Bandedge Measurement .....	13
4.1.2 Test Instruments .....	14
4.1.3 Test Procedures.....	15
4.1.4 Deviation from Test Standard .....	15
4.1.5 Test Setup.....	16
4.1.6 EUT Operating Conditions.....	17
4.1.7 Test Results .....	18
4.2 Conducted Emission Measurement .....	37
4.2.1 Limits of Conducted Emission Measurement .....	37
4.2.2 Test Instruments .....	37
4.2.3 Test Procedures.....	38
4.2.4 Deviation from Test Standard .....	38
4.2.5 Test Setup.....	38
4.2.6 EUT Operating Conditions.....	38
4.2.7 Test Results .....	39
4.3 Transmit Power Measurement .....	41
4.3.1 Limits of Transmit Power Measurement .....	41
4.3.2 Test Setup.....	41
4.3.3 Test Instruments .....	41
4.3.4 Test Procedure .....	42
4.3.5 Deviation from Test Standard .....	42
4.3.6 EUT Operating Conditions.....	42
4.3.7 Test Result.....	43
4.4 Occupied Bandwidth Measurement .....	44
4.4.1 Test Setup.....	44
4.4.2 Test Instruments .....	44
4.4.3 Test Procedure .....	44
4.4.4 Test Result.....	45
4.5 Peak Power Spectral Density Measurement .....	47
4.5.1 Limits of Peak Power Spectral Density Measurement .....	47
4.5.2 Test Setup.....	47
4.5.3 Test Instruments .....	47
4.5.4 Test Procedures.....	47
4.5.5 Deviation from Test Standard .....	48
4.5.6 EUT Operating Conditions.....	48
4.5.7 Test Results .....	49
4.6 Frequency Stability.....	54
4.6.1 Limits of Frequency Stability Measurement .....	54

4.6.2	Test Setup.....	54
4.6.3	Test Instruments .....	54
4.6.4	Test Procedure .....	55
4.6.5	Deviation from Test Standard .....	55
4.6.6	EUT Operating Condition .....	55
4.6.7	Test Results .....	55
4.7	6dB Bandwidth Measurement.....	56
4.7.1	Limits of 6dB Bandwidth Measurement.....	56
4.7.2	Test Setup.....	56
4.7.3	Test Instruments .....	56
4.7.4	Test Procedure .....	56
4.7.5	Deviation from Test Standard .....	56
4.7.6	EUT Operating Condition .....	56
4.7.7	Test Results .....	57
<b>5</b>	<b>Pictures of Test Arrangements.....</b>	<b>59</b>
	<b>Annex A- Radiated Out of Band Emission (OOBE) Measurement (For U-NII-3 band).....</b>	<b>60</b>
	<b>Appendix – Information on the Testing Laboratories .....</b>	<b>63</b>

### Release Control Record

Issue No.	Description	Date Issued
RF170731C03-1	Original release.	Dec. 12, 2017

## 1 Certificate of Conformity

**Product:** 3T3R Wireless 802.11ac/abgn Dual Band Selectable PCIe Module

**Brand:** Sophos

**Test Model:** 7933DMC

**Sample Status:** Engineering sample

**Applicant:** Sophos Ltd

**Test Date:** Nov. 06 ~ Dec. 01, 2017

**Standards:** 47 CFR FCC Part 15, Subpart E (Section 15.407)  
ANSI C63.10:2013

The above equipment has been tested by **Bureau Veritas Consumer Products Services (H.K.) Ltd., Taoyuan Branch**, and found compliance with the requirement of the above standards. The test record, data evaluation & Equipment Under Test (EUT) configurations represented herein are true and accurate accounts of the measurements of the sample's EMC characteristics under the conditions specified in this report.

**Prepared by :** Celine Chou , **Date:** Dec. 12, 2017  
Celine Chou / Specialist

**Approved by :** Ken Liu , **Date:** Dec. 12, 2017  
Ken Liu / Senior Manager

## 2 Summary of Test Results

47 CFR FCC Part 15, Subpart E (Section 15.407)			
FCC Clause	Test Item	Result	Remarks
15.407(b)(6)	AC Power Conducted Emissions	Pass	Meet the requirement of limit. Minimum passing margin is -21.31dB at 0.16173MHz.
15.407(b)(1/2/3/4(i/ii)/6)	Radiated Emissions & Band Edge Measurement	Pass	Meet the requirement of limit. Minimum passing margin is -1.0dB at 5150.00MHz.
15.407(a)(1/2/3)	Max Average Transmit Power	Pass	Meet the requirement of limit.
---	Occupied Bandwidth Measurement	-	Reference only.
15.407(a)(1/2/3)	Peak Power Spectral Density	Pass	Meet the requirement of limit.
15.407(e)	6dB bandwidth	Pass	Meet the requirement of limit. (U-NII-3 Band only)
15.407(g)	Frequency Stability	Pass	Meet the requirement of limit.
15.203	Antenna Requirement	Pass	Antenna connector is SMA Jack reverse not a standard connector.

\*For U-NII-3 band compliance with rule part 15.407(b)(4)(i), the OOB test plots were recorded in Annex A.

### 2.1 Measurement Uncertainty

Where relevant, the following measurement uncertainty levels have been estimated for tests performed on the EUT as specified in CISPR 16-4-2:

Measurement	Frequency	Expanded Uncertainty (k=2) ( $\pm$ )
Conducted Emissions at mains ports	150kHz ~ 30MHz	2.94 dB
Radiated Emissions up to 1 GHz	30MHz ~ 200MHz	3.59 dB
	200MHz ~ 1000MHz	3.60 dB
Radiated Emissions above 1 GHz	1GHz ~ 18GHz	2.29 dB
	18GHz ~ 40GHz	2.29 dB

### 2.2 Modification Record

There were no modifications required for compliance.

### 3 General Information

#### 3.1 General Description of EUT

Product	3T3R Wireless 802.11ac/abgn Dual Band Selectable PCIe Module
Brand	Sophos
Test Model	7933DMC
Sample Status	Engineering sample
Power Supply Rating	3.3Vdc
Modulation Type	256QAM, 64QAM, 16QAM, QPSK, BPSK
Modulation Technology	OFDM
Transfer Rate	802.11a: 54/48/36/24/18/12/9/6Mbps 802.11n: up to 450Mbps 802.11ac: up to 1300Mbps
Operating Frequency	5180~5240MHz, 5745~5825MHz
Number of Channel	5180~5240MHz: 802.11a, 802.11n (HT20), 802.11ac (VHT20): 4 802.11n (HT40), 802.11ac (VHT40): 2 802.11ac (VHT80): 1 5745~5825MHz: 802.11a, 802.11n (HT20), 802.11ac (VHT20): 5 802.11n (HT40), 802.11ac (VHT40): 2 802.11ac (VHT80): 1
Output Power	5180~5240MHz: 416.928mW 5745~5825MHz: 405.108mW
Antenna Type	Refer to Note
Antenna Connector	Refer to Note
Accessory Device	Refer to Note
Cable Supplied	N/A

Note:

- The EUT incorporates a MIMO function. Physically, the EUT provides 3 completed transmitters and 3 receivers.

Modulation Mode	TX Function
802.11a	1TX (Fixed Chain 0)
802.11n (HT20)	3TX
802.11n (HT40)	3TX
802.11ac (VHT20)	3TX
802.11ac (VHT40)	3TX
802.11ac (VHT80)	3TX

\* The modulation and bandwidth are similar for 802.11n mode for 20MHz/40MHz and 802.11ac mode for 20MHz/40MHz, therefore investigated worst case to representative mode in test report. (Final test mode refer section 3.2.1)

2. Accessory devices of EUT are list as below.

	Part Number	Spec.
Antenna	C059-510394-A	Antenna+RG-178+SMA Straight Plug Reverse Dual band
Antenna cable	C059-510395-A	RF CABLE+ $\phi$ 1.13mm(Gray) SMA Jack reverse+MHF L=250mm
	C059-510396-A	RF CABLE+ $\phi$ 1.13mm(Gray) SMA Jack reverse+MHF L=400mm
	C059-510397-A	RF CABLE+ $\phi$ 1.13mm(Gray) SMA Jack reverse(1080)+I-PEX L=100mm

\* After pre-test three antenna cables, C059-510397-A antenna cable was the worst case and chosen for final test and presented in the test report

3. The EUT uses following antennas.

Type	Dipole			Connector	SMA Jack reverse		
Gain (dBi)	Frequency (MHz)						
	2400	2450	2500	5150	5350	5750	5825
	3.1	3.5	3.9	2.7	3.7	4.2	4.4

4. 2.4GHz & 5GHz technology cannot transmit at same time.

### 3.2 Description of Test Modes

#### 5180~5240MHz:

4 channels are provided for 802.11a, 802.11n (HT20), 802.11ac (VHT20):

Channel	Frequency	Channel	Frequency
36	5180 MHz	44	5220 MHz
40	5200 MHz	48	5240 MHz

2 channels are provided for 802.11n (HT40), 802.11ac (VHT40):

Channel	Frequency	Channel	Frequency
38	5190 MHz	46	5230 MHz

1 channel is provided for 802.11ac (VHT80):

Channel	Frequency
42	5210MHz

#### 5745~5825MHz:

5 channels are provided for 802.11a, 802.11n (HT20), 802.11ac (VHT20):

Channel	Frequency	Channel	Frequency
149	5745MHz	161	5805MHz
153	5765MHz	165	5825MHz
157	5785MHz		

2 channels are provided for 802.11n (HT40), 802.11ac (VHT40):

Channel	Frequency	Channel	Frequency
151	5755MHz	159	5795MHz

1 channel is provided for 802.11ac (VHT80):

Channel	Frequency
155	5775MHz



### 3.2.1 Test Mode Applicability and Tested Channel Detail

EUT Configure Mode	Applicable to				Description
	RE $\geq$ 1G	RE $<$ 1G	PLC	APCM	
-	√	√	√	√	-

Where RE $\geq$ 1G: Radiated Emission above 1GHz & Bandedge Measurement  
 RE $<$ 1G: Radiated Emission below 1GHz  
 PLC: Power Line Conducted Emission  
 APCM: Antenna Port Conducted Measurement

Note: The EUT had been pre-tested on the positioned of each 3 axis. The worst case was found when positioned on **X-plane**.

#### **Radiated Emission Test (Above 1GHz):**

- Pre-Scan has been conducted to determine the worst-case mode from all possible combinations between available modulations, data rates and antenna ports (if EUT with antenna diversity architecture).
- Following channel(s) was (were) selected for the final test as listed below.

EUT Configure Mode	Mode	Frequency Band (MHz)	Available Channel	Tested Channel	Modulation Technology	Data Rate (Mbps)
-	802.11a	5180-5240	36 to 48	36, 40, 48	OFDM	6.0
	802.11n (HT20)		36 to 48	36, 40, 48	OFDM	6.5
	802.11n (HT40)		38 to 46	38, 46	OFDM	13.5
	802.11ac (VHT80)		42	42	OFDM	29.3
-	802.11a	5745-5825	149 to 165	149, 157, 165	OFDM	6.0
	802.11n (HT20)		149 to 165	149, 157, 165	OFDM	6.5
	802.11n (HT40)		151 to 159	151, 159	OFDM	13.5
	802.11ac (VHT80)		155	155	OFDM	29.3

#### **Radiated Emission Test (Below 1GHz):**

- Pre-Scan has been conducted to determine the worst-case mode from all possible combinations between available modulations, data rates and antenna ports (if EUT with antenna diversity architecture).
- Following channel(s) was (were) selected for the final test as listed below.

EUT Configure Mode	Mode	Frequency Band (MHz)	Available Channel	Tested Channel	Modulation Technology	Data Rate (Mbps)
-	802.11a	5180-5240	36 to 48	36	OFDM	6.0
	802.11a	5745-5825	149 to 165		OFDM	6.0

#### **Power Line Conducted Emission Test:**

- Pre-Scan has been conducted to determine the worst-case mode from all possible combinations between available modulations, data rates and antenna ports (if EUT with antenna diversity architecture).
- Following channel(s) was (were) selected for the final test as listed below.

EUT Configure Mode	Mode	Frequency Band (MHz)	Available Channel	Tested Channel	Modulation Technology	Data Rate (Mbps)
-	802.11a	5180-5240	36 to 48	36	OFDM	6.0
	802.11a	5745-5825	149 to 165		OFDM	6.0

### Antenna Port Conducted Measurement:

- This item includes all test value of each mode, but only includes spectrum plot of worst value of each mode.
- Pre-Scan has been conducted to determine the worst-case mode from all possible combinations between available modulations, data rates and antenna ports (if EUT with antenna diversity architecture).
- Following channel(s) was (were) selected for the final test as listed below.

EUT Configure Mode	Mode	Frequency Band (MHz)	Available Channel	Tested Channel	Modulation Technology	Data Rate (Mbps)
-	802.11a	5180-5240	36 to 48	36, 40, 48	OFDM	6.0
	802.11n (HT20)		36 to 48	36, 40, 48	OFDM	6.5
	802.11n (HT40)		38 to 46	38, 46	OFDM	13.5
	802.11ac (VHT80)		42	42	OFDM	29.3
-	802.11a	5745-5825	149 to 165	149, 157, 165	OFDM	6.0
	802.11n (HT20)		149 to 165	149, 157, 165	OFDM	6.5
	802.11n (HT40)		151 to 159	151, 159	OFDM	13.5
	802.11ac (VHT80)		155	155	OFDM	29.3

### Test Condition:

Applicable to	Environmental Conditions	Input Power (System)	Tested by
RE <sub>≥</sub> 1G	25 deg. C, 65% RH	120Vac, 60Hz	James Yang
RE <sub>&lt;</sub> 1G	25 deg. C, 65% RH	120Vac, 60Hz	Greg Lin
PLC	25 deg. C, 75% RH	120Vac, 60Hz	Matthew Yang
APCM	25 deg. C, 60% RH	120Vac, 60Hz	Chris Lin

### 3.3 Duty Cycle of Test Signal

Duty cycle of test signal is < 98%, duty factor is required.

802.11a: Duty cycle = 2.706/2.798 = 0.967, Duty factor =  $10 * \log(1/0.967) = 0.15$

802.11n (HT20): Duty cycle = 2.512/2.601 = 0.966, Duty factor =  $10 * \log(1/0.966) = 0.15$

802.11n (HT40): Duty cycle = 1.222/1.308 = 0.934, Duty factor =  $10 * \log(1/0.934) = 0.30$

802.11ac (VHT80): Duty cycle = 0.595/0.685 = 0.869, Duty factor =  $10 * \log(1/0.869) = 0.61$

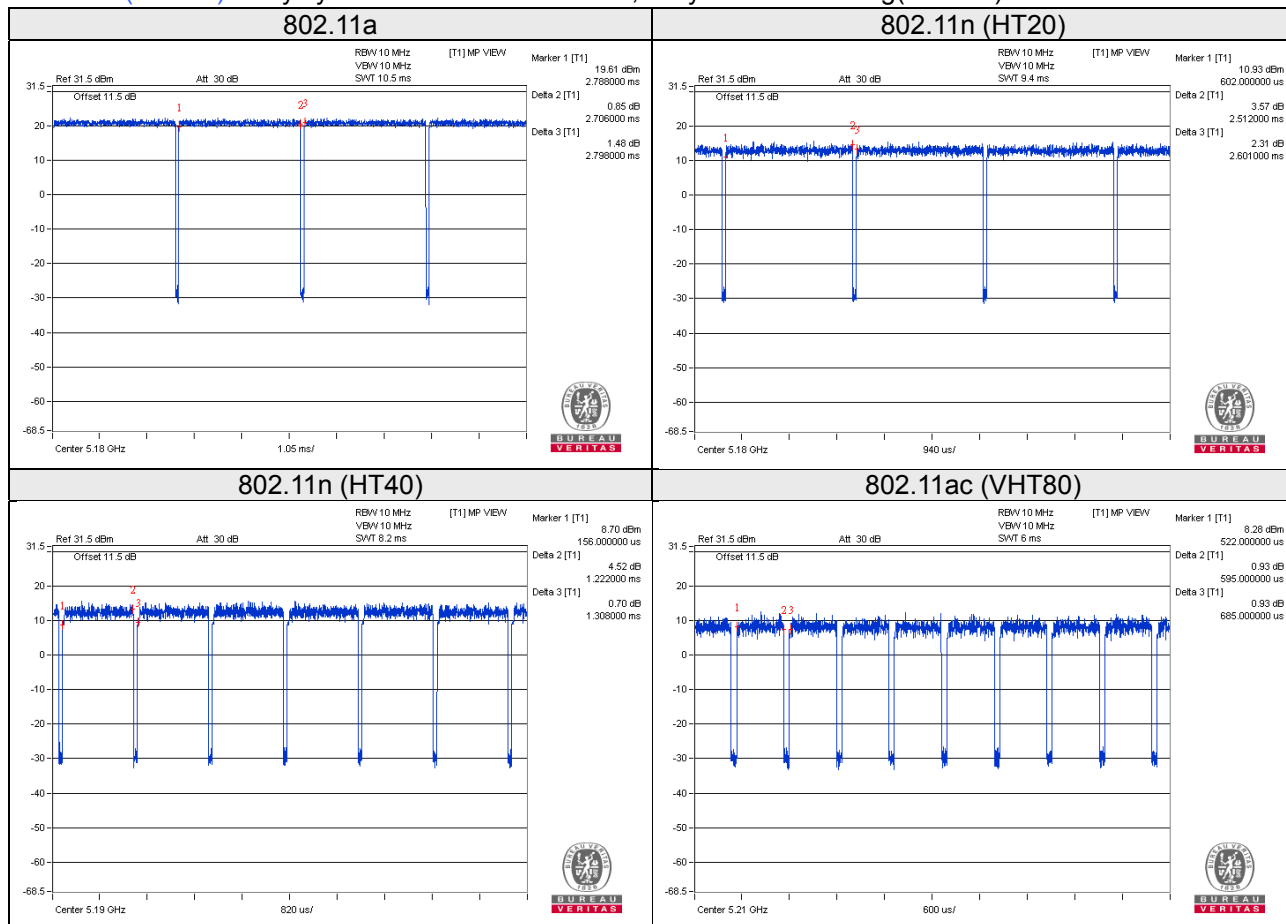

### 3.4 Description of Support Units

The EUT has been tested as an independent unit together with other necessary accessories or support units. The following support units or accessories were used to form a representative test configuration during the tests.

ID	Product	Brand	Model No.	Serial No.	FCC ID	Remarks
A.	Adapter	DVE	DSA-36PFH-12FUS	N/A	N/A	Provided by client
B.	Notebook	DELL	E5430	FKKCYW1	FCC DoC Approved	-
C.	Convertible Board	N/A	N/A	N/A	N/A	Provided by client

Note:

1. All power cords of the above support units are non-shielded (1.8m).
2. Item B acted as a communication partner to transfer data.

ID	Descriptions	Qty.	Length (m)	Shielding (Yes/No)	Cores (Qty.)	Remarks
1.	DC cable	1	1.5	N	0	Provided by client
2.	RJ45, Cat5e	1	3	N	0	-

#### 3.4.1 Configuration of System under Test

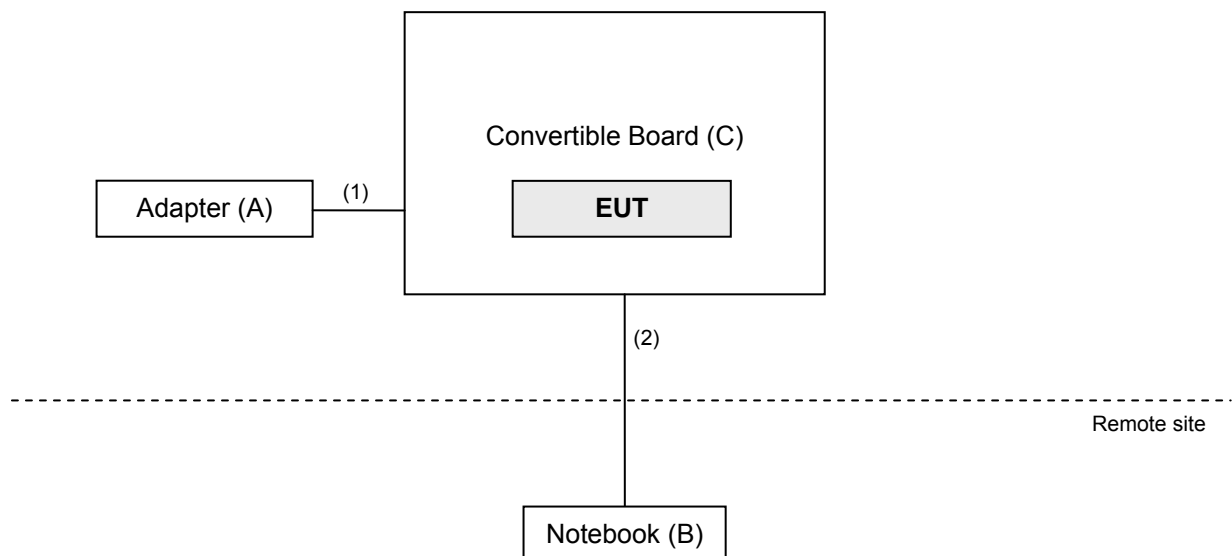

### 3.5 General Description of Applied Standards

The EUT is a RF Product. According to the specifications of the manufacturer, it must comply with the requirements of the following standards:

**FCC Part 15, Subpart E (15.407)**

**KDB 789033 D02 General UNII Test Procedure New Rules v02r01**

**KDB 662911 D01 Multiple Transmitter Output v02r01**

ANSI C63.10:2013

All test items have been performed and recorded as per the above standards.

Note: The EUT has been verified to comply with the requirements of FCC Part 15, Subpart B, Class B (DoC). The test report has been issued separately.

## 4 Test Types and Results

### 4.1 Radiated Emission and Bandedge Measurement

#### 4.1.1 Limits of Radiated Emission and Bandedge Measurement

Radiated emissions which fall in the restricted bands must comply with the radiated emission limits specified as below table.

Frequencies (MHz)	Field Strength (microvolts/meter)	Measurement Distance (meters)
0.009 ~ 0.490	2400/F(kHz)	300
0.490 ~ 1.705	24000/F(kHz)	30
1.705 ~ 30.0	30	30
30 ~ 88	100	3
88 ~ 216	150	3
216 ~ 960	200	3
Above 960	500	3

Note:

1. The lower limit shall apply at the transition frequencies.
2. Emission level (dBuV/m) = 20 log Emission level (uV/m).
3. For frequencies above 1000MHz, the field strength limits are based on average detector, however, the peak field strength of any emission shall not exceed the maximum permitted average limits, specified above by more than 20dB under any condition of modulation.

Limits of unwanted emission out of the restricted bands

Applicable To		Limit	
789033 D02 General UNII Test Procedure New Rules v02r01		Field Strength at 3m	
		PK: 74 (dBµV/m)	AV: 54 (dBµV/m)
Frequency Band	Applicable To	EIRP Limit	Equivalent Field Strength at 3m
5150~5250 MHz	15.407(b)(1)	PK: -27 (dBm/MHz)	PK: 68.2(dBµV/m)
5250~5350 MHz	15.407(b)(2)		
5470~5725 MHz	15.407(b)(3)		
5725~5850 MHz	<input checked="" type="checkbox"/> 15.407(b)(4)(i)	PK: -27 (dBm/MHz) <sup>*1</sup> PK: 10 (dBm/MHz) <sup>*2</sup> PK: 15.6 (dBm/MHz) <sup>*3</sup> PK: 27 (dBm/MHz) <sup>*4</sup>	PK: 68.2(dBµV/m) <sup>*1</sup> PK: 105.2 (dBµV/m) <sup>*2</sup> PK: 110.8(dBµV/m) <sup>*3</sup> PK: 122.2 (dBµV/m) <sup>*4</sup>
	<input type="checkbox"/> 15.407(b)(4)(ii)	Emission limits in section 15.247(d)	
<sup>*1</sup> beyond 75 MHz or more above of the band edge. <sup>*3</sup> below the band edge increasing linearly to a level of 15.6 dBm/MHz at 5 MHz above.		<sup>*2</sup> below the band edge increasing linearly to 10 dBm/MHz at 25 MHz above. <sup>*4</sup> from 5 MHz above or below the band edge increasing linearly to a level of 27 dBm/MHz at the band edge.	

Note: The following formula is used to convert the equipment isotropic radiated power (eirp) to field strength:

$$E = \frac{1000000 \sqrt{30P}}{3} \mu\text{V/m, where P is the eirp (Watts).}$$

#### 4.1.2 Test Instruments

Description & Manufacturer	Model No.	Serial No.	Cal. Date	Cal. Due
Test Receiver KEYSIGHT	N9038A	MY55420137	Mar. 27, 2017	Mar. 26, 2018
Spectrum Analyzer ROHDE & SCHWARZ	FSP40	100269	May 11, 2017	May 10, 2018
BILOG Antenna SCHWARZBECK	VULB9168	9168-148	Dec. 11, 2016	Dec. 10, 2017
HORN Antenna SCHWARZBECK	BBHA 9120 D	9120D-1169	Dec. 27, 2016	Dec. 26, 2017
HORN Antenna SCHWARZBECK	BBHA 9170	BBHA9170241	Dec. 14, 2016	Dec. 13, 2017
Loop Antenna EMCI	EM-6879	269	Aug. 11, 2017	Aug. 10, 2018
Preamplifier Agilent (Below 1GHz)	8447D	2944A10638	Aug. 08, 2017	Aug. 07, 2018
Preamplifier Agilent (Above 1GHz)	8449B	3008A01638	Feb. 22, 2017	Feb. 21, 2018
RF signal cable HUBER+SUHNER	SUCOFLEX 104	CABLE-CH9-02 (248780+MY13377)	Aug. 08, 2017	Aug. 07, 2018
RF signal cable HUBER+SUHNER	SUCOFLEX 104	CABLE-CH9-(250795/4)	Aug. 08, 2017	Aug. 07, 2018
RF signal cable Woken	8D-FB	Cable-CH9-01	Aug. 01, 2017	Jul. 31, 2018
Software BV ADT	ADT_Radiated_ V7.6.15.9.4	NA	NA	NA
Antenna Tower EMCO	2070/2080	512.835.4684	NA	NA
Turn Table EMCO	2087-2.03	NA	NA	NA
Antenna Tower & Turn BV ADT	AT100	AT93021705	NA	NA
Turn Table BV ADT	TT100	TT93021705	NA	NA
Turn Table Controller BV ADT	SC100	SC93021705	NA	NA
26GHz ~ 40GHz Amplifier Agilent	8449B	3008A1960	Aug. 08, 2017	Aug. 07, 2018
High Speed Peak Power Meter	ML2495A	0824012	Aug. 18, 2017	Aug. 17, 2018
Power Sensor	MA2411B	0738171	Aug. 18, 2017	Aug. 17, 2018
WIT Standard Temperature And Humidity Chamber	TH-4S-C	W981030	Jun. 07, 2017	Jun. 06, 2018

- Note: 1. The calibration interval of the above test instruments is 12 months and the calibrations are traceable to NML/ROC and NIST/USA.  
 2. The test was performed in HwaYa Chamber 9.  
 3. The FCC Designation Number is TW0003. The number will be varied with the Lab location and scope as attached.  
 4. The IC Site Registration No. is IC7450F-9.

### 4.1.3 Test Procedures

#### For Radiated emission below 30MHz

- a. The EUT was placed on the top of a rotating table 0.8 meters above the ground at a 3 meter chamber room. The table was rotated 360 degrees to determine the position of the highest radiation.
- b. The EUT was set 3 meters away from the interference-receiving antenna, which was mounted on the top of a variable-height antenna tower.
- c. Both X and Y axes of the antenna are set to make the measurement.
- d. For each suspected emission, the EUT was arranged to its worst case and the rotatable table was turned from 0 degrees to 360 degrees to find the maximum reading.
- e. The test-receiver system was set to Quasi-Peak Detect Function and Specified Bandwidth with Maximum Hold Mode.

Note:

1. The resolution bandwidth and video bandwidth of test receiver/spectrum analyzer is 9kHz at frequency below 30MHz.

#### For Radiated emission above 30MHz

- a. The EUT was placed on the top of a rotating table 0.8 meters (for 30MHz ~ 1GHz) / 1.5 meters (for above 1GHz) above the ground at 3 meter chamber room for test. The table was rotated 360 degrees to determine the position of the highest radiation.
- b. The EUT was set 3 meters away from the interference-receiving antenna, which was mounted on the top of a variable-height antenna tower.
- c. The height of antenna is varied from one meter to four meters above the ground to determine the maximum value of the field strength. Both horizontal and vertical polarizations of the antenna are set to make the measurement.
- d. For each suspected emission, the EUT was arranged to its worst case and then the antenna was tuned to heights from 1 meter to 4 meters and the rotatable table was turned from 0 degrees to 360 degrees to find the maximum reading.
- e. The test-receiver system was set to quasi-peak detect function and specified bandwidth with maximum hold mode when the test frequency is below 1 GHz.
- f. The test-receiver system was set to peak and average detect function and specified bandwidth with maximum hold mode when the test frequency is above 1 GHz. If the peak reading value also meets average limit, measurement with the average detector is unnecessary.

Note:

1. The resolution bandwidth and video bandwidth of test receiver/spectrum analyzer is 120kHz for Quasi-peak detection (QP) at frequency below 1GHz.
2. The resolution bandwidth of test receiver/spectrum analyzer is 1 MHz and the video bandwidth is 3 MHz for Peak detection (PK) at frequency above 1GHz.
3. The resolution bandwidth of test receiver/spectrum analyzer is 1MHz and the video bandwidth is  $\geq 1/T$  (Duty cycle < 98%) or 10Hz (Duty cycle  $\geq 98\%$ ) for Average detection (AV) at frequency above 1GHz.
4. All modes of operation were investigated and the worst-case emissions are reported.

### 4.1.4 Deviation from Test Standard

No deviation.

#### 4.1.5 Test Setup

##### For Radiated emission below 30MHz

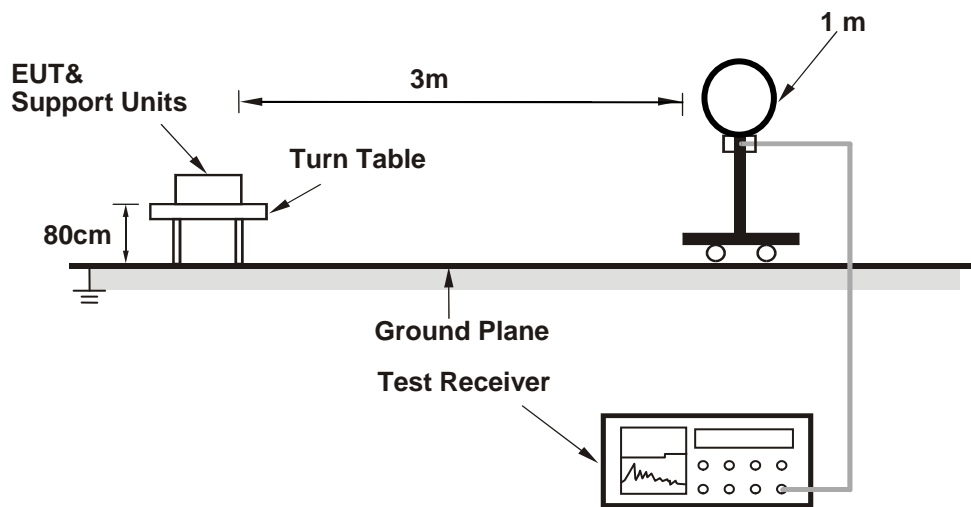

##### For Radiated emission 30MHz to 1GHz

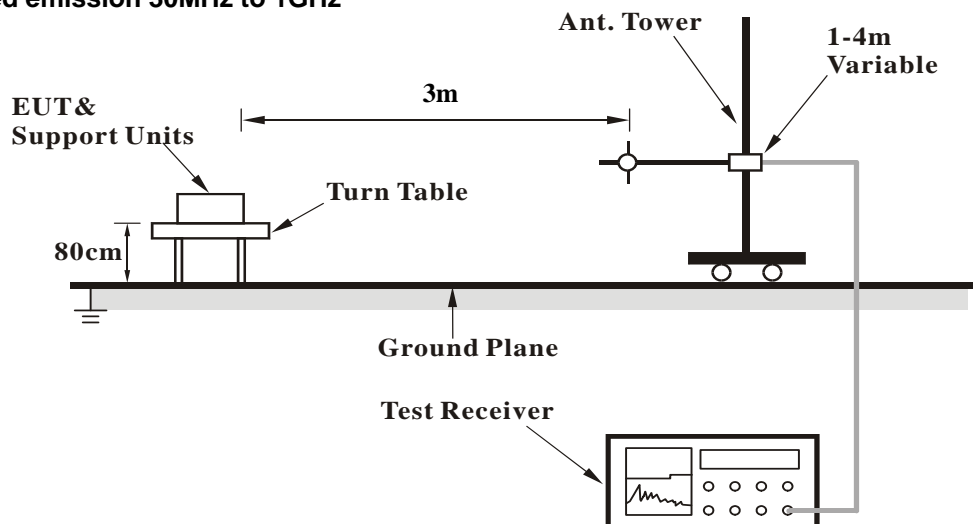



### For Radiated emission above 1GHz

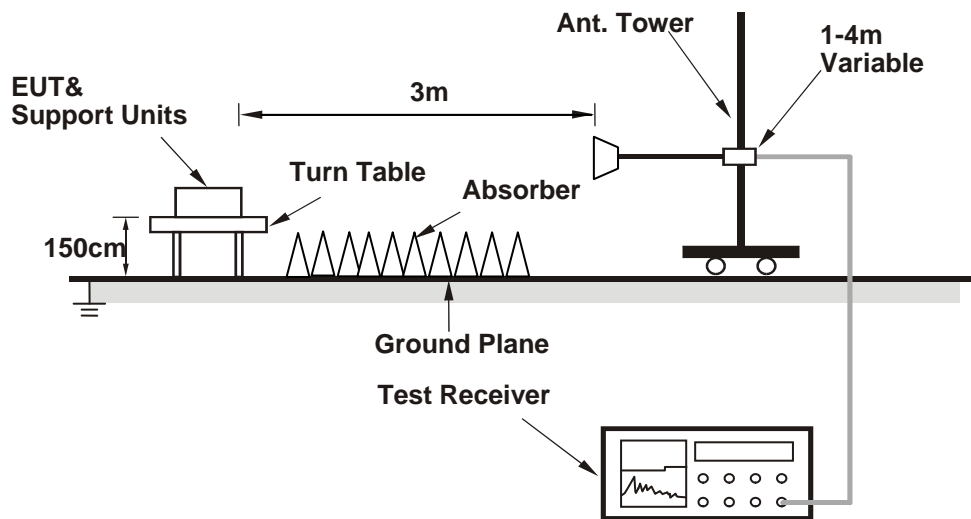

For the actual test configuration, please refer to the attached file (Test Setup Photo).

#### 4.1.6 EUT Operating Conditions

- Connected EUT with convertible board and placed the EUT on the testing table.
- Prepared a notebook to act as a communication partner and placed it outside of testing area.
- The communication partner connected with EUT via a RJ45 cable and ran a test program (provided by manufacturer) to enable EUT under transmission condition continuously at specific channel frequency.
- The communication partner sent data to EUT by command "PING".

#### 4.1.7 Test Results

Above 1GHz data:

802.11a

CHANNEL	TX Channel 36	DETECTOR	Peak (PK)
FREQUENCY RANGE	1GHz ~ 40GHz	FUNCTION	Average (AV)

ANTENNA POLARITY & TEST DISTANCE: HORIZONTAL AT 3 M								
NO.	FREQ. (MHz)	EMISSION LEVEL (dBuV/m)	LIMIT (dBuV/m)	MARGIN (dB)	ANTENNA HEIGHT (m)	TABLE ANGLE (Degree)	RAW VALUE (dBuV)	CORRECTION FACTOR (dB/m)
1	5150.00	59.2 PK	74.0	-14.8	1.53 H	139	55.3	3.9
2	5150.00	45.7 AV	54.0	-8.3	1.53 H	139	41.8	3.9
3	*5180.00	102.6 PK			1.48 H	138	61.9	40.7
4	*5180.00	92.5 AV			1.48 H	138	51.8	40.7
5	#10360.00	59.3 PK	74.0	-14.7	2.84 H	126	43.8	15.5
6	#10360.00	45.6 AV	54.0	-8.4	2.84 H	126	30.1	15.5
ANTENNA POLARITY & TEST DISTANCE: VERTICAL AT 3 M								
NO.	FREQ. (MHz)	EMISSION LEVEL (dBuV/m)	LIMIT (dBuV/m)	MARGIN (dB)	ANTENNA HEIGHT (m)	TABLE ANGLE (Degree)	RAW VALUE (dBuV)	CORRECTION FACTOR (dB/m)
1	5150.00	68.1 PK	74.0	-5.9	1.01 V	81	64.2	3.9
2	<b>5150.00</b>	<b>53.0 AV</b>	<b>54.0</b>	<b>-1.0</b>	<b>1.01 V</b>	<b>81</b>	<b>49.1</b>	<b>3.9</b>
3	*5180.00	113.5 PK			1.05 V	83	72.8	40.7
4	*5180.00	103.1 AV			1.05 V	83	62.4	40.7
5	#10360.00	60.3 PK	74.0	-13.7	1.84 V	198	44.8	15.5
6	#10360.00	47.1 AV	54.0	-6.9	1.84 V	198	31.6	15.5

Remarks:

1. Emission Level(dBuV/m) = Raw Value(dBuV) + Correction Factor(dB/m)
2. Correction Factor(dB/m) = Antenna Factor(dB/m) + Cable Factor(dB) – Pre-Amplifier Factor(dB)
3. The other emission levels were very low against the limit.
4. Margin value = Emission Level – Limit value
5. " \* ": Fundamental frequency.
6. " # ": The radiated frequency is out of the restricted band.

CHANNEL	TX Channel 40	DETECTOR	Peak (PK)
FREQUENCY RANGE	1GHz ~ 40GHz	FUNCTION	Average (AV)

**ANTENNA POLARITY & TEST DISTANCE: HORIZONTAL AT 3 M**

NO.	FREQ. (MHz)	EMISSION LEVEL (dBuV/m)	LIMIT (dBuV/m)	MARGIN (dB)	ANTENNA HEIGHT (m)	TABLE ANGLE (Degree)	RAW VALUE (dBuV)	CORRECTION FACTOR (dB/m)
1	*5200.00	102.6 PK			1.59 H	96	61.8	40.8
2	*5200.00	92.3 AV			1.59 H	96	51.5	40.8
3	#10400.00	58.3 PK	74.0	-15.7	1.65 H	138	42.8	15.5
4	#10400.00	45.3 AV	54.0	-8.7	1.65 H	138	29.8	15.5

**ANTENNA POLARITY & TEST DISTANCE: VERTICAL AT 3 M**

NO.	FREQ. (MHz)	EMISSION LEVEL (dBuV/m)	LIMIT (dBuV/m)	MARGIN (dB)	ANTENNA HEIGHT (m)	TABLE ANGLE (Degree)	RAW VALUE (dBuV)	CORRECTION FACTOR (dB/m)
1	*5200.00	113.8 PK			1.24 V	116	73.0	40.8
2	*5200.00	103.3 AV			1.24 V	116	62.5	40.8
3	#10400.00	58.2 PK	74.0	-15.8	2.44 V	211	42.7	15.5
4	#10400.00	45.1 AV	54.0	-8.9	2.44 V	211	29.6	15.5

**Remarks:**

1. Emission Level(dBuV/m) = Raw Value(dBuV) + Correction Factor(dB/m)
2. Correction Factor(dB/m) = Antenna Factor(dB/m) + Cable Factor(dB) – Pre-Amplifier Factor(dB)
3. The other emission levels were very low against the limit.
4. Margin value = Emission Level – Limit value
5. " \* ": Fundamental frequency.
6. " # ": The radiated frequency is out of the restricted band.

CHANNEL	TX Channel 48	DETECTOR FUNCTION	Peak (PK)
FREQUENCY RANGE	1GHz ~ 40GHz		Average (AV)

**ANTENNA POLARITY & TEST DISTANCE: HORIZONTAL AT 3 M**

NO.	FREQ. (MHz)	EMISSION LEVEL (dBuV/m)	LIMIT (dBuV/m)	MARGIN (dB)	ANTENNA HEIGHT (m)	TABLE ANGLE (Degree)	RAW VALUE (dBuV)	CORRECTION FACTOR (dB/m)
1	*5240.00	104.3 PK			1.60 H	97	63.5	40.8
2	*5240.00	94.3 AV			1.60 H	97	53.5	40.8
3	5350.00	56.8 PK	74.0	-17.2	1.33 H	142	52.4	4.4
4	5350.00	44.0 AV	54.0	-10.0	1.33 H	142	39.6	4.4
5	#10480.00	57.7 PK	74.0	-16.3	3.78 H	24	42.6	15.1
6	#10480.00	44.2 AV	54.0	-9.8	3.78 H	24	29.1	15.1

**ANTENNA POLARITY & TEST DISTANCE: VERTICAL AT 3 M**

NO.	FREQ. (MHz)	EMISSION LEVEL (dBuV/m)	LIMIT (dBuV/m)	MARGIN (dB)	ANTENNA HEIGHT (m)	TABLE ANGLE (Degree)	RAW VALUE (dBuV)	CORRECTION FACTOR (dB/m)
1	*5240.00	113.3 PK			1.22 V	116	72.5	40.8
2	*5240.00	103.2 AV			1.22 V	116	62.4	40.8
3	5350.00	57.3 PK	74.0	-16.7	1.25 V	122	52.9	4.4
4	5350.00	44.2 AV	54.0	-9.8	1.25 V	122	39.8	4.4
5	#10480.00	57.7 PK	74.0	-16.3	2.86 V	195	42.6	15.1
6	#10480.00	44.6 AV	54.0	-9.4	2.86 V	195	29.5	15.1

**Remarks:**

1. Emission Level(dBuV/m) = Raw Value(dBuV) + Correction Factor(dB/m)
2. Correction Factor(dB/m) = Antenna Factor(dB/m) + Cable Factor(dB) – Pre-Amplifier Factor(dB)
3. The other emission levels were very low against the limit.
4. Margin value = Emission Level – Limit value
5. " \* ": Fundamental frequency.
6. " # ": The radiated frequency is out of the restricted band.

CHANNEL	TX Channel 149	DETECTOR FUNCTION	Peak (PK)
FREQUENCY RANGE	1GHz ~ 40GHz		Average (AV)

**ANTENNA POLARITY & TEST DISTANCE: HORIZONTAL AT 3 M**

NO.	FREQ. (MHz)	EMISSION LEVEL (dBuV/m)	LIMIT (dBuV/m)	MARGIN (dB)	ANTENNA HEIGHT (m)	TABLE ANGLE (Degree)	RAW VALUE (dBuV)	CORRECTION FACTOR (dB/m)
1	#5611.20	58.3 PK	68.2	-9.9	1.00 H	239	53.5	4.8
2	*5745.00	105.2 PK			1.00 H	239	63.7	41.5
3	*5745.00	94.7 AV			1.00 H	239	53.2	41.5
4	#5992.00	57.6 PK	68.2	-10.6	1.00 H	239	52.8	4.8
5	11490.00	56.9 PK	74.0	-17.1	1.75 H	285	40.9	16.0
6	11490.00	45.4 AV	54.0	-8.6	1.75 H	285	29.4	16.0

**ANTENNA POLARITY & TEST DISTANCE: VERTICAL AT 3 M**

NO.	FREQ. (MHz)	EMISSION LEVEL (dBuV/m)	LIMIT (dBuV/m)	MARGIN (dB)	ANTENNA HEIGHT (m)	TABLE ANGLE (Degree)	RAW VALUE (dBuV)	CORRECTION FACTOR (dB/m)
1	#5600.00	59.8 PK	68.2	-8.4	3.63 V	155	55.0	4.8
2	*5745.00	113.0 PK			3.63 V	155	71.5	41.5
3	*5745.00	102.7 AV			3.63 V	155	61.2	41.5
4	#5956.00	58.3 PK	68.2	-9.9	3.63 V	155	53.5	4.8
5	11490.00	57.6 PK	74.0	-16.4	2.47 V	233	41.6	16.0
6	11490.00	46.8 AV	54.0	-7.2	2.47 V	233	30.8	16.0

**Remarks:**

1. Emission Level(dBuV/m) = Raw Value(dBuV) + Correction Factor(dB/m)
2. Correction Factor(dB/m) = Antenna Factor(dB/m) + Cable Factor(dB) – Pre-Amplifier Factor(dB)
3. The other emission levels were very low against the limit.
4. Margin value = Emission Level – Limit value
5. " \* ": Fundamental frequency.
6. " # ": The radiated frequency is out of the restricted band.

CHANNEL	TX Channel 157	DETECTOR FUNCTION	Peak (PK)
FREQUENCY RANGE	1GHz ~ 40GHz		Average (AV)

**ANTENNA POLARITY & TEST DISTANCE: HORIZONTAL AT 3 M**

NO.	FREQ. (MHz)	EMISSION LEVEL (dBuV/m)	LIMIT (dBuV/m)	MARGIN (dB)	ANTENNA HEIGHT (m)	TABLE ANGLE (Degree)	RAW VALUE (dBuV)	CORRECTION FACTOR (dB/m)
1	#5616.80	58.3 PK	68.2	-9.9	1.00 H	238	53.5	4.8
2	*5785.00	104.0 PK			1.00 H	238	62.5	41.5
3	*5785.00	93.8 AV			1.00 H	238	52.3	41.5
4	#5980.80	58.5 PK	68.2	-9.7	1.00 H	238	53.7	4.8
5	11570.00	56.4 PK	74.0	-17.6	2.86 H	124	40.7	15.7
6	11570.00	45.3 AV	54.0	-8.7	2.86 H	124	29.6	15.7

**ANTENNA POLARITY & TEST DISTANCE: VERTICAL AT 3 M**

NO.	FREQ. (MHz)	EMISSION LEVEL (dBuV/m)	LIMIT (dBuV/m)	MARGIN (dB)	ANTENNA HEIGHT (m)	TABLE ANGLE (Degree)	RAW VALUE (dBuV)	CORRECTION FACTOR (dB/m)
1	#5632.00	59.6 PK	68.2	-8.6	3.76 V	164	54.9	4.7
2	*5785.00	111.7 PK			3.76 V	164	70.2	41.5
3	*5785.00	101.1 AV			3.76 V	164	59.6	41.5
4	#5970.40	57.7 PK	68.2	-10.5	3.76 V	164	52.9	4.8
5	11570.00	56.9 PK	74.0	-17.1	3.17 V	144	41.2	15.7
6	11570.00	46.5 AV	54.0	-7.5	3.17 V	144	30.8	15.7

**Remarks:**

1. Emission Level(dBuV/m) = Raw Value(dBuV) + Correction Factor(dB/m)
2. Correction Factor(dB/m) = Antenna Factor(dB/m) + Cable Factor(dB) – Pre-Amplifier Factor(dB)
3. The other emission levels were very low against the limit.
4. Margin value = Emission Level – Limit value
5. " \* ": Fundamental frequency.
6. " # ": The radiated frequency is out of the restricted band.

CHANNEL	TX Channel 165	DETECTOR FUNCTION	Peak (PK)
FREQUENCY RANGE	1GHz ~ 40GHz		Average (AV)

**ANTENNA POLARITY & TEST DISTANCE: HORIZONTAL AT 3 M**

NO.	FREQ. (MHz)	EMISSION LEVEL (dBuV/m)	LIMIT (dBuV/m)	MARGIN (dB)	ANTENNA HEIGHT (m)	TABLE ANGLE (Degree)	RAW VALUE (dBuV)	CORRECTION FACTOR (dB/m)
1	#5618.40	58.5 PK	68.2	-9.7	1.10 H	280	53.7	4.8
2	*5825.00	103.3 PK			1.10 H	280	61.7	41.6
3	*5825.00	93.2 AV			1.10 H	280	51.6	41.6
4	#5976.80	57.8 PK	68.2	-10.4	1.10 H	280	53.0	4.8
5	11650.00	56.3 PK	74.0	-17.7	3.42 H	172	40.7	15.6
6	11650.00	45.0 AV	54.0	-9.0	3.42 H	172	29.4	15.6

**ANTENNA POLARITY & TEST DISTANCE: VERTICAL AT 3 M**

NO.	FREQ. (MHz)	EMISSION LEVEL (dBuV/m)	LIMIT (dBuV/m)	MARGIN (dB)	ANTENNA HEIGHT (m)	TABLE ANGLE (Degree)	RAW VALUE (dBuV)	CORRECTION FACTOR (dB/m)
1	#5622.40	58.7 PK	68.2	-9.5	2.37 V	162	53.9	4.8
2	*5825.00	109.8 PK			2.37 V	162	68.2	41.6
3	*5825.00	99.4 AV			2.37 V	162	57.8	41.6
4	#5988.00	57.5 PK	68.2	-10.7	2.37 V	162	52.7	4.8
5	11650.00	57.2 PK	74.0	-16.8	1.51 V	307	41.6	15.6
6	11650.00	46.3 AV	54.0	-7.7	1.51 V	307	30.7	15.6

**Remarks:**

1. Emission Level(dBuV/m) = Raw Value(dBuV) + Correction Factor(dB/m)
2. Correction Factor(dB/m) = Antenna Factor(dB/m) + Cable Factor(dB) – Pre-Amplifier Factor(dB)
3. The other emission levels were very low against the limit.
4. Margin value = Emission Level – Limit value
5. " \* ": Fundamental frequency.
6. " # ": The radiated frequency is out of the restricted band.

802.11n (HT20)

CHANNEL	TX Channel 36	DETECTOR	Peak (PK)
FREQUENCY RANGE	1GHz ~ 40GHz	FUNCTION	Average (AV)

ANTENNA POLARITY & TEST DISTANCE: HORIZONTAL AT 3 M								
NO.	FREQ. (MHz)	EMISSION LEVEL (dBuV/m)	LIMIT (dBuV/m)	MARGIN (dB)	ANTENNA HEIGHT (m)	TABLE ANGLE (Degree)	RAW VALUE (dBuV)	CORRECTION FACTOR (dB/m)
1	5150.00	59.2 PK	74.0	-14.8	1.23 H	218	55.3	3.9
2	5150.00	46.4 AV	54.0	-7.6	1.23 H	218	42.5	3.9
3	*5180.00	108.1 PK			1.32 H	87	67.4	40.7
4	*5180.00	97.7 AV			1.32 H	87	57.0	40.7
5	#10360.00	58.4 PK	74.0	-15.6	1.77 H	96	42.9	15.5
6	#10360.00	45.7 AV	54.0	-8.3	1.77 H	96	30.2	15.5
ANTENNA POLARITY & TEST DISTANCE: VERTICAL AT 3 M								
NO.	FREQ. (MHz)	EMISSION LEVEL (dBuV/m)	LIMIT (dBuV/m)	MARGIN (dB)	ANTENNA HEIGHT (m)	TABLE ANGLE (Degree)	RAW VALUE (dBuV)	CORRECTION FACTOR (dB/m)
1	5150.00	68.1 PK	74.0	-5.9	1.00 V	278	64.2	3.9
2	5150.00	52.9 AV	54.0	-1.1	1.00 V	278	49.0	3.9
3	*5180.00	117.4 PK			1.08 V	109	76.7	40.7
4	*5180.00	107.1 AV			1.08 V	109	66.4	40.7
5	#10360.00	58.0 PK	74.0	-16.0	1.98 V	133	42.5	15.5
6	#10360.00	45.3 AV	54.0	-8.7	1.98 V	133	29.8	15.5

Remarks:

1. Emission Level(dBuV/m) = Raw Value(dBuV) + Correction Factor(dB/m)
2. Correction Factor(dB/m) = Antenna Factor(dB/m) + Cable Factor(dB) – Pre-Amplifier Factor(dB)
3. The other emission levels were very low against the limit.
4. Margin value = Emission Level – Limit value
5. " \* ": Fundamental frequency.
6. " # ": The radiated frequency is out of the restricted band.



CHANNEL	TX Channel 40	DETECTOR	Peak (PK)
FREQUENCY RANGE	1GHz ~ 40GHz	FUNCTION	Average (AV)

**ANTENNA POLARITY & TEST DISTANCE: HORIZONTAL AT 3 M**

NO.	FREQ. (MHz)	EMISSION LEVEL (dBuV/m)	LIMIT (dBuV/m)	MARGIN (dB)	ANTENNA HEIGHT (m)	TABLE ANGLE (Degree)	RAW VALUE (dBuV)	CORRECTION FACTOR (dB/m)
1	*5200.00	110.6 PK			3.06 H	157	69.8	40.8
2	*5200.00	99.8 AV			3.06 H	157	59.0	40.8
3	#10400.00	61.4 PK	74.0	-12.6	2.75 H	163	45.9	15.5
4	#10400.00	47.6 AV	54.0	-6.4	2.75 H	163	32.1	15.5

**ANTENNA POLARITY & TEST DISTANCE: VERTICAL AT 3 M**

NO.	FREQ. (MHz)	EMISSION LEVEL (dBuV/m)	LIMIT (dBuV/m)	MARGIN (dB)	ANTENNA HEIGHT (m)	TABLE ANGLE (Degree)	RAW VALUE (dBuV)	CORRECTION FACTOR (dB/m)
1	*5200.00	118.8 PK			1.39 V	358	78.0	40.8
2	*5200.00	108.1 AV			1.39 V	358	67.3	40.8
3	#10400.00	60.3 PK	74.0	-13.7	1.87 V	143	44.8	15.5
4	#10400.00	46.3 AV	54.0	-7.7	1.87 V	143	30.8	15.5

**Remarks:**

1. Emission Level(dBuV/m) = Raw Value(dBuV) + Correction Factor(dB/m)
2. Correction Factor(dB/m) = Antenna Factor(dB/m) + Cable Factor(dB) – Pre-Amplifier Factor(dB)
3. The other emission levels were very low against the limit.
4. Margin value = Emission Level – Limit value
5. " \* ": Fundamental frequency.
6. " # ": The radiated frequency is out of the restricted band.

CHANNEL	TX Channel 48	DETECTOR FUNCTION	Peak (PK)
FREQUENCY RANGE	1GHz ~ 40GHz		Average (AV)

**ANTENNA POLARITY & TEST DISTANCE: HORIZONTAL AT 3 M**

NO.	FREQ. (MHz)	EMISSION LEVEL (dBuV/m)	LIMIT (dBuV/m)	MARGIN (dB)	ANTENNA HEIGHT (m)	TABLE ANGLE (Degree)	RAW VALUE (dBuV)	CORRECTION FACTOR (dB/m)
1	*5240.00	111.3 PK			3.35 H	155	70.5	40.8
2	*5240.00	100.9 AV			3.35 H	155	60.1	40.8
3	5350.00	57.7 PK	74.0	-16.3	3.41 H	158	53.3	4.4
4	5350.00	44.2 AV	54.0	-9.8	3.41 H	158	39.8	4.4
5	#10480.00	58.7 PK	74.0	-15.3	2.18 H	345	43.6	15.1
6	#10480.00	45.7 AV	54.0	-8.3	2.18 H	345	30.6	15.1

**ANTENNA POLARITY & TEST DISTANCE: VERTICAL AT 3 M**

NO.	FREQ. (MHz)	EMISSION LEVEL (dBuV/m)	LIMIT (dBuV/m)	MARGIN (dB)	ANTENNA HEIGHT (m)	TABLE ANGLE (Degree)	RAW VALUE (dBuV)	CORRECTION FACTOR (dB/m)
1	*5240.00	120.0 PK			1.52 V	2	79.2	40.8
2	*5240.00	109.8 AV			1.52 V	2	69.0	40.8
3	5350.00	60.1 PK	74.0	-13.9	1.57 V	14	55.7	4.4
4	5350.00	46.9 AV	54.0	-7.1	1.57 V	14	42.5	4.4
5	#10480.00	58.4 PK	74.0	-15.6	2.74 V	113	43.3	15.1
6	#10480.00	45.0 AV	54.0	-9.0	2.74 V	113	29.9	15.1

**Remarks:**

1. Emission Level(dBuV/m) = Raw Value(dBuV) + Correction Factor(dB/m)
2. Correction Factor(dB/m) = Antenna Factor(dB/m) + Cable Factor(dB) – Pre-Amplifier Factor(dB)
3. The other emission levels were very low against the limit.
4. Margin value = Emission Level – Limit value
5. " \* ": Fundamental frequency.
6. " # ": The radiated frequency is out of the restricted band.

CHANNEL	TX Channel 149	DETECTOR FUNCTION	Peak (PK)
FREQUENCY RANGE	1GHz ~ 40GHz		Average (AV)

**ANTENNA POLARITY & TEST DISTANCE: HORIZONTAL AT 3 M**

NO.	FREQ. (MHz)	EMISSION LEVEL (dBuV/m)	LIMIT (dBuV/m)	MARGIN (dB)	ANTENNA HEIGHT (m)	TABLE ANGLE (Degree)	RAW VALUE (dBuV)	CORRECTION FACTOR (dB/m)
1	#5626.40	58.4 PK	68.2	-9.8	1.00 H	308	53.7	4.7
2	*5745.00	108.5 PK			1.00 H	308	67.0	41.5
3	*5745.00	98.4 AV			1.00 H	308	56.9	41.5
4	#5928.80	57.9 PK	68.2	-10.3	1.00 H	308	53.1	4.8
5	11490.00	56.9 PK	74.0	-17.1	1.00 H	308	40.9	16.0
6	11490.00	45.6 AV	54.0	-8.4	1.00 H	308	29.6	16.0

**ANTENNA POLARITY & TEST DISTANCE: VERTICAL AT 3 M**

NO.	FREQ. (MHz)	EMISSION LEVEL (dBuV/m)	LIMIT (dBuV/m)	MARGIN (dB)	ANTENNA HEIGHT (m)	TABLE ANGLE (Degree)	RAW VALUE (dBuV)	CORRECTION FACTOR (dB/m)
1	#5606.40	60.9 PK	68.2	-7.3	2.28 V	194	56.1	4.8
2	*5745.00	117.3 PK			2.28 V	194	75.8	41.5
3	*5745.00	106.8 AV			2.28 V	194	65.3	41.5
4	#5965.60	59.4 PK	68.2	-8.8	2.28 V	194	54.6	4.8
5	11490.00	57.5 PK	74.0	-16.5	3.10 V	208	41.5	16.0
6	11490.00	46.6 AV	54.0	-7.4	3.10 V	208	30.6	16.0

**Remarks:**

1. Emission Level(dBuV/m) = Raw Value(dBuV) + Correction Factor(dB/m)
2. Correction Factor(dB/m) = Antenna Factor(dB/m) + Cable Factor(dB) – Pre-Amplifier Factor(dB)
3. The other emission levels were very low against the limit.
4. Margin value = Emission Level – Limit value
5. " \* ": Fundamental frequency.
6. " # ": The radiated frequency is out of the restricted band.

CHANNEL	TX Channel 157	DETECTOR FUNCTION	Peak (PK)
FREQUENCY RANGE	1GHz ~ 40GHz		Average (AV)

**ANTENNA POLARITY & TEST DISTANCE: HORIZONTAL AT 3 M**

NO.	FREQ. (MHz)	EMISSION LEVEL (dBuV/m)	LIMIT (dBuV/m)	MARGIN (dB)	ANTENNA HEIGHT (m)	TABLE ANGLE (Degree)	RAW VALUE (dBuV)	CORRECTION FACTOR (dB/m)
1	#5635.20	58.2 PK	68.2	-10.0	1.13 H	13	53.5	4.7
2	*5785.00	109.3 PK			1.13 H	13	67.8	41.5
3	*5785.00	99.1 AV			1.13 H	13	57.6	41.5
4	#5941.60	58.4 PK	68.2	-9.8	1.13 H	13	53.6	4.8
5	11570.00	57.4 PK	74.0	-16.6	3.61 H	108	41.7	15.7
6	11570.00	45.3 AV	54.0	-8.7	3.61 H	108	29.6	15.7

**ANTENNA POLARITY & TEST DISTANCE: VERTICAL AT 3 M**

NO.	FREQ. (MHz)	EMISSION LEVEL (dBuV/m)	LIMIT (dBuV/m)	MARGIN (dB)	ANTENNA HEIGHT (m)	TABLE ANGLE (Degree)	RAW VALUE (dBuV)	CORRECTION FACTOR (dB/m)
1	#5605.60	60.3 PK	68.2	-7.9	1.22 V	62	55.5	4.8
2	*5785.00	117.4 PK			1.22 V	62	75.9	41.5
3	*5785.00	107.1 AV			1.22 V	62	65.6	41.5
4	#5946.40	57.7 PK	68.2	-10.5	1.22 V	62	52.9	4.8
5	11570.00	57.5 PK	74.0	-16.5	2.53 V	142	41.8	15.7
6	11570.00	46.4 AV	54.0	-7.6	2.53 V	142	30.7	15.7

**Remarks:**

1. Emission Level(dBuV/m) = Raw Value(dBuV) + Correction Factor(dB/m)
2. Correction Factor(dB/m) = Antenna Factor(dB/m) + Cable Factor(dB) – Pre-Amplifier Factor(dB)
3. The other emission levels were very low against the limit.
4. Margin value = Emission Level – Limit value
5. " \* ": Fundamental frequency.
6. " # ": The radiated frequency is out of the restricted band.

CHANNEL	TX Channel 165	DETECTOR FUNCTION	Peak (PK)
FREQUENCY RANGE	1GHz ~ 40GHz		Average (AV)

**ANTENNA POLARITY & TEST DISTANCE: HORIZONTAL AT 3 M**

NO.	FREQ. (MHz)	EMISSION LEVEL (dBuV/m)	LIMIT (dBuV/m)	MARGIN (dB)	ANTENNA HEIGHT (m)	TABLE ANGLE (Degree)	RAW VALUE (dBuV)	CORRECTION FACTOR (dB/m)
1	#5609.60	58.4 PK	68.2	-9.8	1.07 H	13	53.6	4.8
2	*5825.00	110.4 PK			1.07 H	13	68.8	41.6
3	*5825.00	99.1 AV			1.07 H	13	57.5	41.6
4	#5992.80	57.9 PK	68.2	-10.3	1.07 H	13	53.1	4.8
5	11650.00	56.1 PK	74.0	-17.9	1.94 H	317	40.5	15.6
6	11650.00	45.0 AV	54.0	-9.0	1.94 H	317	29.4	15.6

**ANTENNA POLARITY & TEST DISTANCE: VERTICAL AT 3 M**

NO.	FREQ. (MHz)	EMISSION LEVEL (dBuV/m)	LIMIT (dBuV/m)	MARGIN (dB)	ANTENNA HEIGHT (m)	TABLE ANGLE (Degree)	RAW VALUE (dBuV)	CORRECTION FACTOR (dB/m)
1	#5631.20	62.0 PK	68.2	-6.2	2.38 V	225	57.3	4.7
2	*5825.00	118.0 PK			2.38 V	225	76.4	41.6
3	*5825.00	107.5 AV			2.38 V	225	65.9	41.6
4	#5999.20	58.4 PK	68.2	-9.8	2.38 V	225	53.6	4.8
5	11650.00	57.2 PK	74.0	-16.8	2.96 V	217	41.6	15.6
6	11650.00	46.3 AV	54.0	-7.7	2.96 V	217	30.7	15.6

**Remarks:**

1. Emission Level(dBuV/m) = Raw Value(dBuV) + Correction Factor(dB/m)
2. Correction Factor(dB/m) = Antenna Factor(dB/m) + Cable Factor(dB) – Pre-Amplifier Factor(dB)
3. The other emission levels were very low against the limit.
4. Margin value = Emission Level – Limit value
5. " \* ": Fundamental frequency.
6. " # ": The radiated frequency is out of the restricted band.

## 802.11n (HT40)

CHANNEL	TX Channel 38	DETECTOR FUNCTION	Peak (PK) Average (AV)
FREQUENCY RANGE	1GHz ~ 40GHz		

## ANTENNA POLARITY &amp; TEST DISTANCE: HORIZONTAL AT 3 M

NO.	FREQ. (MHz)	EMISSION LEVEL (dBuV/m)	LIMIT (dBuV/m)	MARGIN (dB)	ANTENNA HEIGHT (m)	TABLE ANGLE (Degree)	RAW VALUE (dBuV)	CORRECTION FACTOR (dB/m)
1	5150.00	57.3 PK	74.0	-16.7	3.00 H	94	53.4	3.9
2	5150.00	45.0 AV	54.0	-9.0	3.00 H	94	41.1	3.9
3	*5190.00	101.7 PK			3.16 H	92	60.9	40.8
4	*5190.00	92.0 AV			3.16 H	92	51.2	40.8
5	#10380.00	58.7 PK	74.0	-15.3	1.84 H	320	43.1	15.6
6	#10380.00	45.1 AV	54.0	-8.9	1.84 H	320	29.5	15.6

## ANTENNA POLARITY &amp; TEST DISTANCE: VERTICAL AT 3 M

NO.	FREQ. (MHz)	EMISSION LEVEL (dBuV/m)	LIMIT (dBuV/m)	MARGIN (dB)	ANTENNA HEIGHT (m)	TABLE ANGLE (Degree)	RAW VALUE (dBuV)	CORRECTION FACTOR (dB/m)
1	5150.00	69.2 PK	74.0	-4.8	1.25 V	208	65.3	3.9
2	5150.00	52.7 AV	54.0	-1.3	1.25 V	208	48.8	3.9
3	*5190.00	109.9 PK			1.25 V	277	69.1	40.8
4	*5190.00	100.0 AV			1.25 V	277	59.2	40.8
5	#10380.00	58.2 PK	74.0	-15.8	2.66 V	300	42.6	15.6
6	#10380.00	45.0 AV	54.0	-9.0	2.66 V	300	29.4	15.6

## Remarks:

1. Emission Level(dBuV/m) = Raw Value(dBuV) + Correction Factor(dB/m)
2. Correction Factor(dB/m) = Antenna Factor(dB/m) + Cable Factor(dB) – Pre-Amplifier Factor(dB)
3. The other emission levels were very low against the limit.
4. Margin value = Emission Level – Limit value
5. " \* ": Fundamental frequency.
6. " # ": The radiated frequency is out of the restricted band.

CHANNEL	TX Channel 46	DETECTOR FUNCTION	Peak (PK)
FREQUENCY RANGE	1GHz ~ 40GHz		Average (AV)

ANTENNA POLARITY & TEST DISTANCE: HORIZONTAL AT 3 M								
NO.	FREQ. (MHz)	EMISSION LEVEL (dBuV/m)	LIMIT (dBuV/m)	MARGIN (dB)	ANTENNA HEIGHT (m)	TABLE ANGLE (Degree)	RAW VALUE (dBuV)	CORRECTION FACTOR (dB/m)
1	5150.00	57.0 PK	74.0	-17.0	1.55 H	96	53.1	3.9
2	5150.00	45.2 AV	54.0	-8.8	1.55 H	96	41.3	3.9
3	*5230.00	106.7 PK			1.59 H	90	65.9	40.8
4	*5230.00	96.8 AV			1.59 H	90	56.0	40.8
5	5350.00	57.6 PK	74.0	-16.4	1.42 H	100	53.2	4.4
6	5350.00	44.2 AV	54.0	-9.8	1.42 H	100	39.8	4.4
7	#10460.00	57.1 PK	74.0	-16.9	3.00 H	182	41.9	15.2
8	#10460.00	44.5 AV	54.0	-9.5	3.00 H	182	29.3	15.2

ANTENNA POLARITY & TEST DISTANCE: VERTICAL AT 3 M								
NO.	FREQ. (MHz)	EMISSION LEVEL (dBuV/m)	LIMIT (dBuV/m)	MARGIN (dB)	ANTENNA HEIGHT (m)	TABLE ANGLE (Degree)	RAW VALUE (dBuV)	CORRECTION FACTOR (dB/m)
1	5150.00	69.3 PK	74.0	-4.7	1.38 V	206	65.4	3.9
2	5150.00	52.7 AV	54.0	-1.3	1.38 V	206	48.8	3.9
3	*5230.00	117.2 PK			1.30 V	16	76.4	40.8
4	*5230.00	106.8 AV			1.30 V	16	66.0	40.8
5	5350.00	59.6 PK	74.0	-14.4	1.40 V	201	55.2	4.4
6	5350.00	46.8 AV	54.0	-7.2	1.40 V	201	42.4	4.4
7	#10460.00	58.1 PK	74.0	-15.9	2.73 V	215	42.9	15.2
8	#10460.00	44.1 AV	54.0	-9.9	2.73 V	215	28.9	15.2

Remarks:

1. Emission Level(dBuV/m) = Raw Value(dBuV) + Correction Factor(dB/m)
2. Correction Factor(dB/m) = Antenna Factor(dB/m) + Cable Factor(dB) – Pre-Amplifier Factor(dB)
3. The other emission levels were very low against the limit.
4. Margin value = Emission Level – Limit value
5. " \* ": Fundamental frequency.
6. " # ": The radiated frequency is out of the restricted band.

CHANNEL	TX Channel 151	DETECTOR FUNCTION	Peak (PK)
FREQUENCY RANGE	1GHz ~ 40GHz		Average (AV)

**ANTENNA POLARITY & TEST DISTANCE: HORIZONTAL AT 3 M**

NO.	FREQ. (MHz)	EMISSION LEVEL (dBuV/m)	LIMIT (dBuV/m)	MARGIN (dB)	ANTENNA HEIGHT (m)	TABLE ANGLE (Degree)	RAW VALUE (dBuV)	CORRECTION FACTOR (dB/m)
1	#5611.20	58.1 PK	68.2	-10.1	1.00 H	310	53.3	4.8
2	*5755.00	105.7 PK			1.00 H	310	64.2	41.5
3	*5755.00	95.3 AV			1.00 H	310	53.8	41.5
4	#5992.00	57.9 PK	68.2	-10.3	1.00 H	310	53.1	4.8
5	11510.00	56.4 PK	74.0	-17.6	1.93 H	114	40.5	15.9
6	11510.00	45.2 AV	54.0	-8.8	1.93 H	114	29.3	15.9

**ANTENNA POLARITY & TEST DISTANCE: VERTICAL AT 3 M**

NO.	FREQ. (MHz)	EMISSION LEVEL (dBuV/m)	LIMIT (dBuV/m)	MARGIN (dB)	ANTENNA HEIGHT (m)	TABLE ANGLE (Degree)	RAW VALUE (dBuV)	CORRECTION FACTOR (dB/m)
1	#5609.60	61.4 PK	68.2	-6.8	3.71 V	44	56.6	4.8
2	*5755.00	113.0 PK			3.71 V	44	71.5	41.5
3	*5755.00	102.9 AV			3.71 V	44	61.4	41.5
4	#5957.60	59.1 PK	68.2	-9.1	3.71 V	44	54.3	4.8
5	11510.00	57.5 PK	74.0	-16.5	2.38 V	214	41.6	15.9
6	11510.00	46.5 AV	54.0	-7.5	2.38 V	214	30.6	15.9

**Remarks:**

1. Emission Level(dBuV/m) = Raw Value(dBuV) + Correction Factor(dB/m)
2. Correction Factor(dB/m) = Antenna Factor(dB/m) + Cable Factor(dB) – Pre-Amplifier Factor(dB)
3. The other emission levels were very low against the limit.
4. Margin value = Emission Level – Limit value
5. " \* ": Fundamental frequency.
6. " # ": The radiated frequency is out of the restricted band.



CHANNEL	TX Channel 159	DETECTOR	Peak (PK)
FREQUENCY RANGE	1GHz ~ 40GHz	FUNCTION	Average (AV)

**ANTENNA POLARITY & TEST DISTANCE: HORIZONTAL AT 3 M**

NO.	FREQ. (MHz)	EMISSION LEVEL (dBuV/m)	LIMIT (dBuV/m)	MARGIN (dB)	ANTENNA HEIGHT (m)	TABLE ANGLE (Degree)	RAW VALUE (dBuV)	CORRECTION FACTOR (dB/m)
1	#5637.60	57.9 PK	68.2	-10.3	1.06 H	13	53.2	4.7
2	*5795.00	105.5 PK			1.06 H	13	64.0	41.5
3	*5795.00	95.3 AV			1.06 H	13	53.8	41.5
4	#5989.60	58.1 PK	68.2	-10.1	1.06 H	13	53.3	4.8
5	11590.00	56.3 PK	74.0	-17.7	3.42 H	167	40.8	15.5
6	11590.00	44.9 AV	54.0	-9.1	3.42 H	167	29.4	15.5

**ANTENNA POLARITY & TEST DISTANCE: VERTICAL AT 3 M**

NO.	FREQ. (MHz)	EMISSION LEVEL (dBuV/m)	LIMIT (dBuV/m)	MARGIN (dB)	ANTENNA HEIGHT (m)	TABLE ANGLE (Degree)	RAW VALUE (dBuV)	CORRECTION FACTOR (dB/m)
1	#5601.60	61.7 PK	68.2	-6.5	4.00 V	30	56.9	4.8
2	*5795.00	113.5 PK			4.00 V	30	72.0	41.5
3	*5795.00	103.7 AV			4.00 V	30	62.2	41.5
4	#5994.40	58.8 PK	68.2	-9.4	4.00 V	30	54.0	4.8
5	11590.00	57.0 PK	74.0	-17.0	1.18 V	257	41.5	15.5
6	11590.00	46.2 AV	54.0	-7.8	1.18 V	257	30.7	15.5

**Remarks:**

1. Emission Level(dBuV/m) = Raw Value(dBuV) + Correction Factor(dB/m)
2. Correction Factor(dB/m) = Antenna Factor(dB/m) + Cable Factor(dB) – Pre-Amplifier Factor(dB)
3. The other emission levels were very low against the limit.
4. Margin value = Emission Level – Limit value
5. " \* ": Fundamental frequency.
6. " # ": The radiated frequency is out of the restricted band.

802.11ac (VHT80)

CHANNEL	TX Channel 42	DETECTOR FUNCTION	Peak (PK)
FREQUENCY RANGE	1GHz ~ 40GHz		Average (AV)

ANTENNA POLARITY & TEST DISTANCE: HORIZONTAL AT 3 M

NO.	FREQ. (MHz)	EMISSION LEVEL (dBuV/m)	LIMIT (dBuV/m)	MARGIN (dB)	ANTENNA HEIGHT (m)	TABLE ANGLE (Degree)	RAW VALUE (dBuV)	CORRECTION FACTOR (dB/m)
1	5150.00	56.9 PK	74.0	-17.1	1.55 H	88	53.0	3.9
2	5150.00	44.4 AV	54.0	-9.6	1.55 H	88	40.5	3.9
3	*5210.00	95.1 PK			1.59 H	89	54.3	40.8
4	*5210.00	85.1 AV			1.59 H	89	44.3	40.8
5	5350.00	57.2 PK	74.0	-16.8	1.62 H	86	52.8	4.4
6	5350.00	44.1 AV	54.0	-9.9	1.62 H	86	39.7	4.4
7	#10420.00	57.8 PK	74.0	-16.2	2.41 H	334	42.5	15.3
8	#10420.00	44.6 AV	54.0	-9.4	2.41 H	334	29.3	15.3

ANTENNA POLARITY & TEST DISTANCE: VERTICAL AT 3 M

NO.	FREQ. (MHz)	EMISSION LEVEL (dBuV/m)	LIMIT (dBuV/m)	MARGIN (dB)	ANTENNA HEIGHT (m)	TABLE ANGLE (Degree)	RAW VALUE (dBuV)	CORRECTION FACTOR (dB/m)
1	5150.00	68.0 PK	74.0	-6.0	1.28 V	325	64.1	3.9
2	5150.00	52.6 AV	54.0	-1.4	1.28 V	325	48.7	3.9
3	*5210.00	105.3 PK			1.30 V	14	64.5	40.8
4	*5210.00	94.9 AV			1.30 V	14	54.1	40.8
5	5350.00	57.6 PK	74.0	-16.4	1.30 V	333	53.2	4.4
6	5350.00	44.6 AV	54.0	-9.4	1.30 V	333	40.2	4.4
7	#10420.00	57.6 PK	74.0	-16.4	1.18 V	102	42.3	15.3
8	#10420.00	44.6 AV	54.0	-9.4	1.18 V	102	29.3	15.3

Remarks:

1. Emission Level(dBuV/m) = Raw Value(dBuV) + Correction Factor(dB/m)
2. Correction Factor(dB/m) = Antenna Factor(dB/m) + Cable Factor(dB) – Pre-Amplifier Factor(dB)
3. The other emission levels were very low against the limit.
4. Margin value = Emission Level – Limit value
5. " \* ": Fundamental frequency.
6. " # ": The radiated frequency is out of the restricted band.

CHANNEL	TX Channel 155	DETECTOR FUNCTION	Peak (PK)
FREQUENCY RANGE	1GHz ~ 40GHz		Average (AV)

ANTENNA POLARITY & TEST DISTANCE: HORIZONTAL AT 3 M								
NO.	FREQ. (MHz)	EMISSION LEVEL (dBuV/m)	LIMIT (dBuV/m)	MARGIN (dB)	ANTENNA HEIGHT (m)	TABLE ANGLE (Degree)	RAW VALUE (dBuV)	CORRECTION FACTOR (dB/m)
1	#5641.60	59.7 PK	68.2	-8.5	1.46 H	79	55.0	4.7
2	#5650.00	58.2 PK	68.2	-10.0	1.42 H	76	53.5	4.7
3	*5775.00	100.9 PK			1.46 H	79	59.4	41.5
4	*5775.00	91.1 AV			1.46 H	79	49.6	41.5
5	#5927.20	60.1 PK	68.2	-8.1	1.46 H	79	55.3	4.8
6	11550.00	56.6 PK	74.0	-17.4	1.93 H	117	40.8	15.8
7	11550.00	45.5 AV	54.0	-8.5	1.93 H	117	29.7	15.8
ANTENNA POLARITY & TEST DISTANCE: VERTICAL AT 3 M								
NO.	FREQ. (MHz)	EMISSION LEVEL (dBuV/m)	LIMIT (dBuV/m)	MARGIN (dB)	ANTENNA HEIGHT (m)	TABLE ANGLE (Degree)	RAW VALUE (dBuV)	CORRECTION FACTOR (dB/m)
1	#5644.80	63.9 PK	68.2	-4.3	2.63 V	185	59.2	4.7
2	#5650.00	67.1 PK	68.2	-1.1	2.34 V	182	62.4	4.7
3	*5775.00	111.4 PK			2.63 V	185	69.9	41.5
4	*5775.00	100.3 AV			2.63 V	185	58.8	41.5
5	#5964.00	59.2 PK	68.2	-9.0	2.63 V	185	54.4	4.8
6	11550.00	57.4 PK	74.0	-16.6	2.28 V	142	41.6	15.8
7	11550.00	46.5 AV	54.0	-7.5	2.28 V	142	30.7	15.8

Remarks:

1. Emission Level(dBuV/m) = Raw Value(dBuV) + Correction Factor(dB/m)
2. Correction Factor(dB/m) = Antenna Factor(dB/m) + Cable Factor(dB) – Pre-Amplifier Factor(dB)
3. The other emission levels were very low against the limit.
4. Margin value = Emission Level – Limit value
5. " \* ": Fundamental frequency.
6. " # ": The radiated frequency is out of the restricted band.

Below 1GHz Worst-Case Data: 802.11a

CHANNEL	TX Channel 36	DETECTOR FUNCTION	Quasi-Peak (QP)
FREQUENCY RANGE	9kHz ~ 1GHz		

ANTENNA POLARITY & TEST DISTANCE: HORIZONTAL AT 3 M

NO.	FREQ. (MHz)	EMISSION LEVEL (dBuV/m)	LIMIT (dBuV/m)	MARGIN (dB)	ANTENNA HEIGHT (m)	TABLE ANGLE (Degree)	RAW VALUE (dBuV)	CORRECTION FACTOR (dB/m)
1	53.28	17.8 QP	40.0	-22.2	1.00 H	286	31.4	-13.6
2	115.36	24.5 QP	43.5	-19.0	1.00 H	116	40.7	-16.2
3	163.86	24.8 QP	43.5	-18.7	1.00 H	78	38.3	-13.5
4	331.67	44.0 QP	46.0	-2.0	1.00 H	143	55.8	-11.8
5	742.95	33.4 QP	46.0	-12.6	1.00 H	274	38.5	-5.1
6	774.96	32.4 QP	46.0	-13.6	1.00 H	265	37.1	-4.7

ANTENNA POLARITY & TEST DISTANCE: VERTICAL AT 3 M

NO.	FREQ. (MHz)	EMISSION LEVEL (dBuV/m)	LIMIT (dBuV/m)	MARGIN (dB)	ANTENNA HEIGHT (m)	TABLE ANGLE (Degree)	RAW VALUE (dBuV)	CORRECTION FACTOR (dB/m)
1	53.28	31.5 QP	40.0	-8.5	1.25 V	2	45.1	-13.6
2	326.82	42.6 QP	46.0	-3.4	1.00 V	177	54.3	-11.7
3	425.76	26.5 QP	46.0	-19.5	1.25 V	202	37.1	-10.6
4	625.58	30.1 QP	46.0	-15.9	1.25 V	47	37.1	-7.0
5	757.50	33.3 QP	46.0	-12.7	1.00 V	142	38.1	-4.8
6	894.27	40.4 QP	46.0	-5.6	1.50 V	166	43.5	-3.1

Remarks:

1. Emission Level(dBuV/m) = Raw Value(dBuV) + Correction Factor(dB/m)
2. Correction Factor(dB/m) = Antenna Factor(dB/m) + Cable Factor(dB) – Pre-Amplifier Factor(dB)
3. The other emission levels were very low against the limit.
4. Margin value = Emission Level – Limit value

## 4.2 Conducted Emission Measurement

### 4.2.1 Limits of Conducted Emission Measurement

Frequency (MHz)	Conducted Limit (dBuV)	
	Quasi-peak	Average
0.15 - 0.5	66 - 56	56 - 46
0.50 - 5.0	56	46
5.0 - 30.0	60	50

Note: 1. The lower limit shall apply at the transition frequencies.

2. The limit decreases in line with the logarithm of the frequency in the range of 0.15 to 0.50MHz.

### 4.2.2 Test Instruments

Description & Manufacturer	Model No.	Serial No.	Cal. Date	Cal. Due
Test Receiver ROHDE & SCHWARZ	ESCI	100613	Nov. 23, 2016	Nov. 22, 2017
			Nov. 23, 2017	Nov. 22, 2018
RF signal cable (with 10dB PAD) Woken	5D-FB	Cable-cond1-01	Sep. 05, 2017	Sep. 04, 2018
LISN ROHDE & SCHWARZ (EUT)	ESH3-Z5	835239/001	Mar. 10, 2017	Mar. 09, 2018
LISN ROHDE & SCHWARZ (Peripheral)	ESH3-Z5	100311	Aug. 15, 2017	Aug. 14, 2018
Software ADT	BV ADT_Cond_ V7.3.7.3	NA	NA	NA

Note: 1. The calibration interval of the above test instruments is 12 months and the calibrations are traceable to NML/ROC and NIST/USA.

2. The test was performed in HwaYa Shielded Room 1.

3. The VCCI Site Registration No. is C-2040.

#### 4.2.3 Test Procedures

- The EUT was placed 0.4 meters from the conducting wall of the shielded room with EUT being connected to the power mains through a line impedance stabilization network (LISN). Other support units were connected to the power mains through another LISN. The two LISNs provide 50 ohm/ 50uH of coupling impedance for the measuring instrument.
- Both lines of the power mains connected to the EUT were checked for maximum conducted interference.
- The frequency range from 150kHz to 30MHz was searched. Emission levels under (Limit - 20dB) was not recorded.

Note: The resolution bandwidth and video bandwidth of test receiver is 9kHz for quasi-peak detection (QP) and average detection (AV) at frequency 0.15MHz-30MHz.

#### 4.2.4 Deviation from Test Standard

No deviation.

#### 4.2.5 Test Setup

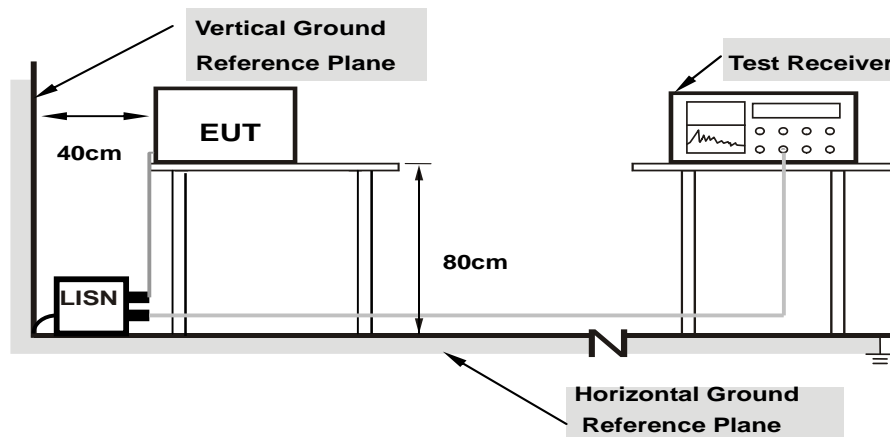

**Note: 1.Support units were connected to second LISN.**

For the actual test configuration, please refer to the attached file (Test Setup Photo).

#### 4.2.6 EUT Operating Conditions

Same as 4.1.6.

#### 4.2.7 Test Results

Worst-case data: 802.11a

Phase	Line (L)	Detector Function	Quasi-Peak (QP) / Average (AV)
-------	----------	-------------------	--------------------------------

No	Freq. [MHz]	Corr. Factor (dB)	Reading Value [dB (uV)]		Emission Level [dB (uV)]		Limit [dB (uV)]		Margin (dB)	
			Q.P.	AV.	Q.P.	AV.	Q.P.	AV.	Q.P.	AV.
			<b>1</b>	<b>0.16173</b>	<b>10.45</b>	<b>33.61</b>	<b>16.58</b>	<b>44.06</b>	<b>27.03</b>	<b>65.37</b>
2	0.18519	10.45	29.44	10.75	39.89	21.20	64.25	54.25	-24.36	-33.05
3	0.21256	10.46	25.86	10.46	36.32	20.92	63.10	53.10	-26.78	-32.18
4	0.31422	10.49	15.54	3.21	26.03	13.70	59.86	49.86	-33.83	-36.16
5	3.21153	10.60	4.04	0.44	14.64	11.04	56.00	46.00	-41.36	-34.96
6	21.31483	11.48	6.65	0.20	18.13	11.68	60.00	50.00	-41.87	-38.32

#### Remarks:

1. Q.P. and AV. are abbreviations of quasi-peak and average individually.
2. The emission levels of other frequencies were very low against the limit.
3. Margin value = Emission level - Limit value
4. Correction factor = Insertion loss + Cable loss
5. Emission Level = Correction Factor + Reading Value.

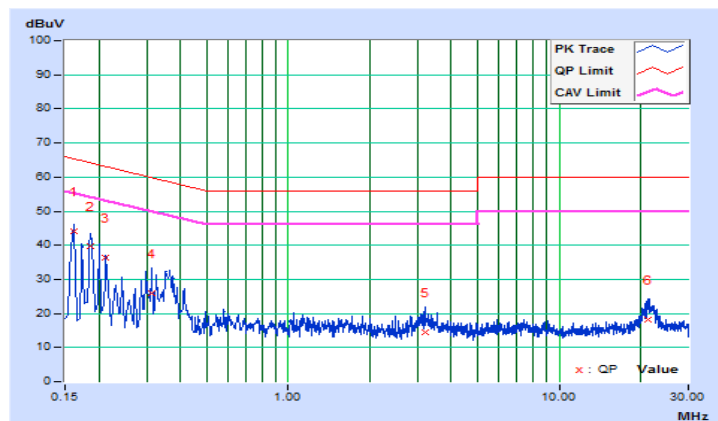

Phase	Neutral (N)	Detector Function	Quasi-Peak (QP) / Average (AV)
-------	-------------	-------------------	--------------------------------

No	Freq. [MHz]	Corr. Factor (dB)	Reading Value		Emission Level		Limit		Margin	
			[dB (uV)]		[dB (uV)]		[dB (uV)]		(dB)	
			Q.P.	AV.	Q.P.	AV.	Q.P.	AV.	Q.P.	AV.
1	0.15391	10.21	32.45	13.19	42.66	23.40	65.79	55.79	-23.13	-32.39
2	0.16955	10.21	28.77	11.45	38.98	21.66	64.98	54.98	-26.00	-33.32
3	0.34550	10.23	15.45	7.64	25.68	17.87	59.07	49.07	-33.39	-31.20
4	1.72573	10.30	4.28	0.69	14.58	10.99	56.00	46.00	-41.42	-35.01
5	2.96520	10.36	5.13	0.81	15.49	11.17	56.00	46.00	-40.51	-34.83
6	21.08805	11.08	7.37	0.54	18.45	11.62	60.00	50.00	-41.55	-38.38

Remarks:

1. Q.P. and AV. are abbreviations of quasi-peak and average individually.
2. The emission levels of other frequencies were very low against the limit.
3. Margin value = Emission level - Limit value
4. Correction factor = Insertion loss + Cable loss
5. Emission Level = Correction Factor + Reading Value.

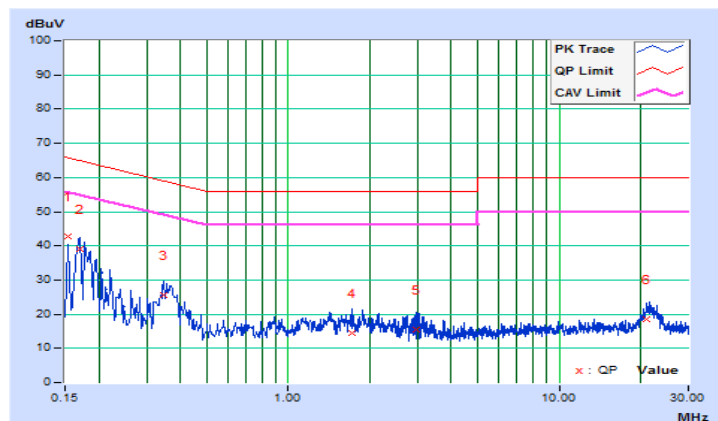



### 4.3 Transmit Power Measurement

#### 4.3.1 Limits of Transmit Power Measurement

Operation Band	EUT Category		Limit
U-NII-1		Outdoor Access Point	1 Watt (30 dBm) (Max. e.i.r.p $\leq$ 125mW(21 dBm) at any elevation angle above 30 degrees as measured from the horizon)
		Fixed point-to-point Access Point	1 Watt (30 dBm)
	√	Indoor Access Point	1 Watt (30 dBm)
		Mobile and Portable client device	250mW (24 dBm)
U-NII-2A			250mW (24 dBm) or 11 dBm+10 log B*
U-NII-2C			250mW (24 dBm) or 11 dBm+10 log B*
U-NII-3	√		1 Watt (30 dBm)

\*B is the 26 dB emission bandwidth in megahertz

Per KDB 662911 Method of conducted output power measurement on IEEE 802.11 devices,

Array Gain = 0 dB (i.e., no array gain) for  $N_{ANT} \leq 4$ ;

Array Gain = 0 dB (i.e., no array gain) for channel widths  $\geq 40$  MHz for any  $N_{ANT}$ ;

Array Gain =  $5 \log(N_{ANT}/N_{SS})$  dB or 3 dB, whichever is less for 20-MHz channel widths with  $N_{ANT} \geq 5$ .

For power measurements on all other devices: Array Gain =  $10 \log(N_{ANT}/N_{SS})$  dB.

#### 4.3.2 Test Setup

For Power Output

802.11a, 802.11n (HT20), 802.11n (HT40)

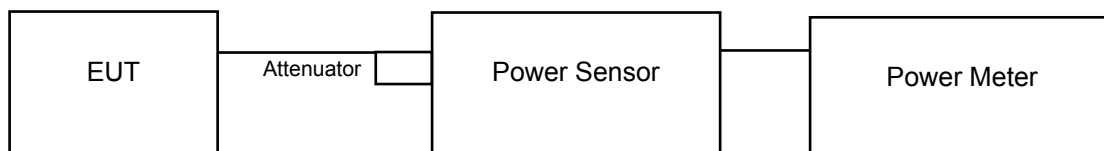

802.11ac (VHT80)

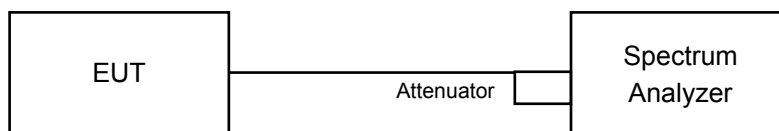

#### 4.3.3 Test Instruments

Refer to section 4.1.2 to get information of above instrument.

#### 4.3.4 Test Procedure

##### For Average Power Measurement

##### For 802.11a, 802.11n (HT20), 802.11n (HT40)

Method PM is used to perform output power measurement, trigger and gating function of wide band power meter is enabled to measure max output power of TX on burst. Duty factor is not added to measured value.

##### For 802.11ac (VHT80)

- a. Set span to encompass the entire 26 dB EBW (or, alternatively, the entire 99% occupied bandwidth) of the signal.
- b. Set sweep trigger to “free run”.
- c. Set RBW = 1 MHz.
- d. Set VBW  $\geq$  3 MHz.
- e. Number of points in sweep  $\geq$  2 Span / RBW.
- f. Sweep time  $\leq$  (number of points in sweep) \* T
- g. Using emission bandwidth to determine the frequency span for integration the channel bandwidth.
- h. Detector = RMS.
- i. Trace mode = max hold.
- j. Allow max hold to run for at least 60 seconds, or longer as needed to allow the trace to stabilize.
- k. Compute power by integrating the spectrum across the EBW (or, alternatively, the entire 99% occupied bandwidth) of the signal using the instrument’s band power measurement function with band limits set equal to the EBW (or occupied bandwidth) band edges. If the instrument does not have a band power function, sum the spectrum levels (in power units) at 1 MHz intervals extending across the EBW (or, alternatively, the entire 99% occupied bandwidth) of the spectrum.

#### 4.3.5 Deviation from Test Standard

No deviation.

#### 4.3.6 EUT Operating Conditions

The software provided by client to enable the EUT under transmission condition continuously at lowest, middle and highest channel frequencies individually.

#### 4.3.7 Test Result

##### Power Output:

##### 802.11a

Chan.	Freq. (MHz)	Maximum Conducted Power (mW)	Maximum Conducted Power (dBm)	Power Limit (dBm)	Pass / Fail
36	5180	127.644	21.06	30.00	Pass
40	5200	142.889	21.55	30.00	Pass
48	5240	77.090	18.87	30.00	Pass
149	5745	142.561	21.54	30.00	Pass
157	5785	143.219	21.56	30.00	Pass
165	5825	115.611	20.63	30.00	Pass

##### 802.11n (HT20)

Chan.	Freq. (MHz)	Maximum Conducted Power (dBm)			Total Power (mW)	Total Power (dBm)	Power Limit (dBm)	Pass / Fail
		Chain 0	Chain 1	Chain 2				
36	5180	18.64	17.70	18.16	197.462	22.95	30.00	Pass
40	5200	21.42	21.07	21.77	<b>416.928</b>	26.20	30.00	Pass
48	5240	18.69	17.95	18.45	206.318	23.15	30.00	Pass
149	5745	21.43	20.65	21.76	<b>405.108</b>	26.08	30.00	Pass
157	5785	20.40	21.12	21.56	382.287	25.82	30.00	Pass
165	5825	20.22	20.45	21.43	355.108	25.50	30.00	Pass

##### 802.11n (HT40)

Chan.	Freq. (MHz)	Maximum Conducted Power (dBm)			Total Power (mW)	Total Power (dBm)	Power Limit (dBm)	Pass / Fail
		Chain 0	Chain 1	Chain 2				
38	5190	13.24	12.78	12.52	57.918	17.63	30.00	Pass
46	5230	20.11	19.15	20.95	309.240	24.90	30.00	Pass
151	5755	20.76	21.46	21.56	402.302	26.05	30.00	Pass
159	5795	20.88	20.92	21.53	388.290	25.89	30.00	Pass

##### 802.11ac (VHT80)

Chan.	Freq. (MHz)	Maximum Conducted Power (dBm)			Total Power (mW)	Total Power (dBm)	Power Limit (dBm)	Pass / Fail
		Chain 0	Chain 1	Chain 2				
42	5210	12.18	11.33	11.47	44.131	16.45	30.00	Pass
155	5775	19.14	19.72	20.11	278.356	24.45	30.00	Pass

## 4.4 Occupied Bandwidth Measurement

### 4.4.1 Test Setup

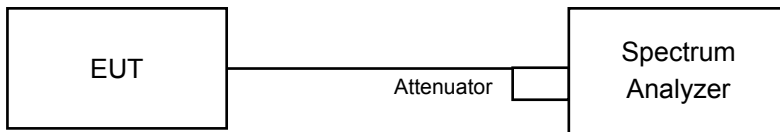

### 4.4.2 Test Instruments

Refer to section 4.1.2 to get information of above instrument.

### 4.4.3 Test Procedure

The transmitter output was connected to the spectrum analyzer through an attenuator. The bandwidth of the fundamental frequency was measured by spectrum analyzer with resolution bandwidth in the range of 1% to 5% of the anticipated emission bandwidth, and a video bandwidth at least 3x the resolution bandwidth and set the detector to sampling. The width of a frequency band such that, below the lower and above the upper frequency limits, the mean powers emitted are each equal to a specified percentage 0.5 %of the total mean power of a given emission.

#### 4.4.4 Test Result

##### 802.11a

Chan.	Freq. (MHz)	Occupied Bandwidth (MHz)
36	5180	23.16
40	5200	25.44
48	5240	17.88
149	5745	23.64
157	5785	23.40
165	5825	22.56

##### 802.11n (HT20)

Chan.	Freq. (MHz)	Occupied Bandwidth (MHz)		
		Chain 0	Chain 1	Chain 2
36	5180	18.60	18.24	18.24
40	5200	34.20	31.32	31.56
48	5240	18.95	18.78	19.30
149	5745	24.48	21.36	20.88
157	5785	21.84	19.68	20.40
165	5825	20.04	19.08	19.08

##### 802.11n (HT40)

Chan.	Freq. (MHz)	Occupied Bandwidth (MHz)		
		Chain 0	Chain 1	Chain 2
38	5190	37.08	37.08	36.96
46	5230	38.88	38.88	38.64
151	5755	39.12	37.56	37.44
159	5795	38.88	37.44	37.44

##### 802.11ac (VHT80)

Chan.	Freq. (MHz)	Occupied Bandwidth (MHz)		
		Chain 0	Chain 1	Chain 2
42	5210	76.32	76.32	76.32
155	5775	76.80	76.80	77.28

### Spectrum Plot of Worst Value

#### 802.11a

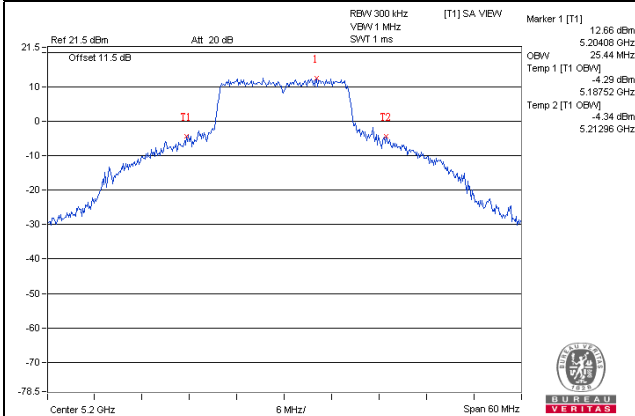

#### 802.11n (HT20)

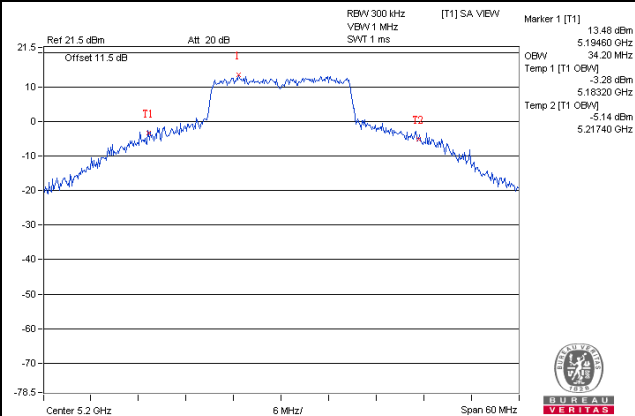

#### 802.11n (HT40)

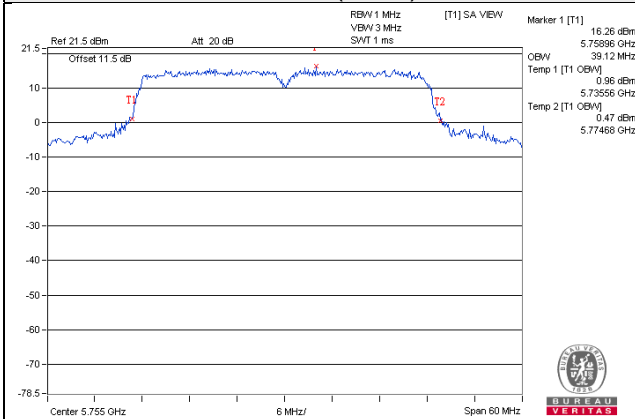

#### 802.11ac (VHT80)

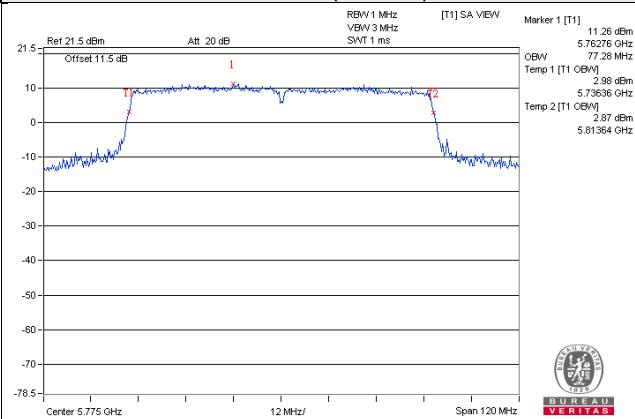

## 4.5 Peak Power Spectral Density Measurement

### 4.5.1 Limits of Peak Power Spectral Density Measurement

Operation Band	EUT Category		Limit
U-NII-1		Outdoor Access Point	17dBm/ MHz
		Fixed point-to-point Access Point	
	√	Indoor Access Point	
		Mobile and Portable client device	11dBm/ MHz
U-NII-2A			11dBm/ MHz
U-NII-2C			11dBm/ MHz
U-NII-3	√		30dBm/ 500kHz

### 4.5.2 Test Setup

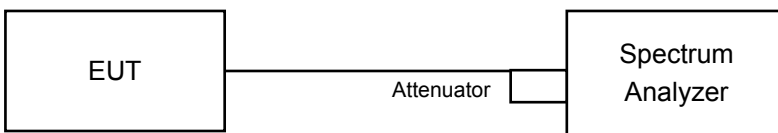

### 4.5.3 Test Instruments

Refer to section 4.1.2 to get information of above instrument.

### 4.5.4 Test Procedures

For U-NII-1 band:

Using method SA-2

- Set span to encompass the entire emission bandwidth (EBW) of the signal.
- Set RBW = 1MHz, Set VBW ≥ 3 MHz, Detector = RMS
- Set Channel power measure = 1MHz
- Sweep time = auto, trigger set to “free run”.
- Trace average at least 100 traces in power averaging mode.
- Record the max value and add 10 log (1/duty cycle)

For U-NII-3 band:

Duty cycle of test signal is < 98%

- Set span to encompass the entire emission bandwidth (EBW) of the signal.
- Set RBW = 300 kHz, Set VBW ≥ 1 MHz, Detector = RMS
- Use the peak marker function to determine the maximum power level in any 300 kHz band segment within the fundamental EBW.
- Scale the observed power level to an equivalent value in 500 kHz by adjusting (reducing) the measured power by a bandwidth correction factor (BWCF) where  $BWCF = 10\log(500 \text{ kHz} / 300 \text{ kHz})$
- Sweep time = auto, trigger set to “free run”.
- Trace average at least 100 traces in power averaging mode.
- Record the max value and add 10 log (1/duty cycle)

#### **4.5.5 Deviation from Test Standard**

No deviation.

#### **4.5.6 EUT Operating Conditions**

Same as 4.3.6.



#### 4.5.7 Test Results

For U-NII-1 band:

##### 802.11a

Chan.	Freq. (MHz)	PSD w/o Duty Factor (dBm/MHz)	Duty Factor (dB)	PSD with Duty Factor (dBm/MHz)	Max. Limit (dBm/MHz)	Pass / Fail
36	5180	8.05	0.15	8.20	17.00	Pass
40	5200	8.46	0.15	8.61	17.00	Pass
48	5240	6.14	0.15	6.29	17.00	Pass

Note: Refer to section 3.3 for duty cycle spectrum plot.

##### 802.11n (HT20)

Chan.	Freq. (MHz)	PSD w/o Duty Factor (dBm/MHz)			Duty Factor (dB)	Total PSD with Duty Factor (dBm/MHz)	Max. Limit (dBm/MHz)	Pass / Fail
		Chain 0	Chain 1	Chain 2				
36	5180	6.02	5.08	5.10	0.15	10.34	14.53	Pass
40	5200	9.14	8.32	8.22	0.15	13.50	14.53	Pass
48	5240	6.00	6.09	5.89	0.15	10.92	14.53	Pass

Note:

- Method 1 of power density measurement of KDB 662911 is using for calculating total power density. Total power density is summing entire spectra across corresponding frequency bins on the various outputs by computer.
- Directional gain =  $3.7\text{dBi} + 10\log(3) = 8.47\text{dBi} > 6\text{dBi}$ , so the power density limit shall be reduced to  $17 - (8.47 - 6) = 14.53\text{dBm}$ .
- Refer to section 3.3 for duty cycle spectrum plot.

##### 802.11n (HT40)

Chan.	Freq. (MHz)	PSD w/o Duty Factor (dBm/MHz)			Duty Factor (dB)	Total PSD with Duty Factor (dBm/MHz)	Max. Limit (dBm/MHz)	Pass / Fail
		Chain 0	Chain 1	Chain 2				
38	5190	-3.22	-3.00	-3.17	0.30	1.94	14.53	Pass
46	5230	3.59	4.06	3.92	0.30	8.93	14.53	Pass

Note:

- Method 1 of power density measurement of KDB 662911 is using for calculating total power density. Total power density is summing entire spectra across corresponding frequency bins on the various outputs by computer.
- Directional gain =  $3.7\text{dBi} + 10\log(3) = 8.47\text{dBi} > 6\text{dBi}$ , so the power density limit shall be reduced to  $17 - (8.47 - 6) = 14.53\text{dBm}$ .
- Refer to section 3.3 for duty cycle spectrum plot.

### 802.11ac (VHT80)

Chan.	Freq. (MHz)	PSD w/o Duty Factor (dBm/MHz)			Duty Factor (dB)	Total PSD with Duty Factor (dBm/MHz)	Max. Limit (dBm/MHz)	Pass / Fail
		Chain 0	Chain 1	Chain 2				
42	5210	-6.78	-7.70	-7.51	0.61	-1.93	14.53	Pass

**Note:**

- Method 1 of power density measurement of KDB 662911 is using for calculating total power density. Total power density is summing entire spectra across corresponding frequency bins on the various outputs by computer.
- Directional gain =  $3.7\text{dBi} + 10\log(3) = 8.47\text{dBi} > 6\text{dBi}$ , so the power density limit shall be reduced to  $17 - (8.47 - 6) = 14.53\text{dBm}$ .
- Refer to section 3.3 for duty cycle spectrum plot.

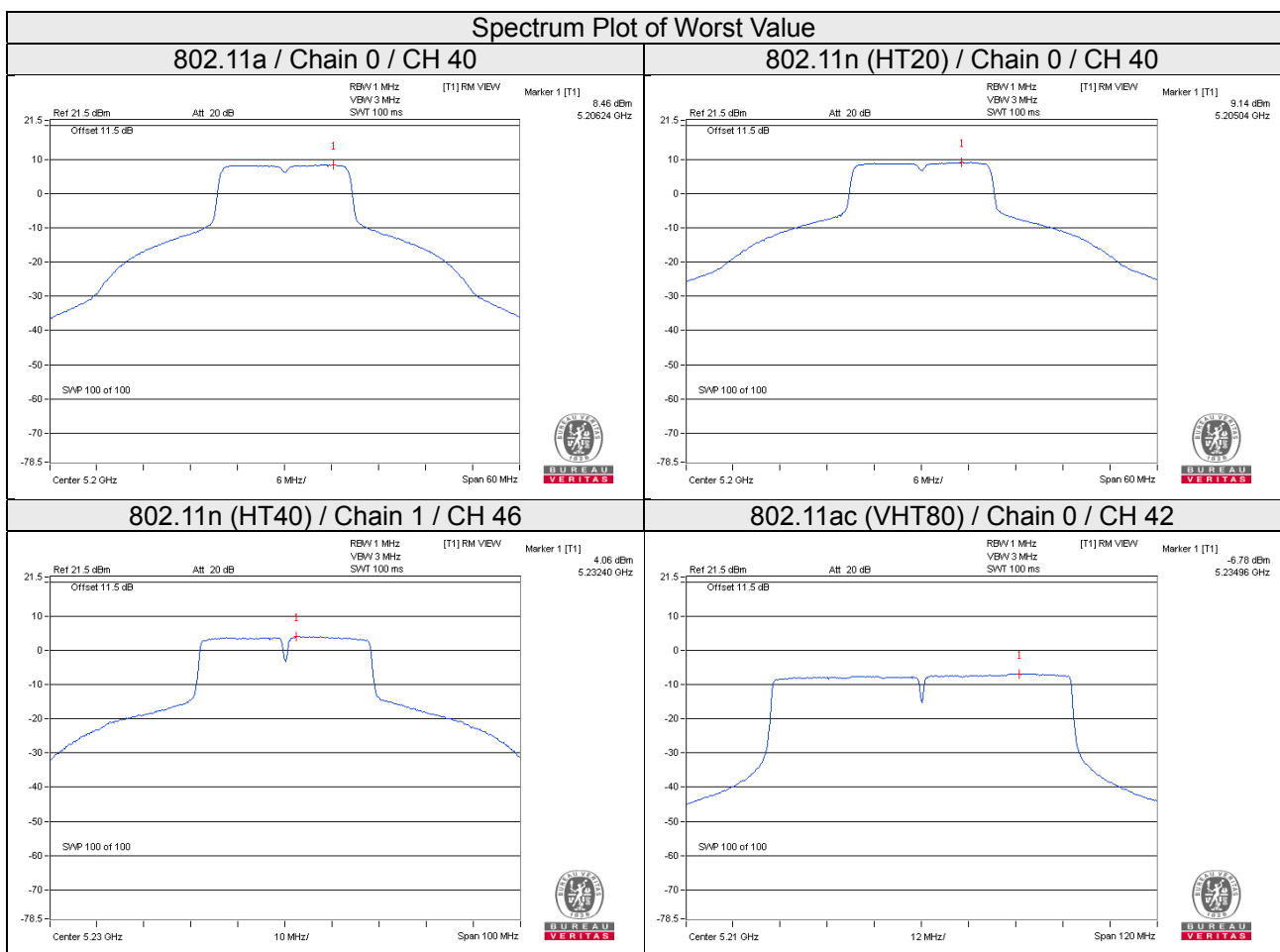

For U-NII-3 band:

802.11a

Chan.	Freq. (MHz)	PSD w/o Duty Factor		Duty Factor (dB)	Total PSD with Duty Factor (dBm/500kHz)	Limit (dBm/500kHz)	Pass / Fail
		(dBm/300kHz)	(dBm/500kHz)				
149	5745	0.30	2.52	0.15	2.67	30.00	Pass
157	5785	0.34	2.56	0.15	2.71	30.00	Pass
165	5825	0.27	2.49	0.15	2.64	30.00	Pass

Note: Refer to section 3.3 for duty cycle spectrum plot.

802.11n (HT20)

TX chain	Chan.	Freq. (MHz)	PSD w/o Duty Factor		10 log (N=3) dB	Duty Factor (dB)	Total PSD with Duty Factor (dBm/500kHz)	Limit (dBm/500 kHz)	Pass / Fail
			(dBm/300kHz)	(dBm/500kHz)					
0	149	5745	-0.62	1.60	4.77	0.15	6.52	26.83	Pass
	157	5785	-1.40	0.82	4.77	0.15	5.74	26.83	Pass
	165	5825	-1.46	0.76	4.77	0.15	5.68	26.83	Pass
1	149	5745	-1.41	0.81	4.77	0.15	5.73	26.83	Pass
	157	5785	-1.67	0.55	4.77	0.15	5.47	26.83	Pass
	165	5825	-1.93	0.29	4.77	0.15	5.21	26.83	Pass
2	149	5745	-1.37	0.85	4.77	0.15	5.77	26.83	Pass
	157	5785	-1.47	0.75	4.77	0.15	5.67	26.83	Pass
	165	5825	-1.87	0.35	4.77	0.15	5.27	26.83	Pass

Note:

1. Method 1 of power density measurement of KDB 662911 is using for calculating total power density. Total power density is summing entire spectra across corresponding frequency bins on the various outputs by computer.
2. Directional gain =  $4.4\text{dBi} + 10\log(3) = 9.17\text{dBi} > 6\text{dBi}$ , so the power density limit shall be reduced to  $30 - (9.17 - 6) = 26.83\text{dBm}$ .
3. Refer to section 3.3 for duty cycle spectrum plot.

### 802.11n (HT40)

TX chain	Chan.	Freq. (MHz)	PSD w/o Duty Factor		10 log (N=3) dB	Duty Factor (dB)	Total PSD with Duty Factor (dBm/500kHz)	Limit (dBm/500 kHz)	Pass / Fail
			(dBm/300kHz)	(dBm/500kHz)					
0	151	5755	-4.00	-1.78	4.77	0.30	3.29	26.83	Pass
	159	5795	-4.03	-1.81	4.77	0.30	3.26	26.83	Pass
1	151	5755	-4.94	-2.72	4.77	0.30	2.35	26.83	Pass
	159	5795	-5.12	-2.90	4.77	0.30	2.17	26.83	Pass
2	151	5755	-5.25	-3.03	4.77	0.30	2.04	26.83	Pass
	159	5795	-5.30	-3.08	4.77	0.30	1.99	26.83	Pass

Note:

- Method 1 of power density measurement of KDB 662911 is using for calculating total power density. Total power density is summing entire spectra across corresponding frequency bins on the various outputs by computer.
- Directional gain =  $4.4\text{dBi} + 10\log(3) = 9.17\text{dBi} > 6\text{dBi}$ , so the power density limit shall be reduced to  $30 - (9.17 - 6) = 26.83\text{dBm}$ .
- Refer to section 3.3 for duty cycle spectrum plot.

### 802.11ac (VHT80)

TX chain	Chan.	Freq. (MHz)	PSD w/o Duty Factor		10 log (N=3) dB	Duty Factor (dB)	Total PSD with Duty Factor (dBm/500kHz)	Limit (dBm/500 kHz)	Pass / Fail
			(dBm/300kHz)	(dBm/500kHz)					
0	155	5775	-8.15	-5.93	4.77	0.61	-0.55	26.83	Pass
1	151	5755	-8.54	-6.32	4.77	0.61	-0.94	26.83	Pass
2	155	5775	-8.32	-6.10	4.77	0.61	-0.72	26.83	Pass

Note:

- Method 1 of power density measurement of KDB 662911 is using for calculating total power density. Total power density is summing entire spectra across corresponding frequency bins on the various outputs by computer.
- Directional gain =  $4.4\text{dBi} + 10\log(3) = 9.17\text{dBi} > 6\text{dBi}$ , so the power density limit shall be reduced to  $30 - (9.17 - 6) = 26.83\text{dBm}$ .
- Refer to section 3.3 for duty cycle spectrum plot.

### Spectrum Plot of Worst Value

#### 802.11a

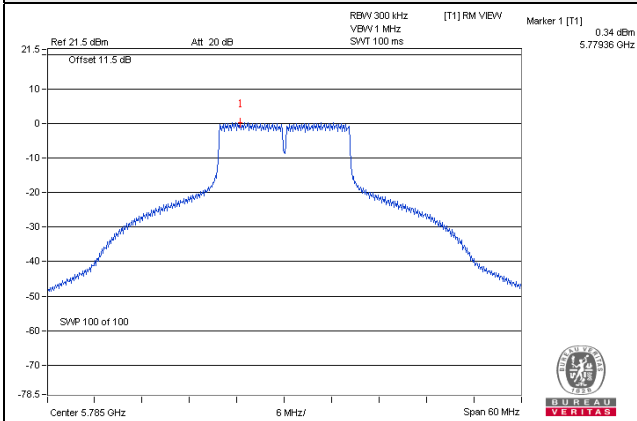

#### 802.11n (HT20)

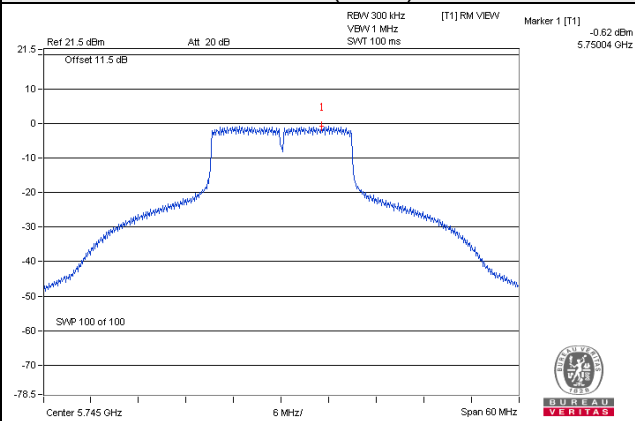

#### 802.11n (HT40)

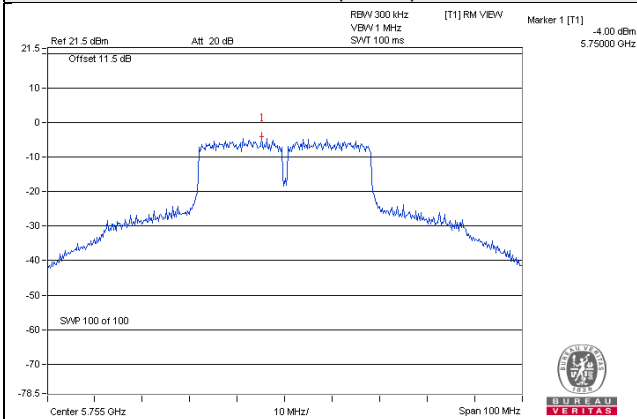

#### 802.11ac (VHT80)

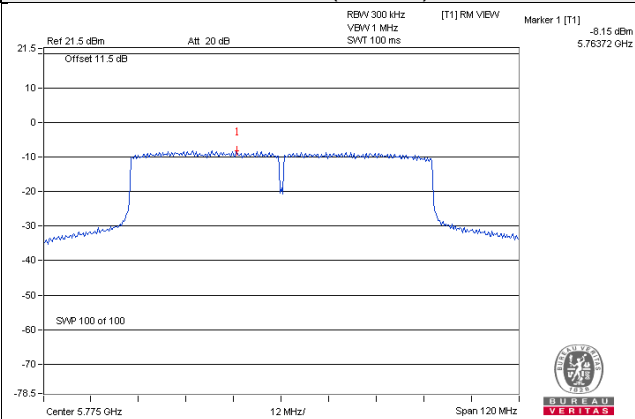

## 4.6 Frequency Stability

### 4.6.1 Limits of Frequency Stability Measurement

The frequency of the carrier signal shall be maintained within band of operation

### 4.6.2 Test Setup

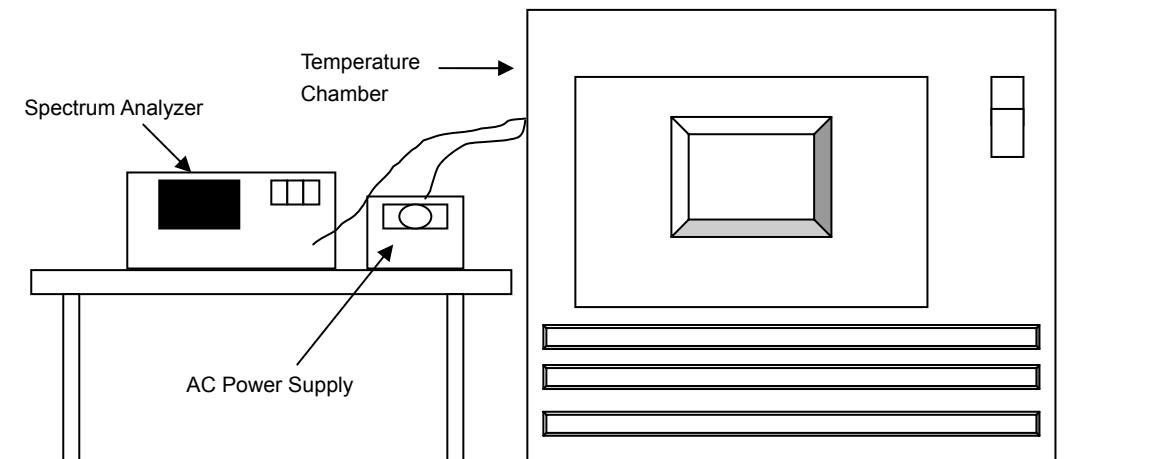

### 4.6.3 Test Instruments

Description & Manufacturer	Model No.	Serial No.	Cal. Date	Cal. Due
Spectrum Analyzer ROHDE & SCHWARZ	FSP40	100040	Aug. 18, 2017	Aug. 17, 2018
WIT Standard Temperature And Humidity Chamber	TH-4S-C	W981030	Jun. 07, 2017	Jun. 06, 2018
Digital Multimeter FLUKE	87-III	70360742	Jun. 30, 2017	Jun. 29, 2018
AC Power Supply EXTECH	CFW-105	E000603	NA	NA

- Note: 1. The calibration interval of the above test instruments is 12 months and the calibrations are traceable to NML/ROC and NIST/USA.
2. The measurement uncertainty is 207Hz, which is calculated as per the document ETSI TR 100 028. This uncertainty represents an expanded uncertainty expressed at approximately the 95% confidence level using a coverage factor of k=2.

#### 4.6.4 Test Procedure

- The EUT was placed inside the environmental test chamber and powered by nominal AC voltage.
- Turn the EUT on and couple its output to a spectrum analyzer.
- Turn the EUT off and set the chamber to the highest temperature specified.
- Allow sufficient time (approximately 30 min) for the temperature of the chamber to stabilize, turn the EUT on and measure the operating frequency after 2, 5, and 10 minutes.
- Repeat step 2 and 3 with the temperature chamber set to the lowest temperature.
- The test chamber was allowed to stabilize at +20 degree C for a minimum of 30 minutes. The supply voltage was then adjusted on the EUT from 85% to 115% and the frequency record.

#### 4.6.5 Deviation from Test Standard

No deviation.

#### 4.6.6 EUT Operating Condition

Set the EUT transmit at un-modulation mode to test frequency stability.

#### 4.6.7 Test Results

Frequency Stability Versus Temp.									
Operating Frequency: 5180MHz									
Temp. (°C)	Power Supply (Vac)	0 Minute		2 Minute		5 Minute		10 Minute	
		Measured Frequency (MHz)	Frequency Drift (%)	Measured Frequency (MHz)	Frequency Drift (%)	Measured Frequency (MHz)	Frequency Drift (%)	Measured Frequency (MHz)	Frequency Drift (%)
50	120	5179.9886	-0.00022	5179.9885	-0.00022	5179.9896	-0.00020	5179.9924	-0.00015
40	120	5179.9996	-0.00001	5179.9976	-0.00005	5180.0003	0.00001	5180.0018	0.00003
30	120	5180.0088	0.00017	5180.0099	0.00019	5180.0123	0.00024	5180.0098	0.00019
20	120	5179.9995	-0.00001	5179.9951	-0.00009	5179.9981	-0.00004	5179.9964	-0.00007
10	120	5180.0194	0.00037	5180.0151	0.00029	5180.0162	0.00031	5180.0159	0.00031
0	120	5180.0124	0.00024	5180.0124	0.00024	5180.0113	0.00022	5180.0129	0.00025
-10	120	5179.9792	-0.00040	5179.9772	-0.00044	5179.9807	-0.00037	5179.9787	-0.00041
-20	120	5180.0255	0.00049	5180.0259	0.00050	5180.0231	0.00045	5180.0231	0.00045
-30	120	5180.0173	0.00033	5180.0178	0.00034	5180.0147	0.00028	5180.0168	0.00032

Frequency Stability Versus Voltage									
Operating Frequency: 5180MHz									
Temp. (°C)	Power Supply (Vac)	0 Minute		2 Minute		5 Minute		10 Minute	
		Measured Frequency (MHz)	Frequency Drift (%)	Measured Frequency (MHz)	Frequency Drift (%)	Measured Frequency (MHz)	Frequency Drift (%)	Measured Frequency (MHz)	Frequency Drift (%)
20	138	5179.9995	-0.00001	5179.9948	-0.00010	5179.9987	-0.00003	5179.9965	-0.00007
	120	5179.9995	-0.00001	5179.9951	-0.00009	5179.9981	-0.00004	5179.9964	-0.00007
	102	5179.9986	-0.00003	5179.9944	-0.00011	5179.9991	-0.00002	5179.9956	-0.00008

## 4.7 6dB Bandwidth Measurement

### 4.7.1 Limits of 6dB Bandwidth Measurement

The minimum of 6dB Bandwidth Measurement is 0.5MHz.

### 4.7.2 Test Setup

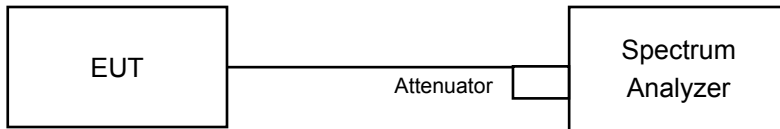

### 4.7.3 Test Instruments

Refer to section 4.1.2 to get information of above instrument.

### 4.7.4 Test Procedure

#### Measurement Procedure REF

- Set resolution bandwidth (RBW) = 100kHz
- Set the video bandwidth (VBW)  $\geq 3 \times$  RBW, Detector = average.
- Trace mode = max hold.
- Sweep = auto couple.
- Measure the maximum width of the emission that is constrained by the frequencies associated with the two amplitude points (upper and lower) that are attenuated by 6 dB relative to the maximum level measured in the fundamental emission

### 4.7.5 Deviation from Test Standard

No deviation.

### 4.7.6 EUT Operating Condition

The software provided by client to enable the EUT under transmission condition continuously at lowest, middle and highest channel frequencies individually.



#### 4.7.7 Test Results

##### 802.11a

Channel	Frequency (MHz)	6dB Bandwidth (MHz)	Minimum Limit (MHz)	Pass / Fail
149	5745	16.40	0.5	Pass
157	5785	16.39	0.5	Pass
165	5825	16.39	0.5	Pass

##### 802.11n (HT20)

Channel	Frequency (MHz)	6dB Bandwidth (MHz)			Minimum Limit (MHz)	Pass / Fail
		Chain 0	Chain 1	Chain 2		
149	5745	17.62	17.57	17.59	0.5	Pass
157	5785	17.62	17.58	17.61	0.5	Pass
165	5825	17.62	17.62	17.62	0.5	Pass

##### 802.11n (HT40)

Channel	Frequency (MHz)	6dB Bandwidth (MHz)			Minimum Limit (MHz)	Pass / Fail
		Chain 0	Chain 1	Chain 2		
151	5755	36.50	35.87	36.03	0.5	Pass
159	5795	36.57	36.45	35.57	0.5	Pass

##### 802.11ac (VHT80)

Channel	Frequency (MHz)	6dB Bandwidth (MHz)			Minimum Limit (MHz)	Pass / Fail
		Chain 0	Chain 1	Chain 2		
155	5775	75.82	72.87	76.31	0.5	Pass

### Spectrum Plot of Worst Value

#### 802.11a

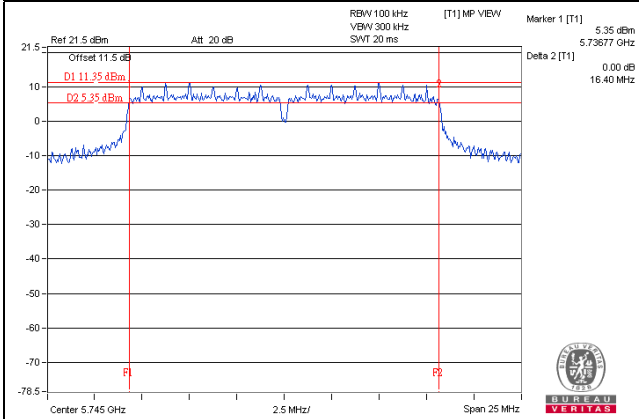

#### 802.11n (HT20)

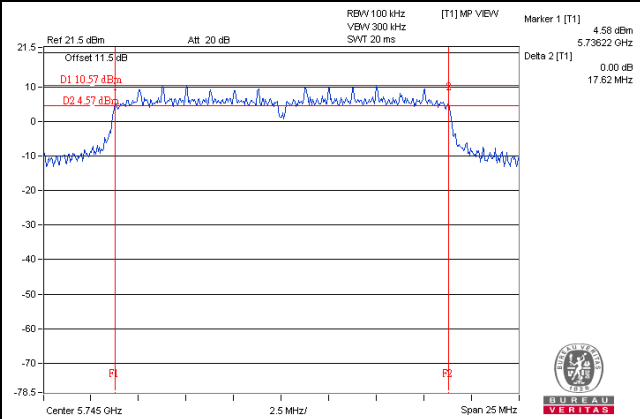

#### 802.11n (HT40)

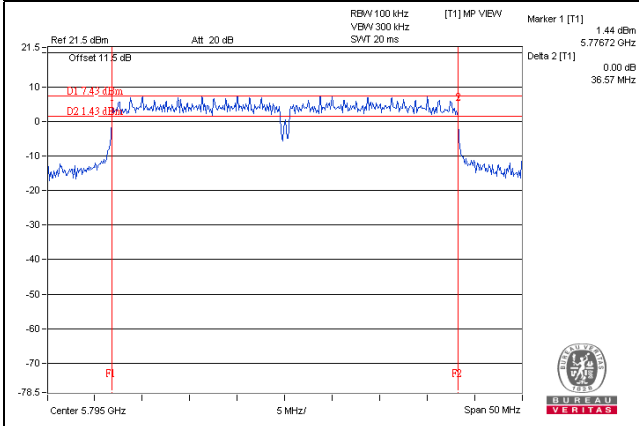

#### 802.11ac (VHT80)

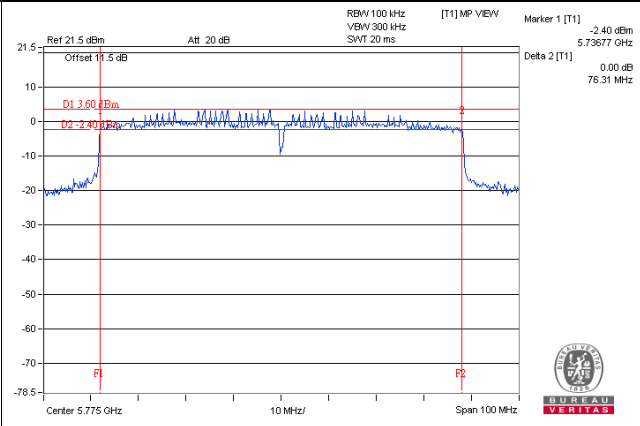

## 5 Pictures of Test Arrangements

Please refer to the attached file (Test Setup Photo).

### Annex A- Radiated Out of Band Emission (OOBE) Measurement (For U-NII-3 band)

802.11a

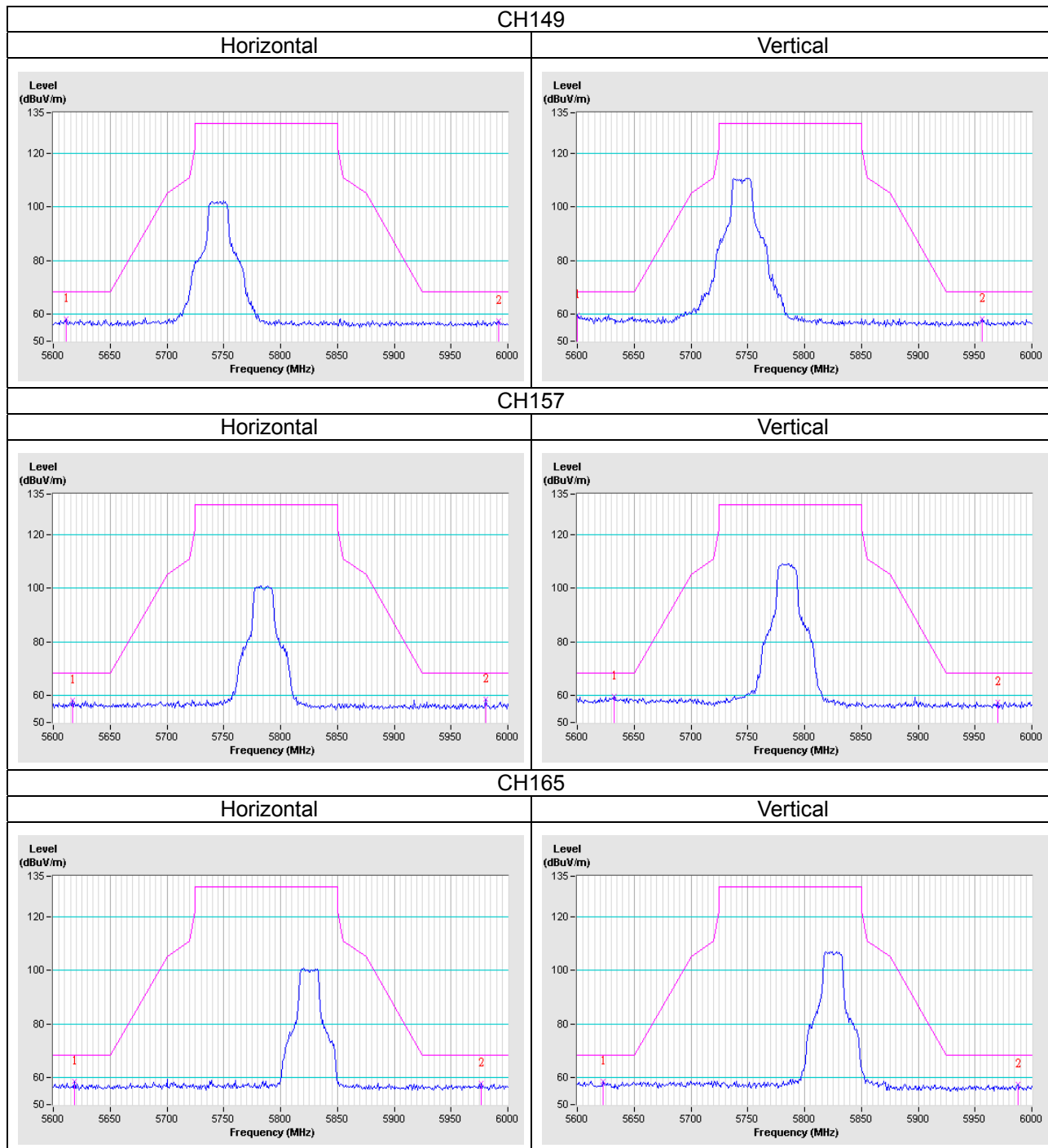

802.11n (HT20)

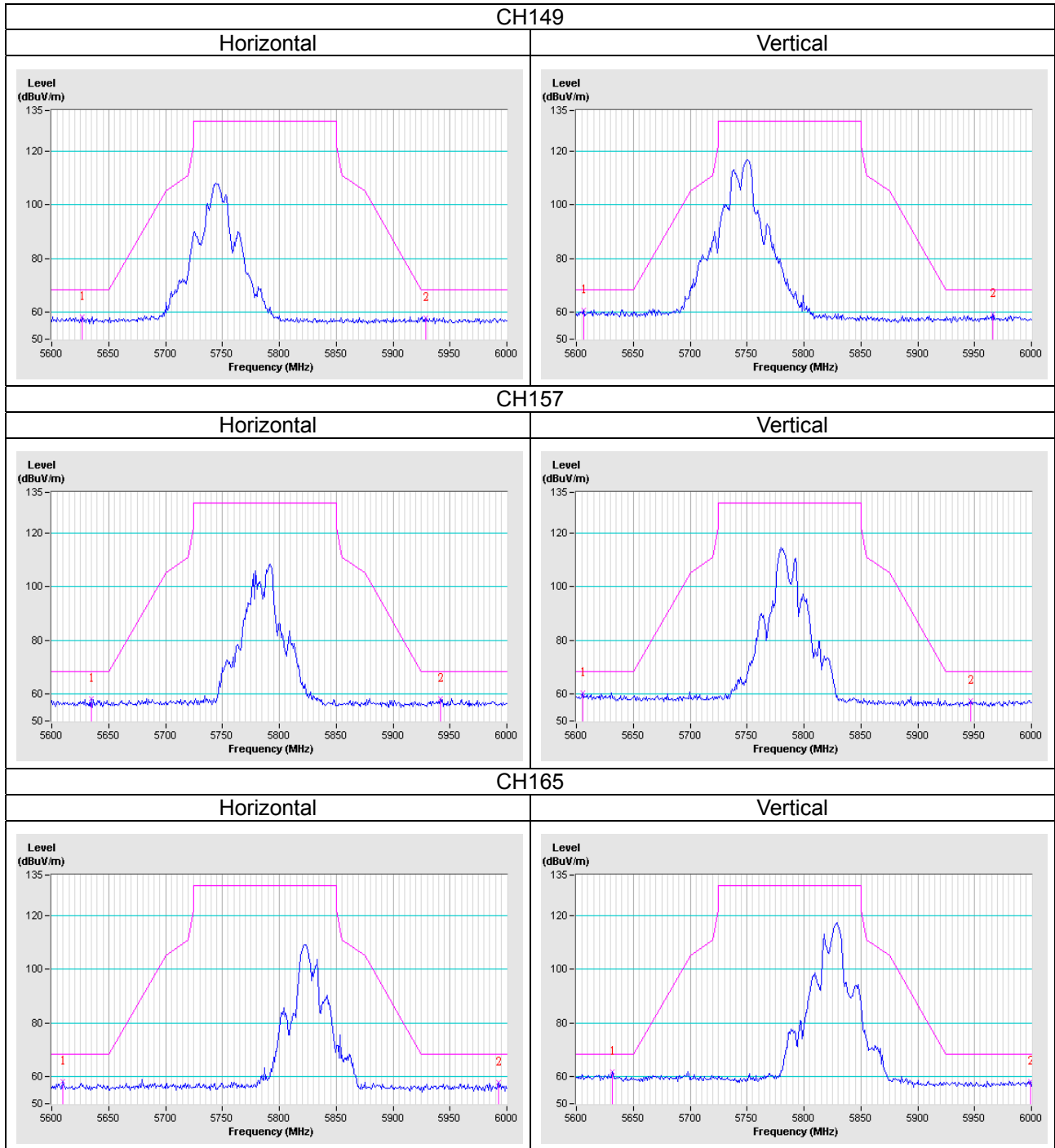

802.11n (HT40)

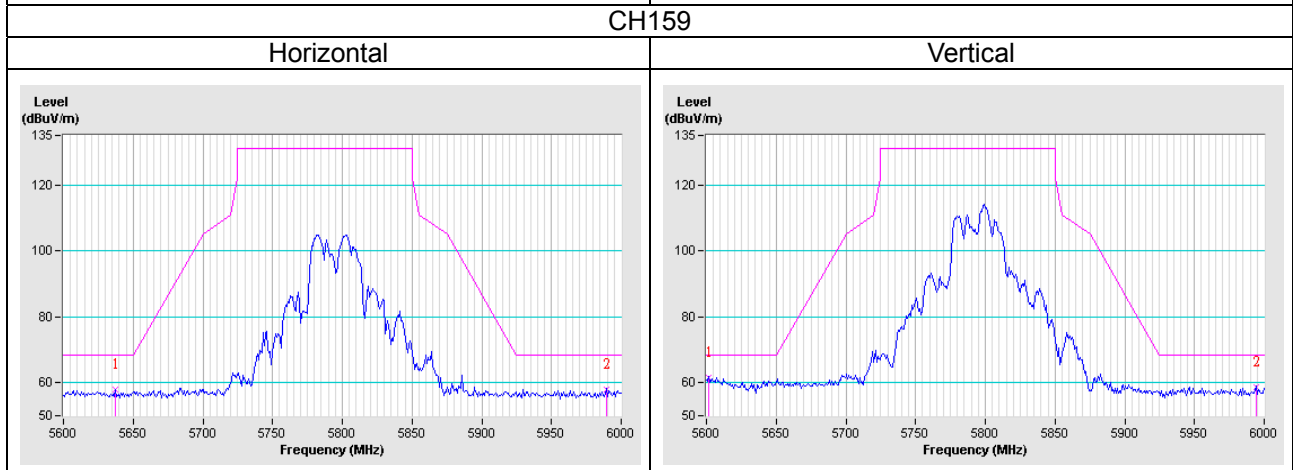
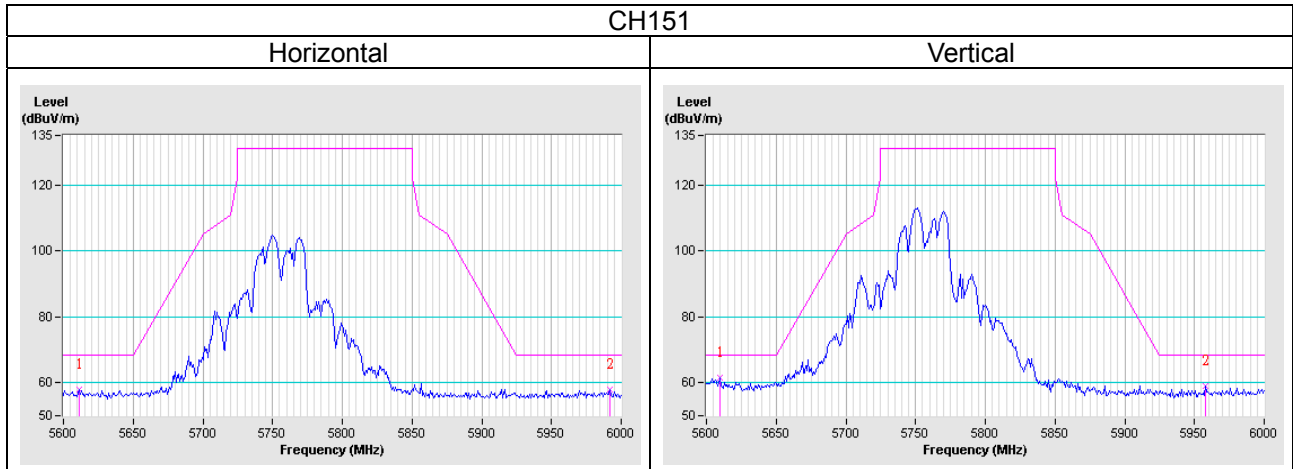

802.11ac (VHT80)

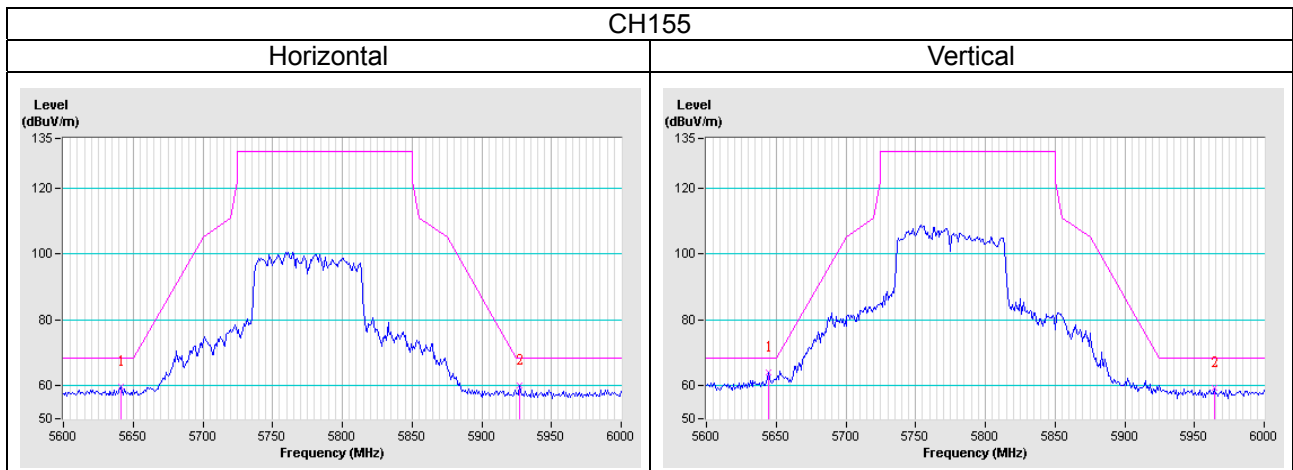

## Appendix – Information on the Testing Laboratories

We, Bureau Veritas Consumer Products Services (H.K.) Ltd., Taoyuan Branch, were founded in 1988 to provide our best service in EMC, Radio, Telecom and Safety consultation. Our laboratories are FCC recognized accredited test firms and accredited and approved according to ISO/IEC 17025.

If you have any comments, please feel free to contact us at the following:

### Linko EMC/RF Lab

Tel: 886-2-26052180

Fax: 886-2-26051924

### Hsin Chu EMC/RF/Telecom Lab

Tel: 886-3-6668565

Fax: 886-3-6668323

### Hwa Ya EMC/RF/Safety

Tel: 886-3-3183232

Fax: 886-3-3270892

**Email:** [service.adt@tw.bureauveritas.com](mailto:service.adt@tw.bureauveritas.com)

**Web Site:** [www.bureauveritas-adt.com](http://www.bureauveritas-adt.com)

The address and road map of all our labs can be found in our web site also.

--- END ---