

FCC Test Report

Report No.: RF170731C02-1

FCC ID: 2ACTO-7922DMC

Test Model: 7922DMC

Received Date: Jul. 31, 2017

Test Date: Oct. 20 ~ Nov. 30, 2017

Issued Date: Dec. 12, 2017

Applicant: Sophos Ltd

Address: The Pentagon, Abingdon, OX14 3YP, United Kingdom

Issued By: Bureau Veritas Consumer Products Services (H.K.) Ltd., Taoyuan Branch

Lab Address: No. 47-2, 14th Ling, Chia Pau Vil., Lin Kou Dist., New Taipei City, Taiwan (R.O.C.)

Test Location: No. 19, Hwa Ya 2nd Rd., Wen Hwa Vil., Kwei Shan Dist., Taoyuan City 33383, TAIWAN (R.O.C.)

**FCC Registration /
Designation Number:** 788550 / TW0003



This report is for your exclusive use. Any copying or replication of this report to or for any other person or entity, or use of our name or trademark, is permitted only with our prior written permission. This report sets forth our findings solely with respect to the test samples identified herein. The results set forth in this report are not indicative or representative of the quality or characteristics of the lot from which a test sample was taken or any similar or identical product unless specifically and expressly noted. Our report includes all of the tests requested by you and the results thereof based upon the information that you provided to us. You have 60 days from date of issuance of this report to notify us of any material error or omission caused by our negligence, provided, however, that such notice shall be in writing and shall specifically address the issue you wish to raise. A failure to raise such issue within the prescribed time shall constitute your unqualified acceptance of the completeness of this report, the tests conducted and the correctness of the report contents. Unless specific mention, the uncertainty of measurement has been explicitly taken into account to declare the compliance or non-compliance to the specification. The report must not be used by the client to claim product certification, approval, or endorsement by TAF or any government agencies.

Table of Contents

Release Control Record	4
1 Certificate of Conformity	5
2 Summary of Test Results	6
2.1 Measurement Uncertainty	6
2.2 Modification Record	6
3 General Information	7
3.1 General Description of EUT	7
3.2 Description of Test Modes	8
3.2.1 Test Mode Applicability and Tested Channel Detail	9
3.3 Duty Cycle of Test Signal	11
3.4 Description of Support Units	12
3.4.1 Configuration of System under Test	12
3.5 General Description of Applied Standards	12
4 Test Types and Results	13
4.1 Radiated Emission and Bandedge Measurement.....	13
4.1.1 Limits of Radiated Emission and Bandedge Measurement	13
4.1.2 Test Instruments	14
4.1.3 Test Procedures.....	15
4.1.4 Deviation from Test Standard	15
4.1.5 Test Setup.....	16
4.1.6 EUT Operating Conditions.....	17
4.1.7 Test Results	18
4.2 Conducted Emission Measurement	37
4.2.1 Limits of Conducted Emission Measurement	37
4.2.2 Test Instruments	37
4.2.3 Test Procedures.....	38
4.2.4 Deviation from Test Standard	38
4.2.5 Test Setup.....	38
4.2.6 EUT Operating Conditions.....	38
4.2.7 Test Results	39
4.3 Transmit Power Measurement	41
4.3.1 Limits of Transmit Power Measurement	41
4.3.2 Test Setup.....	41
4.3.3 Test Instruments	41
4.3.4 Test Procedure	42
4.3.5 Deviation from Test Standard	42
4.3.6 EUT Operating Conditions.....	42
4.3.7 Test Result.....	43
4.4 Occupied Bandwidth Measurement	44
4.4.1 Test Setup.....	44
4.4.2 Test Instruments	44
4.4.3 Test Procedure	44
4.4.4 Test Result.....	45
4.5 Peak Power Spectral Density Measurement	47
4.5.1 Limits of Peak Power Spectral Density Measurement	47
4.5.2 Test Setup.....	47
4.5.3 Test Instruments	47
4.5.4 Test Procedures.....	47
4.5.5 Deviation from Test Standard	48
4.5.6 EUT Operating Conditions.....	48
4.5.7 Test Results	49
4.6 Frequency Stability.....	53
4.6.1 Limits of Frequency Stability Measurement	53

4.6.2 Test Setup.....	53
4.6.3 Test Instruments	53
4.6.4 Test Procedure	54
4.6.5 Deviation from Test Standard	54
4.6.6 EUT Operating Condition	54
4.6.7 Test Results	54
4.7 6dB Bandwidth Measurement.....	55
4.7.1 Limits of 6dB Bandwidth Measurement.....	55
4.7.2 Test Setup.....	55
4.7.3 Test Instruments	55
4.7.4 Test Procedure	55
4.7.5 Deviation from Test Standard	55
4.7.6 EUT Operating Condition	55
4.7.7 Test Results	56
5 Pictures of Test Arrangements.....	58
Annex A- Radiated Out of Band Emission (OOBE) Measurement (For U-NII-3 band).....	59
Appendix – Information on the Testing Laboratories	62

Release Control Record

Issue No.	Description	Date Issued
RF170731C02-1	Original release.	Dec. 12, 2017

1 Certificate of Conformity

Product: 2T2R Wireless 802.11ac/abgn Dual Band Selectable PCIe Module

Brand: Sophos

Test Model: 7922DMC

Sample Status: Engineering sample

Applicant: Sophos Ltd

Test Date: Oct. 20 ~ Nov. 30, 2017

Standards: 47 CFR FCC Part 15, Subpart E (Section 15.407)
ANSI C63.10:2013

The above equipment has been tested by **Bureau Veritas Consumer Products Services (H.K.) Ltd., Taoyuan Branch**, and found compliance with the requirement of the above standards. The test record, data evaluation & Equipment Under Test (EUT) configurations represented herein are true and accurate accounts of the measurements of the sample's EMC characteristics under the conditions specified in this report.

Prepared by : Celine Chou , **Date:** Dec. 12, 2017
Celine Chou / Specialist

Approved by : Ken Liu , **Date:** Dec. 12, 2017
Ken Liu / Senior Manager

2 Summary of Test Results

47 CFR FCC Part 15, Subpart E (Section 15.407)			
FCC Clause	Test Item	Result	Remarks
15.407(b)(6)	AC Power Conducted Emissions	Pass	Meet the requirement of limit. Minimum passing margin is -19.85dB at 0.15391MHz.
15.407(b)(1/2/3/4(i/ii)/6)	Radiated Emissions & Band Edge Measurement	Pass	Meet the requirement of limit. Minimum passing margin is -1.1dB at 5150.00MHz.
15.407(a)(1/2/3)	Max Average Transmit Power	Pass	Meet the requirement of limit.
---	Occupied Bandwidth Measurement	-	Reference only.
15.407(a)(1/2/3)	Peak Power Spectral Density	Pass	Meet the requirement of limit.
15.407(e)	6dB bandwidth	Pass	Meet the requirement of limit. (U-NII-3 Band only)
15.407(g)	Frequency Stability	Pass	Meet the requirement of limit.
15.203	Antenna Requirement	Pass	Antenna connector is SMA Jack reverse not a standard connector.

*For U-NII-3 band compliance with rule part 15.407(b)(4)(i), the OOB test plots were recorded in Annex A.

2.1 Measurement Uncertainty

Where relevant, the following measurement uncertainty levels have been estimated for tests performed on the EUT as specified in CISPR 16-4-2:

Measurement	Frequency	Expanded Uncertainty (k=2) (\pm)
Conducted Emissions at mains ports	150kHz ~ 30MHz	2.94 dB
Radiated Emissions up to 1 GHz	30MHz ~ 200MHz	3.63 dB
	200MHz ~ 1000MHz	3.64 dB
Radiated Emissions above 1 GHz	1GHz ~ 18GHz	2.29 dB
	18GHz ~ 40GHz	2.29 dB

2.2 Modification Record

There were no modifications required for compliance.

3 General Information

3.1 General Description of EUT

Product	2T2R Wireless 802.11ac/abgn Dual Band Selectable PCIe Module
Brand	Sophos
Test Model	7922DMC
Sample Status	Engineering sample
Power Supply Rating	3.3Vdc
Modulation Type	256QAM, 64QAM, 16QAM, QPSK, BPSK
Modulation Technology	OFDM
Transfer Rate	802.11a: 54/48/36/24/18/12/9/6Mbps 802.11n: up to 300Mbps 802.11ac: up to 866.7Mbps
Operating Frequency	5180~5240MHz, 5745~5825MHz
Number of Channel	5180~5240MHz: 802.11a, 802.11n (HT20), 802.11ac (VHT20): 4 802.11n (HT40), 802.11ac (VHT40): 2 802.11ac (VHT80): 1 5745~5825MHz: 802.11a, 802.11n (HT20), 802.11ac (VHT20): 5 802.11n (HT40), 802.11ac (VHT40): 2 802.11ac (VHT80): 1
Output Power	5180~5240MHz: 261.278mW 5745~5825MHz: 225.541mW
Antenna Type	Refer to Note
Antenna Connector	Refer to Note
Accessory Device	Refer to Note
Cable Supplied	N/A

Note:

- The EUT incorporates a MIMO function. Physically, the EUT provides 2 completed transmitters and 2 receivers.

Modulation Mode	TX Function
802.11a	1TX (Fixed Chain 0)
802.11n (HT20)	2TX
802.11n (HT40)	2TX
802.11ac (VHT20)	2TX
802.11ac (VHT40)	2TX
802.11ac (VHT80)	2TX

* The modulation and bandwidth are similar for 802.11n mode for 20MHz/40MHz and 802.11ac mode for 20MHz/40MHz, therefore investigated worst case to representative mode in test report. (Final test mode refer section 3.2.1)

2. Accessory devices of EUT are list as below.

	Part Number	Spec.
Antenna	C059-510394-A	Antenna+RG-178+SMA Straight Plug Reverse Dual band
Antenna cable	C059-510395-A	RF CABLE+ ϕ 1.13mm(Gray) SMA Jack reverse+MHF L=250mm
	C059-510396-A	RF CABLE+ ϕ 1.13mm(Gray) SMA Jack reverse+MHF L=400mm
	C059-510397-A	RF CABLE+ ϕ 1.13mm(Gray) SMA Jack reverse(1080)+I-PEX L=100mm

* After pre-test three antenna cables, C059-510397-A antenna cable was the worst case and chosen for final test and presented in the test report

3. The EUT uses following antennas.

Type	Dipole			Connector	SMA Jack reverse		
Gain (dBi)	Frequency (MHz)						
	2400	2450	2500	5150	5350	5750	5825
	3.1	3.5	3.9	2.7	3.7	4.2	4.4

4. 2.4GHz & 5GHz technology cannot transmit at same time.

3.2 Description of Test Modes

5180~5240MHz:

4 channels are provided for 802.11a, 802.11n (HT20), 802.11ac (VHT20):

Channel	Frequency	Channel	Frequency
36	5180 MHz	44	5220 MHz
40	5200 MHz	48	5240 MHz

2 channels are provided for 802.11n (HT40), 802.11ac (VHT40):

Channel	Frequency	Channel	Frequency
38	5190 MHz	46	5230 MHz

1 channel is provided for 802.11ac (VHT80):

Channel	Frequency
42	5210MHz

5745~5825MHz:

5 channels are provided for 802.11a, 802.11n (HT20), 802.11ac (VHT20):

Channel	Frequency	Channel	Frequency
149	5745MHz	161	5805MHz
153	5765MHz	165	5825MHz
157	5785MHz		

2 channels are provided for 802.11n (HT40), 802.11ac (VHT40):

Channel	Frequency	Channel	Frequency
151	5755MHz	159	5795MHz

1 channel is provided for 802.11ac (VHT80):

Channel	Frequency
155	5775MHz

3.2.1 Test Mode Applicability and Tested Channel Detail

EUT Configure Mode	Applicable to				Description
	RE \geq 1G	RE $<$ 1G	PLC	APCM	
-	√	√	√	√	-

Where RE \geq 1G: Radiated Emission above 1GHz & Bandedge Measurement
 RE $<$ 1G: Radiated Emission below 1GHz
 PLC: Power Line Conducted Emission
 APCM: Antenna Port Conducted Measurement

Note: The EUT had been pre-tested on the positioned of each 3 axis. The worst case was found when positioned on **X-plane**.

Radiated Emission Test (Above 1GHz):

- Pre-Scan has been conducted to determine the worst-case mode from all possible combinations between available modulations, data rates and antenna ports (if EUT with antenna diversity architecture).
- Following channel(s) was (were) selected for the final test as listed below.

EUT Configure Mode	Mode	Frequency Band (MHz)	Available Channel	Tested Channel	Modulation Technology	Data Rate (Mbps)
-	802.11a	5180-5240	36 to 48	36, 40, 48	OFDM	6.0
	802.11n (HT20)		36 to 48	36, 40, 48	OFDM	6.5
	802.11n (HT40)		38 to 46	38, 46	OFDM	13.5
	802.11ac (VHT80)		42	42	OFDM	29.3
-	802.11a	5745-5825	149 to 165	149, 157, 165	OFDM	6.0
	802.11n (HT20)		149 to 165	149, 157, 165	OFDM	6.5
	802.11n (HT40)		151 to 159	151, 159	OFDM	13.5
	802.11ac (VHT80)		155	155	OFDM	29.3

Radiated Emission Test (Below 1GHz):

- Pre-Scan has been conducted to determine the worst-case mode from all possible combinations between available modulations, data rates and antenna ports (if EUT with antenna diversity architecture).
- Following channel(s) was (were) selected for the final test as listed below.

EUT Configure Mode	Mode	Frequency Band (MHz)	Available Channel	Tested Channel	Modulation Technology	Data Rate (Mbps)
-	802.11a	5180-5240	36 to 48	36	OFDM	6.0
	802.11a	5745-5825	149 to 165		OFDM	6.0

Power Line Conducted Emission Test:

- Pre-Scan has been conducted to determine the worst-case mode from all possible combinations between available modulations, data rates and antenna ports (if EUT with antenna diversity architecture).
- Following channel(s) was (were) selected for the final test as listed below.

EUT Configure Mode	Mode	Frequency Band (MHz)	Available Channel	Tested Channel	Modulation Technology	Data Rate (Mbps)
-	802.11a	5180-5240	36 to 48	36	OFDM	6.0
	802.11a	5745-5825	149 to 165		OFDM	6.0

Antenna Port Conducted Measurement:

- This item includes all test value of each mode, but only includes spectrum plot of worst value of each mode.
- Pre-Scan has been conducted to determine the worst-case mode from all possible combinations between available modulations, data rates and antenna ports (if EUT with antenna diversity architecture).
- Following channel(s) was (were) selected for the final test as listed below.

EUT Configure Mode	Mode	Frequency Band (MHz)	Available Channel	Tested Channel	Modulation Technology	Data Rate (Mbps)
-	802.11a	5180-5240	36 to 48	36, 40, 48	OFDM	6.0
	802.11n (HT20)		36 to 48	36, 40, 48	OFDM	6.5
	802.11n (HT40)		38 to 46	38, 46	OFDM	13.5
	802.11ac (VHT80)		42	42	OFDM	29.3
-	802.11a	5745-5825	149 to 165	149, 157, 165	OFDM	6.0
	802.11n (HT20)		149 to 165	149, 157, 165	OFDM	6.5
	802.11n (HT40)		151 to 159	151, 159	OFDM	13.5
	802.11ac (VHT80)		155	155	OFDM	29.3

Test Condition:

Applicable to	Environmental Conditions	Input Power (System)	Tested by
RE _≥ 1G	25 deg. C, 70% RH	120Vac, 60Hz	Luis Lee
RE _{<} 1G	25 deg. C, 70% RH	120Vac, 60Hz	Matthew Yang
PLC	25 deg. C, 75% RH	120Vac, 60Hz	Matthew Yang
APCM	25 deg. C, 60% RH	120Vac, 60Hz	Han Wu

3.3 Duty Cycle of Test Signal

Duty cycle of test signal is < 98%, duty factor is required.

802.11a: Duty cycle = $2.708/2.785 = 0.972$, Duty factor = $10 * \log(1/0.972) = 0.12$

802.11n (HT20): Duty cycle = $2.507/2.599 = 0.965$, Duty factor = $10 * \log(1/0.965) = 0.16$

802.11n (HT40): Duty cycle = $1.229/1.297 = 0.948$, Duty factor = $10 * \log(1/0.948) = 0.23$

802.11ac (VHT80): Duty cycle = $0.084/0.152 = 0.553$, Duty factor = $10 * \log(1/0.553) = 2.58$

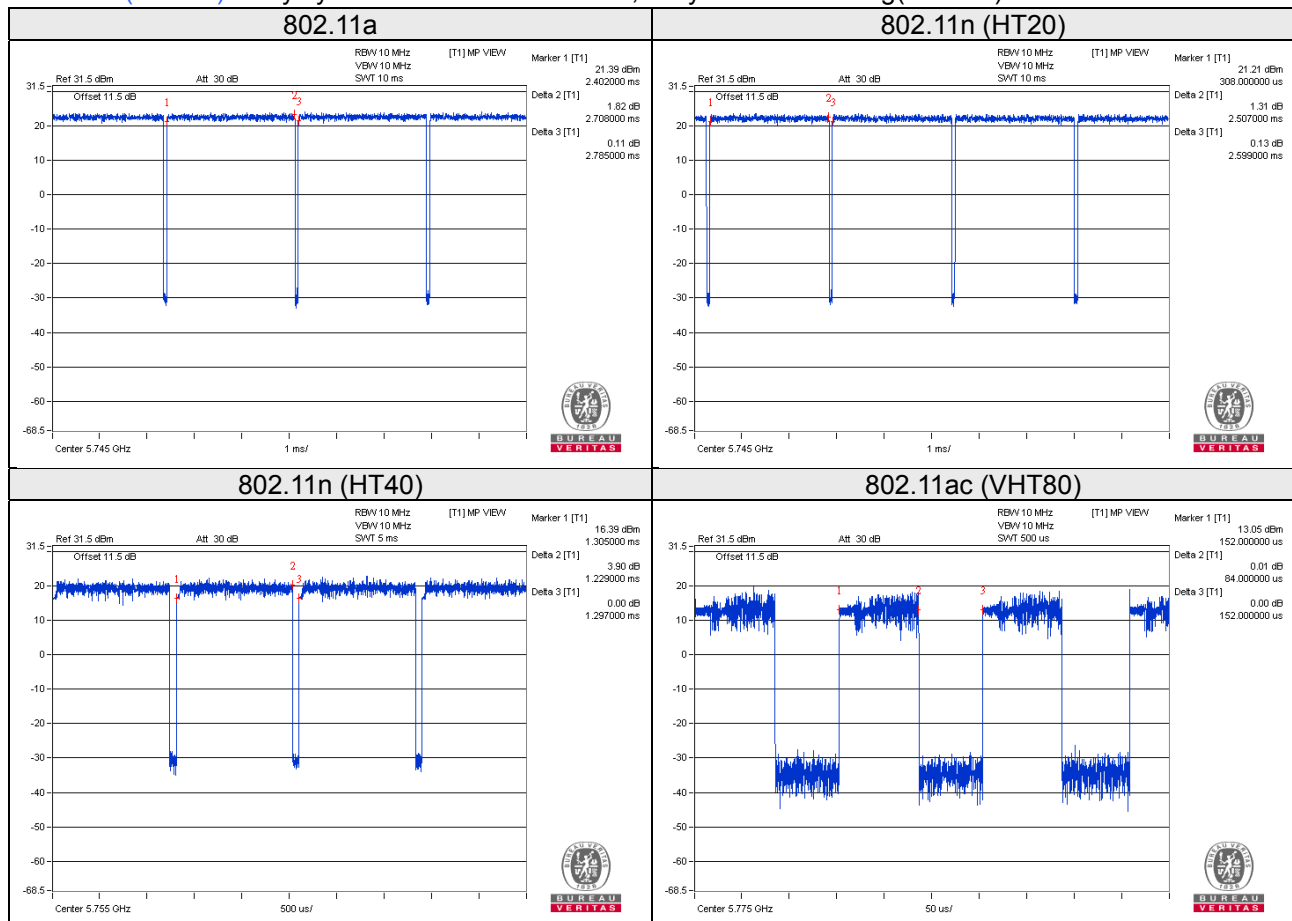

3.4 Description of Support Units

The EUT has been tested as an independent unit together with other necessary accessories or support units. The following support units or accessories were used to form a representative test configuration during the tests.

ID	Product	Brand	Model No.	Serial No.	FCC ID	Remarks
A.	Adapter	DVE	DSA-36PFH-12FUS	N/A	N/A	Provided by client
B.	Notebook	DELL	E5410	6RP2YM1	FCC DoC Approved	-
C.	Convertible Board	N/A	N/A	N/A	N/A	Provided by client

Note:

1. All power cords of the above support units are non-shielded (1.8m).
2. Item B acted as a communication partner to transfer data.

ID	Descriptions	Qty.	Length (m)	Shielding (Yes/No)	Cores (Qty.)	Remarks
1.	DC cable	1	1.5	N	0	Provided by client
2.	RJ45, Cat5e	1	3	N	0	-

3.4.1 Configuration of System under Test

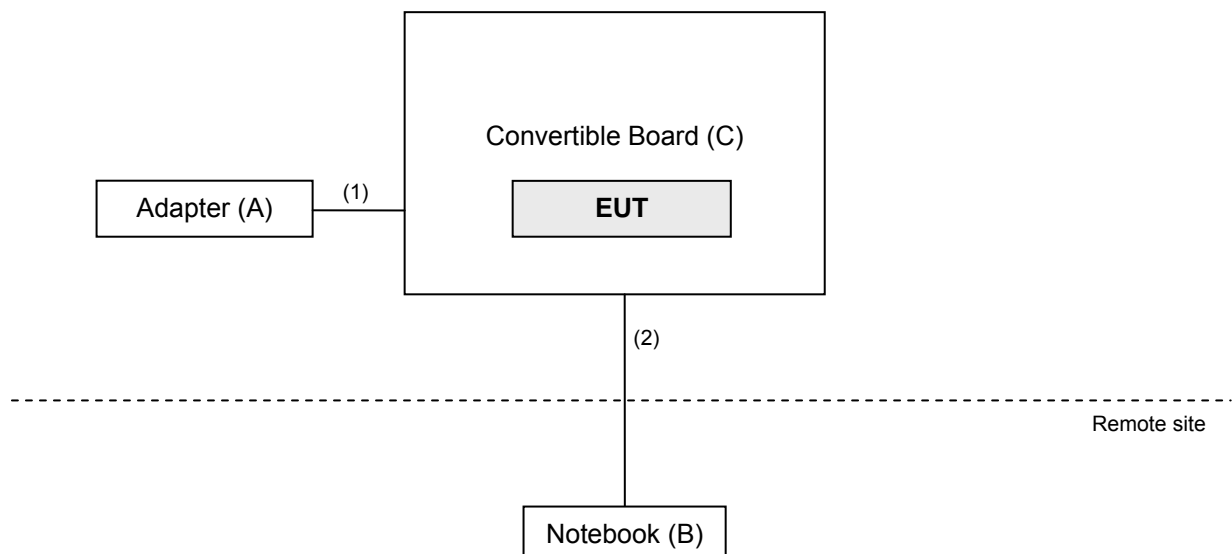

3.5 General Description of Applied Standards

The EUT is a RF Product. According to the specifications of the manufacturer, it must comply with the requirements of the following standards:

FCC Part 15, Subpart E (15.407)

KDB 789033 D02 General UNII Test Procedure New Rules v02r01

KDB 662911 D01 Multiple Transmitter Output v02r01

ANSI C63.10:2013

All test items have been performed and recorded as per the above standards.

Note: The EUT has been verified to comply with the requirements of FCC Part 15, Subpart B, Class B (DoC). The test report has been issued separately.

4 Test Types and Results

4.1 Radiated Emission and Bandedge Measurement

4.1.1 Limits of Radiated Emission and Bandedge Measurement

Radiated emissions which fall in the restricted bands must comply with the radiated emission limits specified as below table.

Frequencies (MHz)	Field Strength (microvolts/meter)	Measurement Distance (meters)
0.009 ~ 0.490	2400/F(kHz)	300
0.490 ~ 1.705	24000/F(kHz)	30
1.705 ~ 30.0	30	30
30 ~ 88	100	3
88 ~ 216	150	3
216 ~ 960	200	3
Above 960	500	3

Note:

1. The lower limit shall apply at the transition frequencies.
2. Emission level (dBuV/m) = 20 log Emission level (uV/m).
3. For frequencies above 1000MHz, the field strength limits are based on average detector, however, the peak field strength of any emission shall not exceed the maximum permitted average limits, specified above by more than 20dB under any condition of modulation.

Limits of unwanted emission out of the restricted bands

Applicable To		Limit	
789033 D02 General UNII Test Procedure New Rules v02r01		Field Strength at 3m	
		PK: 74 (dBµV/m)	AV: 54 (dBµV/m)
Frequency Band	Applicable To	EIRP Limit	Equivalent Field Strength at 3m
5150~5250 MHz	15.407(b)(1)	PK: -27 (dBm/MHz)	PK: 68.2(dBµV/m)
5250~5350 MHz	15.407(b)(2)		
5470~5725 MHz	15.407(b)(3)		
5725~5850 MHz	<input checked="" type="checkbox"/> 15.407(b)(4)(i)	PK: -27 (dBm/MHz) ^{*1} PK: 10 (dBm/MHz) ^{*2} PK: 15.6 (dBm/MHz) ^{*3} PK: 27 (dBm/MHz) ^{*4}	PK: 68.2(dBµV/m) ^{*1} PK: 105.2 (dBµV/m) ^{*2} PK: 110.8(dBµV/m) ^{*3} PK: 122.2 (dBµV/m) ^{*4}
	<input type="checkbox"/> 15.407(b)(4)(ii)	Emission limits in section 15.247(d)	
^{*1} beyond 75 MHz or more above of the band edge. ^{*3} below the band edge increasing linearly to a level of 15.6 dBm/MHz at 5 MHz above.		^{*2} below the band edge increasing linearly to 10 dBm/MHz at 25 MHz above. ^{*4} from 5 MHz above or below the band edge increasing linearly to a level of 27 dBm/MHz at the band edge.	

Note: The following formula is used to convert the equipment isotropic radiated power (eirp) to field strength:

$$E = \frac{1000000 \sqrt{30P}}{3} \mu\text{V/m, where P is the eirp (Watts).}$$

4.1.2 Test Instruments

Description & Manufacturer	Model No.	Serial No.	Cal. Date	Cal. Due
Test Receiver ROHDE & SCHWARZ	ESCI	100424	Oct. 17, 2017	Oct. 16, 2018
Spectrum Analyzer ROHDE & SCHWARZ	FSP40	100040	Aug. 18, 2017	Aug. 17, 2018
BILOG Antenna SCHWARZBECK	VULB9168	9168-155	Dec. 11, 2016	Dec. 10, 2017
HORN Antenna SCHWARZBECK	BBHA 9120D	9120D-1170	Dec. 15, 2016	Dec. 14, 2017
HORN Antenna SCHWARZBECK	BBHA 9170	BBHA9170241	Dec. 14, 2016	Dec. 13, 2017
Loop Antenna EMCI	EM-6879	269	Aug. 11, 2017	Aug. 10, 2018
Preamplifier Agilent (Below 1GHz)	8447D	2944A10631	Aug. 08, 2017	Aug. 07, 2018
Preamplifier Agilent (Above 1GHz)	8449B	3008A01960	Aug. 08, 2017	Aug. 07, 2018
RF signal cable HUBER+SUHNER	SUCOFLEX 104	MY 13380+295012/04	Aug. 08, 2017	Aug. 07, 2018
RF signal cable HUBER+SUHNER	SUCOFLEX 104	Cable-CH4-03 (250724)	Aug. 08, 2017	Aug. 07, 2018
Software BV ADT	ADT_Radiated_ V7.6.15.9.4	NA	NA	NA
Antenna Tower inn-co GmbH	MA 4000	010303	NA	NA
Antenna Tower Controller BV ADT	AT100	AT93021703	NA	NA
Turn Table BV ADT	TT100	TT93021703	NA	NA
Turn Table Controller BV ADT	SC100	SC93021703	NA	NA
26GHz ~ 40GHz Amplifier Agilent	8449B	3008A1960	Aug. 08, 2017	Aug. 07, 2018
High Speed Peak Power Meter	ML2495A	0824012	Aug. 18, 2017	Aug. 17, 2018
Power Sensor	MA2411B	0738171	Aug. 18, 2017	Aug. 17, 2018
WIT Standard Temperature And Humidity Chamber	TH-4S-C	W981030	Jun. 07, 2017	Jun. 06, 2018

- Note: 1. The calibration interval of the above test instruments is 12 months and the calibrations are traceable to NML/ROC and NIST/USA.
 2. The test was performed in HwaYa Chamber 4.
 3. The FCC Designation Number is TW0003. The number will be varied with the Lab location and scope as attached.
 4. The IC Site Registration No. is IC7450F-4.

4.1.3 Test Procedures

For Radiated emission below 30MHz

- a. The EUT was placed on the top of a rotating table 0.8 meters above the ground at a 3 meter chamber room. The table was rotated 360 degrees to determine the position of the highest radiation.
- b. The EUT was set 3 meters away from the interference-receiving antenna, which was mounted on the top of a variable-height antenna tower.
- c. Both X and Y axes of the antenna are set to make the measurement.
- d. For each suspected emission, the EUT was arranged to its worst case and the rotatable table was turned from 0 degrees to 360 degrees to find the maximum reading.
- e. The test-receiver system was set to Quasi-Peak Detect Function and Specified Bandwidth with Maximum Hold Mode.

Note:

1. The resolution bandwidth and video bandwidth of test receiver/spectrum analyzer is 9kHz at frequency below 30MHz.

For Radiated emission above 30MHz

- a. The EUT was placed on the top of a rotating table 0.8 meters (for 30MHz ~ 1GHz) / 1.5 meters (for above 1GHz) above the ground at 3 meter chamber room for test. The table was rotated 360 degrees to determine the position of the highest radiation.
- b. The EUT was set 3 meters away from the interference-receiving antenna, which was mounted on the top of a variable-height antenna tower.
- c. The height of antenna is varied from one meter to four meters above the ground to determine the maximum value of the field strength. Both horizontal and vertical polarizations of the antenna are set to make the measurement.
- d. For each suspected emission, the EUT was arranged to its worst case and then the antenna was tuned to heights from 1 meter to 4 meters and the rotatable table was turned from 0 degrees to 360 degrees to find the maximum reading.
- e. The test-receiver system was set to quasi-peak detect function and specified bandwidth with maximum hold mode when the test frequency is below 1 GHz.
- f. The test-receiver system was set to peak and average detect function and specified bandwidth with maximum hold mode when the test frequency is above 1 GHz. If the peak reading value also meets average limit, measurement with the average detector is unnecessary.

Note:

1. The resolution bandwidth and video bandwidth of test receiver/spectrum analyzer is 120kHz for Quasi-peak detection (QP) at frequency below 1GHz.
2. The resolution bandwidth of test receiver/spectrum analyzer is 1 MHz and the video bandwidth is 3 MHz for Peak detection (PK) at frequency above 1GHz.
3. The resolution bandwidth of test receiver/spectrum analyzer is 1MHz and the video bandwidth is $\geq 1/T$ (Duty cycle < 98%) or 10Hz (Duty cycle $\geq 98\%$) for Average detection (AV) at frequency above 1GHz.
4. All modes of operation were investigated and the worst-case emissions are reported.

4.1.4 Deviation from Test Standard

No deviation.

4.1.5 Test Setup

For Radiated emission below 30MHz

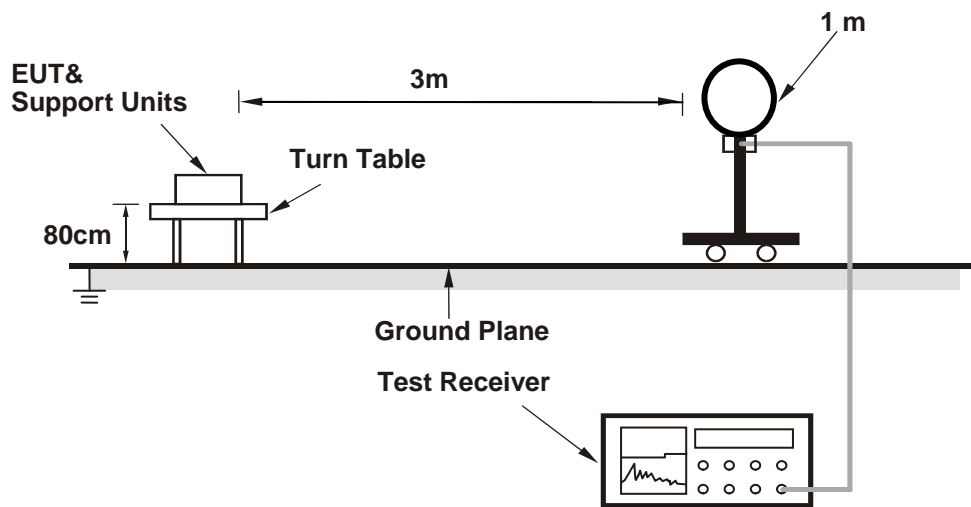

For Radiated emission 30MHz to 1GHz

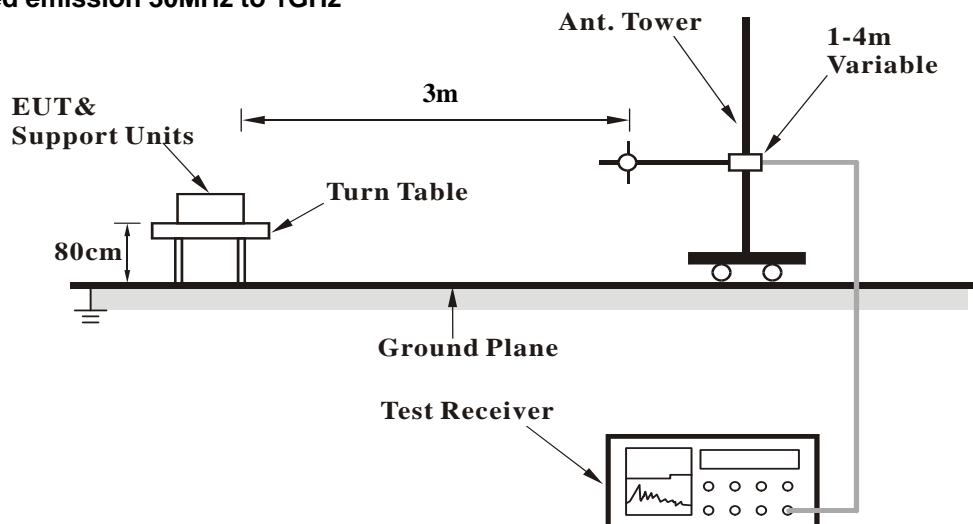

For Radiated emission above 1GHz

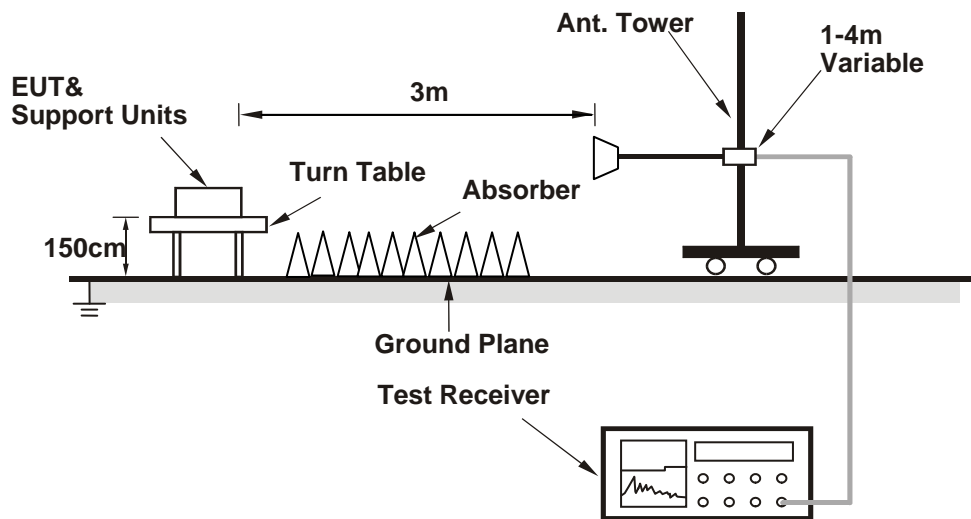

For the actual test configuration, please refer to the attached file (Test Setup Photo).

4.1.6 EUT Operating Conditions

- a. Connected EUT with convertible board and placed the EUT on the testing table.
- b. Prepared a notebook to act as a communication partner and placed it outside of testing area.
- c. The communication partner connected with EUT via a RJ45 cable and ran a test program (provided by manufacturer) to enable EUT under transmission condition continuously at specific channel frequency.
- d. The communication partner sent data to EUT by command "PING".

4.1.7 Test Results

Above 1GHz data:

802.11a

CHANNEL	TX Channel 36	DETECTOR	Peak (PK)
FREQUENCY RANGE	1GHz ~ 40GHz	FUNCTION	Average (AV)

ANTENNA POLARITY & TEST DISTANCE: HORIZONTAL AT 3 M								
NO.	FREQ. (MHz)	EMISSION LEVEL (dBuV/m)	LIMIT (dBuV/m)	MARGIN (dB)	ANTENNA HEIGHT (m)	TABLE ANGLE (Degree)	RAW VALUE (dBuV)	CORRECTION FACTOR (dB/m)
1	5150.00	60.7 PK	74.0	-13.3	1.16 H	135	53.3	7.4
2	5150.00	47.4 AV	54.0	-6.6	1.16 H	135	40.0	7.4
3	*5180.00	104.5 PK			1.30 H	124	63.2	41.3
4	*5180.00	93.8 AV			1.30 H	124	52.5	41.3
5	#10360.00	61.6 PK	74.0	-12.4	2.71 H	119	41.6	20.0
6	#10360.00	48.9 AV	54.0	-5.1	2.71 H	119	28.9	20.0
ANTENNA POLARITY & TEST DISTANCE: VERTICAL AT 3 M								
NO.	FREQ. (MHz)	EMISSION LEVEL (dBuV/m)	LIMIT (dBuV/m)	MARGIN (dB)	ANTENNA HEIGHT (m)	TABLE ANGLE (Degree)	RAW VALUE (dBuV)	CORRECTION FACTOR (dB/m)
1	5150.00	67.1 PK	74.0	-6.9	1.00 V	126	59.7	7.4
2	5150.00	52.7 AV	54.0	-1.3	1.00 V	126	45.3	7.4
3	*5180.00	112.4 PK			1.00 V	93	71.1	41.3
4	*5180.00	102.0 AV			1.00 V	93	60.7	41.3
5	#10360.00	63.1 PK	74.0	-10.9	1.58 V	236	43.1	20.0
6	#10360.00	49.5 AV	54.0	-4.5	1.58 V	236	29.5	20.0

Remarks:

1. Emission Level(dBuV/m) = Raw Value(dBuV) + Correction Factor(dB/m)
2. Correction Factor(dB/m) = Antenna Factor(dB/m) + Cable Factor(dB) – Pre-Amplifier Factor(dB)
3. The other emission levels were very low against the limit.
4. Margin value = Emission Level – Limit value
5. " * ": Fundamental frequency.
6. " # ": The radiated frequency is out of the restricted band.

CHANNEL	TX Channel 40	DETECTOR	Peak (PK)
FREQUENCY RANGE	1GHz ~ 40GHz	FUNCTION	Average (AV)

ANTENNA POLARITY & TEST DISTANCE: HORIZONTAL AT 3 M

NO.	FREQ. (MHz)	EMISSION LEVEL (dBuV/m)	LIMIT (dBuV/m)	MARGIN (dB)	ANTENNA HEIGHT (m)	TABLE ANGLE (Degree)	RAW VALUE (dBuV)	CORRECTION FACTOR (dB/m)
1	*5200.00	106.5 PK			1.25 H	121	65.2	41.3
2	*5200.00	95.9 AV			1.25 H	121	54.6	41.3
3	#10400.00	61.8 PK	74.0	-12.2	2.41 H	133	41.6	20.2
4	#10400.00	49.3 AV	54.0	-4.7	2.41 H	133	29.1	20.2

ANTENNA POLARITY & TEST DISTANCE: VERTICAL AT 3 M

NO.	FREQ. (MHz)	EMISSION LEVEL (dBuV/m)	LIMIT (dBuV/m)	MARGIN (dB)	ANTENNA HEIGHT (m)	TABLE ANGLE (Degree)	RAW VALUE (dBuV)	CORRECTION FACTOR (dB/m)
1	*5200.00	114.1 PK			1.00 V	129	72.8	41.3
2	*5200.00	103.8 AV			1.00 V	129	62.5	41.3
3	#10400.00	63.5 PK	74.0	-10.5	2.66 V	187	43.3	20.2
4	#10400.00	50.0 AV	54.0	-4.0	2.66 V	187	29.8	20.2

Remarks:

1. Emission Level(dBuV/m) = Raw Value(dBuV) + Correction Factor(dB/m)
2. Correction Factor(dB/m) = Antenna Factor(dB/m) + Cable Factor(dB) – Pre-Amplifier Factor(dB)
3. The other emission levels were very low against the limit.
4. Margin value = Emission Level – Limit value
5. " * ": Fundamental frequency.
6. " # ": The radiated frequency is out of the restricted band.

CHANNEL	TX Channel 48	DETECTOR FUNCTION	Peak (PK)
FREQUENCY RANGE	1GHz ~ 40GHz		Average (AV)

ANTENNA POLARITY & TEST DISTANCE: HORIZONTAL AT 3 M

NO.	FREQ. (MHz)	EMISSION LEVEL (dBuV/m)	LIMIT (dBuV/m)	MARGIN (dB)	ANTENNA HEIGHT (m)	TABLE ANGLE (Degree)	RAW VALUE (dBuV)	CORRECTION FACTOR (dB/m)
1	*5240.00	106.8 PK			1.11 H	120	65.3	41.5
2	*5240.00	96.8 AV			1.11 H	120	55.3	41.5
3	5350.00	59.8 PK	74.0	-14.2	1.30 H	114	51.8	8.0
4	5350.00	46.9 AV	54.0	-7.1	1.30 H	114	38.9	8.0
5	#10480.00	62.2 PK	74.0	-11.8	1.44 H	201	41.9	20.3
6	#10480.00	49.0 AV	54.0	-5.0	1.44 H	201	28.7	20.3

ANTENNA POLARITY & TEST DISTANCE: VERTICAL AT 3 M

NO.	FREQ. (MHz)	EMISSION LEVEL (dBuV/m)	LIMIT (dBuV/m)	MARGIN (dB)	ANTENNA HEIGHT (m)	TABLE ANGLE (Degree)	RAW VALUE (dBuV)	CORRECTION FACTOR (dB/m)
1	*5240.00	114.1 PK			1.00 V	96	72.6	41.5
2	*5240.00	103.7 AV			1.00 V	96	62.2	41.5
3	5350.00	60.7 PK	74.0	-13.3	1.21 V	88	52.7	8.0
4	5350.00	47.6 AV	54.0	-6.4	1.21 V	88	39.6	8.0
5	#10480.00	62.9 PK	74.0	-11.1	2.40 V	187	42.6	20.3
6	#10480.00	49.8 AV	54.0	-4.2	2.40 V	187	29.5	20.3

Remarks:

1. Emission Level(dBuV/m) = Raw Value(dBuV) + Correction Factor(dB/m)
2. Correction Factor(dB/m) = Antenna Factor(dB/m) + Cable Factor(dB) – Pre-Amplifier Factor(dB)
3. The other emission levels were very low against the limit.
4. Margin value = Emission Level – Limit value
5. " * ": Fundamental frequency.
6. " # ": The radiated frequency is out of the restricted band.

CHANNEL	TX Channel 149	DETECTOR FUNCTION	Peak (PK)
FREQUENCY RANGE	1GHz ~ 40GHz		Average (AV)

ANTENNA POLARITY & TEST DISTANCE: HORIZONTAL AT 3 M

NO.	FREQ. (MHz)	EMISSION LEVEL (dBuV/m)	LIMIT (dBuV/m)	MARGIN (dB)	ANTENNA HEIGHT (m)	TABLE ANGLE (Degree)	RAW VALUE (dBuV)	CORRECTION FACTOR (dB/m)
1	#5644.80	60.5 PK	68.2	-7.7	1.01 H	62	51.9	8.6
2	*5745.00	108.5 PK			1.01 H	62	65.8	42.7
3	*5745.00	98.8 AV			1.01 H	62	56.1	42.7
4	#5966.40	62.3 PK	68.2	-5.9	1.01 H	62	52.7	9.6
5	11490.00	63.9 PK	74.0	-10.1	1.90 H	213	42.1	21.8
6	11490.00	50.5 AV	54.0	-3.5	1.90 H	213	28.7	21.8

ANTENNA POLARITY & TEST DISTANCE: VERTICAL AT 3 M

NO.	FREQ. (MHz)	EMISSION LEVEL (dBuV/m)	LIMIT (dBuV/m)	MARGIN (dB)	ANTENNA HEIGHT (m)	TABLE ANGLE (Degree)	RAW VALUE (dBuV)	CORRECTION FACTOR (dB/m)
1	#5638.40	61.1 PK	68.2	-7.1	2.18 V	310	52.6	8.5
2	*5745.00	112.4 PK			2.18 V	310	69.7	42.7
3	*5745.00	101.8 AV			2.18 V	310	59.1	42.7
4	#5945.60	61.6 PK	68.2	-6.6	2.18 V	310	52.2	9.4
5	11490.00	64.4 PK	74.0	-9.6	2.45 V	169	42.6	21.8
6	11490.00	51.5 AV	54.0	-2.5	2.45 V	169	29.7	21.8

Remarks:

1. Emission Level(dBuV/m) = Raw Value(dBuV) + Correction Factor(dB/m)
2. Correction Factor(dB/m) = Antenna Factor(dB/m) + Cable Factor(dB) – Pre-Amplifier Factor(dB)
3. The other emission levels were very low against the limit.
4. Margin value = Emission Level – Limit value
5. " * ": Fundamental frequency.
6. " # ": The radiated frequency is out of the restricted band.

CHANNEL	TX Channel 157	DETECTOR FUNCTION	Peak (PK)
FREQUENCY RANGE	1GHz ~ 40GHz		Average (AV)

ANTENNA POLARITY & TEST DISTANCE: HORIZONTAL AT 3 M

NO.	FREQ. (MHz)	EMISSION LEVEL (dBuV/m)	LIMIT (dBuV/m)	MARGIN (dB)	ANTENNA HEIGHT (m)	TABLE ANGLE (Degree)	RAW VALUE (dBuV)	CORRECTION FACTOR (dB/m)
1	#5620.80	60.9 PK	68.2	-7.3	1.00 H	63	52.4	8.5
2	*5785.00	110.2 PK			1.00 H	63	67.5	42.7
3	*5785.00	99.9 AV			1.00 H	63	57.2	42.7
4	#5929.60	61.7 PK	68.2	-6.5	1.00 H	63	52.3	9.4
5	11570.00	63.7 PK	74.0	-10.3	2.63 H	117	41.9	21.8
6	11570.00	50.6 AV	54.0	-3.4	2.63 H	117	28.8	21.8

ANTENNA POLARITY & TEST DISTANCE: VERTICAL AT 3 M

NO.	FREQ. (MHz)	EMISSION LEVEL (dBuV/m)	LIMIT (dBuV/m)	MARGIN (dB)	ANTENNA HEIGHT (m)	TABLE ANGLE (Degree)	RAW VALUE (dBuV)	CORRECTION FACTOR (dB/m)
1	#5609.60	61.1 PK	68.2	-7.1	2.22 V	308	52.6	8.5
2	*5785.00	111.6 PK			2.22 V	308	68.9	42.7
3	*5785.00	101.0 AV			2.22 V	308	58.3	42.7
4	#5997.60	61.9 PK	68.2	-6.3	2.22 V	308	52.2	9.7
5	11570.00	64.4 PK	74.0	-9.6	1.98 V	225	42.6	21.8
6	11570.00	51.3 AV	54.0	-2.7	1.98 V	225	29.5	21.8

Remarks:

1. Emission Level(dBuV/m) = Raw Value(dBuV) + Correction Factor(dB/m)
2. Correction Factor(dB/m) = Antenna Factor(dB/m) + Cable Factor(dB) – Pre-Amplifier Factor(dB)
3. The other emission levels were very low against the limit.
4. Margin value = Emission Level – Limit value
5. " * ": Fundamental frequency.
6. " # ": The radiated frequency is out of the restricted band.

CHANNEL	TX Channel 165	DETECTOR FUNCTION	Peak (PK)
FREQUENCY RANGE	1GHz ~ 40GHz		Average (AV)

ANTENNA POLARITY & TEST DISTANCE: HORIZONTAL AT 3 M

NO.	FREQ. (MHz)	EMISSION LEVEL (dBuV/m)	LIMIT (dBuV/m)	MARGIN (dB)	ANTENNA HEIGHT (m)	TABLE ANGLE (Degree)	RAW VALUE (dBuV)	CORRECTION FACTOR (dB/m)
1	#5612.80	61.5 PK	68.2	-6.7	1.00 H	65	53.0	8.5
2	*5825.00	108.9 PK			1.00 H	65	66.0	42.9
3	*5825.00	98.8 AV			1.00 H	65	55.9	42.9
4	#5967.20	61.8 PK	68.2	-6.4	1.00 H	65	52.2	9.6
5	11650.00	63.2 PK	74.0	-10.8	2.36 H	220	41.8	21.4
6	11650.00	50.5 AV	54.0	-3.5	2.36 H	220	29.1	21.4

ANTENNA POLARITY & TEST DISTANCE: VERTICAL AT 3 M

NO.	FREQ. (MHz)	EMISSION LEVEL (dBuV/m)	LIMIT (dBuV/m)	MARGIN (dB)	ANTENNA HEIGHT (m)	TABLE ANGLE (Degree)	RAW VALUE (dBuV)	CORRECTION FACTOR (dB/m)
1	#5600.80	61.6 PK	68.2	-6.6	1.62 V	313	53.1	8.5
2	*5825.00	110.3 PK			1.62 V	313	67.4	42.9
3	*5825.00	100.3 AV			1.62 V	313	57.4	42.9
4	#5993.60	61.8 PK	68.2	-6.4	1.62 V	313	52.1	9.7
5	11650.00	64.5 PK	74.0	-9.5	2.13 V	225	43.1	21.4
6	11650.00	51.2 AV	54.0	-2.8	2.13 V	225	29.8	21.4

Remarks:

1. Emission Level(dBuV/m) = Raw Value(dBuV) + Correction Factor(dB/m)
2. Correction Factor(dB/m) = Antenna Factor(dB/m) + Cable Factor(dB) – Pre-Amplifier Factor(dB)
3. The other emission levels were very low against the limit.
4. Margin value = Emission Level – Limit value
5. " * ": Fundamental frequency.
6. " # ": The radiated frequency is out of the restricted band.

802.11n (HT20)

CHANNEL	TX Channel 36	DETECTOR	Peak (PK)
FREQUENCY RANGE	1GHz ~ 40GHz	FUNCTION	Average (AV)

ANTENNA POLARITY & TEST DISTANCE: HORIZONTAL AT 3 M								
NO.	FREQ. (MHz)	EMISSION LEVEL (dBuV/m)	LIMIT (dBuV/m)	MARGIN (dB)	ANTENNA HEIGHT (m)	TABLE ANGLE (Degree)	RAW VALUE (dBuV)	CORRECTION FACTOR (dB/m)
1	5150.00	59.8 PK	74.0	-14.2	1.29 H	125	52.4	7.4
2	5150.00	46.4 AV	54.0	-7.6	1.29 H	125	39.0	7.4
3	*5180.00	106.2 PK			1.12 H	117	64.9	41.3
4	*5180.00	95.7 AV			1.12 H	117	54.4	41.3
5	#10360.00	61.9 PK	74.0	-12.1	2.40 H	187	41.9	20.0
6	#10360.00	48.8 AV	54.0	-5.2	2.40 H	187	28.8	20.0
ANTENNA POLARITY & TEST DISTANCE: VERTICAL AT 3 M								
NO.	FREQ. (MHz)	EMISSION LEVEL (dBuV/m)	LIMIT (dBuV/m)	MARGIN (dB)	ANTENNA HEIGHT (m)	TABLE ANGLE (Degree)	RAW VALUE (dBuV)	CORRECTION FACTOR (dB/m)
1	5150.00	66.6 PK	74.0	-7.4	1.00 V	123	59.2	7.4
2	5150.00	52.4 AV	54.0	-1.6	1.00 V	123	45.0	7.4
3	*5180.00	115.3 PK			1.02 V	51	74.0	41.3
4	*5180.00	104.9 AV			1.02 V	51	63.6	41.3
5	#10360.00	62.8 PK	74.0	-11.2	1.94 V	220	42.8	20.0
6	#10360.00	49.7 AV	54.0	-4.3	1.94 V	220	29.7	20.0

Remarks:

1. Emission Level(dBuV/m) = Raw Value(dBuV) + Correction Factor(dB/m)
2. Correction Factor(dB/m) = Antenna Factor(dB/m) + Cable Factor(dB) – Pre-Amplifier Factor(dB)
3. The other emission levels were very low against the limit.
4. Margin value = Emission Level – Limit value
5. " * ": Fundamental frequency.
6. " # ": The radiated frequency is out of the restricted band.

CHANNEL	TX Channel 40	DETECTOR	Peak (PK)
FREQUENCY RANGE	1GHz ~ 40GHz	FUNCTION	Average (AV)

ANTENNA POLARITY & TEST DISTANCE: HORIZONTAL AT 3 M

NO.	FREQ. (MHz)	EMISSION LEVEL (dBuV/m)	LIMIT (dBuV/m)	MARGIN (dB)	ANTENNA HEIGHT (m)	TABLE ANGLE (Degree)	RAW VALUE (dBuV)	CORRECTION FACTOR (dB/m)
1	*5200.00	109.0 PK			1.00 H	118	67.7	41.3
2	*5200.00	98.2 AV			1.00 H	118	56.9	41.3
3	#10400.00	62.3 PK	74.0	-11.7	1.66 H	290	42.1	20.2
4	#10400.00	48.9 AV	54.0	-5.1	1.66 H	290	28.7	20.2

ANTENNA POLARITY & TEST DISTANCE: VERTICAL AT 3 M

NO.	FREQ. (MHz)	EMISSION LEVEL (dBuV/m)	LIMIT (dBuV/m)	MARGIN (dB)	ANTENNA HEIGHT (m)	TABLE ANGLE (Degree)	RAW VALUE (dBuV)	CORRECTION FACTOR (dB/m)
1	*5200.00	118.0 PK			1.00 V	49	76.7	41.3
2	*5200.00	107.7 AV			1.00 V	49	66.4	41.3
3	#10400.00	62.6 PK	74.0	-11.4	2.20 V	175	42.4	20.2
4	#10400.00	49.5 AV	54.0	-4.5	2.20 V	175	29.3	20.2

Remarks:

1. Emission Level(dBuV/m) = Raw Value(dBuV) + Correction Factor(dB/m)
2. Correction Factor(dB/m) = Antenna Factor(dB/m) + Cable Factor(dB) – Pre-Amplifier Factor(dB)
3. The other emission levels were very low against the limit.
4. Margin value = Emission Level – Limit value
5. " * ": Fundamental frequency.
6. " # ": The radiated frequency is out of the restricted band.

CHANNEL	TX Channel 48	DETECTOR FUNCTION	Peak (PK)
FREQUENCY RANGE	1GHz ~ 40GHz		Average (AV)

ANTENNA POLARITY & TEST DISTANCE: HORIZONTAL AT 3 M

NO.	FREQ. (MHz)	EMISSION LEVEL (dBuV/m)	LIMIT (dBuV/m)	MARGIN (dB)	ANTENNA HEIGHT (m)	TABLE ANGLE (Degree)	RAW VALUE (dBuV)	CORRECTION FACTOR (dB/m)
1	*5240.00	109.5 PK			1.08 H	113	68.0	41.5
2	*5240.00	99.0 AV			1.08 H	113	57.5	41.5
3	5350.00	59.9 PK	74.0	-14.1	1.12 H	115	51.9	8.0
4	5350.00	47.1 AV	54.0	-6.9	1.12 H	115	39.1	8.0
5	#10480.00	62.2 PK	74.0	-11.8	2.26 H	175	41.9	20.3
6	#10480.00	49.5 AV	54.0	-4.5	2.26 H	175	29.2	20.3

ANTENNA POLARITY & TEST DISTANCE: VERTICAL AT 3 M

NO.	FREQ. (MHz)	EMISSION LEVEL (dBuV/m)	LIMIT (dBuV/m)	MARGIN (dB)	ANTENNA HEIGHT (m)	TABLE ANGLE (Degree)	RAW VALUE (dBuV)	CORRECTION FACTOR (dB/m)
1	*5240.00	118.1 PK			1.00 V	81	76.6	41.5
2	*5240.00	107.3 AV			1.00 V	81	65.8	41.5
3	5350.00	61.3 PK	74.0	-12.7	1.20 V	89	53.3	8.0
4	5350.00	48.4 AV	54.0	-5.6	1.20 V	89	40.4	8.0
5	#10480.00	63.3 PK	74.0	-10.7	1.88 V	250	43.0	20.3
6	#10480.00	50.2 AV	54.0	-3.8	1.88 V	250	29.9	20.3

Remarks:

1. Emission Level(dBuV/m) = Raw Value(dBuV) + Correction Factor(dB/m)
2. Correction Factor(dB/m) = Antenna Factor(dB/m) + Cable Factor(dB) – Pre-Amplifier Factor(dB)
3. The other emission levels were very low against the limit.
4. Margin value = Emission Level – Limit value
5. " * ": Fundamental frequency.
6. " # ": The radiated frequency is out of the restricted band.

CHANNEL	TX Channel 149	DETECTOR FUNCTION	Peak (PK)
FREQUENCY RANGE	1GHz ~ 40GHz		Average (AV)

ANTENNA POLARITY & TEST DISTANCE: HORIZONTAL AT 3 M

NO.	FREQ. (MHz)	EMISSION LEVEL (dBuV/m)	LIMIT (dBuV/m)	MARGIN (dB)	ANTENNA HEIGHT (m)	TABLE ANGLE (Degree)	RAW VALUE (dBuV)	CORRECTION FACTOR (dB/m)
1	#5603.20	60.7 PK	68.2	-7.5	1.08 H	326	52.2	8.5
2	*5745.00	110.3 PK			1.08 H	326	67.6	42.7
3	*5745.00	100.1 AV			1.08 H	326	57.4	42.7
4	#5988.80	61.3 PK	68.2	-6.9	1.08 H	326	51.6	9.7
5	11490.00	63.7 PK	74.0	-10.3	2.25 H	178	41.9	21.8
6	11490.00	50.9 AV	54.0	-3.1	2.25 H	178	29.1	21.8

ANTENNA POLARITY & TEST DISTANCE: VERTICAL AT 3 M

NO.	FREQ. (MHz)	EMISSION LEVEL (dBuV/m)	LIMIT (dBuV/m)	MARGIN (dB)	ANTENNA HEIGHT (m)	TABLE ANGLE (Degree)	RAW VALUE (dBuV)	CORRECTION FACTOR (dB/m)
1	#5602.40	62.2 PK	68.2	-6.0	2.24 V	170	53.7	8.5
2	*5745.00	118.2 PK			2.24 V	170	75.5	42.7
3	*5745.00	107.4 AV			2.24 V	170	64.7	42.7
4	#5986.40	61.9 PK	68.2	-6.3	2.24 V	170	52.3	9.6
5	11490.00	64.6 PK	74.0	-9.4	2.26 V	315	42.8	21.8
6	11490.00	51.6 AV	54.0	-2.4	2.26 V	315	29.8	21.8

Remarks:

1. Emission Level(dBuV/m) = Raw Value(dBuV) + Correction Factor(dB/m)
2. Correction Factor(dB/m) = Antenna Factor(dB/m) + Cable Factor(dB) – Pre-Amplifier Factor(dB)
3. The other emission levels were very low against the limit.
4. Margin value = Emission Level – Limit value
5. " * ": Fundamental frequency.
6. " # ": The radiated frequency is out of the restricted band.

CHANNEL	TX Channel 157	DETECTOR FUNCTION	Peak (PK)
FREQUENCY RANGE	1GHz ~ 40GHz		Average (AV)

ANTENNA POLARITY & TEST DISTANCE: HORIZONTAL AT 3 M

NO.	FREQ. (MHz)	EMISSION LEVEL (dBuV/m)	LIMIT (dBuV/m)	MARGIN (dB)	ANTENNA HEIGHT (m)	TABLE ANGLE (Degree)	RAW VALUE (dBuV)	CORRECTION FACTOR (dB/m)
1	#5616.00	61.2 PK	68.2	-7.0	1.11 H	318	52.7	8.5
2	*5785.00	111.8 PK			1.11 H	318	69.1	42.7
3	*5785.00	101.1 AV			1.11 H	318	58.4	42.7
4	#5973.60	62.3 PK	68.2	-5.9	1.11 H	318	52.7	9.6
5	11570.00	64.1 PK	74.0	-9.9	2.26 H	194	42.3	21.8
6	11570.00	51.1 AV	54.0	-2.9	2.26 H	194	29.3	21.8

ANTENNA POLARITY & TEST DISTANCE: VERTICAL AT 3 M

NO.	FREQ. (MHz)	EMISSION LEVEL (dBuV/m)	LIMIT (dBuV/m)	MARGIN (dB)	ANTENNA HEIGHT (m)	TABLE ANGLE (Degree)	RAW VALUE (dBuV)	CORRECTION FACTOR (dB/m)
1	#5632.00	62.5 PK	68.2	-5.7	2.35 V	197	54.0	8.5
2	*5785.00	117.1 PK			2.35 V	197	74.4	42.7
3	*5785.00	106.5 AV			2.35 V	197	63.8	42.7
4	#5992.00	61.9 PK	68.2	-6.3	2.35 V	197	52.2	9.7
5	11570.00	65.0 PK	74.0	-9.0	2.69 V	305	43.2	21.8
6	11570.00	51.6 AV	54.0	-2.4	2.69 V	305	29.8	21.8

Remarks:

1. Emission Level(dBuV/m) = Raw Value(dBuV) + Correction Factor(dB/m)
2. Correction Factor(dB/m) = Antenna Factor(dB/m) + Cable Factor(dB) – Pre-Amplifier Factor(dB)
3. The other emission levels were very low against the limit.
4. Margin value = Emission Level – Limit value
5. " * ": Fundamental frequency.
6. " # ": The radiated frequency is out of the restricted band.

CHANNEL	TX Channel 165	DETECTOR FUNCTION	Peak (PK)
FREQUENCY RANGE	1GHz ~ 40GHz		Average (AV)

ANTENNA POLARITY & TEST DISTANCE: HORIZONTAL AT 3 M

NO.	FREQ. (MHz)	EMISSION LEVEL (dBuV/m)	LIMIT (dBuV/m)	MARGIN (dB)	ANTENNA HEIGHT (m)	TABLE ANGLE (Degree)	RAW VALUE (dBuV)	CORRECTION FACTOR (dB/m)
1	#5634.40	61.5 PK	68.2	-6.7	1.37 H	320	53.0	8.5
2	*5825.00	111.9 PK			1.37 H	320	69.0	42.9
3	*5825.00	101.4 AV			1.37 H	320	58.5	42.9
4	#5963.20	62.0 PK	68.2	-6.2	1.37 H	320	52.4	9.6
5	11650.00	63.6 PK	74.0	-10.4	2.45 H	229	42.2	21.4
6	11650.00	50.5 AV	54.0	-3.5	2.45 H	229	29.1	21.4

ANTENNA POLARITY & TEST DISTANCE: VERTICAL AT 3 M

NO.	FREQ. (MHz)	EMISSION LEVEL (dBuV/m)	LIMIT (dBuV/m)	MARGIN (dB)	ANTENNA HEIGHT (m)	TABLE ANGLE (Degree)	RAW VALUE (dBuV)	CORRECTION FACTOR (dB/m)
1	#5630.40	62.1 PK	68.2	-6.1	2.34 V	195	53.6	8.5
2	*5825.00	116.6 PK			2.34 V	195	73.7	42.9
3	*5825.00	106.2 AV			2.34 V	195	63.3	42.9
4	#5949.60	62.0 PK	68.2	-6.2	2.34 V	195	52.6	9.4
5	11650.00	64.6 PK	74.0	-9.4	2.80 V	114	43.2	21.4
6	11650.00	50.9 AV	54.0	-3.1	2.80 V	114	29.5	21.4

Remarks:

1. Emission Level(dBuV/m) = Raw Value(dBuV) + Correction Factor(dB/m)
2. Correction Factor(dB/m) = Antenna Factor(dB/m) + Cable Factor(dB) – Pre-Amplifier Factor(dB)
3. The other emission levels were very low against the limit.
4. Margin value = Emission Level – Limit value
5. " * ": Fundamental frequency.
6. " # ": The radiated frequency is out of the restricted band.

802.11n (HT40)

CHANNEL	TX Channel 38	DETECTOR	Peak (PK)
FREQUENCY RANGE	1GHz ~ 40GHz	FUNCTION	Average (AV)

ANTENNA POLARITY & TEST DISTANCE: HORIZONTAL AT 3 M

NO.	FREQ. (MHz)	EMISSION LEVEL (dBuV/m)	LIMIT (dBuV/m)	MARGIN (dB)	ANTENNA HEIGHT (m)	TABLE ANGLE (Degree)	RAW VALUE (dBuV)	CORRECTION FACTOR (dB/m)
1	5150.00	59.5 PK	74.0	-14.5	1.16 H	142	52.1	7.4
2	5150.00	46.7 AV	54.0	-7.3	1.16 H	142	39.3	7.4
3	*5190.00	98.0 PK			1.08 H	119	56.7	41.3
4	*5190.00	87.9 AV			1.08 H	119	46.6	41.3
5	#10380.00	61.9 PK	74.0	-12.1	1.38 H	201	41.9	20.0
6	#10380.00	48.9 AV	54.0	-5.1	1.38 H	201	28.9	20.0

ANTENNA POLARITY & TEST DISTANCE: VERTICAL AT 3 M

NO.	FREQ. (MHz)	EMISSION LEVEL (dBuV/m)	LIMIT (dBuV/m)	MARGIN (dB)	ANTENNA HEIGHT (m)	TABLE ANGLE (Degree)	RAW VALUE (dBuV)	CORRECTION FACTOR (dB/m)
1	5150.00	66.1 PK	74.0	-7.9	1.00 V	125	58.7	7.4
2	5150.00	52.3 AV	54.0	-1.7	1.00 V	125	44.9	7.4
3	*5190.00	107.1 PK			1.00 V	123	65.8	41.3
4	*5190.00	96.9 AV			1.00 V	123	55.6	41.3
5	#10380.00	62.9 PK	74.0	-11.1	2.24 V	188	42.9	20.0
6	#10380.00	49.6 AV	54.0	-4.4	2.24 V	188	29.6	20.0

Remarks:

1. Emission Level(dBuV/m) = Raw Value(dBuV) + Correction Factor(dB/m)
2. Correction Factor(dB/m) = Antenna Factor(dB/m) + Cable Factor(dB) – Pre-Amplifier Factor(dB)
3. The other emission levels were very low against the limit.
4. Margin value = Emission Level – Limit value
5. " * ": Fundamental frequency.
6. " # ": The radiated frequency is out of the restricted band.

CHANNEL	TX Channel 46	DETECTOR FUNCTION	Peak (PK)
FREQUENCY RANGE	1GHz ~ 40GHz		Average (AV)

ANTENNA POLARITY & TEST DISTANCE: HORIZONTAL AT 3 M								
NO.	FREQ. (MHz)	EMISSION LEVEL (dBuV/m)	LIMIT (dBuV/m)	MARGIN (dB)	ANTENNA HEIGHT (m)	TABLE ANGLE (Degree)	RAW VALUE (dBuV)	CORRECTION FACTOR (dB/m)
1	5150.00	60.7 PK	74.0	-13.3	1.08 H	133	53.3	7.4
2	5150.00	47.7 AV	54.0	-6.3	1.08 H	133	40.3	7.4
3	*5230.00	105.9 PK			1.02 H	120	64.5	41.4
4	*5230.00	95.6 AV			1.02 H	120	54.2	41.4
5	5350.00	59.7 PK	74.0	-14.3	1.34 H	115	51.7	8.0
6	5350.00	46.6 AV	54.0	-7.4	1.34 H	115	38.6	8.0
7	#10460.00	61.9 PK	74.0	-12.1	2.36 H	190	41.7	20.2
8	#10460.00	48.9 AV	54.0	-5.1	2.36 H	190	28.7	20.2

ANTENNA POLARITY & TEST DISTANCE: VERTICAL AT 3 M								
NO.	FREQ. (MHz)	EMISSION LEVEL (dBuV/m)	LIMIT (dBuV/m)	MARGIN (dB)	ANTENNA HEIGHT (m)	TABLE ANGLE (Degree)	RAW VALUE (dBuV)	CORRECTION FACTOR (dB/m)
1	5150.00	65.9 PK	74.0	-8.1	1.11 V	93	58.5	7.4
2	5150.00	52.9 AV	54.0	-1.1	1.11 V	93	45.5	7.4
3	*5230.00	114.8 PK			1.00 V	51	73.4	41.4
4	*5230.00	104.4 AV			1.00 V	51	63.0	41.4
5	5350.00	62.2 PK	74.0	-11.8	1.10 V	43	54.2	8.0
6	5350.00	48.6 AV	54.0	-5.4	1.10 V	43	40.6	8.0
7	#10460.00	62.8 PK	74.0	-11.2	2.29 V	191	42.6	20.2
8	#10460.00	50.0 AV	54.0	-4.0	2.29 V	191	29.8	20.2

Remarks:

1. Emission Level(dBuV/m) = Raw Value(dBuV) + Correction Factor(dB/m)
2. Correction Factor(dB/m) = Antenna Factor(dB/m) + Cable Factor(dB) – Pre-Amplifier Factor(dB)
3. The other emission levels were very low against the limit.
4. Margin value = Emission Level – Limit value
5. " * ": Fundamental frequency.
6. " # ": The radiated frequency is out of the restricted band.

CHANNEL	TX Channel 151	DETECTOR FUNCTION	Peak (PK)
FREQUENCY RANGE	1GHz ~ 40GHz		Average (AV)

ANTENNA POLARITY & TEST DISTANCE: HORIZONTAL AT 3 M

NO.	FREQ. (MHz)	EMISSION LEVEL (dBuV/m)	LIMIT (dBuV/m)	MARGIN (dB)	ANTENNA HEIGHT (m)	TABLE ANGLE (Degree)	RAW VALUE (dBuV)	CORRECTION FACTOR (dB/m)
1	#5614.40	60.6 PK	68.2	-7.6	1.38 H	321	52.1	8.5
2	*5755.00	107.6 PK			1.38 H	321	64.9	42.7
3	*5755.00	97.4 AV			1.38 H	321	54.7	42.7
4	#5928.00	61.8 PK	68.2	-6.4	1.38 H	321	52.4	9.4
5	11510.00	63.8 PK	74.0	-10.2	2.98 H	115	42.1	21.7
6	11510.00	51.5 AV	54.0	-2.5	2.98 H	115	29.8	21.7

ANTENNA POLARITY & TEST DISTANCE: VERTICAL AT 3 M

NO.	FREQ. (MHz)	EMISSION LEVEL (dBuV/m)	LIMIT (dBuV/m)	MARGIN (dB)	ANTENNA HEIGHT (m)	TABLE ANGLE (Degree)	RAW VALUE (dBuV)	CORRECTION FACTOR (dB/m)
1	#5649.60	62.2 PK	68.2	-6.0	2.50 V	193	53.6	8.6
2	*5755.00	113.7 PK			2.50 V	193	71.0	42.7
3	*5755.00	103.5 AV			2.50 V	193	60.8	42.7
4	#5936.00	61.7 PK	68.2	-6.5	2.50 V	193	52.3	9.4
5	11510.00	64.9 PK	74.0	-9.1	2.63 V	322	43.2	21.7
6	11510.00	51.6 AV	54.0	-2.4	2.63 V	322	29.9	21.7

Remarks:

1. Emission Level(dBuV/m) = Raw Value(dBuV) + Correction Factor(dB/m)
2. Correction Factor(dB/m) = Antenna Factor(dB/m) + Cable Factor(dB) – Pre-Amplifier Factor(dB)
3. The other emission levels were very low against the limit.
4. Margin value = Emission Level – Limit value
5. " * ": Fundamental frequency.
6. " # ": The radiated frequency is out of the restricted band.

CHANNEL	TX Channel 159	DETECTOR FUNCTION	Peak (PK)
FREQUENCY RANGE	1GHz ~ 40GHz		Average (AV)

ANTENNA POLARITY & TEST DISTANCE: HORIZONTAL AT 3 M

NO.	FREQ. (MHz)	EMISSION LEVEL (dBuV/m)	LIMIT (dBuV/m)	MARGIN (dB)	ANTENNA HEIGHT (m)	TABLE ANGLE (Degree)	RAW VALUE (dBuV)	CORRECTION FACTOR (dB/m)
1	#5648.80	60.6 PK	68.2	-7.6	1.34 H	320	52.0	8.6
2	*5795.00	108.0 PK			1.34 H	320	65.3	42.7
3	*5795.00	97.8 AV			1.34 H	320	55.1	42.7
4	#5984.80	61.8 PK	68.2	-6.4	1.34 H	320	52.2	9.6
5	11590.00	63.3 PK	74.0	-10.7	1.53 H	330	41.6	21.7
6	11590.00	50.8 AV	54.0	-3.2	1.53 H	330	29.1	21.7

ANTENNA POLARITY & TEST DISTANCE: VERTICAL AT 3 M

NO.	FREQ. (MHz)	EMISSION LEVEL (dBuV/m)	LIMIT (dBuV/m)	MARGIN (dB)	ANTENNA HEIGHT (m)	TABLE ANGLE (Degree)	RAW VALUE (dBuV)	CORRECTION FACTOR (dB/m)
1	#5639.20	62.0 PK	68.2	-6.2	2.56 V	195	53.5	8.5
2	*5795.00	113.3 PK			2.56 V	195	70.6	42.7
3	*5795.00	103.1 AV			2.56 V	195	60.4	42.7
4	#5997.60	61.8 PK	68.2	-6.4	2.56 V	195	52.1	9.7
5	11590.00	64.9 PK	74.0	-9.1	1.93 V	225	43.2	21.7
6	11590.00	51.5 AV	54.0	-2.5	1.93 V	225	29.8	21.7

Remarks:

1. Emission Level(dBuV/m) = Raw Value(dBuV) + Correction Factor(dB/m)
2. Correction Factor(dB/m) = Antenna Factor(dB/m) + Cable Factor(dB) – Pre-Amplifier Factor(dB)
3. The other emission levels were very low against the limit.
4. Margin value = Emission Level – Limit value
5. " * ": Fundamental frequency.
6. " # ": The radiated frequency is out of the restricted band.

802.11ac (VHT80)

CHANNEL	TX Channel 42	DETECTOR FUNCTION	Peak (PK)
FREQUENCY RANGE	1GHz ~ 40GHz		Average (AV)

ANTENNA POLARITY & TEST DISTANCE: HORIZONTAL AT 3 M

NO.	FREQ. (MHz)	EMISSION LEVEL (dBuV/m)	LIMIT (dBuV/m)	MARGIN (dB)	ANTENNA HEIGHT (m)	TABLE ANGLE (Degree)	RAW VALUE (dBuV)	CORRECTION FACTOR (dB/m)
1	5150.00	60.3 PK	74.0	-13.7	1.26 H	118	52.9	7.4
2	5150.00	46.3 AV	54.0	-7.7	1.26 H	118	38.9	7.4
3	*5210.00	94.0 PK			1.11 H	120	52.6	41.4
4	*5210.00	83.8 AV			1.11 H	120	42.4	41.4
5	5350.00	59.1 PK	74.0	-14.9	1.03 H	115	51.1	8.0
6	5350.00	46.1 AV	54.0	-7.9	1.03 H	115	38.1	8.0
7	#10420.00	61.6 PK	74.0	-12.4	1.88 H	172	41.6	20.0
8	#10420.00	48.9 AV	54.0	-5.1	1.88 H	172	28.9	20.0

ANTENNA POLARITY & TEST DISTANCE: VERTICAL AT 3 M

NO.	FREQ. (MHz)	EMISSION LEVEL (dBuV/m)	LIMIT (dBuV/m)	MARGIN (dB)	ANTENNA HEIGHT (m)	TABLE ANGLE (Degree)	RAW VALUE (dBuV)	CORRECTION FACTOR (dB/m)
1	5150.00	66.7 PK	74.0	-7.3	1.00 V	123	59.3	7.4
2	5150.00	52.5 AV	54.0	-1.5	1.00 V	123	45.1	7.4
3	*5210.00	102.3 PK			1.00 V	52	60.9	41.4
4	*5210.00	92.1 AV			1.00 V	52	50.7	41.4
5	5350.00	59.8 PK	74.0	-14.2	1.20 V	141	51.8	8.0
6	5350.00	46.6 AV	54.0	-7.4	1.20 V	141	38.6	8.0
7	#10420.00	62.3 PK	74.0	-11.7	2.66 V	199	42.3	20.0
8	#10420.00	49.5 AV	54.0	-4.5	2.66 V	199	29.5	20.0

Remarks:

1. Emission Level(dBuV/m) = Raw Value(dBuV) + Correction Factor(dB/m)
2. Correction Factor(dB/m) = Antenna Factor(dB/m) + Cable Factor(dB) – Pre-Amplifier Factor(dB)
3. The other emission levels were very low against the limit.
4. Margin value = Emission Level – Limit value
5. " * ": Fundamental frequency.
6. " # ": The radiated frequency is out of the restricted band.

CHANNEL	TX Channel 155	DETECTOR FUNCTION	Peak (PK)
FREQUENCY RANGE	1GHz ~ 40GHz		Average (AV)

ANTENNA POLARITY & TEST DISTANCE: HORIZONTAL AT 3 M

NO.	FREQ. (MHz)	EMISSION LEVEL (dBuV/m)	LIMIT (dBuV/m)	MARGIN (dB)	ANTENNA HEIGHT (m)	TABLE ANGLE (Degree)	RAW VALUE (dBuV)	CORRECTION FACTOR (dB/m)
1	#5609.60	57.9 PK	68.2	-10.3	1.22 H	318	49.4	8.5
2	*5775.00	104.2 PK			1.22 H	318	61.5	42.7
3	*5775.00	94.2 AV			1.22 H	318	51.5	42.7
4	#5938.40	58.5 PK	68.2	-9.7	1.22 H	318	49.1	9.4
5	11550.00	63.2 PK	74.0	-10.8	2.25 H	187	41.4	21.8
6	11550.00	50.6 AV	54.0	-3.4	2.25 H	187	28.8	21.8

ANTENNA POLARITY & TEST DISTANCE: VERTICAL AT 3 M

NO.	FREQ. (MHz)	EMISSION LEVEL (dBuV/m)	LIMIT (dBuV/m)	MARGIN (dB)	ANTENNA HEIGHT (m)	TABLE ANGLE (Degree)	RAW VALUE (dBuV)	CORRECTION FACTOR (dB/m)
1	#5646.40	62.0 PK	68.2	-6.2	2.31 V	171	53.4	8.6
2	*5775.00	110.9 PK			2.31 V	171	68.2	42.7
3	*5775.00	100.6 AV			2.31 V	171	57.9	42.7
4	#5933.60	59.8 PK	68.2	-8.4	2.31 V	171	50.4	9.4
5	11550.00	65.2 PK	74.0	-8.8	2.69 V	117	43.4	21.8
6	11550.00	51.5 AV	54.0	-2.5	2.69 V	117	29.7	21.8

Remarks:

1. Emission Level(dBuV/m) = Raw Value(dBuV) + Correction Factor(dB/m)
2. Correction Factor(dB/m) = Antenna Factor(dB/m) + Cable Factor(dB) – Pre-Amplifier Factor(dB)
3. The other emission levels were very low against the limit.
4. Margin value = Emission Level – Limit value
5. " * ": Fundamental frequency.
6. " # ": The radiated frequency is out of the restricted band.

Below 1GHz Worst-Case Data: 802.11a

CHANNEL	TX Channel 36	DETECTOR FUNCTION	Quasi-Peak (QP)
FREQUENCY RANGE	9kHz ~ 1GHz		

ANTENNA POLARITY & TEST DISTANCE: HORIZONTAL AT 3 M

NO.	FREQ. (MHz)	EMISSION LEVEL (dBuV/m)	LIMIT (dBuV/m)	MARGIN (dB)	ANTENNA HEIGHT (m)	TABLE ANGLE (Degree)	RAW VALUE (dBuV)	CORRECTION FACTOR (dB/m)
1	190.95	28.7 QP	43.5	-14.8	1.50 H	257	44.6	-15.9
2	326.78	41.5 QP	46.0	-4.5	1.00 H	78	52.9	-11.4
3	625.60	33.8 QP	46.0	-12.2	1.00 H	183	39.1	-5.3
4	749.79	38.7 QP	46.0	-7.3	1.00 H	160	41.5	-2.8
5	893.38	41.3 QP	46.0	-4.7	2.00 H	236	42.1	-0.8
6	934.13	40.0 QP	46.0	-6.0	2.00 H	61	39.8	0.2

ANTENNA POLARITY & TEST DISTANCE: VERTICAL AT 3 M

NO.	FREQ. (MHz)	EMISSION LEVEL (dBuV/m)	LIMIT (dBuV/m)	MARGIN (dB)	ANTENNA HEIGHT (m)	TABLE ANGLE (Degree)	RAW VALUE (dBuV)	CORRECTION FACTOR (dB/m)
1	45.42	28.1 QP	40.0	-11.9	1.51 V	7	42.8	-14.7
2	289.91	33.7 QP	46.0	-12.3	1.01 V	262	46.0	-12.3
3	324.84	37.7 QP	46.0	-8.3	1.51 V	117	49.1	-11.4
4	625.60	29.2 QP	46.0	-16.8	1.51 V	128	34.5	-5.3
5	749.79	32.2 QP	46.0	-13.8	1.01 V	184	35.0	-2.8
6	934.13	39.7 QP	46.0	-6.3	2.00 V	241	39.5	0.2

Remarks:

1. Emission Level(dBuV/m) = Raw Value(dBuV) + Correction Factor(dB/m)
2. Correction Factor(dB/m) = Antenna Factor(dB/m) + Cable Factor(dB) – Pre-Amplifier Factor(dB)
3. The other emission levels were very low against the limit.
4. Margin value = Emission Level – Limit value

4.2 Conducted Emission Measurement

4.2.1 Limits of Conducted Emission Measurement

Frequency (MHz)	Conducted Limit (dBuV)	
	Quasi-peak	Average
0.15 - 0.5	66 - 56	56 - 46
0.50 - 5.0	56	46
5.0 - 30.0	60	50

Note: 1. The lower limit shall apply at the transition frequencies.

2. The limit decreases in line with the logarithm of the frequency in the range of 0.15 to 0.50MHz.

4.2.2 Test Instruments

Description & Manufacturer	Model No.	Serial No.	Cal. Date	Cal. Due
Test Receiver ROHDE & SCHWARZ	ESCI	100613	Nov. 23, 2016	Nov. 22, 2017
			Nov. 23, 2017	Nov. 22, 2018
RF signal cable (with 10dB PAD) Woken	5D-FB	Cable-cond1-01	Sep. 05, 2017	Sep. 04, 2018
LISN ROHDE & SCHWARZ (EUT)	ESH3-Z5	835239/001	Mar. 10, 2017	Mar. 09, 2018
LISN ROHDE & SCHWARZ (Peripheral)	ESH3-Z5	100311	Aug. 15, 2017	Aug. 14, 2018
Software ADT	BV ADT_Cond_ V7.3.7.3	NA	NA	NA

Note: 1. The calibration interval of the above test instruments is 12 months and the calibrations are traceable to NML/ROC and NIST/USA.

2. The test was performed in HwaYa Shielded Room 1.

3. The VCCI Site Registration No. is C-2040.

4.2.3 Test Procedures

- The EUT was placed 0.4 meters from the conducting wall of the shielded room with EUT being connected to the power mains through a line impedance stabilization network (LISN). Other support units were connected to the power mains through another LISN. The two LISNs provide 50 ohm/ 50uH of coupling impedance for the measuring instrument.
- Both lines of the power mains connected to the EUT were checked for maximum conducted interference.
- The frequency range from 150kHz to 30MHz was searched. Emission levels under (Limit - 20dB) was not recorded.

Note: The resolution bandwidth and video bandwidth of test receiver is 9kHz for quasi-peak detection (QP) and average detection (AV) at frequency 0.15MHz-30MHz.

4.2.4 Deviation from Test Standard

No deviation.

4.2.5 Test Setup

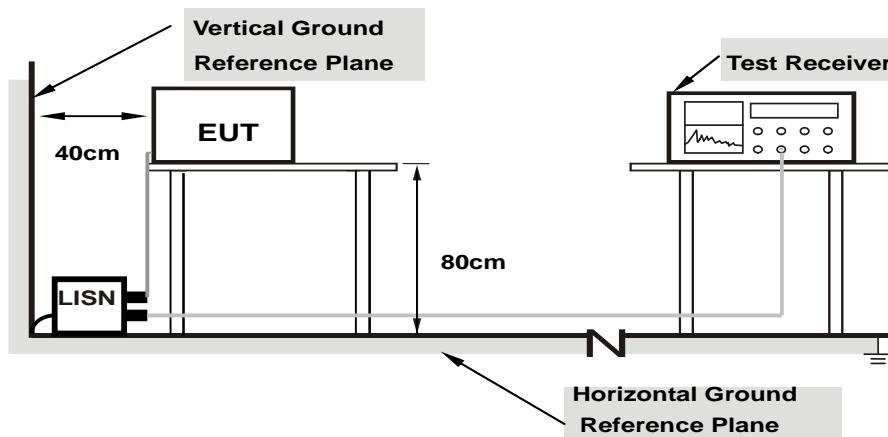

Note: 1.Support units were connected to second LISN.

For the actual test configuration, please refer to the attached file (Test Setup Photo).

4.2.6 EUT Operating Conditions

Same as 4.1.6.

4.2.7 Test Results

Worst-case data: 802.11a

Phase	Line (L)	Detector Function	Quasi-Peak (QP) / Average (AV)
-------	----------	-------------------	--------------------------------

No	Freq. [MHz]	Corr. Factor (dB)	Reading Value [dB (uV)]		Emission Level [dB (uV)]		Limit [dB (uV)]		Margin (dB)	
			Q.P.	AV.	Q.P.	AV.	Q.P.	AV.	Q.P.	AV.
			1	0.15391	10.45	35.49	14.54	45.94	24.99	65.79
2	0.16955	10.45	34.12	15.53	44.57	25.98	64.98	54.98	-20.41	-29.00
3	0.19665	10.45	29.06	9.63	39.51	20.08	63.75	53.75	-24.24	-33.67
4	0.30640	10.49	17.83	3.55	28.32	14.04	60.07	50.07	-31.75	-36.03
5	3.46959	10.61	5.76	-1.35	16.37	9.26	56.00	46.00	-39.63	-36.74
6	21.02940	11.46	7.87	0.39	19.33	11.85	60.00	50.00	-40.67	-38.15

Remarks:

1. Q.P. and AV. are abbreviations of quasi-peak and average individually.
2. The emission levels of other frequencies were very low against the limit.
3. Margin value = Emission level - Limit value
4. Correction factor = Insertion loss + Cable loss
5. Emission Level = Correction Factor + Reading Value.

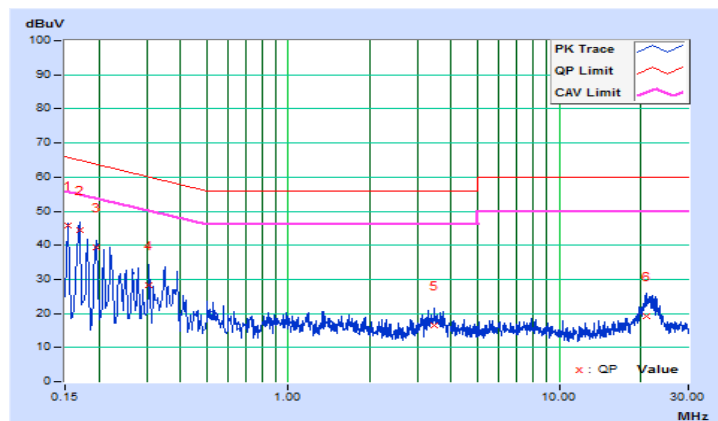

Phase	Neutral (N)	Detector Function	Quasi-Peak (QP) / Average (AV)
-------	-------------	-------------------	--------------------------------

No	Freq. [MHz]	Corr. Factor (dB)	Reading Value [dB (uV)]		Emission Level [dB (uV)]		Limit [dB (uV)]		Margin (dB)	
			Q.P.	AV.	Q.P.	AV.	Q.P.	AV.	Q.P.	AV.
			1	0.17346	10.21	32.27	14.66	42.48	24.87	64.79
2	0.20084	10.22	27.07	9.05	37.29	19.27	63.58	53.58	-26.29	-34.31
3	0.32204	10.23	17.86	5.37	28.09	15.60	59.65	49.65	-31.56	-34.05
4	0.36913	10.23	20.84	13.01	31.07	23.24	58.52	48.52	-27.45	-25.28
5	3.48132	10.38	3.59	-2.81	13.97	7.57	56.00	46.00	-42.03	-38.43
6	20.98639	11.08	10.93	3.46	22.01	14.54	60.00	50.00	-37.99	-35.46

Remarks:

1. Q.P. and AV. are abbreviations of quasi-peak and average individually.
2. The emission levels of other frequencies were very low against the limit.
3. Margin value = Emission level - Limit value
4. Correction factor = Insertion loss + Cable loss
5. Emission Level = Correction Factor + Reading Value.

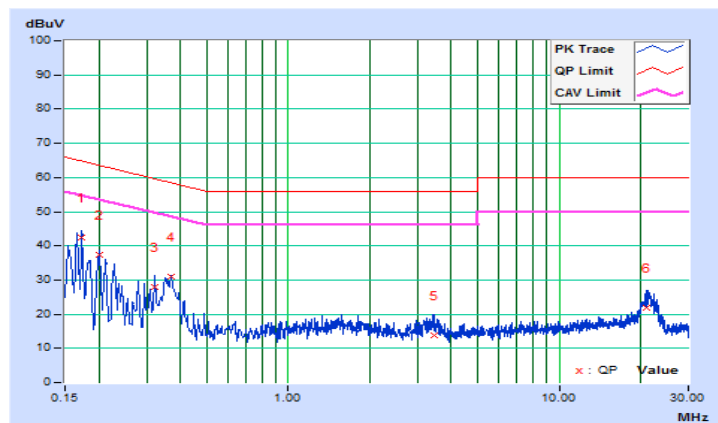

4.3 Transmit Power Measurement

4.3.1 Limits of Transmit Power Measurement

Operation Band	EUT Category		Limit
U-NII-1		Outdoor Access Point	1 Watt (30 dBm) (Max. e.i.r.p \leq 125mW(21 dBm) at any elevation angle above 30 degrees as measured from the horizon)
		Fixed point-to-point Access Point	1 Watt (30 dBm)
	√	Indoor Access Point	1 Watt (30 dBm)
		Mobile and Portable client device	250mW (24 dBm)
U-NII-2A			250mW (24 dBm) or 11 dBm+10 log B*
U-NII-2C			250mW (24 dBm) or 11 dBm+10 log B*
U-NII-3	√		1 Watt (30 dBm)

*B is the 26 dB emission bandwidth in megahertz

Per KDB 662911 Method of conducted output power measurement on IEEE 802.11 devices,

Array Gain = 0 dB (i.e., no array gain) for $N_{ANT} \leq 4$;

Array Gain = 0 dB (i.e., no array gain) for channel widths ≥ 40 MHz for any N_{ANT} ;

Array Gain = $5 \log(N_{ANT}/N_{SS})$ dB or 3 dB, whichever is less for 20-MHz channel widths with $N_{ANT} \geq 5$.

For power measurements on all other devices: Array Gain = $10 \log(N_{ANT}/N_{SS})$ dB.

4.3.2 Test Setup

For Power Output

802.11a, 802.11n (HT20), 802.11n (HT40)

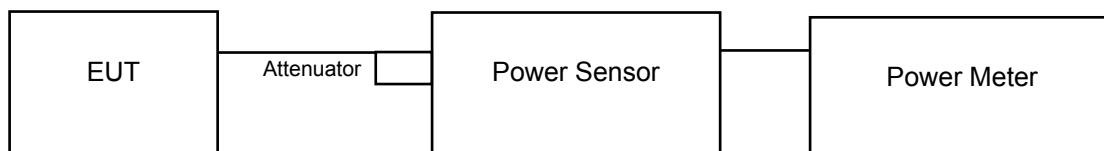

802.11ac (VHT80)

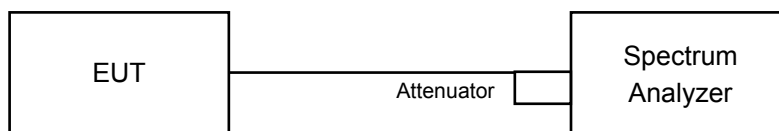

4.3.3 Test Instruments

Refer to section 4.1.2 to get information of above instrument.

4.3.4 Test Procedure

For Average Power Measurement

For 802.11a, 802.11n (HT20), 802.11n (HT40)

Method PM is used to perform output power measurement, trigger and gating function of wide band power meter is enabled to measure max output power of TX on burst. Duty factor is not added to measured value.

For 802.11ac (VHT80)

- a. Set span to encompass the entire 26 dB EBW (or, alternatively, the entire 99% occupied bandwidth) of the signal.
- b. Set sweep trigger to “free run”.
- c. Set RBW = 1 MHz.
- d. Set VBW \geq 3 MHz.
- e. Number of points in sweep \geq 2 Span / RBW.
- f. Sweep time \leq (number of points in sweep) * T
- g. Using emission bandwidth to determine the frequency span for integration the channel bandwidth.
- h. Detector = RMS.
- i. Trace mode = max hold.
- j. Allow max hold to run for at least 60 seconds, or longer as needed to allow the trace to stabilize.
- k. Compute power by integrating the spectrum across the EBW (or, alternatively, the entire 99% occupied bandwidth) of the signal using the instrument’s band power measurement function with band limits set equal to the EBW (or occupied bandwidth) band edges. If the instrument does not have a band power function, sum the spectrum levels (in power units) at 1 MHz intervals extending across the EBW (or, alternatively, the entire 99% occupied bandwidth) of the spectrum.

4.3.5 Deviation from Test Standard

No deviation.

4.3.6 EUT Operating Conditions

The software provided by client to enable the EUT under transmission condition continuously at lowest, middle and highest channel frequencies individually.

4.3.7 Test Result

Power Output:

802.11a

Chan.	Freq. (MHz)	Maximum Conducted Power (mW)	Maximum Conducted Power (dBm)	Power Limit (dBm)	Pass / Fail
36	5180	85.901	19.34	30.00	Pass
40	5200	142.889	21.55	30.00	Pass
48	5240	75.858	18.80	30.00	Pass
149	5745	121.899	20.86	30.00	Pass
157	5785	137.404	21.38	30.00	Pass
165	5825	170.608	22.32	30.00	Pass

802.11n (HT20)

Chan.	Freq. (MHz)	Maximum Conducted Power (dBm)		Total Power (mW)	Total Power (dBm)	Power Limit (dBm)	Pass / Fail
		Chain 0	Chain 1				
36	5180	18.03	17.62	121.343	20.84	30.00	Pass
40	5200	21.24	21.08	261.278	24.17	30.00	Pass
48	5240	18.78	18.22	141.883	21.52	30.00	Pass
149	5745	20.65	20.21	221.099	23.45	30.00	Pass
157	5785	20.65	20.39	225.541	23.53	30.00	Pass
165	5825	20.54	20.06	214.631	23.32	30.00	Pass

802.11n (HT40)

Chan.	Freq. (MHz)	Maximum Conducted Power (dBm)		Total Power (mW)	Total Power (dBm)	Power Limit (dBm)	Pass / Fail
		Chain 0	Chain 1				
38	5190	12.52	12.86	37.185	15.70	30.00	Pass
46	5230	18.81	18.46	146.179	21.65	30.00	Pass
151	5755	20.58	20.13	217.327	23.37	30.00	Pass
159	5795	20.51	20.06	213.851	23.30	30.00	Pass

802.11ac (VHT80)

Chan.	Freq. (MHz)	Maximum Conducted Power (dBm)		Total Power (mW)	Total Power (dBm)	Power Limit (dBm)	Pass / Fail
		Chain 0	Chain 1				
42	5210	11.85	11.67	30.000	14.77	30.00	Pass
155	5775	20.38	20.07	210.769	23.24	30.00	Pass

4.4 Occupied Bandwidth Measurement

4.4.1 Test Setup

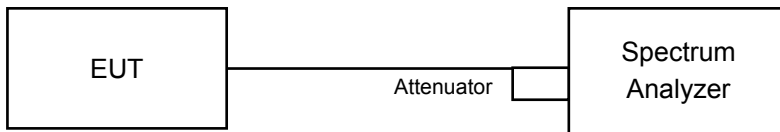

4.4.2 Test Instruments

Refer to section 4.1.2 to get information of above instrument.

4.4.3 Test Procedure

The transmitter output was connected to the spectrum analyzer through an attenuator. The bandwidth of the fundamental frequency was measured by spectrum analyzer with resolution bandwidth in the range of 1% to 5% of the anticipated emission bandwidth, and a video bandwidth at least 3x the resolution bandwidth and set the detector to sampling. The width of a frequency band such that, below the lower and above the upper frequency limits, the mean powers emitted are each equal to a specified percentage 0.5 %of the total mean power of a given emission.

4.4.4 Test Result

802.11a

Chan.	Freq. (MHz)	Occupied Bandwidth (MHz)
36	5180	18.84
40	5200	29.04
48	5240	18.48
149	5745	19.80
157	5785	20.04
165	5825	21.12

802.11n (HT20)

Chan.	Freq. (MHz)	Occupied Bandwidth (MHz)	
		Chain 0	Chain 1
36	5180	18.36	18.24
40	5200	29.64	29.40
48	5240	19.08	18.84
149	5745	21.36	20.52
157	5785	21.96	21.48
165	5825	20.16	18.96

802.11n (HT40)

Chan.	Freq. (MHz)	Occupied Bandwidth (MHz)	
		Chain 0	Chain 1
38	5190	36.96	36.96
46	5230	38.64	37.92
151	5755	37.92	37.56
159	5795	38.28	37.80

802.11ac (VHT80)

Chan.	Freq. (MHz)	Occupied Bandwidth (MHz)	
		Chain 0	Chain 1
42	5210	76.56	76.32
155	5775	77.04	77.28

Spectrum Plot of Worst Value

802.11a

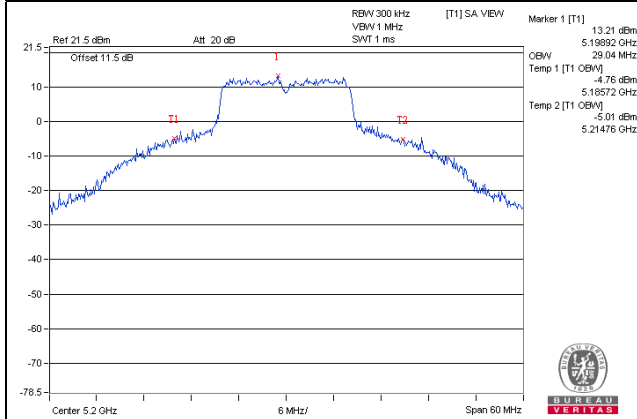

802.11n (HT20)

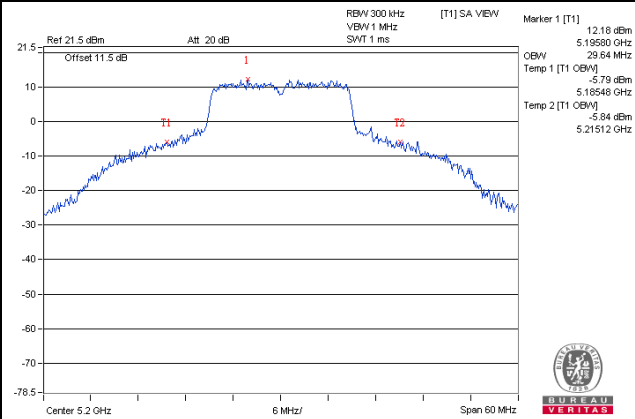

802.11n (HT40)

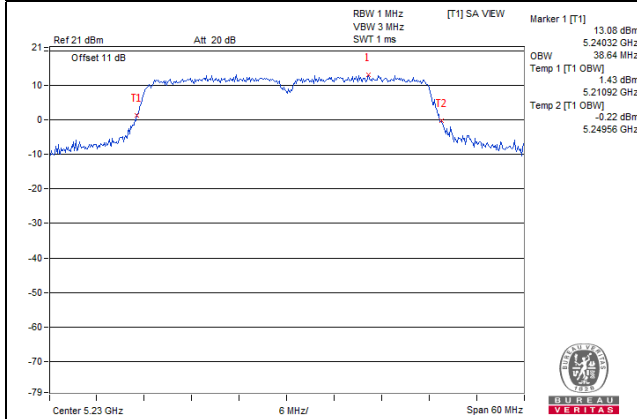

802.11ac (VHT80)

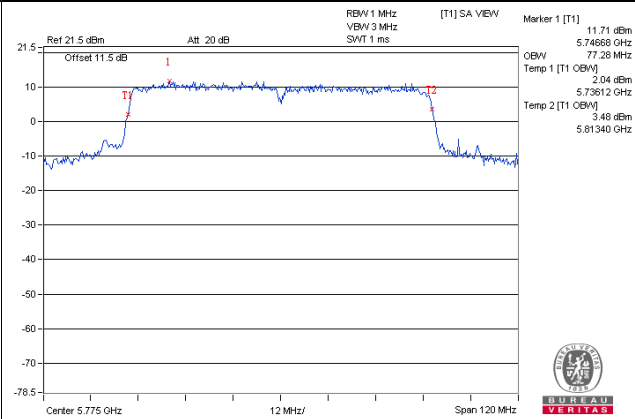

4.5 Peak Power Spectral Density Measurement

4.5.1 Limits of Peak Power Spectral Density Measurement

Operation Band	EUT Category		Limit
U-NII-1		Outdoor Access Point	17dBm/ MHz
		Fixed point-to-point Access Point	
	√	Indoor Access Point	
		Mobile and Portable client device	11dBm/ MHz
U-NII-2A			11dBm/ MHz
U-NII-2C			11dBm/ MHz
U-NII-3	√		30dBm/ 500kHz

4.5.2 Test Setup

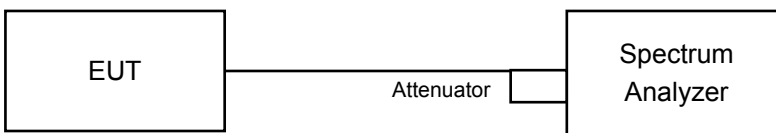

4.5.3 Test Instruments

Refer to section 4.1.2 to get information of above instrument.

4.5.4 Test Procedures

For U-NII-1 band:

Using method SA-2

- Set span to encompass the entire emission bandwidth (EBW) of the signal.
- Set RBW = 1MHz, Set VBW ≥ 3 MHz, Detector = RMS
- Set Channel power measure = 1MHz
- Sweep time = auto, trigger set to “free run”.
- Trace average at least 100 traces in power averaging mode.
- Record the max value and add 10 log (1/duty cycle)

For U-NII-3 band:

Duty cycle of test signal is < 98%

- Set span to encompass the entire emission bandwidth (EBW) of the signal.
- Set RBW = 300 kHz, Set VBW ≥ 1 MHz, Detector = RMS
- Use the peak marker function to determine the maximum power level in any 300 kHz band segment within the fundamental EBW.
- Scale the observed power level to an equivalent value in 500 kHz by adjusting (reducing) the measured power by a bandwidth correction factor (BWCF) where $BWCF = 10\log(500 \text{ kHz} / 300 \text{ kHz})$
- Sweep time = auto, trigger set to “free run”.
- Trace average at least 100 traces in power averaging mode.
- Record the max value and add 10 log (1/duty cycle)

4.5.5 Deviation from Test Standard

No deviation.

4.5.6 EUT Operating Conditions

Same as 4.3.6.

4.5.7 Test Results

For U-NII-1 band:

802.11a

Chan.	Freq. (MHz)	PSD w/o Duty Factor (dBm/MHz)	Duty Factor (dB)	PSD with Duty Factor (dBm/MHz)	Max. Limit (dBm/MHz)	Pass / Fail
36	5180	6.65	0.12	6.77	17.00	Pass
40	5200	8.39	0.12	8.51	17.00	Pass
48	5240	6.14	0.12	6.26	17.00	Pass

Note: Refer to section 3.3 for duty cycle spectrum plot.

802.11n (HT20)

Chan.	Freq. (MHz)	PSD w/o Duty Factor (dBm/MHz)		Duty Factor (dB)	Total PSD with Duty Factor (dBm/MHz)	Max. Limit (dBm/MHz)	Pass / Fail
		Chain 0	Chain 1				
36	5180	4.87	4.85	0.16	8.03	16.29	Pass
40	5200	7.75	7.95	0.16	11.02	16.29	Pass
48	5240	5.47	5.60	0.16	8.70	16.29	Pass

Note:

- Method 1 of power density measurement of KDB 662911 is using for calculating total power density. Total power density is summing entire spectra across corresponding frequency bins on the various outputs by computer.
- Directional gain = $3.7\text{dBi} + 10\log(2) = 6.71\text{dBi} > 6\text{dBi}$, so the power density limit shall be reduced to $17 - (6.71 - 6) = 16.29\text{dBm}$.
- Refer to section 3.3 for duty cycle spectrum plot.

802.11n (HT40)

Chan.	Freq. (MHz)	PSD w/o Duty Factor (dBm/MHz)		Duty Factor (dB)	Total PSD with Duty Factor (dBm/MHz)	Max. Limit (dBm/MHz)	Pass / Fail
		Chain 0	Chain 1				
38	5190	-3.15	-3.47	0.23	-0.06	16.29	Pass
46	5230	2.37	1.90	0.23	5.38	16.29	Pass

Note:

- Method 1 of power density measurement of KDB 662911 is using for calculating total power density. Total power density is summing entire spectra across corresponding frequency bins on the various outputs by computer.
- Directional gain = $3.7\text{dBi} + 10\log(2) = 6.71\text{dBi} > 6\text{dBi}$, so the power density limit shall be reduced to $17 - (6.71 - 6) = 16.29\text{dBm}$.
- Refer to section 3.3 for duty cycle spectrum plot.

802.11ac (VHT80)

Chan.	Freq. (MHz)	PSD w/o Duty Factor (dBm/MHz)		Duty Factor (dB)	Total PSD with Duty Factor (dBm/MHz)	Max. Limit (dBm/MHz)	Pass / Fail
		Chain 0	Chain 1				
42	5210	-8.45	-9.15	2.58	-3.20	16.29	Pass

Note:

1. Method 1 of power density measurement of KDB 662911 is using for calculating total power density. Total power density is summing entire spectra across corresponding frequency bins on the various outputs by computer.
2. Directional gain = $3.7\text{dBi} + 10\log(2) = 6.71\text{dBi} > 6\text{dBi}$, so the power density limit shall be reduced to $17 - (6.71 - 6) = 16.29\text{dBm}$.
3. Refer to section 3.3 for duty cycle spectrum plot.

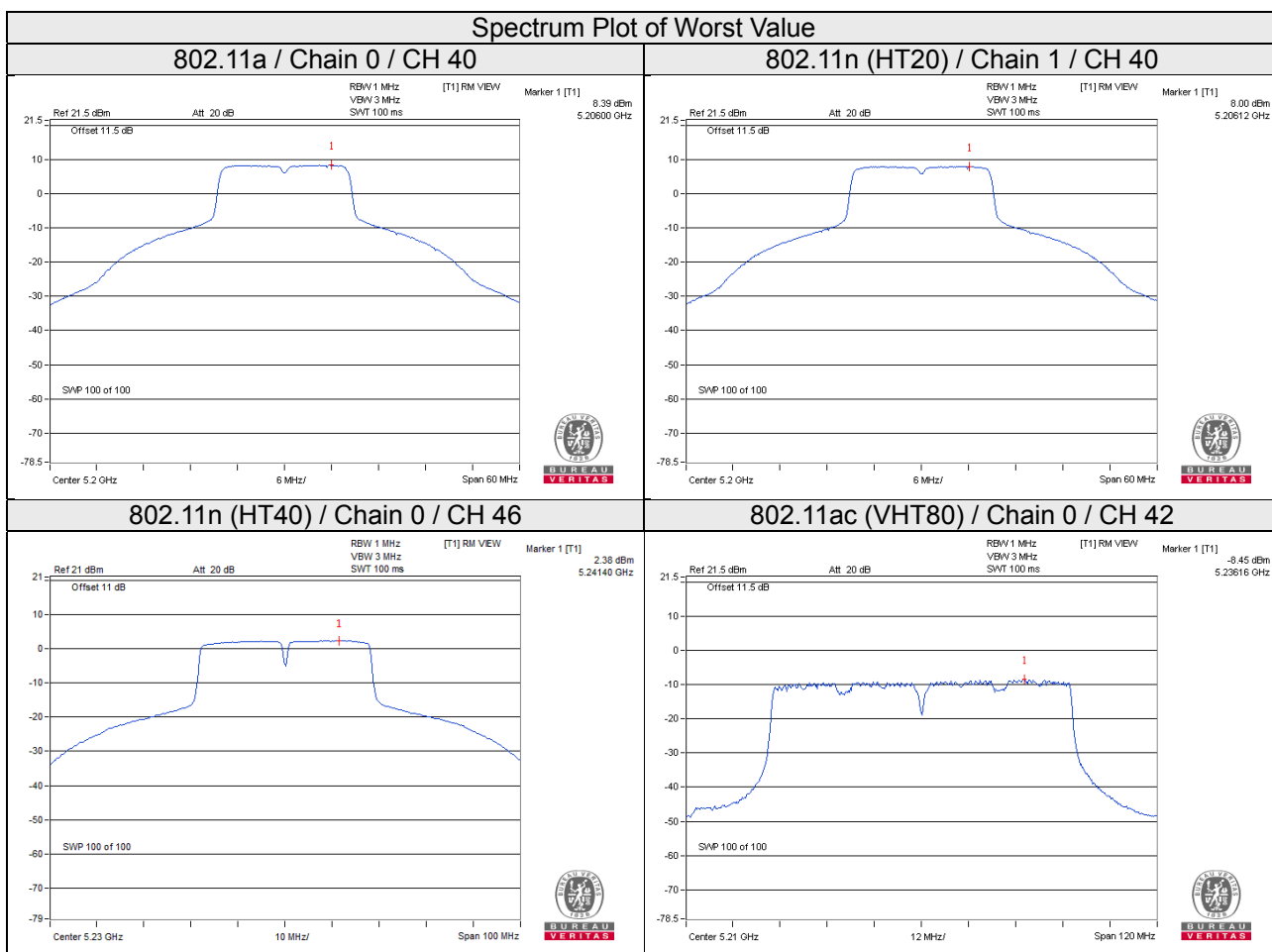

For U-NII-3 band:

802.11a

Chan.	Freq. (MHz)	PSD w/o Duty Factor		Duty Factor (dB)	Total PSD with Duty Factor (dBm/500kHz)	Limit (dBm/500kHz)	Pass / Fail
		(dBm/300kHz)	(dBm/500kHz)				
149	5745	-1.19	1.03	0.12	1.15	30.00	Pass
157	5785	-1.27	0.95	0.12	1.07	30.00	Pass
165	5825	-1.15	1.07	0.12	1.19	30.00	Pass

Note: Refer to section 3.3 for duty cycle spectrum plot.

802.11n (HT20)

TX chain	Chan.	Freq. (MHz)	PSD w/o Duty Factor		10 log (N=2) dB	Duty Factor (dB)	Total PSD with Duty Factor (dBm/500kHz)	Limit (dBm/500 kHz)	Pass / Fail
			(dBm/300kHz)	(dBm/500kHz)					
0	149	5745	-1.73	0.49	3.01	0.16	3.66	28.59	Pass
	157	5785	-1.61	0.61	3.01	0.16	3.78	28.59	Pass
	165	5825	-2.01	0.21	3.01	0.16	3.38	28.59	Pass
1	149	5745	-1.81	0.41	3.01	0.16	3.58	28.59	Pass
	157	5785	-1.47	0.75	3.01	0.16	3.92	28.59	Pass
	165	5825	-2.18	0.04	3.01	0.16	3.21	28.59	Pass

Note:

- Method 1 of power density measurement of KDB 662911 is using for calculating total power density. Total power density is summing entire spectra across corresponding frequency bins on the various outputs by computer.
- Directional gain = $4.4\text{dBi} + 10\log(2) = 7.41\text{dBi} > 6\text{dBi}$, so the power density limit shall be reduced to $30 - (7.41 - 6) = 28.59\text{dBm}$.
- Refer to section 3.3 for duty cycle spectrum plot.

802.11n (HT40)

TX chain	Chan.	Freq. (MHz)	PSD w/o Duty Factor		10 log (N=2) dB	Duty Factor (dB)	Total PSD with Duty Factor (dBm/500kHz)	Limit (dBm/500 kHz)	Pass / Fail
			(dBm/300kHz)	(dBm/500kHz)					
0	151	5755	-5.05	-2.83	3.01	0.23	0.41	28.59	Pass
	159	5795	-5.14	-2.92	3.01	0.23	0.32	28.59	Pass
1	151	5755	-5.08	-2.86	3.01	0.23	0.38	28.59	Pass
	159	5795	-4.81	-2.59	3.01	0.23	0.65	28.59	Pass

Note:

- Method 1 of power density measurement of KDB 662911 is using for calculating total power density. Total power density is summing entire spectra across corresponding frequency bins on the various outputs by computer.
- Directional gain = $4.4\text{dBi} + 10\log(2) = 7.41\text{dBi} > 6\text{dBi}$, so the power density limit shall be reduced to $30 - (7.41 - 6) = 28.59\text{dBm}$.
- Refer to section 3.3 for duty cycle spectrum plot.

802.11ac (VHT80)

TX chain	Chan.	Freq. (MHz)	PSD w/o Duty Factor		10 log (N=2) dB	Duty Factor (dB)	Total PSD with Duty Factor (dBm/500kHz)	Limit (dBm/500 kHz)	Pass / Fail
			(dBm/300kHz)	(dBm/500kHz)					
0	155	5775	-8.46	-6.24	3.01	2.58	-0.65	28.59	Pass
1	151	5755	-7.99	-5.77	3.01	2.58	-0.18	28.59	Pass

Note:

- Method 1 of power density measurement of KDB 662911 is using for calculating total power density. Total power density is summing entire spectra across corresponding frequency bins on the various outputs by computer.
- Directional gain = $4.4\text{dBi} + 10\log(2) = 7.41\text{dBi} > 6\text{dBi}$, so the power density limit shall be reduced to $30 - (7.41 - 6) = 28.59\text{dBm}$.
- Refer to section 3.3 for duty cycle spectrum plot.

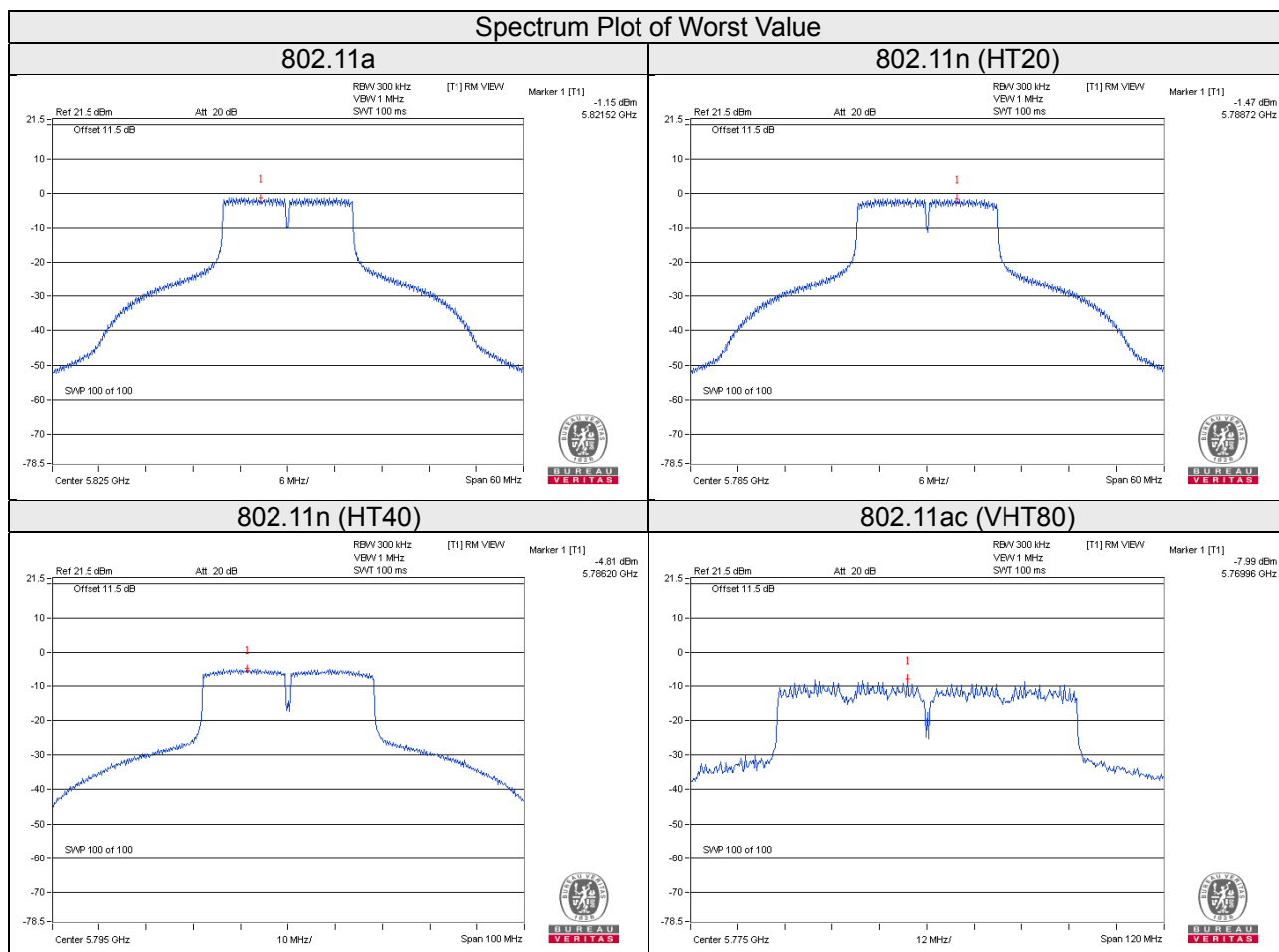

4.6 Frequency Stability

4.6.1 Limits of Frequency Stability Measurement

The frequency of the carrier signal shall be maintained within band of operation

4.6.2 Test Setup

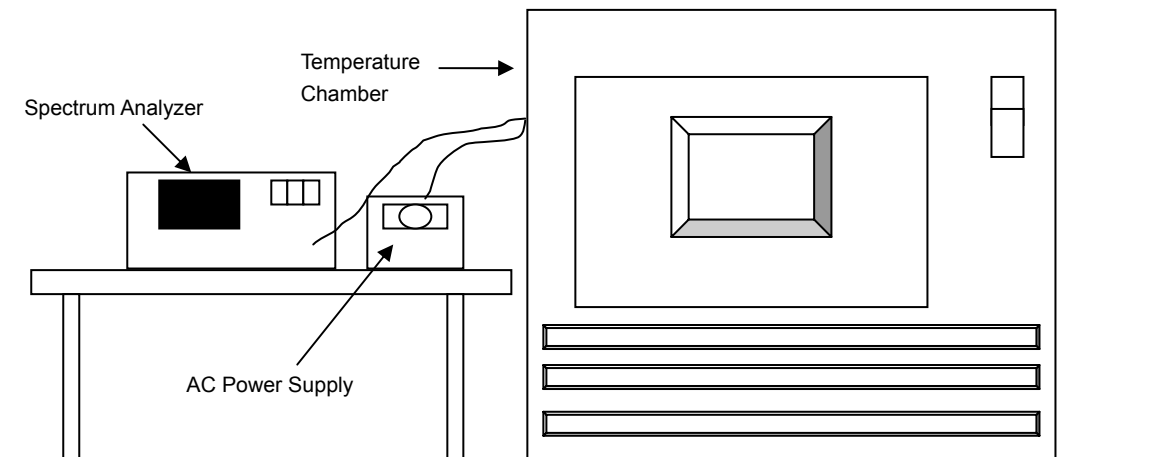

4.6.3 Test Instruments

Description & Manufacturer	Model No.	Serial No.	Cal. Date	Cal. Due
Spectrum Analyzer ROHDE & SCHWARZ	FSP40	100040	Aug. 18, 2017	Aug. 17, 2018
WIT Standard Temperature And Humidity Chamber	TH-4S-C	W981030	Jun. 07, 2017	Jun. 06, 2018
Digital Multimeter FLUKE	87-III	70360742	Jun. 30, 2017	Jun. 29, 2018
AC Power Supply EXTECH	CFW-105	E000603	NA	NA

- Note: 1. The calibration interval of the above test instruments is 12 months and the calibrations are traceable to NML/ROC and NIST/USA.
2. The measurement uncertainty is 207Hz, which is calculated as per the document ETSI TR 100 028. This uncertainty represents an expanded uncertainty expressed at approximately the 95% confidence level using a coverage factor of k=2.

4.6.4 Test Procedure

- The EUT was placed inside the environmental test chamber and powered by nominal AC voltage.
- Turn the EUT on and couple its output to a spectrum analyzer.
- Turn the EUT off and set the chamber to the highest temperature specified.
- Allow sufficient time (approximately 30 min) for the temperature of the chamber to stabilize, turn the EUT on and measure the operating frequency after 2, 5, and 10 minutes.
- Repeat step 2 and 3 with the temperature chamber set to the lowest temperature.
- The test chamber was allowed to stabilize at +20 degree C for a minimum of 30 minutes. The supply voltage was then adjusted on the EUT from 85% to 115% and the frequency record.

4.6.5 Deviation from Test Standard

No deviation.

4.6.6 EUT Operating Condition

Set the EUT transmit at un-modulation mode to test frequency stability.

4.6.7 Test Results

Frequency Stability Versus Temp.									
Operating Frequency: 5180MHz									
Temp. (°C)	Power Supply (Vac)	0 Minute		2 Minute		5 Minute		10 Minute	
		Measured Frequency (MHz)	Frequency Drift (%)	Measured Frequency (MHz)	Frequency Drift (%)	Measured Frequency (MHz)	Frequency Drift (%)	Measured Frequency (MHz)	Frequency Drift (%)
50	120	5180.011	0.00021	5180.0097	0.00019	5180.0122	0.00024	5180.0075	0.00014
40	120	5179.9848	-0.00029	5179.9812	-0.00036	5179.9853	-0.00028	5179.983	-0.00033
30	120	5179.9848	-0.00029	5179.9839	-0.00031	5179.9874	-0.00024	5179.9857	-0.00028
20	120	5180.0061	0.00012	5180.0095	0.00018	5180.0088	0.00017	5180.0107	0.00021
10	120	5180.0045	0.00009	5180.0038	0.00007	5180.0071	0.00014	5180.0069	0.00013
0	120	5179.9797	-0.00039	5179.9777	-0.00043	5179.9788	-0.00041	5179.9795	-0.00040
-10	120	5179.9894	-0.00020	5179.9911	-0.00017	5179.989	-0.00021	5179.9925	-0.00014
-20	120	5180.0168	0.00032	5180.015	0.00029	5180.0176	0.00034	5180.0148	0.00029
-30	120	5180.0206	0.00040	5180.0187	0.00036	5180.0206	0.00040	5180.0198	0.00038

Frequency Stability Versus Voltage									
Operating Frequency: 5180MHz									
Temp. (°C)	Power Supply (Vac)	0 Minute		2 Minute		5 Minute		10 Minute	
		Measured Frequency (MHz)	Frequency Drift (%)	Measured Frequency (MHz)	Frequency Drift (%)	Measured Frequency (MHz)	Frequency Drift (%)	Measured Frequency (MHz)	Frequency Drift (%)
20	138	5180.0056	0.00011	5180.0086	0.00017	5180.0097	0.00019	5180.0098	0.00019
	120	5180.0061	0.00012	5180.0095	0.00018	5180.0088	0.00017	5180.0107	0.00021
	102	5180.0064	0.00012	5180.0099	0.00019	5180.0082	0.00016	5180.0117	0.00023

4.7 6dB Bandwidth Measurement

4.7.1 Limits of 6dB Bandwidth Measurement

The minimum of 6dB Bandwidth Measurement is 0.5MHz.

4.7.2 Test Setup

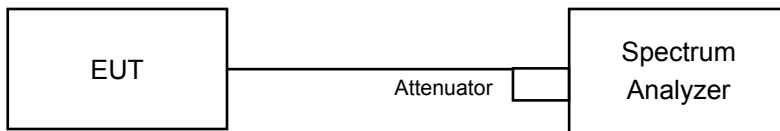

4.7.3 Test Instruments

Refer to section 4.1.2 to get information of above instrument.

4.7.4 Test Procedure

Measurement Procedure REF

- Set resolution bandwidth (RBW) = 100kHz
- Set the video bandwidth (VBW) $\geq 3 \times$ RBW, Detector = average.
- Trace mode = max hold.
- Sweep = auto couple.
- Measure the maximum width of the emission that is constrained by the frequencies associated with the two amplitude points (upper and lower) that are attenuated by 6 dB relative to the maximum level measured in the fundamental emission

4.7.5 Deviation from Test Standard

No deviation.

4.7.6 EUT Operating Condition

The software provided by client to enable the EUT under transmission condition continuously at lowest, middle and highest channel frequencies individually.

4.7.7 Test Results

802.11a

Channel	Frequency (MHz)	6dB Bandwidth (MHz)	Minimum Limit (MHz)	Pass / Fail
149	5745	16.39	0.5	Pass
157	5785	16.39	0.5	Pass
165	5825	16.39	0.5	Pass

802.11n (HT20)

Channel	Frequency (MHz)	6dB Bandwidth (MHz)		Minimum Limit (MHz)	Pass / Fail
		Chain 0	Chain 1		
149	5745	17.61	17.19	0.5	Pass
157	5785	17.62	17.60	0.5	Pass
165	5825	17.61	17.63	0.5	Pass

802.11n (HT40)

Channel	Frequency (MHz)	6dB Bandwidth (MHz)		Minimum Limit (MHz)	Pass / Fail
		Chain 0	Chain 1		
151	5755	36.43	35.89	0.5	Pass
159	5795	36.44	36.34	0.5	Pass

802.11ac (VHT80)

Channel	Frequency (MHz)	6dB Bandwidth (MHz)		Minimum Limit (MHz)	Pass / Fail
		Chain 0	Chain 1		
155	5775	76.52	75.99	0.5	Pass

Spectrum Plot of Worst Value

802.11a

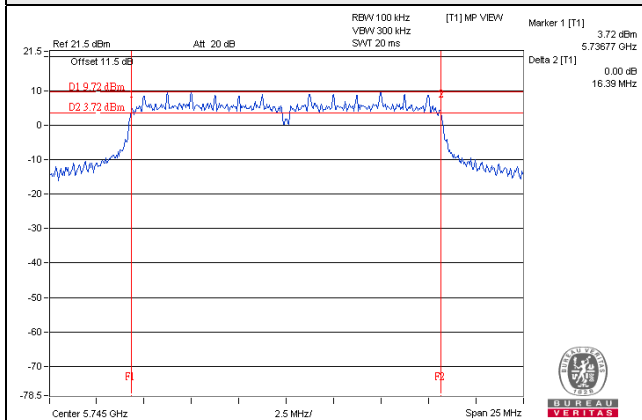

802.11n (HT20)

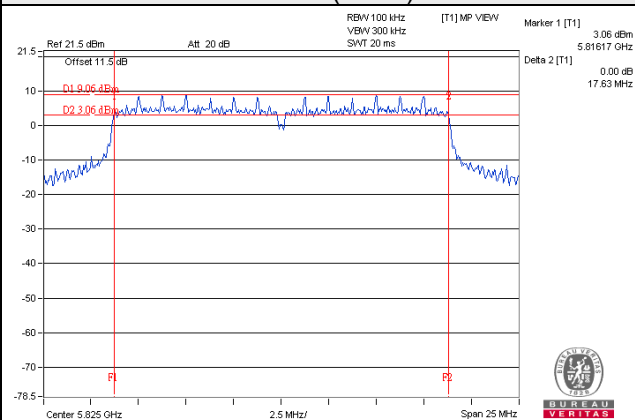

802.11n (HT40)

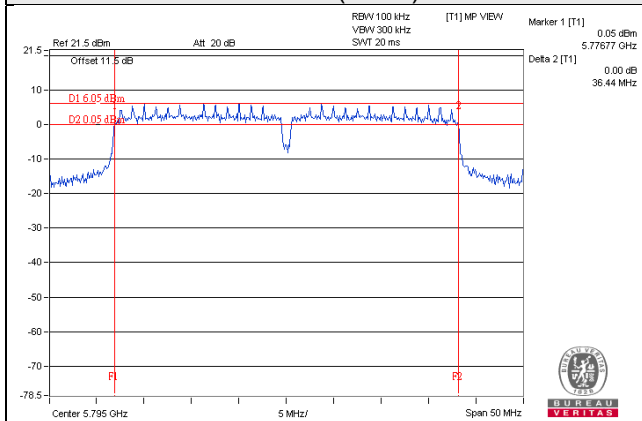

802.11ac (VHT80)

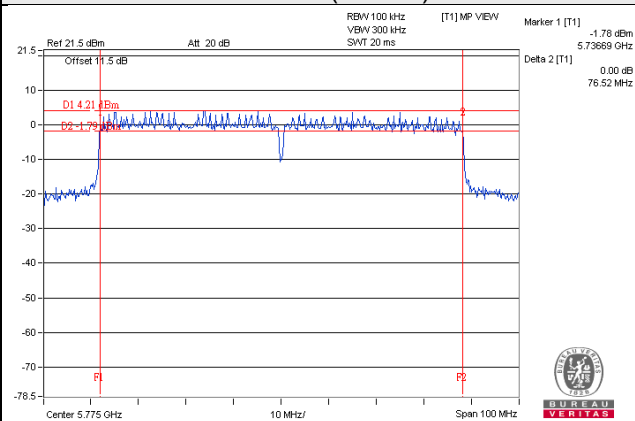

5 Pictures of Test Arrangements

Please refer to the attached file (Test Setup Photo).

Annex A- Radiated Out of Band Emission (OOBE) Measurement (For U-NII-3 band)

802.11a

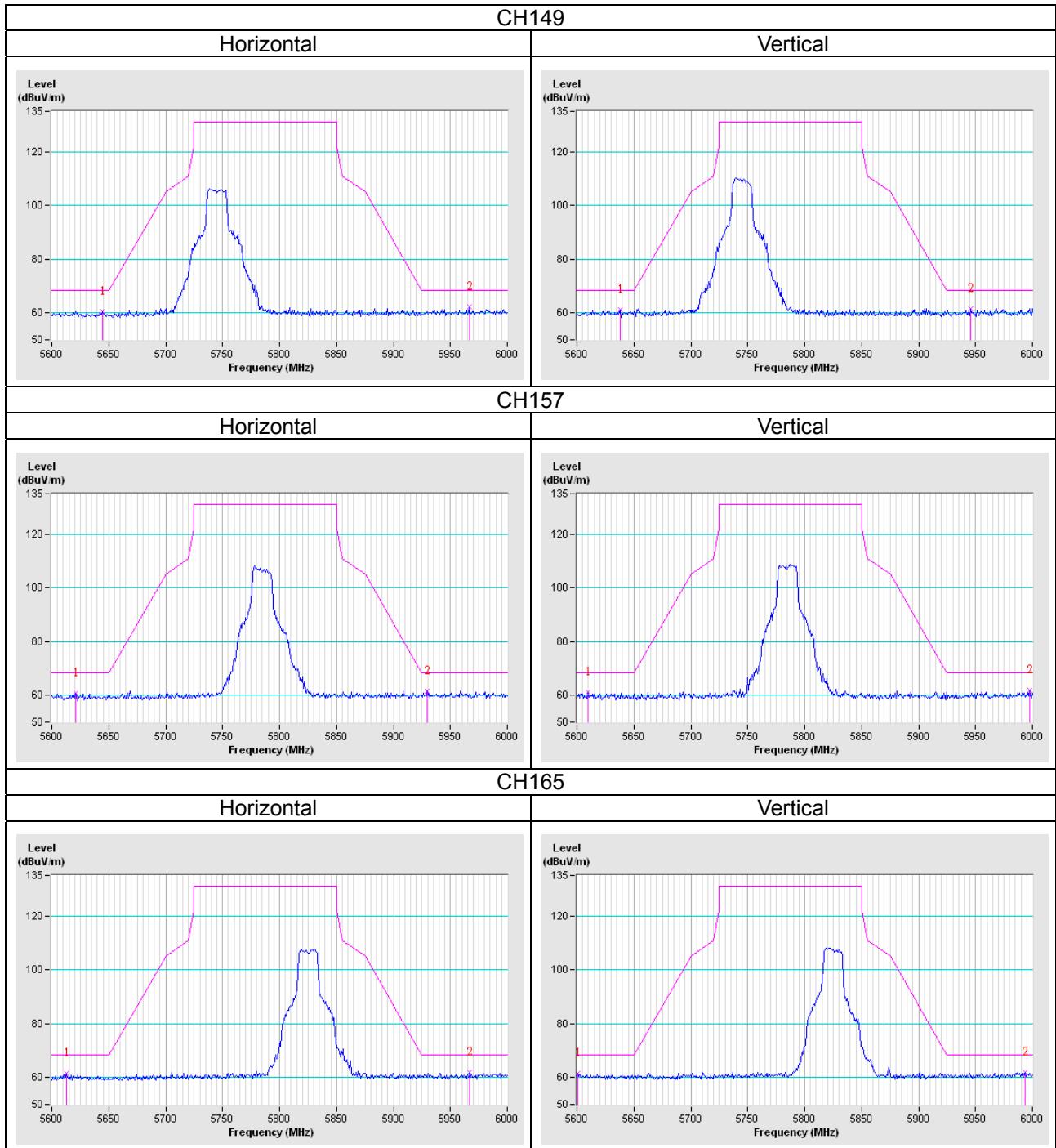

802.11n (HT20)

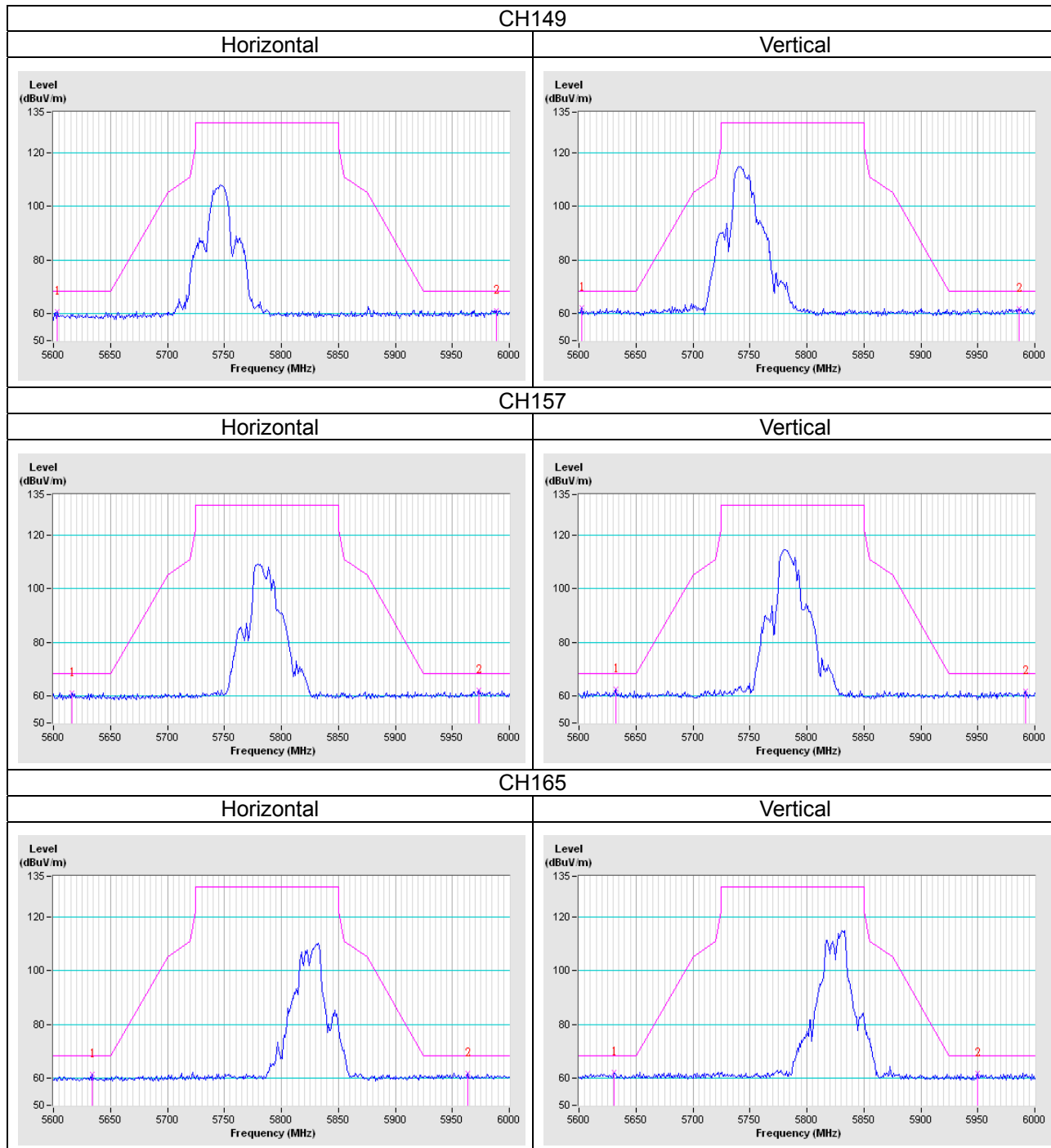

802.11n (HT40)

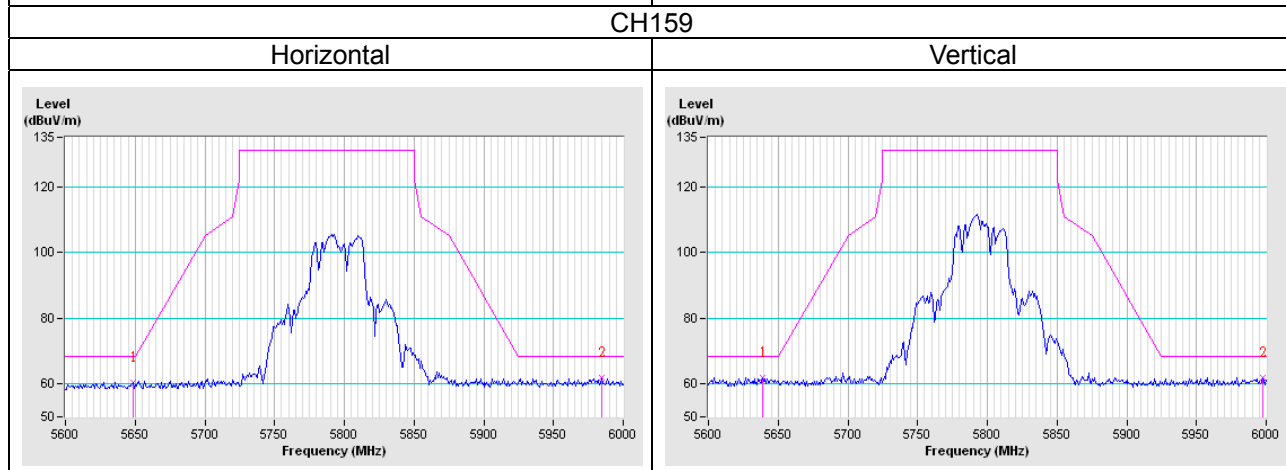
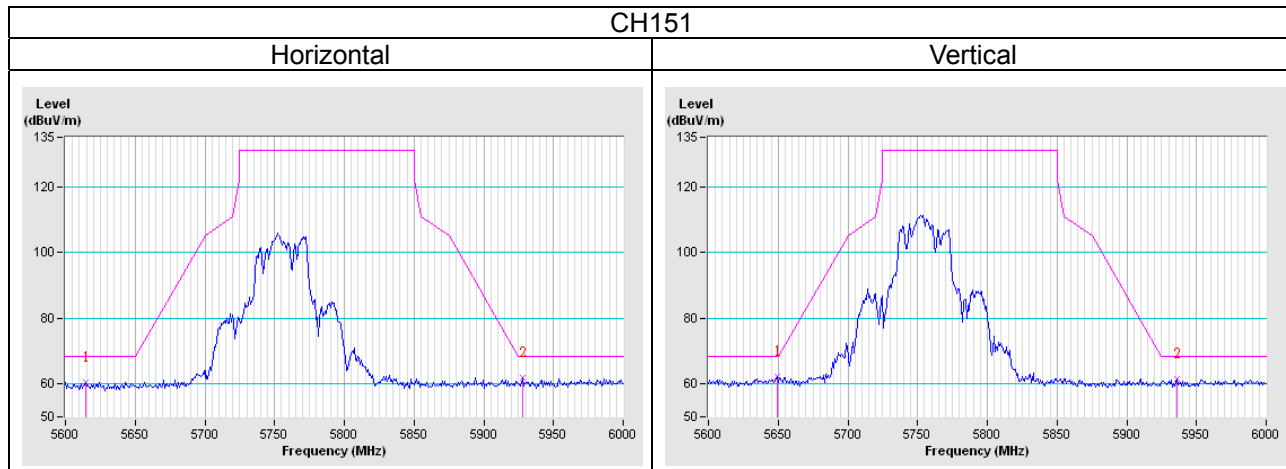

802.11ac (VHT80)

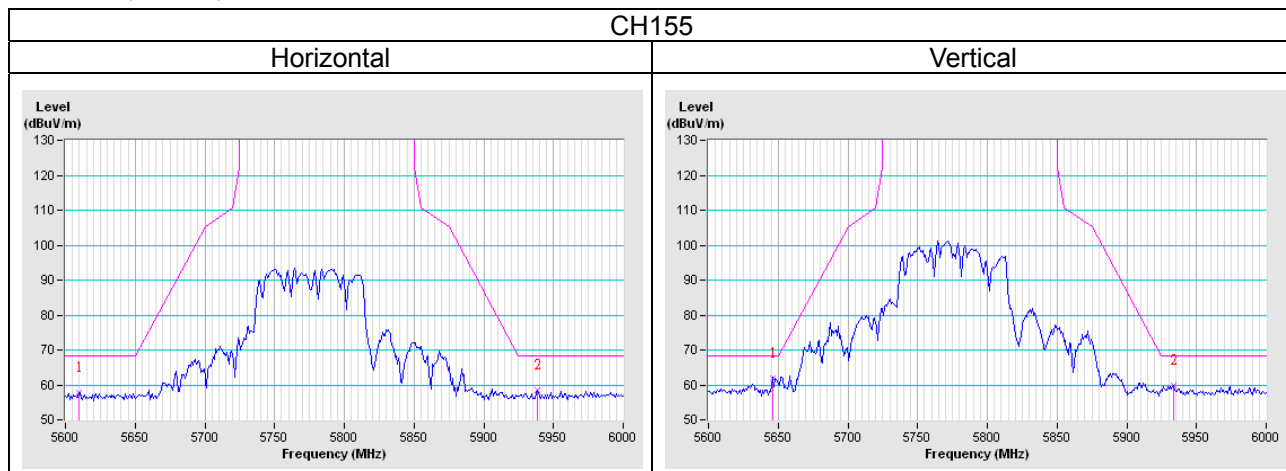

Appendix – Information on the Testing Laboratories

We, Bureau Veritas Consumer Products Services (H.K.) Ltd., Taoyuan Branch, were founded in 1988 to provide our best service in EMC, Radio, Telecom and Safety consultation. Our laboratories are FCC recognized accredited test firms and accredited and approved according to ISO/IEC 17025.

If you have any comments, please feel free to contact us at the following:

Linko EMC/RF Lab

Tel: 886-2-26052180

Fax: 886-2-26051924

Hsin Chu EMC/RF/Telecom Lab

Tel: 886-3-6668565

Fax: 886-3-6668323

Hwa Ya EMC/RF/Safety

Tel: 886-3-3183232

Fax: 886-3-3270892

Email: service.adt@tw.bureauveritas.com

Web Site: www.bureauveritas-adt.com

The address and road map of all our labs can be found in our web site also.

--- END ---