

# FCC Radio Test Report

## FCC ID: 2ACSVHF-LPS170

This report concerns: Original Grant

**Project No.** : 2103H034  
**Equipment** : Low Power SDIO Wi-Fi + BLE Module  
**Brand Name** : High-Flying  
**Test Model** : HF-LPS170  
**Series Model** : N/A  
**Applicant** : High-Flying Electronics Technology Co., Ltd.  
**Address** : Room 1002, Building 1, No.3000, Longdong Avenue, Pudong New Area, Shanghai ,China  
**Manufacturer** : High-Flying Electronics Technology Co., Ltd.  
**Address** : Room 1002, Building 1, No.3000, Longdong Avenue, Pudong New Area, Shanghai ,China  
**Factory** : China Dragon Technology Limited  
**Address** : B4 Building, Haosan NO.1 Industrial Zone, Nanpu Road,Xinqiao Street, Baoan District, Shenzhen  
**Date of Receipt** : Apr. 22, 2021  
**Date of Test** : Apr. 22, 2021~Jun.04, 2021  
**Issued Date** : Jun. 16, 2021  
**Report Version** : R00  
**Test Sample** : Engineering Sample No.: SH2021040798-2  
**Standard(s)** : FCC CFR Title 47, Part 15, Subpart C  
FCC KDB 558074 D01 15.247 Meas Guidance v05r02  
ANSI C63.10-2013

The above equipment has been tested and found compliance with the requirement of the relative standards by BTL Inc.

Maker Qi

Prepared by : Maker Qi

Issac Song.

Approved by : Issac Song



Certificate # 5123.03

Add: No. 29, Jintang Road, Tangzhen Industry Park, Pudong New Area, Shanghai 201210,China

TEL: +86-021-61765666

Web: www.newbtl.com

**Declaration**

**BTL** represents to the client that testing is done in accordance with standard procedures as applicable and that test instruments used has been calibrated with standards traceable to international standard(s) and/or national standard(s).

**BTL's** reports apply only to the specific samples tested under conditions. It is manufacture's responsibility to ensure that additional production units of this model are manufactured with the identical electrical and mechanical components. **BTL** shall have no liability for any declarations, inferences or generalizations drawn by the client or others from **BTL** issued reports.

The report must not be used by the client to claim product certification, approval, or endorsement by NVLAP, NIST, A2LA, or any agency of the U.S. Government.

This report is the confidential property of the client. As a mutual protection to the clients, the public and ourselves, the test report shall not be reproduced, except in full, without our written approval.

**BTL's** laboratory quality assurance procedures are in compliance with the **ISO/IEC 17025** requirements, and accredited by the conformity assessment authorities listed in this test report.

**BTL** is not responsible for the sampling stage, so the results only apply to the sample as received.

The information, data and test plan are provided by manufacturer which may affect the validity of results, so it is manufacturer's responsibility to ensure that the apparatus meets the essential requirements of applied standards and in all the possible configurations as representative of its intended use.

**Limitation**

For the use of the authority's logo is limited unless the Test Standard(s)/Scope(s)/Item(s) mentioned in this test report is (are) included in the conformity assessment authorities acceptance respective.

Please note that the measurement uncertainty is provided for informational purpose only and are not use in determining the Pass/Fail results.

<b>Table of Contents</b>	<b>Page</b>
<b>REPORT ISSUED HISTORY</b>	<b>6</b>
<b>1 . SUMMARY OF TEST RESULTS</b>	<b>7</b>
1.1 TEST FACILITY	8
1.2 MEASUREMENT UNCERTAINTY	8
1.3 TEST ENVIRONMENT CONDITIONS	8
<b>2 . GENERAL INFORMATION</b>	<b>9</b>
2.1 GENERAL DESCRIPTION OF EUT	9
2.2 DESCRIPTION OF TEST MODES	10
2.3 PARAMETERS OF TEST SOFTWARE	11
2.4 BLOCK DIAGRAM SHOWING THE CONFIGURATION OF SYSTEM TESTED	12
2.5 SUPPORT UNITS	12
<b>3 . AC POWER LINE CONDUCTED EMISSIONS</b>	<b>13</b>
3.1 LIMIT	13
3.2 TEST PROCEDURE	13
3.3 DEVIATION FROM TEST STANDARD	13
3.4 TEST SETUP	14
3.5 EUT OPERATING CONDITIONS	14
3.6 TEST RESULTS	14
<b>4 . RADIATED EMISSIONS</b>	<b>15</b>
4.1 LIMIT	15
4.2 TEST PROCEDURE	16
4.3 DEVIATION FROM TEST STANDARD	17
4.4 TEST SETUP	17
4.5 EUT OPERATING CONDITIONS	18
4.6 TEST RESULT - 9 KHZ TO 30 MHZ	18
4.7 TEST RESULT - 30 MHZ TO 1000 MHZ	18
4.8 TEST RESULT - ABOVE 1000 MHZ	18
<b>5 . BANDWIDTH</b>	<b>19</b>
5.1 LIMIT	19
5.2 TEST PROCEDURE	19
5.3 DEVIATION FROM STANDARD	19
5.4 TEST SETUP	19

<b>Table of Contents</b>	<b>Page</b>
5.5 EUT OPERATION CONDITIONS	19
5.6 TEST RESULTS	19
<b>6 . MAXIMUM OUTPUT POWER</b>	<b>20</b>
6.1 LIMIT	20
6.2 TEST PROCEDURE	20
6.3 DEVIATION FROM STANDARD	20
6.4 TEST SETUP	20
6.5 EUT OPERATION CONDITIONS	20
6.6 TEST RESULTS	20
<b>7 . CONDUCTED SPURIOUS EMISSION</b>	<b>21</b>
7.1 LIMIT	21
7.2 TEST PROCEDURE	21
7.3 DEVIATION FROM STANDARD	21
7.4 TEST SETUP	21
7.5 EUT OPERATION CONDITIONS	21
7.6 TEST RESULTS	21
<b>8 . POWER SPECTRAL DENSITY</b>	<b>22</b>
8.1 LIMIT	22
8.2 TEST PROCEDURE	22
8.3 DEVIATION FROM STANDARD	22
8.4 TEST SETUP	22
8.5 EUT OPERATION CONDITIONS	22
8.6 TEST RESULTS	22
<b>9 . MEASUREMENT INSTRUMENTS LIST</b>	<b>23</b>
<b>10 . EUT TEST PHOTO</b>	<b>25</b>
<b>APPENDIX A - AC POWER LINE CONDUCTED EMISSIONS</b>	<b>27</b>
<b>APPENDIX B - RADIATED EMISSION - 9 KHZ TO 30 MHZ</b>	<b>28</b>
<b>APPENDIX C - RADIATED EMISSION - 30 MHZ TO 1000 MHZ</b>	<b>29</b>
<b>APPENDIX D - RADIATED EMISSION - ABOVE 1000 MHZ</b>	<b>32</b>
<b>APPENDIX E - BANDWIDTH</b>	<b>45</b>
<b>APPENDIX F - MAXIMUM OUTPUT POWER</b>	<b>47</b>

**Table of Contents****Page****APPENDIX G - CONDUCTED SPURIOUS EMISSION****49****APPENDIX H - POWER SPECTRAL DENSITY****51**

**REPORT ISSUED HISTORY**

Report Version	Description	Issued Date
R00	Original Issue.	Jun. 16, 2021

## 1. SUMMARY OF TEST RESULTS

Test procedures according to the technical standard(s):

FCC CFR Title 47, Part 15, Subpart C				
Standard(s) Section	Test Item	Test Result	Judgment	Remark
15.207	AC Power Line Conducted Emissions	APPENDIX A	N/A	-----
15.247(d) 15.205(a) 15.209(a)	Radiated Emissions	APPENDIX B APPENDIX C APPENDIX D	PASS	-----
15.247(a)(2)	Bandwidth	APPENDIX E	PASS	-----
15.247(b)(3)	Maximum Output Power	APPENDIX F	PASS	-----
15.247(d)	Conducted Spurious Emission	APPENDIX G	PASS	-----
15.247(e)	Power Spectral Density	APPENDIX H	PASS	-----
15.203	Antenna Requirement	-----	PASS	Note(2)

Note:

- (1) "N/A" denotes test is not applicable to this device.
- (2) The device what use a permanently attached antenna were considered sufficient to comply with the provisions of 15.203.

### 1.1 TEST FACILITY

The test facilities used to collect the test data in this report is at the location of No. 29, Jintang Road, Tangzhen Industry Park, Pudong New Area, Shanghai 201210, China  
 BTL's Test Firm Registration Number for FCC: 476765  
 BTL's Designation Number for FCC: CN1241

### 1.2 MEASUREMENT UNCERTAINTY

ISO/IEC 17025 requires that an estimate of the measurement uncertainties associated with the emissions test results be included in the report. The measurement uncertainties given below are based on a 95% confidence level (based on a coverage factor (k=2))  
 The BTL measurement uncertainty as below table:

A. Radiated emissions test:

Test Site	Method	Measurement Frequency Range	Ant. H / V	U, (dB)
SH-CB01	CISPR	9 KHz~30 MHz	V	3.79
		9 KHz~30 MHz	H	3.57
		30 MHz~200 MHz	V	4.04
		30 MHz~200 MHz	H	3.76
		200 MHz~1,000 MHz	V	4.24
		200 MHz~1,000 MHz	H	3.84
		1 GHz~18 GHz	V	4.46
		1 GHz~18 GHz	H	4.40
		18 GHz~40 GHz	V	3.95
		18 GHz~40 GHz	H	3.95

Note: Unless specifically mentioned, the uncertainty of measurement has not been taken into account to declare the compliance or non-compliance to the specification.

### 1.3 TEST ENVIRONMENT CONDITIONS

Test Item	Temperature	Humidity	Test Voltage	Tested By
Radiated Emissions-30 MHz to 1000 MHz	24°C	58%	DC 3.3V	Forest Li
Radiated Emissions-Above 1000 MHz	24°C	58%	DC 3.3V	Forest Li
Bandwidth	26°C	42%	DC 3.3V	Danny Dang
Maximum Output Power	26°C	42%	DC 3.3V	Danny Dang
Conducted Spurious Emission	26°C	42%	DC 3.3V	Danny Dang
Power Spectral Density	26°C	42%	DC 3.3V	Danny Dang



## 2. GENERAL INFORMATION

### 2.1 GENERAL DESCRIPTION OF EUT

Equipment	Low Power SDIO Wi-Fi + BLE Module
Brand Name	High-Flying
Test Model	HF-LPS170
Series Model	N/A
Model Difference(s)	N/A
Software Version	2.0.07
Hardware Version	V2.0
Power Source	DC voltage supplied via Notebook.
Power Rating	DC 3.3V
Operation Frequency	2402 MHz ~ 2480 MHz
Modulation Type	GFSK
Bit Rate of Transmitter	1Mbps
Max. Output Power	1Mbps: 8.86 dBm (0.0077 W)

Note:

- For a more detailed features description, please refer to the manufacturer's specifications or the user's manual.

#### 2. Channel List:

Channel	Frequency (MHz)	Channel	Frequency (MHz)
00	2402	20	2442
01	2404	21	2444
02	2406	22	2446
03	2408	23	2448
04	2410	24	2450
05	2412	25	2452
06	2414	26	2454
07	2416	27	2456
08	2418	28	2458
09	2420	29	2460
10	2422	30	2462
11	2424	31	2464
12	2426	32	2466
13	2428	33	2468
14	2430	34	2470
15	2432	35	2472
16	2434	36	2474
17	2436	37	2476
18	2438	38	2478
19	2440	39	2480

#### 3. Table for Filed Antenna:

Ant.	Brand	Model Name	Antenna Type	Connector	Gain (dBi)
1	N/A	N/A	Dipole	N/A	3

Note:

The antenna gain is provided by the manufacturer.

## 2.2 DESCRIPTION OF TEST MODES

The test system was pre-tested based on the consideration of all possible combinations of EUT operation mode.

Pretest Mode	Description
Mode 1	TX Mode_1Mbps Channel 00/19/39
Mode 2	TX Mode_1Mbps Channel 00

Following mode(s) was (were) found to be the worst case(s) and selected for the final test.

Radiated emissions test - Below 1GHz	
Final Test Mode	Description
Mode 2	TX Mode_1Mbps Channel 00

Radiated emissions test - Above 1GHz	
Final Test Mode	Description
Mode 1	TX Mode_1Mbps Channel 00/19/39

Conducted test	
Final Test Mode	Description
Mode 1	TX Mode_1Mbps Channel 00/19/39

Note:

- (1) For radiated emission above 1 GHz test, the spurious points of 1GHz~26.5GHz have been pre-tested and in this report only recorded the worst case. The remaining spurious points are all below the limit value of 20dB.
- (2) For radiated emissions below 1 GHz test, the 1Mbps Channel 00 is found to be the worst case and recorded.

### 2.3 PARAMETERS OF TEST SOFTWARE

During testing channel & power controlling software provided by the customer was used to control the operating channel as well as the output power level.

Test Software Version	BLDevCube V1.4.7		
Frequency (MHz)	2402	2440	2480
1Mbps	13	10	10

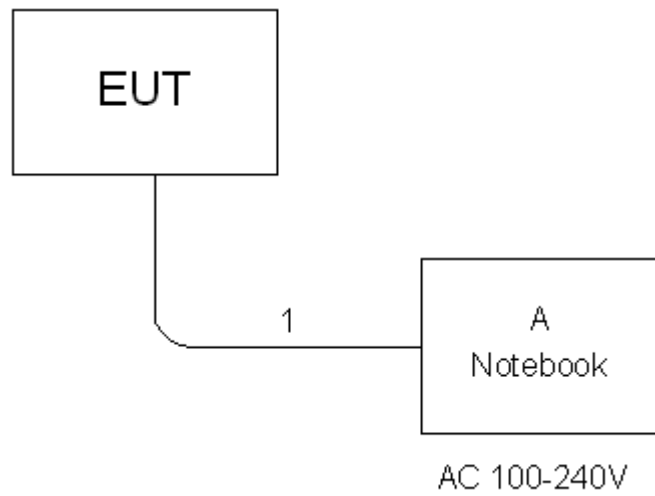
**2.4 BLOCK DIAGRAM SHOWING THE CONFIGURATION OF SYSTEM TESTED****2.5 SUPPORT UNITS**

Item	Equipment	Brand	Model/Type No.	Series No.
A	Notebook	Dell	Inspiron 14-7472	N/A

Item	Cable Type	Shielded Type	Ferrite Core	Length
1	USB Cable	N/A	N/A	1m

### 3. AC POWER LINE CONDUCTED EMISSIONS

#### 3.1 LIMIT

Frequency of Emission (MHz)	Limit (dB $\mu$ V)	
	Quasi-peak	Average
0.15 - 0.5	66 to 56*	56 to 46*
0.5 - 5.0	56	46
5.0 - 30.0	60	50

Note:

- (1) The tighter limit applies at the band edges.
- (2) The limit of " \* " marked band means the limitation decreases linearly with the logarithm of the frequency in the range.

#### 3.2 TEST PROCEDURE

- a. The EUT was placed 0.8 meters from the horizontal ground plane with EUT being connected to the power mains through a line impedance stabilization network (LISN). All other support equipment powered from additional LISN(s). The LISN provide 50 Ohm/ 50uH of coupling impedance for the measuring instrument.
- b. Interconnecting cables that hang closer than 40 cm to the ground plane shall be folded back and forth in the center forming a bundle 30 to 40 cm long.
- c. I/O cables that are not connected to a peripheral shall be bundled in the center. The end of the cable may be terminated, if required, using the correct terminating impedance. The overall length shall not exceed 1 m.
- d. LISN at least 80 cm from nearest part of EUT chassis.
- e. For the actual test configuration, please refer to the related Item –EUT Test Photos.

The following table is the setting of the receiver:

Receiver Parameters	Setting
Start Frequency	0.15 MHz
Stop Frequency	30 MHz
IF Bandwidth	9 kHz

#### 3.3 DEVIATION FROM TEST STANDARD

No deviation.

### 3.4 TEST SETUP

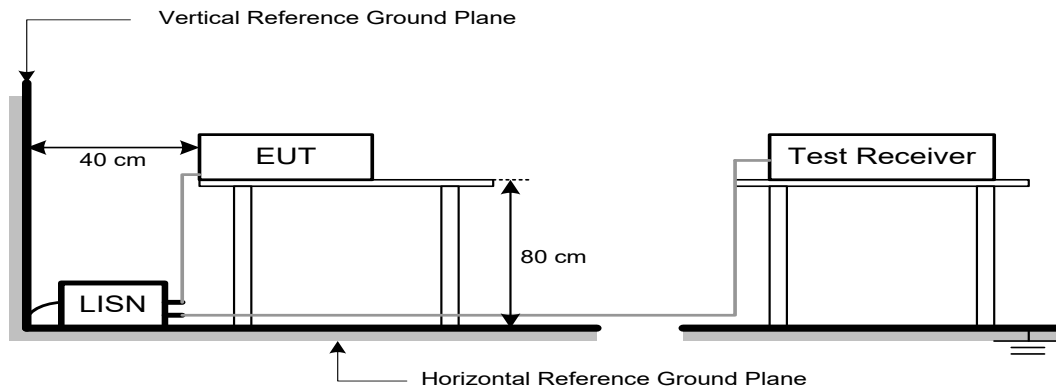

### 3.5 EUT OPERATING CONDITIONS

The EUT was configured for testing in a typical fashion (as a customer would normally use it). The EUT has been programmed to continuously transmit during test. This operating condition was tested and used to collect the included data.

### 3.6 TEST RESULTS

Please refer to the APPENDIX A.

Remark:

- (1) All readings are QP Mode value unless otherwise stated AVG in column of 『Note』 . If the QP Mode Measured value compliance with the QP Limits and lower than AVG Limits, the EUT shall be deemed to meet both QP & AVG Limits and then only QP Mode was measured, but AVG Mode didn't perform. In this case, a “ \* ” marked in AVG Mode column of Interference Voltage Measured.
- (2) Measuring frequency range from 150 kHz to 30 MHz.

## 4. RADIATED EMISSIONS

### 4.1 LIMIT

In case the emission fall within the restricted band specified on 15.205(a), then the 15.209(a) limit in the table below has to be followed.

#### LIMITS OF RADIATED EMISSION MEASUREMENT (9 kHz-1000 MHz)

Frequency (MHz)	Field Strength (microvolts/meter)	Measurement Distance (meters)
0.009-0.490	2400/F(kHz)	300
0.490-1.705	24000/F(kHz)	30
1.705-30.0	30	30
30-88	100	3
88-216	150	3
216-960	200	3
Above 960	500	3

#### LIMITS OF RADIATED EMISSION MEASUREMENT (Above 1000 MHz)

Frequency (MHz)	(dBuV/m at 3 m)	
	Peak	Average
Above 1000	74	54

**Note:**

- (1) The limit for radiated test was performed according to FCC CFR Title 47, Part 15, Subpart C.
- (2) The tighter limit applies at the band edges.
- (3) Emission level (dBuV/m)=20log Emission level (uV/m).

#### 4.2 TEST PROCEDURE

- a. The measuring distance of 3 m shall be used for measurements. The EUT was placed on the top of a rotating table 0.8 meter above the ground at a 3 meter semi-anechoic chamber. The table was rotated 360 degrees to determine the position of the highest radiation.(below 1 GHz)
- b. The measuring distance of 3 m shall be used for measurements. The EUT was placed on the top of a rotating table 1.5 meter above the ground at a 3 meter semi-anechoic chamber. The table was rotated 360 degrees to determine the position of the highest radiation.(above 1 GHz)
- c. The height of the equipment or of the substitution antenna shall be 0.8m or 1.5m; the height of the test antenna shall vary between 1 m to 4 m. Both horizontal and vertical polarizations of the antenna are set to make the measurement.
- d. For each suspected emission, the EUT was arranged to its worst case and then the antenna was tuned to heights find the maximum reading (used Bore sight function).
- e. The receiver system was set to peak and average detect function and specified bandwidth with maximum hold mode when the test frequency is above 1 GHz.
- f. The initial step in collecting radiated emission data is a receiver peak detector mode pre-scanning the measurement frequency range. Significant peaks are then marked and then Quasi Peak detector mode re-measured.
- g. All readings are Peak unless otherwise stated QP in column of Note. Peak denotes that the Peak reading compliance with the QP Limits and then QP Mode measurement didn't perform.  
(below 1 GHz)
- h. All readings are Peak Mode value unless otherwise stated AVG in column of Note. If the Peak Mode Measured value compliance with the Peak Limits and lower than AVG Limits, the EUT shall be deemed to meet both Peak & AVG Limits and then only Peak Mode was measured, but AVG Mode didn't perform. (above 1 GHz)
- i. For the actual test configuration, please refer to the related Item –EUT Test Photos.

The following table is the setting of the receiver:

Spectrum Parameters	Setting
Start ~ Stop Frequency	9 kHz~150 kHz for RBW 200 Hz
Start ~ Stop Frequency	0.15 MHz~30 MHz for RBW 9 kHz
Start ~ Stop Frequency	30 MHz~1000 MHz for RBW 100 kHz

Spectrum Parameters	Setting
Start Frequency	1000 MHz
Stop Frequency	10th carrier harmonic
RBW / VBW (Emission in restricted band)	1 MHz / 3 MHz for PK value 1 MHz / 1/T Hz for AVG value

Spectrum Parameters	Setting
Start ~ Stop Frequency	9 kHz~90 kHz for PK/AVG detector
Start ~ Stop Frequency	90 kHz~110 kHz for QP detector
Start ~ Stop Frequency	110 kHz~490 kHz for PK/AVG detector
Start ~ Stop Frequency	490 kHz~30 MHz for QP detector
Start ~ Stop Frequency	30 MHz~1000 MHz for QP detector
Start ~ Stop Frequency	1 GHz~26.5 GHz for PK/AVG detector



### 4.3 DEVIATION FROM TEST STANDARD

No deviation.

### 4.4 TEST SETUP

9 kHz to 30 MHz

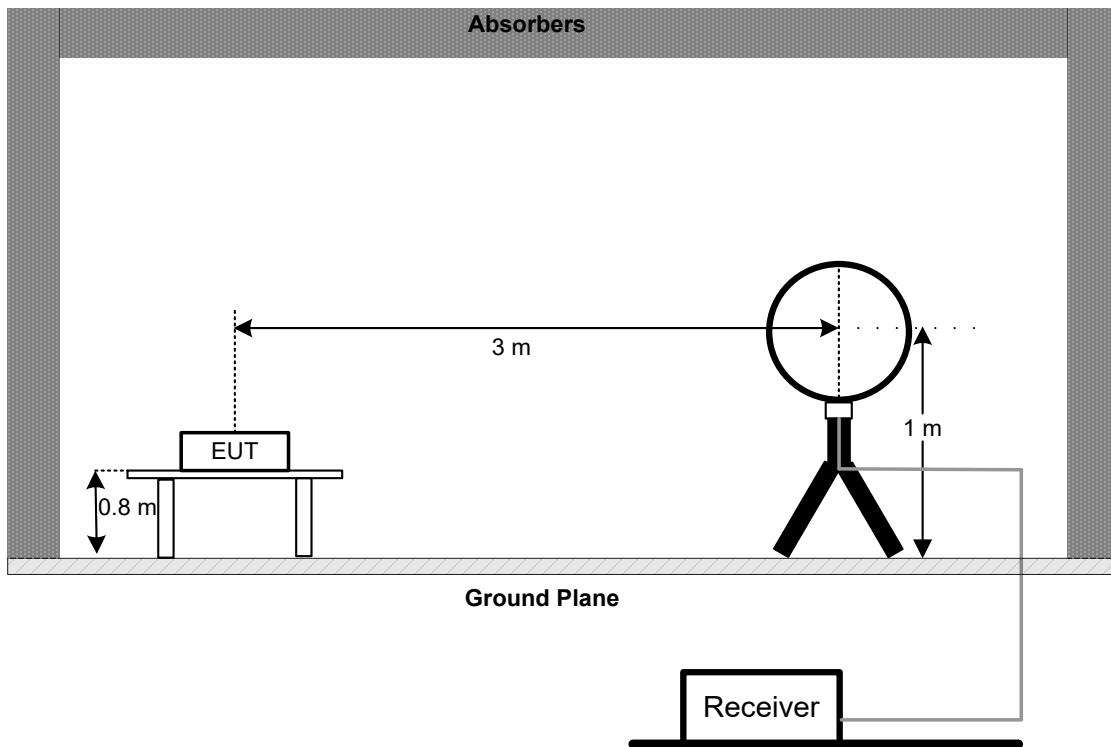

30 MHz to 1 GHz

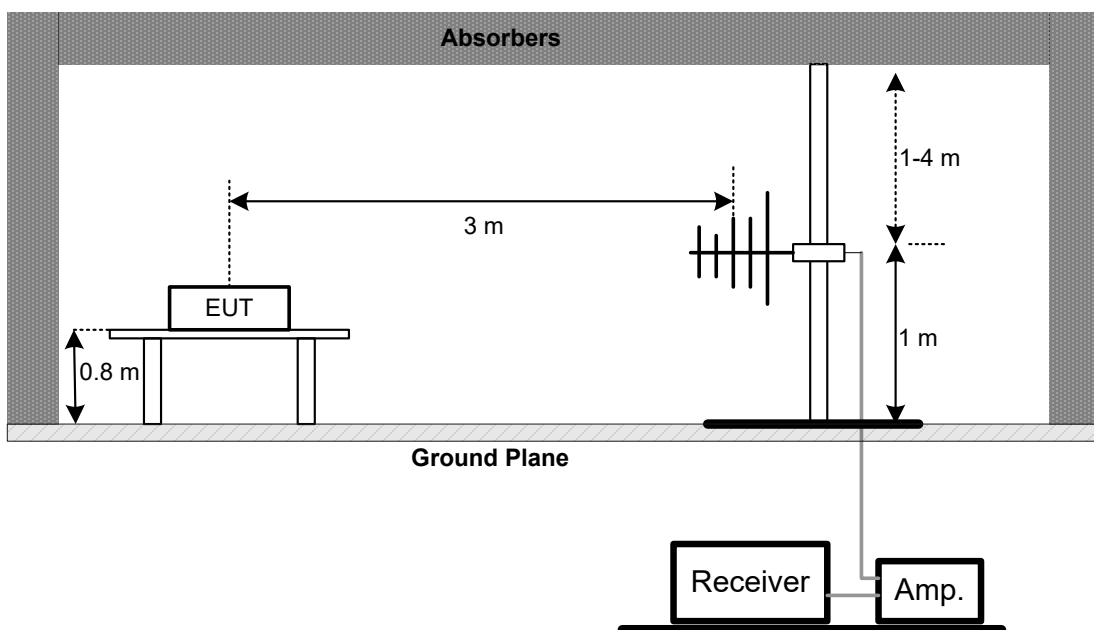

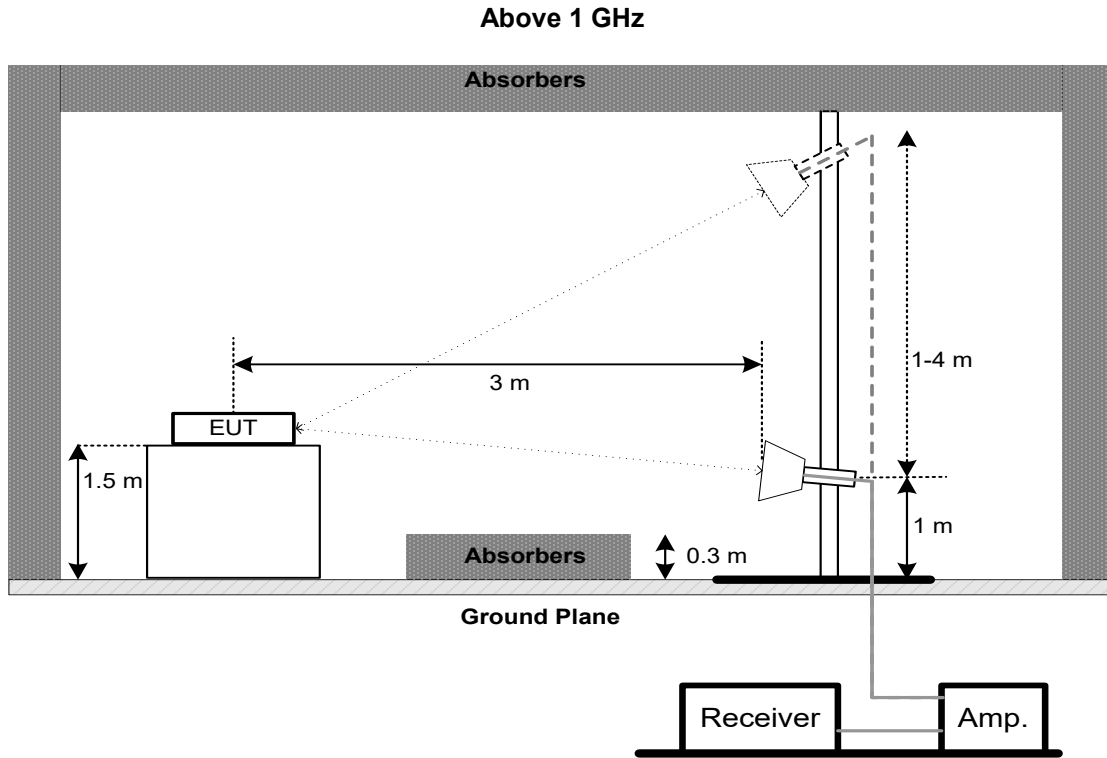

#### 4.5 EUT OPERATING CONDITIONS

The EUT was programmed to be in continuously transmitting mode.

#### 4.6 TEST RESULT - 9 kHz TO 30 MHz

Please refer to the APPENDIX B.

Remark:

- (1) Distance extrapolation factor =  $40 \log(\text{specific distance} / \text{test distance})$  (dB).
- (2) Limit line = specific limits (dBuV) + distance extrapolation factor.

#### 4.7 TEST RESULT - 30 MHz TO 1000 MHz

Please refer to the APPENDIX C.

#### 4.8 TEST RESULT - ABOVE 1000 MHz

Please refer to the APPENDIX D.

Remark:

- (1) No limit: This is fundamental signal, the judgment is not applicable.  
For fundamental signal judgment was referred to Peak output test.

## 5. BANDWIDTH

### 5.1 LIMIT

Section	Test Item	Limit
FCC 15.247(a)(2)	6 dB Bandwidth	$\geq 500$ kHz
	99% Emission Bandwidth	-

### 5.2 TEST PROCEDURE

- The EUT was directly connected to the spectrum analyzer and antenna output port as show in the block diagram below.
- The following table is the setting of the spectrum analyzer:

For 6 dB Bandwidth:

Spectrum Parameters	Setting
Span Frequency	$>$ Measurement Bandwidth
RBW	100 kHz
VBW	300 kHz
Detector	Peak
Trace	Max Hold
Sweep Time	Auto

For 99% Emission Bandwidth:

Spectrum Parameters	Setting
Span Frequency	Between 1.5 times and 5.0 times the OBW
RBW	30 kHz
VBW	100 kHz
Detector	Peak
Trace	Max Hold
Sweep Time	Auto

### 5.3 DEVIATION FROM STANDARD

No deviation.

### 5.4 TEST SETUP

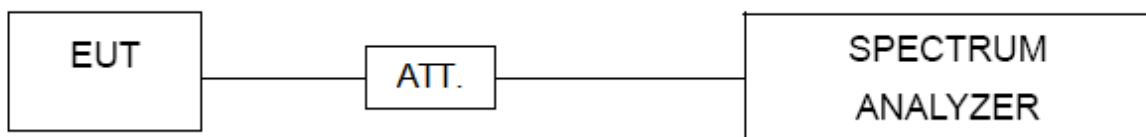

### 5.5 EUT OPERATION CONDITIONS

The EUT was programmed to be in continuously transmitting mode.

### 5.6 TEST RESULTS

Please refer to the APPENDIX E.

## 6. MAXIMUM OUTPUT POWER

### 6.1 LIMIT

Section	Test Item	Limit
FCC 15.247(b)(3)	Maximum Output Power	1.0000 watt or 30.00 dBm

### 6.2 TEST PROCEDURE

- a. The EUT was directly connected to the spectrum analyzer and antenna output port as show in the block diagram below.
- b. The following table is the setting of the spectrum analyzer:

Spectrum Parameters	Setting
Span Frequency	At least 1.5 times the OBW
RBW	1% to 5% of the OBW, not to exceed 1 MHz
VBW	$\geq 3 \times \text{RBW}$
Detector	RMS
Trace	Max Hold
Sweep Time	$\leq (\text{number of points in sweep}) \times T$ (Note)

Note: Where T is defined in 11.6 of ANSI C63.10-2013.

### 6.3 DEVIATION FROM STANDARD

No deviation.

### 6.4 TEST SETUP



### 6.5 EUT OPERATION CONDITIONS

The EUT was programmed to be in continuously transmitting mode.

### 6.6 TEST RESULTS

Please refer to the APPENDIX F.

**7. CONDUCTED SPURIOUS EMISSION**

**7.1 LIMIT**

In any 100 kHz bandwidth outside the frequency band in which the spread spectrum or digitally modulated intentional radiator is operating, the radio frequency power that is produced by the intentional radiator shall be at least 20 dB below that in the 100 kHz bandwidth within the band that contains the highest level of the desired power, based on either an RF conducted or a radiated measurement, provided the transmitter demonstrates compliance with the peak Output Power limits. If the transmitter complies with the Output Power limits based on the use of RMS averaging over a time interval, as permitted under paragraph (b)(3) of this section, the attenuation required under this paragraph shall be 30 dB instead of 20 dB. Attenuation below the general limits specified in Section 15.209(a) is not required.

**7.2 TEST PROCEDURE**

- a. The EUT was directly connected to the spectrum analyzer and antenna output port as show in the block diagram below.
- b. The following table is the setting of the spectrum analyzer:

Spectrum Parameters	Setting
Start Frequency	30 MHz
Stop Frequency	26.5 GHz
RBW	100 kHz
VBW	100 kHz
Detector	Peak
Trace	Max Hold
Sweep Time	Auto

**7.3 DEVIATION FROM STANDARD**

No deviation.

**7.4 TEST SETUP**

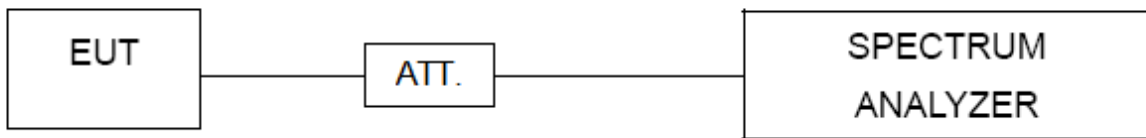

**7.5 EUT OPERATION CONDITIONS**

The EUT was programmed to be in continuously transmitting mode.

**7.6 TEST RESULTS**

Please refer to the APPENDIX G.

## 8. POWER SPECTRAL DENSITY

### 8.1 LIMIT

Section	Test Item	Limit
FCC 15.247(e)	Power Spectral Density	8 dBm (in any 3 kHz)

### 8.2 TEST PROCEDURE

- a. The EUT was directly connected to the spectrum analyzer and antenna output port as show in the block diagram below.
- b. The following table is the setting of the spectrum analyzer:

Spectrum Parameters	Setting
Span Frequency	2 MHz (1 Mbps)
RBW	3 kHz
VBW	10 kHz
Detector	Peak
Trace	Max Hold
Sweep Time	Auto

### 8.3 DEVIATION FROM STANDARD

No deviation.

### 8.4 TEST SETUP



### 8.5 EUT OPERATION CONDITIONS

The EUT was programmed to be in continuously transmitting mode.

### 8.6 TEST RESULTS

Please refer to the APPENDIX H.

## 9. MEASUREMENT INSTRUMENTS LIST

Radiated Emissions - 9 kHz to 30 MHz					
Item	Kind of Equipment	Manufacturer	Type No.	Serial No.	Calibrated until
1	Loop Antenna	EMCI	EMCI LPA600	275	Apr. 15, 2022
2	Cable	N/A	EMCRG400-BM-N M-10000	170628	Apr. 11, 2022
3	MXE EMI Receiver	Keysight	N9038A	MY57150106	Mar. 21, 2022
4	Measurement Software	Farad	EZ-EMC Ver.BTL-2ANT-1	N/A	N/A

Radiated Emissions - 30 MHz to 1 GHz					
Item	Kind of Equipment	Manufacturer	Type No.	Serial No.	Calibrated until
1	TRILOG Broadband Antenna	Schwarzbeck	VULB 9168	719	Mar. 26, 2022
2	Pre-Amplifier	emci	EMC9135	980400	Mar. 20, 2022
3	MXE EMI Receiver	Keysight	N9038A	MY57150106	Mar. 21, 2022
4	Test Cable	emci	EMC104-SM-SM-7 000	170330	Apr. 11, 2022
5	Test Cable	emci	EMC104-SM-SM-1 000	170331	Apr. 11, 2022
6	Test Cable	emci	EMC104-SM-NM-3 500	170621	Apr. 11, 2022
7	Measurement Software	Farad	EZ-EMC Ver.NB-03A1-01	N/A	N/A

Radiated Emissions - Above 1 GHz					
Item	Kind of Equipment	Manufacturer	Type No.	Serial No.	Calibrated until
1	Double-Ridged Waveguide Horn Antenna	ETS-Lindgren	9120D	9120D-1786	Mar. 26, 2022
2	Pre-Amplifier	emci	EMC012645SE	980421	May. 11, 2021 May. 10, 2022
3	EXA Spectrum Analyzer	Keysight	N9010A	MY56480545	Mar. 20, 2022
4	Test Cable	emci	EMC104-SM-SM-7 000	170330	Apr. 11, 2022
5	Test Cable	emci	EMC104-SM-SM-1 000	170331	Apr. 11, 2022
6	Test Cable	emci	EMC104-SM-NM-3 500	170621	Apr. 11, 2022
7	Measurement Software	Farad	EZ-EMC Ver.NB-03A1-01	N/A	N/A
8	MXE EMI Receiver	Keysight	N9038A	MY57150106	Mar. 21, 2022
9	Double-Ridged Waveguide Horn Antenna	ETS-Lindgren	3116C	00203919	Mar. 27, 2022
10	Pre-Amplifier	emci	EMC184045SE	980409	Mar. 20, 2022
11	Test Cable	emci	EMC102-KM-KM-8 00	170654	Apr. 15, 2022
12	Test Cable	emci	Super Reliable-40G-SS11- 7000	W0030860001	Apr. 15, 2022

Bandwidth					
Item	Kind of Equipment	Manufacturer	Type No.	Serial No.	Calibrated until
1	Spectrum Analyzer	R&S	FSP40	100626	Mar. 07, 2022
2	Attenuator	Solvang Technology	5.8GHz 0-65dB	STI02-0203-01	Aug. 23, 2021

Maximum Output Power					
Item	Kind of Equipment	Manufacturer	Type No.	Serial No.	Calibrated until
1	Spectrum Analyzer	R&S	FSP40	100626	Mar. 07, 2022
2	Attenuator	Solvang Technology	5.8GHz 0-65dB	STI02-0203-01	Aug. 23, 2021

Antenna Conducted Spurious Emissions					
Item	Kind of Equipment	Manufacturer	Type No.	Serial No.	Calibrated until
1	Spectrum Analyzer	R&S	FSP40	100626	Mar. 07, 2022
2	Attenuator	Solvang Technology	5.8GHz 0-65dB	STI02-0203-01	Aug. 23, 2021

Power Spectral Density					
Item	Kind of Equipment	Manufacturer	Type No.	Serial No.	Calibrated until
1	Spectrum Analyzer	R&S	FSP40	100626	Mar. 07, 2022
2	Attenuator	Solvang Technology	5.8GHz 0-65dB	STI02-0203-01	Aug. 23, 2021

Remark: "N/A" denotes no model name, serial no. or calibration specified.

All calibration period of equipment list is one year.

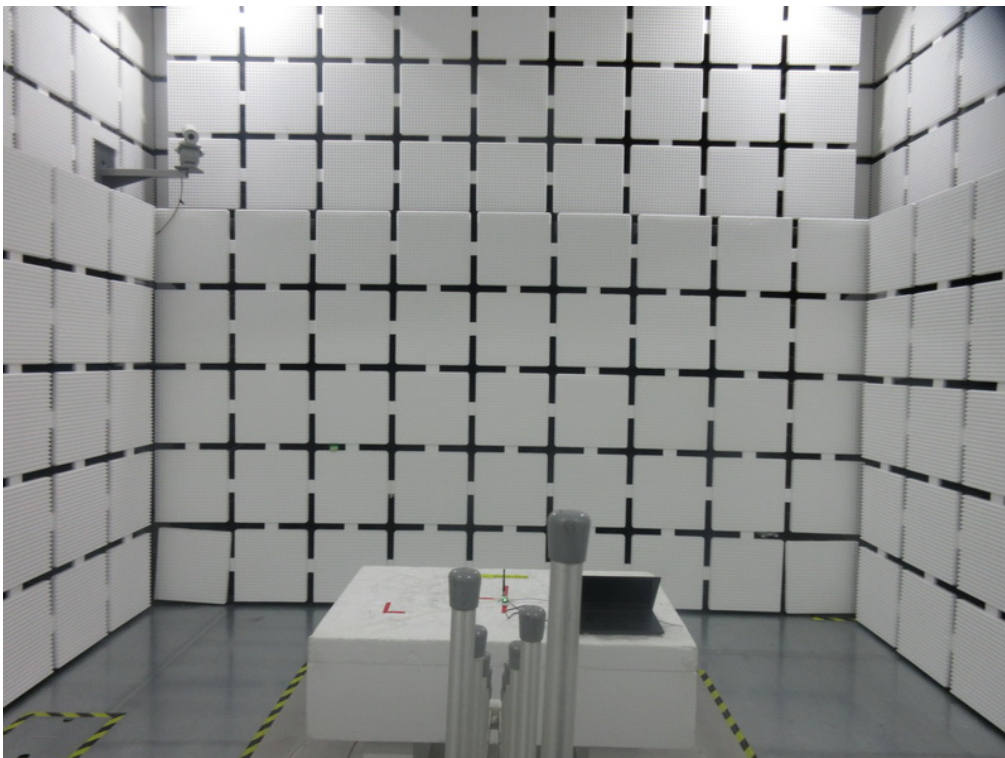
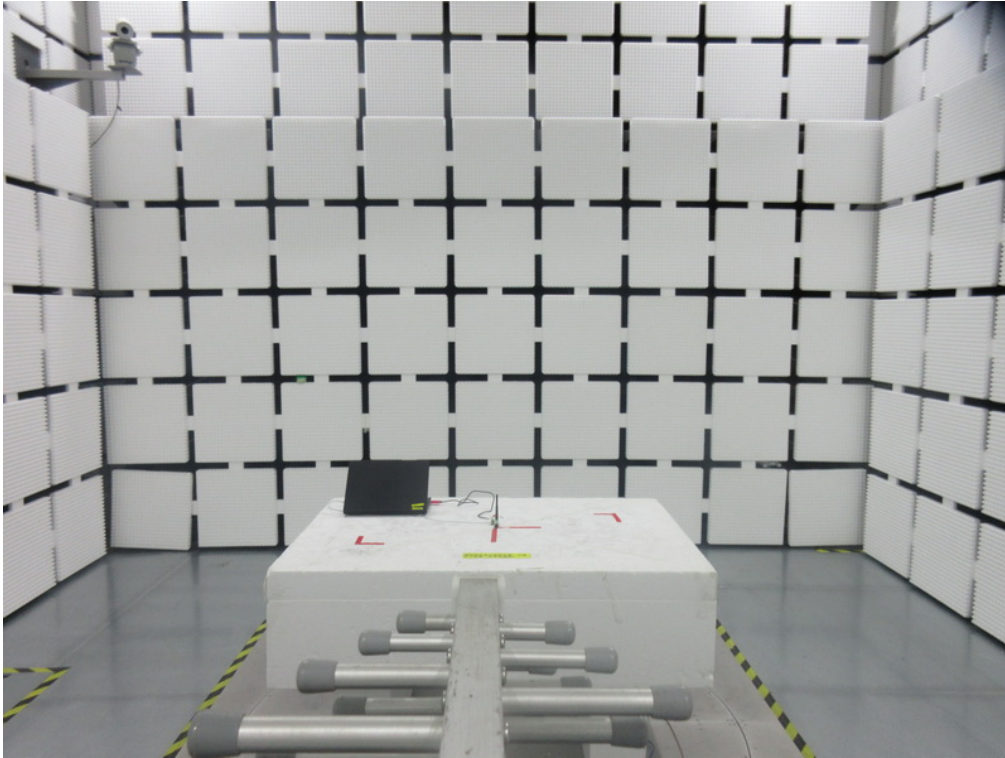

**10. EUT TEST PHOTO****Radiated Emissions Test Photos****30 MHz to 1000 MHz**

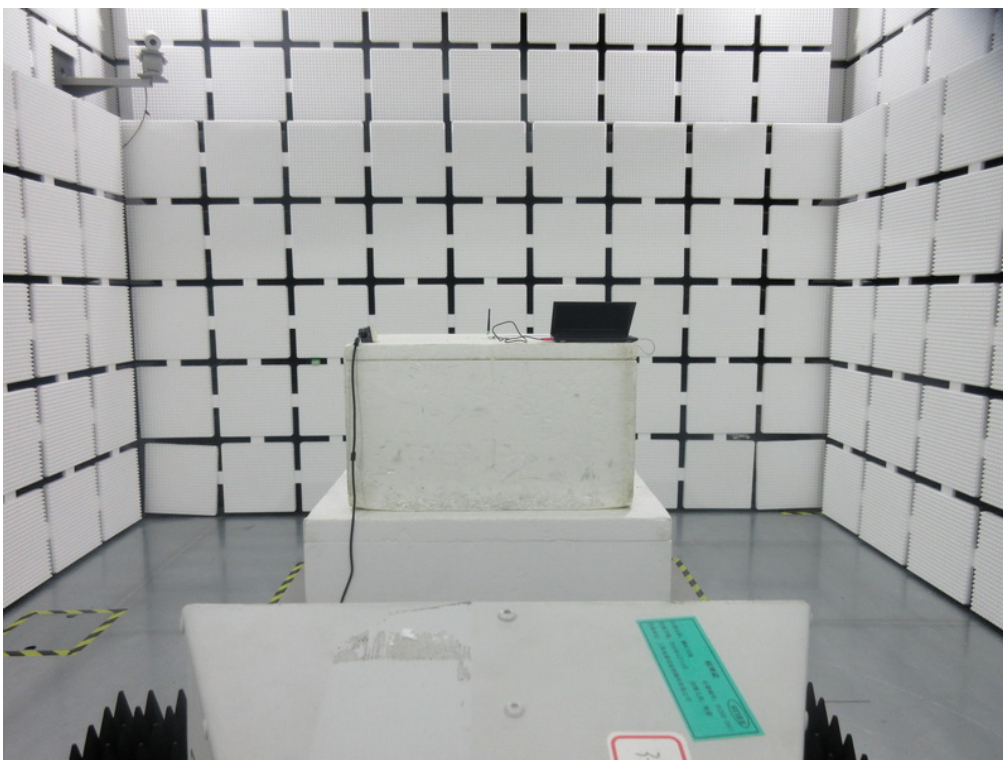
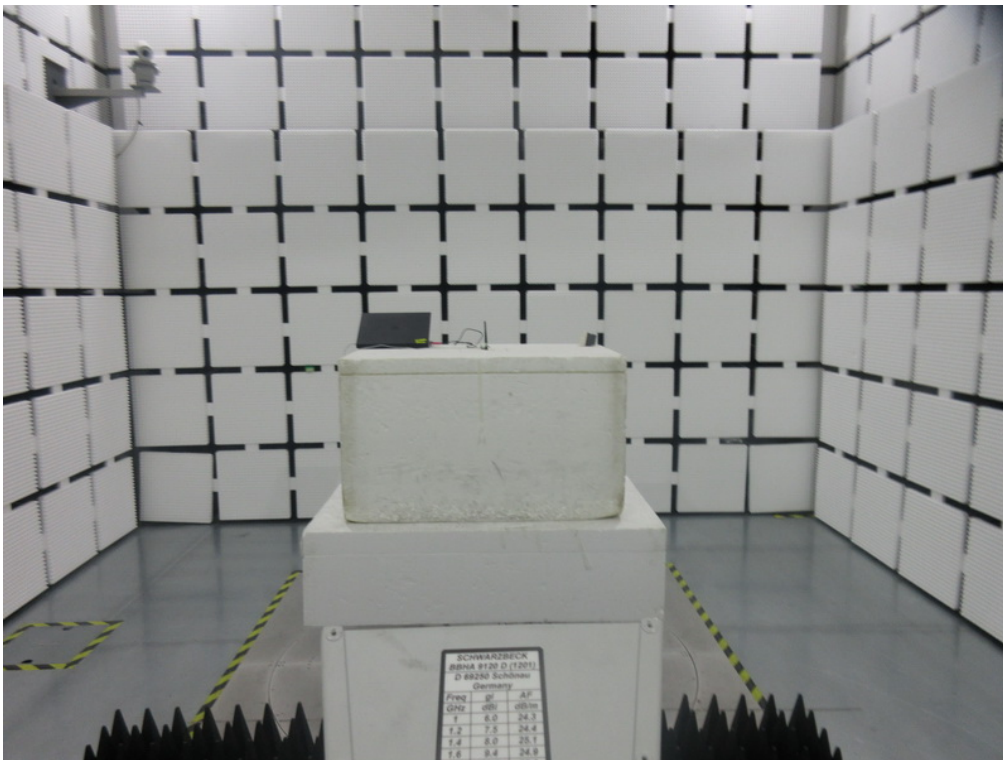
**Radiated Emissions Test Photos****Above 1 GHz**

**APPENDIX A - AC POWER LINE CONDUCTED EMISSIONS**

N/A

## **APPENDIX B - RADIATED EMISSION - 9 KHZ TO 30 MHZ**

Note: The measured value have enough margin over 20dB than the limit, therefore they are not reported.

**APPENDIX C - RADIATED EMISSION - 30 MHZ TO 1000 MHZ**

Test Mode	TX Mode_1Mbps Channel 00	Polarization	Vertical
-----------	--------------------------	--------------	----------

80 dBuV/m

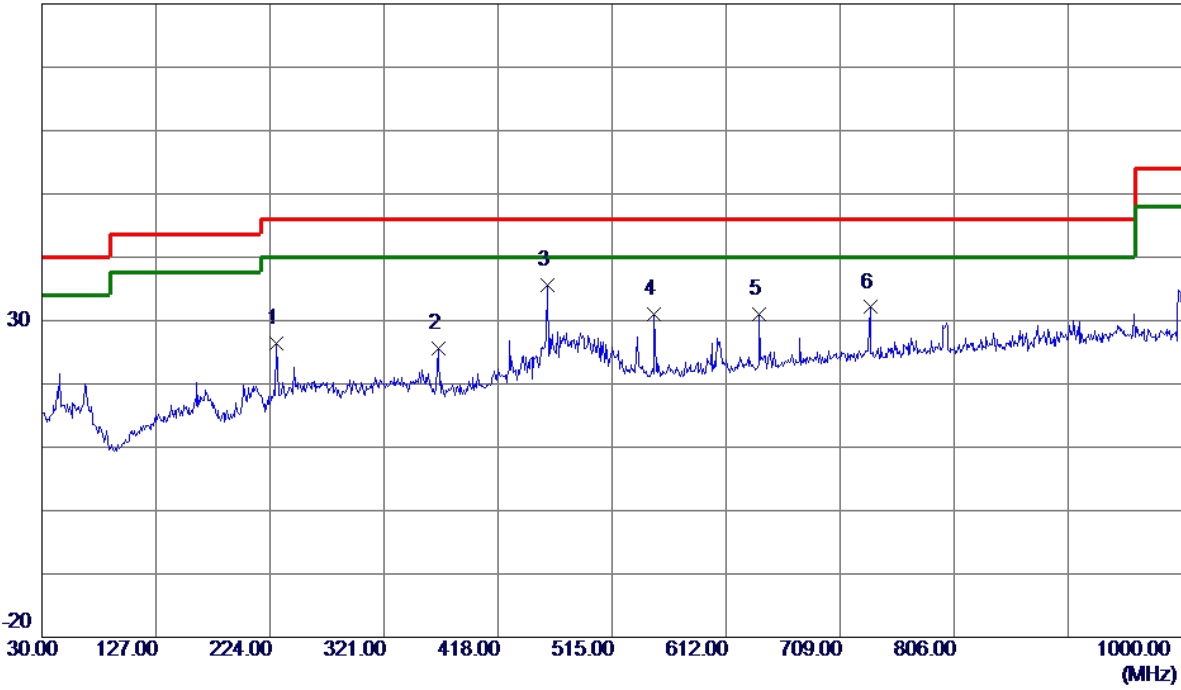

No.	Freq. MHz	Reading Level dBuV/m	Correct Factor dB	Measure ment dBuV/m	Limit dBuV/m	Margin dB	Detector	Comment
1	229.8200	45.30	-18.83	26.47	46.00	-19.53	Peak	
2	367.0750	39.84	-14.15	25.69	46.00	-20.31	Peak	
3 *	459.7100	47.39	-11.71	35.68	46.00	-10.32	Peak	
4	550.8900	41.51	-10.48	31.03	46.00	-14.97	Peak	
5	640.1300	39.74	-8.67	31.07	46.00	-14.93	Peak	
6	734.7050	39.51	-7.41	32.10	46.00	-13.90	Peak	

**REMARKS:**

- (1) Measurement Value = Reading Level + Correct Factor.
- (2) Margin Level = Measurement Value - Limit Value.

Test Mode	TX Mode_1Mbps Channel 00	Polarization	Horizontal
-----------	--------------------------	--------------	------------

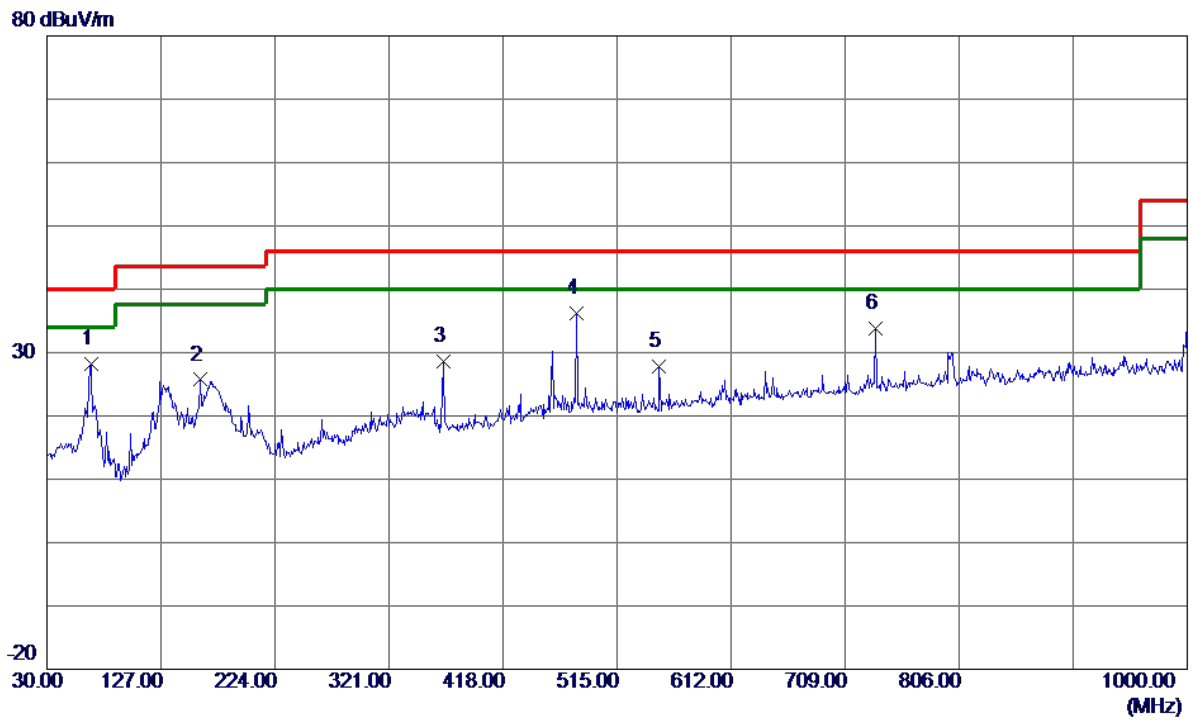

No.	Freq. MHz	Reading Level dBuV/m	Correct Factor dB	Measure ment dBuV/m	Limit dBuV/m	Margin dB	Detector	Comment
1	67.3450	46.30	-18.15	28.15	40.00	-11.85	Peak	
2	159.9800	41.75	-16.05	25.70	43.50	-17.80	Peak	
3	367.0750	42.75	-14.15	28.60	46.00	-17.40	Peak	
4 *	480.0800	47.74	-11.53	36.21	46.00	-9.79	Peak	
5	550.8900	38.29	-10.48	27.81	46.00	-18.19	Peak	
6	734.7050	41.19	-7.41	33.78	46.00	-12.22	Peak	

REMARKS:  
 (1) Measurement Value = Reading Level + Correct Factor.  
 (2) Margin Level = Measurement Value - Limit Value.

**APPENDIX D - RADIATED EMISSION - ABOVE 1000 MHZ**



Test Mode	TX 2402 MHz _CH00_1Mbps	Polarization	Vertical
-----------	-------------------------	--------------	----------

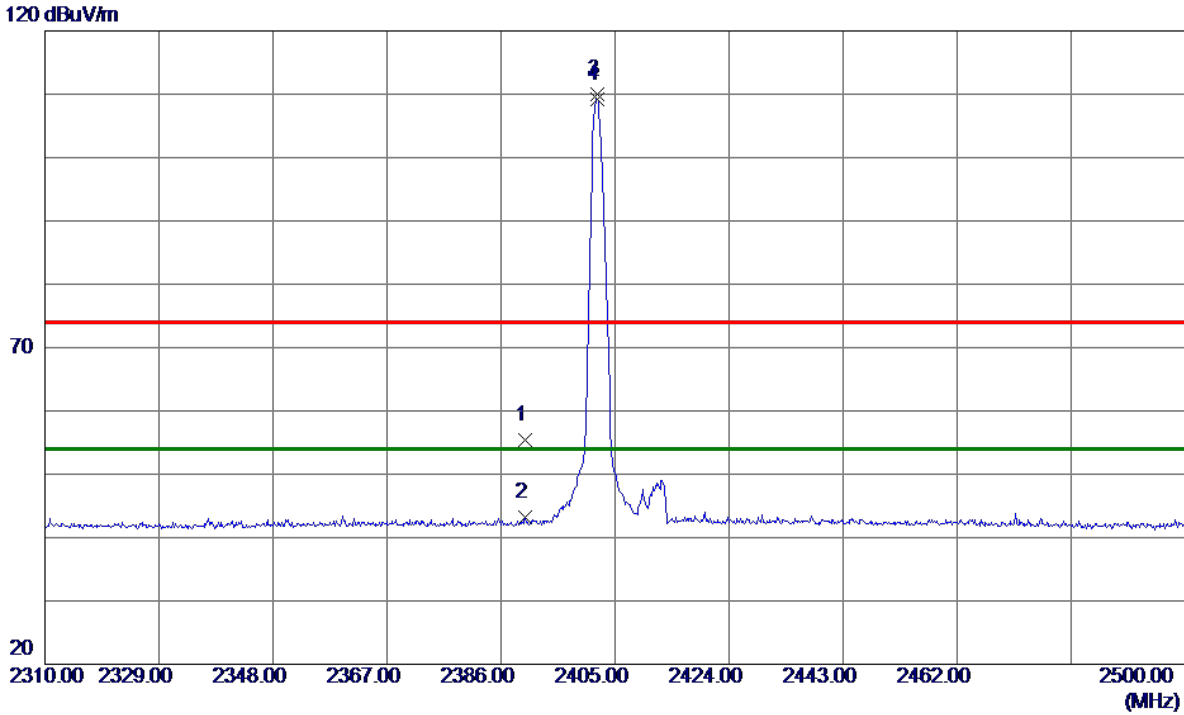

No.	Freq. MHz	Reading Level dBuV/m	Correct Factor dB	Measure ment dBuV/m	Limit dBuV/m	Margin dB	Detector	Comment
1	2389.9900	23.60	31.74	55.34	74.00	-18.66	Peak	
2	2389.9900	11.54	31.74	43.28	54.00	-10.72	AVG	
3	2402.0550	78.37	31.72	110.09	74.00	36.09	Peak	No limit
4 *	2402.0550	77.57	31.72	109.29	54.00	55.29	AVG	No limit

**REMARKS:**

- (1) Measurement Value = Reading Level + Correct Factor.
- (2) Margin Level = Measurement Value - Limit Value.

Test Mode	TX 2402 MHz _CH00_1Mbps	Polarization	Vertical
-----------	-------------------------	--------------	----------

80 dBuV/m

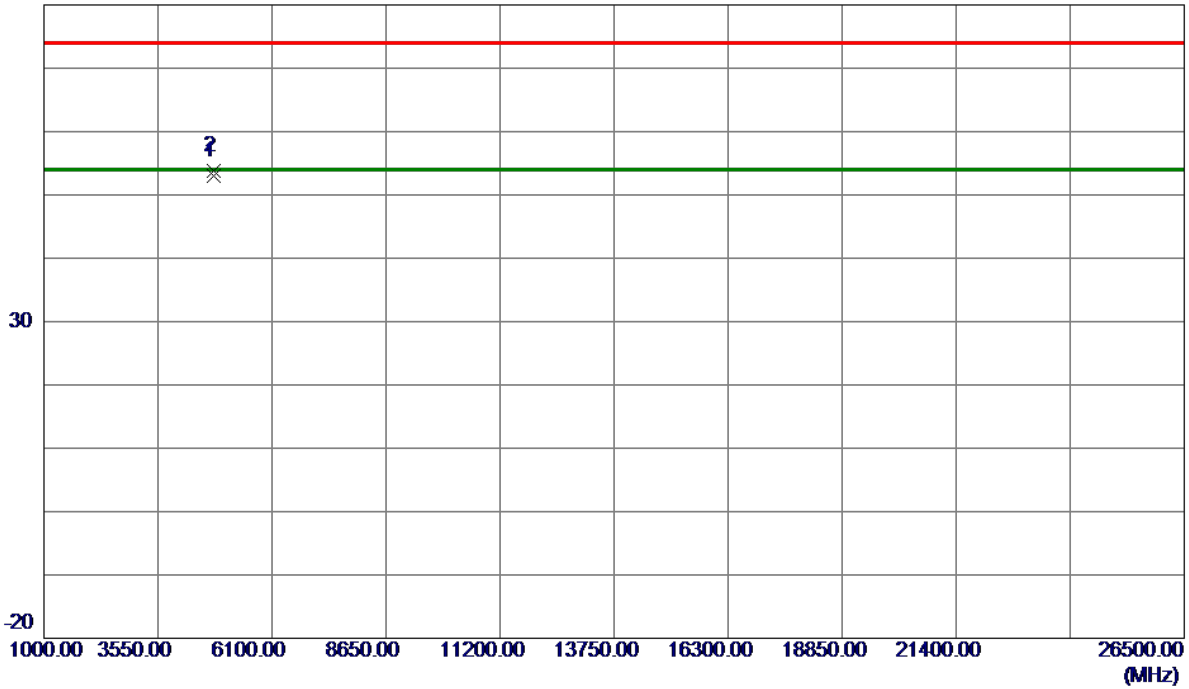

No.	Freq. MHz	Reading Level dBuV/m	Correct Factor dB	Measure ment dBuV/m	Limit dBuV/m	Margin dB	Detector	Comment
1 *	4803.9560	63.87	-10.95	52.92	54.00	-1.08	AVG	
2	4804.6000	64.81	-10.95	53.86	74.00	-20.14	Peak	

**REMARKS:**

- (1) Measurement Value = Reading Level + Correct Factor.
- (2) Margin Level = Measurement Value - Limit Value.

Test Mode	TX 2402 MHz _CH00_1Mbps	Polarization	Horizontal
-----------	-------------------------	--------------	------------

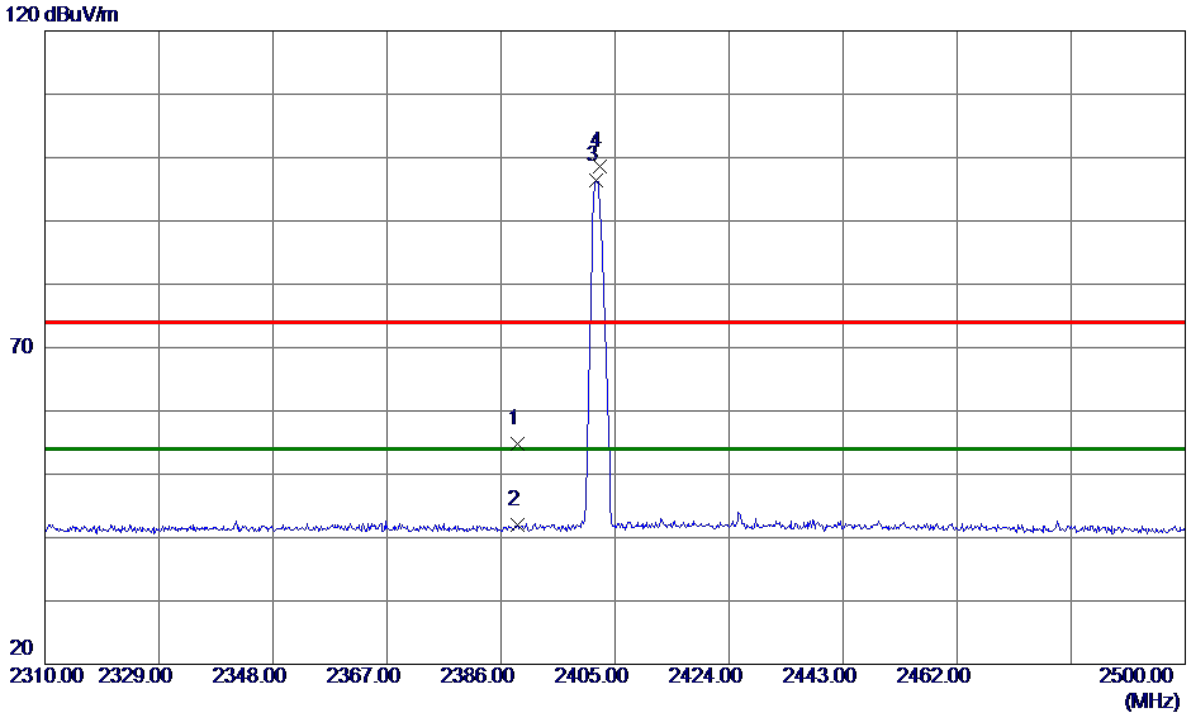

No.	Freq. MHz	Reading Level dBuV/m	Correct Factor dB	Measure ment dBuV/m	Limit dBuV/m	Margin dB	Detector	Comment
1	2388.6600	23.02	31.74	54.76	74.00	-19.24	Peak	
2	2388.6600	10.20	31.74	41.94	54.00	-12.06	AVG	
3 *	2401.7700	64.60	31.72	96.32	54.00	42.32	AVG	No limit
4	2402.4350	66.80	31.72	98.52	74.00	24.52	Peak	No limit

REMARKS:  
 (1) Measurement Value = Reading Level + Correct Factor.  
 (2) Margin Level = Measurement Value - Limit Value.

Test Mode	TX 2402 MHz _CH00_1Mbps	Polarization	Horizontal
-----------	-------------------------	--------------	------------

80 dBuV/m

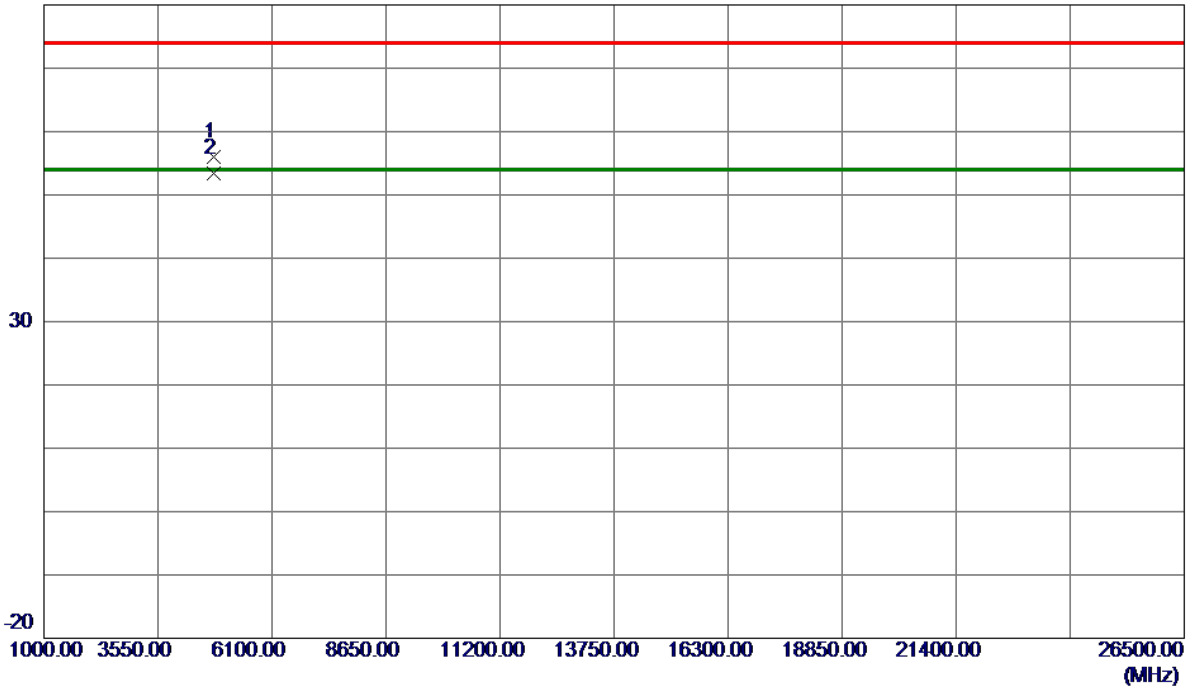

No.	Freq. MHz	Reading Level dBuV/m	Correct Factor dB	Measure ment dBuV/m	Limit dBuV/m	Margin dB	Detector	Comment
1	4803.3250	66.92	-10.95	55.97	74.00	-18.03	Peak	
2 *	4803.9570	64.42	-10.95	53.47	54.00	-0.53	AVG	

**REMARKS:**

- (1) Measurement Value = Reading Level + Correct Factor.
- (2) Margin Level = Measurement Value - Limit Value.

Test Mode	TX 2440 MHz _CH19_ 1Mbps	Polarization	Vertical
-----------	--------------------------	--------------	----------

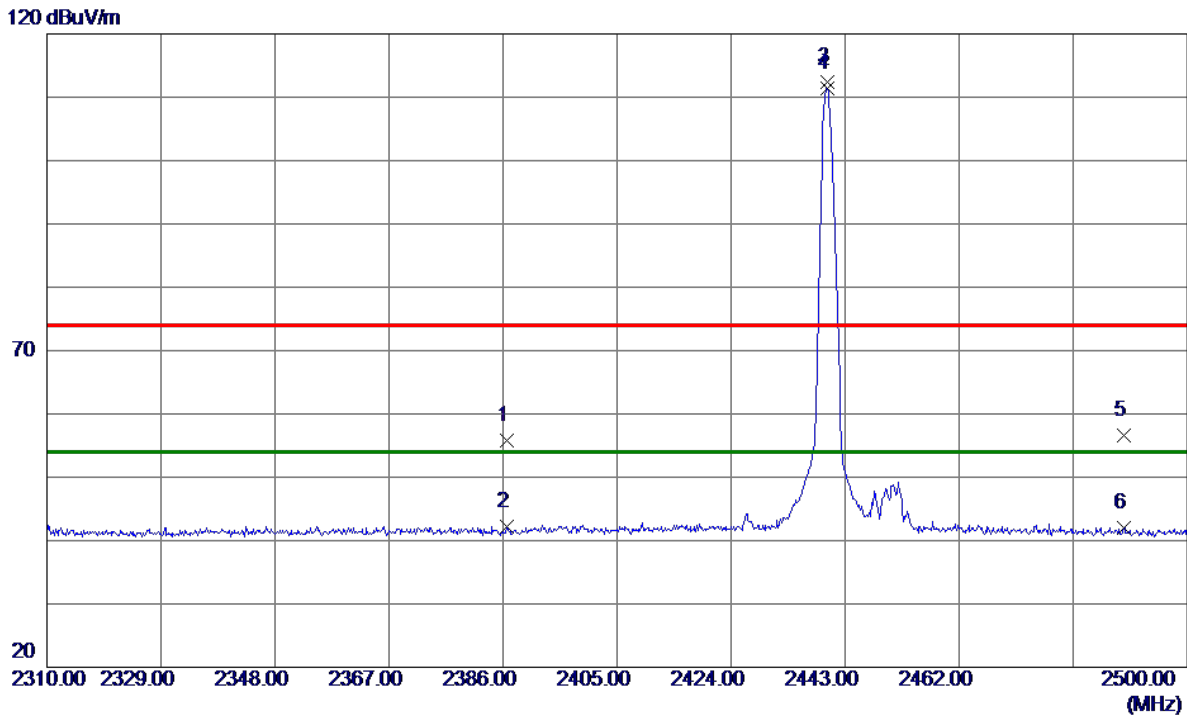

No.	Freq. MHz	Reading Level dBuV/m	Correct Factor dB	Measure ment dBuV/m	Limit dBuV/m	Margin dB	Detector	Comment
1	2386.5700	24.01	31.75	55.76	74.00	-18.24	Peak	
2	2386.5700	10.52	31.75	42.27	54.00	-11.73	AVG	
3	2439.9600	80.66	31.72	112.38	74.00	38.38	Peak	No limit
4 *	2439.9600	79.63	31.72	111.35	54.00	57.35	AVG	No limit
5	2489.4550	24.98	31.71	56.69	74.00	-17.31	Peak	
6	2489.4550	10.35	31.71	42.06	54.00	-11.94	AVG	

**REMARKS:**

- (1) Measurement Value = Reading Level + Correct Factor.
- (2) Margin Level = Measurement Value - Limit Value.

Test Mode	TX 2440 MHz _CH19_ 1Mbps	Polarization	Vertical
-----------	--------------------------	--------------	----------

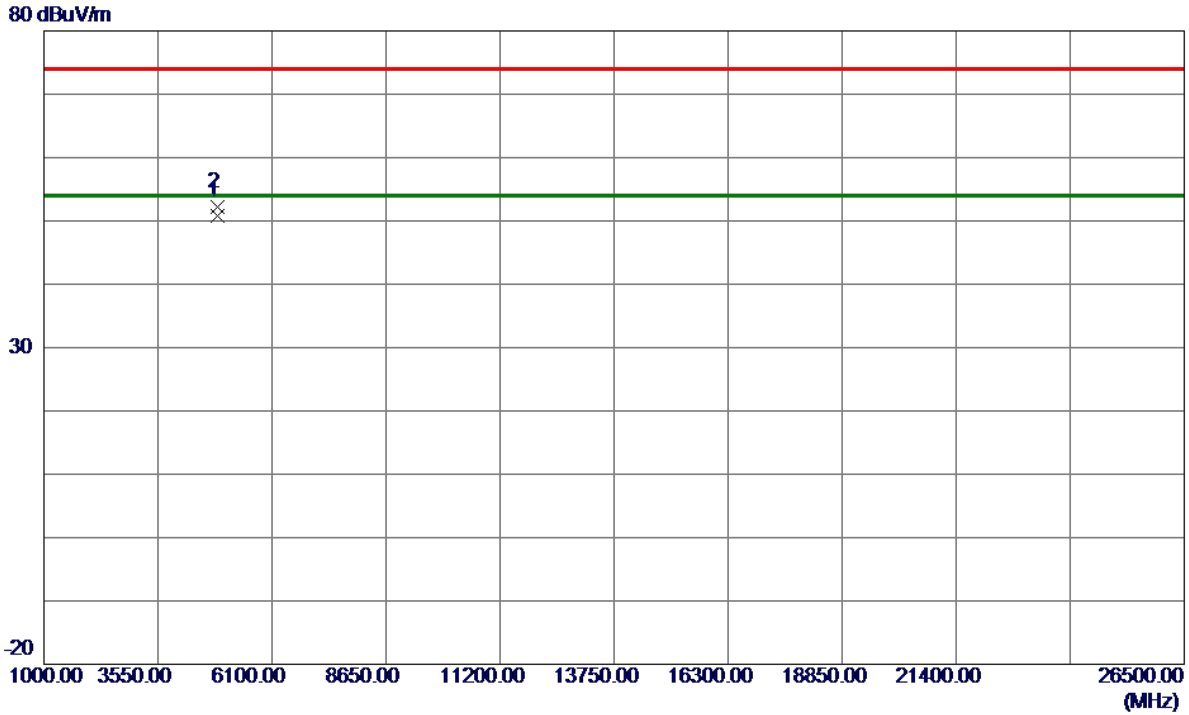

No.	Freq. MHz	Reading Level dBuV/m	Correct Factor dB	Measure ment dBuV/m	Limit dBuV/m	Margin dB	Detector	Comment
1 *	4880.0419	61.66	-10.78	50.88	54.00	-3.12	AVG	
2	4881.1000	62.98	-10.78	52.20	74.00	-21.80	Peak	

**REMARKS:**

- (1) Measurement Value = Reading Level + Correct Factor.
- (2) Margin Level = Measurement Value - Limit Value.

Test Mode	TX 2440 MHz _CH19_ 1Mbps	Polarization	Horizontal
-----------	--------------------------	--------------	------------

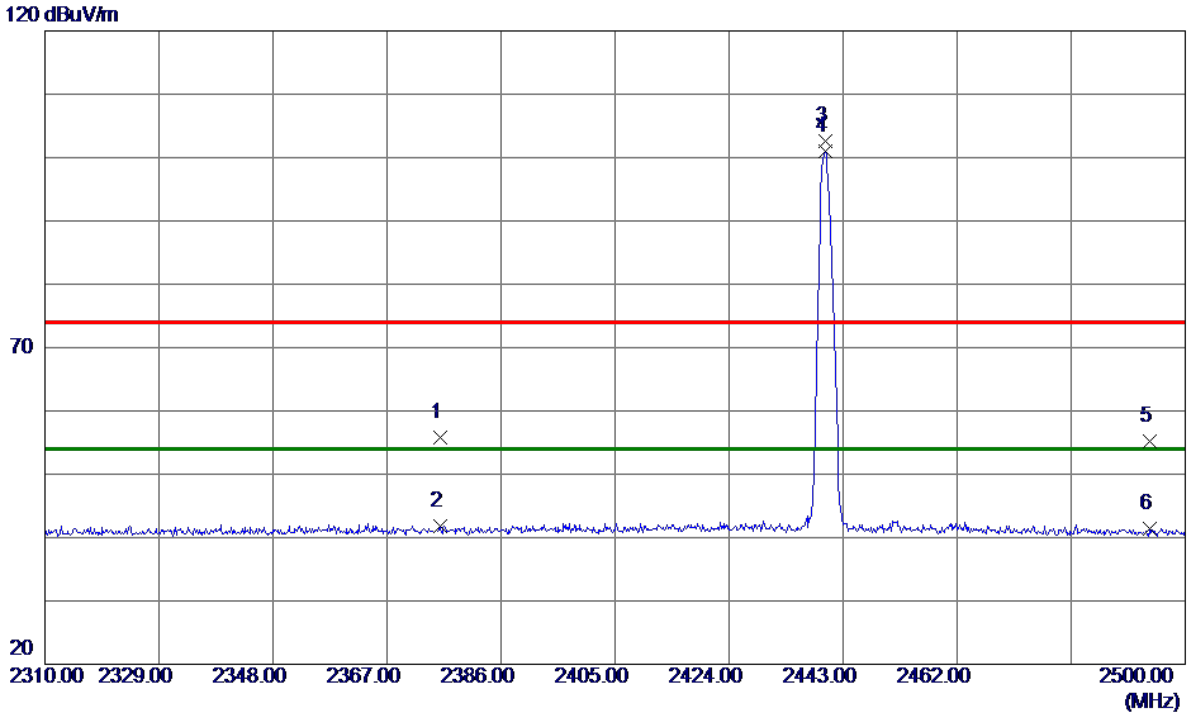

No.	Freq. MHz	Reading Level dBuV/m	Correct Factor dB	Measure ment dBuV/m	Limit dBuV/m	Margin dB	Detector	Comment
1	2375.8350	24.03	31.77	55.80	74.00	-18.20	Peak	
2	2375.8350	10.05	31.77	41.82	54.00	-12.18	AVG	
3	2440.0550	70.91	31.72	102.63	74.00	28.63	Peak	No limit
4 *	2440.0550	69.33	31.72	101.05	54.00	47.05	AVG	No limit
5	2494.0149	23.45	31.71	55.16	74.00	-18.84	Peak	
6	2494.0149	9.67	31.71	41.38	54.00	-12.62	AVG	

**REMARKS:**

- (1) Measurement Value = Reading Level + Correct Factor.
- (2) Margin Level = Measurement Value - Limit Value.

Test Mode	TX 2440 MHz _CH19_ 1Mbps	Polarization	Horizontal
-----------	--------------------------	--------------	------------

80 dBuV/m

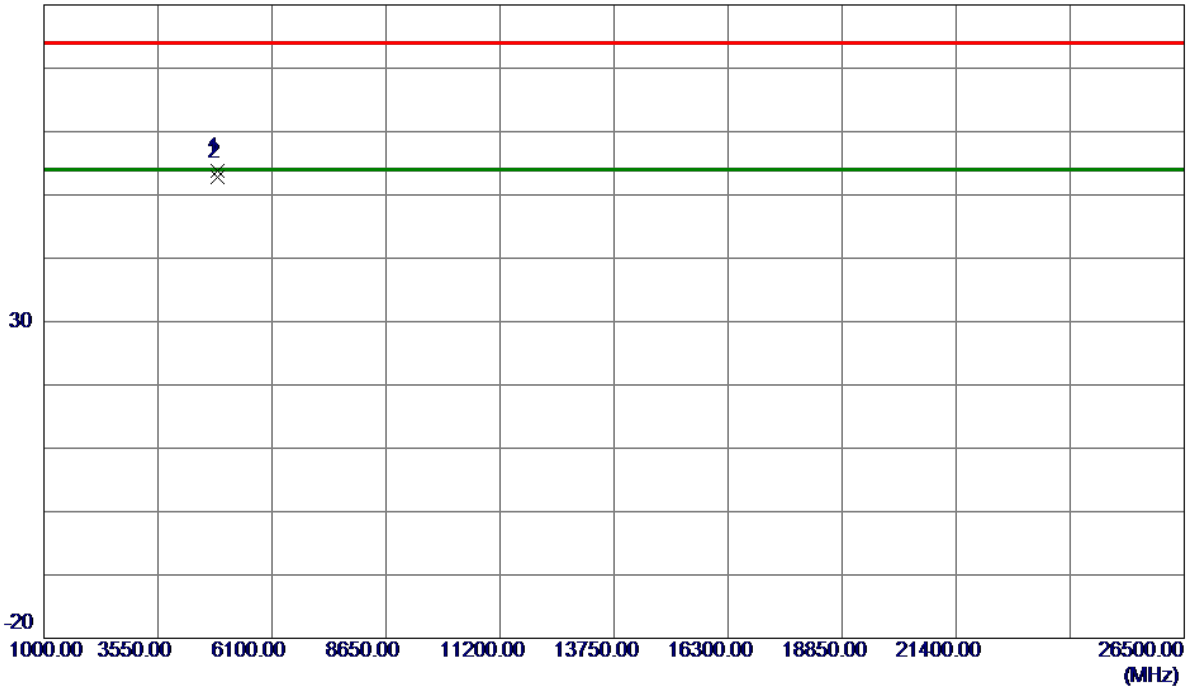

No.	Freq. MHz	Reading Level dBuV/m	Correct Factor dB	Measure ment dBuV/m	Limit dBuV/m	Margin dB	Detector	Comment
1	4879.8250	64.48	-10.78	53.70	74.00	-20.30	Peak	
2 *	4879.8630	63.59	-10.78	52.81	54.00	-1.19	AVG	

REMARKS:

- (1) Measurement Value = Reading Level + Correct Factor.
- (2) Margin Level = Measurement Value - Limit Value.



Test Mode	TX 2480 MHz _CH39_1Mbps	Polarization	Vertical
-----------	-------------------------	--------------	----------

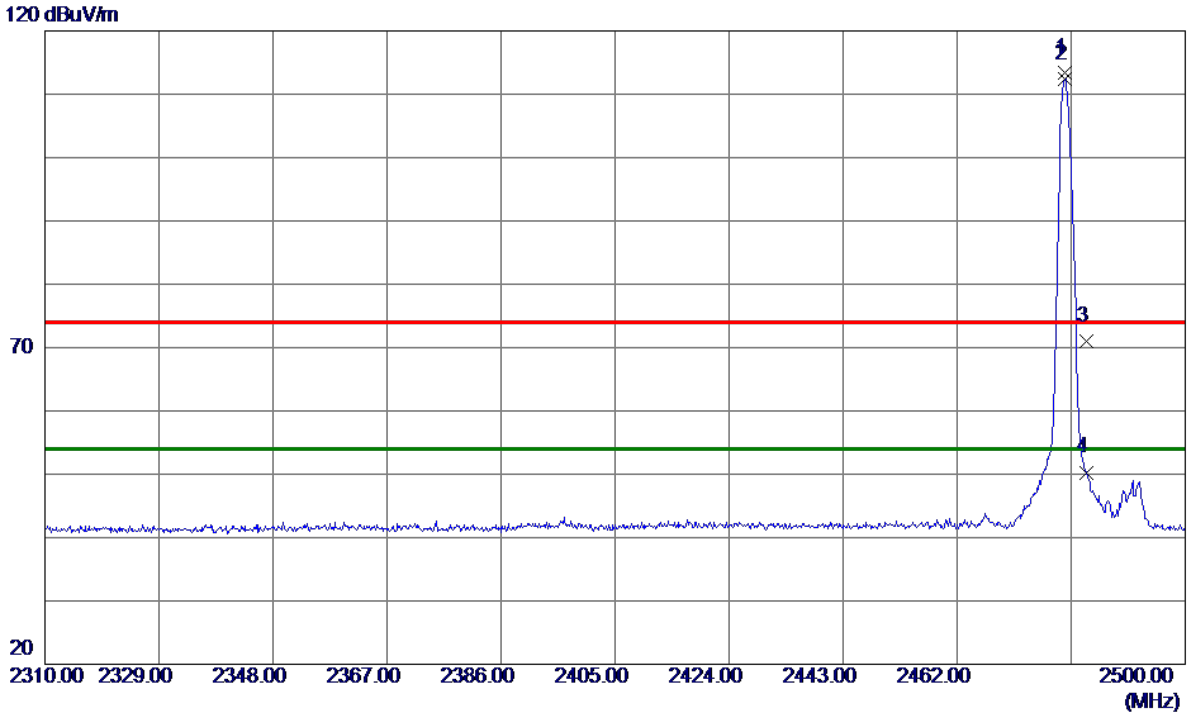

No.	Freq. MHz	Reading Level dBuV/m	Correct Factor dB	Measure ment dBuV/m	Limit dBuV/m	Margin dB	Detector	Comment
1	2479.9550	81.75	31.71	113.46	74.00	39.46	Peak	No limit
2 *	2479.9550	80.66	31.71	112.37	54.00	58.37	AVG	No limit
3	2483.5000	39.31	31.71	71.02	74.00	-2.98	Peak	
4	2483.5000	18.59	31.71	50.30	54.00	-3.70	AVG	

**REMARKS:**

- (1) Measurement Value = Reading Level + Correct Factor.
- (2) Margin Level = Measurement Value - Limit Value.

Test Mode	TX 2480 MHz _CH39_ 1Mbps	Polarization	Vertical
-----------	--------------------------	--------------	----------

80 dBuV/m

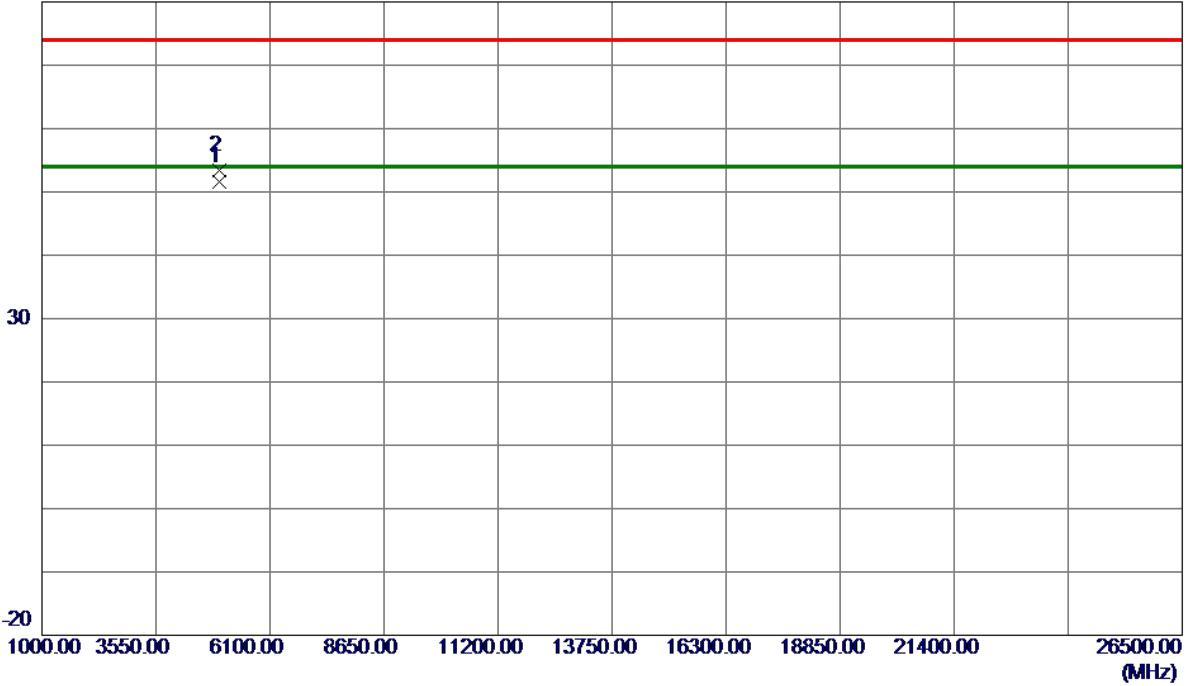

No.	Freq. MHz	Reading Level dBuV/m	Correct Factor dB	Measure ment dBuV/m	Limit dBuV/m	Margin dB	Detector	Comment
1 *	4960.0070	62.08	-10.46	51.62	54.00	-2.38	AVG	
2	4960.1500	63.79	-10.46	53.33	74.00	-20.67	Peak	

**REMARKS:**

- (1) Measurement Value = Reading Level + Correct Factor.
- (2) Margin Level = Measurement Value - Limit Value.

Test Mode	TX 2480 MHz _CH39_1Mbps	Polarization	Horizontal
-----------	-------------------------	--------------	------------

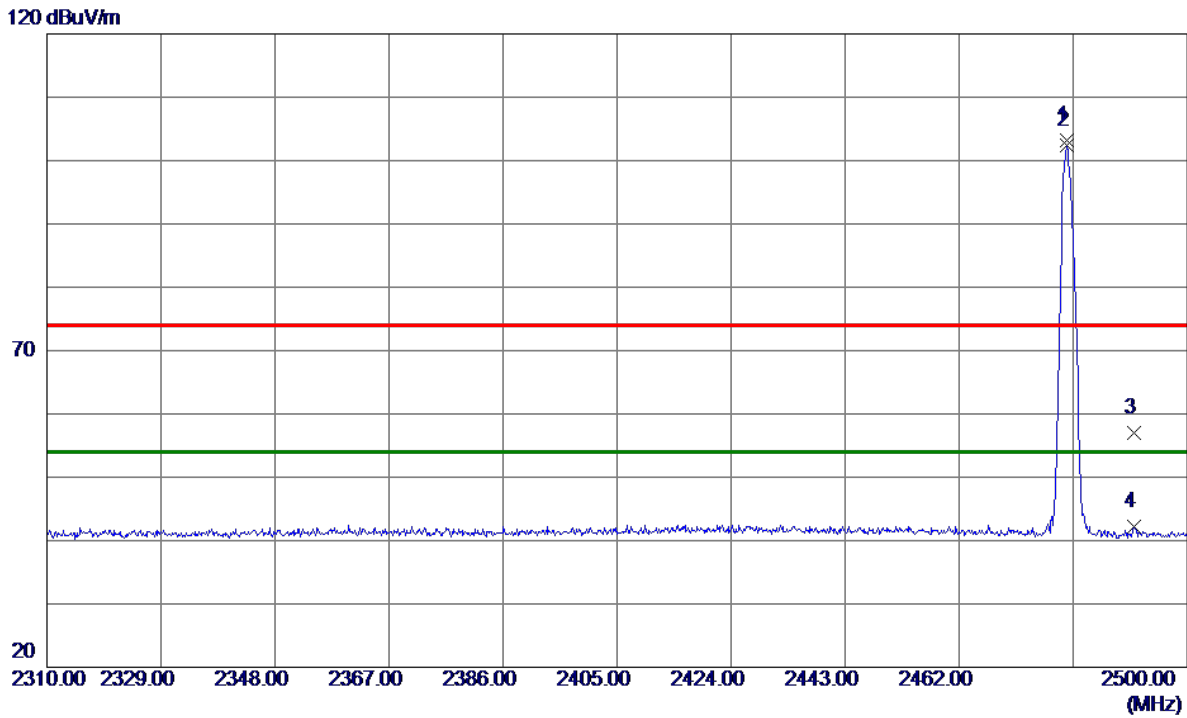

No.	Freq. MHz	Reading Level dBuV/m	Correct Factor dB	Measure ment dBuV/m	Limit dBuV/m	Margin dB	Detector	Comment
1	2479.9550	71.56	31.71	103.27	74.00	29.27	Peak	No limit
2 *	2479.9550	70.66	31.71	102.37	54.00	48.37	AVG	No limit
3	2491.1650	25.23	31.71	56.94	74.00	-17.06	Peak	
4	2491.1650	10.58	31.71	42.29	54.00	-11.71	AVG	

**REMARKS:**

- (1) Measurement Value = Reading Level + Correct Factor.
- (2) Margin Level = Measurement Value - Limit Value.

Test Mode	TX 2480 MHz _CH39_ 1Mbps	Polarization	Horizontal
-----------	--------------------------	--------------	------------

80 dBuV/m

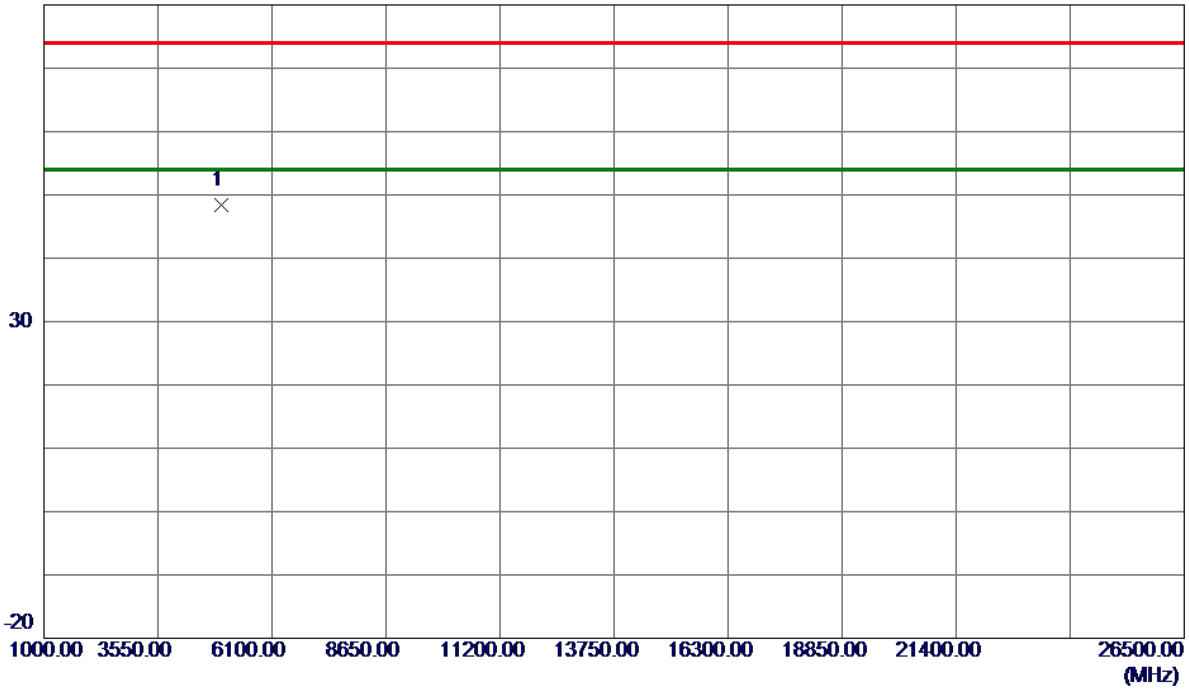

No.	Freq. MHz	Reading Level dBuV/m	Correct Factor dB	Measure ment dBuV/m	Limit dBuV/m	Margin dB	Detector	Comment
1 *	4960.1500	58.86	-10.46	48.40	74.00	-25.60	Peak	

**REMARKS:**

- (1) Measurement Value = Reading Level + Correct Factor.
- (2) Margin Level = Measurement Value - Limit Value.

## APPENDIX E - BANDWIDTH

Test Mode	TX Mode_1Mbps
-----------	---------------

Channel	Frequency (MHz)	6 dB Bandwidth (MHz)	99 % Occupied Bandwidth (MHz)	6 dB Bandwidth Min. Limit (MHz)	Test Result
00	2402	0.698	1.032	0.5	Pass
19	2440	0.710	1.032	0.5	Pass
39	2480	0.700	1.028	0.5	Pass

**CH00**

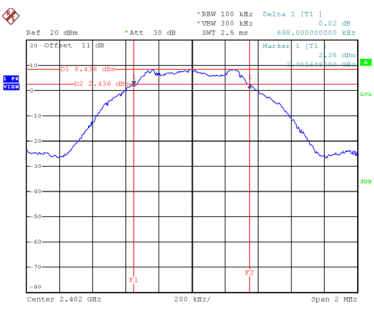

Date: 30.APR.2021 19:43:55

**CH19**

**6 dB Bandwidth**

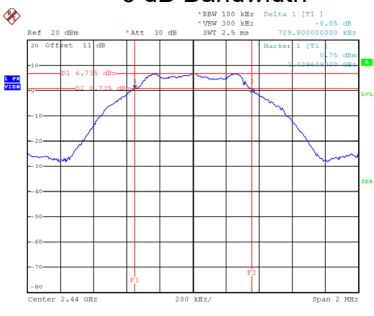

Date: 6.MAY.2021 18:03:16

**CH39**

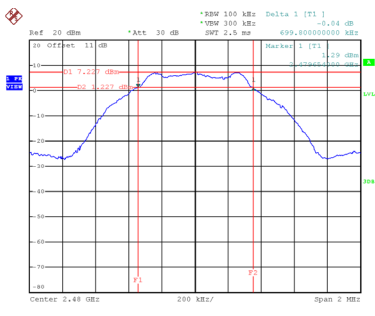

Date: 6.MAY.2021 18:06:01

**99 % Occupied Bandwidth**

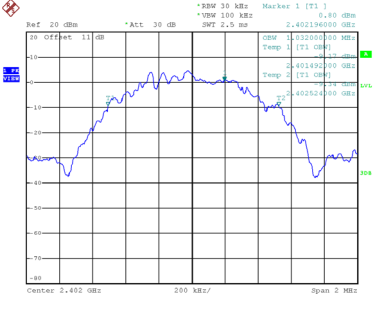

Date: 30.APR.2021 19:43:21

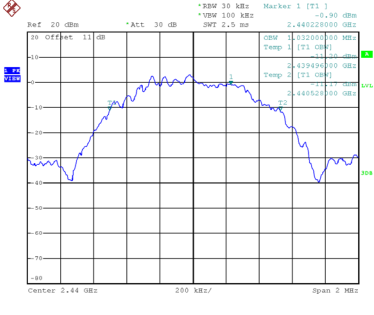

Date: 6.MAY.2021 18:03:22

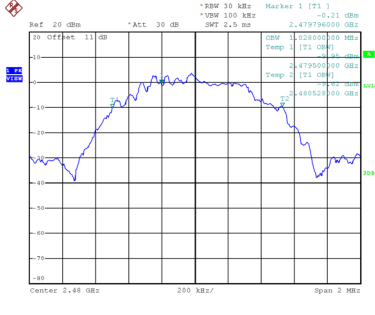

Date: 6.MAY.2021 18:06:07

## **APPENDIX F - MAXIMUM OUTPUT POWER**

Test Mode	TX Mode_1Mbps
-----------	---------------

Frequency (MHz)	Output Power (dBm)	Output Power (W)	Max. Limit (dBm)	Max. Limit (W)	Test Result
2402	8.86	0.0077	30.00	1.0000	Pass
2440	7.33	0.0054	30.00	1.0000	Pass
2480	7.79	0.0060	30.00	1.0000	Pass

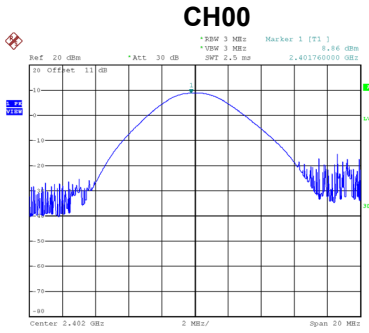

Date: 30.APR.2021 19:44:41

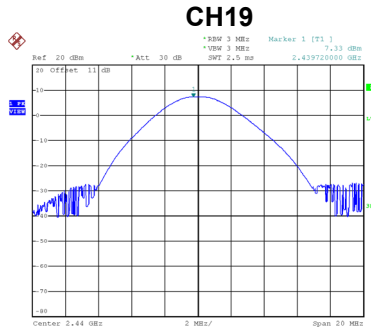

Date: 6.MAY.2021 18:04:09

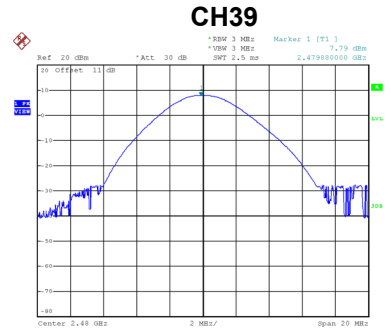

Date: 6.MAY.2021 18:06:53



## **APPENDIX G - CONDUCTED SPURIOUS EMISSION**

Test Mode TX Mode\_1Mbps

### Bandedge CH00 (Lower)

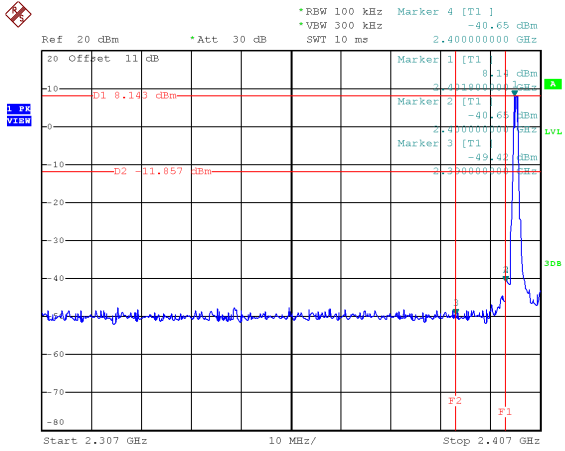

### Bandedge CH39 (Upper)

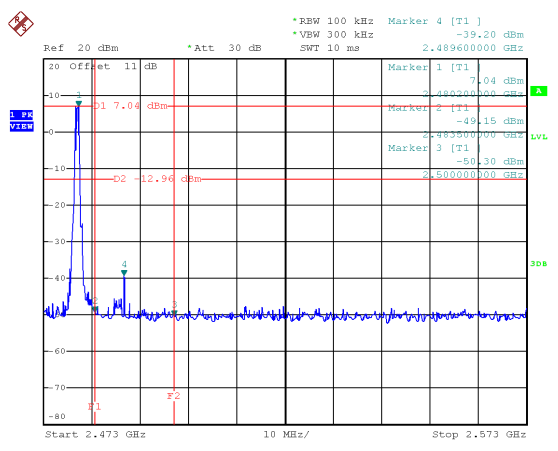

Date: 30.APR.2021 19:44:02

Date: 6.MAY.2021 18:06:14

### CH00 – 10th Harmonic of the fundamental frequency

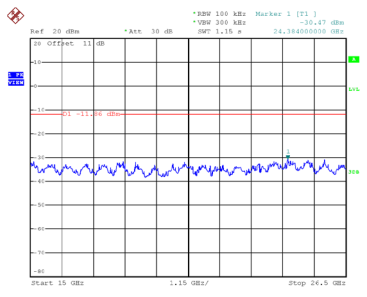
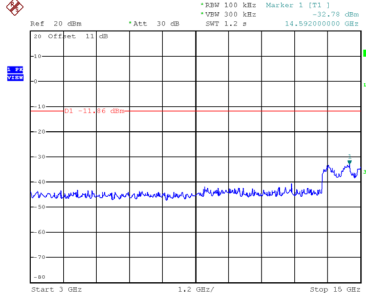
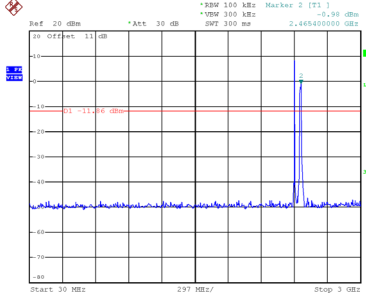

Date: 30.APR.2021 19:44:15

Date: 30.APR.2021 19:44:23

Date: 30.APR.2021 19:44:30

### CH19 – 10th Harmonic of the fundamental frequency

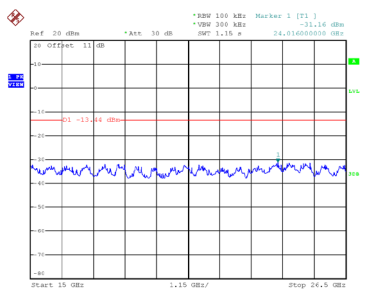
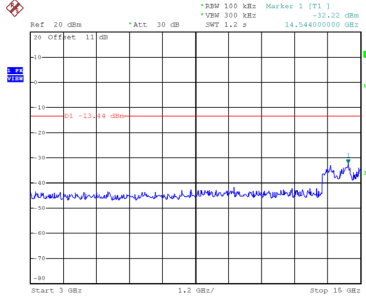
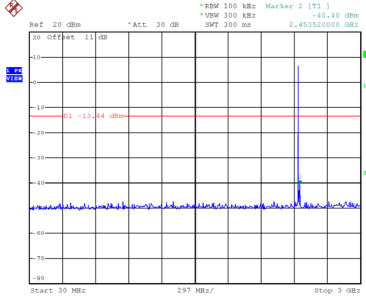

Date: 6.MAY.2021 18:03:43

Date: 6.MAY.2021 18:03:50

Date: 6.MAY.2021 18:03:57

### CH39 – 10th Harmonic of the fundamental frequency

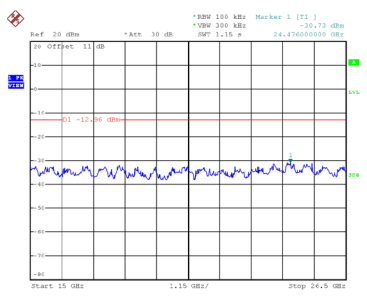
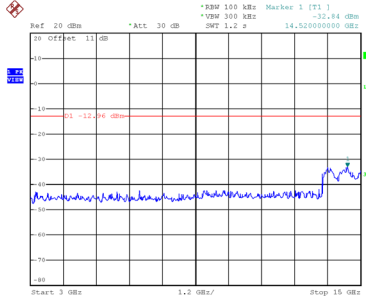
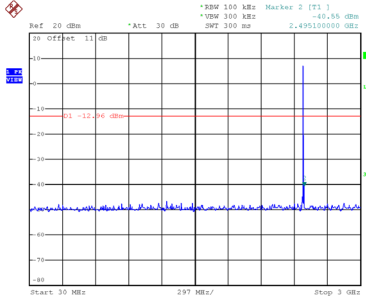

Date: 6.MAY.2021 18:06:27

Date: 6.MAY.2021 18:06:34

Date: 6.MAY.2021 18:06:42

## **APPENDIX H - POWER SPECTRAL DENSITY**

Test Mode	TX Mode_1Mbps
-----------	---------------

Channel	Frequency (MHz)	Power Spectral Density (dBm/3 kHz)	Max. Limit (dBm/3 kHz)	Test Result
00	2402	-5.85	8.00	Pass
19	2440	-7.64	8.00	Pass
39	2480	-7.07	8.00	Pass

**CH00**

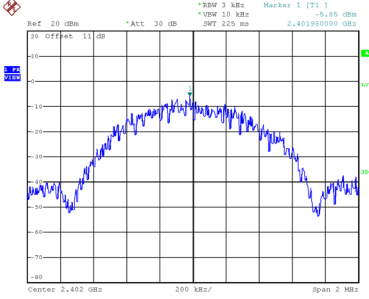

Date: 30.APR.2021 19:44:35

**CH19**

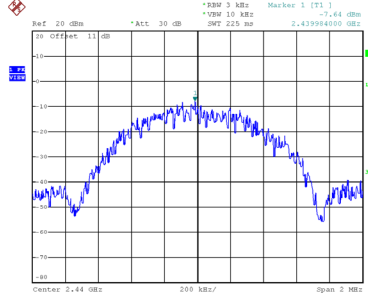

Date: 6.MAY.2021 18:04:03

**CH39**

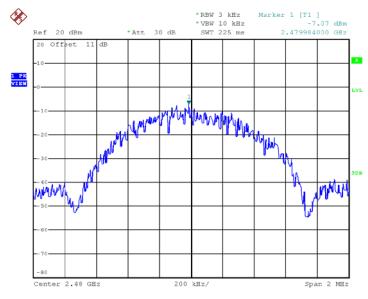

Date: 6.MAY.2021 18:06:47

**End of Test Report**