

FCC TEST REPORT
for
High-Flying Electronics Technology Co., Ltd.

HF-A21
Model No.: HF-A21

Prepared for : High-Flying Electronics Technology Co., Ltd.
Address : Room 1002, Building 1, No.3000, Longdong Avenue, Pudong
New Area, Shanghai, 201203, China

Prepared By : Shenzhen Anbotek Compliance Laboratory Limited
Address : 1/F., Building 1, SEC Industrial Park, No.0409 Qianhai Road,
Nanshan District, Shenzhen, Guangdong, China
Tel: (86) 755-26066544
Fax: (86) 755-26014772

Report Number : R011611208I
Date of Test : Nov. 04~ 29, 2016
Date of Report : Nov. 30, 2016

TABLE OF CONTENT

Description

Page

Test Report

1. GENERAL INFORMATION.....4

 1.1. Description of Device (EUT).....4

 1.2. Auxiliary Equipment Used during Test.....5

 1.3. Description of Test Facility.....5

 1.4. Measurement Uncertainty.....5

2. TEST METHODOLOGY.....6

 2.1. Summary of Test Results.....6

 2.2. Description of Test Modes.....6

 2.3. List of channels:.....7

3. CONDUCTED EMISSION TEST..... 8

 3.1. Block Diagram of Test Setup.....8

 3.2. Power Line Conducted Emission Measurement Limits (15.207).....8

 3.3. Configuration of EUT on Measurement.....8

 3.4. Operating Condition of EUT.....8

 3.5. Test Procedure.....9

 3.6. Test equipment.....9

 3.7. Power Line Conducted Emission Measurement Results.....9

4. FCC PART 15.247 REQUIREMENTS FOR DSSS & OFDM MODULATION..... 14

 4.1 Test Setup.....14

 4.2 6dB Bandwidth.....14

 4.3. Maximum Output Power Test.....22

 4.4. Band Edges Measurement.....26

 4.5. Peak Power Spectral Density.....62

 4.6. Radiated Emissions.....66

5. ANTENNA APPLICATION..... 77

 5.1. Antenna requirement.....77

 5.2. Result.....77

6. PHOTOGRAPH..... 78

 6.1. Photo of Conducted Emission Measurement.....78

 6.2. Photo of Radiation Emission Test.....78

APPENDIX I (EXTERNAL PHOTOS)..... 80

APPENDIX II (INTERNAL PHOTOS)..... 81

TEST REPORT

Applicant : High-Flying Electronics Technology Co., Ltd.
Manufacturer : High-Flying Electronics Technology Co., Ltd.
EUT : HF-A21
Model No. : HF-A21
Serial No. : N.A.
Trade Mark : High-Flying
Rating : DC 3.3V, 400mA max

Measurement Procedure Used:
FCC Part15 Subpart C 2016, Paragraph 15.247

The device described above is tested by Shenzhen Anbotek Compliance Laboratory Limited to determine the maximum emission levels emanating from the device and the severe levels of the device can endure and its performance criterion. The measurement results are contained in this test report and Shenzhen Anbotek Compliance Laboratory Limited is assumed full of responsibility for the accuracy and completeness of these measurements. Also, this report shows that the EUT (Equipment Under Test) is technically compliant with the FCC Part 15 Subpart C requirements.

This report applies to above tested sample only and shall not be reproduced in part without written approval of Shenzhen Anbotek Compliance Laboratory Limited.

Date of Test : Nov. 04~ 29, 2016

Prepared by : 
(Tested Engineer / Baron Wen)

Reviewer : 
(Project Manager / Amy Ding)

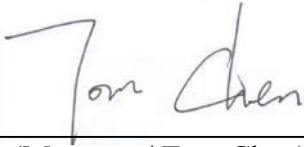
Approved & Authorized Signer : 
(Manager / Tom Chen)

1. GENERAL INFORMATION

1.1. Description of Device (EUT)

EUT : HF-A21

Model Number : HF-A21

Test Power Supply : AC 120V, 60Hz for adapter/
AC 240V, 60Hz for adapter

RF Transmission Frequency : 2412MHz~2462MHz (802.11b/802.11g/802.11n(HT20))
2422MHz~2452MHz (802.11n(HT40))

Channels : 11 For (802.11b/802.11g/802.11n(HT20))
7 For (802.11n(HT40))

Modulation : 802.11b CCK; 802.11g OFDM; 802.11n MCS

Antenna Gain: : 2dBi

Applicant : High-Flying Electronics Technology Co., Ltd.
Address : Room 1002, Building 1, No.3000, Longdong Avenue, Pudong New Area, Shanghai, 201203, China

Manufacturer : High-Flying Electronics Technology Co., Ltd.
Address : Room 1002, Building 1, No.3000, Longdong Avenue, Pudong New Area, Shanghai, 201203, China

Factory : High-Flying Electronics Technology Co., Ltd.
Address : Room 1002, Building 1, No.3000, Longdong Avenue, Pudong New Area, Shanghai, 201203, China

Date of receipt : Nov. 04, 2016
Date of Test : Nov. 04~ 29, 2016

1.2. Auxiliary Equipment Used during Test

Adapter : Model No.: FLD052-0501000C
Input: AC 100-240V, 50/60Hz, 0.15A Max
Output: DC 5.0V, 1.0A

1.3. Description of Test Facility

The test facility is recognized, certified, or accredited by the following organizations:

FCC-Registration No.: 752021

Shenzhen Anbotek Compliance Laboratory Limited, EMC Laboratory has been registered and fully described in a report filed with the (FCC) Federal Communications Commission. The acceptance letter from the FCC is maintained in our files. Registration 752021, July 06, 2016.

IC-Registration No.: 8058A-1

Shenzhen Anbotek Compliance Laboratory Limited., EMC Laboratory has been registered and fully described in a report filed with the (IC) Industry Canada. The acceptance letter from the IC is maintained in our files. Registration 8058A, Jun. 13, 2016.

Test Location

All Emissions tests were performed at Shenzhen Anbotek Compliance Laboratory Limited. at 1/F., Building 1, SEC Industrial Park, No.0409 Qianhai Road, Nanshan District, Shenzhen, Guangdong, China

1.4. Measurement Uncertainty

Radiation Uncertainty : Ur = 4.1 dB (Horizontal)
Ur = 4.3 dB (Vertical)
Conduction Uncertainty : Uc = 3.4dB

2. TEST METHODOLOGY

The tests documented in this report were performed in accordance with ANSI C63.10: 2013 and FCC Part 15, Paragraph 15.247.

2.1. Summary of Test Results

The EUT has been tested according to the following specifications:

Standard	Test Type	Result	Notes
FCC Part 15, Paragraph 15.107, 15.207	Conducted Emission Test	PASS	Complies
FCC Part 15, Paragraph 15.247(b)(1)	Maximum Output Power	PASS	Complies
FCC Part 15, Paragraph 15.247(a)(2)	6dB Bandwidth	PASS	Complies
FCC Part 15, Paragraph 15.247(c)	100kHz Bandwidth of Frequency Band Edges	PASS	Complies
FCC Part 15, Paragraph 15.209(a)(f)	Spurious Emission	PASS	Complies
FCC Part 15, Paragraph 15.247(a)(1)	Frequency Separation	-	N/A
FCC Part 15, Paragraph 15.247(a)(1)(iii)	Number of Hopping Frequency	-	N/A
FCC Part 15, Paragraph 15.247(a)(1)(iii)	Time of Occupancy	-	N/A
FCC Part 15, Paragraph 15.247(c)	Peak Power Density	PASS	Complies

2.2. Description of Test Modes

The EUT has been tested under operating condition.

Software used to control the EUT for staying in continuous transmitting and receiving mode is programmed.

IEEE802.11b: Channel 1(2412MHz), Channel 6(2437MHz) and Channel 11(2462MHz) with 1 Mbps lowest data rate (worst case) are chosen for the final testing.

IEEE802.11g: Channel 1(2412MHz), Channel 6(2437MHz) and Channel 11(2462MHz) with 6 Mbps lowest data rate (the worst case) are chosen for the final testing.

IEEE802.11n (HT20): Channel 1(2412MHz), Channel 6(2437MHz) and Channel 11(2462MHz) with MCS 0 Mbps lowest data rate (the worst case) are chosen for the final testing.

IEEE802.11n (HT40): Channel 3(2422MHz), Channel 6(2437MHz) and Channel 9(2452MHz) with MCS 0 Mbps lowest data rate (the worst case) are chosen for the final testing.

2.3. List of channels:

√ - available

X - tested

Number	Frequency(MHz)		802.11 b/g/n (HT20)	802.11 b/g/n (HT40)
1	2412	√	X	
2	2417	√		
3	2422	√		X
4	2427	√		
5	2432	√		
6	2437	√	X	X
7	2442	√		
8	2447	√		
9	2452	√		X
10	2457	√		
11	2462	√	X	

3. Conducted Emission Test

3.1. Block Diagram of Test Setup

3.1.1. Block diagram of connection between the EUT and simulators

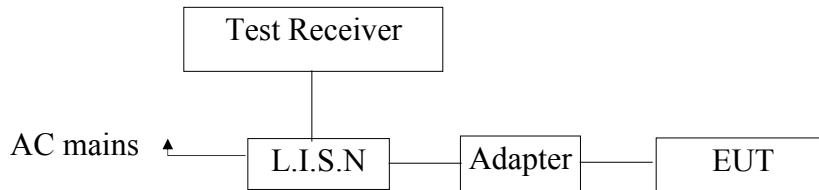

3.2. Power Line Conducted Emission Measurement Limits (15.207)

Frequency MHz	Limits dB(μV)	
	Quasi-peak Level	Average Level
0.15 ~ 0.50	66 ~ 56*	56 ~ 46*
0.50 ~ 5.00	56	46
5.00 ~ 30.00	60	50

Notes: 1. *Decreasing linearly with logarithm of frequency.
2. The lower limit shall apply at the transition frequencies.

3.3. Configuration of EUT on Measurement

The following equipments are installed on Power Line Conducted Emission Measurement to meet the commission requirement and operating regulations in a manner which tends to maximize its emission characteristics in a normal application.

3.4. Operating Condition of EUT

- 3.4.1. Setup the EUT and simulator as shown as Section 3.1.
- 3.4.2. Turn on the power of all equipment.
- 3.4.3. Let the EUT work in test mode (WiFi Mode) and measure it.

3.5. Test Procedure

The EUT system is connected to the power mains through a line impedance stabilization network (L.I.S.N.). This provides a 50ohm coupling impedance for the EUT system. Please refer the block diagram of the test setup and photographs. Both sides of AC line are checked to find out the maximum conducted emission. In order to find the maximum emission levels, the relative positions of equipment and all of the interface cables shall be changed according to FCC ANSI C63.10-2013 on Conducted Emission Measurement.

The bandwidth of test receiver (ESCI) set at 9KHz.

The frequency range from 150KHz to 30MHz is checked.

The test results are reported on Section 3.6.

3.6. Test equipment

Item	Equipment	Manufacturer	Model No.	Serial No.	Last Cal.	Cal. Interval
1.	Two-Line V-network	Rohde & Schwarz	ENV216	100055	Jul. 19, 2016	1 Year
2.	EMI Test Receiver	Rohde & Schwarz	ESCI	100627	Jun. 17, 2016	1 Year
3.	RF Switching Unit	Compliance Direction	RSU-M2	38303	Jun. 17, 2016	1 Year

3.7. Power Line Conducted Emission Measurement Results

PASS.

The frequency range from 150KHz to 30 MHz is investigated.

Please refer the following pages.

CONDUCTED EMISSION TEST DATA

Test Site: 1# Shielded Room
 Operating Condition: WiFi Mode
 Test Specification: AC 120V, 60Hz for adapter
 Comment: Live Line
 Tem.:25°C Hum.:50%

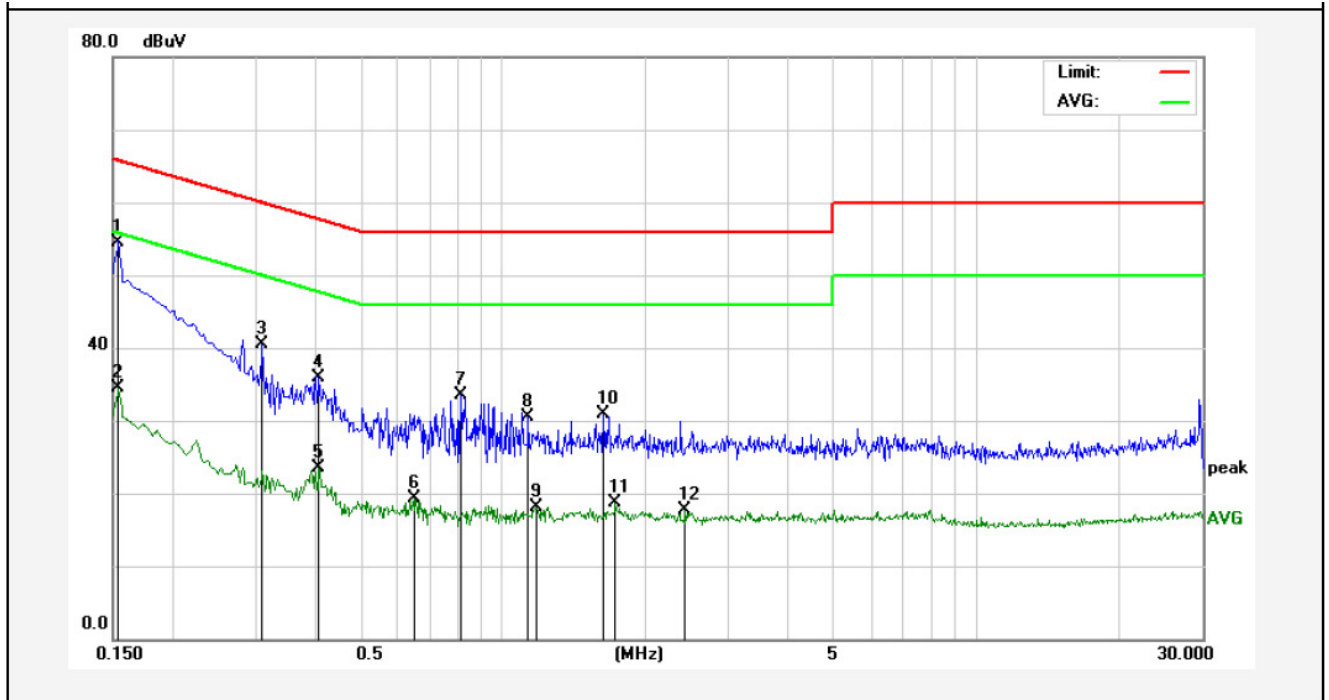

No.	Freq. (MHz)	Reading (dBuV)	Factor (dB)	Result (dBuV)	Limit dBuV	Over Limit (dB)	Detector	Remark
1	0.1539	34.70	19.90	54.60	65.78	-11.18	QP	
2	0.1539	14.54	19.90	34.44	55.78	-21.34	AVG	
3	0.3100	20.52	19.89	40.41	59.97	-19.56	QP	
4	0.4100	15.88	19.94	35.82	57.65	-21.83	QP	
5	0.4100	3.64	19.94	23.58	47.65	-24.07	AVG	
6	0.6540	-0.77	20.03	19.26	46.00	-26.74	AVG	
7	0.8139	13.36	20.07	33.43	56.00	-22.57	QP	
8	1.1340	10.43	20.12	30.55	56.00	-25.45	QP	
9	1.1820	-2.03	20.12	18.09	46.00	-27.91	AVG	
10	1.6340	10.73	20.13	30.86	56.00	-25.14	QP	
11	1.7260	-1.43	20.13	18.70	46.00	-27.30	AVG	
12	2.4260	-2.43	20.15	17.72	46.00	-28.28	AVG	

CONDUCTED EMISSION TEST DATA

Test Site: 1# Shielded Room
 Operating Condition: WiFi Mode
 Test Specification: AC 120V, 60Hz for adapter
 Comment: Neutral Line
 Tem.:25°C Hum.:50%

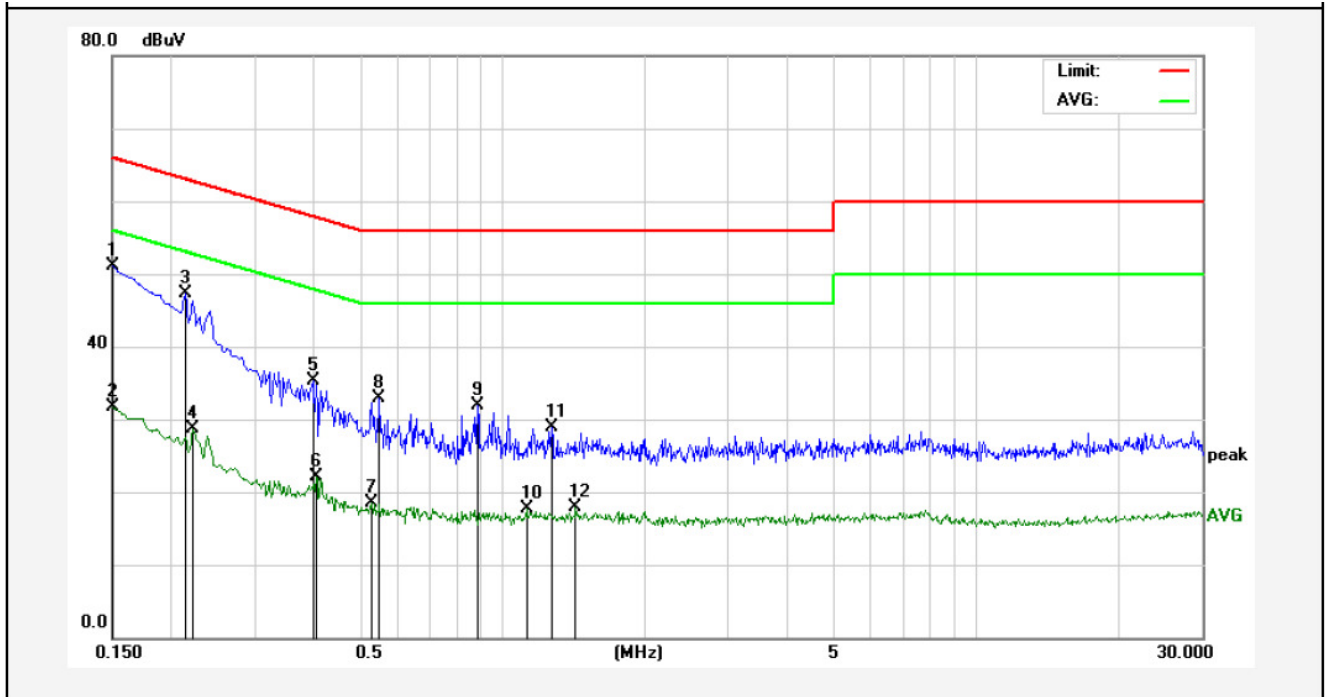

No.	Freq. (MHz)	Reading (dBuV)	Factor (dB)	Result (dBuV)	Limit dBuV	Over Limit (dB)	Detector	Remark
1	0.1500	31.29	19.90	51.19	65.99	-14.80	QP	
2	0.1500	11.81	19.90	31.71	55.99	-24.28	AVG	
3	0.2140	27.39	19.90	47.29	63.04	-15.75	QP	
4	0.2220	8.72	19.90	28.62	52.74	-24.12	AVG	
5	0.3980	15.43	19.93	35.36	57.89	-22.53	QP	
6	0.4060	2.11	19.94	22.05	47.73	-25.68	AVG	
7	0.5299	-1.41	19.99	18.58	46.00	-27.42	AVG	
8	0.5500	12.94	19.99	32.93	56.00	-23.07	QP	
9	0.8860	11.83	20.09	31.92	56.00	-24.08	QP	
10	1.1260	-2.43	20.12	17.69	46.00	-28.31	AVG	
11	1.2740	8.73	20.13	28.86	56.00	-27.14	QP	
12	1.4260	-2.25	20.13	17.88	46.00	-28.12	AVG	

CONDUCTED EMISSION TEST DATA

Test Site: 1# Shielded Room
 Operating Condition: WiFi Mode
 Test Specification: AC 240V, 60Hz for adapter
 Comment: Live Line
 Tem.:25°C Hum.:50%

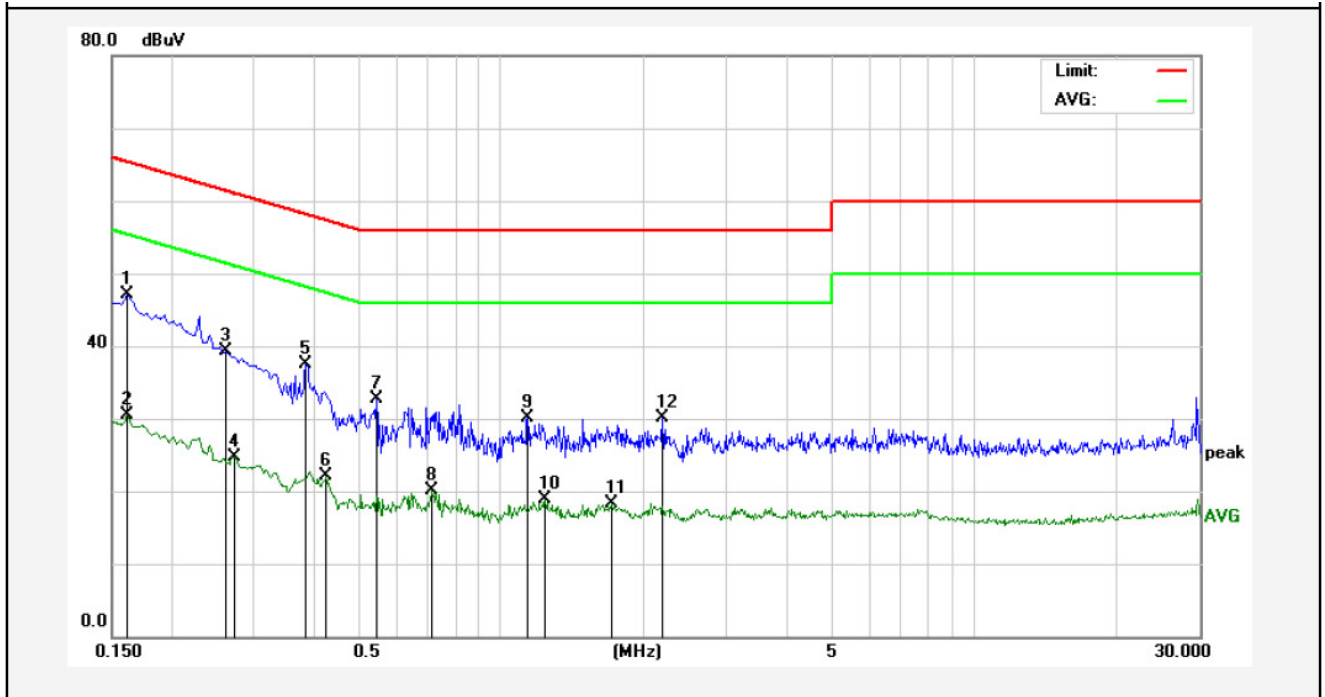

No.	Freq. (MHz)	Reading (dBuV)	Factor (dB)	Result (dBuV)	Limit dBuV	Over Limit (dB)	Detector	Remark
1	0.1620	27.13	19.90	47.03	65.36	-18.33	QP	
2	0.1620	10.56	19.90	30.46	55.36	-24.90	AVG	
3	0.2620	19.41	19.89	39.30	61.36	-22.06	QP	
4	0.2740	4.88	19.89	24.77	50.99	-26.22	AVG	
5	0.3860	17.66	19.93	37.59	58.15	-20.56	QP	
6	0.4260	2.07	19.95	22.02	47.33	-25.31	AVG	
7	0.5460	12.65	19.99	32.64	56.00	-23.36	QP	
8	0.7140	-0.01	20.04	20.03	46.00	-25.97	AVG	
9	1.1380	9.90	20.12	30.02	56.00	-25.98	QP	
10	1.2380	-1.31	20.12	18.81	46.00	-27.19	AVG	
11	1.7140	-1.87	20.13	18.26	46.00	-27.74	AVG	
12	2.1980	10.00	20.14	30.14	56.00	-25.86	QP	

CONDUCTED EMISSION TEST DATA

Test Site: 1# Shielded Room
 Operating Condition: WiFi Mode
 Test Specification: AC 240V, 60Hz for adapter
 Comment: Neutral Line
 Tem.:25°C Hum.:50%

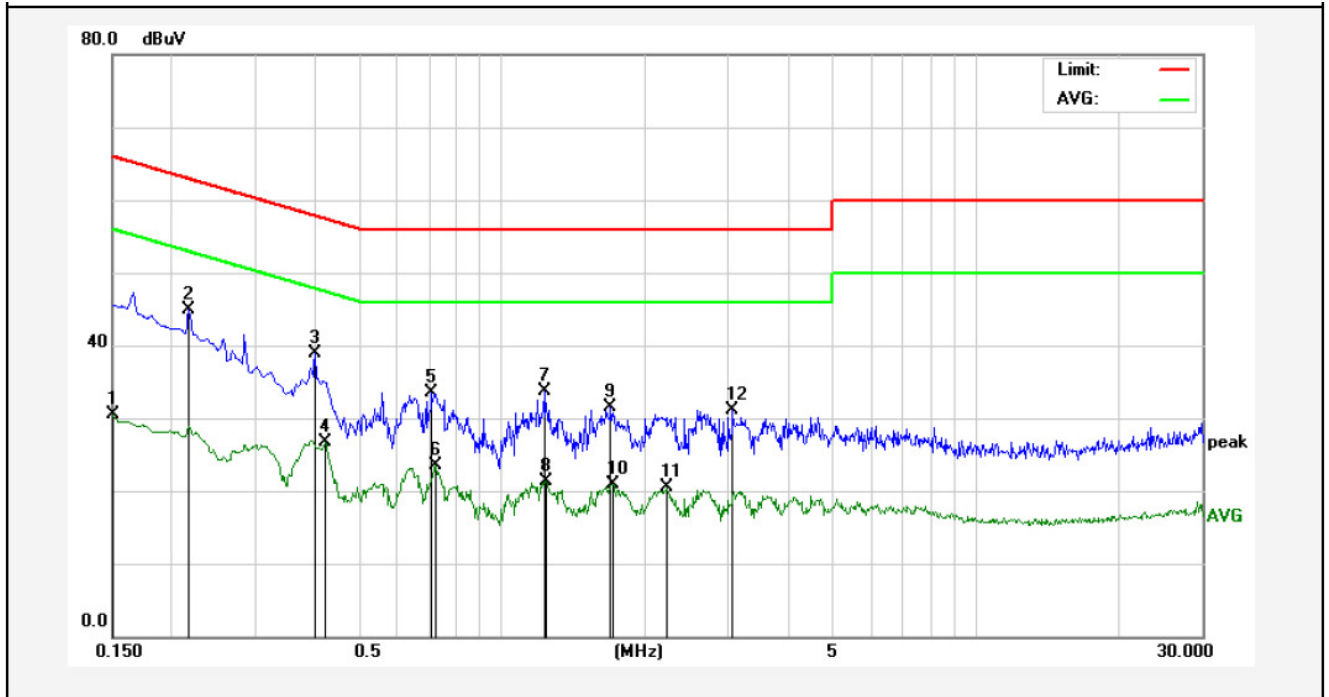

No.	Freq. (MHz)	Reading (dBuV)	Factor (dB)	Result (dBuV)	Limit dBuV	Over Limit (dB)	Detector	Remark
1	0.1500	10.57	19.90	30.47	55.99	-25.52	AVG	
2	0.2180	25.04	19.90	44.94	62.89	-17.95	QP	
3	0.4020	18.89	19.94	38.83	57.81	-18.98	QP	
4	0.4220	6.73	19.94	26.67	47.41	-20.74	AVG	
5	0.7100	13.44	20.04	33.48	56.00	-22.52	QP	
6	0.7260	3.47	20.05	23.52	46.00	-22.48	AVG	
7	1.2260	13.61	20.12	33.73	56.00	-22.27	QP	
8	1.2380	1.24	20.12	21.36	46.00	-24.64	AVG	
9	1.6980	11.31	20.13	31.44	56.00	-24.56	QP	
10	1.7100	0.81	20.13	20.94	46.00	-25.06	AVG	
11	2.2260	0.36	20.14	20.50	46.00	-25.50	AVG	
12	3.0700	10.93	20.16	31.09	56.00	-24.91	QP	

4. FCC Part 15.247 Requirements for DSSS & OFDM Modulation

4.1 Test Setup

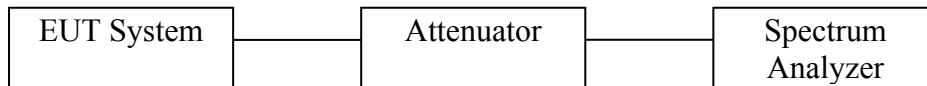

4.2 6dB Bandwidth

a. Limit

For the direct sequence systems, the minimum 6dB bandwidth shall be at least 500kHz.

b. Test Procedure

1. Place the EUT on the table and set it in the transmitting mode.
2. Remove the antenna from the EUT and then connect a low loss RF cable from the antenna port to the spectrum analyzer.
3. Set the spectrum analyzer as:
RBW = 100kHz, VBW \geq 3*RBW =300kHz,
Detector= Peak
Trace mode= Max hold.
Sweep- auto couple.
4. Mark the peak frequency and -6dB (upper and lower) frequency.
5. Repeat until all the rest channels are investigated.

20dB Bandwidth:

C63.10

Occupied Bandwidth (OBW=20dB Bandwidth)

1. Set RBW=1%~5% OBW
2. Set the VBW \geq 3*RBW
3. Set the span range between 2 times and 5 times of the OBW
4. Sweep Time= Auto
Detector= Peak
Trace= Max hold
5. Once the reference level is established, the equipment is conditioned with typical modulating signals to produce the worst case (i.e. the widest) bandwidth. Unless otherwise specified for an unlicensed wireless device, measure the bandwidth at the -20dB levels with respect to the reference level.

c. Test Setup See 4.1

d. Test Equipment

Item	Equipment	Manufacturer	Model No.	Serial No.	Last Cal.	Cal. Interval
1.	Spectrum Analysis	Agilent	E4407B	US39390582	Jul. 12, 2016	1 Year
2.	Preamplifier	Instruments corporation	EMC011830	980100	Jun. 17, 2016	1 Year
3.	EMI Test Receiver	Rohde & Schwarz	ESPI	101604	Jun. 17, 2016	1 Year
4.	Double Ridged Horn Antenna	Instruments corporation	GTH-0118	351600	May 06, 2016	1 Year
5.	Bilog Broadband Antenna	Schwarzbeck	VULB9163	VULB 9163-289	May 06, 2016	1 Year
6.	Pre-amplifier	SONOMA	310N	186860	Jun. 17, 2016	1 Year
7.	EMI Test Software EZ-EMC	SHURPLE	N/A	N/A	N/A	N/A
8	Power Sensor	Agilent	KFSW150502	15I00041SN045	Jun. 17, 2016	1 Year
9	MXA Spectrum Analysis	Agilent	N9020A	MY51170037	Jun. 17, 2016	1 Year
10	MXG RF Vector Signal Generator	Agilent	N5182A	MY48180656	Jun. 17, 2016	1 Year
11	Signal Generator	Agilent	E4421B	MY41000743	Jun. 17, 2016	1 Year
12	DC Power supply	IV	IV-8080	YQSB0096	Jun. 17, 2016	1 Year
13	TEMP&HUMI PROGRAMMABLE CHAMBER	Bell Group	BE-THK-150M8	SE-0137	Jun. 17, 2016	1 Year

e. Test Results

Pass.

f. Test Data

6dB Bandwidth

Test mode: IEEE 802.11b

Channel	Frequency (MHz)	Bandwidth (MHz)	Limit (kHz)	Results
Low	2412	7.829		Pass
Mid	2437	8.321	>500	Pass
High	2462	8.323		Pass

Test mode: IEEE 802.11g

Channel	Frequency (MHz)	Bandwidth (MHz)	Limit (kHz)	Results
Low	2412	15.73		Pass
Mid	2437	15.74	>500	Pass
High	2462	15.11		Pass

Test mode: IEEE 802.11n (HT20)

Channel	Frequency (MHz)	Bandwidth (MHz)	Limit (kHz)	Results
Low	2412	16.32		Pass
Mid	2437	16.34	>500	Pass
High	2462	15.67		Pass

Test mode: IEEE 802.11n (HT40)

Channel	Frequency (MHz)	Bandwidth (MHz)	Limit (kHz)	Results
Low	2422	26.96		Pass
Mid	2437	31.97	>500	Pass
High	2452	35.68		Pass

Test Plots See the following page.

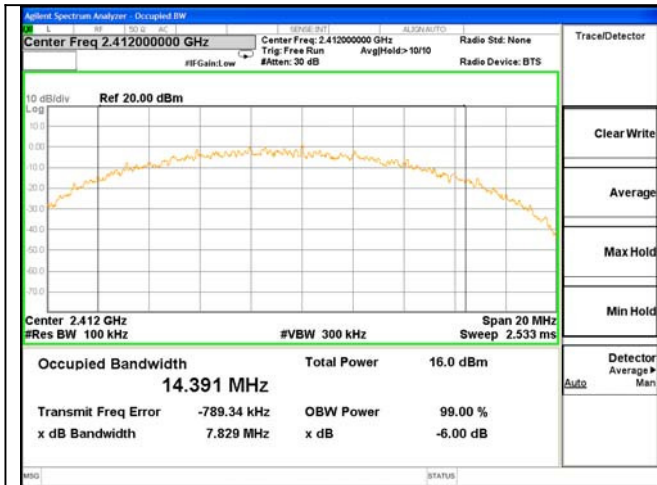

Test Mode: 802.11b---Low

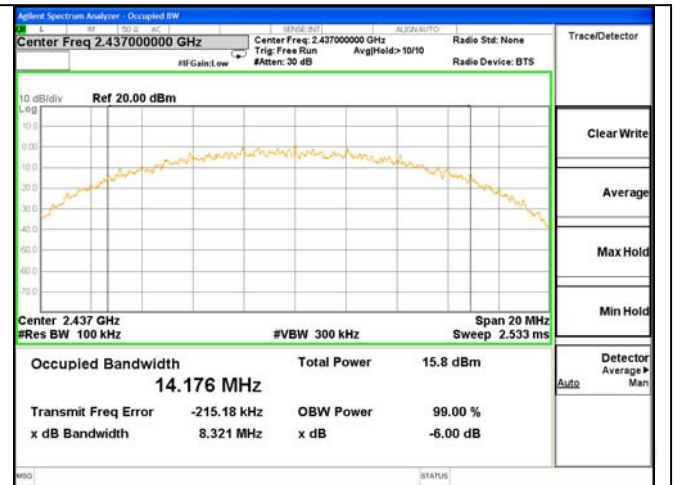

Test Mode: 802.11b---Mid

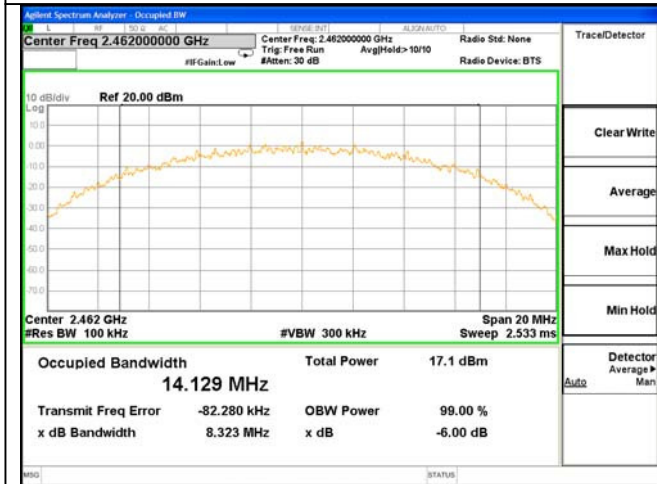

Test Mode: 802.11b---High

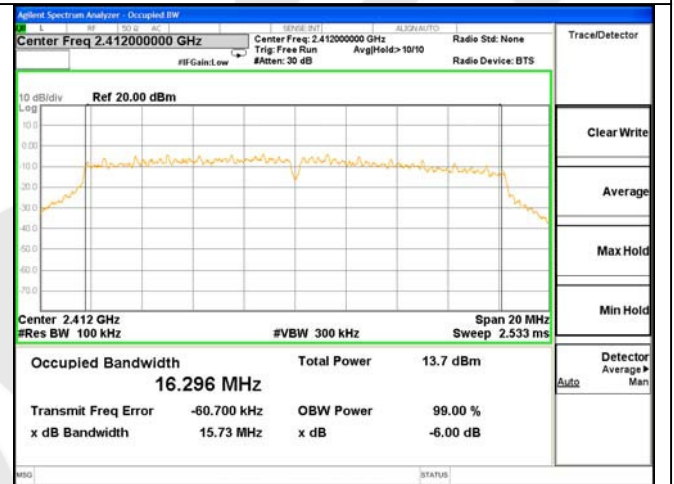

Test Mode: 802.11g---Low

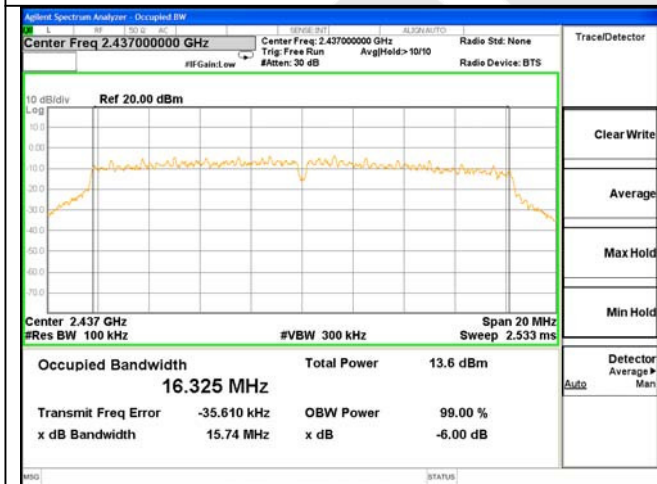

Test Mode: 802.11g---Mid

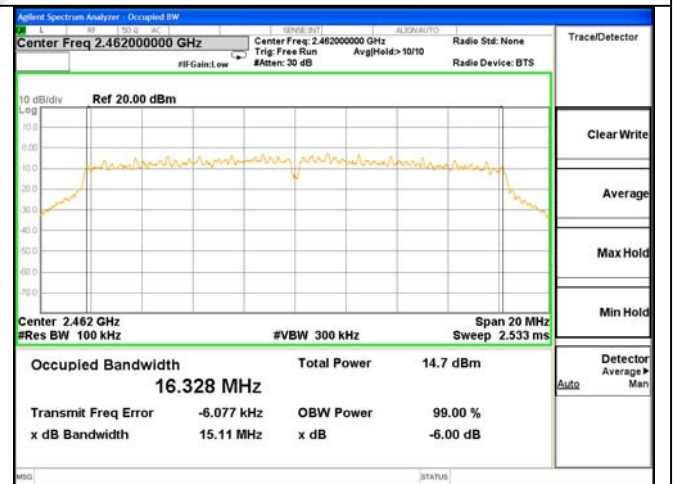

Test Mode: 802.11g---High

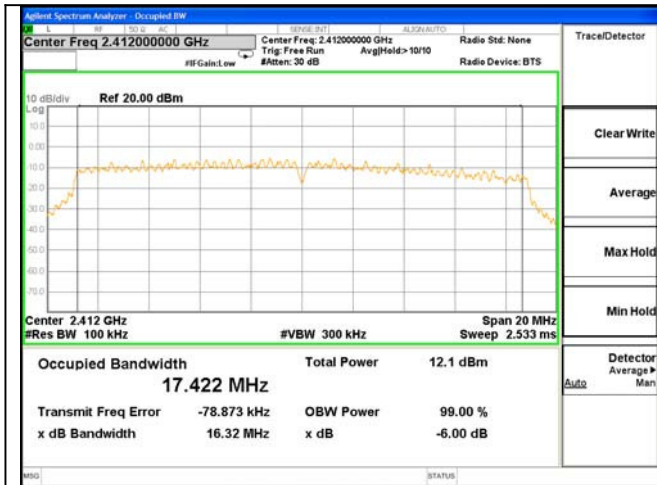

Test Mode: 802.11n20---Low

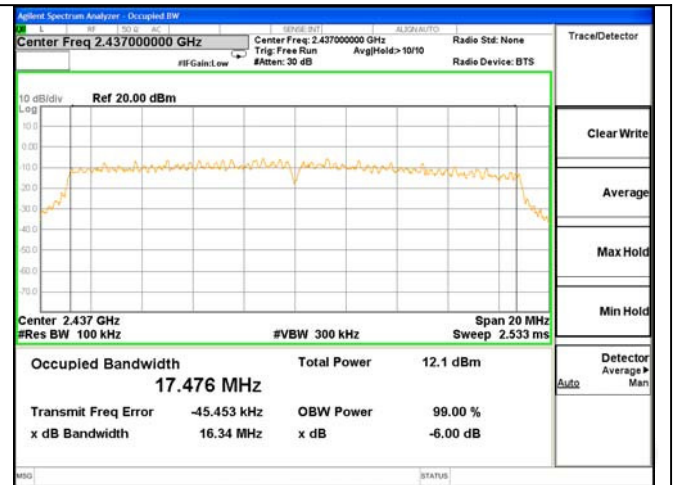

Test Mode: 802.11n20---Mid

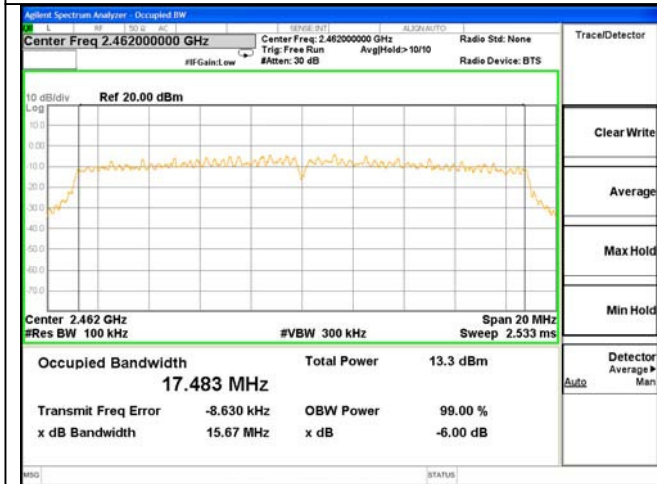

Test Mode: 802.11n20---High

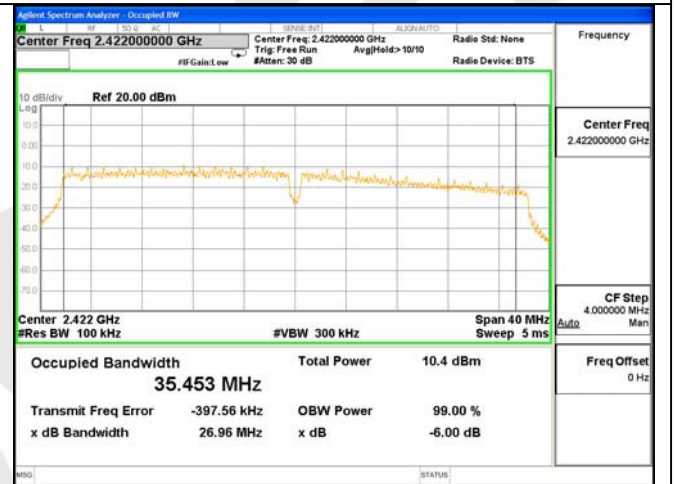

Test Mode: 802.11n40---Low

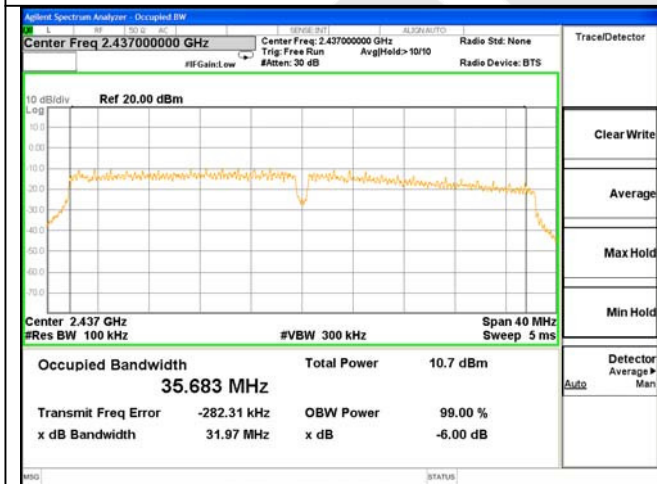

Test Mode: 802.11n40---Mid

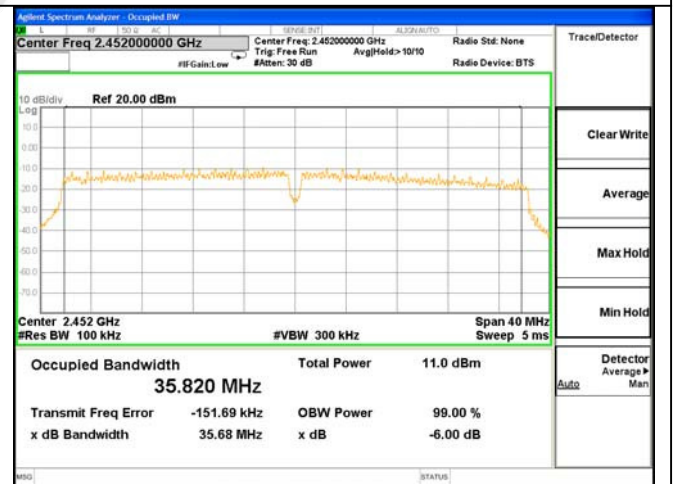

Test Mode: 802.11n40---High

20dB Bandwidth

Test mode: IEEE 802.11b

Channel	Frequency (MHz)	Bandwidth (MHz)	Results
Low	2412	16.11	Pass
Mid	2437	16.43	Pass
High	2462	16.58	Pass

Test mode: IEEE 802.11g

Channel	Frequency (MHz)	Bandwidth (MHz)	Results
Low	2412	18.29	Pass
Mid	2437	18.19	Pass
High	2462	17.98	Pass

Test mode: IEEE 802.11n (HT20)

Channel	Frequency (MHz)	Bandwidth (MHz)	Results
Low	2412	18.82	Pass
Mid	2437	19.06	Pass
High	2462	18.92	Pass

Test mode: IEEE 802.11n (HT40)

Channel	Frequency (MHz)	Bandwidth (MHz)	Results
Low	2422	39.20	Pass
Mid	2437	39.31	Pass
High	2452	39.23	Pass

Test Plots See the following page.

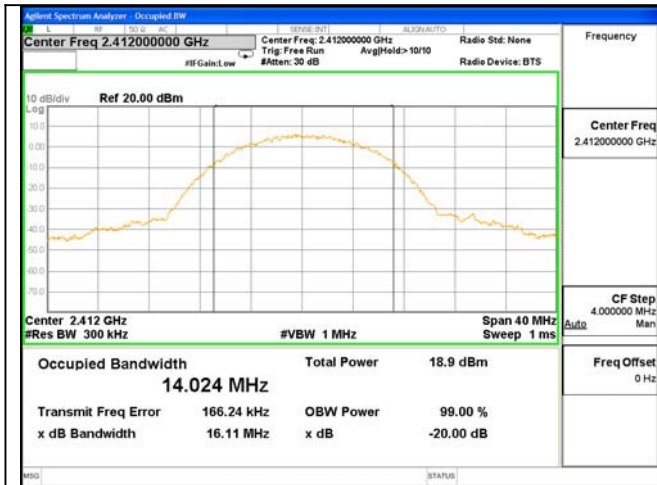

Test Mode: 802.11b---Low

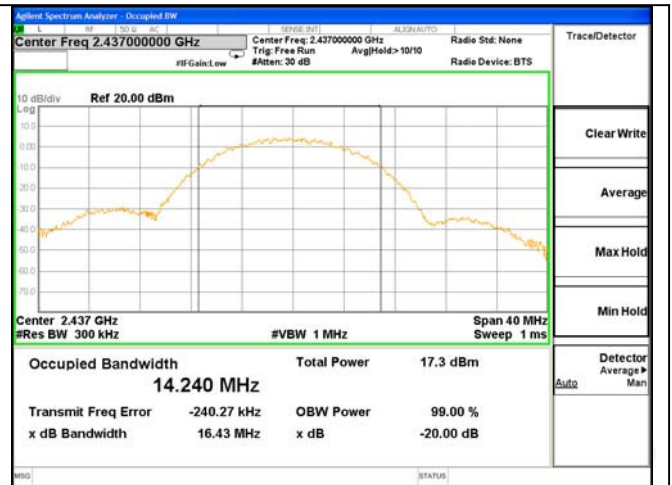

Test Mode: 802.11b---Mid

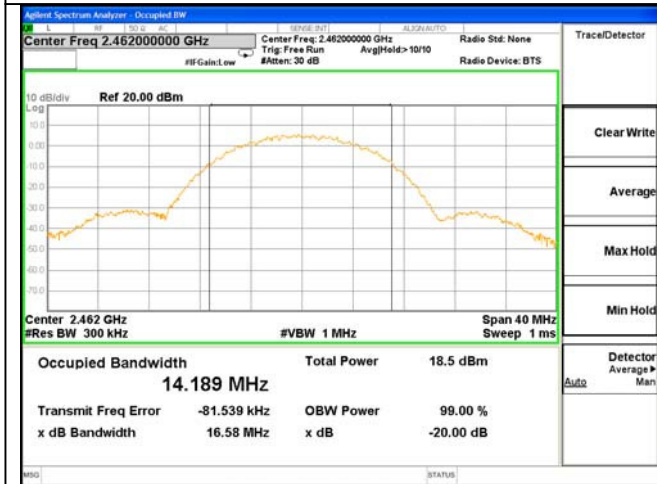

Test Mode: 802.11b---High

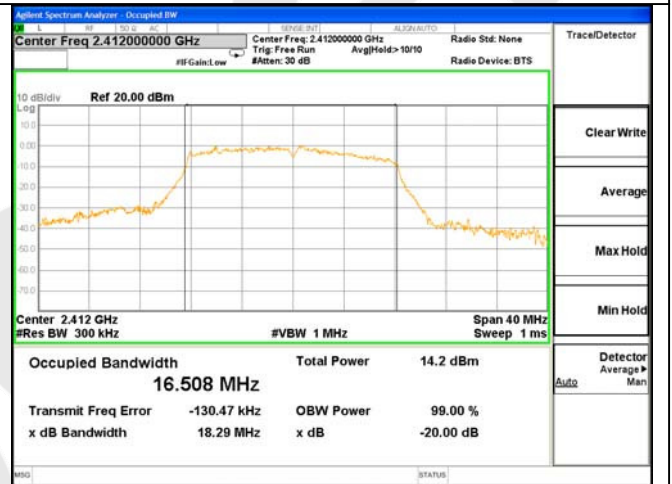

Test Mode: 802.11g---Low

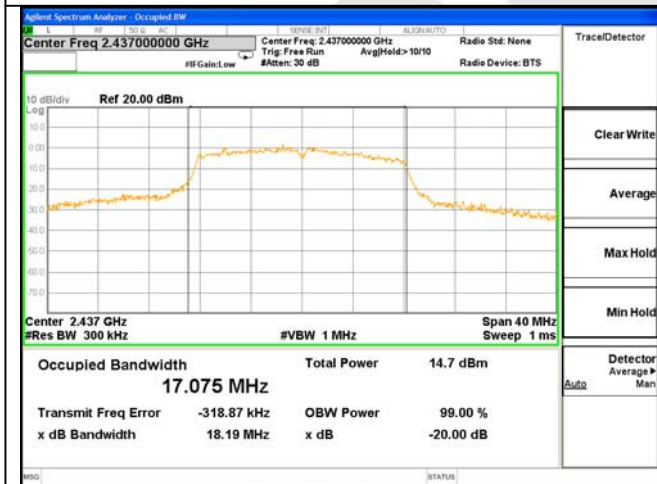

Test Mode: 802.11g---Mid

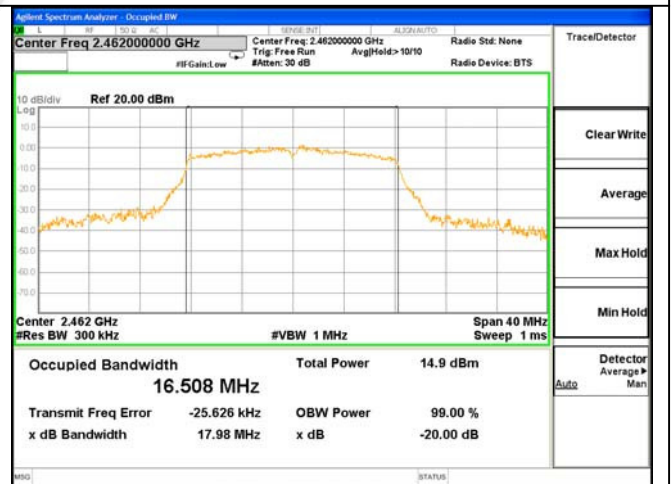

Test Mode: 802.11g---High

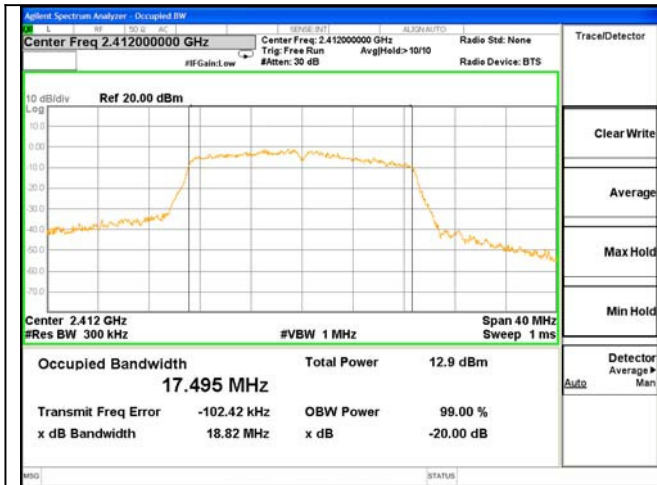

Test Mode: 802.11n20---Low

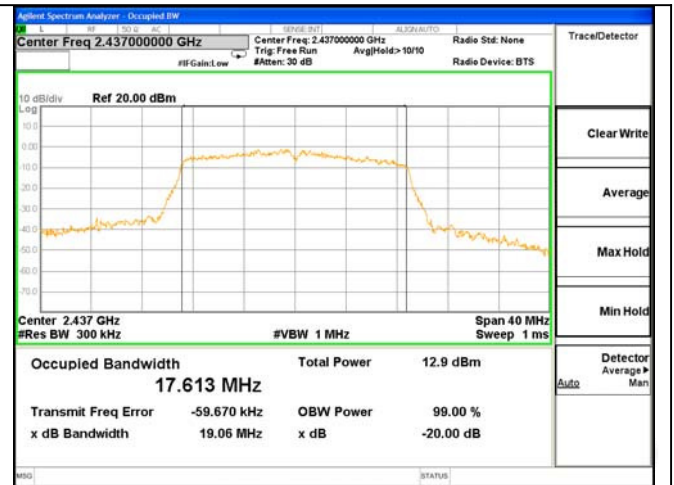

Test Mode: 802.11n20---Mid

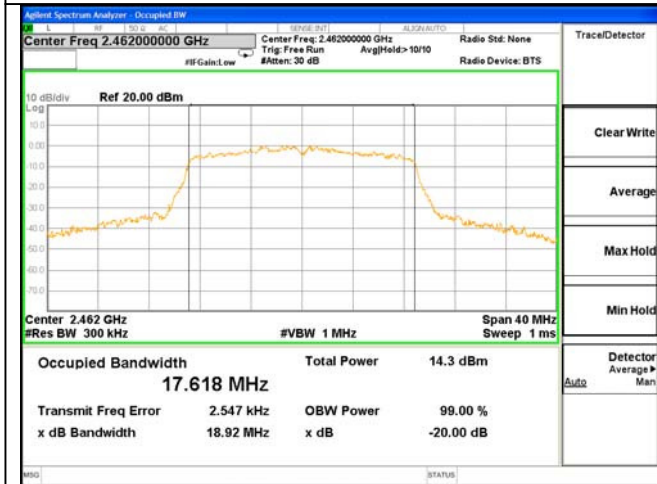

Test Mode: 802.11n20---High

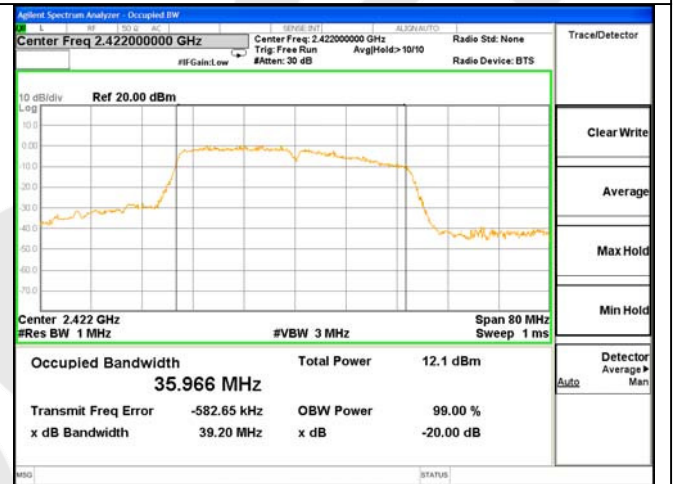

Test Mode: 802.11n40---Low

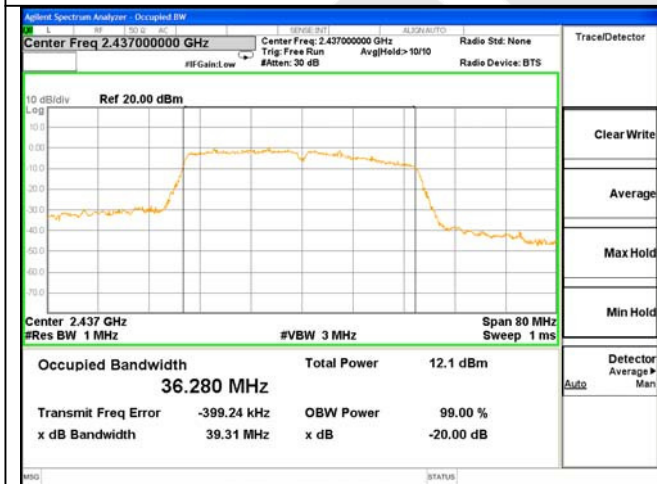

Test Mode: 802.11n40---Mid

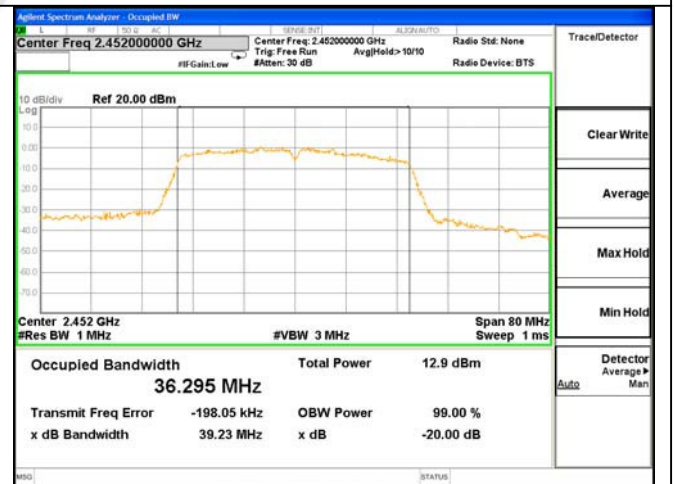

Test Mode: 802.11n40---High

4.3. Maximum Output Power Test

a. Limit

The maximum output power of the intentional radiator shall not exceed the following:

1. For systems using digital modulation in the bands of 902-928 MHz, 2400-2483.5 MHz, and 5725-5850 MHz: 1 watt (30dBm).
2. Except as shown in paragraphs (b)(3) (i), (ii) and (iii) of this section, if transmitting antenna of directional gain greater than 6 dBi are used the peak output power from the intentional radiator shall be reduced below the stated values in paragraphs (b)(1) or (b)(2) of this section, as appropriate, by the amount in dB that the directional gain of the antenna exceeds 6 dBi.

b. Configuration of Measurement

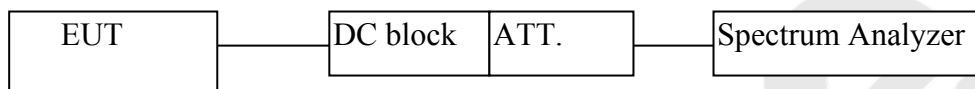

c. Data Rates

IEEE802.11b: Channel 1(2412MHz), Channel 6(2437MHz) and Channel 11(2462MHz) with 1 Mbps data rate (worst case) are chosen for the final testing.

IEEE802.11g: Channel 1(2412MHz), Channel 6(2437MHz) and Channel 11(2462MHz) with 6 Mbps data rate (the worst case) are chosen for the final testing.

IEEE802.11n (HT20): Channel 1(2412MHz), Channel 6(2437MHz) and Channel 11(2462MHz) with 6.5Mbps data rate (the worst case) are chosen for the final testing.

IEEE802.11n (HT40): Channel 3(2422MHz), Channel 6(2437MHz) and Channel 9(2452MHz) with 13.5Mbps data rate (the worst case) are chosen for the final testing.

d. Test Procedure

This test was according the kDB 558074 D01 DTS Meas Guidance v03r05 9.1.1:

1. Set span to at least 1.5 times the OBW.
2. Set the RBW = 1~5% of the OBW, not to exceed 1MHz.
3. Set VBW ≥ 3 * RBW.
4. Detector = Average.
5. Sweep time = auto couple.
6. Trace mode = max hold.
7. Allow trace to fully stabilize.

e. Test Equipment

Same as the equipment listed in 4.2.

f. Test Results

Pass.

g. Test Data

Test mode: IEEE 802.11b

Channel	Frequency (MHz)	Maximum transmit power (dBm)	Limit		Result
			(dBm)	(watts)	
Low	2412	18.64	30	1	Pass
Mid	2437	17.69			Pass
High	2462	17.40			Pass

Test mode: IEEE 802.11g

Channel	Frequency (MHz)	Maximum transmit power (dBm)	Limit		Result
			(dBm)	(watts)	
Low	2412	15.36	30	1	Pass
Mid	2437	15.49			Pass
High	2462	15.86			Pass

Test mode: IEEE 802.11n (HT20)

Channel	Frequency (MHz)	Maximum transmit power (dBm)	Limit		Result
			(dBm)	(watts)	
Low	2412	15.03	30	1	Pass
Mid	2437	15.05			Pass
High	2462	15.96			Pass

Test mode: IEEE 802.11n (HT40)

Channel	Frequency (MHz)	Maximum transmit power (dBm)	Limit		Result
			(dBm)	(watts)	
Low	2422	14.05	30	1	Pass
Mid	2437	14.10			Pass
High	2452	14.67			Pass



Test Mode: 802.11b---Low



Test Mode: 802.11b---Mid



Test Mode: 802.11b---High



Test Mode: 802.11g---Low



Test Mode: 802.11g---Mid

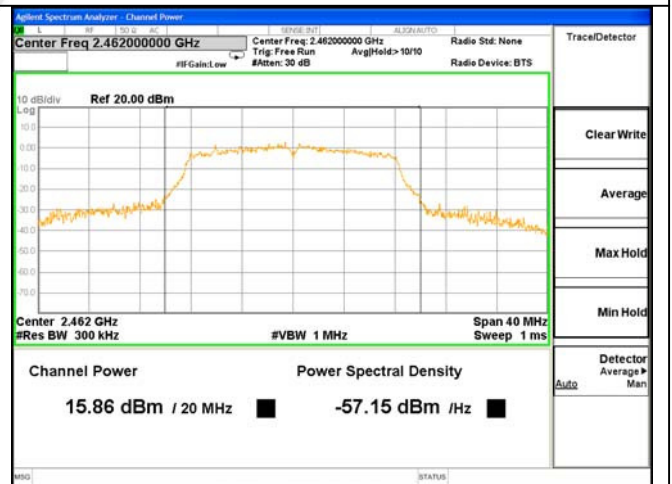

Test Mode: 802.11g---High



Test Mode: 802.11n20---Low



Test Mode: 802.11n20---Mid



Test Mode: 802.11n20---High



Test Mode: 802.11n40---Low



Test Mode: 802.11n40---Mid



Test Mode: 802.11n40---High

4.4. Band Edges Measurement

a. Limit

According to §15.247(c), in any 100 kHz bandwidth outside the frequency bands in which the spread spectrum intentional radiator is operating, the radio frequency power that is produced by the intentional radiator shall be at least 20dB below that in the 100kHz bandwidth within the band that contains the highest level of the desired power, In addition, radiated emissions which fall in the restricted bands, as defined in §15.205(a), must also comply with the radiated emission limits specified in §15.209(a).

b. Test Procedure

1. Conducted Method:

- 1) Set RBW=100KHz, VBW=300KHz
- 2) Detector=peak
- 3) Sweep time= auto
- 4) Trace mode=max hold.

2. Radiated Method:

- 1) For below 1GHz: The EUT is placed on a turntable, which is 0.8m above the ground plane. The EUT is tested in 9*6*6 Chamber.
For above 1GHz: The EUT is placed on a turntable, which is 1.5m above the ground plane. The EUT is tested in 9*6*6 Chamber.
- 2) The turntable shall be rotated for 360 degrees to determine the position of maximum emission level.
- 3) EUT is set 3m away from the receiving antenna, which is varied from 1m to 4m to find out the highest emission.
- 4) Peak detector: RBW=1MHz, VBW=3MHz, SWT=AUTO
Average detector: RBW=1MHz, VBW=10Hz, SWT=AUTO
The EUT is tested in 9*6*6 Chamber.
- 5) Repeat the procedures until all the PEAK and AVERAGE versus POLARIZATION are measured.

30M to 1G emissions:

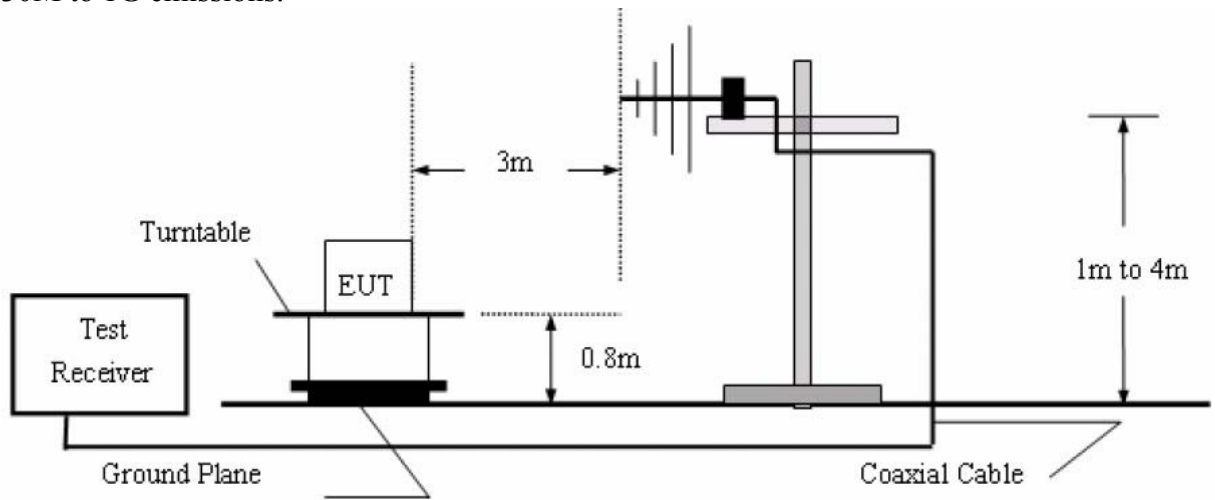

1G to 40G emissions:

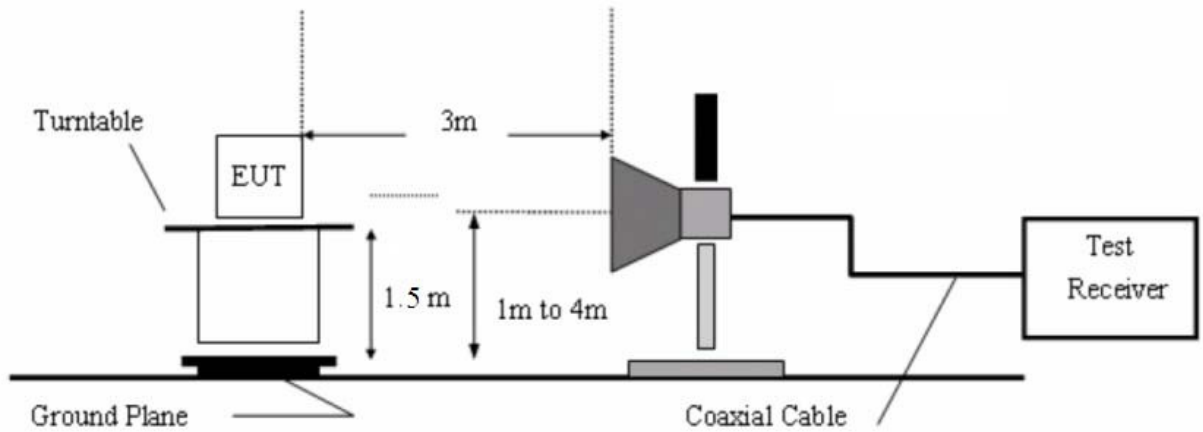

c. Test Equipment

Same as the equipment listed in 4.2.

d. Test Results

Pass.

e. Test Plots

See the following page.

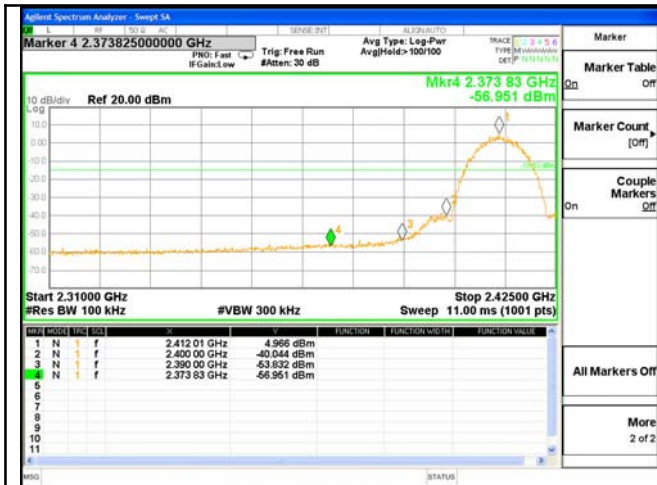

Test Mode: 802.11b---Low



Test Mode: 802.11b---High

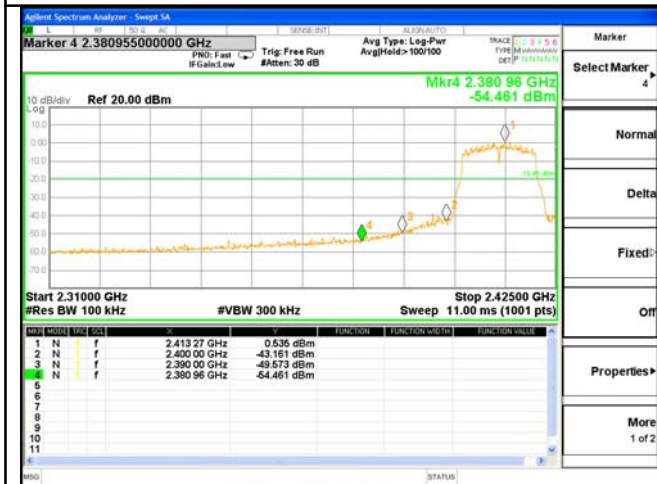

Test Mode: 802.11g---Low



Test Mode: 802.11g---High



Test Mode: 802.11n20---Low

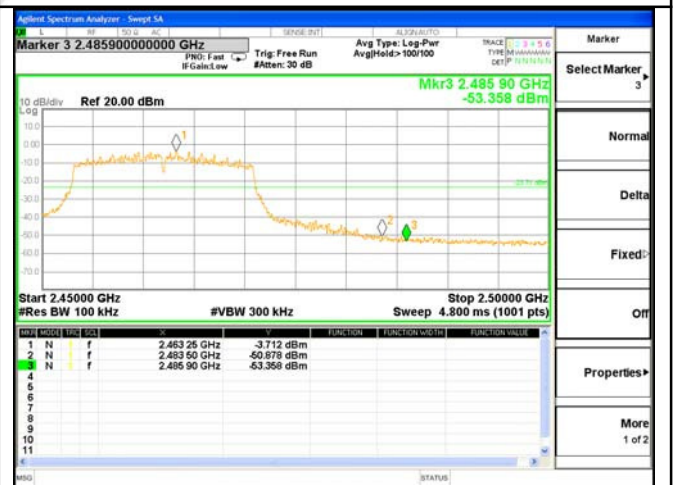

Test Mode: 802.11n20---High

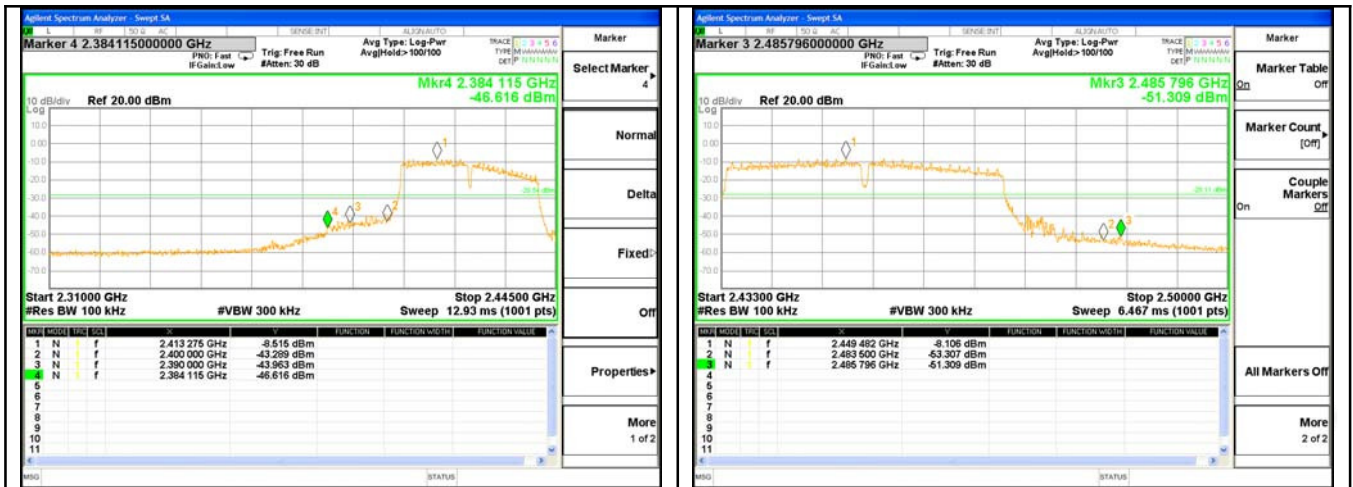

Test Mode: 802.11n40---Low

Test Mode: 802.11n40---High



Test Mode: 802.11b
2412MHz
Horizontal-PEAK:

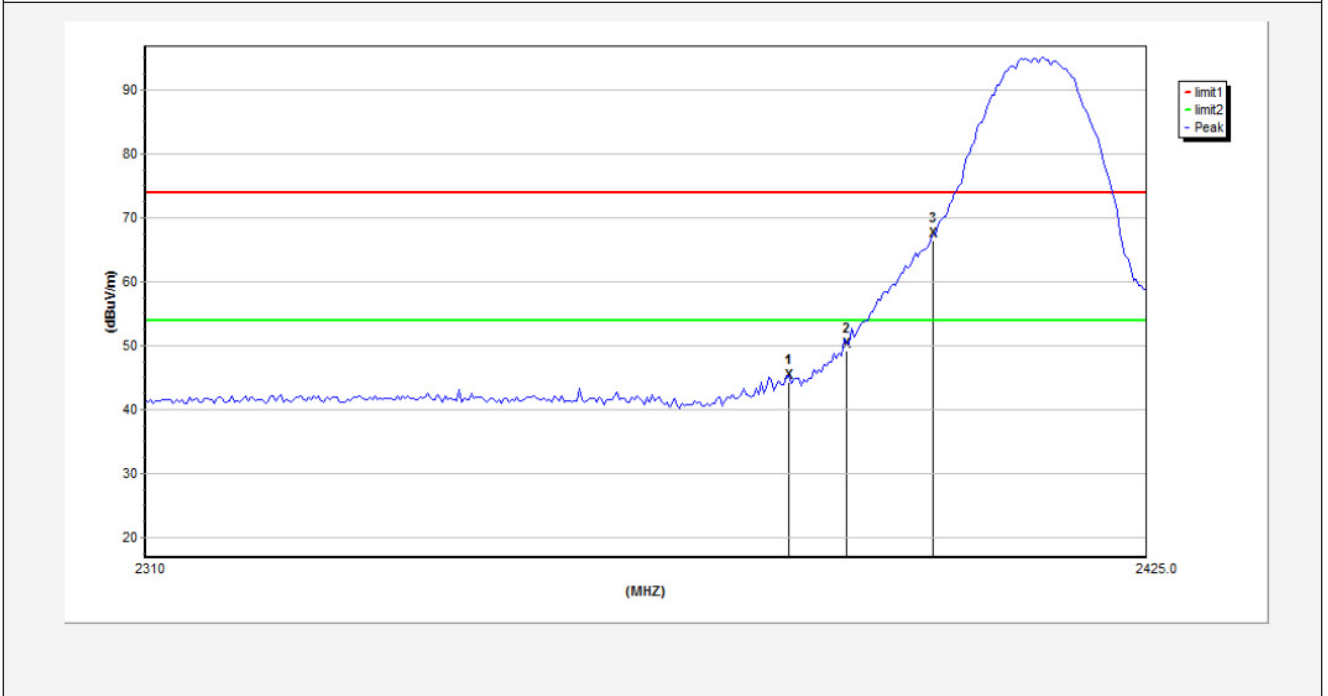

No.	Freq. (MHz)	Reading (dBuV/m)	Antenna (dB/m)	Amp. (dB/m)	Cable (dB/m)	Result (dBuV/m)	Limit (dBuV/m)	Over Limit (dB)	Detector	Height (cm)	degree (deg)
1	2383.3125	46.89	29.14	34.01	3.4	45.42	74.00	-28.58	peak	---	---
2	2390.0000	51.75	29.15	34.01	3.41	50.30	74.00	-23.70	peak	---	---
3	2400.0000	68.85	29.16	34.01	3.43	67.43	74.00	-6.57	peak	---	---

Anbotek

Horizontal-AV:

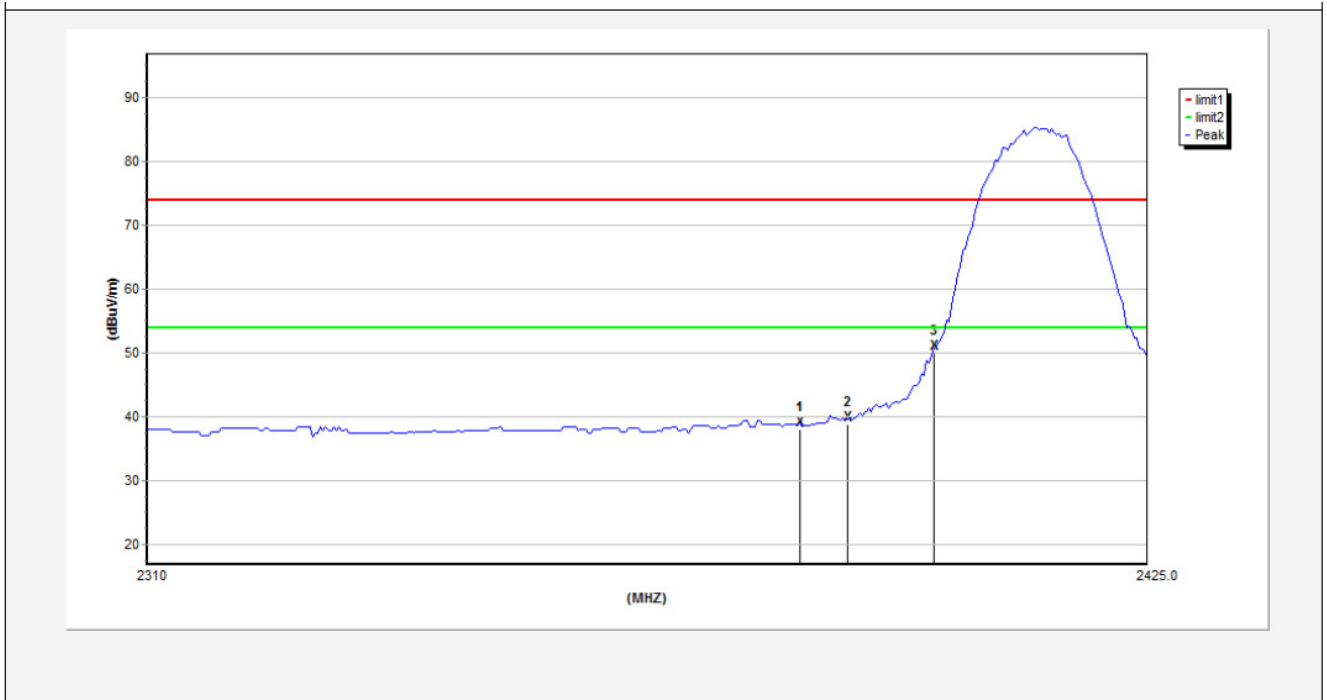

No.	Freq. (MHz)	Reading (dBuV/m)	Antenna (dB/m)	Amp. (dB/m)	Cable (dB/m)	Result (dBuV/m)	Limit (dBuV/m)	Over Limit (dB)	Detector	Height (cm)	degree (deg)
1	2384.4625	40.45	29.14	34.01	3.4	38.98	54.00	-15.02	AVG	---	---
2	2390.0000	41.33	29.15	34.01	3.41	39.88	54.00	-14.12	AVG	---	---
3	2400.0000	52.36	29.16	34.01	3.43	50.94	54.00	-3.06	AVG	---	---

Anbotek

Test Mode: 802.11b
2412MHz
Vertical-PEAK:

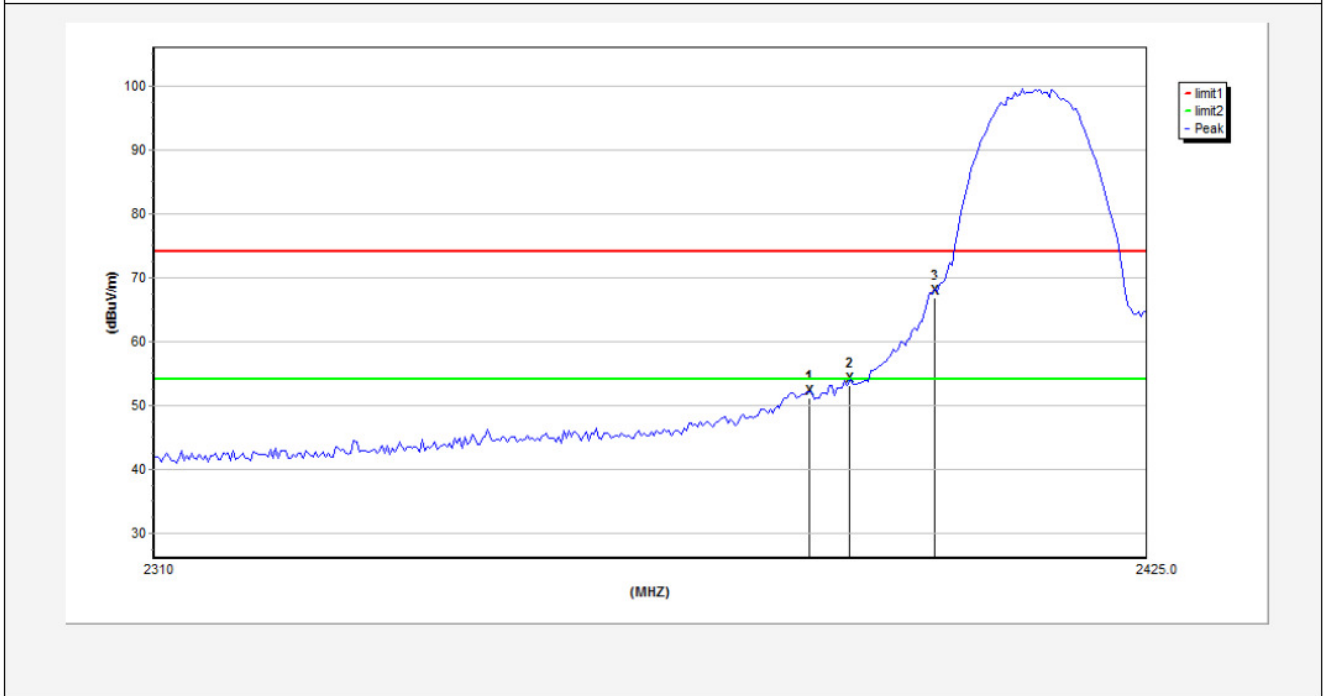

No.	Freq. (MHz)	Reading (dBuV/m)	Antenna (dB/m)	Amp. (dB/m)	Cable (dB/m)	Result (dBuV/m)	Limit (dBuV/m)	Over Limit (dB)	Detector	Height (cm)	degree (deg)
1	2385.3250	53.59	29.14	34.01	3.41	52.13	74.00	-21.87	peak	---	---
2	2390.0000	55.50	29.15	34.01	3.41	54.05	74.00	-19.95	peak	---	---
3	2400.0000	69.17	29.16	34.01	3.43	67.75	74.00	-6.25	peak	---	---

Anbotek

Vertical-AV:

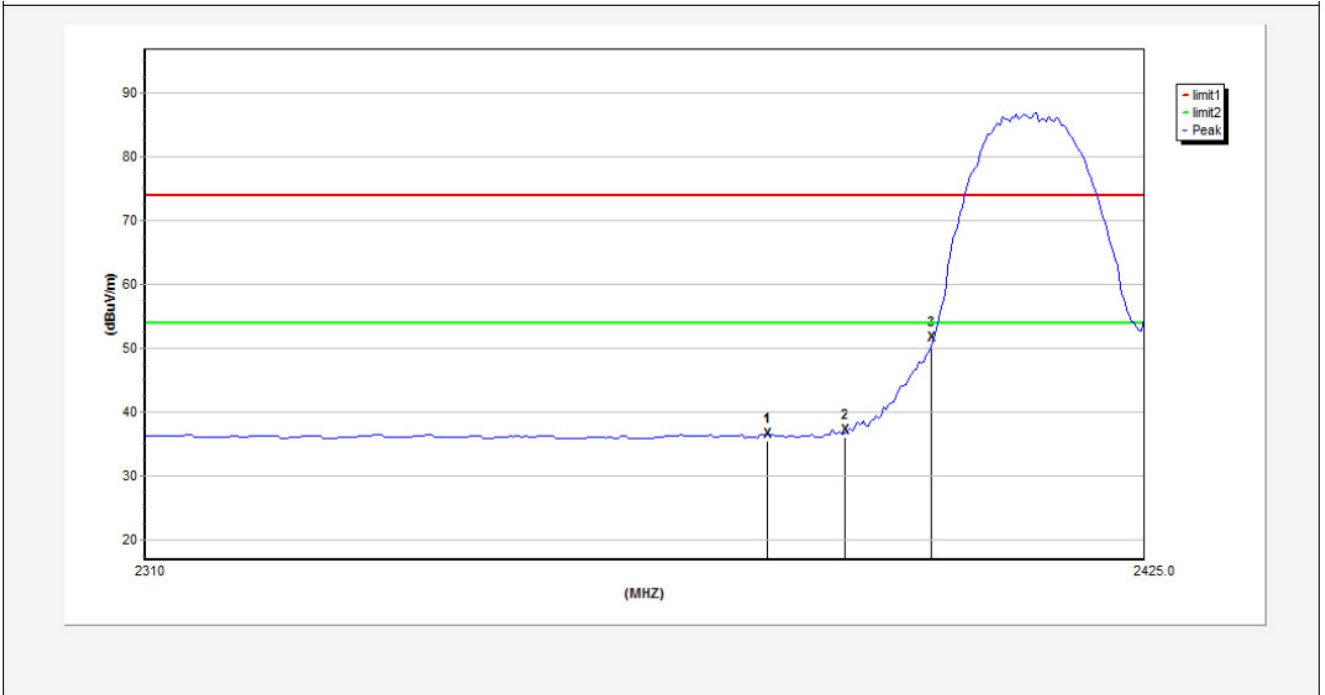

No.	Freq. (MHz)	Reading (dBuV/m)	Antenna (dB/m)	Amp. (dB/m)	Cable (dB/m)	Result (dBuV/m)	Limit (dBuV/m)	Over Limit (dB)	Detector	Height (cm)	degree (deg)
1	2381.0124	37.98	29.13	34.01	3.4	36.50	54.00	-17.50	AVG	---	---
2	2390.0000	38.51	29.15	34.01	3.41	37.06	54.00	-16.94	AVG	---	---
3	2400.0000	52.97	29.16	34.01	3.43	51.55	54.00	-2.45	AVG	---	---

Anbotek

Test Mode: 802.11b
2462MHz
Horizontal-PEAK:

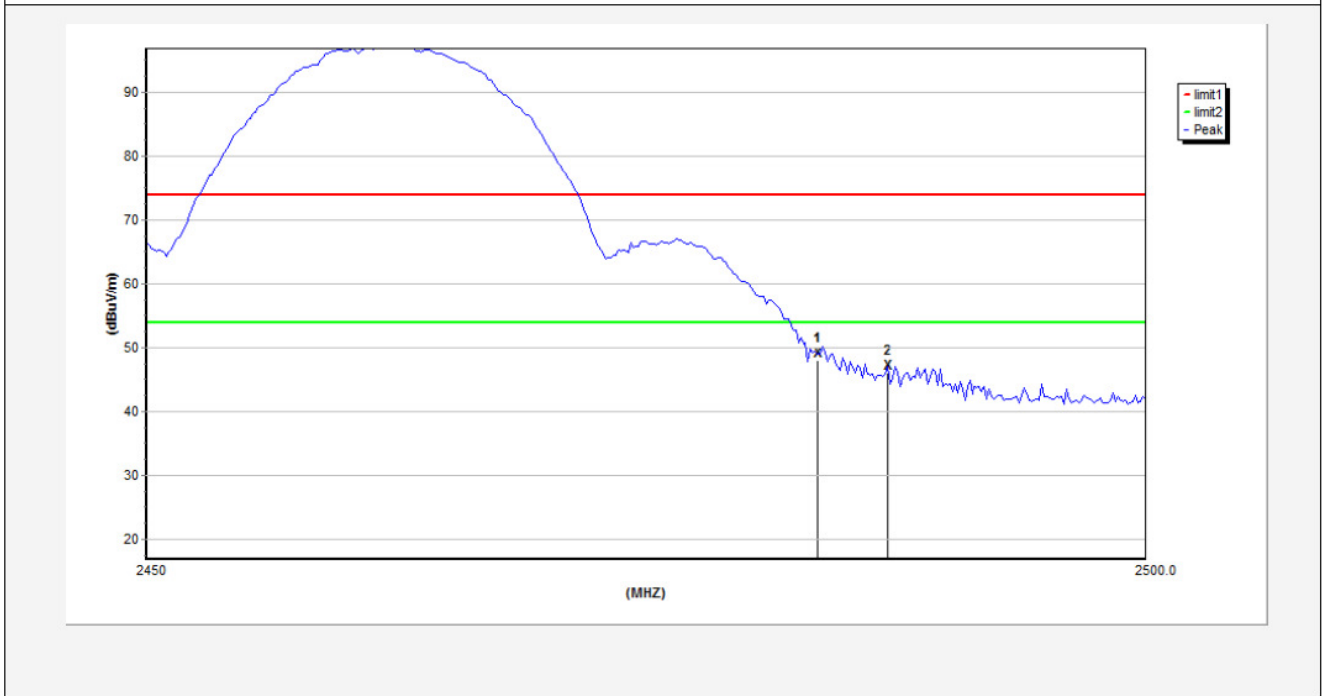

No.	Freq. (MHz)	Reading (dBuV/m)	Antenna (dB/m)	Amp. (dB/m)	Cable (dB/m)	Result (dBuV/m)	Limit (dBuV/m)	Over Limit (dB)	Detector	Height (cm)	degree (deg)
1	2483.5000	50.22	29.28	34.03	3.53	49.00	74.00	-25.00	peak	---	---
2	2487.0000	48.33	29.28	34.03	3.54	47.12	74.00	-26.88	peak	---	---

Anbotek

Horizontal-AV:

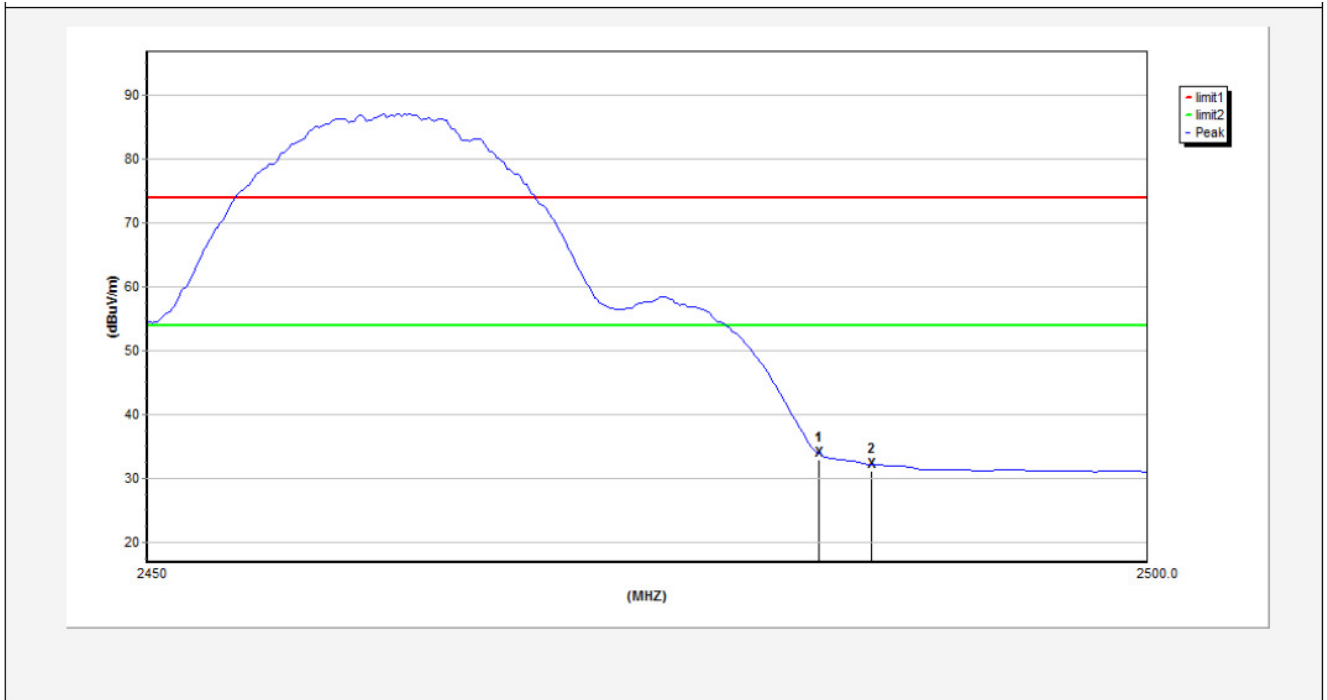

No.	Freq. (MHz)	Reading (dBuV/m)	Antenna (dB/m)	Amp. (dB/m)	Cable (dB/m)	Result (dBuV/m)	Limit (dBuV/m)	Over Limit (dB)	Detector	Height (cm)	degree (deg)
1	2483.5000	35.15	29.28	34.03	3.53	33.93	54.00	-20.07	AVG	---	---
2	2486.1250	33.43	29.28	34.03	3.54	32.22	54.00	-21.78	AVG	---	---

Anbotek

Test Mode: 802.11b
2462MHz
Vertical-PEAK:

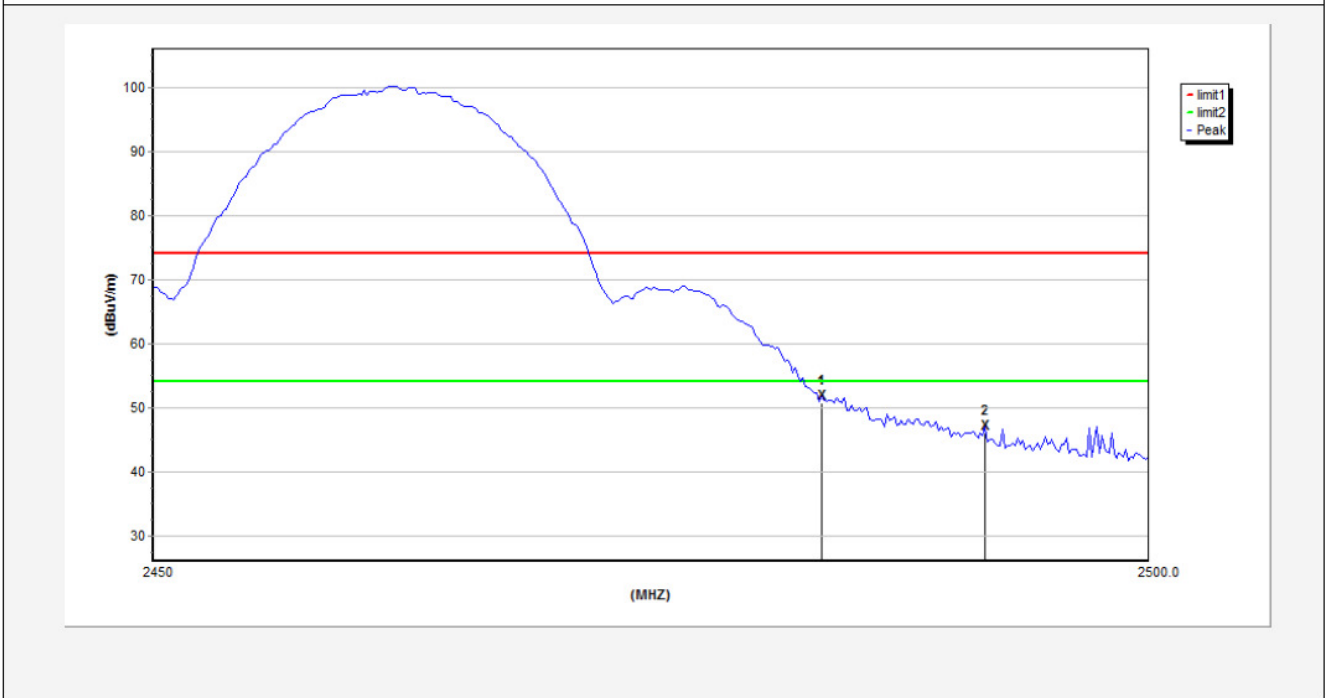

No.	Freq. (MHz)	Reading (dBuV/m)	Antenna (dB/m)	Amp. (dB/m)	Cable (dB/m)	Result (dBuV/m)	Limit (dBuV/m)	Over Limit (dB)	Detector	Height (cm)	degree (deg)
1	2483.5000	52.93	29.28	34.03	3.53	51.71	74.00	-22.29	peak	---	---
2	2491.7500	48.19	29.29	34.03	3.55	47.00	74.00	-27.00	peak	---	---

Anbotek

Vertical-AV:

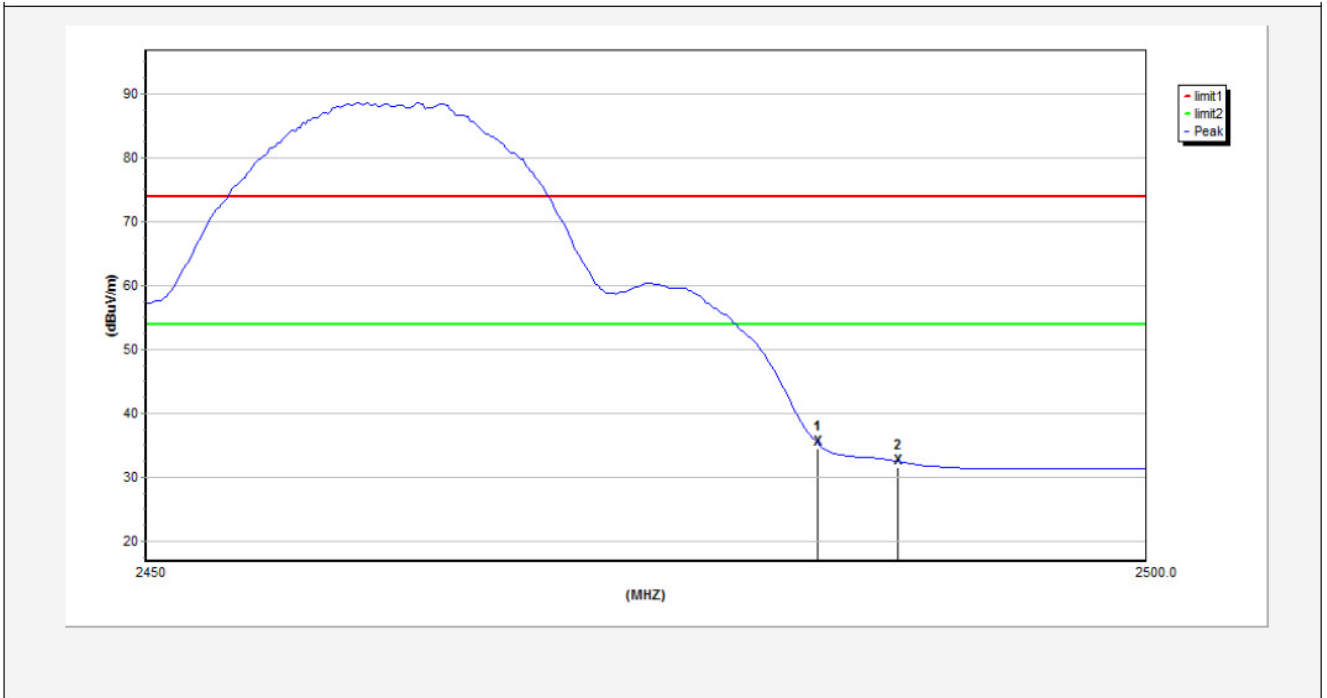

No.	Freq. (MHz)	Reading (dBuV/m)	Antenna (dB/m)	Amp. (dB/m)	Cable (dB/m)	Result (dBuV/m)	Limit (dBuV/m)	Over Limit (dB)	Detector	Height (cm)	degree (deg)
1	2483.5000	36.78	29.28	34.03	3.53	35.56	54.00	-18.44	AVG	---	---
2	2487.5000	33.73	29.28	34.03	3.54	32.52	54.00	-21.48	AVG	---	---

Anbotek

Test Mode: 802.11g
2412MHz
Horizontal-PEAK:

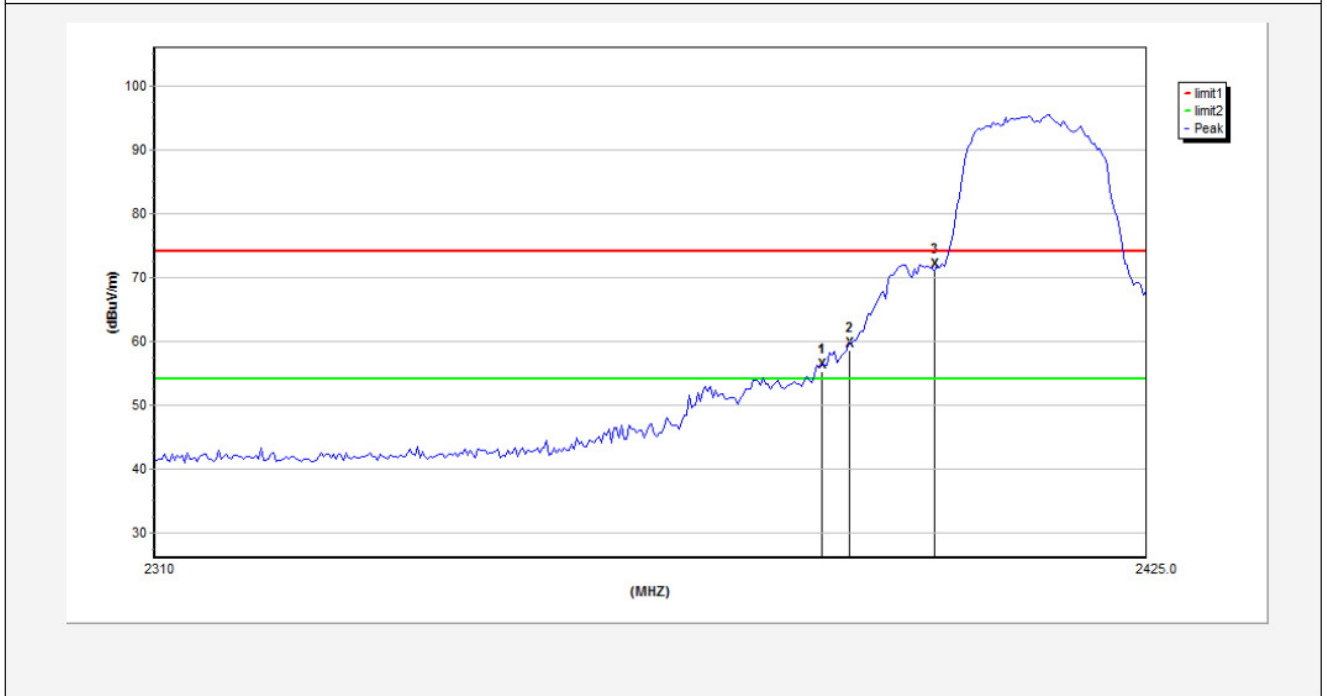

No.	Freq. (MHz)	Reading (dBuV/m)	Antenna (dB/m)	Amp. (dB/m)	Cable (dB/m)	Result (dBuV/m)	Limit (dBuV/m)	Over Limit (dB)	Detector	Height (cm)	degree (deg)
1	2386.7620	57.71	29.14	34.01	3.41	56.25	74.00	-17.75	peak	---	---
2	2390.0000	60.98	29.15	34.01	3.41	59.53	74.00	-14.47	peak	---	---
3	2400.0000	73.24	29.16	34.01	3.43	71.82	74.00	-2.18	peak	---	---

Anbotek

Horizontal-AV:

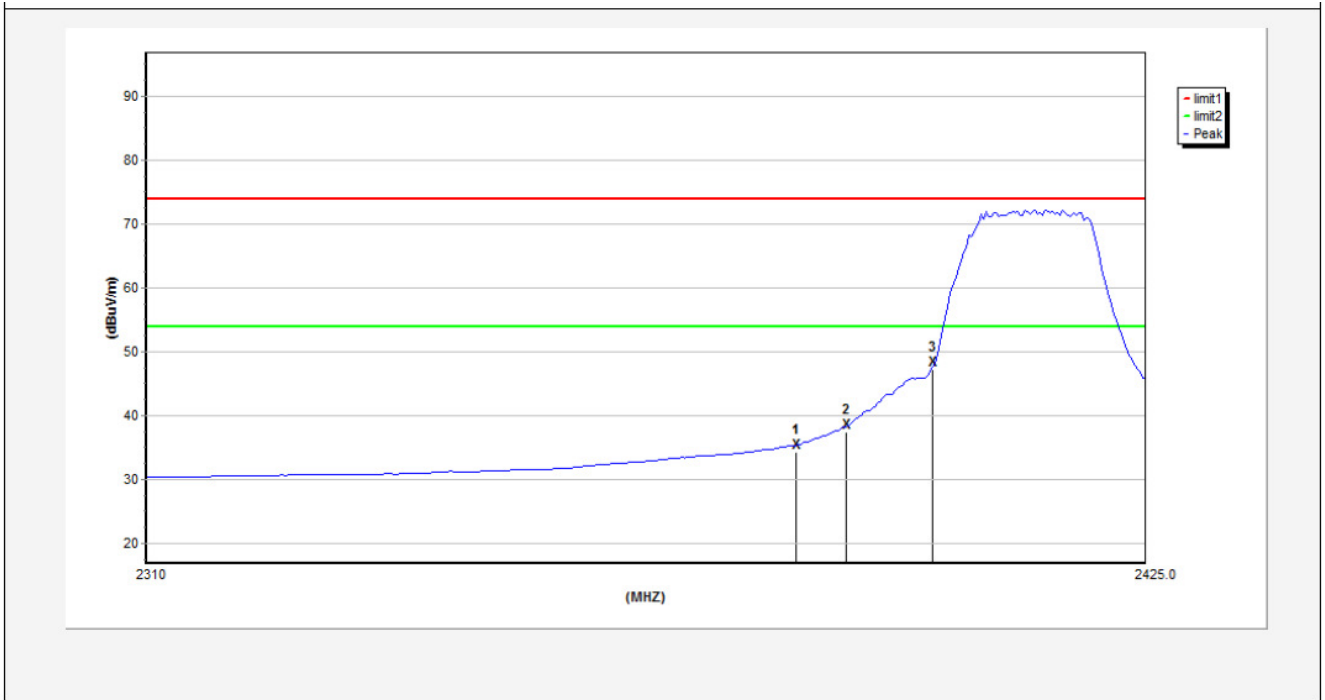

No.	Freq. (MHz)	Reading (dBuV/m)	Antenna (dB/m)	Amp. (dB/m)	Cable (dB/m)	Result (dBuV/m)	Limit (dBuV/m)	Over Limit (dB)	Detector	Height (cm)	degree (deg)
1	2384.1750	36.79	29.14	34.01	3.4	35.32	54.00	-18.68	AVG	---	---
2	2390.0000	39.95	29.15	34.01	3.41	38.50	54.00	-15.50	AVG	---	---
3	2400.0000	49.61	29.16	34.01	3.43	48.19	54.00	-5.81	AVG	---	---

Anbotek

Test Mode: 802.11g
2412MHz
Vertical-PEAK:

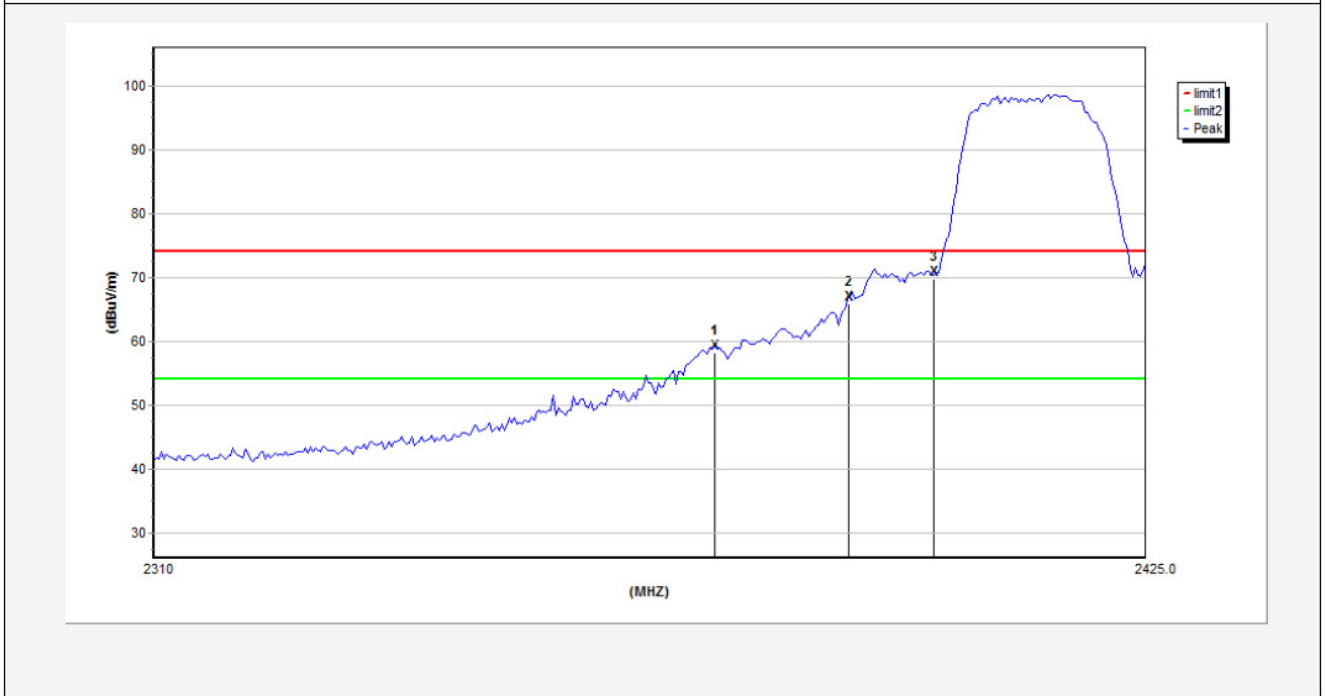

No.	Freq. (MHz)	Reading (dBuV/m)	Antenna (dB/m)	Amp. (dB/m)	Cable (dB/m)	Result (dBuV/m)	Limit (dBuV/m)	Over Limit (dB)	Detector	Height (cm)	degree (deg)
1	2374.4000	60.61	29.12	34.01	3.39	59.11	74.00	-14.89	peak	---	---
2	2390.0000	68.28	29.15	34.01	3.41	66.83	74.00	-7.17	peak	---	---
3	2400.0000	72.12	29.16	34.01	3.43	70.70	74.00	-3.30	peak	---	---

Anbotek

Vertical-AV:

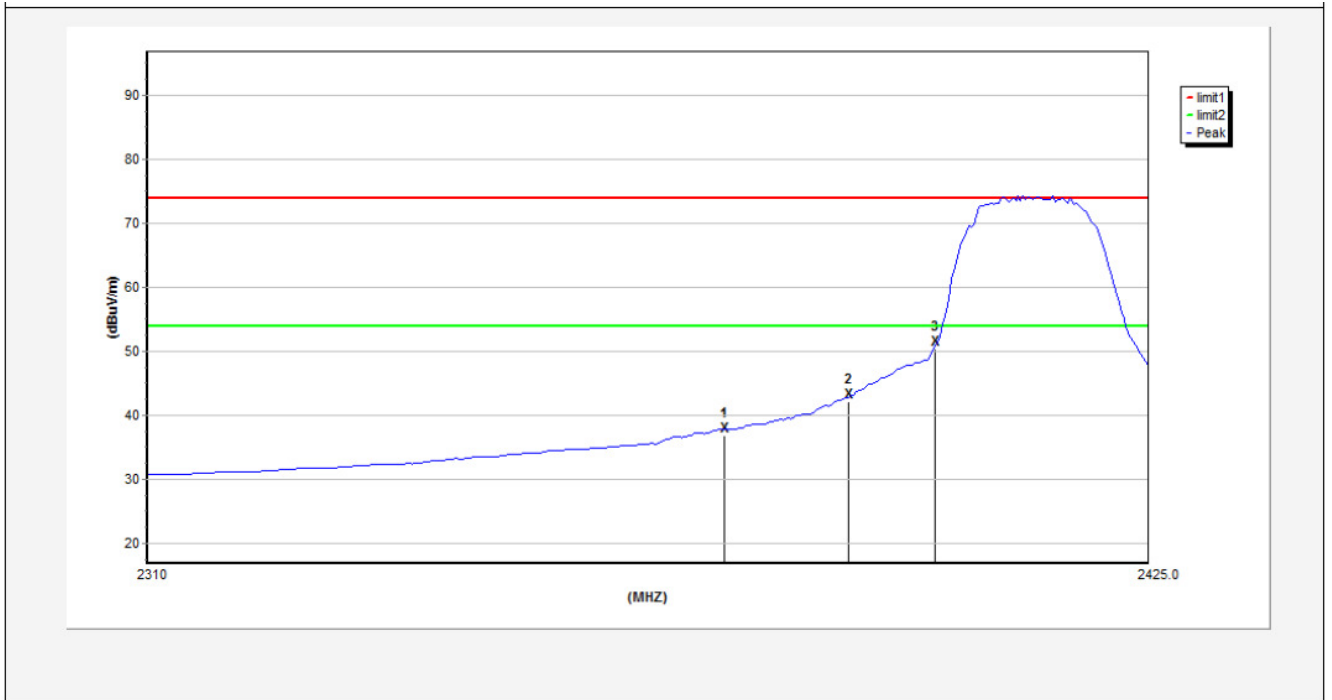

No.	Freq. (MHz)	Reading (dBuV/m)	Antenna (dB/m)	Amp. (dB/m)	Cable (dB/m)	Result (dBuV/m)	Limit (dBuV/m)	Over Limit (dB)	Detector	Height (cm)	degree (deg)
1	2375.5500	39.44	29.13	34.01	3.39	37.95	54.00	-16.05	AVG	---	---
2	2390.0000	44.55	29.15	34.01	3.41	43.10	54.00	-10.90	AVG	---	---
3	2400.0000	52.75	29.16	34.01	3.43	51.33	54.00	-2.67	AVG	---	---

Anbotek

Test Mode: 802.11g
2462MHz
Horizontal-PEAK:

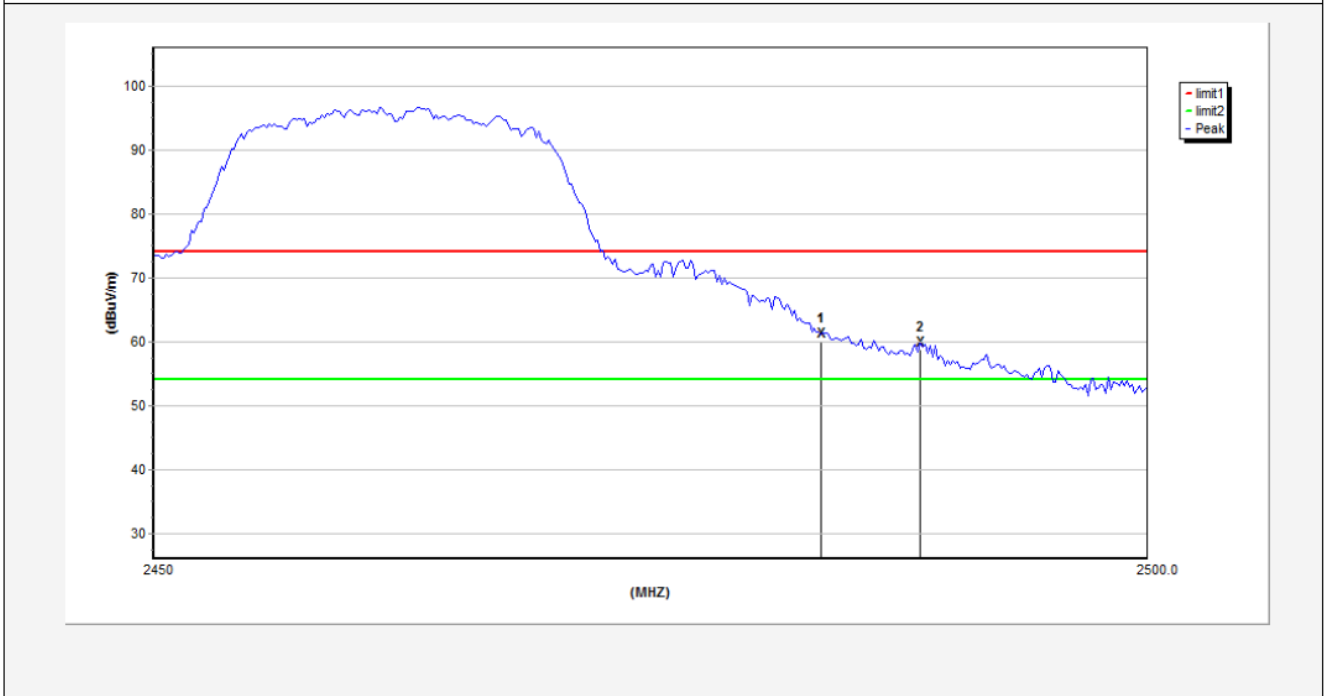

No.	Freq. (MHz)	Reading (dBuV/m)	Antenna (dB/m)	Amp. (dB/m)	Cable (dB/m)	Result (dBuV/m)	Limit (dBuV/m)	Over Limit (dB)	Detector	Height (cm)	degree (deg)
1	2483.5000	62.24	29.28	34.03	3.53	61.02	74.00	-12.98	peak	---	---
2	2488.5000	60.94	29.28	34.03	3.54	59.73	74.00	-14.27	peak	---	---

Anbotek

Horizontal-AV:

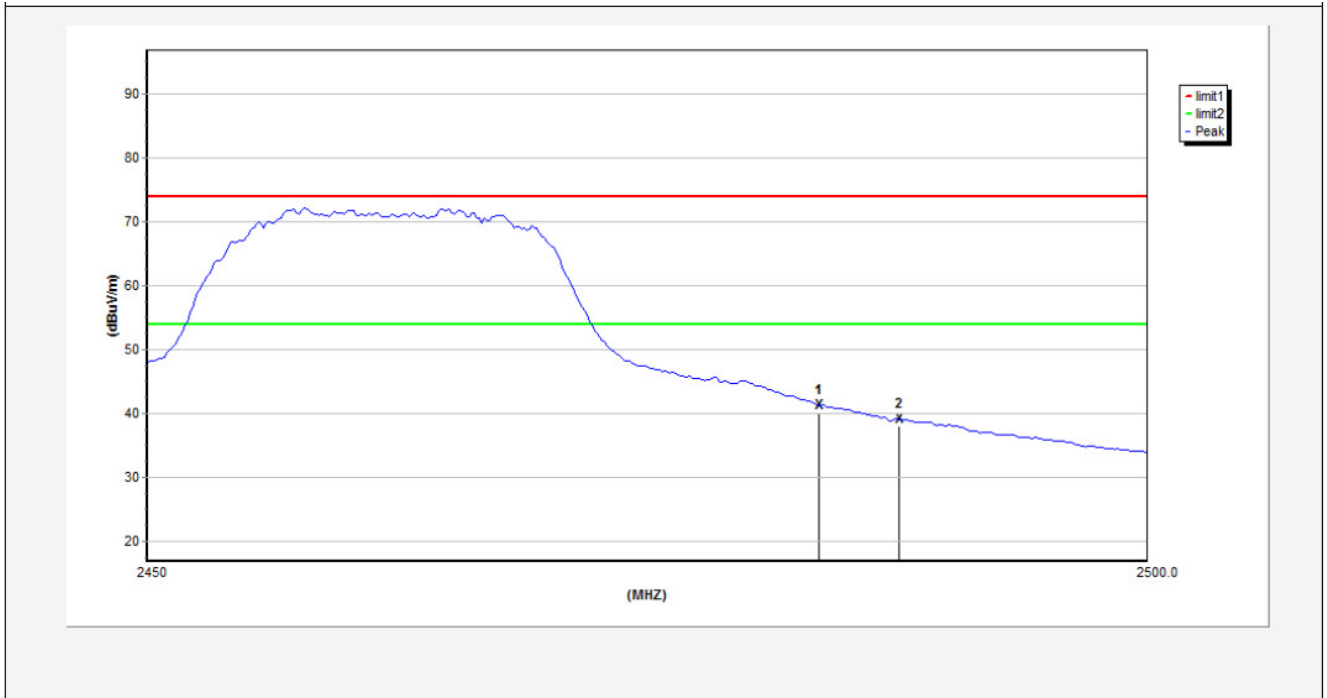

No.	Freq. (MHz)	Reading (dBuV/m)	Antenna (dB/m)	Amp. (dB/m)	Cable (dB/m)	Result (dBuV/m)	Limit (dBuV/m)	Over Limit (dB)	Detector	Height (cm)	degree (deg)
1	2483.5000	42.52	29.28	34.03	3.53	41.30	54.00	-12.70	AVG	---	---
2	2487.5000	40.34	29.28	34.03	3.54	39.13	54.00	-14.87	AVG	---	---

Anbotek

Test Mode: 802.11g
2462MHz
Vertical-PEAK:

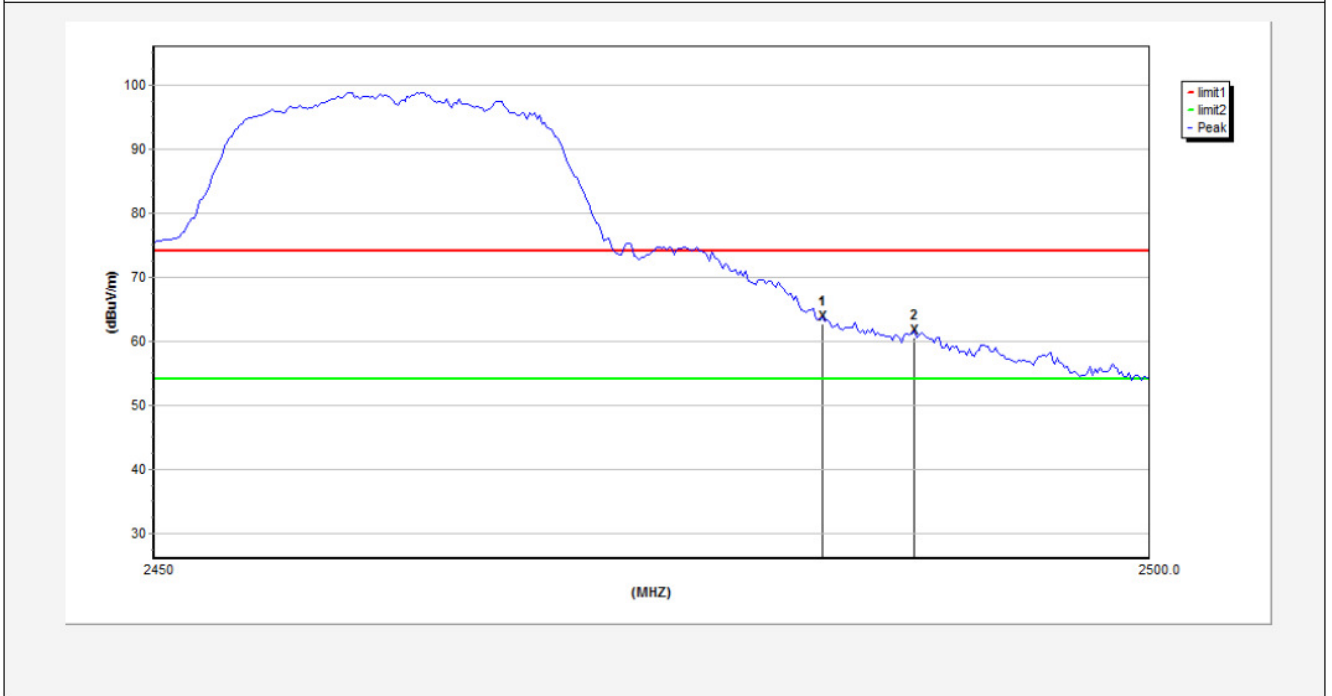

No.	Freq. (MHz)	Reading (dBuV/m)	Antenna (dB/m)	Amp. (dB/m)	Cable (dB/m)	Result (dBuV/m)	Limit (dBuV/m)	Over Limit (dB)	Detector	Height (cm)	degree (deg)
1	2483.5000	64.84	29.28	34.03	3.53	63.62	74.00	-10.38	peak	---	---
2	2488.1250	62.71	29.28	34.03	3.54	61.50	74.00	-12.50	peak	---	---

Anbotek

Vertical-AV:

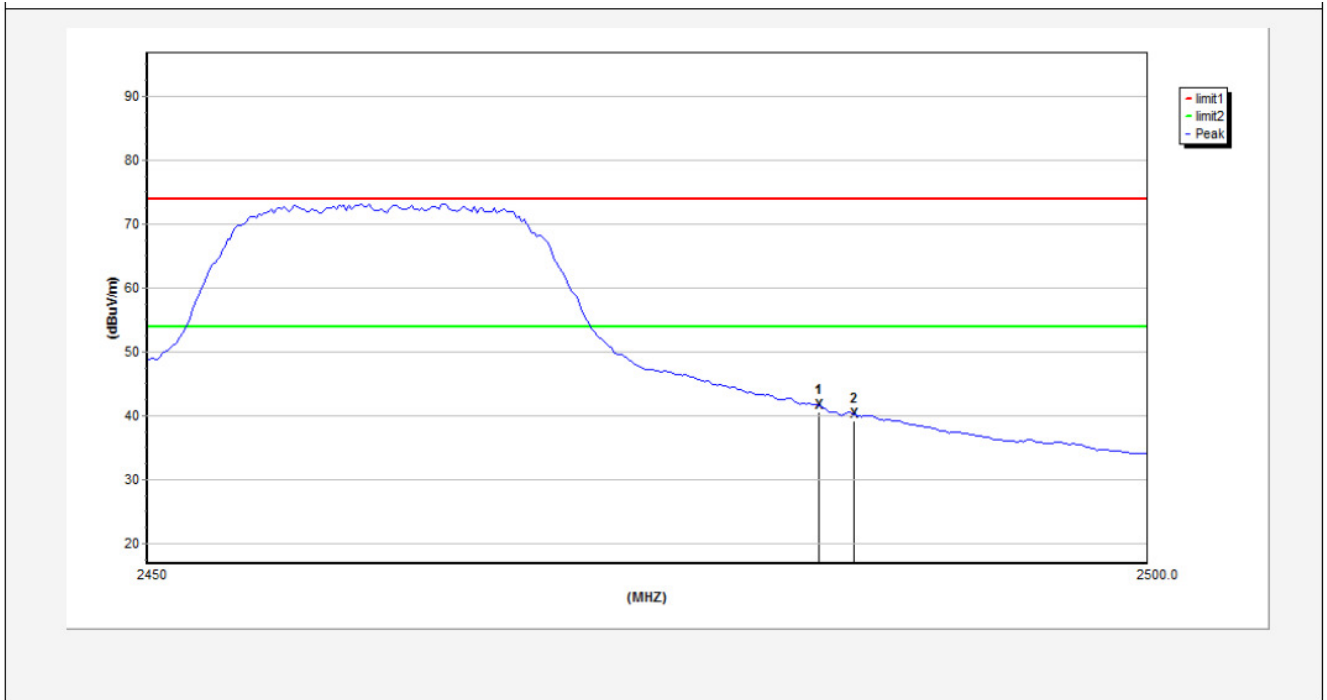

No.	Freq. (MHz)	Reading (dBuV/m)	Antenna (dB/m)	Amp. (dB/m)	Cable (dB/m)	Result (dBuV/m)	Limit (dBuV/m)	Over Limit (dB)	Detector	Height (cm)	degree (deg)
1	2483.5000	42.77	29.28	34.03	3.53	41.55	54.00	-12.45	AVG	---	---
2	2485.2500	41.40	29.28	34.03	3.54	40.19	54.00	-13.81	AVG	---	---

Anbotek

Test Mode: 802.11n (HT20)

2412MHz

Horizontal-PEAK:

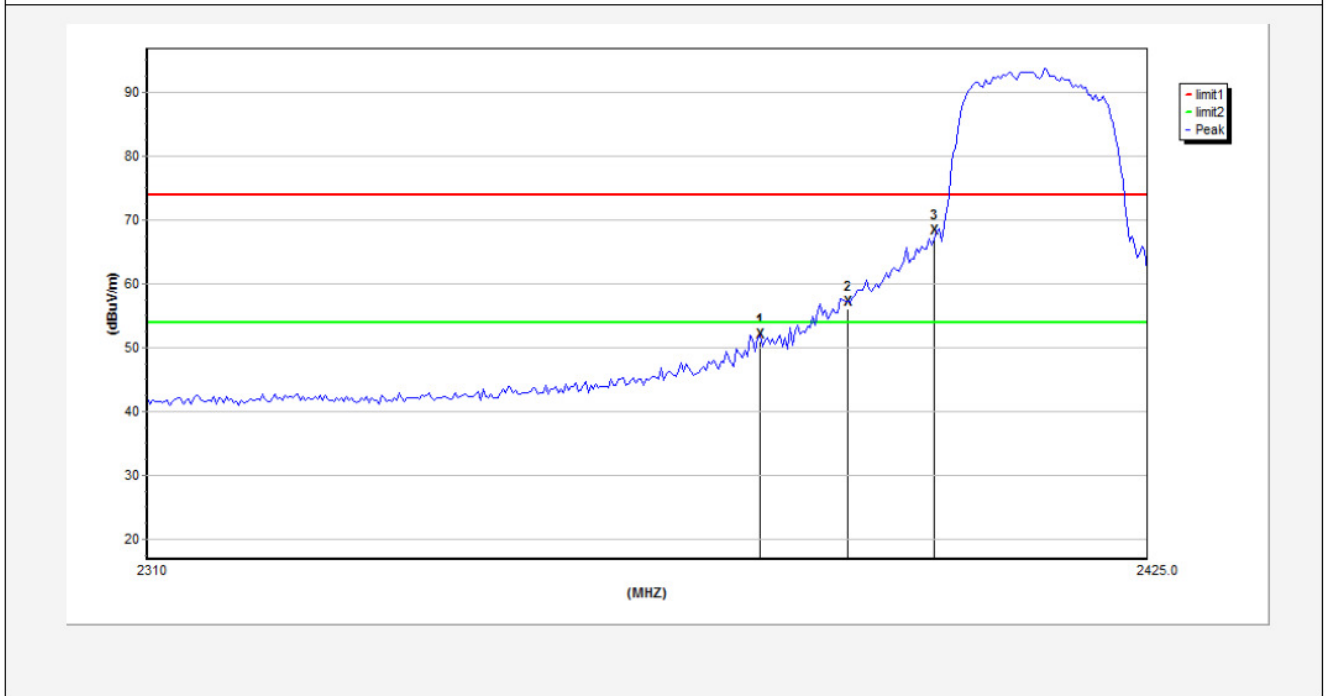

No.	Freq. (MHz)	Reading (dBuV/m)	Antenna (dB/m)	Amp. (dB/m)	Cable (dB/m)	Result (dBuV/m)	Limit (dBuV/m)	Over Limit (dB)	Detector	Height (cm)	degree (deg)
1	2379.8630	53.52	29.13	34.01	3.4	52.04	74.00	-21.96	peak	---	---
2	2390.0000	58.64	29.15	34.01	3.41	57.19	74.00	-16.81	peak	---	---
3	2400.0000	69.71	29.16	34.01	3.43	68.29	74.00	-5.71	peak	---	---

AMB

Horizontal-AV:

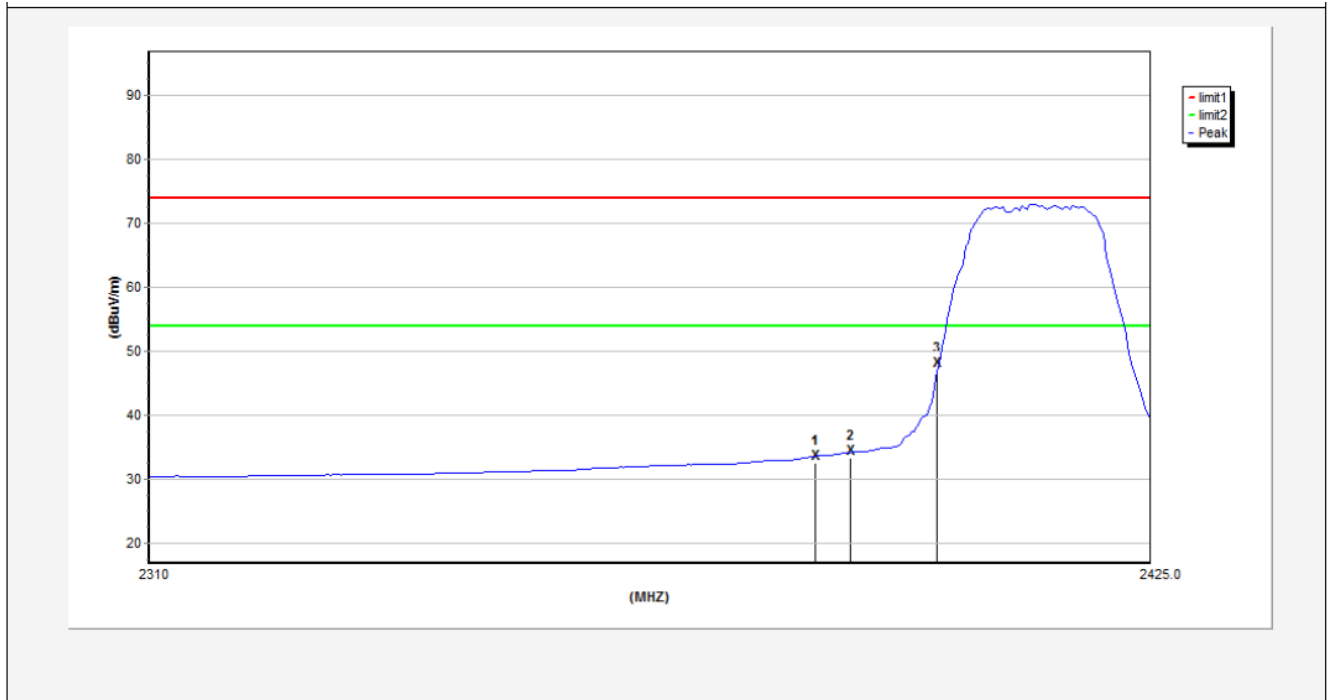

No.	Freq. (MHz)	Reading (dBuV/m)	Antenna (dB/m)	Amp. (dB/m)	Cable (dB/m)	Result (dBuV/m)	Limit (dBuV/m)	Over Limit (dB)	Detector	Height (cm)	degree (deg)
1	2385.9000	35.09	29.14	34.01	3.41	33.63	54.00	-20.37	AVG	---	---
2	2390.0000	35.71	29.15	34.01	3.41	34.26	54.00	-19.74	AVG	---	---
3	2400.0000	49.48	29.16	34.01	3.43	48.06	54.00	-5.94	AVG	---	---

Anbotek

Test Mode: 802.11n (HT20)

2412MHz

Vertical-PEAK:

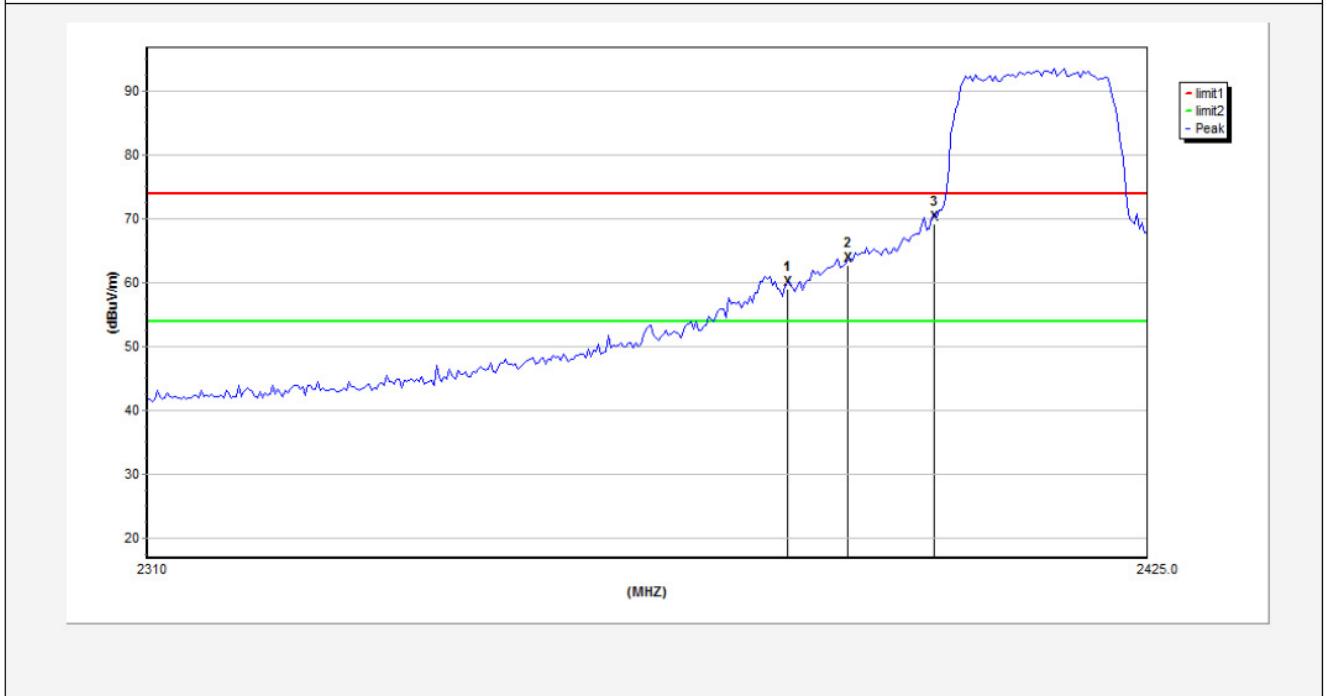

No.	Freq. (MHz)	Reading (dBuV/m)	Antenna (dB/m)	Amp. (dB/m)	Cable (dB/m)	Result (dBuV/m)	Limit (dBuV/m)	Over Limit (dB)	Detector	Height (cm)	degree (deg)
1	2383.0250	61.59	29.14	34.01	3.4	60.12	74.00	-13.88	peak	---	---
2	2390.0000	65.27	29.15	34.01	3.41	63.82	74.00	-10.18	peak	---	---
3	2400.0000	71.59	29.16	34.01	3.43	70.17	74.00	-3.83	peak	---	---

Vertical-AV:

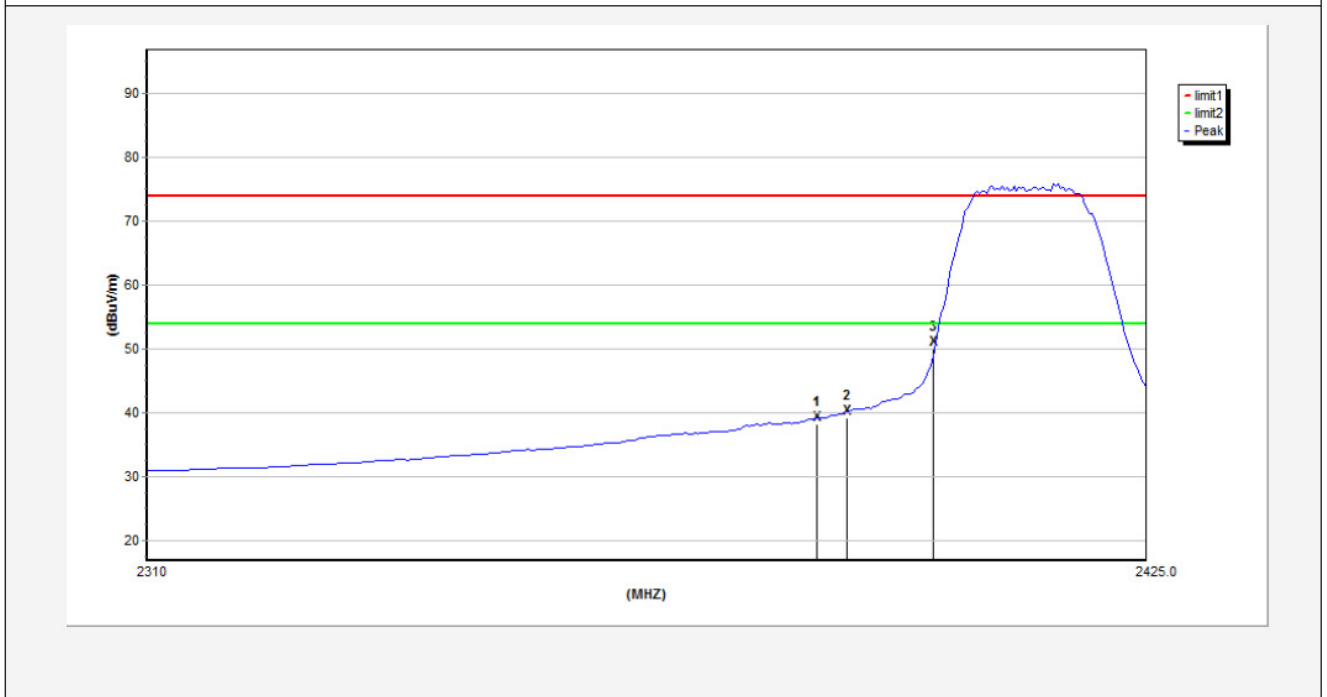

No.	Freq. (MHz)	Reading (dBuV/m)	Antenna (dB/m)	Amp. (dB/m)	Cable (dB/m)	Result (dBuV/m)	Limit (dBuV/m)	Over Limit (dB)	Detector	Height (cm)	degree (deg)
1	2386.4750	40.62	29.14	34.01	3.41	39.16	54.00	-14.84	AVG	---	---
2	2390.0000	41.65	29.15	34.01	3.41	40.20	54.00	-13.80	AVG	---	---
3	2400.0000	52.42	29.16	34.01	3.43	51.00	54.00	-3.00	AVG	---	---

Anbotek

Test Mode: 802.11n (HT20)

2462MHz

Horizontal-PEAK:

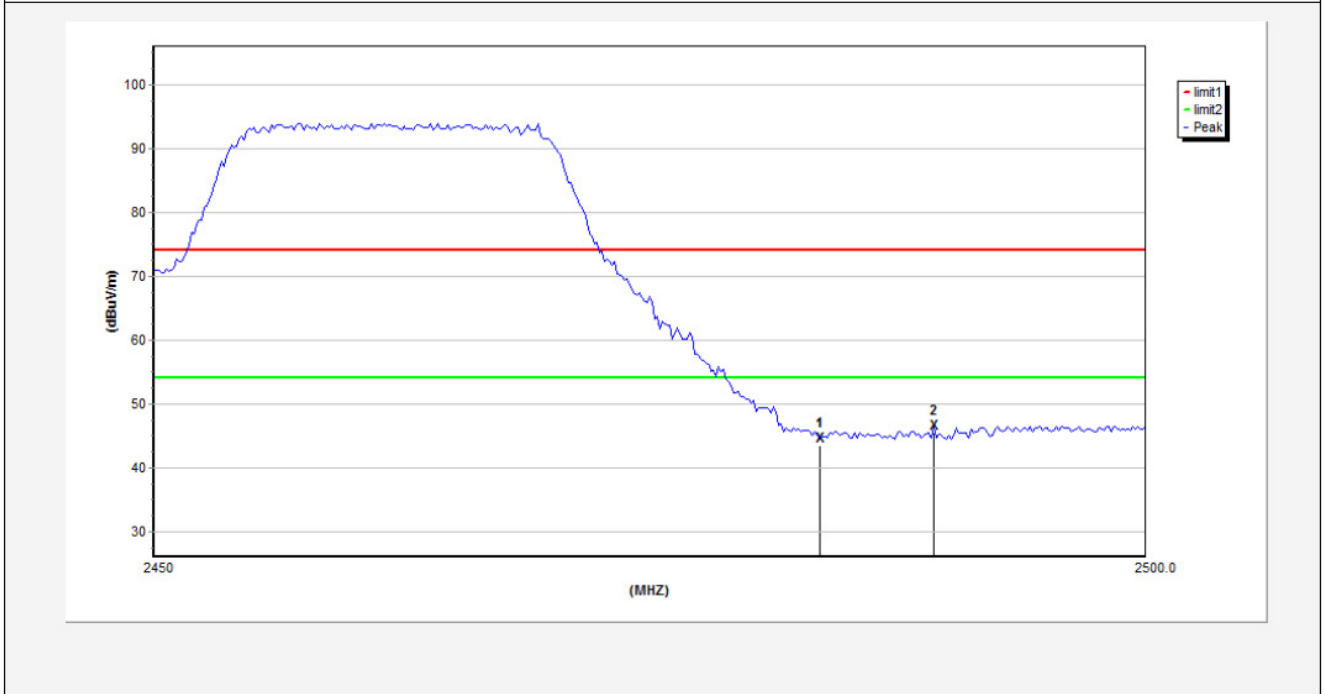

No.	Freq. (MHz)	Reading (dBuV/m)	Antenna (dB/m)	Amp. (dB/m)	Cable (dB/m)	Result (dBuV/m)	Limit (dBuV/m)	Over Limit (dB)	Detector	Height (cm)	degree (deg)
1	2483.5000	45.74	29.28	34.03	3.53	44.52	74.00	-29.48	peak	---	---
2	2489.2500	47.51	29.28	34.03	3.54	46.30	74.00	-27.70	peak	---	---

Anbotek

Horizontal-AV:

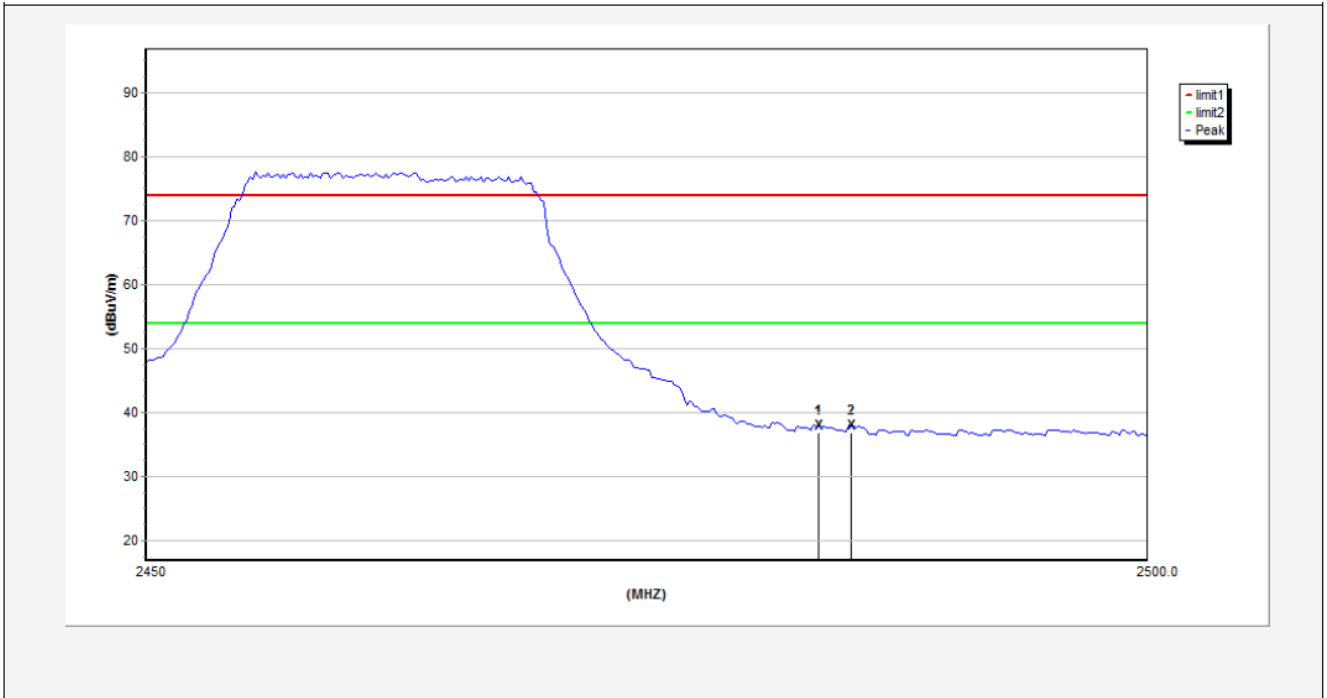

No.	Freq. (MHz)	Reading (dBuV/m)	Antenna (dB/m)	Amp. (dB/m)	Cable (dB/m)	Result (dBuV/m)	Limit (dBuV/m)	Over Limit (dB)	Detector	Height (cm)	degree (deg)
1	2483.5000	39.02	29.28	34.03	3.53	37.80	54.00	-16.20	AVG	---	---
2	2485.1250	39.11	29.28	34.03	3.54	37.90	54.00	-16.10	AVG	---	---

Anbotek

Test Mode: 802.11n (HT20)

2462MHz

Vertical-PEAK:

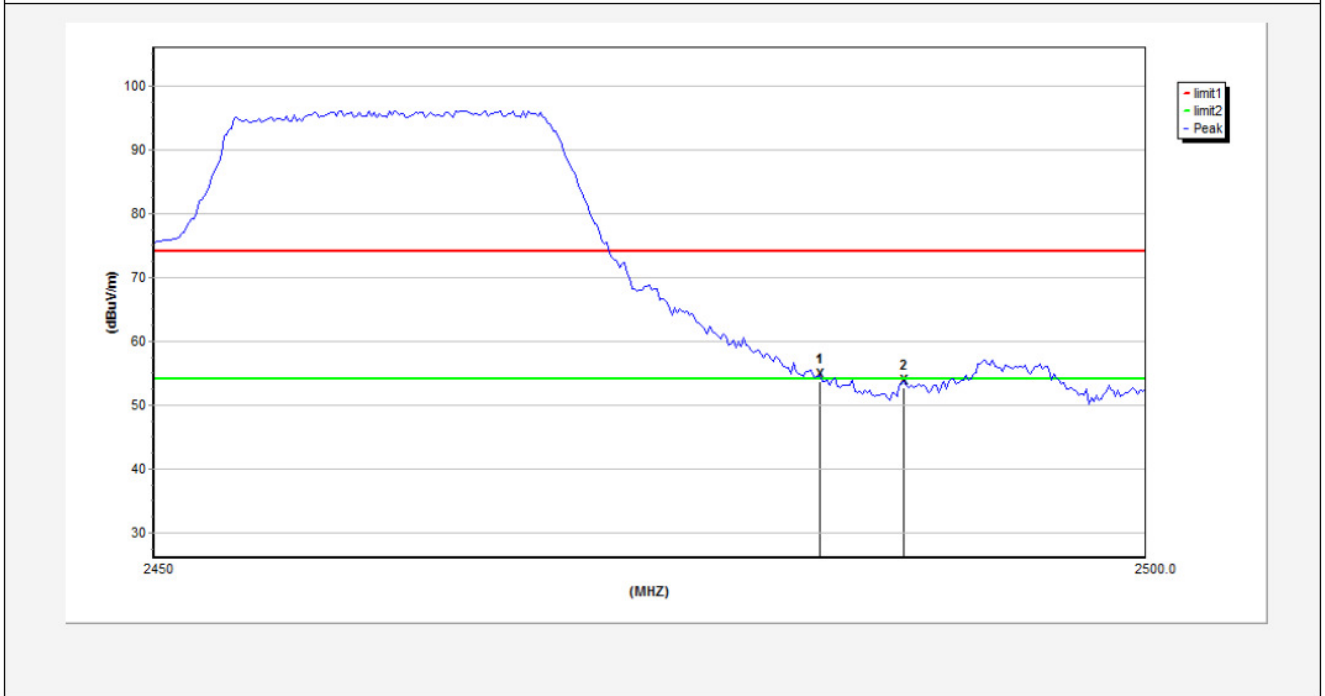

No.	Freq. (MHz)	Reading (dBuV/m)	Antenna (dB/m)	Amp. (dB/m)	Cable (dB/m)	Result (dBuV/m)	Limit (dBuV/m)	Over Limit (dB)	Detector	Height (cm)	degree (deg)
1	2483.5000	55.84	29.28	34.03	3.53	54.62	74.00	-19.38	peak	---	---
2	2487.7500	54.86	29.28	34.03	3.54	53.65	74.00	-20.35	peak	---	---

Anbotek

Vertical-AV:

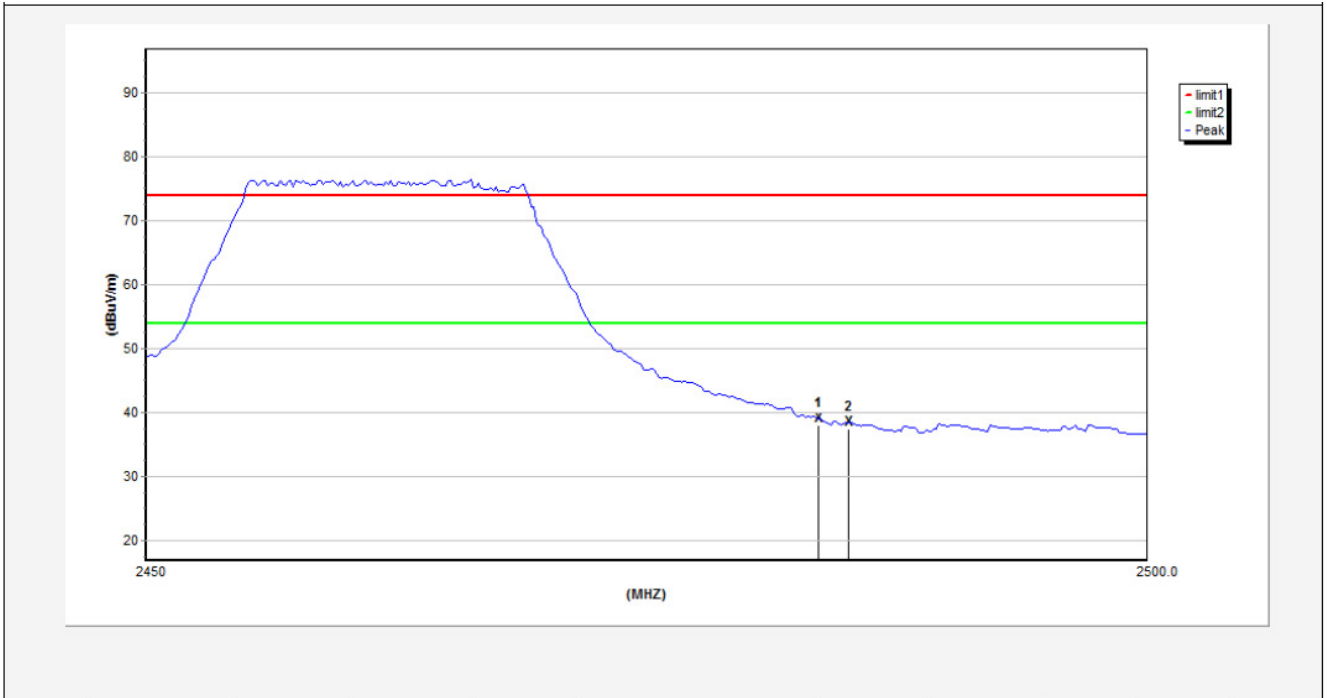

No.	Freq. (MHz)	Reading (dBuV/m)	Antenna (dB/m)	Amp. (dB/m)	Cable (dB/m)	Result (dBuV/m)	Limit (dBuV/m)	Over Limit (dB)	Detector	Height (cm)	degree (deg)
1	2483.5000	40.27	29.28	34.03	3.53	39.05	54.00	-14.95	AVG	---	---
2	2485.0000	39.77	29.28	34.03	3.54	38.56	54.00	-15.44	AVG	---	---

Anbotek

Test Mode: 802.11n (HT40)

2422MHz

Horizontal-PEAK:

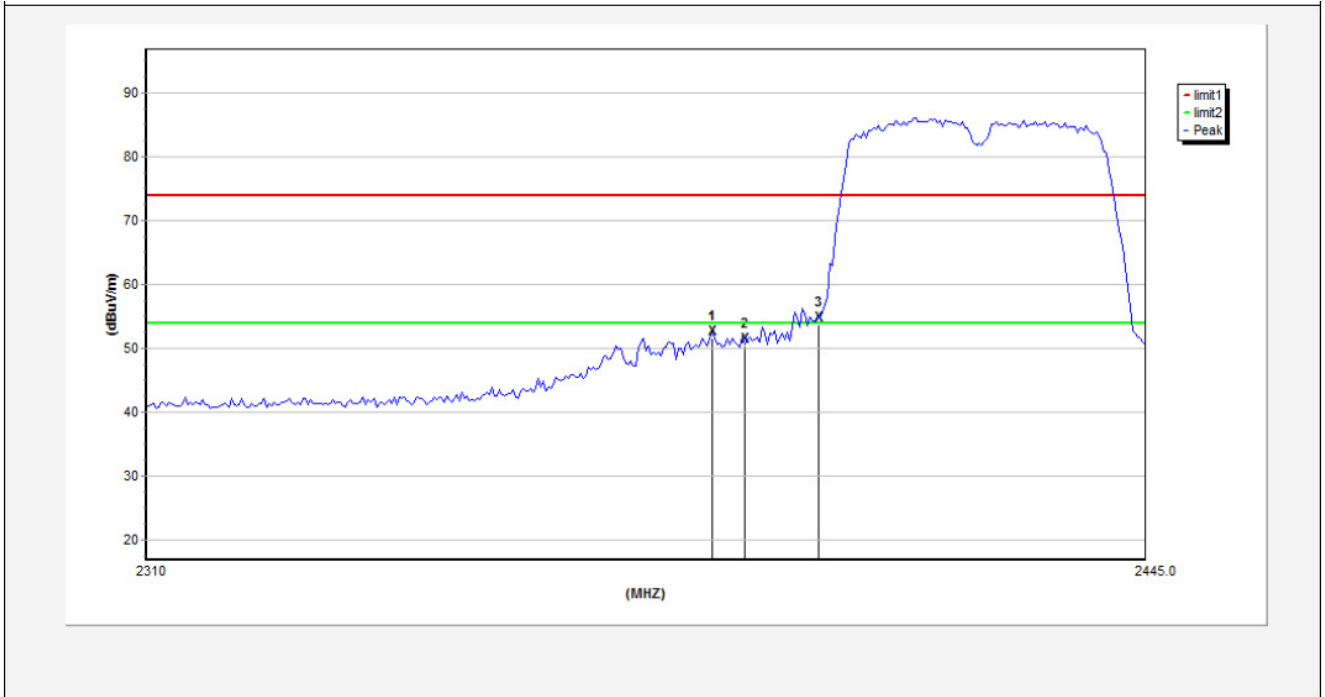

No.	Freq. (MHz)	Reading (dBuV/m)	Antenna (dB/m)	Amp. (dB/m)	Cable (dB/m)	Result (dBuV/m)	Limit (dBuV/m)	Over Limit (dB)	Detector	Height (cm)	degree (deg)
1	2385.6000	54.12	29.14	34.01	3.41	52.66	74.00	-21.34	peak	---	---
2	2390.0000	52.77	29.15	34.01	3.41	51.32	74.00	-22.68	peak	---	---
3	2400.0000	56.16	29.16	34.01	3.43	54.74	74.00	-19.26	peak	---	---

Anbotek

Horizontal-AV:

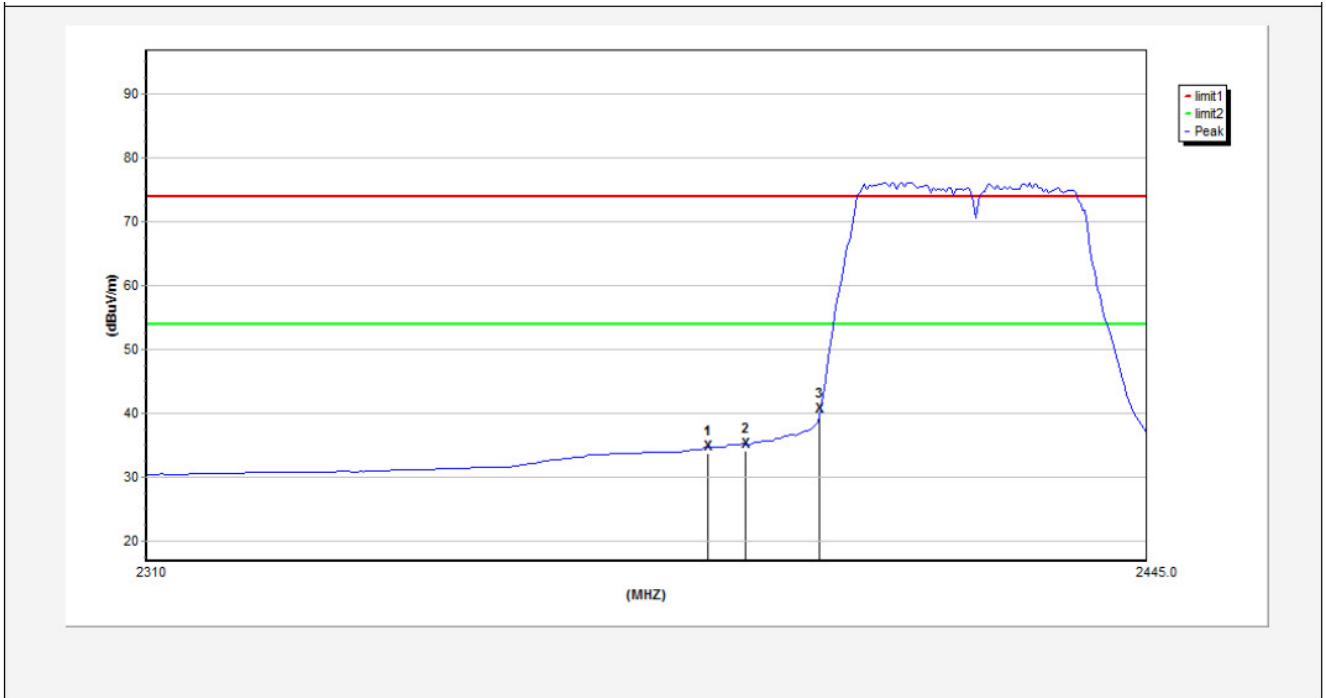

No.	Freq. (MHz)	Reading (dBuV/m)	Antenna (dB/m)	Amp. (dB/m)	Cable (dB/m)	Result (dBuV/m)	Limit (dBuV/m)	Over Limit (dB)	Detector	Height (cm)	degree (deg)
1	2384.9250	36.19	29.14	34.01	3.41	34.73	54.00	-19.27	AVG	---	---
2	2390.0000	36.53	29.15	34.01	3.41	35.08	54.00	-18.92	AVG	---	---
3	2400.0000	42.03	29.16	34.01	3.43	40.61	54.00	-13.39	AVG	---	---

Anbotek

Test Mode: 802.11n (HT40)

2422MHz

Vertical-PEAK:

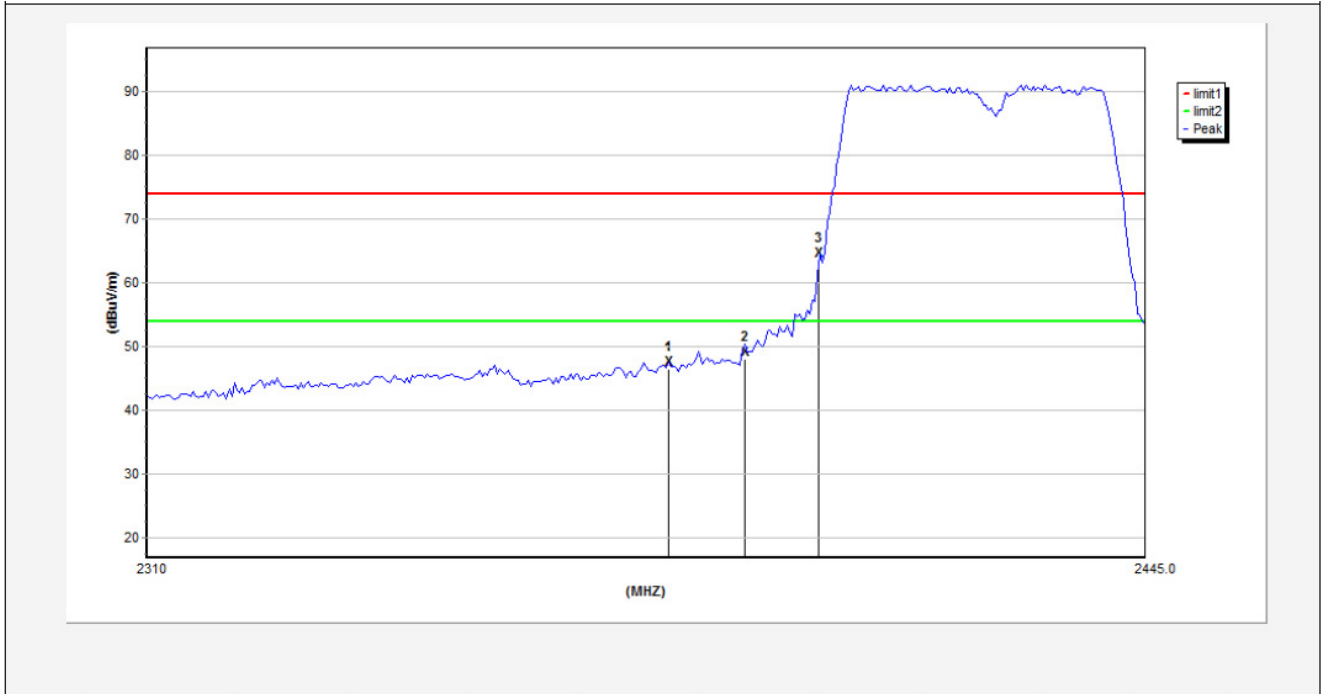

No.	Freq. (MHz)	Reading (dBuV/m)	Antenna (dB/m)	Amp. (dB/m)	Cable (dB/m)	Result (dBuV/m)	Limit (dBuV/m)	Over Limit (dB)	Detector	Height (cm)	degree (deg)
1	2379.5250	49.05	29.13	34.01	3.4	47.57	74.00	-26.43	peak	---	---
2	2390.0000	50.47	29.15	34.01	3.41	49.02	74.00	-24.98	peak	---	---
3	2400.0000	66.00	29.16	34.01	3.43	64.58	74.00	-9.42	peak	---	---

Anbotek

Vertical-AV:

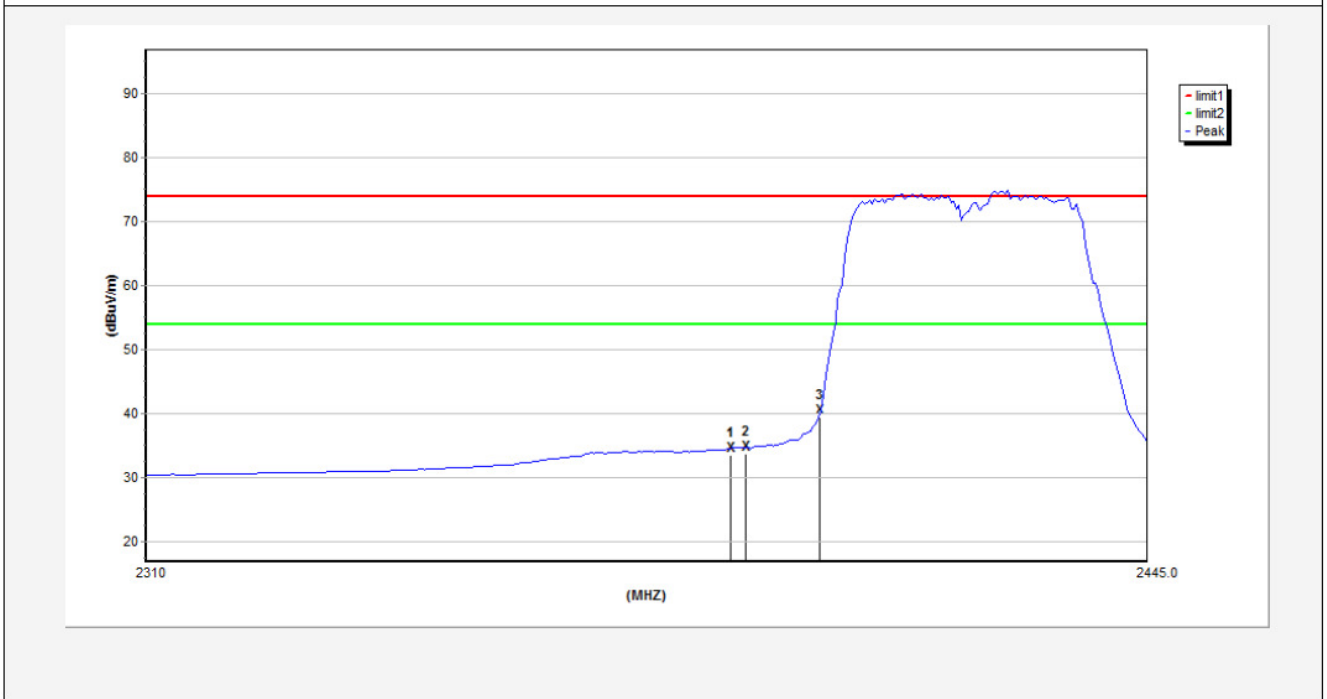

No.	Freq. (MHz)	Reading (dBuV/m)	Antenna (dB/m)	Amp. (dB/m)	Cable (dB/m)	Result (dBuV/m)	Limit (dBuV/m)	Over Limit (dB)	Detector	Height (cm)	degree (deg)
1	2387.9625	36.06	29.14	34.01	3.41	34.60	54.00	-19.40	AVG	---	---
2	2390.0000	36.14	29.15	34.01	3.41	34.69	54.00	-19.31	AVG	---	---
3	2400.0000	41.80	29.16	34.01	3.43	40.38	54.00	-13.62	AVG	---	---

Anbotek

Test Mode: 802.11n (HT40)

2452MHz

Horizontal-PEAK:

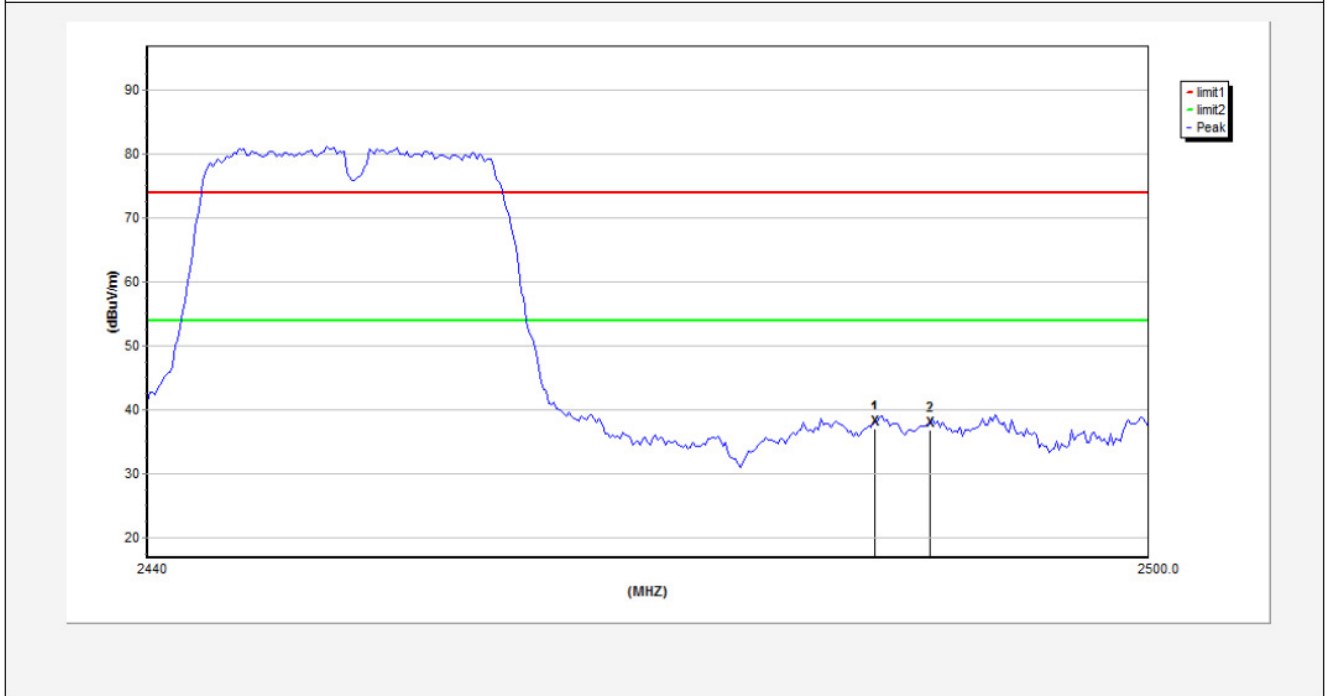

No.	Freq. (MHz)	Reading (dBuV/m)	Antenna (dB/m)	Amp. (dB/m)	Cable (dB/m)	Result (dBuV/m)	Limit (dBuV/m)	Over Limit (dB)	Detector	Height (cm)	degree (deg)
1	2483.5000	39.36	29.28	34.03	3.53	38.14	74.00	-35.86	peak	---	---
2	2486.8000	39.11	29.28	34.03	3.54	37.90	74.00	-36.10	peak	---	---

Anbotek

Horizontal-AV:

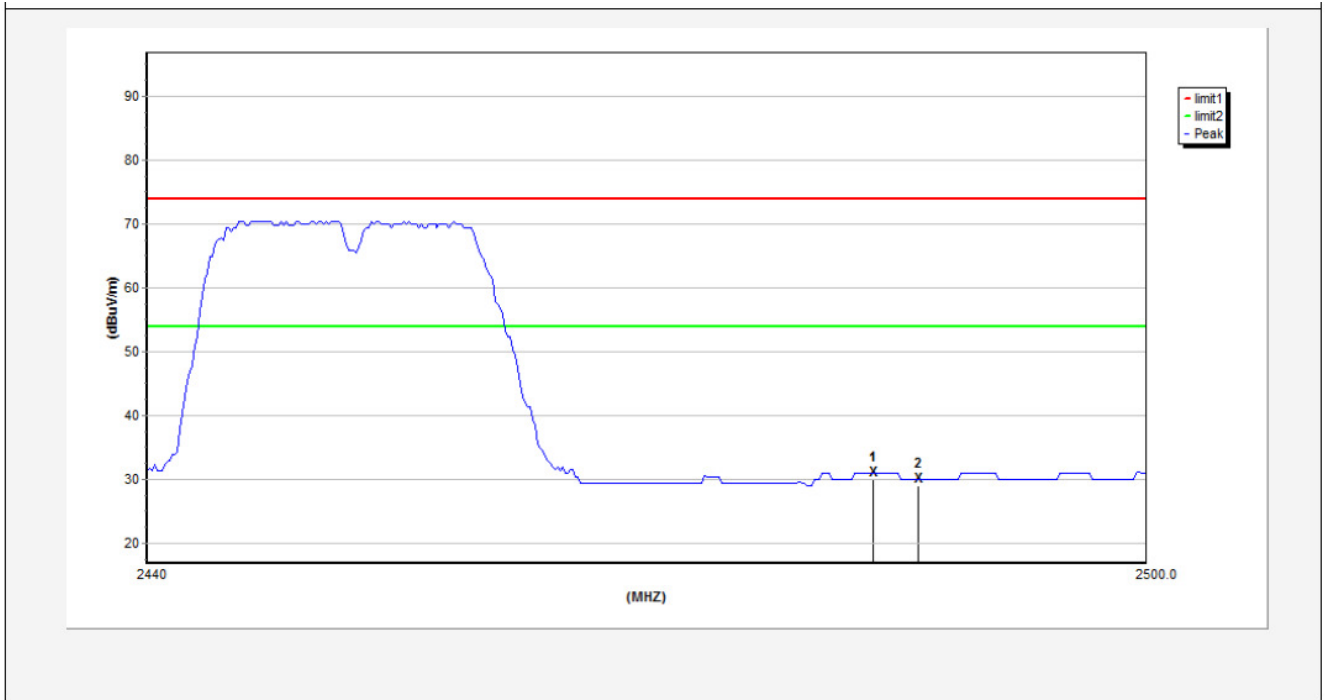

No.	Freq. (MHz)	Reading (dBuV/m)	Antenna (dB/m)	Amp. (dB/m)	Cable (dB/m)	Result (dBuV/m)	Limit (dBuV/m)	Over Limit (dB)	Detector	Height (cm)	degree (deg)
1	2483.5000	32.28	29.28	34.03	3.53	31.06	54.00	-22.94	AVG	---	---
2	2486.2000	31.28	29.28	34.03	3.54	30.07	54.00	-23.93	AVG	---	---

Anbotek

Test Mode: 802.11n (HT40)
2452MHz
Vertical-PEAK:

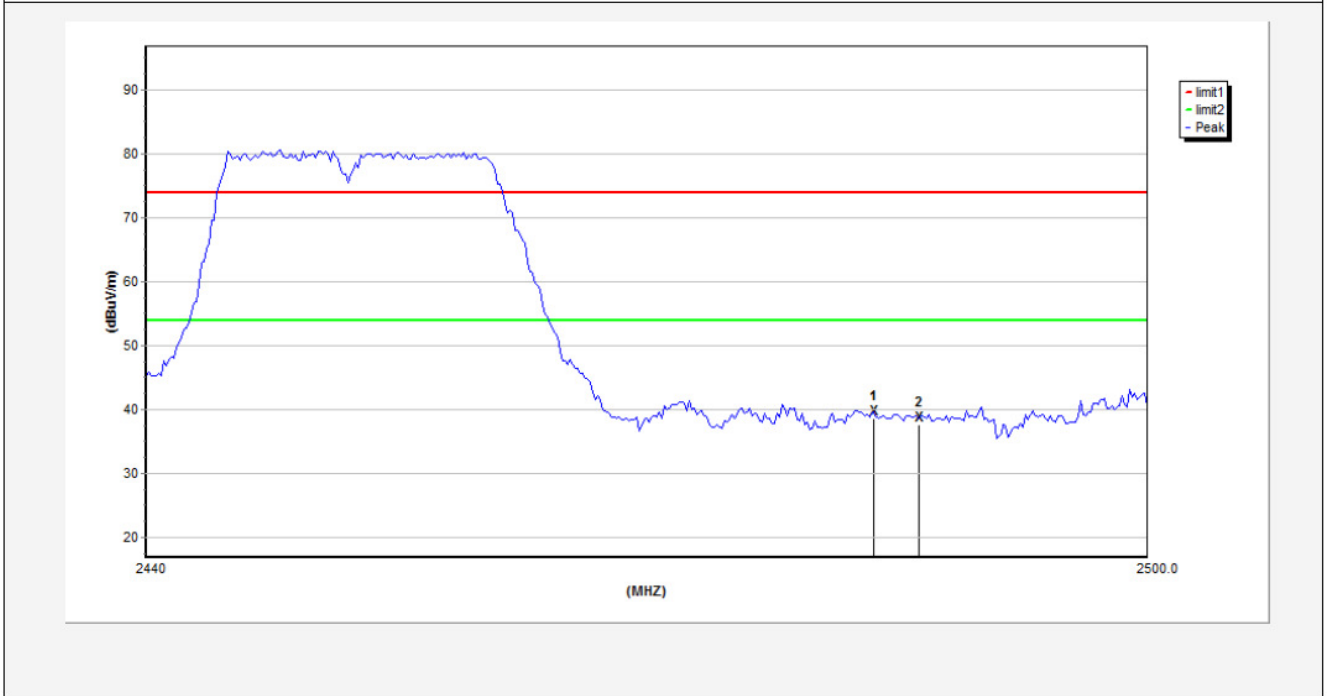

No.	Freq. (MHz)	Reading (dBuV/m)	Antenna (dB/m)	Amp. (dB/m)	Cable (dB/m)	Result (dBuV/m)	Limit (dBuV/m)	Over Limit (dB)	Detector	Height (cm)	degree (deg)
1	2483.5000	40.85	29.28	34.03	3.53	39.63	74.00	-34.37	peak	---	---
2	2486.2000	39.87	29.28	34.03	3.54	38.66	74.00	-35.34	peak	---	---

Anbotek

Vertical-AV:

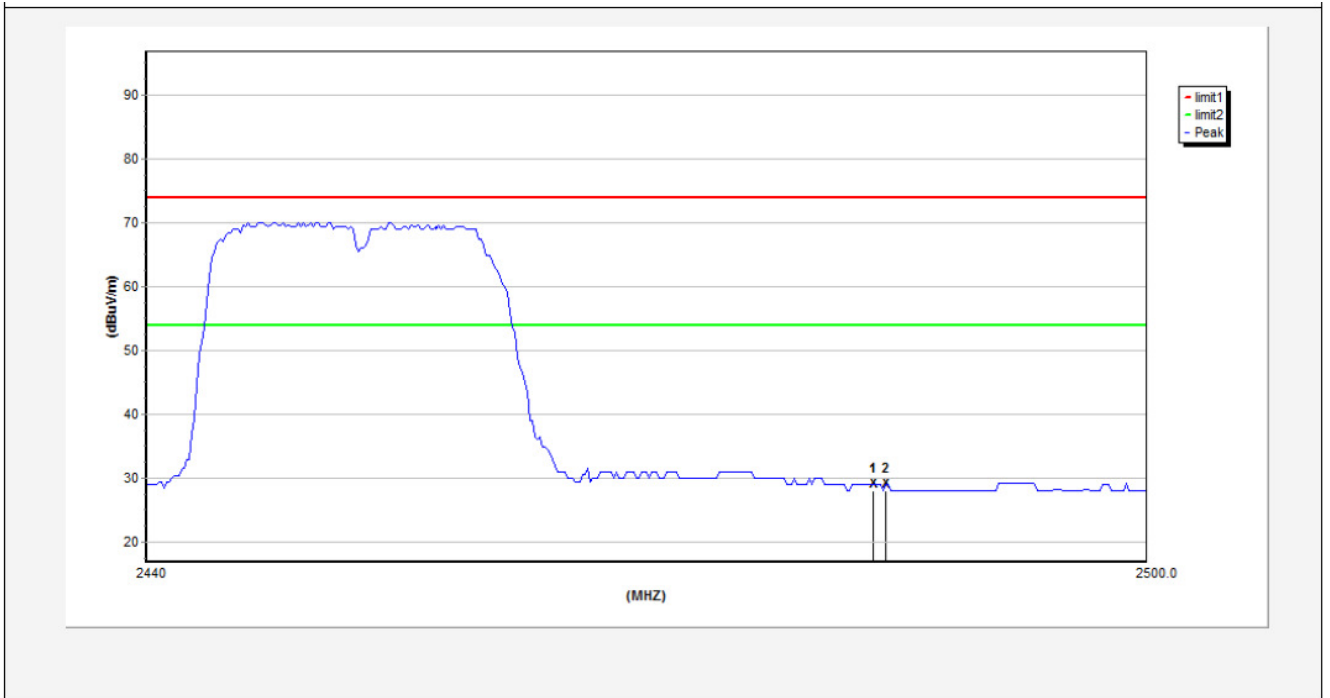

No.	Freq. (MHz)	Reading (dBuV/m)	Antenna (dB/m)	Amp. (dB/m)	Cable (dB/m)	Result (dBuV/m)	Limit (dBuV/m)	Over Limit (dB)	Detector	Height (cm)	degree (deg)
1	2483.5000	30.32	29.28	34.03	3.53	29.10	54.00	-24.90	AVG	---	---
2	2484.2500	30.31	29.28	34.03	3.54	29.10	54.00	-24.90	AVG	---	---

Anbotek

4.5. Peak Power Spectral Density

a. Limit

1. For direct sequence systems, the peak power spectral density conducted from the intentional radiator to the antenna shall not be greater than 8dBm in any 3kHz band during any time interval of continuous transmission.
2. The direct sequence operating of the hybrid system, with the frequency hopping operation turned off, shall comply with the power density requirements of paragraph (d) of this section.

b. Test Procedure

1. Place the EUT on the table and set it in transmitting mode. Remove the antenna from the EUT and then connect a low loss RF cable from the antenna port to the spectrum analyzer.
2. Set the spectrum analyzer as RBW = 3.0kHz, VBW = 10kHz, Span = 1.5xDTS BW
3. Record the max. reading.
4. Repeat the above procedure until the measurements for all frequencies are completed.

c. Test Equipment

Same as the equipment listed in 4.2.

d. Test Setup

See 4.1

e. Test Results

Pass

f. Test Data

Please refer to the following data.

g. Test Plot See the following pages

Test mode: IEEE 802.11b

Channel	Frequency (MHz)	PPSD (dBm/3KHz)	∑PPSD (dBm/3KHz)	Limit (dBm)	Result
Low	2412	-11.663	-	8.00	Pass
Mid	2437	-13.279	-		Pass
High	2462	-12.733	-		Pass

Test mode: IEEE 802.11g

Channel	Frequency (MHz)	PPSD (dBm)	∑PPSD (dBm)	Limit (dBm)	Result
Low	2412	-16.145	-	8.00	Pass
Mid	2437	-16.702	-		Pass
High	2462	-17.649	-		Pass

Test mode: IEEE 802.11n (HT20)

Channel	Frequency (MHz)	PPSD (dBm/3KHz)	∑PPSD (dBm/3KHz)	Limit (dBm)	Result
Low	2412	-17.443	-	8.00	Pass
Mid	2437	-17.780	-		Pass
High	2462	-19.330	-		Pass

Test mode: IEEE 802.11n (HT40)

Channel	Frequency (MHz)	PPSD (dBm/3KHz)	∑PPSD (dBm/3KHz)	Limit (dBm)	Result
Low	2422	-22.618	-	8.00	Pass
Mid	2437	-21.702	-		Pass
High	2452	-22.232	-		Pass

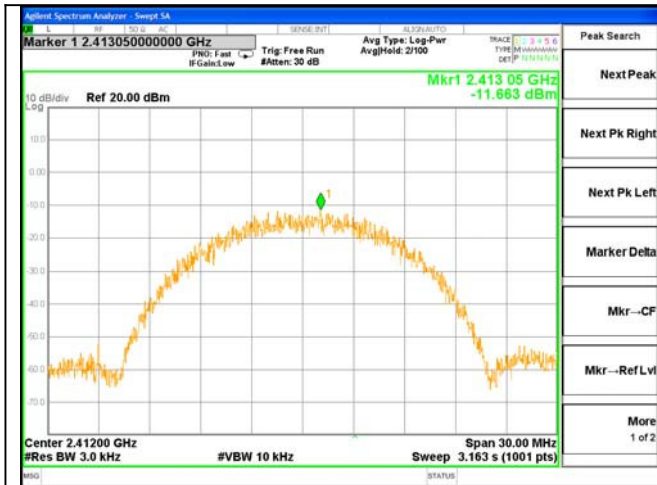

Test Mode: 802.11b---Low

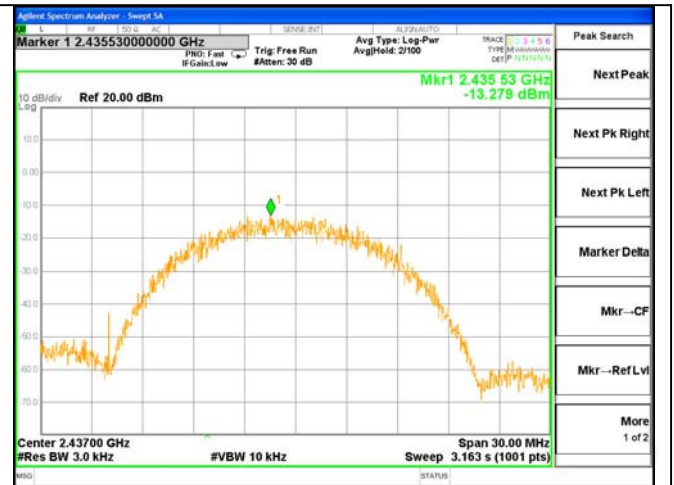

Test Mode: 802.11b---Mid

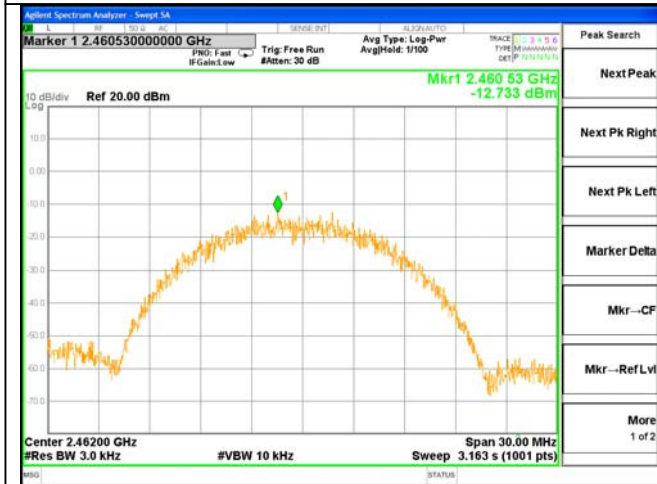

Test Mode: 802.11b---High

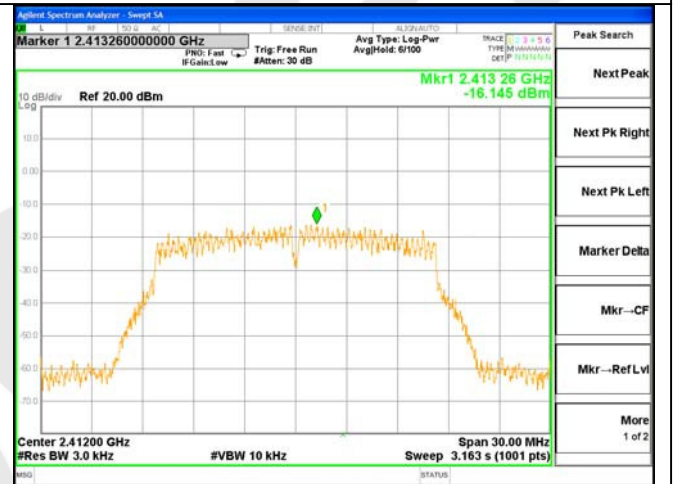

Test Mode: 802.11g---Low

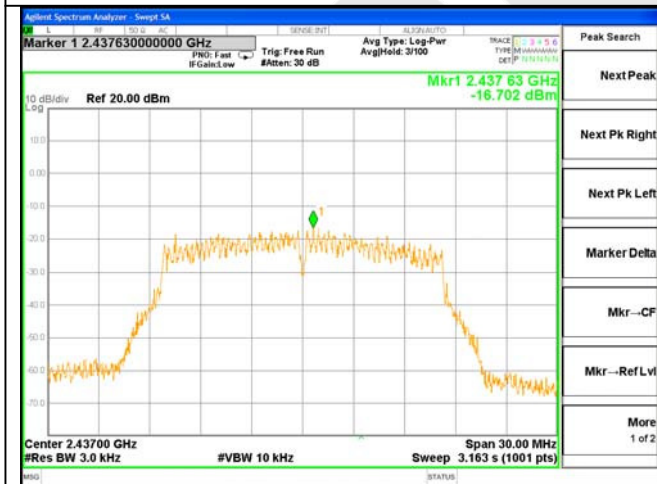

Test Mode: 802.11g---Mid

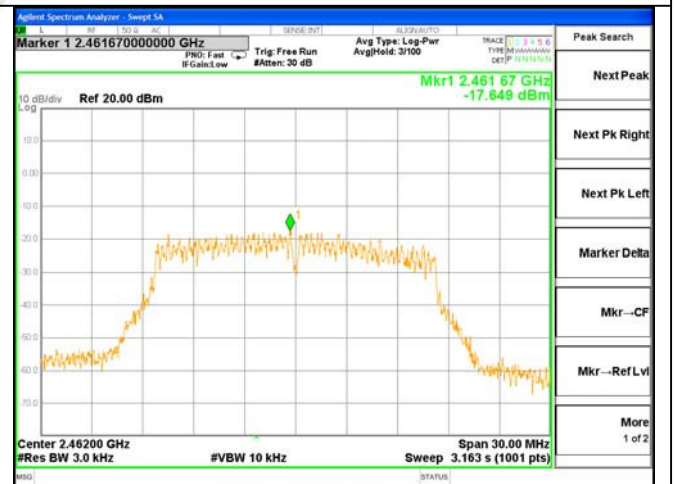

Test Mode: 802.11g---High

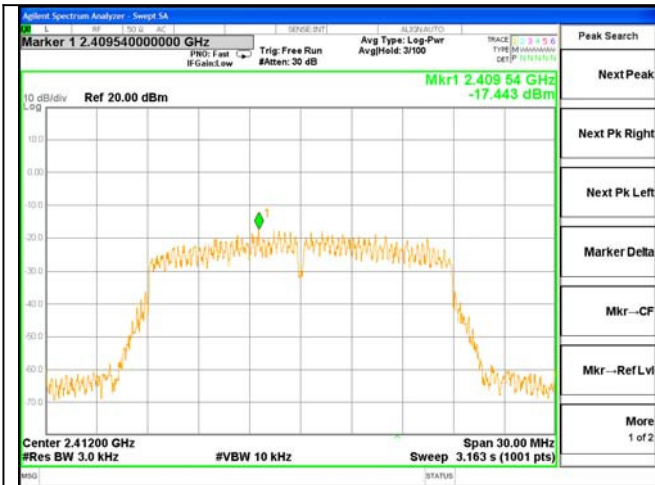

Test Mode: 802.11n20---Low

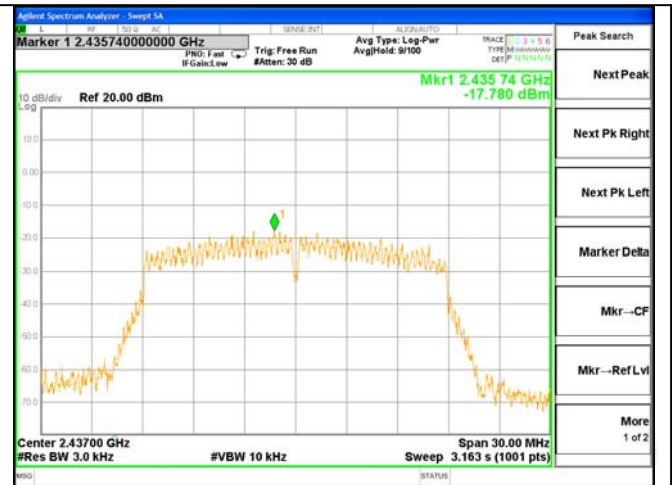

Test Mode: 802.11n20---Mid

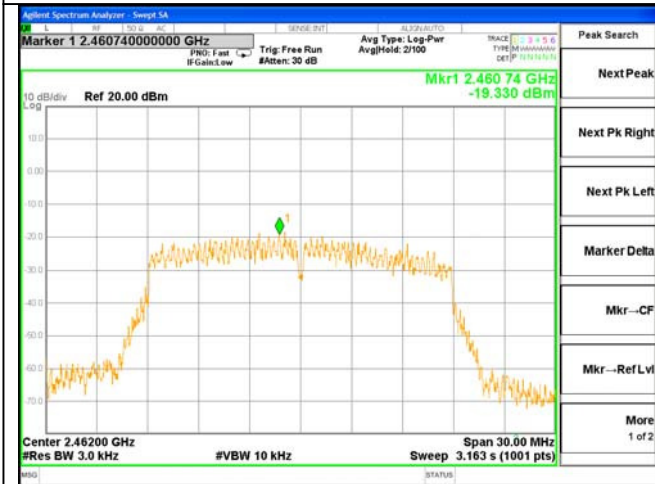

Test Mode: 802.11n20---High

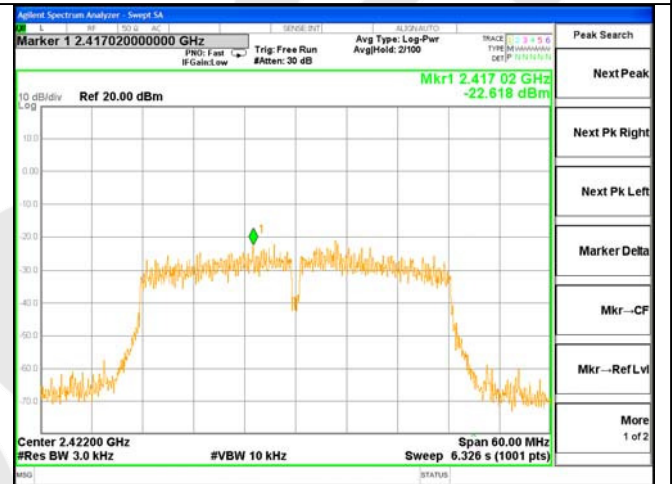

Test Mode: 802.11n40---Low

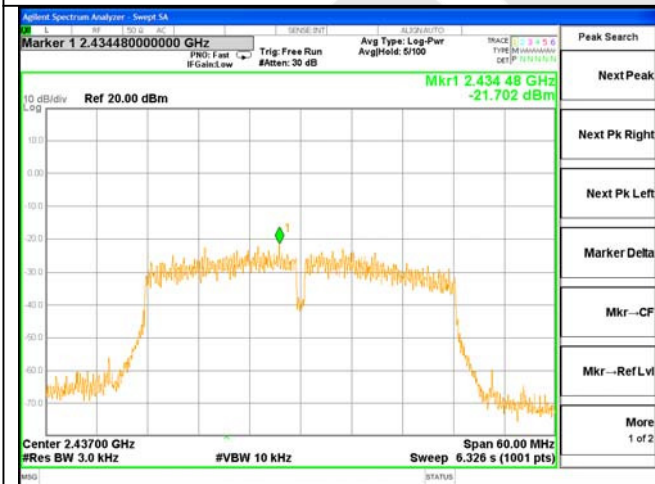

Test Mode: 802.11n40---Mid

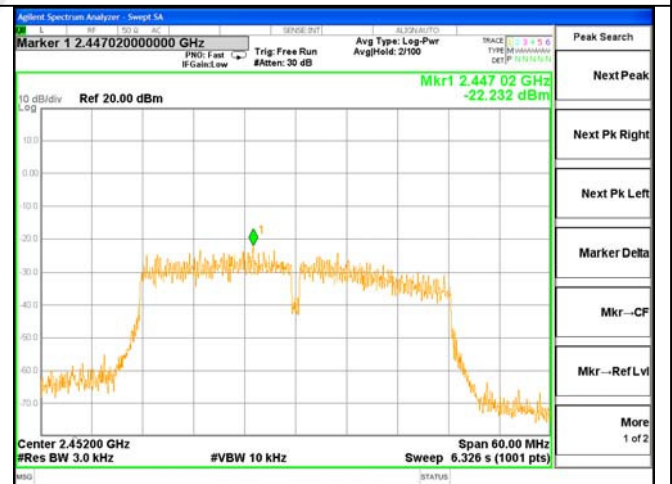

Test Mode: 802.11n40---High

4.6. Radiated Emissions

4.6.1.1. Test Limits (< 30 MHz)

Frequency (MHz)	Field Strength (microvolts/meter)	Measurement Distance (meter)
0.009-0.490	2400/F(kHz)	300
0.490-1.705	24000/F(kHz)	30
1.705-30.0	30	30

4.6.1.2. Test Limits (≥ 30 MHz)

FIELD STRENGTH of Fundamental: @3M	FIELD STRENGTH of Harmonics	S15.209 30 - 88 MHz	40 dBuV/m
902-928 MHz		88 - 216 MHz	43.5
2.4-2.4835 GHz		216 - 960 MHz	46
94 dBμV/m @3m	54 dBμV/m @3m	ABOVE 960 MHz	54dBuV/m

In any 100 kHz bandwidth outside the frequency band in which the spread spectrum or digitally modulated intentional radiator is operating, the radio frequency power that is produced by the intentional radiator shall be at least 20 dB below that in the 100 kHz bandwidth within the band that contains the highest level of the desired power, based on either an RF conducted or a radiated measurement. Attenuation below the general limits specified in Section 15.209(a) is not required. In addition, radiated emissions which fall in the restricted bands, as defined in Section 15.205(a), must also comply with the radiated emission limits specified in Section 15.209(a) (see Section 15.205(c)).

Test Equipment

Item	Equipment	Manufacturer	Model No.	Serial No.	Last Cal.	Cal. Interval
1.	Spectrum Analysis	Agilent	E4407B	US39390582	Jul. 12, 2016	1 Year
2.	Preamplifier	Instruments corporation	EMC011830	980100	Jun. 17, 2016	1 Year
3.	EMI Test Receiver	Rohde & Schwarz	ESPI	101604	Jun. 17, 2016	1 Year
4.	Double Ridged Horn Antenna	Instruments corporation	GTH-0118	351600	May 06, 2016	1 Year
5.	Bilog Broadband Antenna	Schwarzbeck	VULB9163	VULB 9163-289	May 06, 2016	1 Year
6.	Pre-amplifier	SONOMA	310N	186860	Jun. 17, 2016	1 Year
7.	EMI Test Software EZ-EMC	SHURPLE	N/A	N/A	N/A	N/A
8.	Power Sensor	DAER	RPR3006W	15I00041SN046	Jun. 17, 2016	1 Year
9.	MXA Spectrum Analysis	Agilent	N9020A	MY51170037	Jun. 17, 2016	1 Year
10.	MXG RF Vector Signal Generator	Agilent	N5182A	MY48180656	Jun. 17, 2016	1 Year
11.	Signal Generator	Agilent	E4421B	MY41000743	Jun. 17, 2016	1 Year
12.	DC Power supply	IV	IV-8080	YQSB0096	Jun. 17, 2016	1 Year
13.	TEMP&HUMI PROGRAMMABLE CHAMBER	Bell Group	BE-THK-15 0M8	SE-0137	Jun. 17, 2016	1 Year

4.6.2. Test Configuration:

4.6.2.1. 9k to 30MHz emissions:

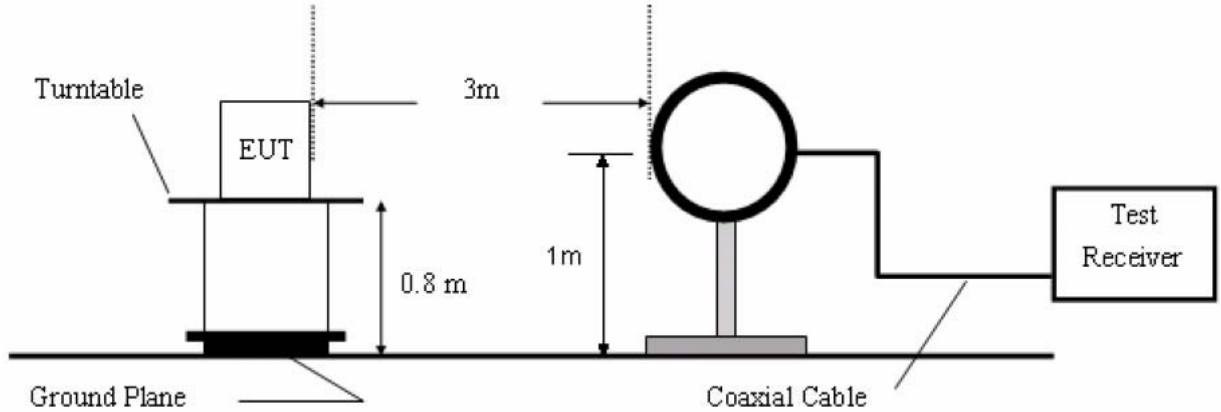

4.6.2.2. 30M to 1G emissions:

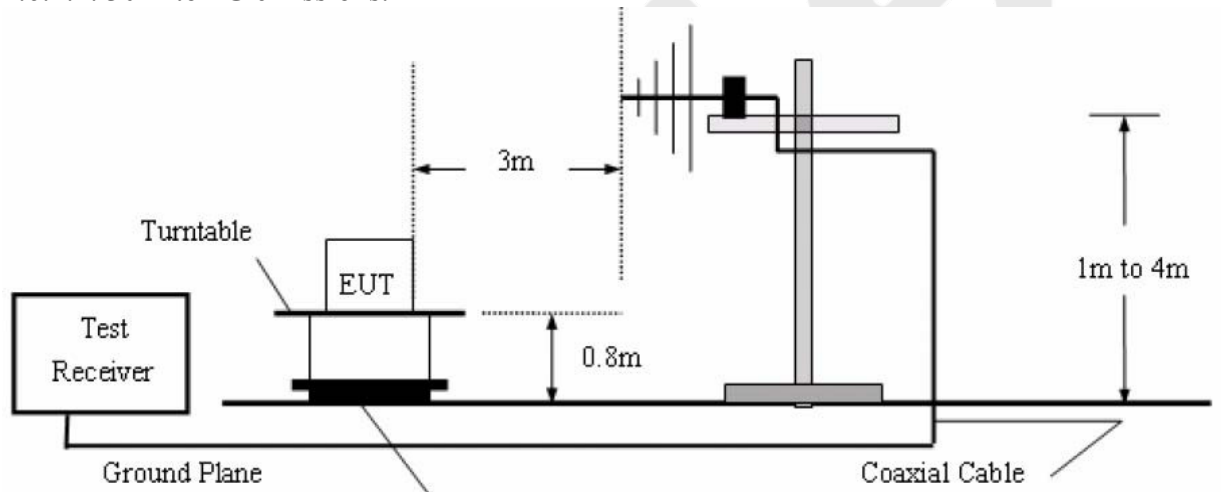

4.6.2.3. 1G to 40G emissions:

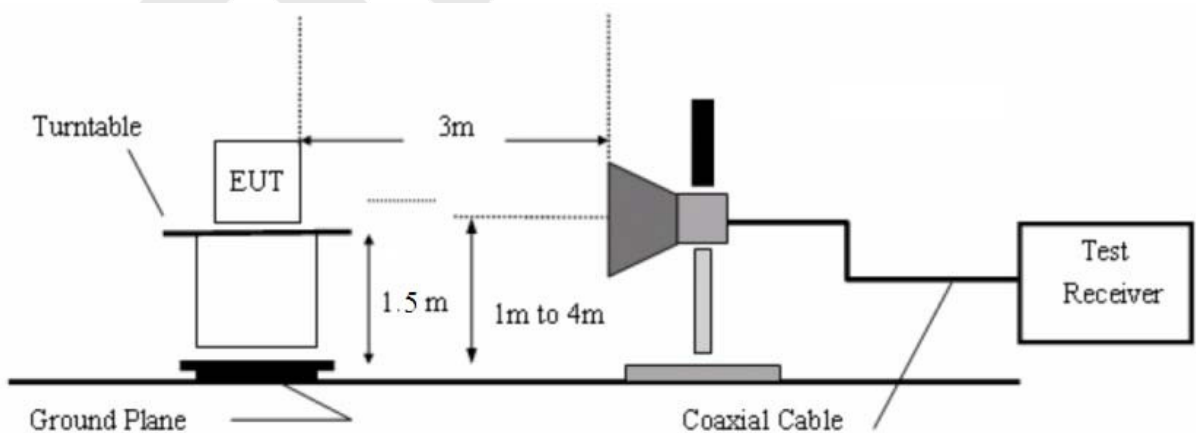

4.6.3. Test Procedure

For below 1GHz: The EUT is placed on a turntable, which is 0.8m above the ground plane.
For above 1GHz: The EUT is placed on a turntable, which is 1.5m above the ground plane.
The turn table can rotate 360 degrees to determine the position of the maximum emission level.
The EUT is set 3 meters away from the receiving antenna which is mounted on a antenna tower.
The antenna can be moved up and down from 1 to 4 meters to find out the maximum emission level. Both horizontal and vertical polarization of the antenna are set on test.

Measurements are made on 9KHz to 30MHz and 30MHz to 26GHz range with the transmitter set to the lowest, middle, and highest channels.

All readings from 30MHz to 1GHz are quasi-peak values with a resolution bandwidth of 120kHz. All reading are above 1GHz, peak & average values with a resolution bandwidth of 1MHz.

The EUT is tested in 9*6*6 Chamber. The device is evaluated in xyz orientation.

The test results are listed in Section 4.6.4.

4.6.4. Test Results

Please refer the following pages. Only the worst case (x orientation).

The test results of above 18000MHz are attenuated more than 20dB below the permissible limits, so the results don't record in the report.

Job No.:	011611208I	Polarization:	Horizontal
Standard:	(RE)FCC PART15 C_3m	Power Source:	AC 120V, 60Hz for adapter
Test item:	Radiation Test	Temp.(C)/Hum. (%RH):	24.6(C)/53% RH
Test Mode:	WiFi Mode	Distance:	3m

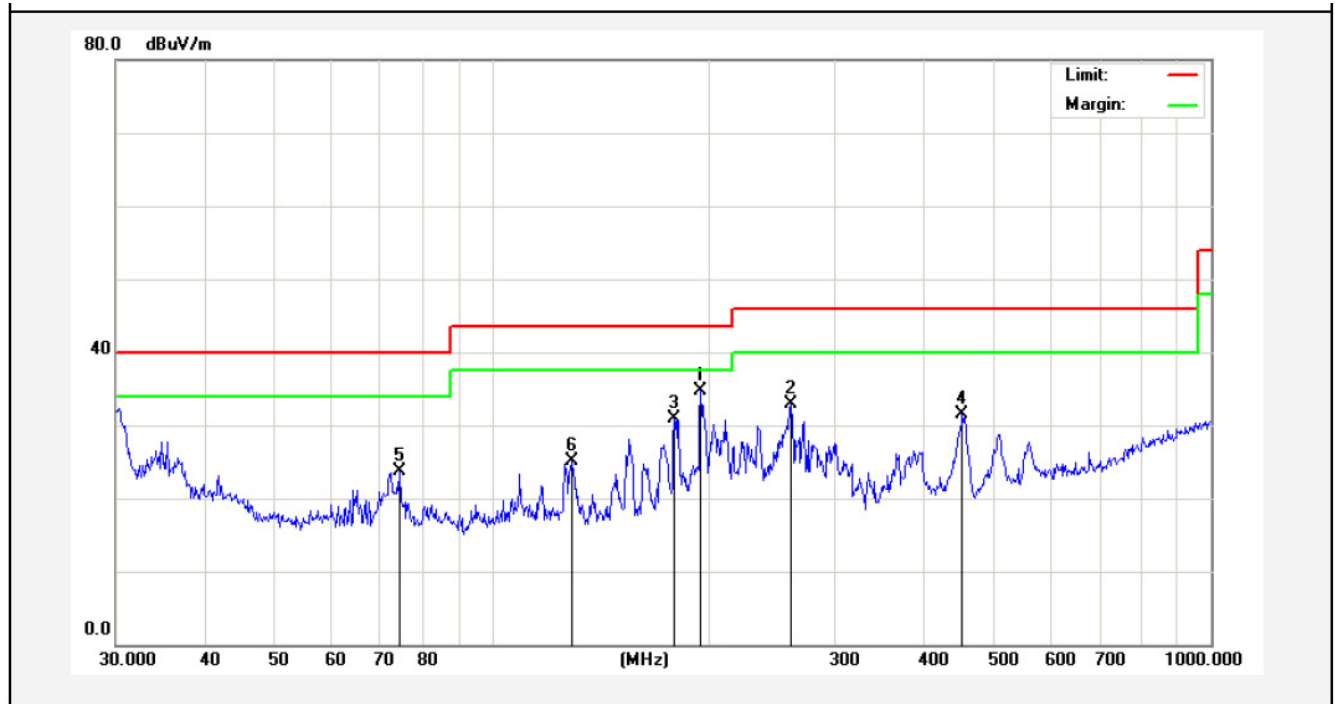

No.	Freq. (MHz)	Reading (dBuV/m)	Factor (dB/m)	Result (dBuV/m)	Limit (dBuV/)	Over Limit (dB)	Detector	Height (cm)	degree (deg)	Remark
1	195.1365	55.62	-20.89	34.73	43.50	-8.77	peak			
2	260.1444	51.80	-18.99	32.81	46.00	-13.19	peak			
3	179.3863	52.85	-21.89	30.96	43.50	-12.54	peak			
4	451.1350	43.70	-12.15	31.55	46.00	-14.45	peak			
5	74.3955	44.22	-20.48	23.74	40.00	-16.26	peak			
6	129.0146	47.70	-22.67	25.03	43.50	-18.47	peak			

Job No.:	011611208I	Polarization:	Vertical
Standard:	(RE)FCC PART15 C_3m	Power Source:	AC 120V, 60Hz for adapter
Test item:	Radiation Test	Temp.(C)/Hum.(%RH):	24.6(C)/53% RH
Test Mode:	WiFi Mode	Distance:	3m

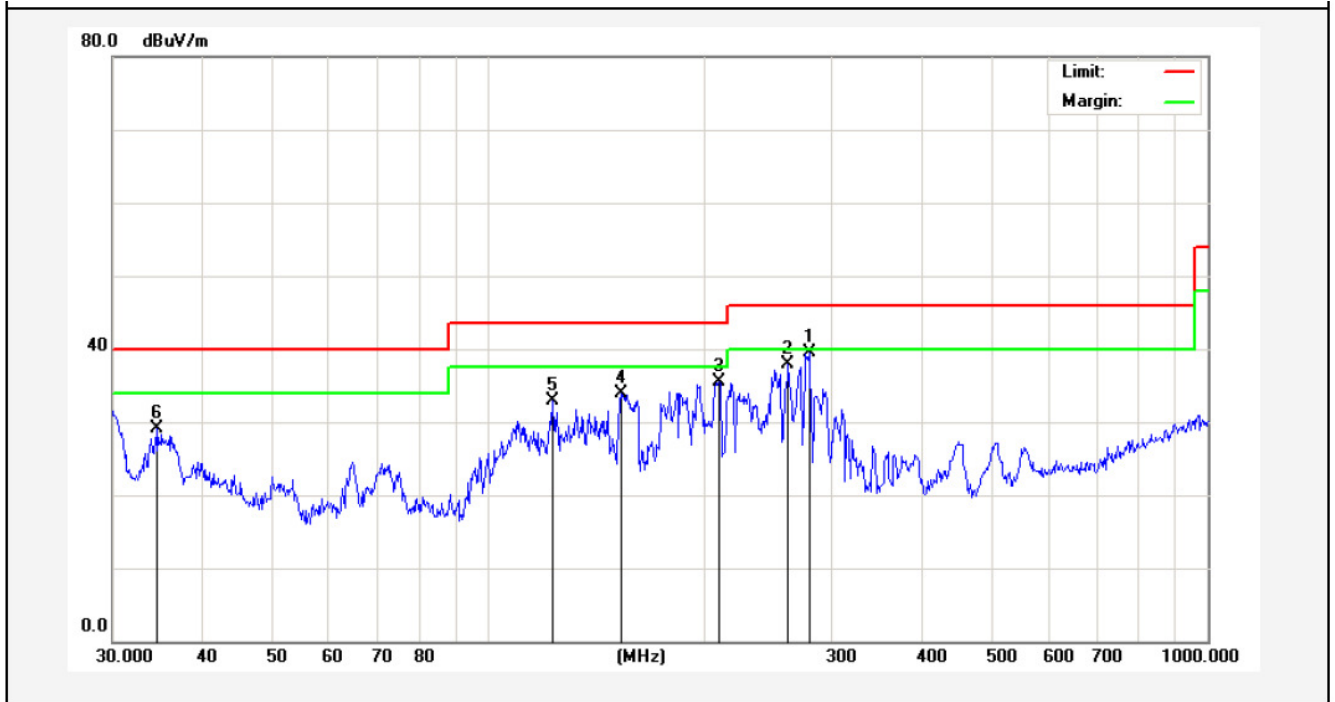

No.	Freq. (MHz)	Reading (dBuV/m)	Factor (dB/m)	Result (dBuV/m)	Limit (dBuV/)	Over Limit (dB)	Detector	Height (cm)	degree (deg)	Remark
1	279.0436	54.68	-15.16	39.52	46.00	-6.48	peak			
2	261.0583	51.87	-14.06	37.81	46.00	-8.19	peak			
3	209.3129	51.06	-15.52	35.54	43.50	-7.96	peak			
4	152.6641	52.09	-18.22	33.87	43.50	-9.63	peak			
5	122.8340	49.60	-16.76	32.84	43.50	-10.66	peak			
6	34.6385	43.64	-14.49	29.15	40.00	-10.85	peak			

Job No.:	011611208I	Polarization:	Horizontal
Standard:	(RE)FCC PART15 C _3m	Power Source:	AC 120V, 60Hz for adapter
Test item:	Radiation Test	Temp.(C)/Hum.(%RH):	24.6(C)/53% RH
Note:	802.11b(2412MHz)	Distance:	3m

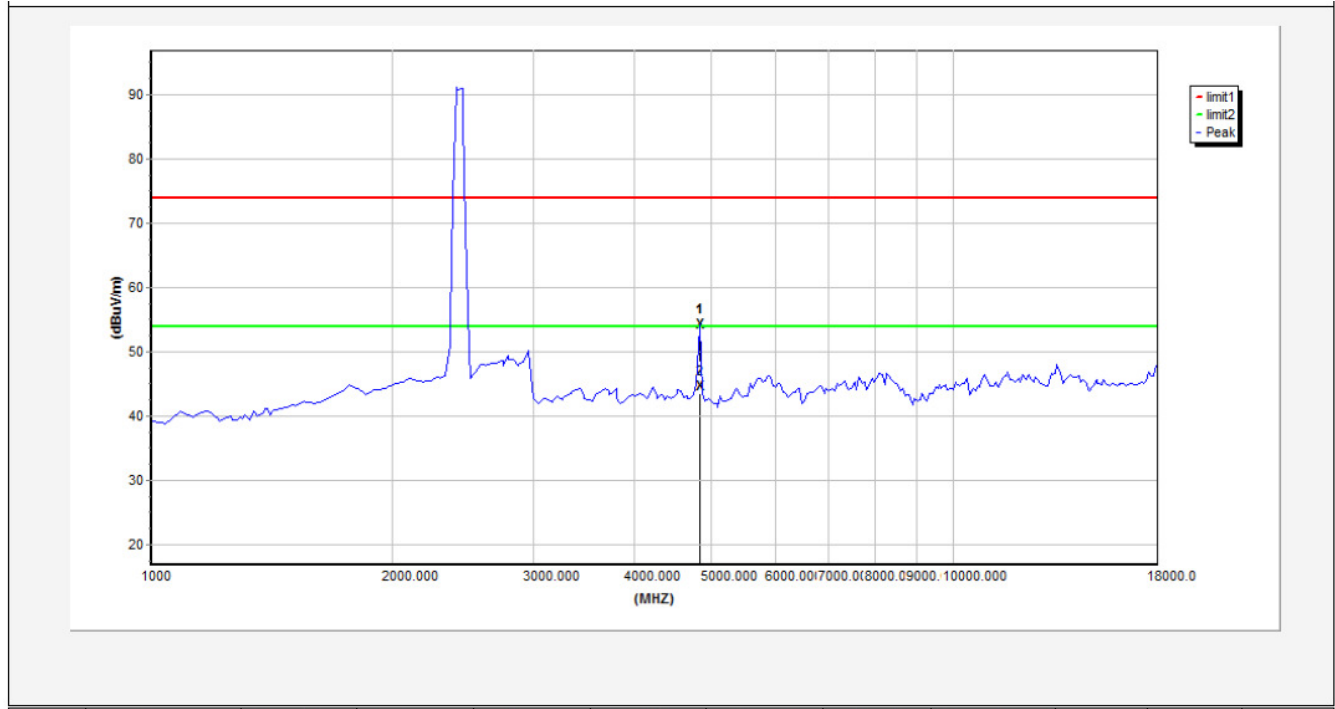

No.	Freq. (MHz)	Reading (dBuV/m)	Antenna (dB/m)	Amp. (dB/m)	Cable (dB/m)	Result (dBuV/m)	Limit (dBuV/m)	Over Limit (dB)	Detector	Height (cm)	degree (deg)
1	4831.9620	47.56	34.16	34.09	6.62	54.25	74.00	-19.75	peak	---	---
2	4831.9620	37.92	34.16	34.09	6.62	44.61	54.00	-9.39	AVG	---	---



Job No.:	011611208I	Polarization:	Vertical
Standard:	(RE)FCC PART15 C _3m	Power Source:	AC 120V, 60Hz for adapter
Test item:	Radiation Test	Temp.(C)/Hum.(%RH):	24.6(C)/53% RH
Note:	802.11b(2412MHz)	Distance:	3m

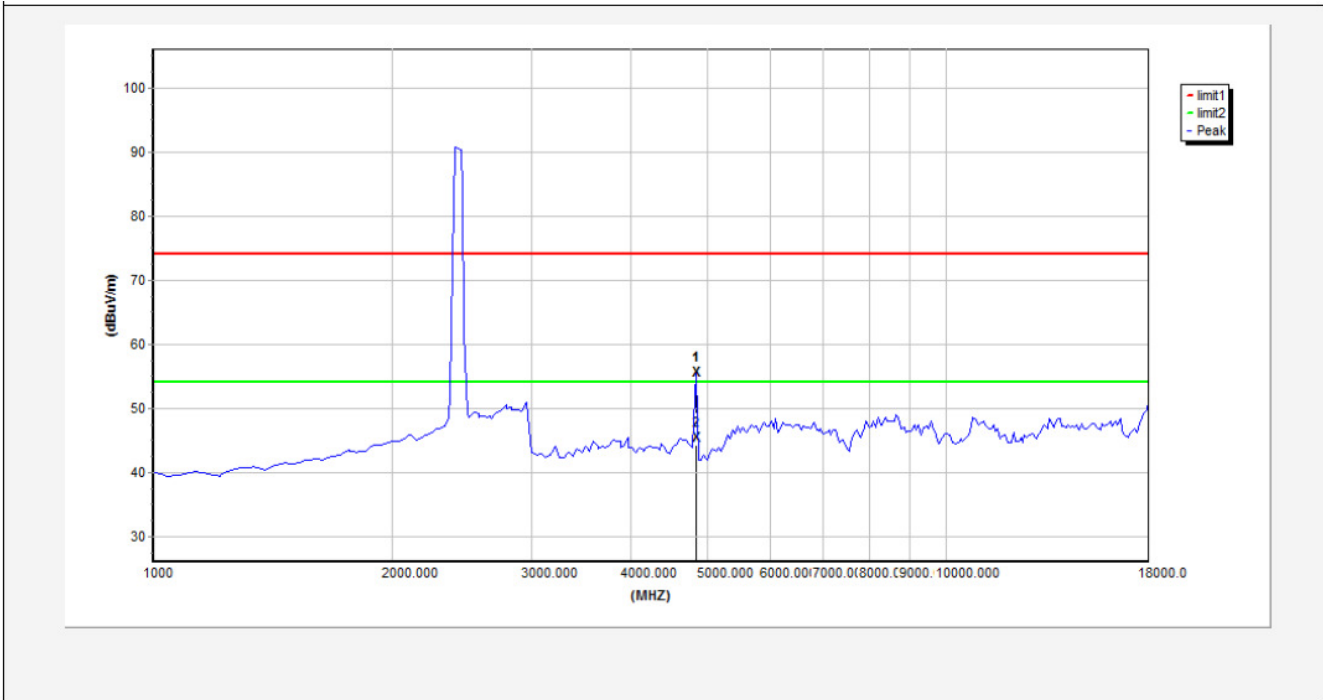

No.	Freq. (MHz)	Reading (dBuV/m)	Antenna (dB/m)	Amp. (dB/m)	Cable (dB/m)	Result (dBuV/m)	Limit (dBuV/m)	Over Limit (dB)	Detector	Height (cm)	degree (deg)
1	4831.9620	48.78	34.16	34.09	6.62	55.47	74.00	-18.53	peak	---	---
2	4831.9620	38.62	34.16	34.09	6.62	45.31	54.00	-8.69	AVG	---	---

AM

Job No.:	011611208I	Polarization:	Horizontal
Standard:	(RE)FCC PART15 C _3m	Power Source:	AC 120V, 60Hz for adapter
Test item:	Radiation Test	Temp.(C)/Hum.(%RH):	24.6(C)/53% RH
Note:	802.11b(2437MHz)	Distance:	3m

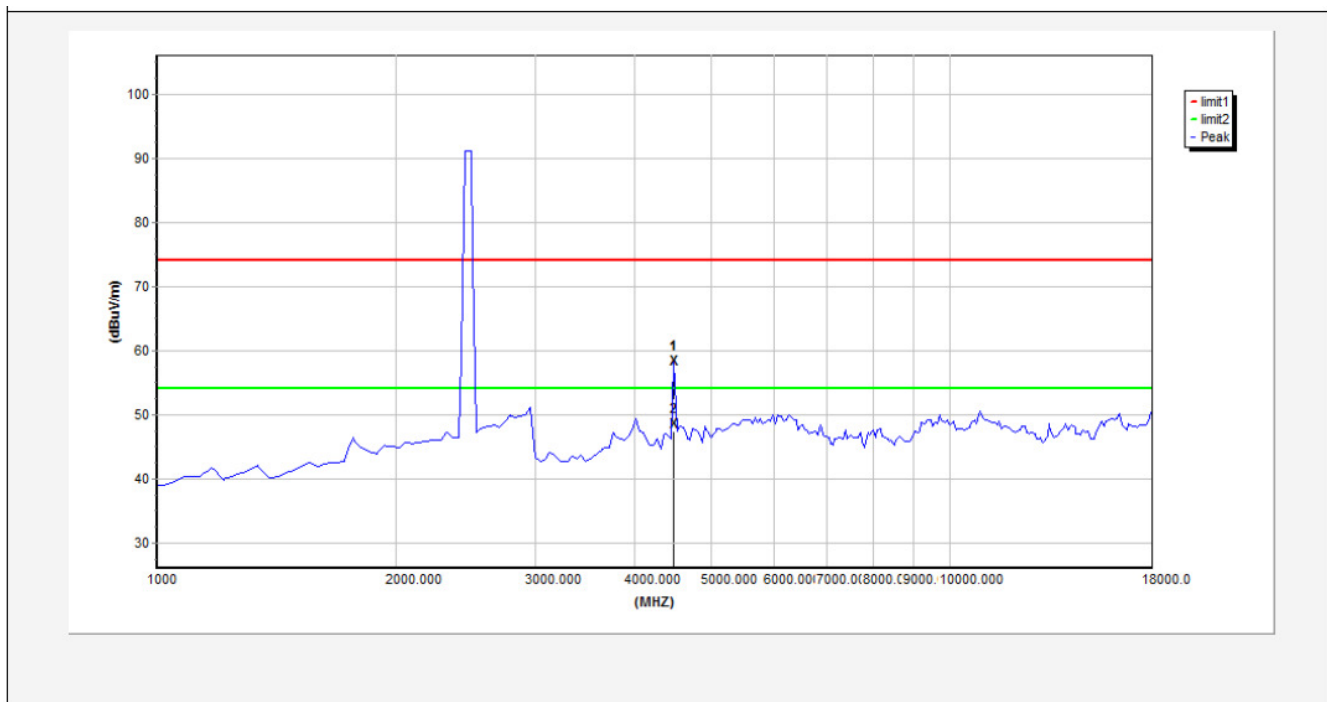

No.	Freq. (MHz)	Reading (dBuV/m)	Antenna (dB/m)	Amp. (dB/m)	Cable (dB/m)	Result (dBuV/m)	Limit (dBuV/m)	Over Limit (dB)	Detector	Height (cm)	degree (deg)
1	4485.0000	53.32	32.72	34.08	6.16	58.12	74.00	-15.88	peak	---	---
2	4485.0000	43.49	32.72	34.08	6.16	48.29	54.00	-5.71	AVG	---	---



Job No.:	0116112081	Polarization:	Vertical
Standard:	(RE)FCC PART15 C_3m	Power Source:	AC 120V, 60Hz for adapter
Test item:	Radiation Test	Temp.(C)/Hum.(%RH):	24.6(C)/53% RH
Note:	802.11b(2437MHz)	Distance:	3m

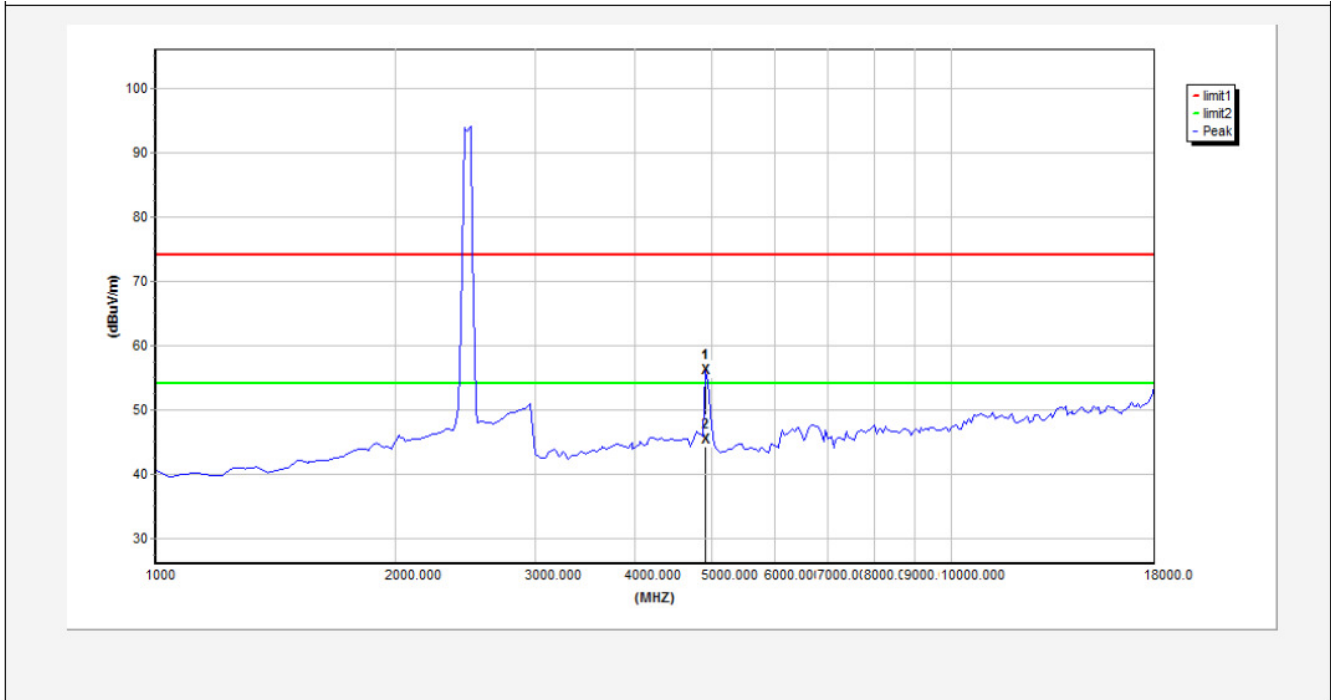

No.	Freq. (MHz)	Reading (dBuV/m)	Antenna (dB/m)	Amp. (dB/m)	Cable (dB/m)	Result (dBuV/m)	Limit (dBuV/m)	Over Limit (dB)	Detector	Height (cm)	degree (deg)
1	4910.0000	48.86	34.5	34.09	6.72	55.99	74.00	-18.01	peak	---	---
2	4910.0000	38.10	34.5	34.09	6.72	45.23	54.00	-8.77	AVG	---	---



Job No.:	011611208I	Polarization:	Horizontal
Standard:	(RE)FCC PART15 C_3m	Power Source:	AC 120V, 60Hz for adapter
Test item:	Radiation Test	Temp.(C)/Hum.(% RH):	24.6(C)/53 % RH
Note:	802.11b(2462MHz)	Distance:	3m

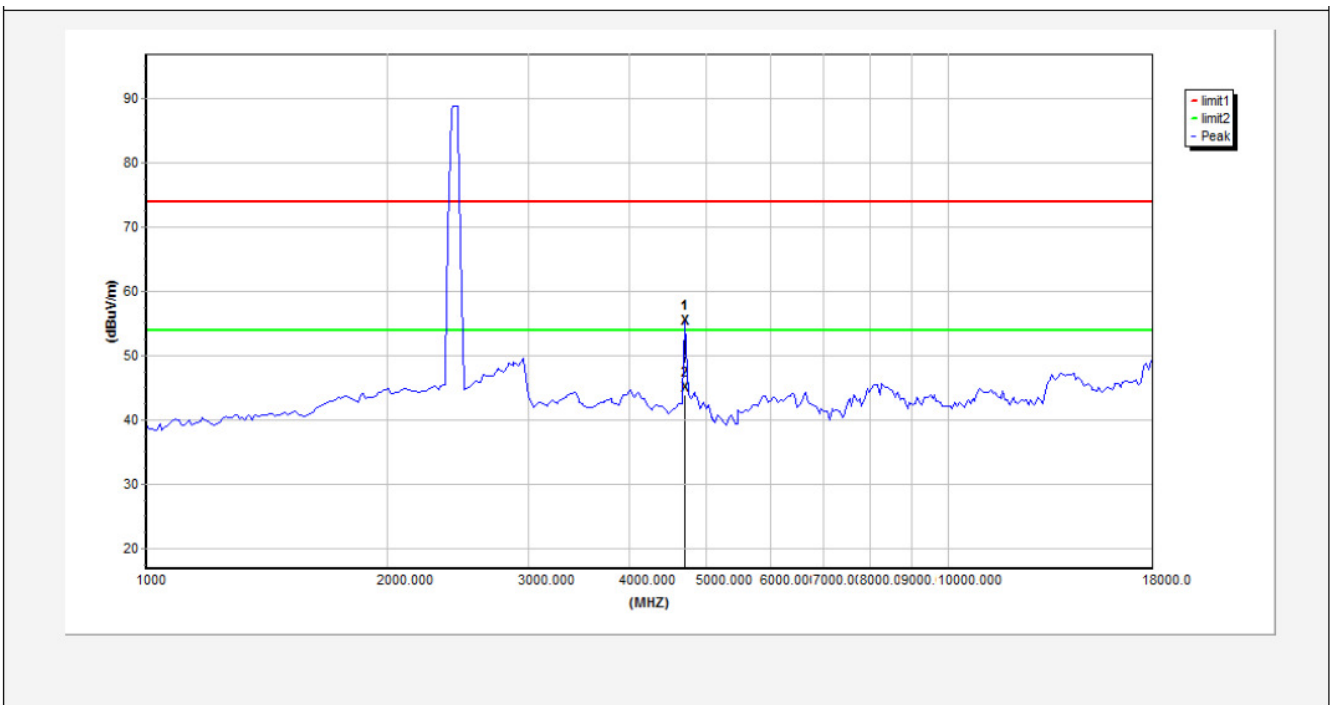

No.	Freq. (MHz)	Reading (dBuV/m)	Antenna (dB/m)	Amp. (dB/m)	Cable (dB/m)	Result (dBuV/m)	Limit (dBuV/m)	Over Limit (dB)	Detector	Height (cm)	degree (deg)
1	4697.5000	49.33	33.57	34.09	6.44	55.25	74.00	-18.75	peak	---	---
2	4697.5000	39.11	33.57	34.09	6.44	45.03	54.00	-8.97	AVG	---	---



Job No.:	011611208I	Polarization:	Vertical
Standard:	(RE)FCC PART15 C_3m	Power Source:	AC 120V, 60Hz for adapter
Test item:	Radiation Test	Temp.(C)/Hum.(% RH):	24.6(C)/53% RH
Note:	802.11b(2462MHz)	Distance:	3m

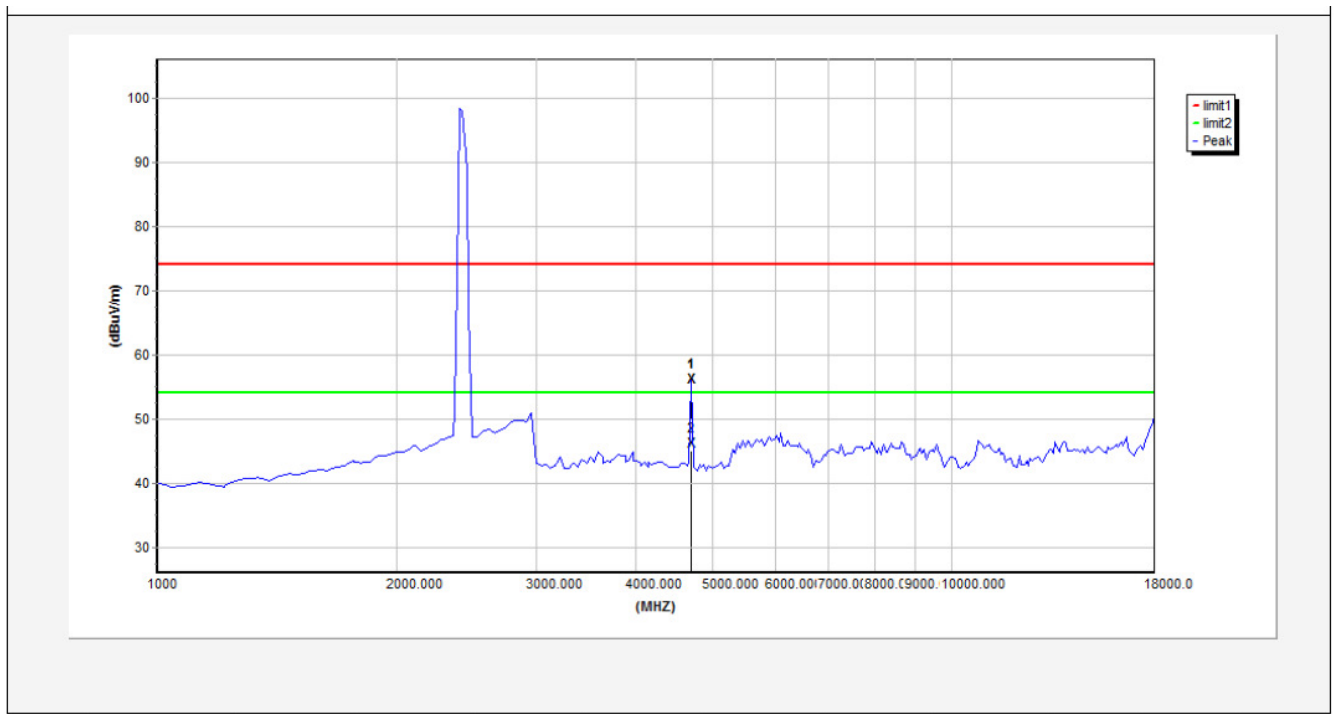

No.	Freq. (MHz)	Reading (dBuV/m)	Antenna (dB/m)	Amp. (dB/m)	Cable (dB/m)	Result (dBuV/m)	Limit (dBuV/m)	Over Limit (dB)	Detector	Height (cm)	degree (deg)
1	4697.5000	50.12	33.57	34.09	6.44	56.04	74.00	-17.96	peak	---	---
2	4697.5000	40.11	33.57	34.09	6.44	46.03	54.00	-7.97	AVG	---	---



5. ANTENNA APPLICATION

5.1. Antenna requirement

The EUT'S antenna is met the requirement of FCC part 15C section 15.203.

An intentional radiator shall be designed to ensure that no antenna other than that furnished by the responsible party shall be used with the device. The use of a permanently attached antenna or of an antenna that uses a unique coupling to the intentional radiator shall be considered sufficient to comply with the provisions of this section. The manufacturer may design the unit so that a broken antenna can be replaced by the user, but the use of a standard antenna jack or electrical connector is prohibited. This requirement does not apply to carrier current devices or to devices operated under the provisions of §15.211, §15.213, §15.217, §15.219, or §15.221. Further, this requirement does not apply to intentional radiators that must be professionally installed, such as perimeter protection systems and some field disturbance sensors, or to other intentional radiators which, in accordance with §15.31(d), must be measured at the installation site. However, the installer shall be responsible for ensuring that the proper antenna is employed so that the limits in this part are not exceeded.

5.2. Result

The EUT's antenna used a chip antenna which is permanently attached, The antenna's gain is 2dBi and meets the requirement.

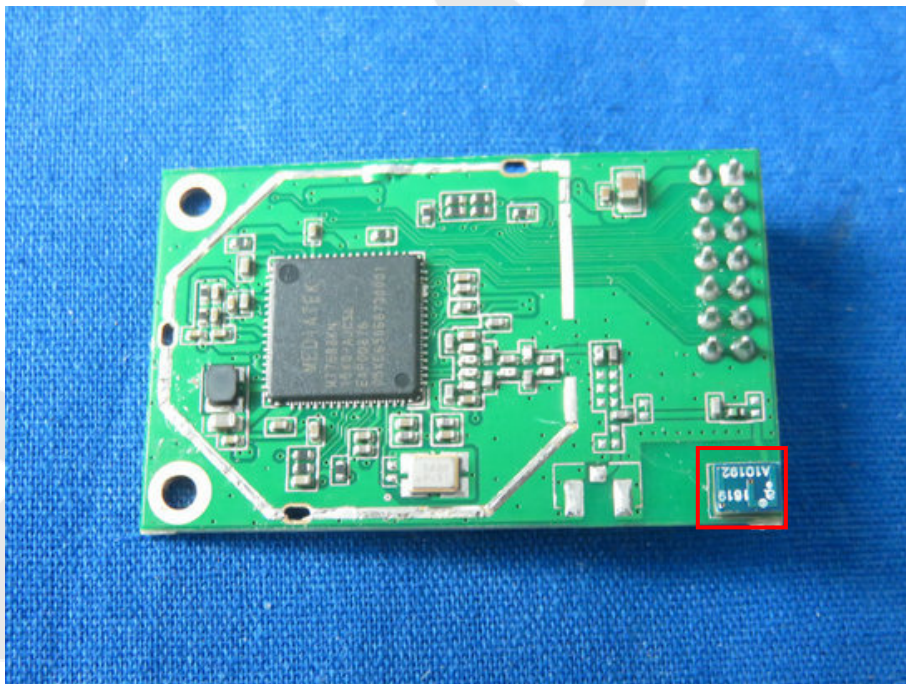

6. PHOTOGRAPH

6.1. Photo of Conducted Emission Measurement



6.2. Photo of Radiation Emission Test

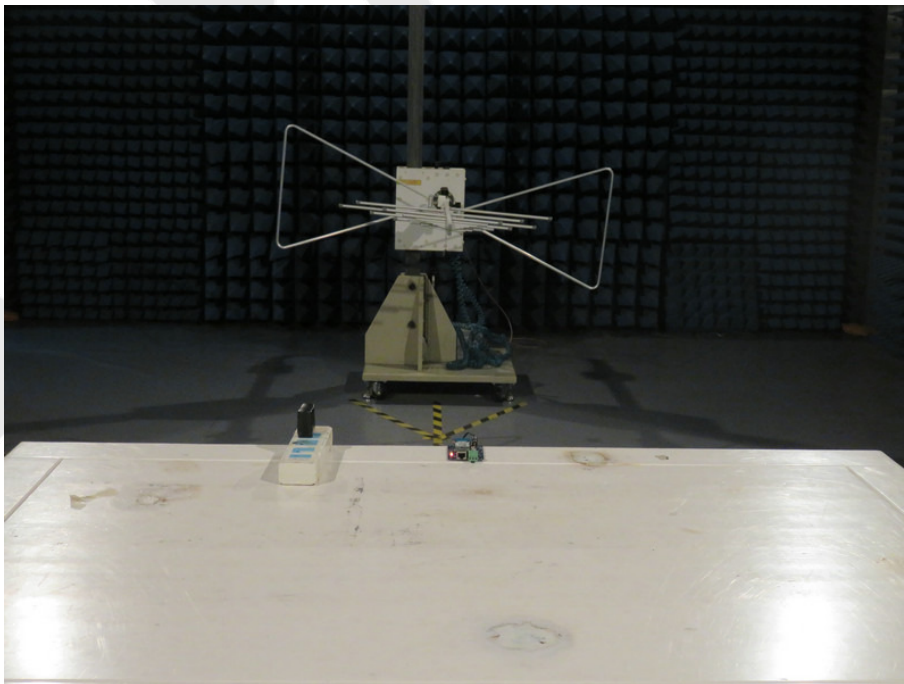

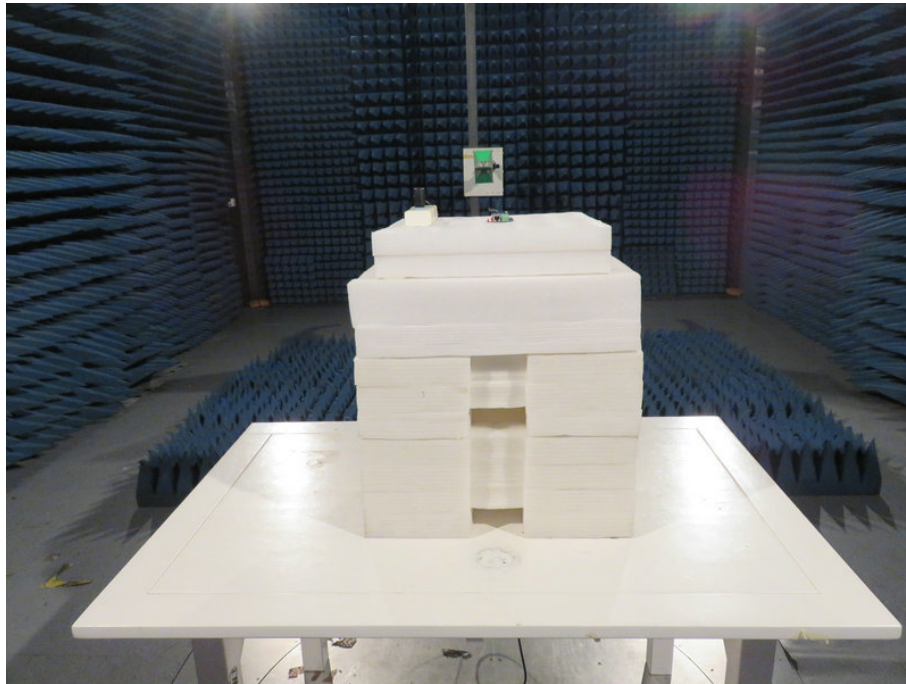

APPENDIX I (EXTERNAL PHOTOS)

1. Figure

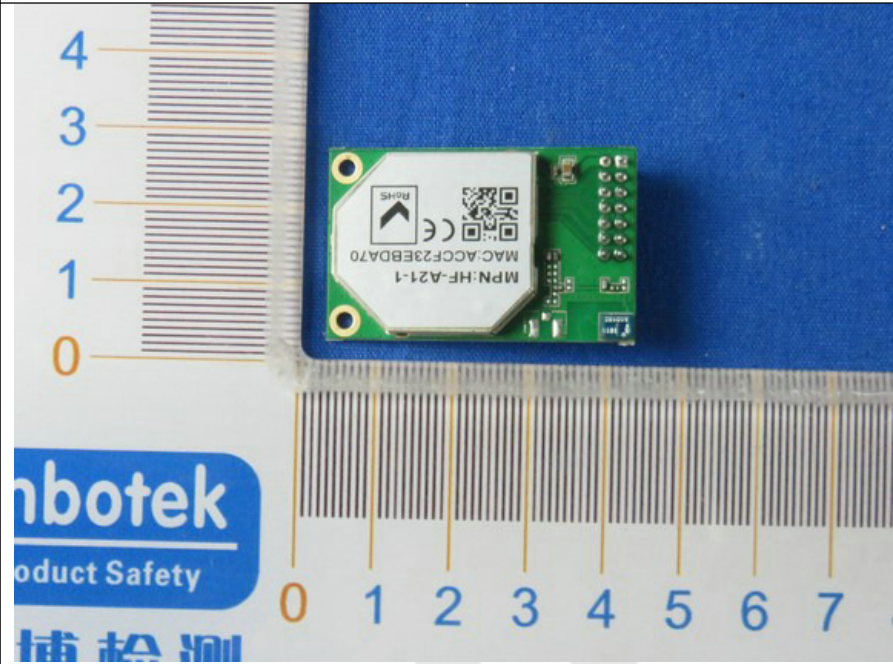

2. Figure

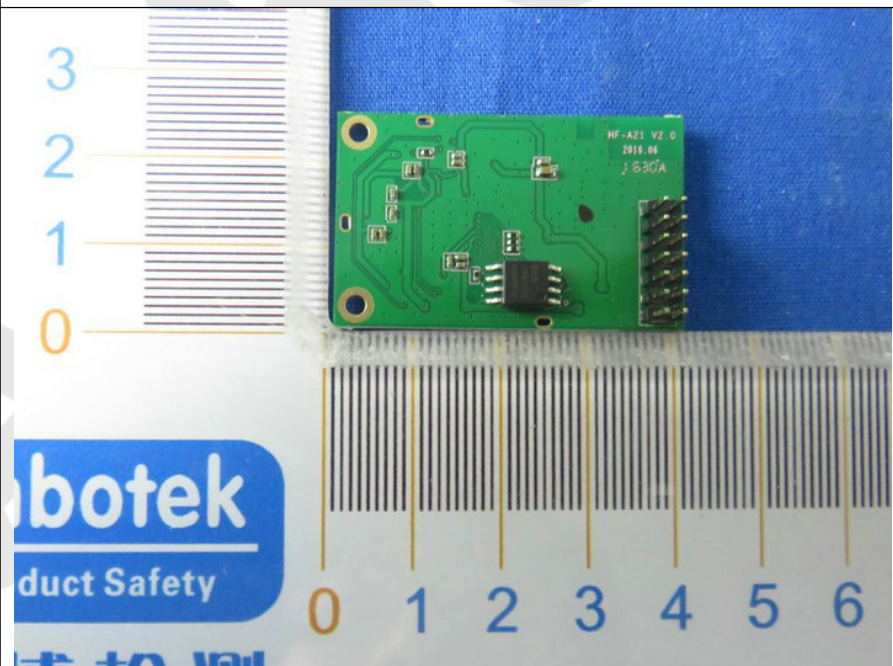

APPENDIX II (INTERNAL PHOTOS)

1. Figure

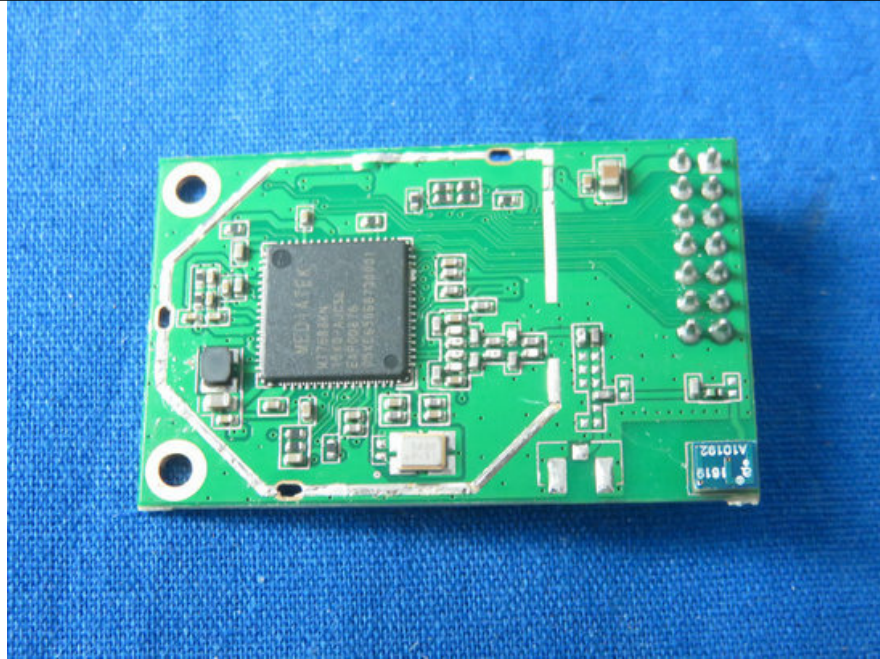

2. Figure

