

® RadioShack®

**6001436
USER'S GUIDE**

AGE 14+



ACCELERATOR

HD VIDEO STREAMING DRONE



Contents

Features.....	3
Package Contents	3
About Accelerator App.....	3
Compatibility.....	3
Specifications	4
Fly Safely.....	4
Charge the Drone Battery.....	4
Lithium Battery Notes	5
Recycle Rechargeable Batteries.....	5
Install Batteries in the Remote Control.....	5
Battery Notes.....	5
Drone Design Overview	6-7
Remote Control Design Overview	8-9
Pairing	10
Multiple Player Mode Pairing.....	10
Fly Your Drone.....	10
Land Your Drone.....	10
Trim Your Drone.....	11
Fly in "Headless" Mode.....	11
Perform Stunts	11
Using the Camera	12
Taking Photos and Videos	12
Download Accelerator App.....	12
App Controls Overview	13
Playback Photos/ Video.....	14
Replace Damaged Propellers.....	14
Troubleshooting.....	15
Need Spare Parts?.....	16
FCC Information	16
Limited Warranty.....	16

We hope you enjoy your Accelerator HD Video Streaming Drone from RadioShack. Congratulations! No FAA Registration is required for this drone. Please read this user's guide before setting up and using your drone.

Features

- 2 ways to fly, control and shoot video/ pictures using remote control or Wi-Fi app
- Air pressure sensor for enhanced hovering
- Built-in HD camera
- One touch takeoff/ landing
- Digital proportional control
- 6-axis gyro stabilization

Package Contents

- Accelerator
- AC Adapter
- Spare Propeller with screw (6)
- User's Guide
- Remote Control
- Mobile Device Holder
- 3.7V Drone Battery

About Accelerator App

Functions and controls are basically the same as those on the included remote control, but the app has a few extra tricks to enjoy:

- You can leave the remote control at home, because you want to travel light and cannot bear to separate from your smart device...
- You prefer touch screen controls, plus there's a cool motion sensor navigation option
- You can stream photo/ video footage live to your friends on social media
- Last but not least, for remote control users, the app allows quick access to view photos/ video shot using the included remote control and a SD card (not included) loaded in your drone. Snap the device holder onto the remote to use your device as a monitor (see page 9). This conveniently eliminates transferring the SD card to your device or a card reader.

Accelerator pilots, you have nothing to lose, the world is your oyster! Master flight first by getting to grips with the remote control, and then discover the extras offered in app control. Download the free **Accelerator app** from App StoreSM or Google PlayTM.



Compatibility

- **iOS8** or above
- **Android 4.0** or above. Note, app functions and compatibility may vary depending on device brand and models

Specifications

Power	
Drone	3.7V, 2000mAh lithium polymer battery
Remote Control	4 × AAA batteries
Control Distance	max. 190 ft. (58m)
App Distance	max. 130 ft (40m)
Camera	
Lens Resolution (video)	640 × 480
Photo Resolution	1280 × 720 JPEG
Maximum SD card support	32G

Specifications are subject to change and improvement without notice. Actual product may vary from the images found in this document.

Fly Safely

- This drone is designed for outdoor play. However, the drone is neither waterproof nor weatherproof. Do not play in rain, snow, or windy conditions.
- Do not fly the drone near or at other people or animals.
- Do not fly your drone where emergency responders are working, or emergency aircraft are operating.
- Keep the drone away from power lines, trees, weeds, and water.
- Do not fly your drone over private property where you are not welcomed.
- Keep eyes, hands, hair, and loose clothing away from moving propellers.
- Fly safely. If the drone crashes, the SD card may fall out.
- Adult supervision is recommended at all times.

Charge the Drone Battery

Make sure you use the supplied battery and AC adapter, or one of the same type: 3.7 V, 2000mAh lithium polymer.

1. Use only the supplied AC adapter to connect as shown below. The LED on the adapter lights red during charging, and turns green when charging is complete.
A full charge takes about **120** minutes. A fully charged battery provides up to **6** minutes of flight and camera time.
2. After charging, unplug the adapter and separate the battery connectors. Do not attempt to overcharge the battery.

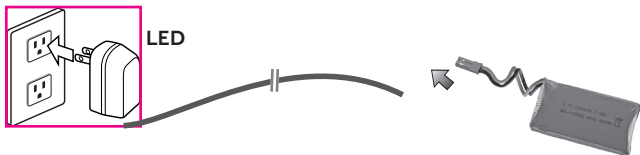

- To install the battery, plug the two ends of the white battery connectors. They only fit one way, so do not use force. Neatly slot the battery and cables into the drone's battery compartment.



CAUTION:

- After playing, let the built-in battery cool before charging again.
- Always unplug the drone's battery when not in use.

Lithium Battery Notes

- Do not charge longer than recommended. Unplug the charging cable when the battery is charged.**
- Do not attempt to charge or operate damaged toys.
- Do not puncture or crush. Do not disassemble.
- Do not dispose of lithium batteries in the trash.
- If the electrolyte in the cells should get on your skin, thoroughly wash with soap and water. If in the eyes, rinse thoroughly with cool water. Immediately seek medical attention.

Install Batteries in the Remote Control

- Make sure the remote control is turned off.
- Use a screwdriver to open the battery compartment. Then insert four AAA batteries (not included), matching the polarities (+ and -) marked inside. Use alkaline batteries for optimal performance. Replace the cover.

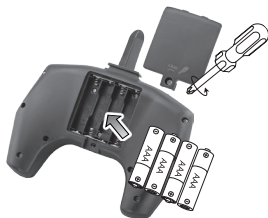

Note: If the remote control's LED flashes during use, the batteries are low and should be replaced.

Battery Notes

- Dispose of old batteries promptly and properly. Do not burn or bury them. Use only fresh batteries of the required size and recommended type.
- Do not mix old and new batteries, different types of batteries (standard, alkaline, or rechargeable), or rechargeable batteries of different capacities.
- Remove batteries during longer storage periods. Batteries can leak chemicals that can damage electronic parts.

Drone Design Overview

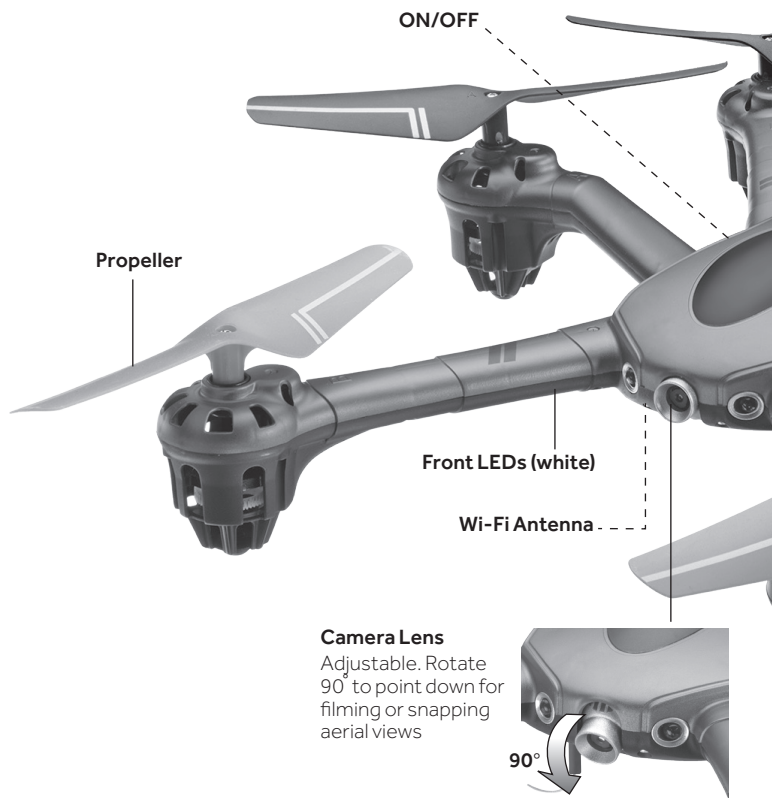

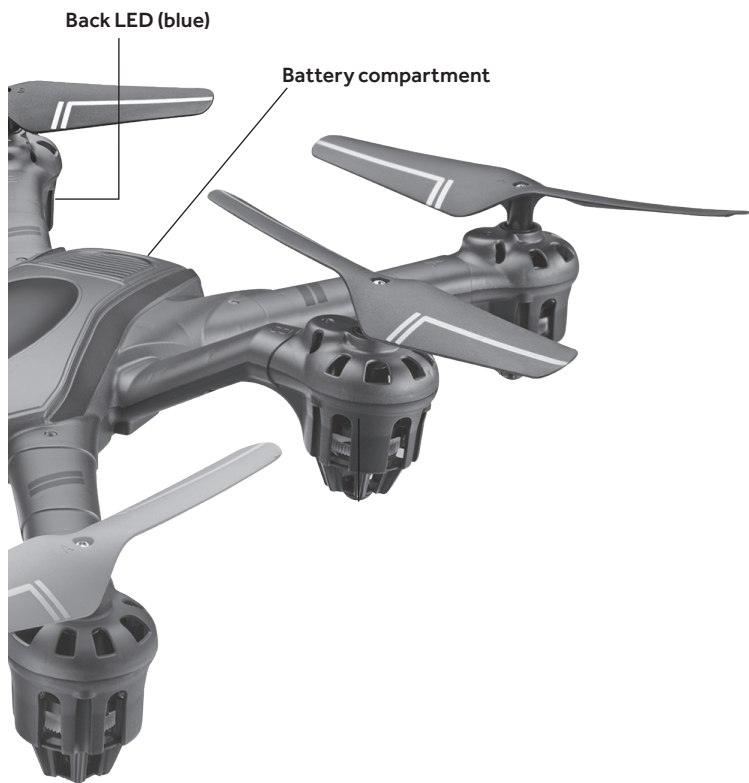

Remote Control Overview

Antenna/ Support for Device Holder



Power on/off

Throttle

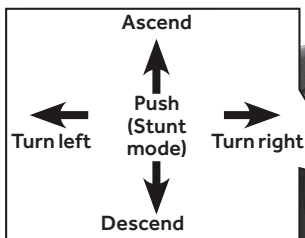

One-touch takeoff



Start/ stop recording video in beeline cruise mode



Start/ stop recording video in auto 360° rotation mode



Headless navigation mode on/off

Using the Detachable Device Holder

1. Slot holder onto antenna's groove until it clicks.
2. Pull up holder bracket to extend and insert your smart device (max. screen width 7 inches).
3. Rotate lock to adjust and lock holder at desired viewing angle.
4. Push holder up and off the groove with both hands to release.

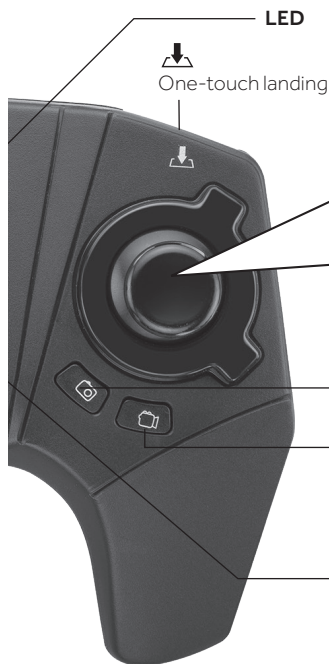

Steering

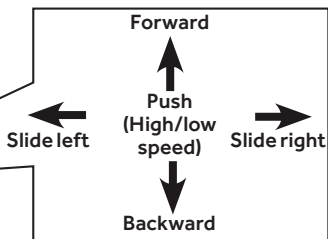

Take a photo



Start/ stop video recording

Trim Control

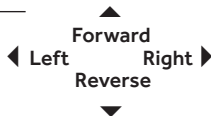

Pairing

1. Turn on the drone. The LEDs on the drone flash.
2. Place the drone on level ground.
3. Turn on the remote control. The remote control's LED lights up.
4. Move the throttle all the way up and then down to pair the remote control with the drone. The drone's propellers remain still during pairing. When paired, all LEDs on both the remote control and drone light steadily.

Note: If pairing fails, turn off the drone and remote control and repeat the steps above, or change locations to avoid electrical interference.

Multiple Player Mode Pairing

You can play together with friends to fly up to 6 Accelerators side by side. Before pairing, make sure all players have switched off their Accelerators and remotes. Players must pair their unit separately to avoid interference. Once paired, keep your unit switched on, until the other players have also completed pairing.

Fly Your Drone

1. There are 2 ways to take off. Place your drone on the ground and then either:
 - Press the  button. The drone will automatically take off, ascending about 5 ft (150cm) and then hover.
 - Move the throttle forward to ascend. To avoid ground air turbulence, fly the drone at least 1 ft. (30cm) off the ground.
2. For speed options, push the steering control in to switch between high speed (double beep) and low speed (single beep).

IMPORTANT: If your drone crashes upside down, pull the throttle all the way down. Wait till the propellers have stopped still before you handle the drone.

Land Your Drone

Automatically: Press  and the drone will steadily descend and land.

Manually: Slowly move the throttle backward to descend. Avoid moving the throttle too quickly, as it can stop the propellers instantly and cause the drone to crash.

- When you finish flying the drone, turn off the remote control and drone.

Trim Your Drone

Push the throttle forward and observe how the drone reacts.

Forward/Reverse Movement Trim: If the drone tends to move forward, press ▼; if it tends to move backward, press ▲.

Left/Right Slide Trim: If the drone tends to slide right, press ◀; if it tends to slide left, press ▶.

Note: The remote control beeps when you press a trim control but stops beeping when you reach maximum trim adjustment.

Fly in "Headless" Mode

Featuring an integrated true-north compass, the drone can automatically align to fly "headless". This simplifies steering:

1. During flight, press  on the remote. The drone's front LEDs flash when headless mode is activated.
2. The drone will now fly forward, regardless which way the drone's head faces.

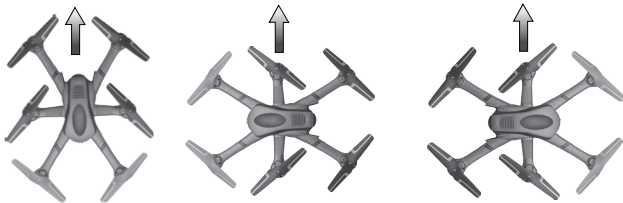

3. Press  again to exit headless mode.

Perform Stunts

1. Push the throttle control to activate stunt mode. The remote control beeps repeatedly.
2. Move the steering lever right or left to perform a 360° barrel roll.
3. The drone automatically exits stunt mode after performing a stunt, or push in the throttle control again to exit immediately.

IMPORTANT: Make sure there is enough space, at least 6 feet in the air and minimum clearance of 6 feet in all directions for the drone to perform stunts without crashing into objects or people.

Using the Camera





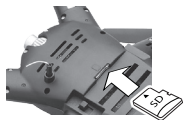

For good pictures, use the camera in daylight or well-lit environments.

1. For players using the remote control, align and insert a Micro SD card (not included) into the card slot in the direction as marked. Push the SD card in until it clicks.
2. To remove the SD card, press it to eject.



Taking Photos and Videos

When the drone flies stably, on the remote control:

- Press  once to take a photo. The remote control beeps and the drone's back LEDs flash once.
- Press  to record a video. Press  again to stop recording and save your file recording.
- To fly and shoot video in a beeline, press .
- To shoot video in 360° panoramic view, press  and the drone will automatically steadily rotate whilst hovering. Press  again to stop shooting and return to normal flight mode.

Note:

- Video recordings are without audio, in order to omit the roaring drone motor.
- The remote control beeps and the drone's back LEDs flash repeatedly during recording.
- The video recorded may fail to play in some video applications if (1) the SD card falls out due to a crash; (2) you remove the SD card before stopping recording; (3) battery power was too low during recording.

Download Accelerator App

1. For Android and iOS users, go to Google Play™ or App StoreSM respectively to download **Accelerator app**
2. Follow screen instructions to install the app.
3. After installation, turn on the drone. The drone's LEDs start flashing indicating pairing mode.
4. On your smart device, open the Wi-Fi setting to start searching for the list of available Wi-Fi networks. Select the network named **RS-xxxxxx** (where **x** represents an unique code.) 
5. On your smart device, tap on **Accelerator** app icon to open the app. When the main menu screen appears, select "**TAP TO BEGIN**" to enter the app control screen.
6. Upon successful connection with your drone, the drone LEDs stop flashing and light up steadily.
7. Familiarize yourself with the onscreen app controls. Have fun flying!

App Controls Overview

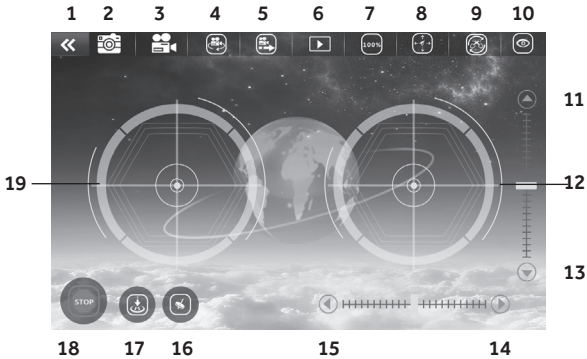

KEY

- 1 Go to previous page
- 2 Take a **photo**
- 3 Start/ stop **video recording**
- 4 Start/ stop recording **video in auto 360° rotation mode**
- 5 Start/ stop recording **video in beeline cruise mode**
- 6 Enter **folder view** for **playback** of photos/ video. See page 14, "**Playback Photos/ Video.**"
- 7 **Speed setting:** 30/60/100%. Default 30%.
- 8 Activate/ deactivate **headless mode**
- 9 Activate/ deactivate **stunt mode**
- 10 **Show/ hide** throttle, steering and trim controls. Button icon toggles when touched
- 11 **Trim control:** adjust forward
- 12 **Steering control:** forward/backward/slide left/ slide right
- 13 **Trim control:** adjust backward
- 14 **Trim control:** adjust right
- 15 **Trim control:** adjust left
- 16 Activate/ deactivate **motion sensor control**
- 17 **One button take off/landing:** button icon toggles when touched
- 18 **STOP:** activate emergency landing
- 19 **Throttle control:** ascend/ descend/turn left/ turn right

Playback Photos/ Video

Accelerator photo and video shoots are stored in the app's 3 playback folders: **PICTURES**, **VIDEO** and **VIDEO Card**.

- To playback, tap on the relevant folder to access content.



Note:

- For easy folder management, operate the camera either with the app controls on your smart device, or with the remote control buttons.
- **Remote control pilots:** need to insert a SD card in the drone. Your media is stored in the folder **VIDEO Card**.
- **App pilots:** there is no need to insert a SD card into the drone, unless you like to use a SD card as backup, storing media in all 3 folders.
- **For remote control pilots with smart device in holder:** use your device for instant playback. As well as shooting video and photos with your remote control, you can also use the app's camera control buttons. In mixed control mode shoots, app screen control shoots prioritize over remote control shoots for storage.

Replace Damaged Propellers

The left and right propellers of the drone are different (see **A/B** orientation marking on propellers and on the rotor axles). You must use the correct propeller in the correct location, otherwise the drone will fail to take off.

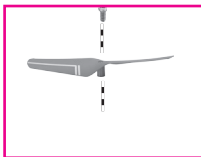
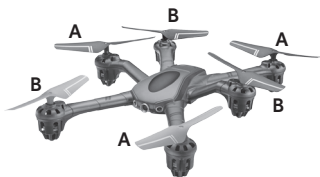

To replace a damaged propeller, use a screwdriver to remove the old propeller. Insert a new matching propeller onto the propeller axle, then screw securely, but do not overtighten otherwise the propeller won't turn.

WARNING:

- To avoid injury and damage, inspect the propellers for nicks and breaks and make sure they are securely attached before and after each flight. Replace nicked, chipped, cracked or broken propellers.
- Use only the supplied propellers. Do not alter, modify, or customize.

Troubleshooting

Drone does not respond

- Make sure the drone and remote control are switched on and paired.
- The drone battery may be low. Fully charge the battery. See **"Charge the Drone Battery."**
- Remote control battery may be low. Replace the batteries. For app pilots, recharge your smart device if the battery status is low.
- Make sure the drone is within the control range and in line of sight.

Drone difficult to control

- The propellers may be deformed due to a crash. Adjust deformed propellers by hand. If you cannot adjust the propellers, replace with the spare propellers.
- The throttle control is very sensitive. Use small, fine movements to control.
- If you are a beginner, set to low speed, use the takeoff and landing buttons  and select headless mode.

Drone swerves or moves erratically before taking off

- After a crash, the gyroscope inside your drone may need calibrating. On the remote control, do the following:
 1. Switch on your drone and remote control, and pair them.
 2. Move the throttle all the way down and the steering forward at the same time. Hold this position until the drone LEDs start to blink rapidly. Then release the controls.
 3. The drone LEDs light steadily. Calibration is successfully completed, and you are now ready for takeoff.
- See **"Trim Your Drone"** to further fine tune and improve control of your drone after calibration, if necessary.
- For app pilots, calibration is similar to the above. Move and hold the app's onscreen throttle and steering controls for 3 seconds, and then observe the drone LED status described in steps 2-3.



Need Spare Parts?

Need more spare propellers, or lost some of the accessories? Consult your dealer for details on the 6001462 Crash Pack for 6001436 Accelerator.

FCC Information

This equipment has been tested and found to comply with the limits for a Class B digital device, pursuant to Part 15 of the FCC Rules. These limits are designed to provide reasonable protection against harmful interference in a residential installation. This equipment generates, uses and can radiate radio frequency energy and, if not installed and used in accordance with the instructions, may cause harmful interference to radio communications. However, there is no guarantee that interference will not occur in a particular installation. If this equipment does cause harmful interference to radio or television reception, which can be determined by turning the equipment off and on, the user is encouraged to try to correct the interference by one or more of the following measures:

- Reorient or relocate the receiving antenna.
- Increase the separation between the equipment and receiver.
- Connect the equipment into an outlet on a circuit different from that to which the receiver is connected.
- Consult your dealer or an experienced radio/TV technician for help.

If you cannot eliminate the interference, the FCC requires that you stop using your equipment. Changes or modifications not expressly approved by the party responsible for compliance could void the user's authority to operate the equipment.

This device complies with Part 15 of the FCC Rules. Operation is subject to the following two conditions: (1) this device may not cause harmful interference, and (2) this device must accept any interference received, including interference that may cause undesired operation.

Limited Warranty

Go to www.radioshack.com/help for details.

RadioShack Customer Relations

300 RadioShack Circle, Fort Worth, TX 76102

CHOKING HAZARD! Small parts. Not for children under 3 years.

iPod, iPhone, iPad, iPad mini, iPad Air and iPod touch are trademarks of Apple Inc.

App Store is a service mark of Apple Inc.

Google Play and Android are trademarks of Google Inc.

RoHS

Complies with the European Union's "Restriction of Hazardous Substances Directive," which protects the environment by restricting specific hazardous materials and products.



© 2016 General Wireless Operations Inc.

All rights reserved. RadioShack is a registered trademark used by General Wireless Operations Inc. dba RadioShack. radioshack.com

Printed
in China

08A16
6001436