



MEASUREMENT REPORT

FCC PART 15.407 / RSS-247 WLAN 802.11a

FCC ID: 2ACS5-YUNHDA
IC: 11554B-YUNHDA
APPLICANT: Yuneec Technology Co., Limited

Application Type: Certification
Product: Inductrix FPV HD RTF
Model No.: BLH9900
Brand Name: Blade
FCC Classification: Unlicensed National Information Infrastructure (UNII)
FCC Rule Part(s): Part15 Subpart E (Section 15.407)
ISED Rule(s): RSS-247 Issue 2, RSS-GEN Issue 5
Test Procedure(s): ANSI C63.10-2013, KDB 789033 D02v02r01
Test Date: March 01 ~ October 17, 2018

Reviewed By : Sunny Sun
 (Sunny Sun)
 Approved By : Robin Wu
 (Robin Wu)



The test results relate only to the samples tested.
 This equipment has been shown to be capable of compliance with the applicable technical standards as indicated in the measurement report and was tested in accordance with the measurement procedures specified in KDB 789033 D02v02r01. Test results reported herein relate only to the item(s) tested.
 The test report shall not be reproduced except in full without the written approval of MRT Technology (Suzhou) Co., Ltd.

Revision History

Report No.	Version	Description	Issue Date	Note
1803RSU014-U1	Rev. 01	Initial Report	05-26-2018	Invalid
1803RSU014-U1	Rev. 02	Update Product Name, Model, Brand Name and Raise the Target Power	10-18-2018	Valid

CONTENTS

Description	Page
1. INTRODUCTION	6
1.1. Scope	6
1.2. MRT Test Location	6
2. PRODUCT INFORMATION	7
2.1. Equipment Description.....	7
2.2. Product Specification Subjective to this Report.....	7
2.3. Operation Frequency and Channel List for this report.....	7
2.4. Test Mode	7
2.5. Description of Test Software.....	8
2.6. Device Capabilities	8
2.7. Test Configuration	9
2.8. EMI Suppression Device(s)/Modifications.....	9
2.9. Labeling Requirements.....	9
3. DESCRIPTION OF TEST	10
3.1. Evaluation Procedure	10
3.2. AC Line Conducted Emissions	10
3.3. Radiated Emissions	11
4. ANTENNA REQUIREMENTS.....	12
5. TEST EQUIPMENT CALIBRATION DATE	13
6. MEASUREMENT UNCERTAINTY.....	14
7. TEST RESULT	15
7.1. Summary	15
7.2. 26dB Bandwidth & 99% Bandwidth Measurement	17
7.2.1. Test Limit	17
7.2.2. Test Procedure used.....	17
7.2.3. Test Setting.....	17
7.2.4. Test Setup	17
7.2.5. Test Result.....	18
7.3. 6dB Bandwidth Measurement.....	20
7.3.1. Test Limit	20
7.3.2. Test Procedure used.....	20
7.3.3. Test Setting.....	20
7.3.4. Test Setup	20

7.3.5. Test Result.....	21
7.4. Output Power Measurement.....	22
7.4.1. Test Limit	22
7.4.2. Test Procedure Used	22
7.4.3. Test Setting.....	22
7.4.4. Test Setup	22
7.4.5. Test Result.....	23
7.5. Power Spectral Density Measurement.....	25
7.5.1. Test Limit	25
7.5.2. Test Procedure Used	25
7.5.3. Test Setting.....	25
7.5.4. Test Setup	26
7.5.5. Test Result.....	27
7.6. Frequency Stability Measurement.....	29
7.6.1. Test Limit	29
7.6.2. Test Procedure Used	29
7.6.3. Test Setup	30
7.6.4. Test Result.....	31
7.7. Radiated Spurious Emission Measurement	32
7.7.1. Test Limit	32
7.7.2. Test Procedure Used	32
7.7.3. Test Setting.....	32
7.7.4. Test Setup	34
7.7.5. Test Result.....	35
7.8. Radiated Restricted Band Edge Measurement	43
7.8.1. Test Limit	43
7.8.2. Test Procedure Used	46
7.8.3. Test Setting.....	47
7.8.4. Test Setup	47
7.8.5. Test Result.....	48
7.9. AC Conducted Emissions Measurement.....	56
7.9.1. Test Limit	56
7.9.2. Test Setup	56
7.9.3. Test Result.....	56
8. CONCLUSION.....	57
Appendix A - Test Setup Photograph	58
Appendix B - EUT Photograph.....	59

§2.1033 General Information

Applicant:	Yunee Technology Co., Limited
Applicant Address:	Unit 2301, 23/F, 9 Chong Yip Street, Kwun Tong, Kowloon, Hong Kong.
Manufacturer:	Yunee International (China) Co., Ltd.
Manufacturer Address:	No.388 East Zhengwei Road, Jinxi Town, Kunshan, Jiangsu 215324, China
Test Site:	MRT Technology (Suzhou) Co., Ltd
Test Site Address:	D8 Building, No.2 Tian'edang Rd., Wuzhong Economic Development Zone, Suzhou, China
FCC Registration No.:	893164
IC Registration No.:	11384A-1
Test Device Serial No.:	N/A <input type="checkbox"/> Production <input checked="" type="checkbox"/> Pre-Production <input type="checkbox"/> Engineering

Test Facility / Accreditations

Measurements were performed at MRT Laboratory located in Tian'edang Rd., Suzhou, China.

- MRT facility is a FCC registered (MRT Reg. No. 893164) test facility with the site description report on file and has met all the requirements specified in ANSI C63.4-2014.
- MRT facility is an IC registered (MRT Reg. No. 11384A-1) test laboratory with the site description on file at Industry Canada.
- MRT facility is a VCCI registered (R-20025, G-20034, C-20020, T-20020) test laboratory with the site description on file at VCCI Council.
- MRT Lab is accredited to ISO 17025 by the American Association for Laboratory Accreditation (A2LA) under the American Association for Laboratory Accreditation Program (A2LA Cert. No. 3628.01) in EMC, Telecommunications, Radio and SAR testing.



1. INTRODUCTION

1.1. Scope

Measurement and determination of electromagnetic emissions (EMC) of radio frequency devices including intentional and/or unintentional radiators for compliance with the technical rules and regulations of the Federal Communications Commission and the Industry Canada Certification and Engineering Bureau.

1.2. MRT Test Location

The map below shows the location of the MRT LABORATORY, its proximity to the Taihu Lake. These measurement tests were conducted at the MRT Technology (Suzhou) Co., Ltd. Facility located at D8 Building, No.2 Tian'edang Rd., Wuzhong Economic Development Zone, Suzhou, China. The measurement facility compliant with the test site requirements specified in ANSI C63.4-2014.



2. PRODUCT INFORMATION

2.1. Equipment Description

Product Name:	Inductrix FPV HD RTF
Model No.:	BLH9900
Brand Name:	Blade
Wi-Fi Specification:	802.11a
Zigbee Specification:	802.15.4 (Receive only)

2.2. Product Specification Subjective to this Report

Frequency Range:	5180~5240MHz, 5745~5825MHz (For FCC) 5745~5825MHz (For IC)
Type of Modulation:	OFDM
Data Rate:	6/9/12/18/24/36/48/54Mbps
Maximum Average Output Power:	25.30dBm
Antenna Type:	PCB Antenna
Antenna Gain:	1.49dBi

2.3. Operation Frequency and Channel List for this report

For FCC

Channel	Frequency	Channel	Frequency	Channel	Frequency
36	5180 MHz	40	5200 MHz	44	5220 MHz
48	5240 MHz	149	5745 MHz	153	5765 MHz
157	5785 MHz	161	5805 MHz	165	5825 MHz

For IC

Channel	Frequency	Channel	Frequency	Channel	Frequency
149	5745 MHz	153	5765 MHz	157	5785 MHz
161	5805 MHz	165	5825 MHz	---	---

2.4. Test Mode

Test Mode	Mode 1: Transmit by 802.11a (6Mbps)
-----------	-------------------------------------

2.5. Description of Test Software

The test utility software used during testing was engineering directive ordered by applicant.

Mode	Channel No.	Frequency (MHz)	Power Parameter Value
802.11a	36	5180	59
	44	5220	58
	48	5240	58
	149	5745	54
	157	5785	54
	165	5825	52

2.6. Device Capabilities

This device contains the following capabilities:

802.11a WLAN (NII) and 802.15.4 Zigbee(receiver function only) devices.

Note: 5GHz (UNII) operation is possible in 20MHz channel bandwidths. The maximum achievable duty cycles for all modes were determined based on measurements performed on a spectrum analyzer in zero-span mode with RBW = 8MHz, VBW = 50MHz.

The duty cycles are as follows:

Test Mode	Duty Cycle
802.11a	93.38 %
802.11a (T = 2.055 ms)	

Marker	Mode	Trch	Scal	X	Y	Function	Function Unit	Function Value
1	A2	1	t	(Δ)	2.055 ms	(Δ)		0.29 dB
2	F	1	t	(Δ)	4.015 ms	(Δ)		15.16 dBm
3	A4	1	t	(Δ)	2.210 ms	(Δ)		3.00 dB
4	F	1	t	(Δ)	4.015 ms	(Δ)		15.16 dBm

2.7. Test Configuration

The device was tested per the guidance of KDB 789033 D02v02r01. ANSI C63.10-2013 was used to reference the appropriate EUT setup for radiated spurious emissions testing and AC line conducted testing.

2.8. EMI Suppression Device(s)/Modifications

No EMI suppression device(s) were added and/or no modifications were made during testing.

2.9. Labeling Requirements

Per 2.1074 & 15.19; Docket 95-19

The label shall be permanently affixed at a conspicuous location on the device; instruction manual or pamphlet supplied to the user and be readily visible to the purchaser at the time of purchase. However, when the device is so small wherein placement of the label with specified statement is not practical, only the FCC ID must be displayed on the device per Section 15.19(a)(5). Please see attachment for FCC ID label and label location.

RSP-100 Issue 11 Section 3

The manufacturer, importer or distributor shall meet the labelling requirements set out in this section for every unit:

- (i) prior to marketing in Canada, for products manufactured in Canada
- (ii) prior to importation into Canada, for imported products

For information regarding the e-labelling option, see Notice 2014–DRS1003. The label for the certified product represents the manufacturer's or importer's compliance with Innovation, Science and Economic Development Canada's (ISED) regulatory requirements.

Please see attachment for IC label and label location.

3. DESCRIPTION OF TEST

3.1. Evaluation Procedure

The measurement procedures described in the American National Standard for Testing Unlicensed Wireless Devices (ANSI C63.10-2013), and the guidance provided in KDB 789033 D02v02r01 were used in the measurement.

Deviation from measurement procedure.....None

3.2. AC Line Conducted Emissions

The line-conducted facility is located inside an 8'x4'x4' shielded enclosure. A 1m x 2m wooden table 80cm high is placed 40cm away from the vertical wall and 80cm away from the sidewall of the shielded room. Two 10kHz-30MHz, 50Ω/50uH Line-Impedance Stabilization Networks (LISNs) are bonded to the shielded room floor. Power to the LISNs is filtered by external high-current high-insertion loss power line filters. These filters attenuate ambient signal noise from entering the measurement lines. These filters are also bonded to the shielded enclosure.

The EUT is powered from one LISN and the support equipment is powered from the second LISN. All interconnecting cables more than 1 meter were shortened to a 1 meter length by non-inductive bundling (serpentine fashion) and draped over the back edge of the test table. All cables were at least 40cm above the horizontal reference ground-plane. Power cables for support equipment were routed down to the second LISN while ensuring that that cables were not draped over the second LISN.

Sufficient time for the EUT, support equipment, and test equipment was allowed in order for them to warm up to their normal operating condition. The RF output of the LISN was connected to the receiver and exploratory measurements were made to determine the frequencies producing the maximum emission from the EUT. The receiver was scanned from 150kHz to 30MHz. The detector function was set to peak mode for exploratory measurements while the bandwidth of the analyzer was set to 9kHz. The EUT, support equipment, and interconnecting cables were arranged and manipulated to maximize each emission. Each emission was also maximized by varying: power lines, the mode of operation or data exchange speed, or support equipment whichever determined the worst-case emission. Once the worst case emissions have been identified, the one EUT cable configuration/arrangement and mode of operation that produced these emissions are used for final measurements on the same test site. The analyzer is set to CISPR quasi-peak and average detectors with a 9kHz resolution bandwidth for final measurements.

An extension cord was used to connect to a single LISN which powered by EUT. The extension cord was calibrated with LISN, the impedance and insertion loss are compliance with the requirements as stated in ANSI C63.10-2013.

3.3. Radiated Emissions

The radiated test facilities consisted of an indoor 3 meter semi-anechoic chamber used for final measurements and exploratory measurements, when necessary. The measurement area is contained within the semi-anechoic chamber which is shielded from any ambient interference. For measurements above 1GHz absorbers are arranged on the floor between the turn table and the antenna mast in such a way so as to maximize the reduction of reflections. For measurements below 1GHz, the absorbers are removed. A MF Model 210SS turntable is used for radiated measurement. It is a continuously rotatable, remote controlled, metallic turntable and 2 meters (6.56 ft.) in diameter. The turn table is flush with the raised floor of the chamber in order to maintain its function as a ground plane. An 80cm high PVC support structure is placed on top of the turntable.

For all measurements, the spectrum was scanned through all EUT azimuths and from 1 to 4 meter receive antenna height using a broadband antenna from 30MHz up to the upper frequency shown in 15.33(b)(1) depending on the highest frequency generated or used in the device or on which the device operates or tunes. For frequencies above 1GHz, linearly polarized double ridge horn antennas were used. For frequencies below 30MHz, a calibrated loop antenna was used. When exploratory measurements were necessary, they were performed at 1 meter test distance inside the semi-anechoic chamber using broadband antennas, broadband amplifiers, and spectrum analyzers to determine the frequencies and modes producing the maximum emissions. Sufficient time for the EUT, support equipment, and test equipment was allowed in order for them to warm up to their normal operating condition. The test set-up for frequencies below 1GHz was placed on top of the 0.8 meter high, 1 x 1.5 meter table; and test set-up for frequencies 1-40GHz was placed on top of the 1.5 meter high, 1 x 1.5 meter table. The EUT, support equipment, and interconnecting cables were arranged and manipulated to maximize each emission. Appropriate precaution was taken to ensure that all emissions from the EUT were maximized and investigated. The system configuration, clock speed, mode of operation or video resolution, if applicable, turntable azimuth, and receive antenna height was noted for each frequency found.

Final measurements were made in the semi-anechoic chamber using calibrated, linearly polarized broadband and horn antennas. The test setup was configured to the setup that produced the worst case emissions. The spectrum analyzer was set to investigate all frequencies required for testing to compare the highest radiated disturbances with respect to the specified limits. The turntable containing the EUT was rotated through 360 degrees and the height of the receive antenna was varied 1 to 4 meters and stopped at the azimuth and height producing the maximum emission. Each emission was maximized by changing the orientation of the EUT through three orthogonal planes and changing the polarity of the receive antenna, whichever produced the worst-case emissions. According to 3dB Beam-Width of horn antenna, the horn antenna should be always directed to the EUT when rising height.

4. ANTENNA REQUIREMENTS

Excerpt from §15.203 of the FCC Rules/Regulations:

“An intentional radiator antenna shall be designed to ensure that no antenna other than that furnished by the responsible party can be used with the device. The use of a permanently attached antenna or of an antenna that uses a unique coupling to the intentional radiator shall be considered sufficient to comply with the provisions of this section.”

- The antenna of the **Inductrix FPV HD RTF** is **permanently attached**.
- There are no provisions for connection to an external antenna.

Conclusion:

The unit complies with the requirement of §15.203.

5. TEST EQUIPMENT CALIBRATION DATE

Conducted Emissions - SR2

Instrument	Manufacturer	Type No.	Asset No.	Cali. Interval	Cali. Due Date
EMI Test Receiver	R&S	ESR3	MRTSUE06185	1 year	2019/04/20
Two-Line V-Network	R&S	ENV216	MRTSUE06002	1 year	2019/06/15
Two-Line V-Network	R&S	ENV216	MRTSUE06003	1 year	2019/06/15
Thermohygrometer	Testo	608-H1	MRTSUE06404	1 year	2019/08/15
Shielding Anechoic Chamber	Mikebang	Chamber-SR2	MRTSUE06214	N/A	N/A

Radiated Emissions - AC1

Instrument	Manufacturer	Type No.	Asset No.	Cali. Interval	Cali. Due Date
PXA Signal Analyzer	Keysight	9030B	MRTSUE06395	1 year	2019/09/06
EMI Test Receiver	R&S	ESR7	MRTSUE06001	1 year	2019/08/14
Loop Antenna	Schwarzbeck	FMZB1519	MRTSUE06025	1 year	2018/11/20
Bilog Period Antenna	Schwarzbeck	VULB 9168	MRTSUE06172	1 year	2019/04/12
Broad Band Horn Antenna	Schwarzbeck	BBHA9120D	MRTSUE06023	1 year	2018/10/21
Microwave System Amplifier	Agilent	83017A	MRTSUE06076	1 year	2018/11/17
Broad Band Horn Antenna	Schwarzbeck	BBHA 9170	MRTSUE06024	1 year	2018/12/14
Amplifier	Schwarzbeck	BBV 9721	MRTSUE06121	1 year	2019/06/13
Thermohygrometer	Testo	608-H1	MRTSUE06403	1 year	2019/08/15
Anechoic Chamber	TDK	Chamber-AC1	MRTSUE06212	1 year	2019/05/02

Conducted Test Equipment - TR3

Instrument	Manufacturer	Type No.	Asset No.	Cali. Interval	Cali. Due Date
Spectrum Analyzer	Agilent	N9020A	MRTSUE06106	1 year	2019/04/20
Power Meter	Agilent	U2021XA	MRTSUE06030	1 year	2018/12/06
Thermohygrometer	Testo	608-H1	MRTSUE06401	1 year	2019/08/15

Software	Version	Function
e3	V 8.3.5	EMI Test Software

6. MEASUREMENT UNCERTAINTY

Where relevant, the following test uncertainty levels have been estimated for tests performed on the EUT as specified in CISPR 16-4-2. This uncertainty represents an expanded uncertainty expressed at approximately the 95% confidence level using a coverage factor of $k = 2$.

AC Conducted Emission Measurement - SR2
Measuring Uncertainty for a Level of Confidence of 95% ($U=2Uc(y)$): 150kHz~30MHz: 3.46dB
Radiated Emission Measurement - AC1
Measuring Uncertainty for a Level of Confidence of 95% ($U=2Uc(y)$): 9kHz ~ 1GHz: 4.18dB 1GHz ~ 40GHz: 4.76dB
Output Power - TR3
Measuring Uncertainty for a Level of Confidence of 95% ($U=2Uc(y)$): 1.13dB
Power Spectrum Density - TR3
Measuring Uncertainty for a Level of Confidence of 95% ($U=2Uc(y)$): 1.15dB
Occupied Bandwidth - TR3
Measuring Uncertainty for a Level of Confidence of 95% ($U=2Uc(y)$): 0.28%

7. TEST RESULT

7.1. Summary

Company Name: Yunee Technology Co., Limited

FCC ID: 2ACS5-YUNHDA

IC: 11554B-YUNHDA

FCC Section(s)	Test Description	Test Limit	Test Condition	Test Result	Reference
15.407(a)	26dB Bandwidth	N/A	Conducted	Pass	Section 7.2
15.407(e)	6dB Bandwidth	$\geq 500\text{kHz}$		Pass	Section 7.3
15.407(a)(1)(iii), (3)	Maximum Conducted Output Power	Refer to section 7.4		Pass	Section 7.4
15.407(a)(1)(iii), (3), (5)	Peak Power Spectral Density	Refer to section 7.5		Pass	Section 7.5
15.407(g)	Frequency Stability	N/A		Pass	Section 7.6
15.407(b)(1), (4)(i)	Undesirable Emissions	$\leq -27\text{dBm/MHz EIRP}$	Radiated	Pass	Section 7.7 & 7.8
15.205, 15.209 15.407(b)(5), (6), (7)	General Field Strength Limits (Restricted Bands and Radiated Emission Limits)	Emissions in restricted bands must meet the radiated limits detailed in 15.209		Pass	
15.207	AC Conducted Emissions 150kHz - 30MHz	$< \text{FCC 15.207 limits}$	Line Conducted	N/A	Section 7.9

RSS Section(s)	Test Description	Test Limit	Test Condition	Test Result	Reference
RSS-247 §6.2	99% Bandwidth	N/A	Conducted	Pass	Section 7.2
RSS-247 §6.2.4	6dB Bandwidth	>500kHz		Pass	Section 7.3
RSS-247 §6.2.1, §6.2.4	Max Conducted Output Power	Refer to section 7.4		Pass	Section 7.4
	Maximum E.I.R.P			Pass	Section 7.5
RSS-247 §6.2.1, §6.2.4	Peak Power Spectral Density	Refer to section 7.5		Pass	Section 7.6
RSS-Gen [8.11]	Frequency Stability	N/A	Pass	Section 7.6	
RSS-247 §6.2.1, §6.2.4	Out-of-Band Emissions	≤ -27dBm/MHz EIRP	Radiated	Pass	Section 7.7 & 7.8
RSS-247 §6.2.1, §6.2.4	General Field Strength Limits (Restricted Bands and Radiated Emission Limits)	Emissions in restricted bands must meet the radiated limits detailed in RSS-Gen [8.9]		Pass	
RSS-Gen [8.8]	AC Conducted Emissions 150kHz - 30MHz	≤ RSS-Gen [8.8] Limit	Line Conducted	N/A	Section 7.9

Notes:

- 1) All channels, modes, and modulations/data rates were investigated among all UNII bands. For radiated emission test, every axis (X, Y, Z) was also verified. The test results shown in the following sections represent the worst case emissions.
- 2) The analyzer plots shown in this section were all taken with a correction table loaded into the analyzer. The correction table was used to account for the losses of the cables and attenuators used as part of the system to connect the EUT to the analyzer at all frequencies of interest.

7.2. 26dB Bandwidth & 99% Bandwidth Measurement

7.2.1. Test Limit

N/A

7.2.2. Test Procedure used

KDB 789033 D02v02r01 – Section C.1

7.2.3. Test Setting

1. The analyzers' automatic bandwidth measurement capability was used to perform the 26dB bandwidth measurement. The "X" dB bandwidth parameter was set to $X = 26$. The automatic bandwidth measurement function also has the capability of simultaneously measuring the 99% occupied bandwidth. The bandwidth measurement was not influenced by any intermediated power nulls in the fundamental emission.
2. RBW = approximately 1% of the emission bandwidth.
3. VBW $\geq 3 \times$ RBW.
4. Detector = Peak.
5. Trace mode = max hold.

7.2.4. Test Setup

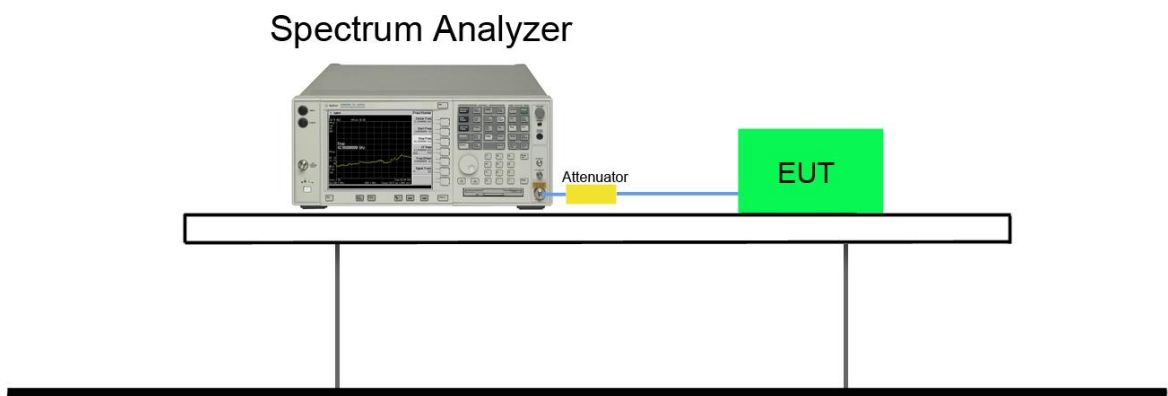

7.2.5. Test Result

Product	Inductrix FPV HD RTF	Temperature	24°C
Test Engineer	Hunk Li	Relative Humidity	53%
Test Site	TR3	Test Date	2018/05/14

Test Mode	Data Rate (Mbps)	Channel No.	Frequency (MHz)	26dB Bandwidth (MHz)	99% Bandwidth (MHz)
802.11a	6	36	5180	21.80	17.08
802.11a	6	44	5220	27.83	17.08
802.11a	6	48	5240	21.65	17.05
802.11a	6	149	5745	32.33	17.23
802.11a	6	157	5785	27.85	17.06
802.11a	6	165	5805	21.86	16.97

802.11a 26dB Bandwidth & 99% Bandwidth

Channel 36 (5180MHz)

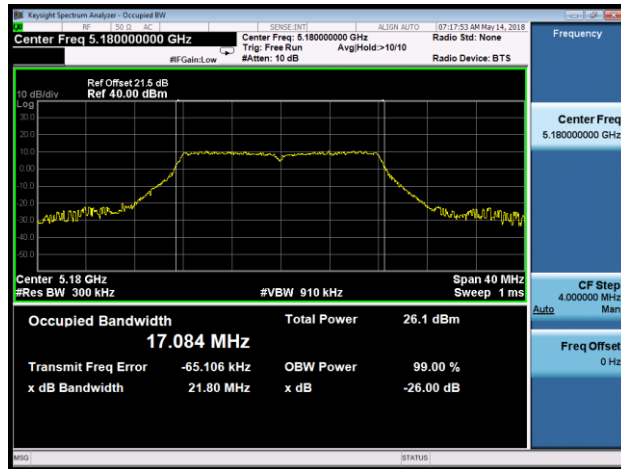

Channel 44 (5220MHz)

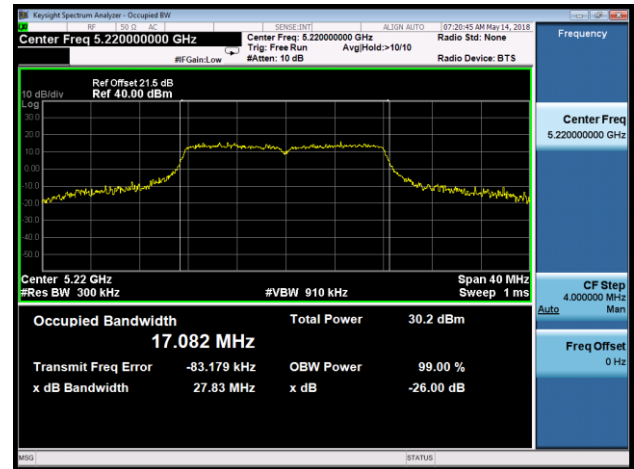

Channel 48 (5240MHz)

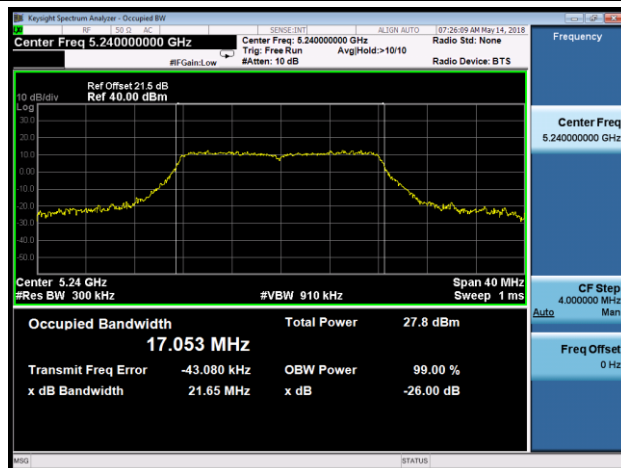

Channel 149 (5745MHz)

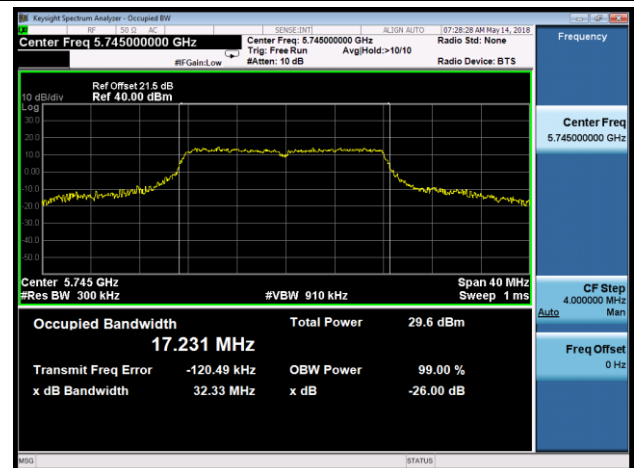

Channel 157 (5785MHz)

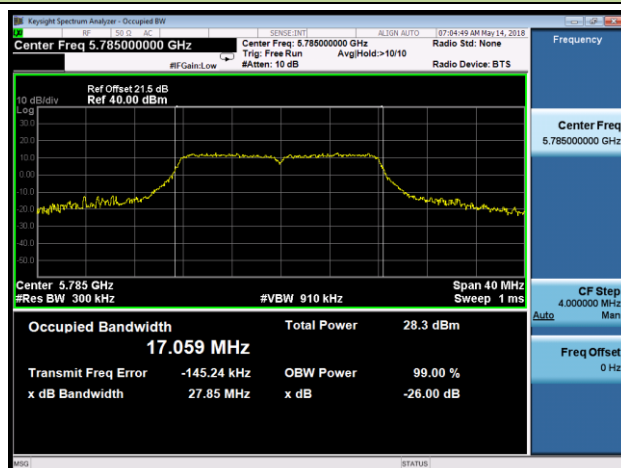

Channel 165 (5825MHz)

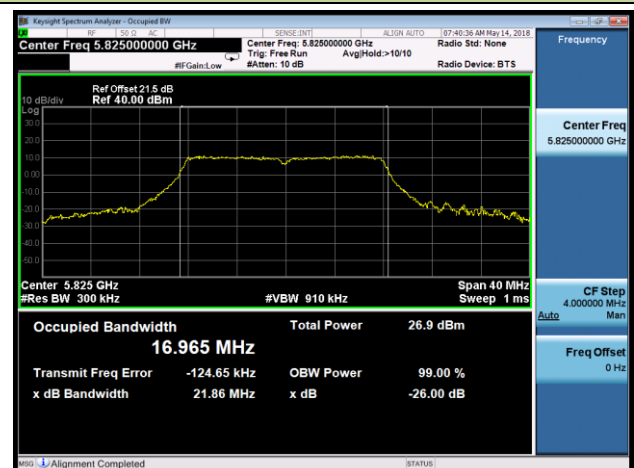

7.3. 6dB Bandwidth Measurement

7.3.1. Test Limit

The minimum 6dB bandwidth shall be at least 500 kHz.

7.3.2. Test Procedure used

KDB 789033 D02v02r01 - Section C.2

7.3.3. Test Setting

1. Set center frequency to the nominal EUT channel center frequency.
2. RBW = 100 kHz.
3. VBW $\geq 3 \times$ RBW.
4. Detector = Peak.
5. Trace mode = max hold.
6. Sweep = auto couple.
7. Allow the trace to stabilize.
8. Measure the maximum width of the emission that is constrained by the frequencies associated with the two outermost amplitude points (upper and lower frequencies) that are attenuated by 6 dB relative to the maximum level measured in the fundamental emission.

7.3.4. Test Setup

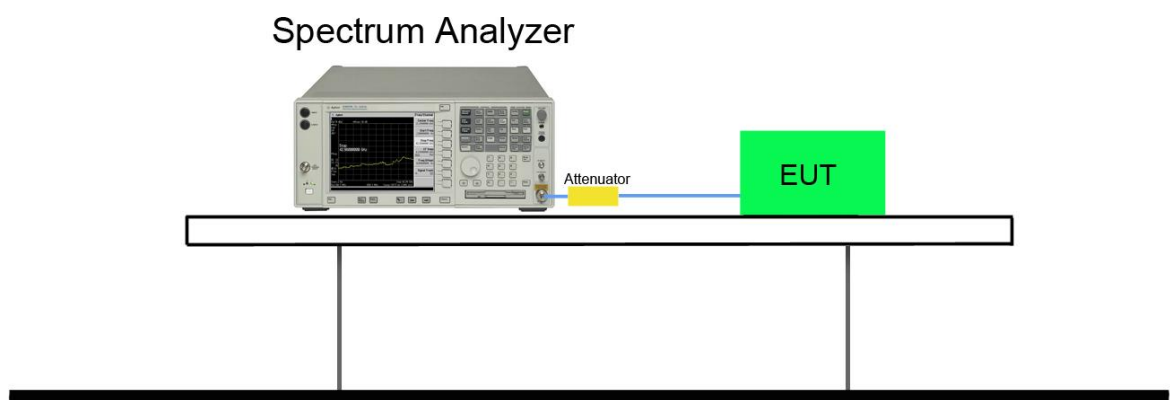

7.3.5. Test Result

Product	Inductrix FPV HD RTF	Temperature	24°C
Test Engineer	Lewis Huang	Relative Humidity	53%
Test Site	TR3	Test Date	2018/05/14

Test Mode	Data Rate (Mbps)	Channel No.	Frequency (MHz)	6dB Bandwidth (MHz)	Limit (MHz)	Result
802.11a	6	149	5745	16.39	≥ 0.5	Pass
802.11a	6	157	5785	16.31	≥ 0.5	Pass
802.11a	6	165	5825	16.37	≥ 0.5	Pass

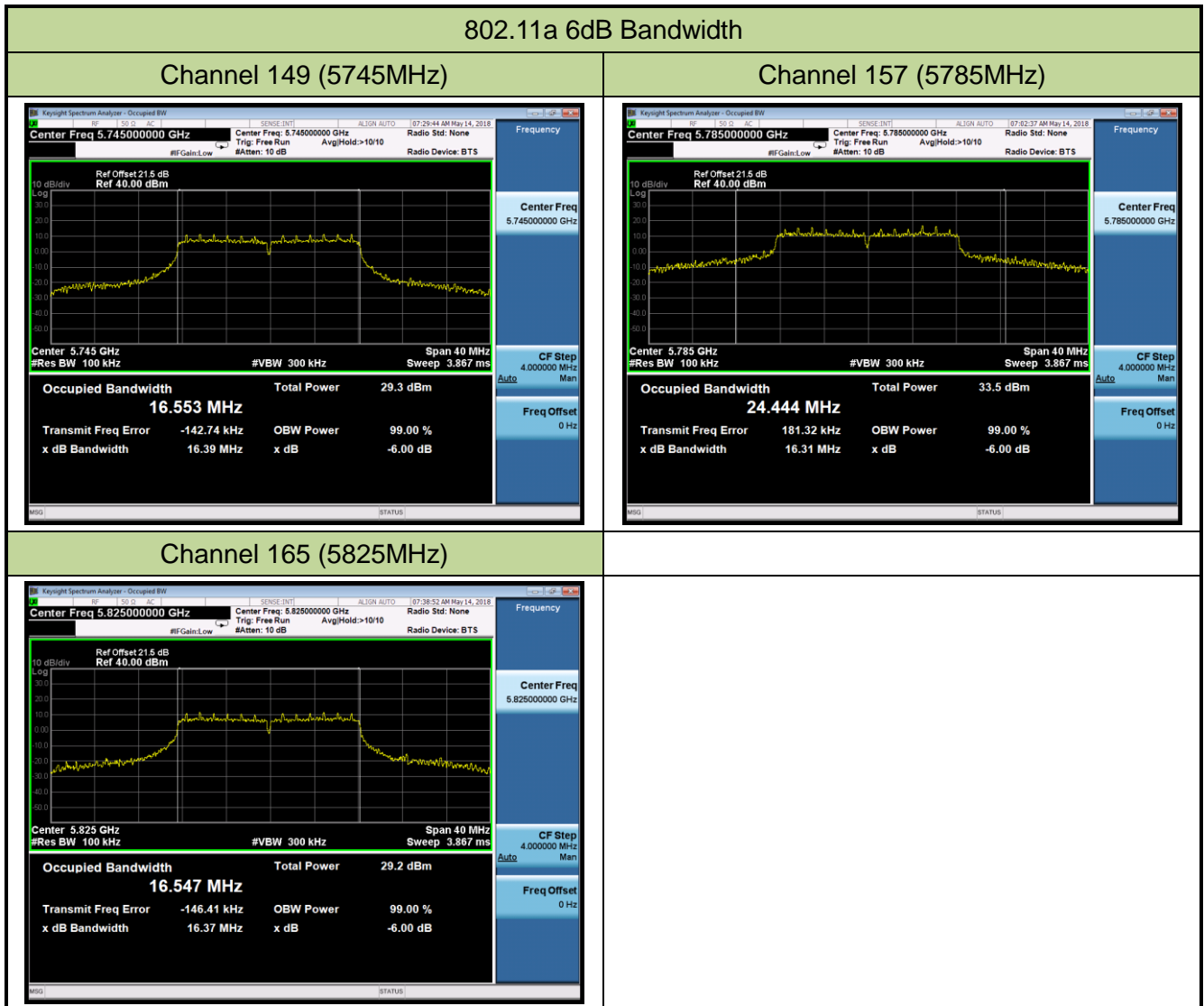

7.4. Output Power Measurement

7.4.1. Test Limit

For FCC

For fixed point-to-point access points operating in the band 5.15-5.25 GHz, the maximum conducted output power over the frequency band of operation shall not exceed 1 W

For the band 5.725-5.85 GHz, the maximum conducted output power over the frequency band of operation shall not exceed 1 W (30dBm).

Additional Requirement for IC

For the band 5.15-5.25 GHz, the maximum e.i.r.p. shall not exceed 200mW (23.01dBm) or $10 + 10 \log_{10} B$, dBm, whichever power is less. B is the 99% emission bandwidth in MHz.

7.4.2. Test Procedure Used

KDB 789033 D02v02r01 - Section E) 3) b) Method PM-G

7.4.3. Test Setting

Average power measurements were performed only when the EUT was transmitting at its maximum power control level using a broadband power meter with a pulse sensor. The power meter implemented triggering and gating capabilities which were set up such that power measurements were recorded only during the ON time of the transmitter.

7.4.4. Test Setup

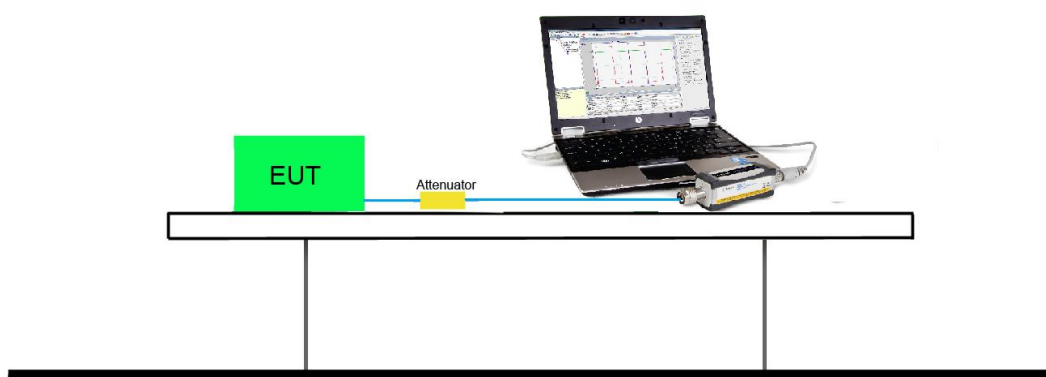

7.4.5. Test Result

Power output test was verified over all data rates of each mode shown as below table, and then choose the maximum power output (Gray Marker) for final test of each channel.

Test Mode	Frequency (MHz)	Data Rate (Mbps)	Average Power (dBm)
802.11a	5180	6	25.30
		9	25.18
		12	25.05
		18	24.93
		24	24.81
		36	24.59
		48	24.46
		54	24.28

Product	Inductrix FPV HD RTF	Temperature	24°C
Test Engineer	Hunk Li	Relative Humidity	53%
Test Site	TR3	Test Date	2018/05/14
Test Item	Output Power (For FCC)		

Test Mode	Data Rate (Mbps)	Channel No.	Freq. (MHz)	Average Power (dBm)	Average Power Limit (dBm)	Result
802.11a	6	36	5180	25.30	≤ 30.00	Pass
802.11a	6	44	5220	25.23	≤ 30.00	Pass
802.11a	6	48	5240	25.27	≤ 30.00	Pass
802.11a	6	149	5745	25.17	≤ 30.00	Pass
802.11a	6	157	5785	25.14	≤ 30.00	Pass
802.11a	6	165	5825	25.23	≤ 30.00	Pass

Product	Inductrix FPV HD RTF	Temperature	24°C
Test Engineer	Hunk Li	Relative Humidity	53%
Test Site	TR3	Test Date	2018/03/22
Test Item	Output Power (For IC)		

Test Mode	Data Rate (Mbps)	Channel No.	Freq. (MHz)	Average Power (dBm)	Average Power Limit (dBm)	Result
802.11a	6	149	5745	25.17	≤ 30.00	Pass
802.11a	6	157	5785	25.14	≤ 30.00	Pass
802.11a	6	165	5825	25.23	≤ 30.00	Pass

7.5. Power Spectral Density Measurement

7.5.1. Test Limit

For FCC

For fixed point-to-point access points operating in the band 5.15-5.25 GHz, the maximum power spectral density shall not exceed 17 dBm in any 1 megahertz band.

For the band 5.725-5.85 GHz, the maximum power spectral density shall not exceed 30 dBm in any 500-kHz band.

If transmitting antennas of directional gain greater than 6dBi are used, the peak power spectral density shall be reduced by the amount in dB that the directional gain of the antenna exceeds 6dBi.

Additional Requirement for IC

For the band 5.15-5.25 GHz, the e.i.r.p. spectral density shall not exceed 10dBm in any 1.0 MHz band.

7.5.2. Test Procedure Used

KDB 789033 D02v02r01 - Section F

7.5.3. Test Setting

1. Analyzer was set to the center frequency of the UNII channel under investigation
2. Span was set to encompass the entire 26dB OBW of the signal.
3. RBW = 1MHz, if measurement bandwidth of Maximum PSD is specified in 500 kHz,
RBW = 100 kHz
4. VBW = 3MHz
5. Number of sweep points $\geq 2 \times (\text{span} / \text{RBW})$
6. Detector = power averaging (RMS)
7. Sweep time = auto
8. Trigger = free run
9. Use the peak search function on the instrument to find the peak of the spectrum and record its value.
10. Add $10 \cdot \log(1/x)$, where x is the duty cycle, to the measured power in order to compute the average power during the actual transmission times (because the measurement represents an average over both the on and off times of the transmission). For example, add $10 \cdot \log(1/0.25) = 6$ dB if the duty cycle is 25 percent.

11. When the measurement bandwidth of Maximum PSD is specified in 500 kHz, add a constant factor $10 \cdot \log(500\text{kHz}/100\text{kHz}) = 6.99 \text{ dB}$ to the measured result.

7.5.4. Test Setup

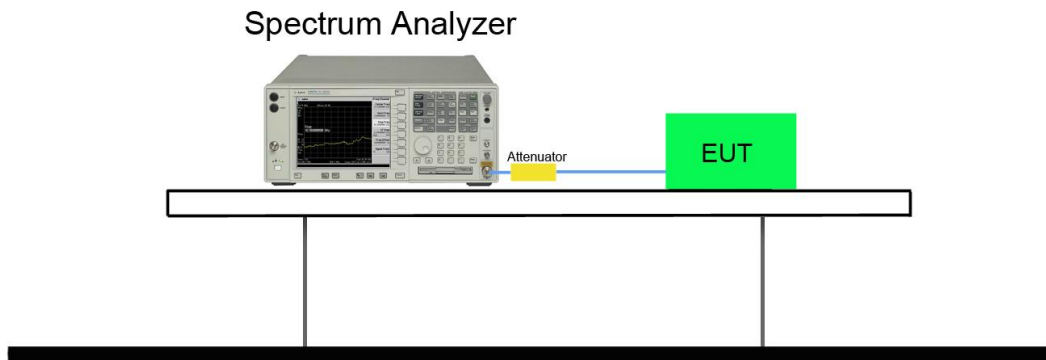

7.5.5. Test Result

Product	Inductrix FPV HD RTF	Temperature	24°C
Test Engineer	Hunk Li	Relative Humidity	53%
Test Site	TR3	Test Date	2018/05/14
Test Item	Power Spectral Density (For FCC NII-Band 1)		

Test Mode	Data Rate (Mbps)	Channel No.	Freq. (MHz)	PSD (dBm/MHz)	Duty Cycle (%)	Final PSD (dBm/MHz)	PSD Limit (dBm/MHz)	Result
802.11a	6	36	5180	11.77	93.38	12.07	≤ 17.00	Pass
802.11a	6	44	5220	10.51	93.38	10.81	≤ 17.00	Pass
802.11a	6	48	5240	12.91	93.38	13.21	≤ 17.00	Pass

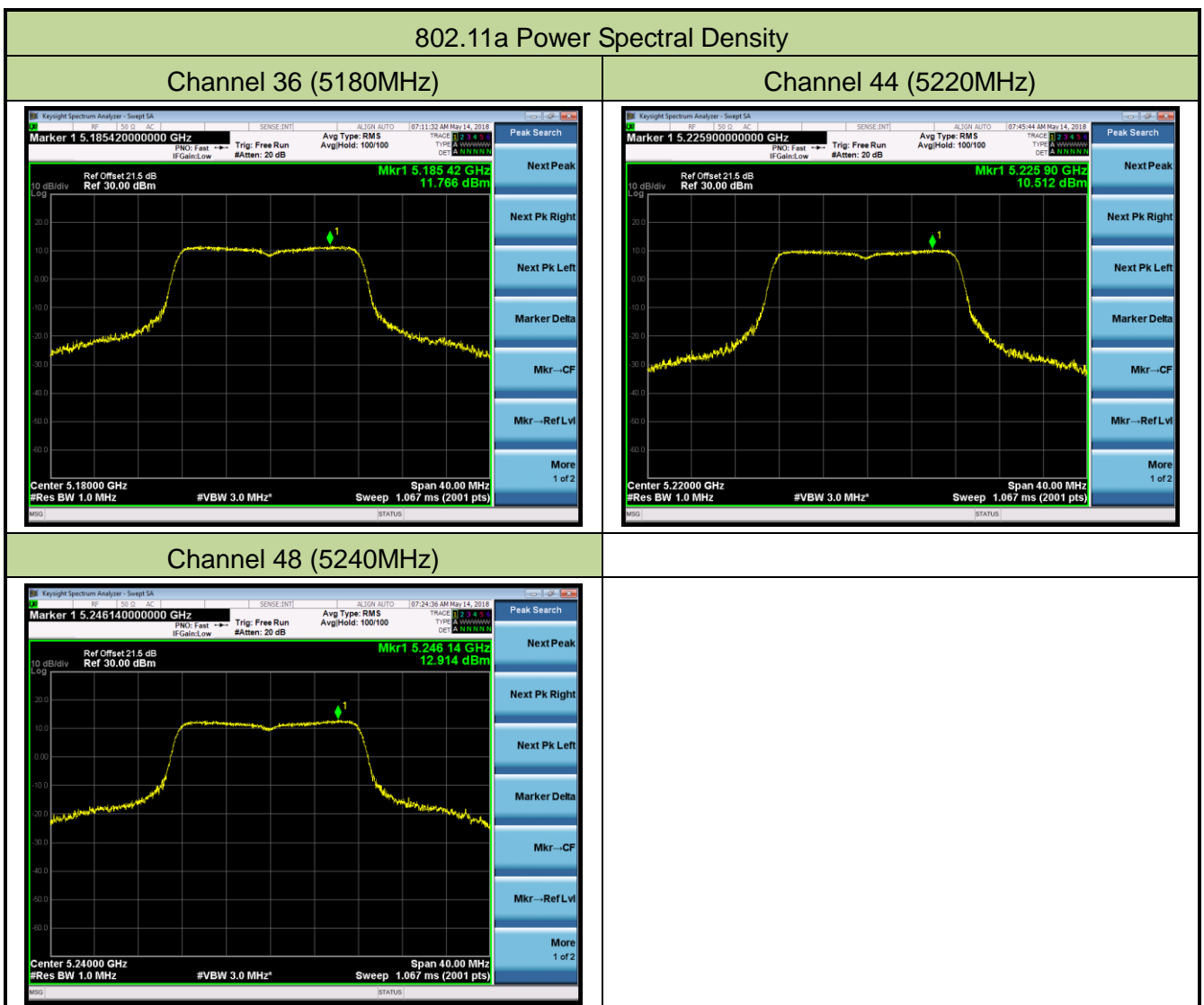

Product	Inductrix FPV HD RTF	Temperature	24°C
Test Engineer	Hunk Li	Relative Humidity	53%
Test Site	TR3	Test Date	2018/05/14
Test Item	Power Spectral Density (For FCC & IC NII-Band 3)		

Test Mode	Data Rate (Mbps)	Channel No.	Freq. (MHz)	PSD (dBm/100kHz)	Duty Cycle (%)	Constant Factor	Final PSD (dBm/500kHz)	Limit (dBm/500kHz)	Result
802.11a	6	149	5745	5.10	93.38	6.99	12.39	≤ 30.00	Pass
802.11a	6	157	5785	5.65	93.38	6.99	12.94	≤ 30.00	Pass
802.11a	6	165	5825	5.85	93.38	6.99	13.14	≤ 30.00	Pass

Note: When EUT duty cycle < 98%, the Final PSD (dBm/500kHz) = PSD (dBm/100kHz) + Constant Factor + 10*log (1/Duty Cycle).

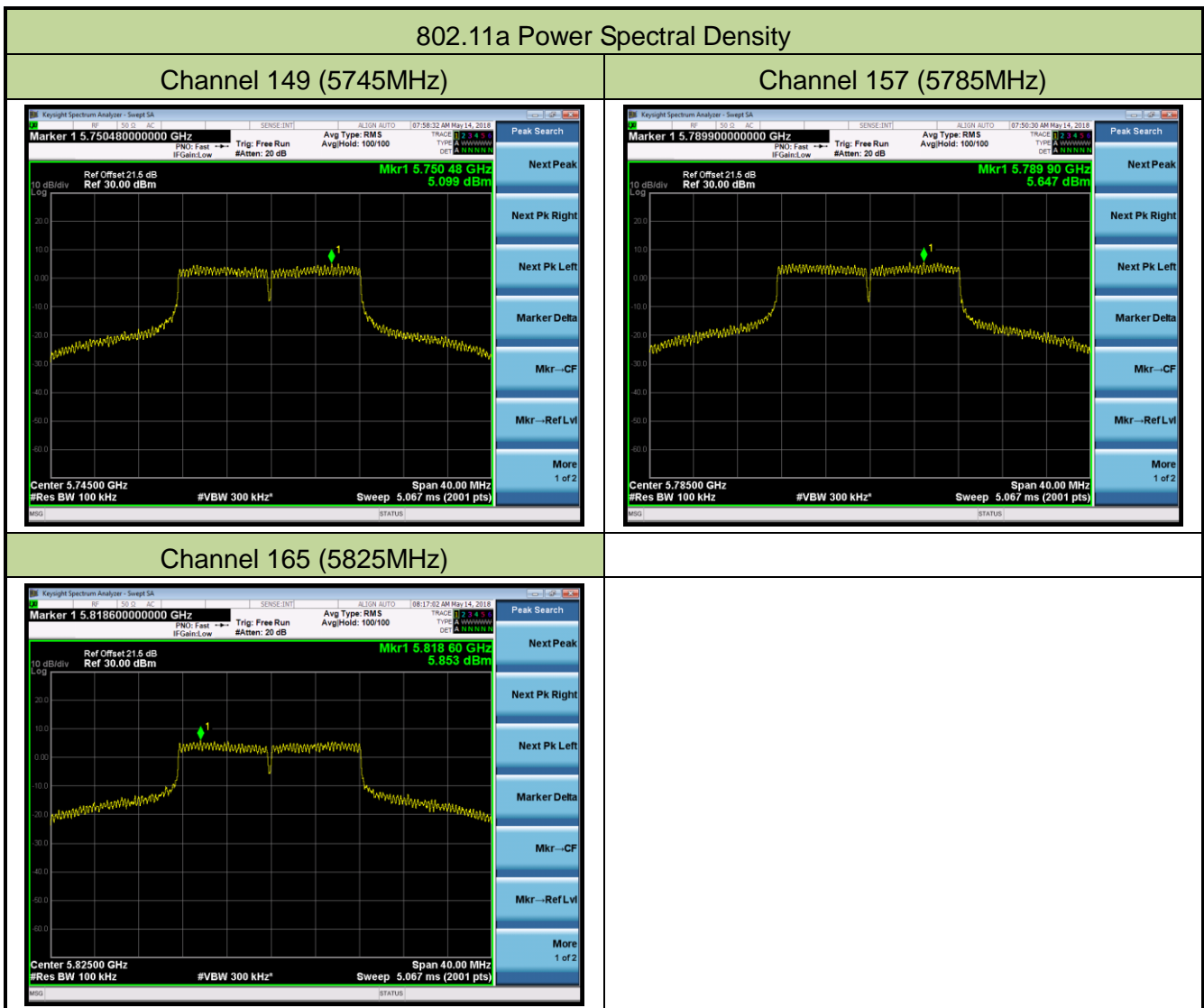

7.6. Frequency Stability Measurement

7.6.1. Test Limit

Manufacturers of U-NII devices are responsible for ensuring frequency stability such that an emission is maintained within the band of operation under all conditions of normal operation as specified in the user's manual.

The transmitter center frequency tolerance shall be ± 20 ppm maximum for the 5GHz band (IEEE 802.11 specification).

7.6.2. Test Procedure Used

Frequency Stability Under Temperature Variations:

The equipment under test was connected to an external AC or DC power supply and input rated voltage. RF output was connected to a frequency counter or spectrum analyzer via feed through attenuators. The EUT was placed inside the temperature chamber. Set the spectrum analyzer RBW low enough to obtain the desired frequency resolution and measure EUT 20°C operating frequency as reference frequency. Turn EUT off and set the chamber temperature to highest. After the temperature stabilized for approximately 30 minutes recorded the frequency. Repeat step measure with 10°C decreased per stage until the lowest temperature reached.

Frequency Stability Under Voltage Variations:

Set chamber temperature to 20°C. Use a variable AC power supply / DC power source to power the EUT and set the voltage to rated voltage. Set the spectrum analyzer RBW low enough to obtain the desired frequency resolution and recorded the frequency.

Reduce the input voltage to specify extreme voltage variation ($\pm 15\%$) and endpoint, record the maximum frequency change.

7.6.3. Test Setup

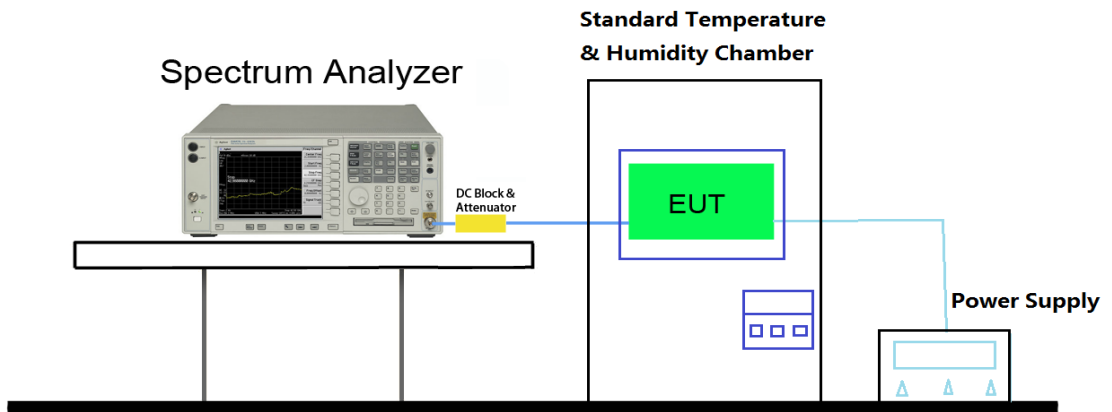

7.6.4. Test Result

Test Engineer	Lewis Huang	Temperature	-30 ~ 50°C
Test Time	2018/03/22	Relative Humidity	52%RH
Test Mode	5180MHz (Carrier Mode)	Test Site	TR3

Voltage (%)	Power	Temp (°C)	Frequency Tolerance (ppm)			
			0 minutes	2 minutes	5 minutes	10 minutes
100%	DC 3.7V	- 30	12.07	13.09	12.31	12.27
		- 20	11.76	12.27	11.49	11.82
		- 10	11.55	12.30	11.83	12.10
		0	10.27	10.67	9.75	10.01
		+ 10	8.09	9.11	8.33	8.65
		+ 20 (Ref)	8.93	9.23	8.51	8.78
		+ 30	9.35	10.35	9.57	9.71
		+ 40	9.56	10.58	9.69	9.90
		+ 50	8.39	9.57	8.92	8.13
115%	DC 4.3V	+ 20	10.11	10.58	9.81	10.08
85%	DC 3.1V	+ 20	10.23	11.25	10.47	10.77

Note: Frequency Tolerance (ppm) = $\frac{\{[\text{Measured Frequency (Hz)} - \text{Declared Frequency (Hz)}]\}}{\text{Declared Frequency (Hz)}} * 10^6$.

7.7. Radiated Spurious Emission Measurement

7.7.1. Test Limit

All out of band emissions appearing in a restricted band as specified in Section 15.205 of the Title 47 CFR must not exceed the limits shown in Table per Section 15.209.

All out of band emissions appearing in a restricted band as specified in Section 8.10 of the RSS-Gen Issue 5 must not exceed the limits shown in Table per Section 8.9.

FCC Part 15 Subpart C Paragraph 15.209 & RSS-Gen Issue4 Section 8.9		
Frequency [MHz]	Field Strength [uV/m]	Measured Distance [Meters]
0.009 ~ 0.490	2400/F (kHz)	300
0.490 ~ 1.705	24000/F (kHz)	30
1.705 ~ 30	30	30
30 ~ 88	100	3
88 ~ 216	150	3
216 ~ 960	200	3
Above 960	500	3

7.7.2. Test Procedure Used

ANSI C63.10 Section 6.3 (General Requirements)

ANSI C63.10 Section 6.4 (Standard test method below 30MHz)

ANSI C63.10 Section 6.5 (Standard test method above 30MHz to 1GHz)

ANSI C63.10 Section 6.6 (Standard test method above 1GHz)

7.7.3. Test Setting

Quasi-Peak Measurements below 1GHz

1. Analyzer center frequency was set to the frequency of the radiated spurious emission of interest
2. Span was set greater than 1MHz
3. RBW = as specified in Table 1
4. Detector = CISPR quasi-peak or power average (Average)
5. Sweep time = auto couple
6. Trace was allowed to stabilize

Table 1 - RBW as a function of frequency

Frequency	RBW
9 ~ 150 kHz	200 ~ 300 Hz
0.15 ~ 30 MHz	9 ~ 10 kHz
30 ~ 1000 MHz	100 ~ 120 kHz

Peak Measurements above 1GHz

1. Analyzer center frequency was set to the frequency of the radiated spurious emission of interest
2. RBW = 1MHz
3. VBW = 3MHz
4. Detector = peak
5. Sweep time = auto couple
6. Trace mode = max hold
7. Trace was allowed to stabilize

Average Measurements above 1GHz (Method AD)

1. Analyzer center frequency was set to the frequency of the radiated spurious emission of interest
2. RBW = 1MHz
3. VBW; If the EUT is configured to transmit with duty cycle $\geq 98\%$, set VBW = 10 Hz.
If the EUT duty cycle is $< 98\%$, set $VBW \geq 1/T$. T is the minimum transmission duration.
4. Detector = Peak
5. Sweep time = auto
6. Trace mode = max hold
7. Allow max hold to run for at least 50 traces if the transmitted signal is continuous or has at least 98% duty cycle. For lower duty cycles, increase the minimum number of traces by a factor of $1/x$, where x is the duty cycle.

7.7.4. Test Setup

9kHz ~ 30MHz Test Setup:

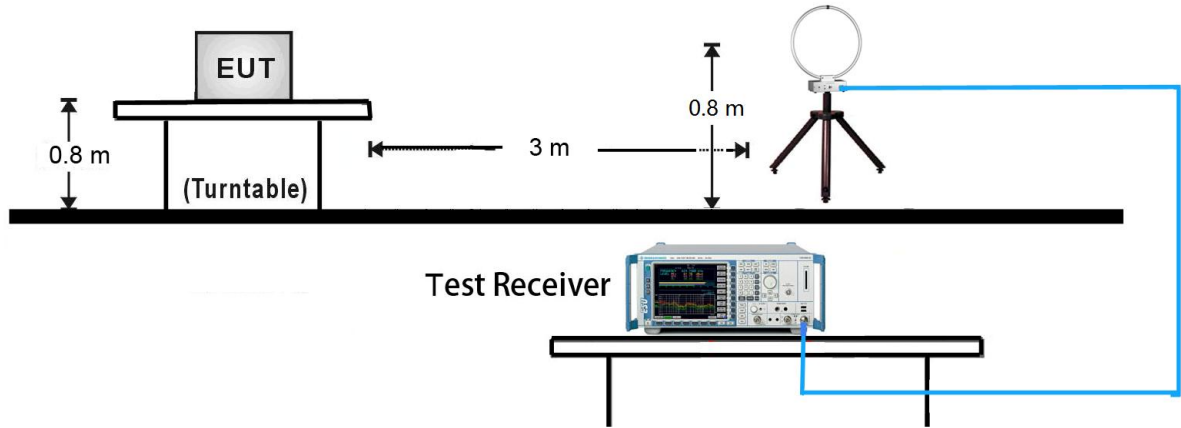

30MHz ~ 1GHz Test Setup:

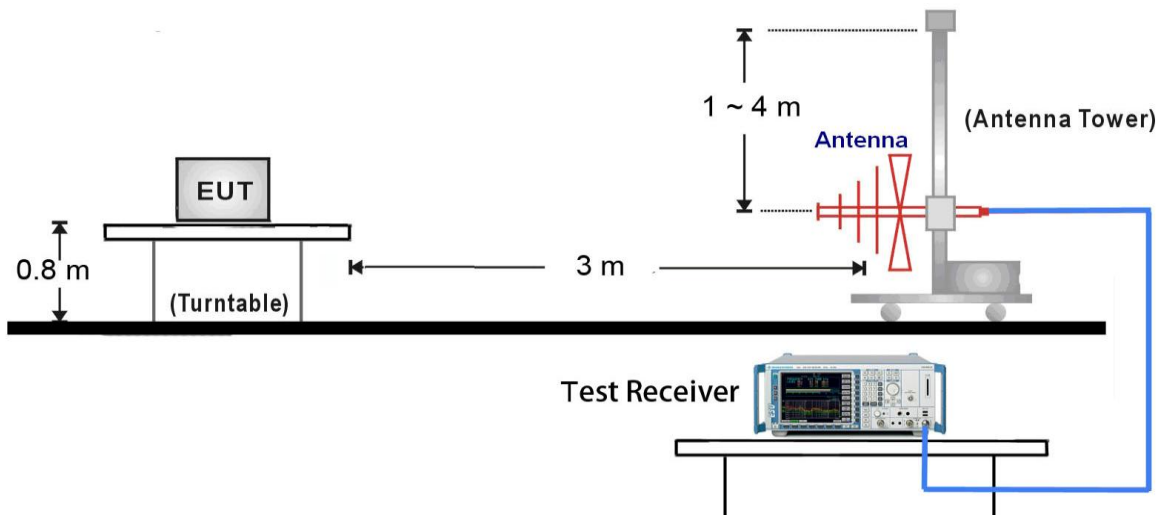

1GHz ~ 40GHz Test Setup:

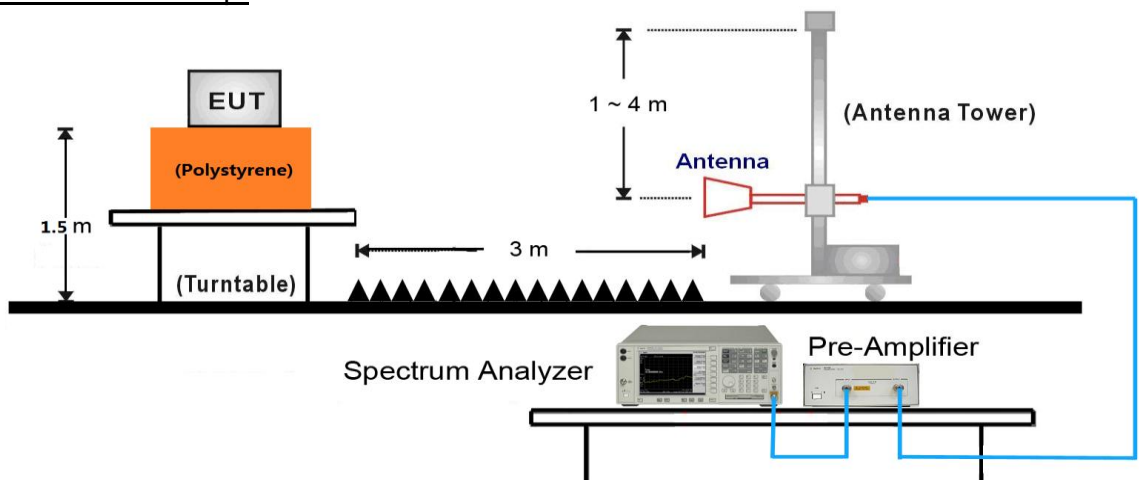

7.7.5. Test Result

Product	Inductrix FPV HD RTF	Temperature	26°C
Test Engineer	Bruce Wang	Relative Humidity	56%
Test Site	AC1	Test Date	2018/05/15
Test Mode:	802.11a	Test Channel:	36
Remark:	1. Average measurement was not performed if peak level lower than average limit. 2. Other frequency was 20dB below limit line within 1-18GHz, there is not show in the report.		

Mark	Frequency (MHz)	Reading Level (dBμV)	Factor (dB)	Measure Level (dBμV/m)	Limit (dBμV/m)	Margin (dB)	Detector	Polarization
*	8794.5	36.4	13.3	49.7	68.2	-18.5	Peak	Horizontal
*	10384.0	35.3	17.4	52.7	68.2	-15.5	Peak	Horizontal
	11217.0	36.4	17.6	54.0	74.0	-20.0	Peak	Horizontal
	12152.0	35.9	17.5	53.4	74.0	-20.6	Peak	Horizontal
*	8811.5	36.9	13.3	50.2	68.2	-18.0	Peak	Vertical
*	10222.5	35.5	17.1	52.6	68.2	-15.6	Peak	Vertical
	11319.0	35.6	17.6	53.2	74.0	-20.8	Peak	Vertical
	12245.5	36.4	17.4	53.8	74.0	-20.2	Peak	Vertical

Note 1: "*" is not in restricted band, its limit is -27dBm/MHz. At a distance of 3 meters, the field strength limit in dBμV/m can be determined by adding a "conversion" factor of 95.2dB to the EIRP limit of -27dBm/MHz to obtain the limit for out of band spurious emissions.

Note 2: Measure Level (dBμV/m) = Reading Level (dBμV) + Factor (dB)

Factor (dB) = Cable Loss (dB) + Antenna Factor (dB/m) - Pre_Amplifier Gain (dB)

Product	Inductrix FPV HD RTF	Temperature	26°C
Test Engineer	Bruce Wang	Relative Humidity	56%
Test Site	AC1	Test Date	2018/05/15
Test Mode:	802.11a	Test Channel:	44
Remark:	1. Average measurement was not performed if peak level lower than average limit. 2. Other frequency was 20dB below limit line within 1-18GHz, there is not show in the report.		

Mark	Frequency (MHz)	Reading Level (dBμV)	Factor (dB)	Measure Level (dBμV/m)	Limit (dBμV/m)	Margin (dB)	Detector	Polarization
*	8641.5	36.6	12.9	49.5	68.2	-18.7	Peak	Horizontal
*	10316.0	35.3	17.4	52.7	68.2	-15.5	Peak	Horizontal
	11183.0	36.3	17.6	53.9	74.0	-20.1	Peak	Horizontal
	12075.5	35.6	17.5	53.1	74.0	-20.9	Peak	Horizontal
*	8896.5	36.4	13.2	49.6	68.2	-18.6	Peak	Vertical
*	10392.5	35.8	17.4	53.2	68.2	-15.0	Peak	Vertical
	11582.5	36.0	17.7	53.7	74.0	-20.3	Peak	Vertical
	12449.5	35.5	17.2	52.7	74.0	-21.3	Peak	Vertical

Note 1: "*" is not in restricted band, its limit is -27dBm/MHz. At a distance of 3 meters, the field strength limit in dBμV/m can be determined by adding a "conversion" factor of 95.2dB to the EIRP limit of -27dBm/MHz to obtain the limit for out of band spurious emissions.

Note 2: Measure Level (dBμV/m) = Reading Level (dBμV) + Factor (dB)

Factor (dB) = Cable Loss (dB) + Antenna Factor (dB/m) - Pre_Amplifier Gain (dB)

Product	Inductrix FPV HD RTF	Temperature	26°C
Test Engineer	Bruce Wang	Relative Humidity	56%
Test Site	AC1	Test Date	2018/05/15
Test Mode:	802.11a	Test Channel:	48
Remark:	1. Average measurement was not performed if peak level lower than average limit. 2. Other frequency was 20dB below limit line within 1-18GHz, there is not show in the report.		

Mark	Frequency (MHz)	Reading Level (dBμV)	Factor (dB)	Measure Level (dBμV/m)	Limit (dBμV/m)	Margin (dB)	Detector	Polarization
*	8871.0	37.0	13.2	50.2	68.2	-18.0	Peak	Horizontal
*	9874.0	35.8	16.8	52.6	68.2	-15.6	Peak	Horizontal
	11412.5	35.9	17.7	53.6	74.0	-20.4	Peak	Horizontal
	12024.5	36.0	17.4	53.4	74.0	-20.6	Peak	Horizontal
*	8709.5	36.8	13.0	49.8	68.2	-18.4	Peak	Vertical
*	10477.5	37.3	17.4	54.7	68.2	-13.5	Peak	Vertical
	11336.0	35.8	17.6	53.4	74.0	-20.6	Peak	Vertical
	12262.5	35.2	17.4	52.6	74.0	-21.4	Peak	Vertical

Note 1: "*" is not in restricted band, its limit is -27dBm/MHz. At a distance of 3 meters, the field strength limit in dBμV/m can be determined by adding a "conversion" factor of 95.2dB to the EIRP limit of -27dBm/MHz to obtain the limit for out of band spurious emissions.

Note 2: Measure Level (dBμV/m) = Reading Level (dBμV) + Factor (dB)

Factor (dB) = Cable Loss (dB) + Antenna Factor (dB/m) - Pre_Amplifier Gain (dB)

Product	Inductrix FPV HD RTF	Temperature	26°C
Test Engineer	Bruce Wang	Relative Humidity	56%
Test Site	AC1	Test Date	2018/05/15
Test Mode:	802.11a	Test Channel:	149
Remark:	1. Average measurement was not performed if peak level lower than average limit. 2. Other frequency was 20dB below limit line within 1-18GHz, there is not show in the report.		

Mark	Frequency (MHz)	Reading Level (dBμV)	Factor (dB)	Measure Level (dBμV/m)	Limit (dBμV/m)	Margin (dB)	Detector	Polarization
*	8667.0	37.0	12.9	49.9	68.2	-18.3	Peak	Horizontal
*	9857.0	36.0	16.7	52.7	68.2	-15.5	Peak	Horizontal
	10809.0	35.7	18.0	53.7	74.0	-20.3	Peak	Horizontal
	12211.5	35.3	17.4	52.7	74.0	-21.3	Peak	Horizontal
*	8820.0	35.9	13.3	49.2	68.2	-19.0	Peak	Vertical
*	9840.0	35.1	16.7	51.8	68.2	-16.4	Peak	Vertical
	10792.0	35.9	18.0	53.9	74.0	-20.1	Peak	Vertical
	12101.0	35.6	17.5	53.1	74.0	-20.9	Peak	Vertical

Note 1: "*" is not in restricted band, its limit is -27dBm/MHz. At a distance of 3 meters, the field strength limit in dBμV/m can be determined by adding a "conversion" factor of 95.2dB to the EIRP limit of -27dBm/MHz to obtain the limit for out of band spurious emissions.

Note 2: Measure Level (dBμV/m) = Reading Level (dBμV) + Factor (dB)

Factor (dB) = Cable Loss (dB) + Antenna Factor (dB/m) - Pre_Amplifier Gain (dB)

Product	Inductrix FPV HD RTF	Temperature	26°C
Test Engineer	Bruce Wang	Relative Humidity	56%
Test Site	AC1	Test Date	2018/05/15
Test Mode:	802.11a	Test Channel:	157
Remark:	1. Average measurement was not performed if peak level lower than average limit. 2. Other frequency was 20dB below limit line within 1-18GHz, there is not show in the report.		

Mark	Frequency (MHz)	Reading Level (dBμV)	Factor (dB)	Measure Level (dBμV/m)	Limit (dBμV/m)	Margin (dB)	Detector	Polarization
*	8854.0	36.5	13.4	49.9	68.2	-18.3	Peak	Horizontal
*	10375.5	35.6	17.4	53.0	68.2	-15.2	Peak	Horizontal
	11582.5	37.2	17.7	54.9	74.0	-19.1	Peak	Horizontal
	12466.5	35.9	17.3	53.2	74.0	-20.8	Peak	Horizontal
*	8820.0	36.6	13.3	49.9	68.2	-18.3	Peak	Vertical
*	9942.0	35.3	16.8	52.1	68.2	-16.1	Peak	Vertical
	11565.5	40.5	17.8	58.3	74.0	-15.7	Peak	Vertical
	11569.0	27.6	17.8	45.4	54.0	-8.6	Average	Vertical
	12645.0	35.0	17.7	52.7	74.0	-21.3	Peak	Vertical

Note 1: "*" is not in restricted band, its limit is -27dBm/MHz. At a distance of 3 meters, the field strength limit in dBμV/m can be determined by adding a "conversion" factor of 95.2dB to the EIRP limit of -27dBm/MHz to obtain the limit for out of band spurious emissions.

Note 2: Measure Level (dBμV/m) = Reading Level (dBμV) + Factor (dB)

Factor (dB) = Cable Loss (dB) + Antenna Factor (dB/m) - Pre_Amplifier Gain (dB)

Product	Inductrix FPV HD RTF	Temperature	26°C
Test Engineer	Bruce Wang	Relative Humidity	56%
Test Site	AC1	Test Date	2018/05/15
Test Mode:	802.11a	Test Channel:	165
Remark:	1. Average measurement was not performed if peak level lower than average limit. 2. Other frequency was 20dB below limit line within 1-18GHz, there is not show in the report.		

Mark	Frequency (MHz)	Reading Level (dBμV)	Factor (dB)	Measure Level (dBμV/m)	Limit (dBμV/m)	Margin (dB)	Detector	Polarization
*	8828.5	36.1	13.3	49.4	68.2	-18.8	Peak	Horizontal
*	9950.5	35.3	16.7	52.0	68.2	-16.2	Peak	Horizontal
	10851.5	35.2	18.1	53.3	74.0	-20.7	Peak	Horizontal
	12169.0	35.6	17.5	53.1	74.0	-20.9	Peak	Horizontal
*	8828.5	36.2	13.3	49.5	68.2	-18.7	Peak	Vertical
*	10358.5	35.6	17.4	53.0	68.2	-15.2	Peak	Vertical
	11412.5	36.5	17.7	54.2	74.0	-19.8	Peak	Vertical
	12016.0	35.7	17.4	53.1	74.0	-20.9	Peak	Vertical

Note 1: "*" is not in restricted band, its limit is -27dBm/MHz. At a distance of 3 meters, the field strength limit in dBμV/m can be determined by adding a "conversion" factor of 95.2dB to the EIRP limit of -27dBm/MHz to obtain the limit for out of band spurious emissions.

Note 2: Measure Level (dBμV/m) = Reading Level (dBμV) + Factor (dB)

Factor (dB) = Cable Loss (dB) + Antenna Factor (dB/m) - Pre_Amplifier Gain (dB)

The worst case of Radiated Emission below 1GHz:

Site: AC1	Time: 2018/10/17 - 23:06
Limit: FCC_Part15.209_RE(3m)	Engineer: Snake Ni
Probe: VULB 9168_20-2000MHz	Polarity: Horizontal
EUT: Inductrix FPV HD RTF	Power: By Battery
Worse Case Mode: Transmit by 802.11a at Channel 5180MHz	

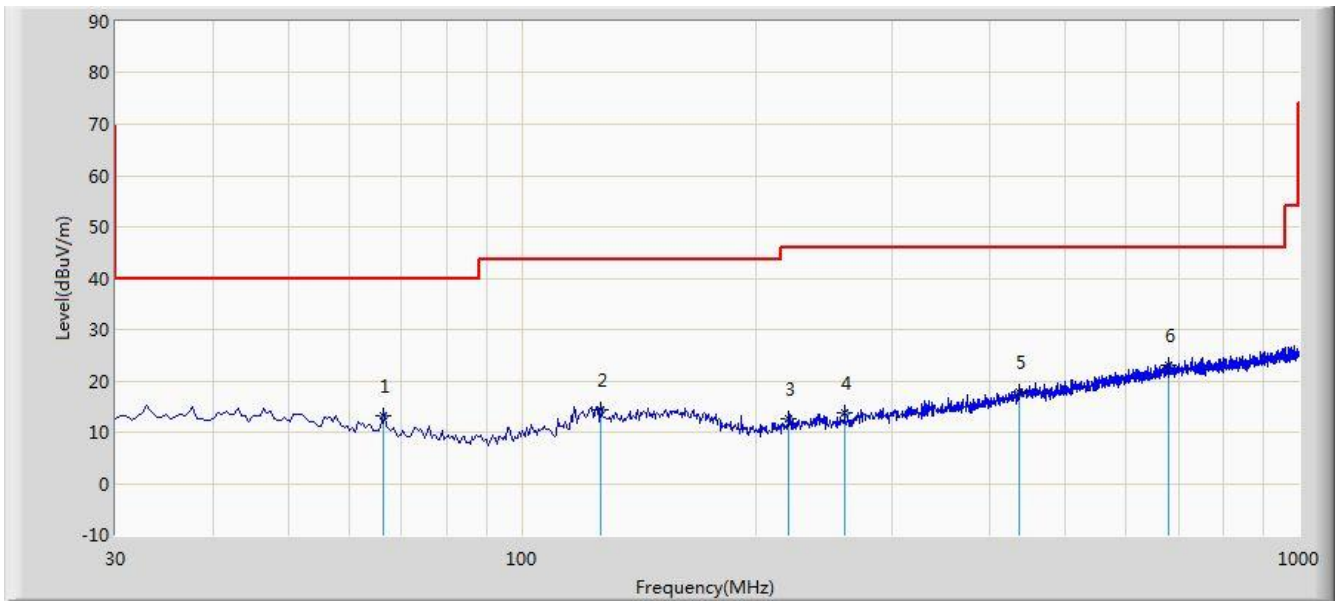

No	Flag	Mark	Frequency (MHz)	Measure Level (dBuV/m)	Reading Level (dBuV)	Over Limit (dB)	Limit (dBuV/m)	Factor (dB)	Type
1			66.375	13.111	0.840	-26.889	40.000	12.271	QP
2			126.515	14.469	0.840	-29.031	43.500	13.629	QP
3			220.605	12.573	0.530	-33.427	46.000	12.044	QP
4			260.375	13.766	0.500	-32.234	46.000	13.265	QP
5			436.430	17.829	0.260	-28.171	46.000	17.569	QP
6		*	681.355	23.140	1.270	-22.860	46.000	21.869	QP

Note 1: Measure Level (dB μ V/m) = Reading Level (dB μ V) + Factor (dB)

Factor (dB) = Cable Loss (dB) + Antenna Factor (dB/m)

Note 2: The test trace is same as the ambient noise and the amplitude of the emissions are attenuated more than 20dB below the permissible (the test frequency range: 9kHz ~ 30MHz, 18GHz ~ 40GHz), therefore no data appear in the report.

Site: AC1	Time: 2018/10/17 - 23:07
Limit: FCC_Part15.209_RE(3m)	Engineer: Snake Ni
Probe: VULB 9168_20-2000MHz	Polarity: Vertical
EUT: Inductrix FPV HD RTF	Power: By Battery
Worse Case Mode: Transmit by 802.11a at Channel 5180MHz	

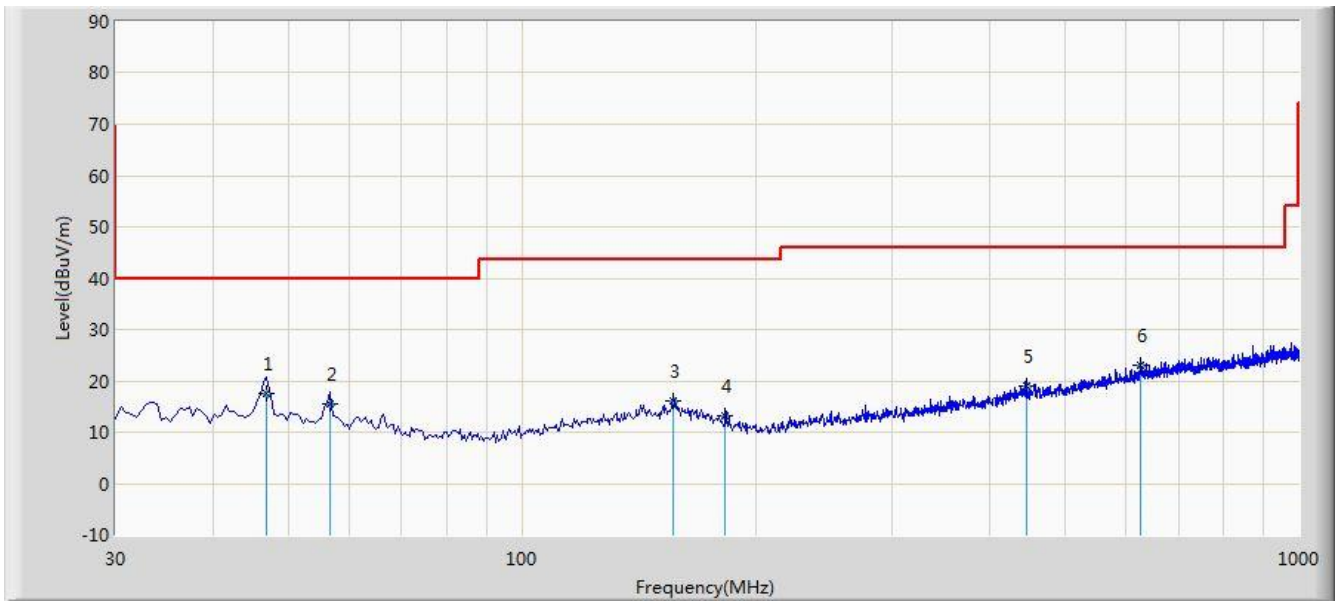

No	Flag	Mark	Frequency (MHz)	Measure Level (dBuV/m)	Reading Level (dBuV)	Over Limit (dB)	Limit (dBuV/m)	Factor (dB)	Type
1		*	46.975	17.603	3.360	-22.397	40.000	14.243	QP
2			56.675	15.504	1.800	-24.496	40.000	13.704	QP
3			156.585	15.956	0.660	-27.544	43.500	15.296	QP
4			182.775	13.105	0.520	-30.395	43.500	12.585	QP
5			445.645	19.039	1.230	-26.961	46.000	17.810	QP
6			625.095	23.161	2.060	-22.839	46.000	21.101	QP

Note 1: Measure Level (dB μ V/m) = Reading Level (dB μ V) + Factor (dB)

Factor (dB) = Cable Loss (dB) + Antenna Factor (dB/m)

Note 2: The test trace is same as the ambient noise and the amplitude of the emissions are attenuated more than 20dB below the permissible (the test frequency range: 9kHz ~ 30MHz, 18GHz ~ 40GHz), therefore no data appear in the report.

7.8. Radiated Restricted Band Edge Measurement

7.8.1. Test Limit

For 15.205 requirement:

Radiated emissions which fall in the restricted bands, as defined in Section 15.205(a) of FCC part 15, must also comply with the radiated emission limits specified in Section 15.209(a).

Frequency (MHz)	Frequency (MHz)	Frequency (MHz)	Frequency (GHz)
0.090 - 0.110	16.42 - 16.423	399.9 - 410	4.5 - 5.15
¹ 0.495 - 0.505	16.69475 - 16.69525	608 - 614	5.35 - 5.46
2.1735 - 2.1905	16.80425 - 16.80475	960 - 1240	7.25 - 7.75
4.125 - 4.128	25.5 - 25.67	1300 - 1427	8.25 - 8.5
4.17725 - 4.17775	37.5 - 38.25	1435 - 1626.5	9.0 - 9.2
4.20725 - 4.20775	73 - 74.6	1645.5 - 1646.5	9.3 - 9.5
6.215 - 6.218	74.8 - 75.2	1660 - 1710	10.6 - 12.7
6.26775 - 6.26825	108 - 121.94	1718.8 - 1722.2	13.25 - 13.4
6.31175 - 6.31225	123 - 138	2200 - 2300	14.47 - 14.5
8.291 - 8.294	149.9 - 150.05	2310 - 2390	15.35 - 16.2
8.362 - 8.366	156.52475 - 156.525	2483.5 - 2500	17.7 - 21.4
8.37625 - 8.38675	156.7 - 156.9	2690 - 2900	22.01 - 23.12
8.41425 - 8.41475	162.0125 - 167.17	3260 - 3267	23.6 - 24.0
12.29 - 12.293	167.72 - 173.2	3332 - 3339	31.2 - 31.8
12.51975 - 12.52025	240 - 285	3345.8 - 3358	36.43 - 36.5
12.57675 - 12.57725	322 - 335.4	3600 - 4400	(²)
13.36 - 13.41	--	--	--

For 15.407(b) requirement:

For transmitters operating in the 5.15-5.25 GHz band: All emissions outside of the 5.15-5.35 GHz band shall not exceed an e.i.r.p. of -27 dBm/MHz.

For transmitters operating in the 5.725-5.85 GHz band: All emissions shall be limited to a level of -27 dBm/MHz at 75 MHz or more above or below the band edge increasing linearly to 10 dBm/MHz at 25 MHz above or below the band edge, and from 25 MHz above or below the band edge increasing linearly to a level of 15.6 dBm/MHz at 5 MHz above or below the band edge, and from 5 MHz above or below the band edge increasing linearly to a level of 27 dBm/MHz at the band edge.

Refer to KDB 789033 D02v02r01 G)2)c), as specified in § 15.407(b), emissions above 1000 MHz that are outside of the restricted bands are subject to a maximum emission limit of -27 dBm/MHz (or -17 dBm/MHz as specified in § 15.407(b)(4)). However, an out-of-band emission that complies with both the peak and average limits of § 15.209 is not required to satisfy the -27 dBm/MHz or -17 dBm/MHz maximum emission limit.

All out of band emissions appearing in a restricted band as specified in Section 15.205 of the Title 47 CFR must not exceed the limits shown in Table per Section 15.209.

FCC Part 15 Subpart C Paragraph 15.209		
Frequency [MHz]	Field Strength [uV/m]	Measured Distance [Meters]
0.009 ~ 0.490	2400/F (kHz)	300
0.490 ~ 1.705	24000/F (kHz)	30
1.705 ~ 30	30	30
30 ~ 88	100	3
88 ~ 216	150	3
216 ~ 960	200	3
Above 960	500	3

For RSS-Gen Section 8.10 Requirement:

Radiated emissions which fall in the restricted bands, as defined in Section 8.10 of RSS-Gen, must also comply with the radiated emission limits specified in Section 8.9.

Frequency (MHz)	Frequency (MHz)	Frequency (MHz)
0.009 - 0.110	240 - 285	9.0 - 9.2
2.1735 - 2.1905	322 - 335.4	9.3 - 9.5
3.020 - 3.026	399.9 - 410	10.6 - 12.7
4.125 - 4.128	608 - 614	13.25 - 13.4
4.17725 - 4.17775	960 - 1427	14.47 - 14.5
4.20725 - 4.20775	1435 - 1626.5	15.35 - 16.2
5.677 - 5.683	1645.5 - 1646.5	17.7 - 21.4
6.215 - 6.218	1660 - 1710	22.01 - 23.12
6.26775 - 6.26825	1718.8 - 1722.2	23.6 - 24.0
6.31175 - 6.31225	2200 - 2300	31.2 - 31.8
8.291 - 8.294	2310 - 2390	36.43 - 36.5
8.362 - 8.366	2655 - 2900	Above 38.6
8.37625 - 8.38675	3260 - 3267	--
8.41425 - 8.41475	3332 - 3339	
12.29 - 12.293	334.5 - 3358	
12.51975 - 12.52025	3500 - 4400	
12.57675 - 12.57725	4500 - 5150	
13.36 - 13.41	5350 - 5460	
16.42 - 16.423	7250 - 7750	
16.69475 - 16.69525	8025 - 8500	
16.80425 - 16.80475	--	
25.5 - 25.67		
37.5 - 38.25		
73 - 74.6		
74.8 - 75.2		
108 - 138		
156.52475 - 156.525225		
156.7 - 156.9		

Note: *Certain frequency bands listed in Table 6 and in bands above 38.6 GHz are designated for licence-exempt applications. These frequency bands and the requirements that apply to the devices are set out in the 200- and 300-series of RSSs, such as RSS-210 and RSS-310, which contain the requirements that apply to licence-exempt radio apparatus.

For transmitters with operating frequencies in the band 5150-5250 MHz, all emissions outside the band 5150-5350 MHz shall not exceed -27 dBm/MHz e.i.r.p.

For transmitters operating in the band 5725-5850 MHz shall have e.i.r.p. of unwanted emissions comply with the following:

- a) 27 dBm/MHz at frequencies from the band edges decreasing linearly to 15.6 dBm/MHz at 5MHz above or below the band edges;
- b) 15.6 dBm/MHz at 5 MHz above or below the band edges decreasing linearly to 10 dBm/MHz at 25 MHz above or below the band edges;
- c) 10 dBm/MHz at 25 MHz above or below the band edges decreasing linearly to -27 dBm/MHz at 75 MHz above or below the band edges; and
- d) -27 dBm/MHz at frequencies more than 75 MHz above or below the band edges.

All out of band emissions appearing in a restricted band as specified in Section 8.10 of the RSS-Gen must not exceed the limits shown in Table per Section 8.9.

RSS-Gen Section 8.9		
Frequency [MHz]	Field Strength [uV/m]	Measured Distance [Meters]
0.009 ~ 0.490	2400/F (kHz)	300
0.490 ~ 1.705	24000/F (kHz)	30
1.705 ~ 30	30	30
30 ~ 88	100	3
88 ~ 216	150	3
216 ~ 960	200	3
Above 960	500	3

7.8.2. Test Procedure Used

ANSI C63.10 Section 6.6 (Standard test method above 1GHz)

7.8.3. Test Setting

Peak Measurements above 1GHz

1. Analyzer center frequency was set to the frequency of the radiated spurious emission of interest
2. RBW = 1MHz
3. VBW = 3MHz
4. Detector = peak
5. Sweep time = auto couple
6. Trace mode = max hold
7. Trace was allowed to stabilize

Average Measurements above 1GHz (Method VB)

1. Analyzer center frequency was set to the frequency of the radiated spurious emission of interest
2. RBW = 1MHz
3. VBW; If the EUT is configured to transmit with duty cycle $\geq 98\%$, set VBW = 10 Hz.
If the EUT duty cycle is $< 98\%$, set VBW $\geq 1/T$. T is the minimum transmission duration.
4. Detector = Peak
5. Sweep time = auto
6. Trace mode = max hold
7. Trace was allowed to stabilize

7.8.4. Test Setup

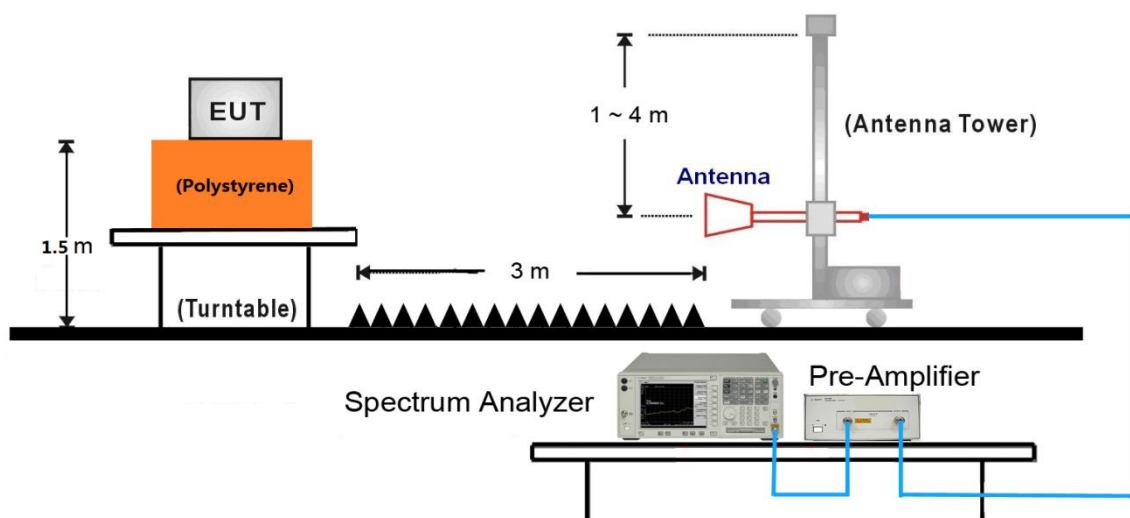

Note: This item was performed with the WIFI antenna connected.

7.8.5. Test Result

Site: AC1	Time: 2018/05/11 - 13:58
Limit: FCC_Part15.209_RE(3m)	Engineer: Bruce Wang
Probe: BBHA9120D_1-18GHz	Polarity: Horizontal
EUT: Inductrix FPV HD RTF	Power: By Battery
Test Mode: Transmit by 802.11a at Channel 5180MHz	

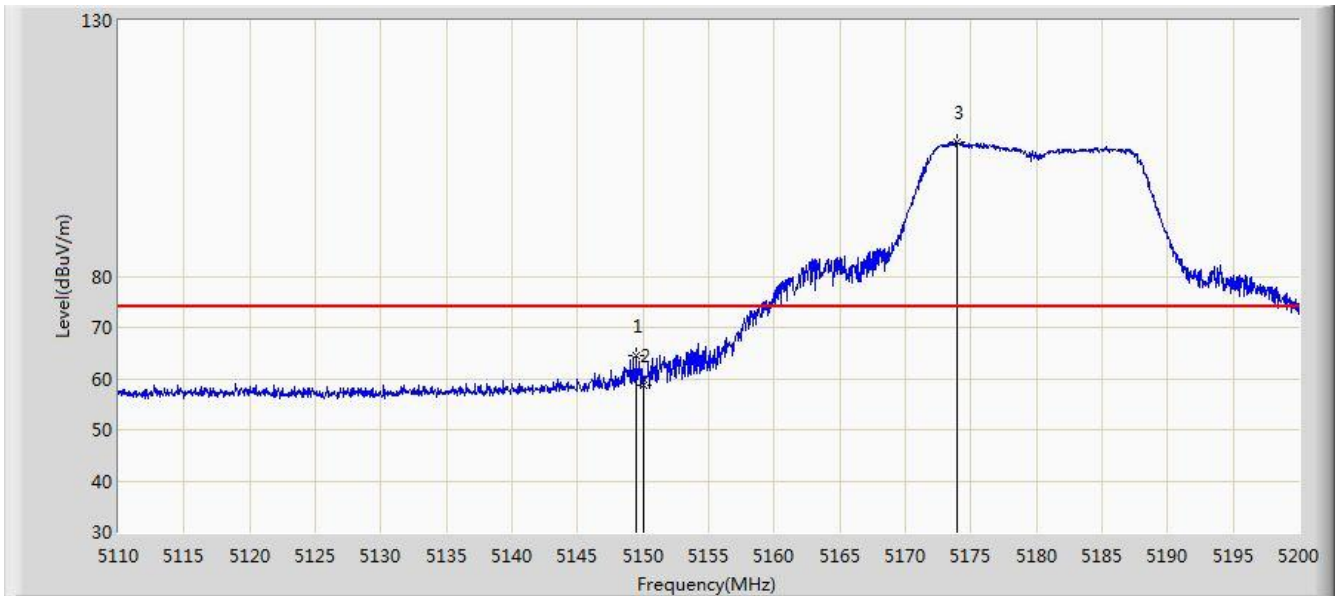

No	Flag	Mark	Frequency (MHz)	Measure Level (dBuV/m)	Reading Level (dBuV)	Over Limit (dB)	Limit (dBuV/m)	Factor (dB)	Type
1			5149.420	64.425	59.460	-9.575	74.000	4.965	PK
2			5150.000	58.658	53.690	-15.342	74.000	4.968	PK
3		*	5173.900	106.097	101.103	N/A	N/A	4.995	PK

Note: Measure Level (dB μ V/m) = Reading Level (dB μ V) + Factor (dB)

Factor (dB) = Cable Loss (dB) + Antenna Factor (dB/m) - Pre_Amplifier

Site: AC1	Time: 2018/05/11 - 14:00
Limit: FCC_Part15.209_RE(3m)	Engineer: Bruce Wang
Probe: BBHA9120D_1-18GHz	Polarity: Horizontal
EUT: Inductrix FPV HD RTF	Power: By Battery
Test Mode: Transmit by 802.11a at Channel 5180MHz	

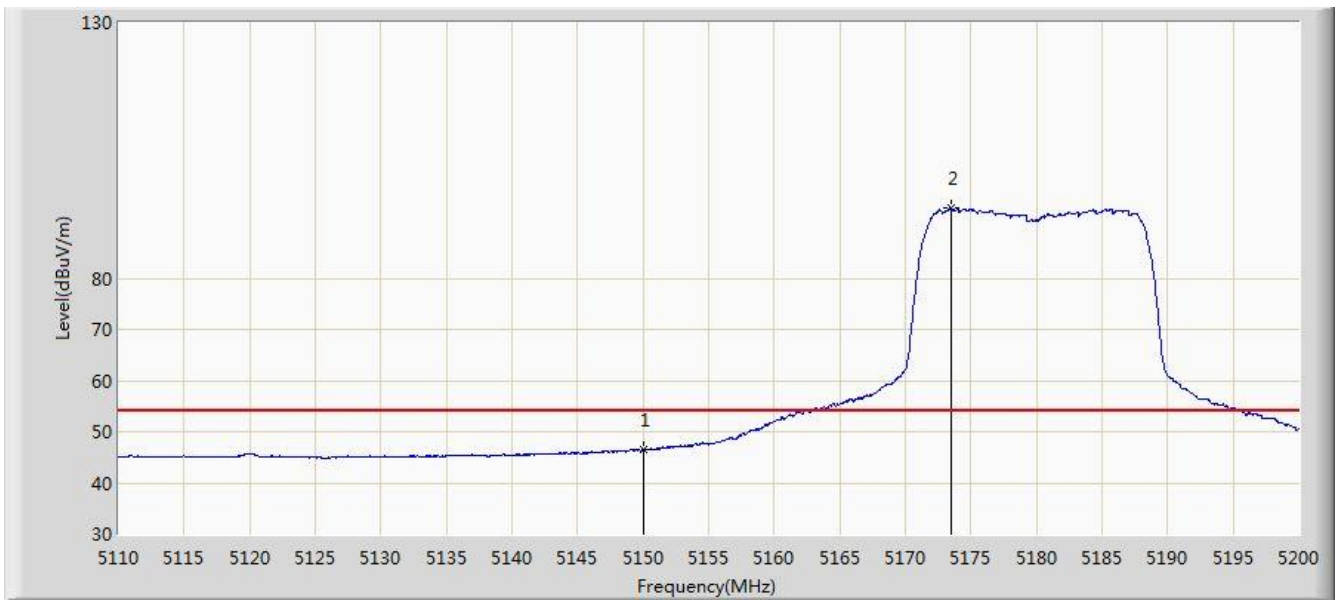

No	Flag	Mark	Frequency (MHz)	Measure Level (dBuV/m)	Reading Level (dBuV)	Over Limit (dB)	Limit (dBuV/m)	Factor (dB)	Type
1			5150.000	46.475	41.507	-7.525	54.000	4.968	AV
2		*	5173.450	93.671	88.675	N/A	N/A	4.997	AV

Note: Measure Level (dBuV/m) = Reading Level (dBuV) + Factor (dB)

Factor (dB) = Cable Loss (dB) + Antenna Factor (dB/m) - Pre_Amplifier

Site: AC1	Time: 2018/05/11 - 14:01
Limit: FCC_Part15.209_RE(3m)	Engineer: Bruce Wang
Probe: BBHA9120D_1-18GHz	Polarity: Vertical
EUT: Inductrix FPV HD RTF	Power: By Battery
Test Mode: Transmit by 802.11a at Channel 5180MHz	

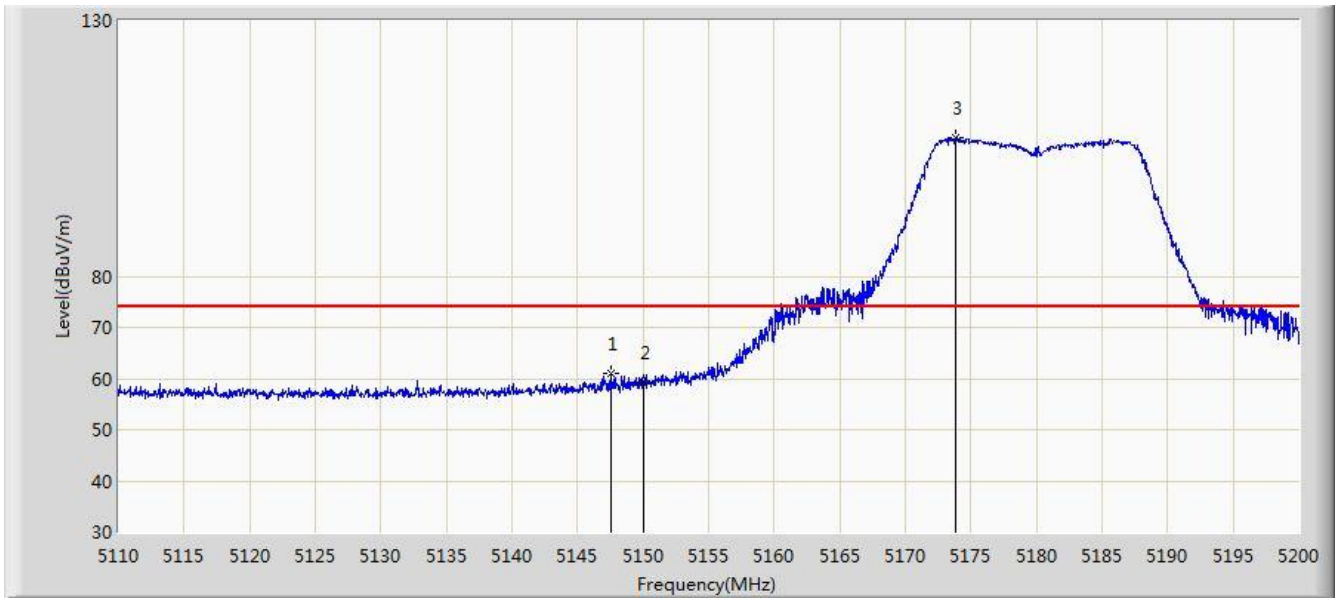

No	Flag	Mark	Frequency (MHz)	Measure Level (dBuV/m)	Reading Level (dBuV)	Over Limit (dB)	Limit (dBuV/m)	Factor (dB)	Type
1			5147.575	61.015	56.058	-12.985	74.000	4.956	PK
2			5150.000	59.307	54.339	-14.693	74.000	4.968	PK
3		*	5173.855	107.112	102.117	N/A	N/A	4.995	PK

Note: Measure Level (dB μ V/m) = Reading Level (dB μ V) + Factor (dB)

Factor (dB) = Cable Loss (dB) + Antenna Factor (dB/m) - Pre_Amplifier

Site: AC1	Time: 2018/05/11 - 14:03
Limit: FCC_Part15.209_RE(3m)	Engineer: Bruce Wang
Probe: BBHA9120D_1-18GHz	Polarity: Vertical
EUT: Inductrix FPV HD RTF	Power: By Battery
Test Mode: Transmit by 802.11a at Channel 5180MHz	

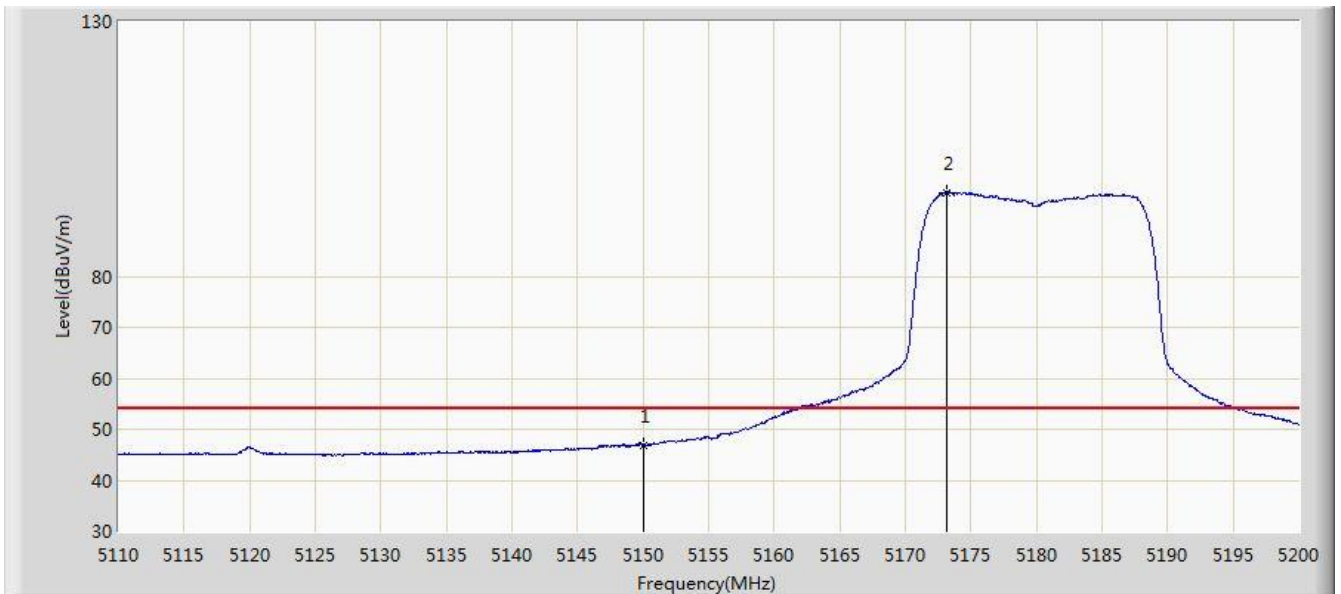

No	Flag	Mark	Frequency (MHz)	Measure Level (dBuV/m)	Reading Level (dBuV)	Over Limit (dB)	Limit (dBuV/m)	Factor (dB)	Type
1			5150.000	46.915	41.947	-7.085	54.000	4.968	AV
2		*	5173.180	96.502	91.505	N/A	N/A	4.998	AV

Note: Measure Level (dB μ V/m) = Reading Level (dB μ V) + Factor (dB)

Factor (dB) = Cable Loss (dB) + Antenna Factor (dB/m) - Pre_Amplifier

Site: AC1	Time: 2018/05/11 - 13:54
Limit: FCC_Part15.407_RE(3m)	Engineer: Bruce Wang
Probe: BBHA9120D_1-18GHz	Polarity: Horizontal
EUT: Inductrix FPV HD RTF	Power: By Battery
Test mode: Transmit by 802.11a at Channel 5745MHz	

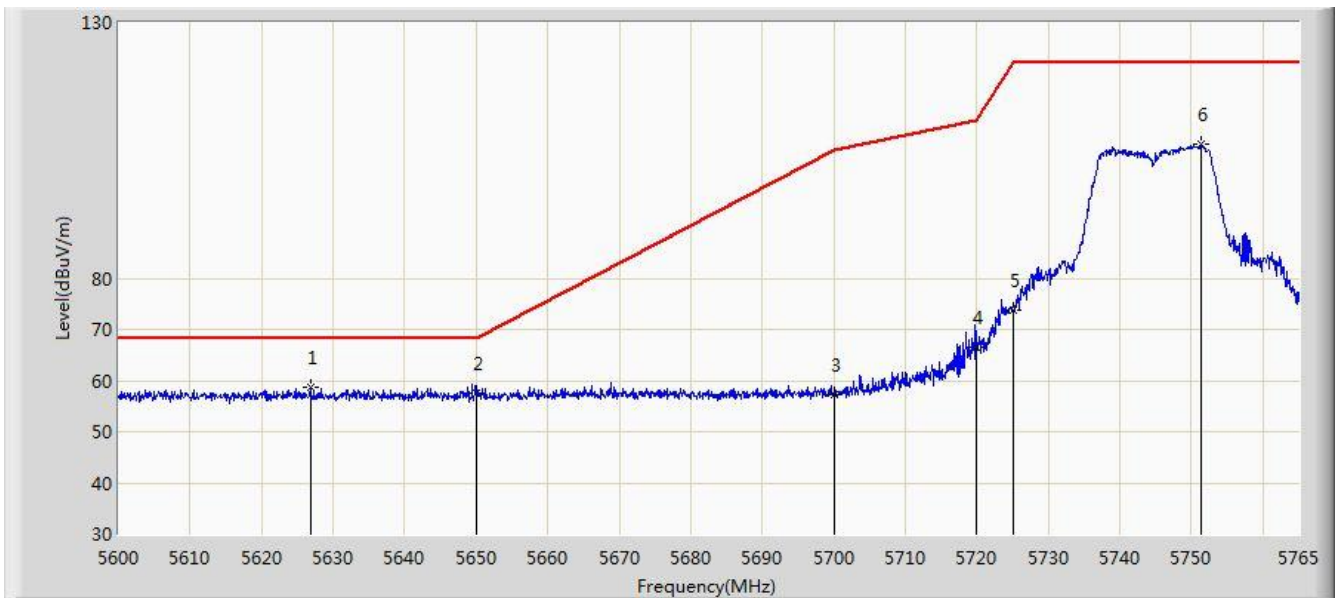

No	Flag	Mark	Frequency (MHz)	Measure Level (dBuV/m)	Reading Level (dBuV)	Over Limit (dB)	Limit (dBuV/m)	Factor (dB)	Type
1		*	5626.812	58.734	53.428	-9.466	68.200	5.306	PK
2			5650.000	57.610	52.231	-10.590	68.200	5.379	PK
3			5700.000	57.163	51.672	-48.037	105.200	5.490	PK
4			5720.000	66.447	60.881	-44.353	110.800	5.565	PK
5			5725.000	73.846	68.269	-48.354	122.200	5.577	PK
6			5751.388	106.115	100.476	N/A	N/A	5.639	PK

Note: Measure Level (dB μ V/m) = Reading Level (dB μ V) + Factor (dB)

Factor (dB) = Cable Loss (dB) + Antenna Factor (dB/m).

Site: AC1	Time: 2018/05/11 - 13:55
Limit: FCC_Part15.407_RE(3m)	Engineer: Bruce Wang
Probe: BBHA9120D_1-18GHz	Polarity: Vertical
EUT: Inductrix FPV HD RTF	Power: By Battery
Test mode: Transmit by 802.11a at Channel 5745MHz	

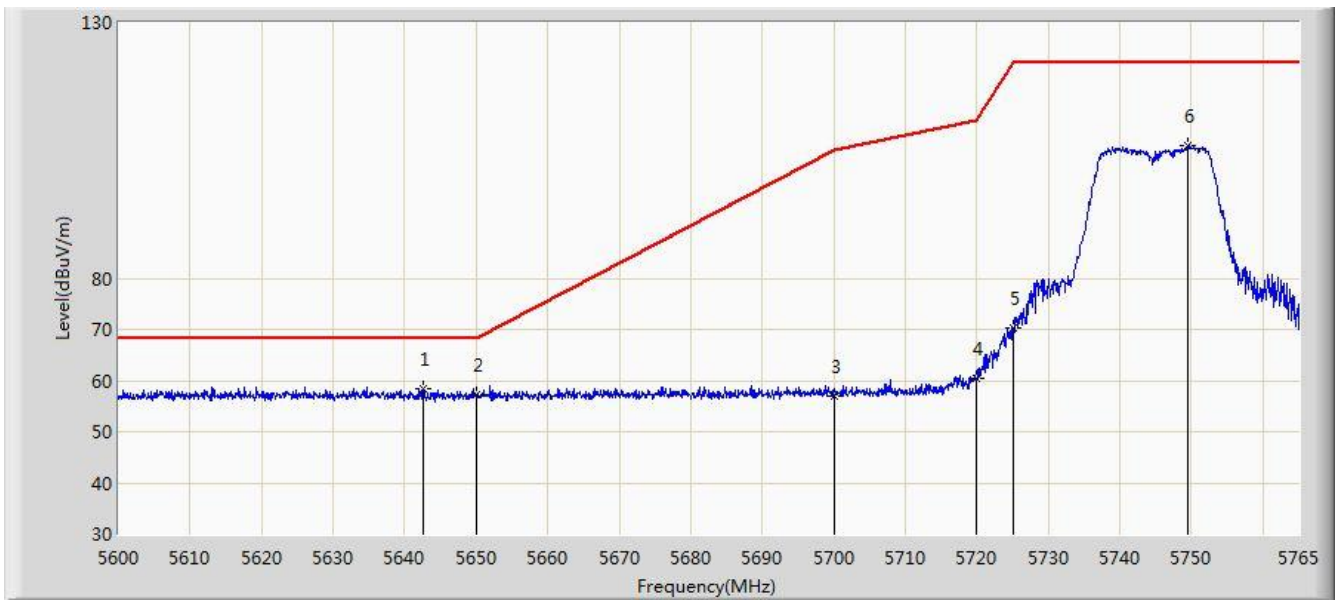

No	Flag	Mark	Frequency (MHz)	Measure Level (dBuV/m)	Reading Level (dBuV)	Over Limit (dB)	Limit (dBuV/m)	Factor (dB)	Type
1		*	5642.652	58.530	53.180	-9.670	68.200	5.351	PK
2			5650.000	57.191	51.812	-11.009	68.200	5.379	PK
3			5700.000	57.096	51.605	-48.104	105.200	5.490	PK
4			5720.000	60.438	54.872	-50.362	110.800	5.565	PK
5			5725.000	70.268	64.691	-51.932	122.200	5.577	PK
6			5749.408	105.894	100.259	N/A	N/A	5.634	PK

Note: Measure Level (dBuV/m) = Reading Level (dBuV) + Factor (dB)

Factor (dB) = Cable Loss (dB) + Antenna Factor (dB/m).

Site: AC1	Time: 2018/05/11 - 13:50
Limit: FCC_Part15.407_RE(3m)	Engineer: Bruce Wang
Probe: BBHA9120D_1-18GHz	Polarity: Horizontal
EUT: Inductrix FPV HD RTF	Power: By Battery
Test mode: Transmit by 802.11a at Channel 5825MHz	

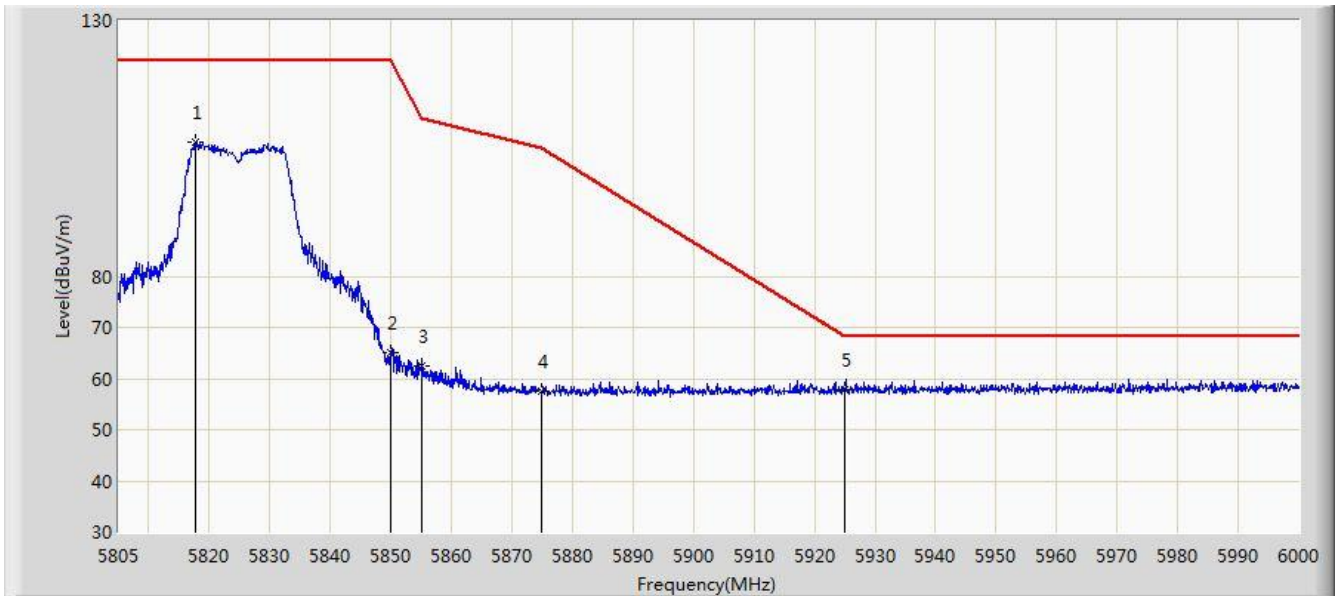

No	Flag	Mark	Frequency (MHz)	Measure Level (dBuV/m)	Reading Level (dBuV)	Over Limit (dB)	Limit (dBuV/m)	Factor (dB)	Type
1			5817.772	106.087	100.291	N/A	N/A	5.795	PK
2			5850.000	64.999	59.152	-57.201	122.200	5.848	PK
3			5855.000	62.583	56.739	-48.217	110.800	5.844	PK
4			5875.000	57.544	51.653	-47.656	105.200	5.891	PK
5		*	5925.000	57.943	51.895	-10.257	68.200	6.049	PK

Note: Measure Level (dB μ V/m) = Reading Level (dB μ V) + Factor (dB)

Factor (dB) = Cable Loss (dB) + Antenna Factor (dB/m).

Site: AC1	Time: 2018/05/11 - 13:51
Limit: FCC_Part15.407_RE(3m)	Engineer: Bruce Wang
Probe: BBHA9120D_1-18GHz	Polarity: Vertical
EUT: Inductrix FPV HD RTF	Power: By Battery
Test mode: Transmit by 802.11a at Channel 5825MHz	

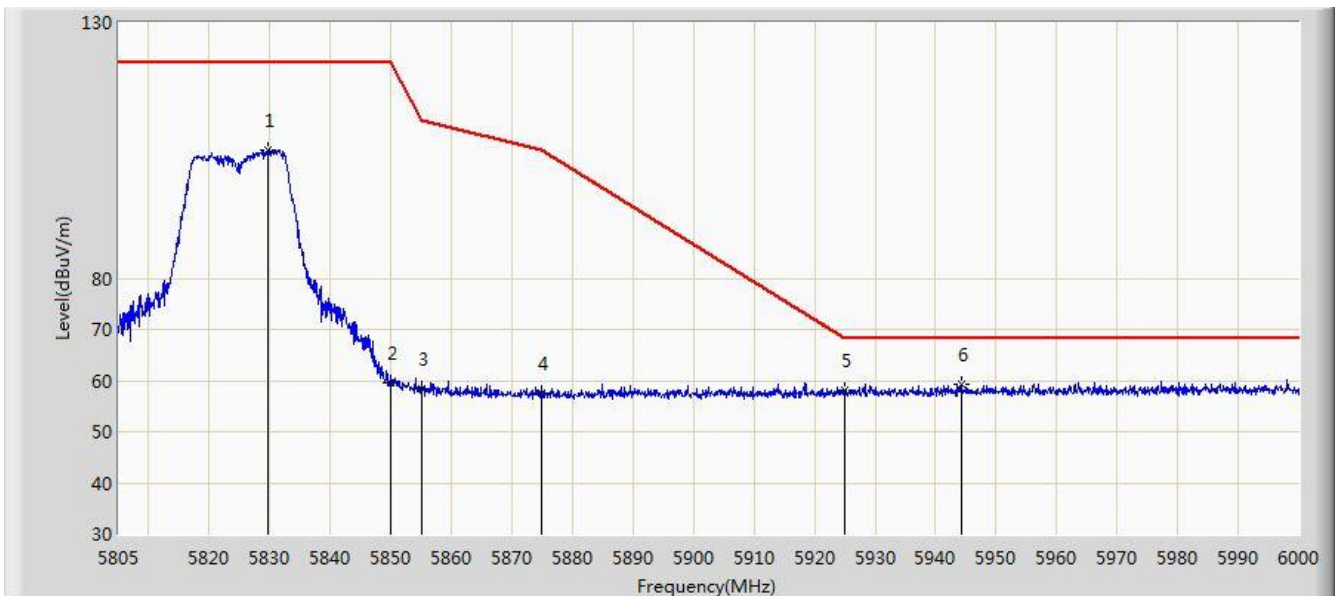

No	Flag	Mark	Frequency (MHz)	Measure Level (dBuV/m)	Reading Level (dBuV)	Over Limit (dB)	Limit (dBuV/m)	Factor (dB)	Type
1			5829.667	105.073	99.248	N/A	N/A	5.825	PK
2			5850.000	59.454	53.607	-62.746	122.200	5.848	PK
3			5855.000	58.470	52.626	-52.330	110.800	5.844	PK
4			5875.000	57.444	51.553	-47.756	105.200	5.891	PK
5			5925.000	58.001	51.953	-10.199	68.200	6.049	PK
6		*	5944.230	59.365	53.263	-8.835	68.200	6.103	PK

Note: Measure Level (dB μ V/m) = Reading Level (dB μ V) + Factor (dB)

Factor (dB) = Cable Loss (dB) + Antenna Factor (dB/m).

7.9. AC Conducted Emissions Measurement

7.9.1. Test Limit

FCC 15.207 Limits		
Frequency (MHz)	QP (dBuV)	AV (dBuV)
0.15 ~ 0.50	66 ~ 56	56 ~ 46
0.50 ~ 5.0	56	46
5.0 ~ 30	60	50

Note 1: The lower limit shall apply at the transition frequencies.

Note 2: The limit decreases linearly with the logarithm of the frequency in the range 0.15MHz to 0.5MHz.

7.9.2. Test Setup

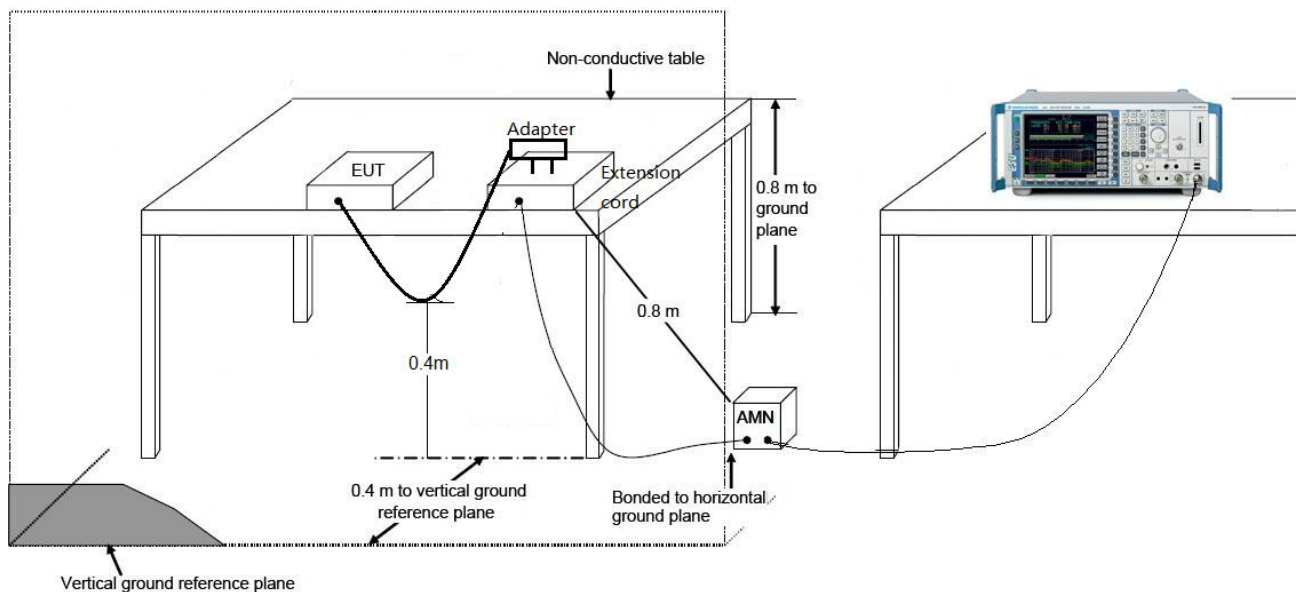

7.9.3. Test Result

The EUT is powered by battery, so this requirement does not apply.

8. CONCLUSION

The data collected relate only the item(s) tested and show that the **Inductrix FPV HD RTF** is in compliance with Part 15E of the FCC Rules and ISED Rules.

The End

Appendix A - Test Setup Photograph

Refer to "1803RSU014-UT" file.

Appendix B - EUT Photograph

Refer to "1803RSU014-UE" file.