

MEASUREMENT REPORT

FCC PART 15.247 / RSS-247 ZigBee

FCC ID: 2ACS5-YUNFBD
IC: 11554B-YUNFBD
APPLICANT: Yuneec Technology Co., Limited

Application Type: Certification
Product: Firebird FPV
Model No.: YUNFBD
Brand Name: YUNEEC
FCC Classification: Digital Transmission System (DTS)
FCC Rule Part(s): Part15 Subpart C (Section 15.247)
IC Rule(s): RSS-247 Issue 2, RSS-GEN Issue 4
Test Procedure(s): ANSI C63.10-2013, KDB 558074 D01v04
Test Date: October 25 ~ December 16, 2017

Reviewed By : Paddy Chen
(Paddy Chen)

Approved By : Chenz Ker
(Chenz Ker)



The test results relate only to the samples tested.

This equipment has been shown to be capable of compliance with the applicable technical standards as indicated in the measurement report and was tested in accordance with the measurement procedures specified in KDB 558074 D01v04. Test results reported herein relate only to the item(s) tested.

The test report shall not be reproduced except in full without the written approval of MRT Technology (Taiwan) Co., Ltd.

Revision History

Report No.	Version	Description	Issue Date	Note
1711TW0109-U1	Rev. 01	Initial Report	01-04-2018	Valid

CONTENTS

Description	Page
§2.1033 General Information	5
1. INTRODUCTION	6
1.1. Scope	6
1.2. MRT Test Location	6
2. PRODUCT INFORMATION	7
2.1. Equipment Description.....	7
2.2. Product Specification Subjective to this Report.....	7
2.3. Operation Frequency / Channel List	7
2.4. Description of Available Antennas	7
2.5. Test Mode	8
2.6. Test Software	8
2.7. Description of Antenna RF Port	8
2.8. Device Capabilities	9
2.9. Test Configuration	9
2.10. EMI Suppression Device(s)/Modifications.....	9
2.11. Labeling Requirements.....	10
3. DESCRIPTION OF TEST	11
3.1. Evaluation Procedure	11
3.2. AC Line Conducted Emissions	11
3.3. Radiated Emissions.....	12
4. ANTENNA REQUIREMENTS.....	13
5. TEST EQUIPMENT CALIBRATION DATE.....	14
6. MEASUREMENT UNCERTAINTY.....	15
7. TEST RESULT	16
7.1. Summary	16
7.2. 6dB Bandwidth Measurement.....	17
7.2.1. Test Limit	17
7.2.2. Test Procedure used.....	17
7.2.3. Test Setting.....	17
7.2.4. Test Setup.....	17
7.2.5. Test Result.....	18
7.3. Output Power Measurement.....	19
7.3.1. Test Limit	19

7.3.2.	Test Procedure Used	19
7.3.3.	Test Setting.....	19
7.3.4.	Test Setup.....	19
7.3.5.	Test Result of Output Power	20
7.4.	Power Spectral Density Measurement	21
7.4.1.	Test Limit	21
7.4.2.	Test Procedure Used	21
7.4.3.	Test Setting.....	21
7.4.4.	Test Setup.....	21
7.4.5.	Test Result.....	22
7.5.	Conducted Band Edge and Out-of-Band Emissions.....	23
7.5.1.	Test Limit	23
7.5.2.	Test Procedure Used	23
7.5.3.	Test Setting.....	23
7.5.4.	Test Setup.....	24
7.5.5.	Test Result.....	25
7.6.	Radiated Spurious Emission Measurement	27
7.6.1.	Test Limit	27
7.6.2.	Test Procedure Used	27
7.6.3.	Test Setting.....	27
7.6.4.	Test Setup.....	29
7.6.5.	Test Result.....	31
7.7.	Radiated Restricted Band Edge Measurement	36
7.7.1.	Test Limit	36
7.7.2.	Test Procedure Used	37
7.7.3.	Test Setting.....	37
7.7.4.	Test Setup.....	38
7.7.5.	Test Result.....	39
7.8.	AC Conducted Emissions Measurement.....	47
7.8.1.	Test Limit	47
7.8.2.	Test Setup.....	47
7.8.3.	Test Result.....	47
8.	CONCLUSION.....	48

§2.1033 General Information

Applicant:	Yuneecc Technology Co., Limited
Applicant Address:	2/F Man Shung Industrial Building, 7 Lai Yip Street, Kwun Tong, Hong Kong
Manufacturer:	Yuneecc International (China) Co., Ltd.
Manufacturer Address:	No.388 East Zhengwei Road, Jinxi Town, Kunshan, Jiangsu 215324, China
Test Site:	MRT Technology (Taiwan) Co., Ltd
Test Site Address:	No. 38, Fuxing Second Rd., Guishan Dist., Taoyuan City 333, Taiwan (R.O.C)
FCC Registration No.:	153292
IC Registration No.:	21723-1
Test Device Serial No.:	N/A <input type="checkbox"/> Production <input checked="" type="checkbox"/> Pre-Production <input type="checkbox"/> Engineering

Test Facility / Accreditations

Measurements were performed at MRT Laboratory located in Fuxing Rd., Taoyuan, Taiwan (R.O.C)

- MRT facility is a FCC registered (Reg. No. 153292) test facility with the site description report on file and is designated by the FCC as an Accredited Test Film.
- MRT facility is an IC registered (MRT Reg. No. 21723-1) test laboratory with the site description on file at Industry Canada.
- MRT Lab is accredited to ISO 17025 by the American Association for Laboratory Accreditation (TAF) under the American Association for Laboratory Accreditation Program (TAF Cert. No. 3261) in EMC, Telecommunications and Radio testing for FCC, Industry Taiwan, EU and TELEC Rules.

1. INTRODUCTION

1.1. Scope

Measurement and determination of electromagnetic emissions (EMC) of radio frequency devices including intentional and/or unintentional radiators for compliance with the technical rules and regulations of the Federal Communications Commission and the Industry Canada Certification and Engineering Bureau.

1.2. MRT Test Location

The map below shows the location of the MRT LABORATORY, its proximity to the Taoyuan City. These measurement tests were conducted at the MRT Technology (Taiwan) Co., Ltd. Facility located at No.38, Fuxing 2nd Rd., Guishan Dist., Taoyuan City 33377, Taiwan (R.O.C).

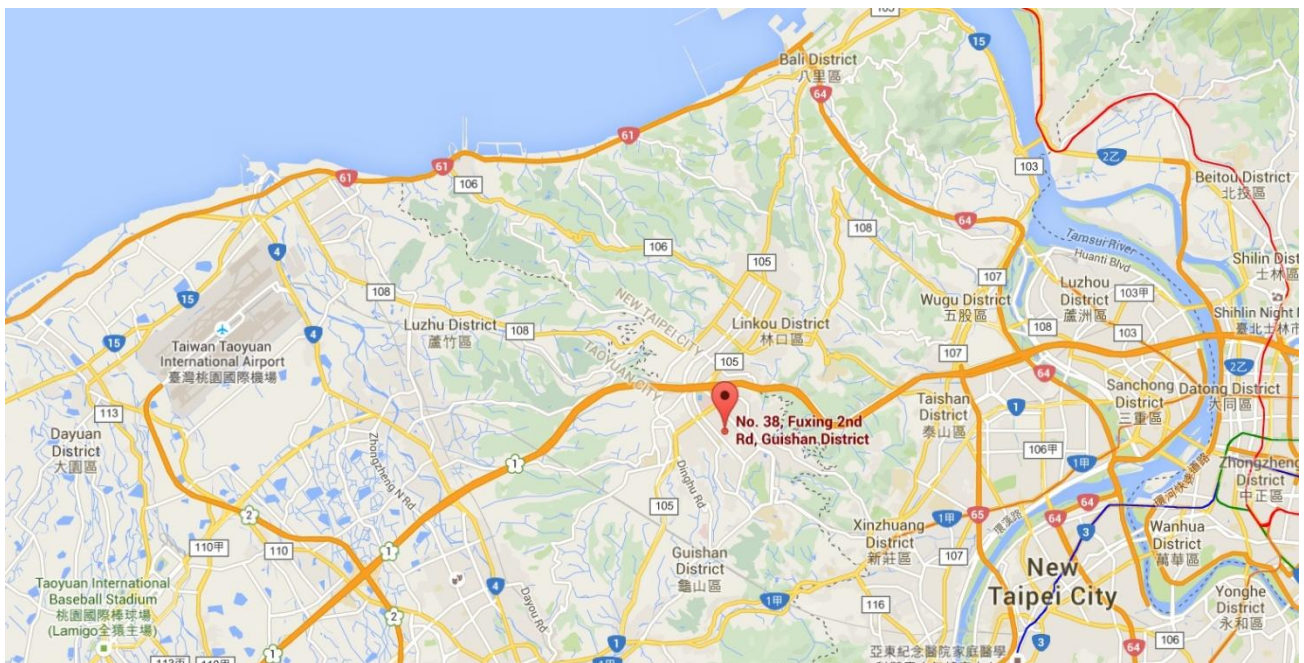

2. PRODUCT INFORMATION

2.1. Equipment Description

Product Name	Firebird FPV
Model No.	YUNFBD
Brand Name	YUNEEC
Wi-Fi Specification	802.11a/n-HT20
ZigBee Specification	802.15.4

2.2. Product Specification Subjective to this Report

Frequency Range	802.15.4: 2405 ~ 2475 MHz
Maximum Peak Output Power	17.94dBm
Type of Modulation	O-QPSK

Note: For other features of this EUT, test report will be issued separately.

2.3. Operation Frequency / Channel List

Channel	Frequency	Channel	Frequency	Channel	Frequency
11	2405 MHz	12	2410 MHz	13	2415 MHz
14	2420 MHz	15	2425 MHz	16	2430 MHz
17	2435 MHz	18	2440 MHz	19	2445 MHz
20	2450 MHz	21	2455 MHz	22	2460 MHz
23	2465 MHz	24	2470 MHz	25	2475 MHz

2.4. Description of Available Antennas

Antenna Type	Manufacturer	Frequency Band (MHz)	Max Peak Gain (dBi)
Omni-directional Antenna	Cortec Technology Inc.	2400 ~ 2483.5	1.5
Omni-directional Antenna	Yuneeec International (China) Co., Ltd.	5180 ~ 5240	3.0
		5745 ~ 5825	3.0

2.5. Test Mode

Test Mode	Mode 1: Transmit by 802.15.4
-----------	------------------------------

2.6. Test Software

The test utility software used during testing was engineering directive ordered by applicant.

2.7. Description of Antenna RF Port

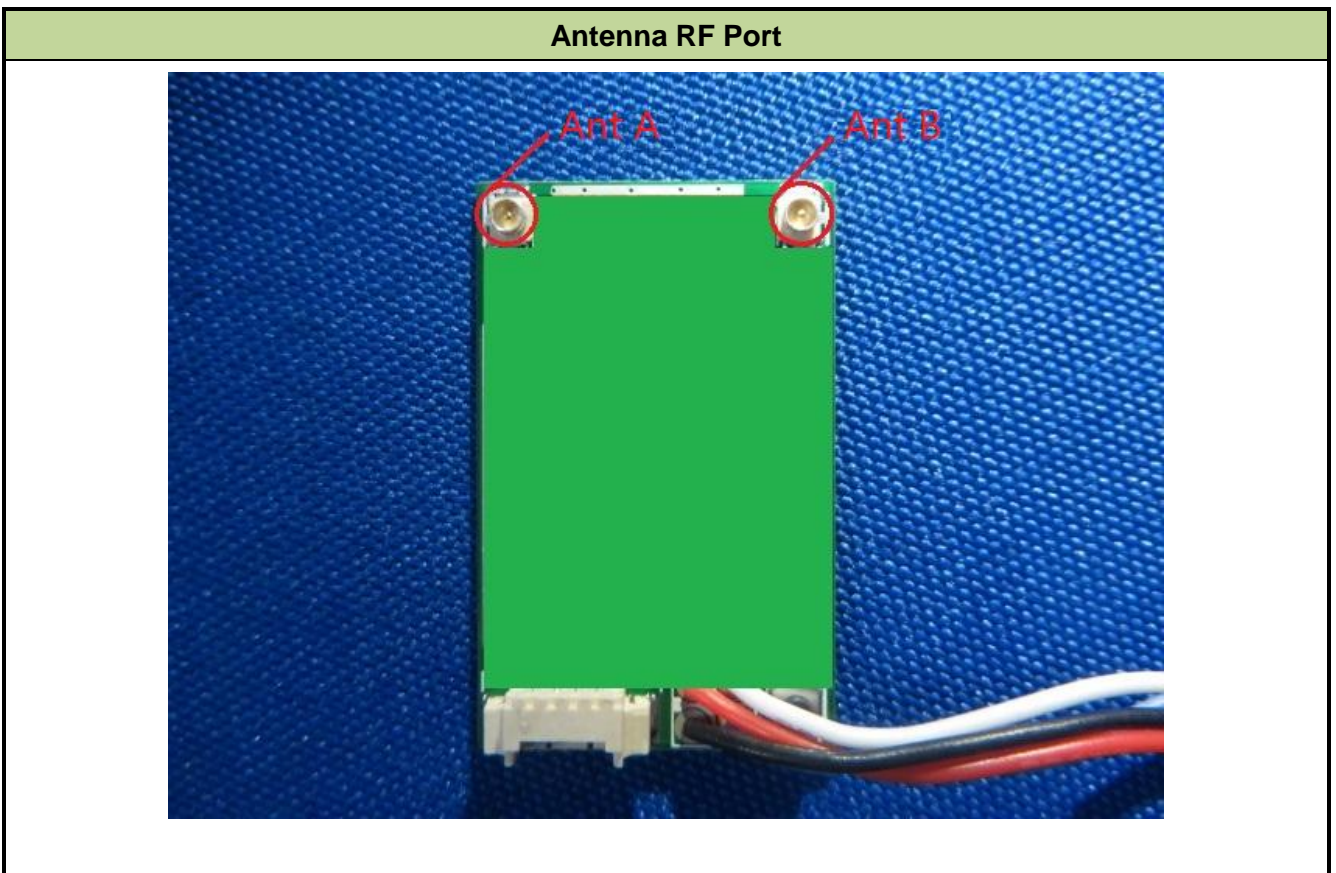

2.8. Device Capabilities

This device contains the following capabilities:

2.4GHz Wireless (DTS), 5GHz WLAN (NII)

Note: 2.4GHz ZigBee (DTS) operation is possible in 20MHz channel bandwidth. The maximum achievable duty cycle was determined based on measurements performed on a spectrum analyzer in zero-span mode with RBW = 8MHz, VBW = 50MHz. The RBW and VBW were both greater than 50/T, where T is the minimum transmission duration, and the number of sweep points across T was greater than 100. The duty cycles are as follows:

Test Mode	Duty Cycle
802.15.4	19.10%

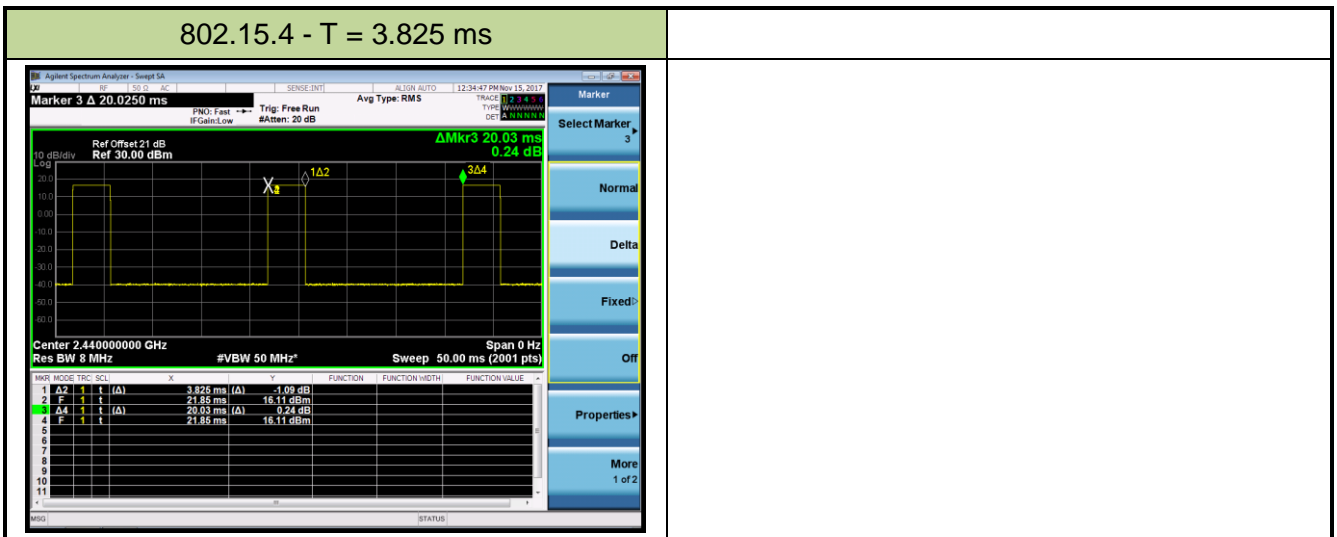

2.9. Test Configuration

The device was tested per the guidance of KDB 558074 D01v04. ANSI C63.10-2013 was used to reference the appropriate EUT setup for radiated spurious emissions testing and AC line conducted testing.

2.10. EMI Suppression Device(s)/Modifications

No EMI suppression device(s) were added and/or no modifications were made during testing.

2.11. Labeling Requirements

Per 2.1074 & 15.19; Docket 95-19

The label shall be permanently affixed at a conspicuous location on the device; instruction manual or pamphlet supplied to the user and be readily visible to the purchaser at the time of purchase.

However, when the device is so small wherein placement of the label with specified statement is not practical, only the FCC ID must be displayed on the device per Section 15.19(a)(5). Please see attachment for FCC ID label and label location.

3. DESCRIPTION OF TEST

3.1. Evaluation Procedure

The measurement procedures described in the American National Standard for Testing Unlicensed Wireless Devices (ANSI C63.10-2013), and the guidance provided in KDB 558074 D01v04 were used in the measurement.

Deviation from measurement procedure.....None

3.2. AC Line Conducted Emissions

The line-conducted facility is located inside an 8'x4'x4' shielded enclosure. A 1m x 2m wooden table 80cm high is placed 40cm away from the vertical wall and 80cm away from the sidewall of the shielded room. Two 10kHz-30MHz, 50Ω/50uH Line-Impedance Stabilization Networks (LISNs) are bonded to the shielded room floor. Power to the LISNs is filtered by external high-current high-insertion loss power line filters. These filters attenuate ambient signal noise from entering the measurement lines. These filters are also bonded to the shielded enclosure.

The EUT is powered from one LISN and the support equipment is powered from the second LISN. All interconnecting cables more than 1 meter were shortened to a 1 meter length by non-inductive bundling (serpentine fashion) and draped over the back edge of the test table. All cables were at least 40cm above the horizontal reference ground-plane. Power cables for support equipment were routed down to the second LISN while ensuring that that cables were not draped over the second LISN.

Sufficient time for the EUT, support equipment, and test equipment was allowed in order for them to warm up to their normal operating condition. The RF output of the LISN was connected to the receiver and exploratory measurements were made to determine the frequencies producing the maximum emission from the EUT. The receiver was scanned from 150kHz to 30MHz. The detector function was set to peak mode for exploratory measurements while the bandwidth of the analyzer was set to 9kHz. The EUT, support equipment, and interconnecting cables were arranged and manipulated to maximize each emission. Each emission was also maximized by varying: power lines, the mode of operation or data exchange speed, or support equipment whichever determined the worst-case emission. Once the worst case emissions have been identified, the one EUT cable configuration/arrangement and mode of operation that produced these emissions are used for final measurements on the same test site. The analyzer is set to CISPR quasi-peak and average detectors with a 9kHz resolution bandwidth for final measurements.

An extension cord was used to connect to a single LISN which powered by EUT. The extension cord was calibrated with LISN, the impedance and insertion loss are compliance with the requirements as stated in ANSI C63.10-2013.

3.3. Radiated Emissions

The radiated test facilities consisted of an indoor 3 meter semi-anechoic chamber used for final measurements and exploratory measurements, when necessary. The measurement area is contained within the semi-anechoic chamber which is shielded from any ambient interference. For measurements above 1GHz absorbers are arranged on the floor between the turn table and the antenna mast in such a way so as to maximize the reduction of reflections. For measurements below 1GHz, the absorbers are removed. A MF Model 210SS turntable is used for radiated measurement. It is a continuously rotatable, remote controlled, metallic turntable and 2 meters (6.56 ft.) in diameter. The turn table is flush with the raised floor of the chamber in order to maintain its function as a ground plane. An 80cm high PVC support structure is placed on top of the turntable.

For all measurements, the spectrum was scanned through all EUT azimuths and from 1 to 4 meter receive antenna height using a broadband antenna from 30MHz up to the upper frequency shown in 15.33(b)(1) depending on the highest frequency generated or used in the device or on which the device operates or tunes. For frequencies above 1GHz, linearly polarized double ridge horn antennas were used. For frequencies below 30MHz, a calibrated loop antenna was used. When exploratory measurements were necessary, they were performed at 1 meter test distance inside the semi-anechoic chamber using broadband antennas, broadband amplifiers, and spectrum analyzers to determine the frequencies and modes producing the maximum emissions. Sufficient time for the EUT, support equipment, and test equipment was allowed in order for them to warm up to their normal operating condition. The test set-up for frequencies below 1GHz was placed on top of the 0.8 meter high, 1 x 1.5 meter table; and test set-up for frequencies 1-25GHz was placed on top of the 1.5 meter high, 1 x 1.5 meter table. The EUT, support equipment, and interconnecting cables were arranged and manipulated to maximize each emission. Appropriate precaution was taken to ensure that all emissions from the EUT were maximized and investigated. The system configuration, clock speed, mode of operation or video resolution, if applicable, turntable azimuth, and receive antenna height was noted for each frequency found.

Final measurements were made in the semi-anechoic chamber using calibrated, linearly polarized broadband and horn antennas. The test setup was configured to the setup that produced the worst case emissions. The spectrum analyzer was set to investigate all frequencies required for testing to compare the highest radiated disturbances with respect to the specified limits. The turntable containing the EUT was rotated through 360 degrees and the height of the receive antenna was varied 1 to 4 meters and stopped at the azimuth and height producing the maximum emission. Each emission was maximized by changing the orientation of the EUT through three orthogonal planes and changing the polarity of the receive antenna, whichever produced the worst-case emissions. According to 3dB Beam-Width of horn antenna, the horn antenna should be always directed to the EUT when rising height.

4. ANTENNA REQUIREMENTS

Excerpt from §15.203 of the FCC Rules/Regulations:

“An intentional radiator antenna shall be designed to ensure that no antenna other than that furnished by the responsible party can be used with the device. The use of a permanently attached antenna or of an antenna that uses a unique coupling to the intentional radiator shall be considered sufficient to comply with the provisions of this section.”

- The antenna of the **Firebird FPV** is **permanently attached**.
- There are no provisions for connection to an external antenna.

Conclusion:

The unit complies with the requirement of §15.203.

5. TEST EQUIPMENT CALIBRATION DATE

Conducted Emissions - SR2

Instrument	Manufacturer	Type No.	Asset No.	Cali. Interval	Cali. Due Date
EMI Test Receiver	R&S	ESR3	MRTTWA00045	1 year	2018/03/17
Two-Line V-Network	R&S	ENV216	MRTTWA00019	1 year	2018/03/23
Two-Line V-Network	R&S	ENV216	MRTTWA00020	1 year	2018/03/23
Temperature/Humidity Meter	TFA	35.1078.10.IT	MRTTWA00033	1 year	2018/06/08

Radiated Emissions - AC1

Instrument	Manufacturer	Type No.	Asset No.	Cali. Interval	Cali. Due Date
Signal Analyzer	R&S	FSV40	MRTTWA00007	1 year	2018/03/02
EMI Test Receiver	R&S	ESR3	MRTTWA00009	1 year	2018/03/16
Broadband Preamplifier	SCHWARZBECK	BBV 9718	MRTTWA00005	1 year	2018/04/06
Broadband Amplifier	SCHWARZBECK	BBV 9721	MRTTWA00006	1 year	2018/04/06
Active Loop Antenna	SCHWARZBECK	FMZB 1519B	MRTTWA00002	1 year	2018/04/06
Broadband TRILOG Antenna	SCHWARZBECK	VULB 9162	MRTTWA00001	1 year	2018/04/06
Broadband Hornantenna	SCHWARZBECK	BBHA 9120D	MRTTWA00003	1 year	2018/04/06
Breitband Hornantenna	SCHWARZBECK	BBHA 9170	MRTTWA00004	1 year	2018/04/06
Temperature/Humidity Meter	TFA	35.1078.10.IT	MRTTWA00033	1 year	2018/06/08

Conducted Test Equipment - SR1

Instrument	Manufacturer	Type No.	Asset No.	Cali. Interval	Cali. Due Date
EXA Signal Analyzer	KEYSIGHT	N9010A	MRTTWA00012	1 year	2018/07/10
X-Series USB Peak and Average Power Sensor	KEYSIGHT	U2021XA	MRTTWA00014	1 year	2018/03/18
X-Series USB Peak and Average Power Sensor	KEYSIGHT	U2021XA	MRTTWA00015	1 year	2018/03/18
Programmable Temperature & Humidity Chamber	TEN BILLION	TTH-B3UP	MRTTWA00036	1 year	2018/05/11
Temperature/Humidity Meter	TFA	35.1078.10.IT	MRTTWA00033	1 year	2018/06/08

Software	Version	Function
e3	V8.3.5	EMI Test Software

6. MEASUREMENT UNCERTAINTY

Where relevant, the following test uncertainty levels have been estimated for tests performed on the EUT as specified in CISPR 16-4-2. This uncertainty represents an expanded uncertainty expressed at approximately the 95% confidence level using a coverage factor of $k = 2$.

AC Conducted Emission Measurement - SR1
Measuring Uncertainty for a Level of Confidence of 95% ($U=2Uc(y)$): 150kHz~30MHz: 3.46dB
Radiated Emission Measurement - AC1
Measuring Uncertainty for a Level of Confidence of 95% ($U=2Uc(y)$): 9kHz ~ 1GHz: 4.18dB 1GHz ~ 25GHz: 4.76dB

7. TEST RESULT

7.1. Summary

Company Name: Yuneec Technology Co., Limited
FCC ID: 2ACS5-YUNFBD
IC: 11554B-YUNFBD

FCC Part Section(s)	RSS Section(s)	Test Description	Test Limit	Test Condition	Test Result	Reference
15.247(a)(2)	RSS-247 [5.2]	6dB Bandwidth	$\geq 500\text{kHz}$	Conducted	Pass	Section 7.2
15.247(b)(3)	RSS-247 [5.4(4)]	Output Power	$\leq 1\text{Watt} \ \& \ \text{EIRP} \leq 4\text{Watt}$		Pass	Section 7.3
15.247(e)	RSS-247 [5.2]	Power Spectral Density	$\leq 8\text{dBm} / 3\text{kHz Band}$		Pass	Section 7.4
15.247(d)	RSS-247 [5.5]	Band Edge / Out-of-Band Emissions	$\geq 20\text{dBc(Peak)}$		Pass	Section 7.5
15.205 15.209	RSS-247 [5.5]	General Field Strength Limits (Restricted Bands and Radiated Emission Limits)	Emissions in restricted bands must meet the radiated limits detailed in 15.209	Radiated	Pass	Section 7.6 & 7.7
15.207	RSS-Gen [8.8]	AC Conducted Emissions 150kHz - 30MHz	< FCC 15.207 limits	Line Conducted	N/A	Section 7.8

Notes:

- 1) All modes of operation and data rates were investigated. The test results shown in the following sections represent the worst case emissions.
- 2) The analyzer plots shown in this section were all taken with a correction table loaded into the analyzer. The correction table was used to account for the losses of the cables and attenuators used as part of the system to connect the EUT to the analyzer at all frequencies of interest.

7.2. 6dB Bandwidth Measurement

7.2.1. Test Limit

The minimum 6dB bandwidth shall be at least 500 kHz.

7.2.2. Test Procedure used

KDB 558074 D01v04 - Section 8.2 Option 2

7.2.3. Test Setting

1. The Spectrum's automatic bandwidth measurement capability was used to perform the 6dB bandwidth measurement. The "X" dB bandwidth parameter was set to $X = 6$. The bandwidth measurement was not influenced by any intermediate power nulls in the fundamental emission.
2. Set RBW = 100 kHz
3. VBW $\geq 3 \times$ RBW
4. Detector = Peak
5. Trace mode = max hold
6. Sweep = auto couple
7. Allow the trace was allowed to stabilize

7.2.4. Test Setup

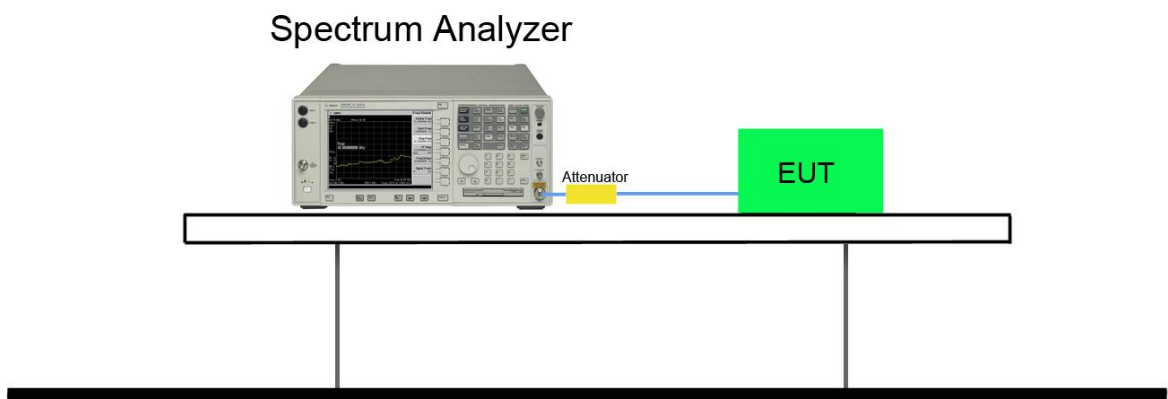

7.2.5. Test Result

Product	Firebird FPV	Temperature	24°C
Test Engineer	Kevin Ker	Relative Humidity	59%
Test Site	SR1	Test Date	2017/11/15

Test Mode	Modulation Mode	Channel No.	Frequency (MHz)	6dB Bandwidth (MHz)	Limit (MHz)	Result
802.15.4	O-QPSK	11	2405	1.63	≥ 0.5	Pass
802.15.4	O-QPSK	18	2440	1.62	≥ 0.5	Pass
802.15.4	O-QPSK	25	2475	1.58	≥ 0.5	Pass

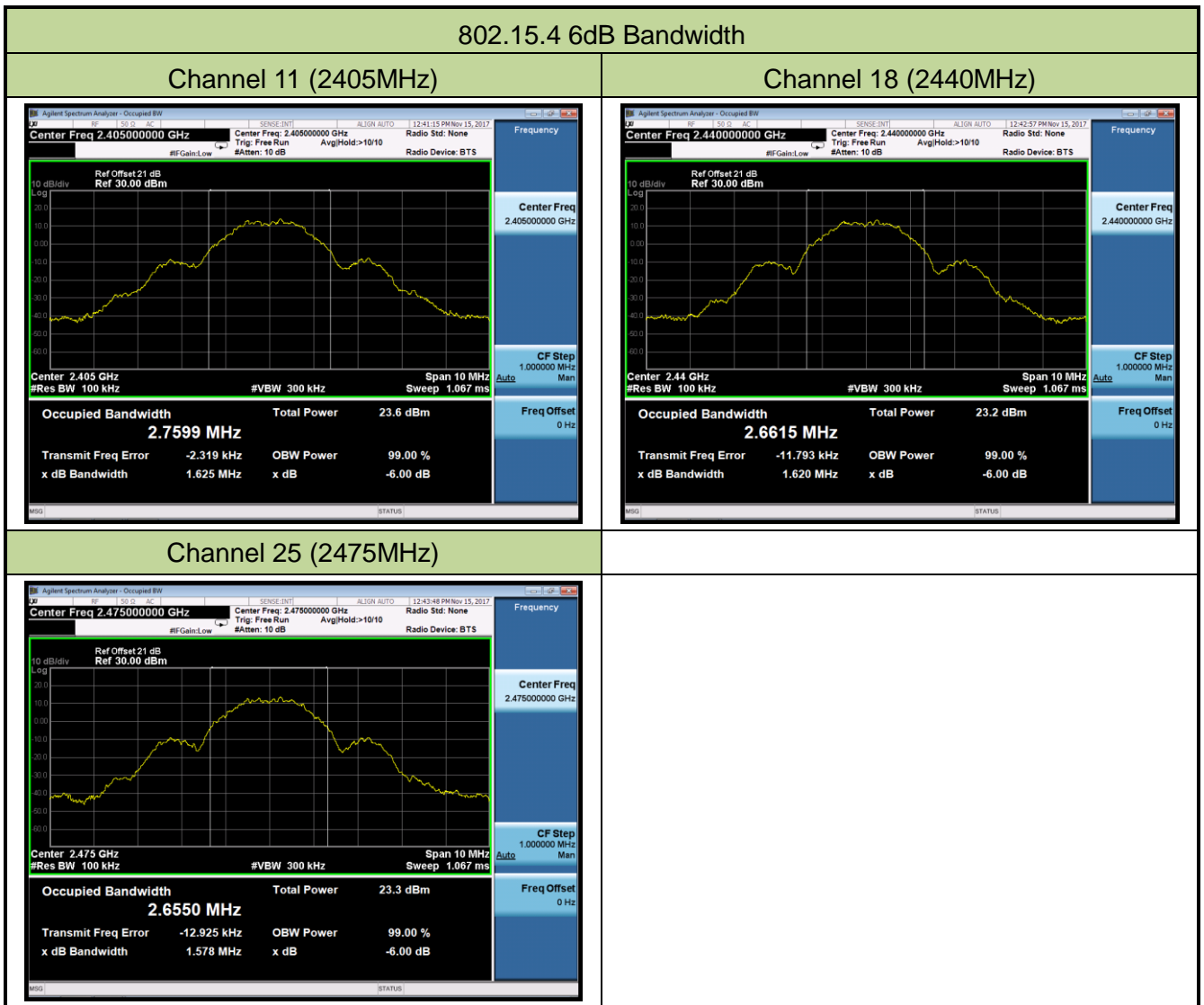

7.3. Output Power Measurement

7.3.1. Test Limit

The maximum output power shall be less 1 Watt (30dBm).

7.3.2. Test Procedure Used

KDB 558074 D01v04 - Section 9.1.3 PKPM1 Peak-reading power meter method

KDB 558074 D01v04 - Section 9.2.3.2 Method AVGPM-G

7.3.3. Test Setting

Method PKPM1 (Peak Power Measurement)

Peak power measurements were performed only when the EUT was transmitting at its maximum power control level using a broadband power meter with a pulse sensor. The pulse sensor employs a VBW = 50MHz so this method was only used for signals whose DTS bandwidth was less than or equal to 50MHz.

Method AVGPM-G (Measurement using a gated RF average-reading power meter)

Measurements may be performed using a wideband gated RF power meter provided that the gate parameters are adjusted such that the power is measured only when the EUT is transmitting at its maximum power control level. Since this measurement is made only during the ON time of the transmitter, no duty cycle correction is required.

7.3.4. Test Setup

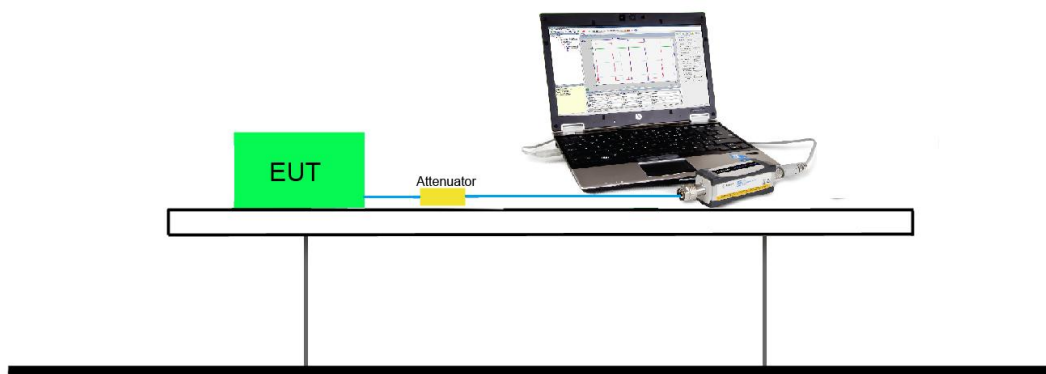

7.3.5. Test Result of Output Power

Product	Firebird FPV	Temperature	24°C
Test Engineer	Kevin Ker	Relative Humidity	59%
Test Site	SR1	Test Date	2017/11/15
Test Item	FCC & IC Output Power		

Ant A

Test Mode	Modulation Type	Channel No.	Frequency (MHz)	Output Power (dBm)	Limit (dBm)	E.I.R.P (dBm)	Limit (dBm)	Result
Peak Output Power								
802.15.4	O-QPSK	11	2405	17.94	≤ 30	19.44	≤ 36	Pass
802.15.4	O-QPSK	18	2440	17.56	≤ 30	19.06	≤ 36	Pass
802.15.4	O-QPSK	25	2475	17.55	≤ 30	19.05	≤ 36	Pass
Average Output Power								
802.15.4	O-QPSK	11	2405	17.77	≤ 30	19.27	≤ 36	Pass
802.15.4	O-QPSK	18	2440	17.31	≤ 30	18.81	≤ 36	Pass
802.15.4	O-QPSK	25	2475	17.32	≤ 30	18.82	≤ 36	Pass

Note: E.I.R.P (dBm) = Average Output Power (dBm) + Antenna Gain (dBi).

Ant B

Test Mode	Modulation Type	Channel No.	Frequency (MHz)	Output Power (dBm)	Limit (dBm)	E.I.R.P (dBm)	Limit (dBm)	Result
Peak Output Power								
802.15.4	O-QPSK	11	2405	17.91	≤ 30	19.41	≤ 36	Pass
802.15.4	O-QPSK	18	2440	17.52	≤ 30	19.02	≤ 36	Pass
802.15.4	O-QPSK	25	2475	17.48	≤ 30	18.98	≤ 36	Pass
Average Output Power								
802.15.4	O-QPSK	11	2405	17.74	≤ 30	19.24	≤ 36	Pass
802.15.4	O-QPSK	18	2440	17.30	≤ 30	18.80	≤ 36	Pass
802.15.4	O-QPSK	25	2475	17.28	≤ 30	18.78	≤ 36	Pass

Note: E.I.R.P (dBm) = Average Output Power (dBm) + Antenna Gain (dBi).

7.4. Power Spectral Density Measurement

7.4.1. Test Limit

The maximum permissible power spectral density is 8dBm in any 3 kHz band.

7.4.2. Test Procedure Used

KDB 558074 D01v04 - Section 10.2 Method PKPSD

7.4.3. Test Setting

1. Analyzer was set to the center frequency of the DTS channel under investigation
2. Span = 1.5 times the DTS channel bandwidth
3. RBW = 3kHz
4. VBW = 10kHz
5. Detector = peak
6. Sweep time = auto couple
7. Trace mode = max hold
8. Trace was allowed to stabilize

7.4.4. Test Setup

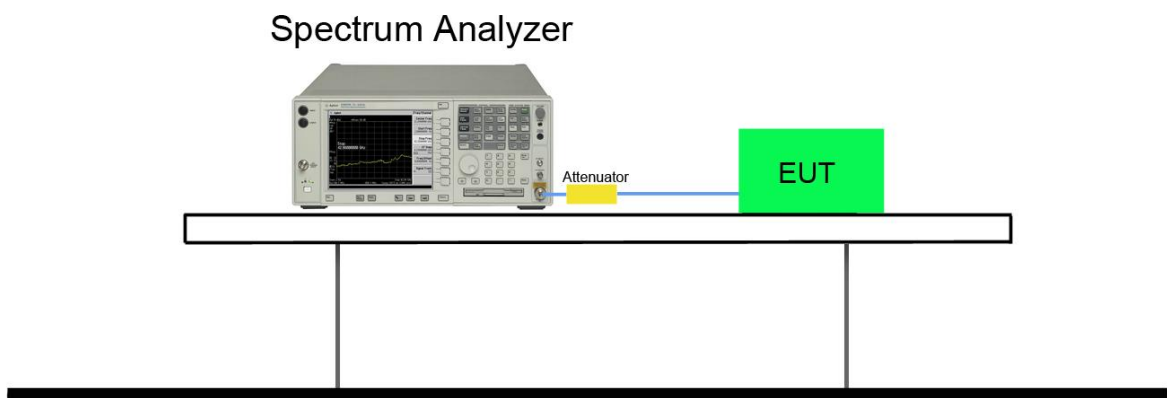

7.4.5. Test Result

Product	Firebird FPV	Temperature	24°C
Test Engineer	Kevin Ker	Relative Humidity	59%
Test Site	SR1	Test Date	2017/11/15

Test Mode	Modulation Mode	Channel No.	Frequency (MHz)	Measured PSD (dBm / 3kHz)	Limit (dBm / 3kHz)	Result
802.15.4	O-QPSK	11	2405	6.78	≤ 8	Pass
802.15.4	O-QPSK	18	2440	5.25	≤ 8	Pass
802.15.4	O-QPSK	25	2475	6.32	≤ 8	Pass

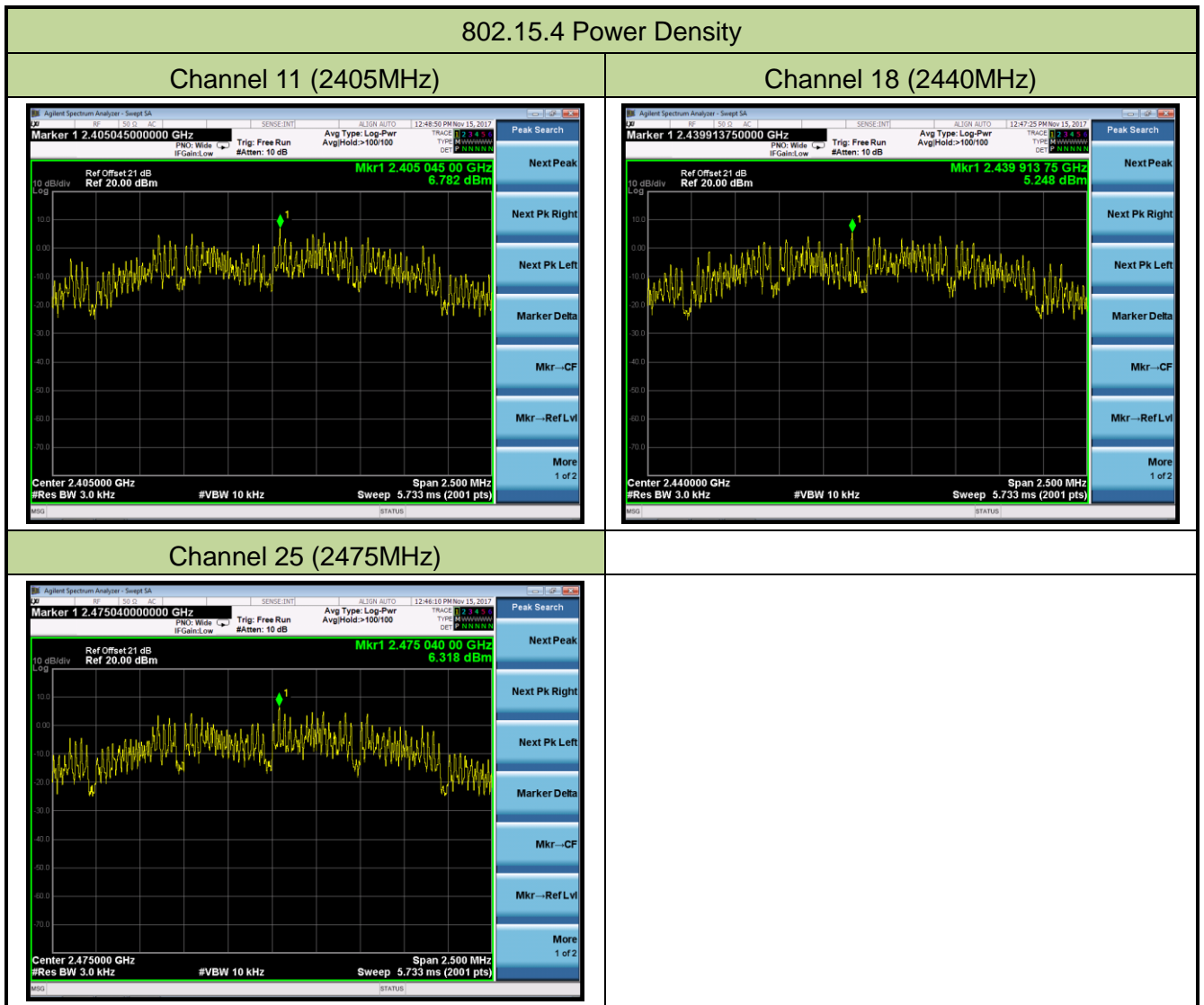

7.5. Conducted Band Edge and Out-of-Band Emissions

7.5.1. Test Limit

The limit for out-of-band spurious emissions at the band edge is 20dB below the fundamental emission level, as determined from the in-band power measurement of the DTS channel performed in a 100 kHz bandwidth per the PSD procedure.

7.5.2. Test Procedure Used

KDB 558074 D01v04 - Section 11.2 & Section 11.3

7.5.3. Test Setting

1. Reference level measurement

- (a) Set instrument center frequency to DTS channel center frequency
- (b) Set the span to ≥ 1.5 times the DTS bandwidth
- (c) Set the RBW = 100 kHz
- (d) Set the VBW $\geq 3 \times$ RBW
- (e) Detector = peak
- (f) Sweep time = auto couple
- (g) Trace mode = max hold
- (h) Allow trace to fully stabilize

2. Emission level measurement

- (a) Set the center frequency and span to encompass frequency range to be measured
- (b) RBW = 100kHz
- (c) VBW = 300kHz
- (d) Detector = Peak
- (e) Trace mode = max hold
- (f) Sweep time = auto couple
- (g) The trace was allowed to stabilize

7.5.4. Test Setup

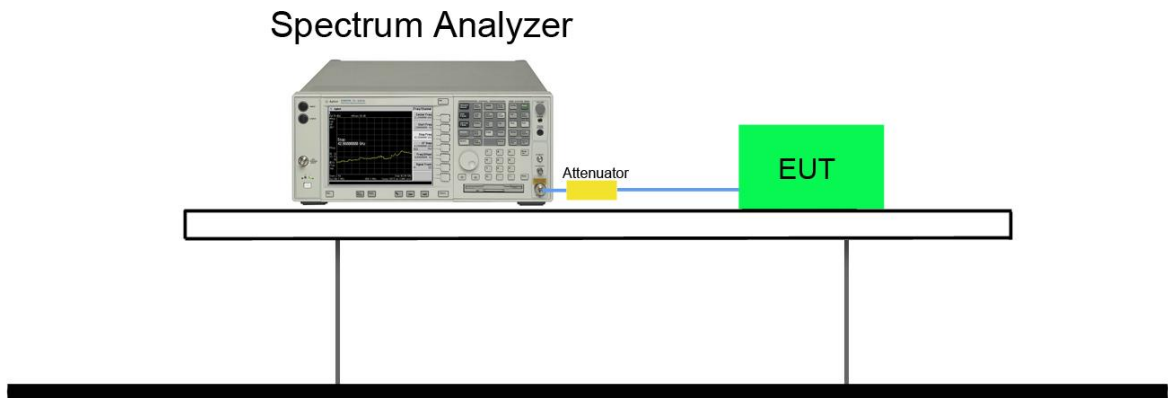

7.5.5. Test Result

Product	Firebird FPV	Temperature	24°C
Test Engineer	Kevin Ker	Relative Humidity	59%
Test Site	SR1	Test Date	2017/11/15

Test Mode	Modulation Mode	Channel No.	Frequency (MHz)	Limit	Result
802.15.4	O-QPSK	11	2405	20dBc	Pass
802.15.4	O-QPSK	18	2440	20dBc	Pass
802.15.4	O-QPSK	25	2475	20dBc	Pass

802.15.4 Out-of-Band Emissions
Channel 11 (2405MHz)

100kHz PSD reference Level	Low Band Edge
Spurious Emission	

Channel 18 (2440MHz)

100kHz PSD reference Level

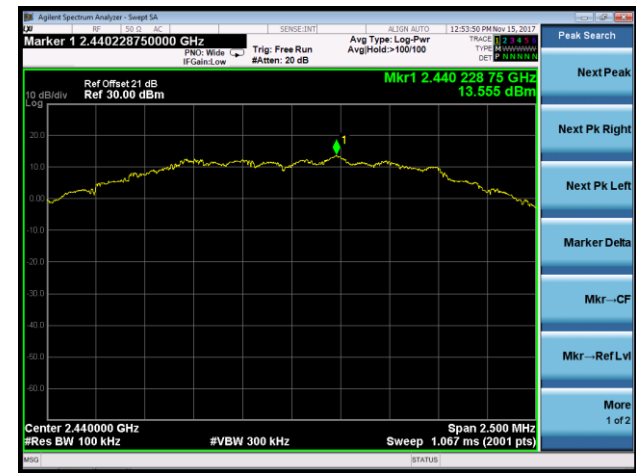

Spurious Emission

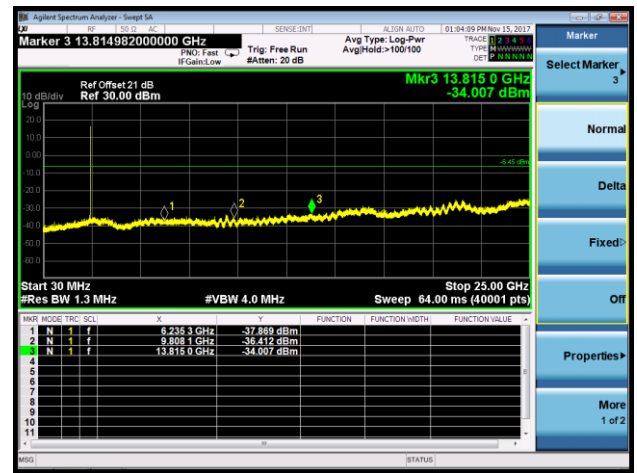

Channel 25 (2475MHz)

100kHz PSD reference Level

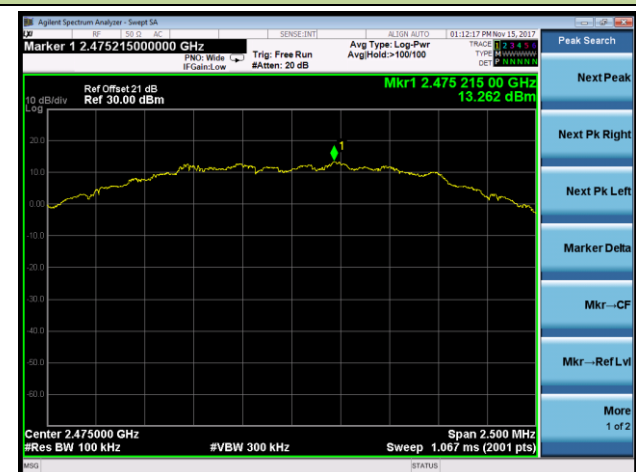

High Band Edge

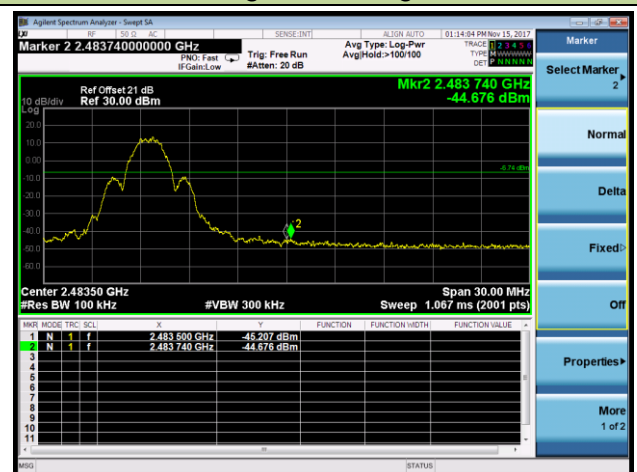

Spurious Emission

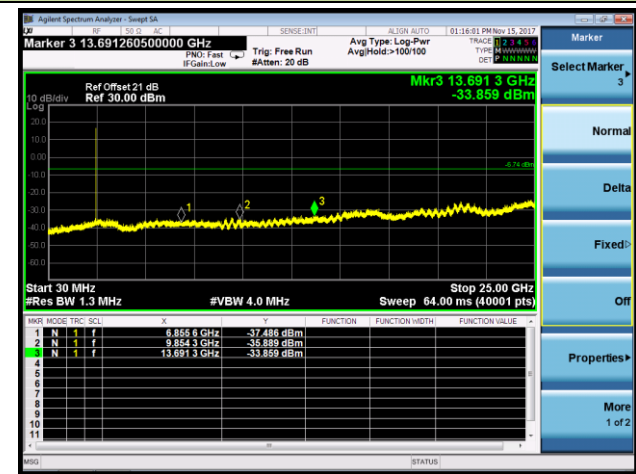

7.6. Radiated Spurious Emission Measurement

7.6.1. Test Limit

All out of band emissions appearing in a restricted band as specified in Section 15.205 of the Title 47 CFR must not exceed the limits shown in Table per Section 15.209.

FCC Part 15 Subpart C Paragraph 15.209		
Frequency [MHz]	Field Strength [V/m]	Measured Distance [Meters]
0.009 - 0.490	2400/F (kHz)	300
0.490 - 1.705	24000/F (kHz)	30
1.705 - 30	30	30
30 - 88	100	3
88 - 216	150	3
216 - 960	200	3
Above 960	500	3

7.6.2. Test Procedure Used

ANSI C63.10 Section 6.3 (General Requirements)

ANSI C63.10 Section 6.4 (Standard test method below 30MHz)

ANSI C63.10 Section 6.5 (Standard test method above 30MHz to 1GHz)

ANSI C63.10 Section 6.6 (Standard test method above 1GHz)

7.6.3. Test Setting

Peak Field Strength Measurements

1. Analyzer center frequency was set to the frequency of the radiated spurious emission of interest
2. RBW = as specified in Table 1
3. VBW = 3MHz
4. Detector = peak
5. Sweep time = auto couple
6. Trace mode = max hold
7. Trace was allowed to stabilize

Table 1 - RBW as a function of frequency	
Frequency	RBW
9 ~ 150 kHz	200 ~ 300 Hz
0.15 ~ 30 MHz	9 ~ 10 kHz
30 ~ 1000 MHz	100 ~ 120 kHz
> 1000 MHz	1 MHz

Average Field Strength Measurements

1. Analyzer center frequency was set to the frequency of the radiated spurious emission of interest
2. RBW = 1MHz
3. VBW \geq 1/T
4. De As an alternative, the instrument may be set to linear detector mode. Ensure that video filtering is applied in linear voltage domain (rather than in a log or dB domain). Some instruments require linear display mode in order to accomplish this. Others have a setting for Average-VBW Type, which can be set to "Voltage" regardless of the display mode
5. Detector = Peak
6. Sweep time = auto
7. Trace mode = max hold
8. Allow max hold to run for at least 50 times (1/duty cycle) traces

7.6.4. Test Setup

9kHz ~ 30MHz Test Setup:

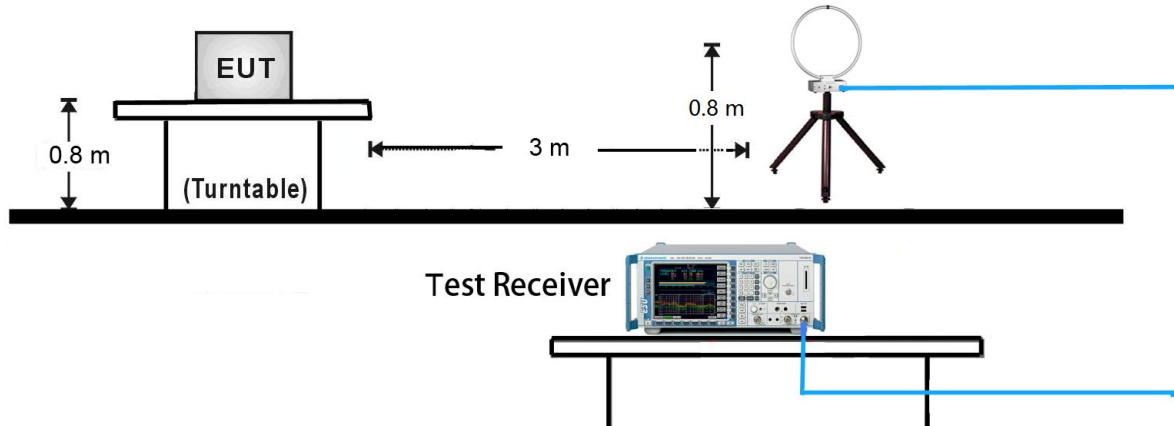

30MHz ~ 1GHz Test Setup:

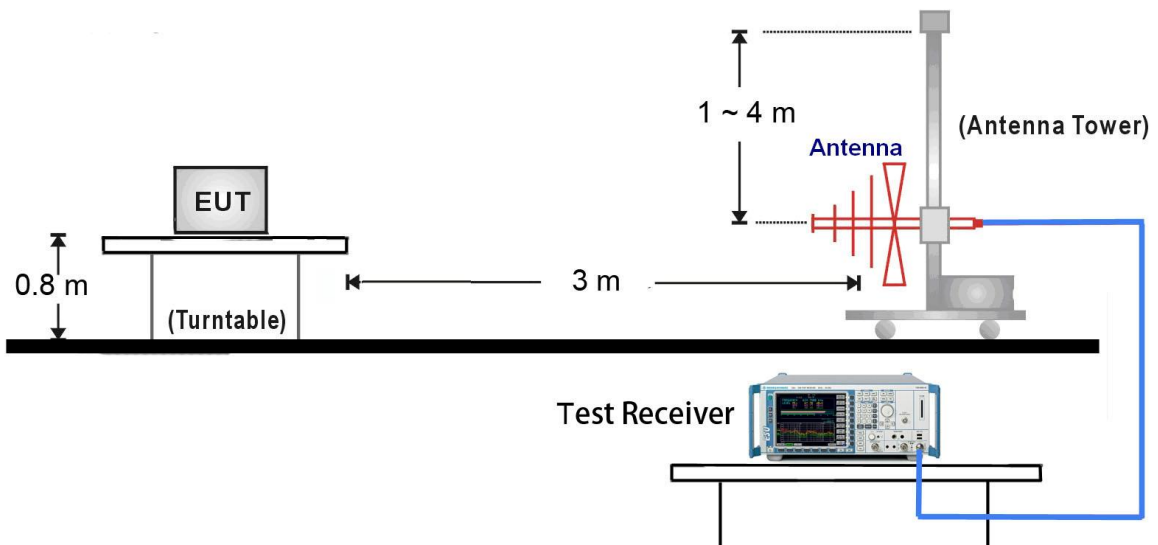

1GHz ~ 25GHz Test Setup:

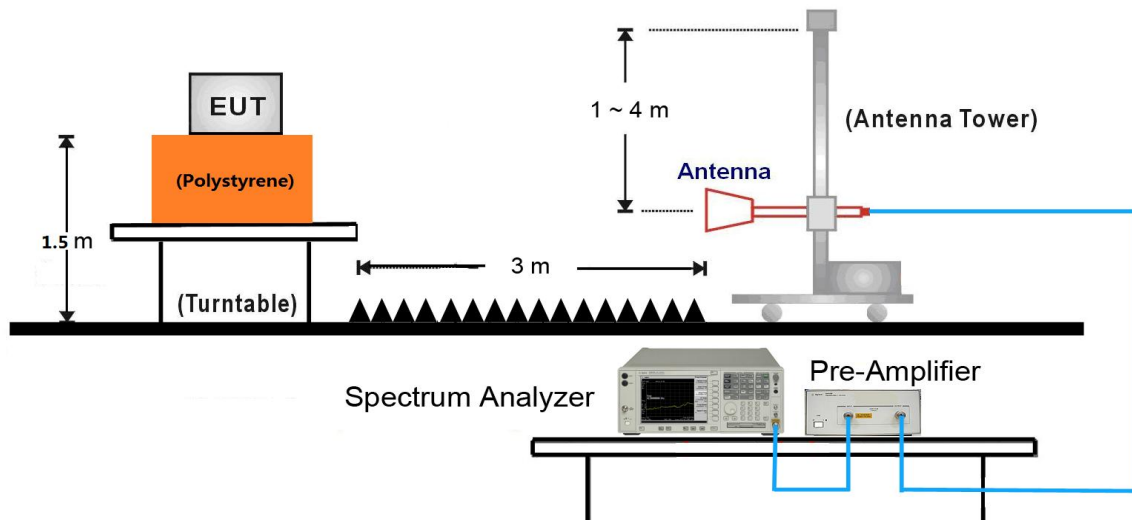

7.6.5. Test Result

Test Mode:	802.15.4	Test Site:	AC1
Test Channel:	11	Test Engineer:	Kevin Ker
Remark:	1. Average measurement was not performed if peak level lower than average limit. 2. Other frequency was 20dB below limit line within 1-18GHz, there is not show in the report.		

Mark	Frequency (MHz)	Reading Level (dBμV)	Factor (dB)	Measure Level (dBμV/m)	Limit (dBμV/m)	Margin (dB)	Detector	Polarization
	3864.5	40.7	0.3	41.0	74.0	-33.0	Peak	Horizontal
	4808.0	51.3	3.7	55.0	74.0	-19.0	Peak	Horizontal
	4808.0	43.6	3.7	47.3	54.0	-6.7	Average	Horizontal
*	5828.0	38.1	5.6	43.7	89.6	-45.9	Peak	Horizontal
*	7213.5	40.5	12.1	52.6	89.6	-37.0	Peak	Horizontal
	3847.5	40.0	0.3	40.3	74.0	-33.7	Peak	Vertical
	4808.0	48.3	3.7	52.0	74.0	-22.0	Peak	Vertical
*	5734.5	39.4	5.1	44.5	89.6	-45.1	Peak	Vertical
*	7213.5	37.9	12.1	50.0	89.6	-39.6	Peak	Vertical

Note 1: "*" is not in restricted band, its limit is 20dBc of the fundamental emission level (109.6dBμV/m) or 15.209 which is higher.

Note 2: Measure Level (dBμV/m) = Reading Level (dBμV) + Factor (dB)

Factor (dB) = Cable Loss (dB) + Antenna Factor (dB/m) – Pre_Amplifier Gain (dB)

Test Mode:	802.15.4	Test Site:	AC1
Test Channel:	18	Test Engineer:	Kevin Ker
Remark:	1. Average measurement was not performed if peak level lower than average limit. 2. Other frequency was 20dB below limit line within 1-18GHz, there is not show in the report.		

Mark	Frequency (MHz)	Reading Level (dBμV)	Factor (dB)	Measure Level (dBμV/m)	Limit (dBμV/m)	Margin (dB)	Detector	Polarization
	4927.0	40.1	3.7	43.8	74.0	-30.2	Peak	Horizontal
	7324.0	37.8	12.4	50.2	74.0	-23.8	Peak	Horizontal
*	8828.5	34.9	14.0	48.9	89.4	-40.5	Peak	Horizontal
*	9755.0	39.9	14.8	54.7	89.4	-34.7	Peak	Horizontal
	4876.0	41.9	3.7	45.6	74.0	-28.4	Peak	Vertical
	7324.0	38.1	12.4	50.5	74.0	-23.5	Peak	Vertical
*	8811.5	34.7	14.0	48.7	89.4	-40.7	Peak	Vertical
*	9755.0	39.8	14.8	54.6	89.4	-34.8	Peak	Vertical

Note 1: "*" is not in restricted band, its limit is 20dBc of the fundamental emission level (109.4dBμV/m) or 15.209 which is higher.

Note 2: Measure Level (dBμV/m) = Reading Level (dBμV) + Factor (dB)

Factor (dB) = Cable Loss (dB) + Antenna Factor (dB/m) – Pre_Amplifier Gain (dB)

Test Mode:	802.15.4	Test Site:	AC1
Test Channel:	25	Test Engineer:	Kevin Ker
Remark:	1. Average measurement was not performed if peak level lower than average limit. 2. Other frequency was 20dB below limit line within 1-18GHz, there is not show in the report.		

Mark	Frequency (MHz)	Reading Level (dBμV)	Factor (dB)	Measure Level (dBμV/m)	Limit (dBμV/m)	Margin (dB)	Detector	Polarization
	4952.5	44.2	3.7	47.9	74.0	-26.1	Peak	Horizontal
	7426.0	40.6	12.7	53.3	74.0	-20.7	Peak	Horizontal
*	8752.0	35.0	13.9	48.9	89.2	-40.3	Peak	Horizontal
*	9789.0	37.3	15.0	52.3	89.2	-36.9	Peak	Horizontal
	4952.5	44.2	3.7	47.9	74.0	-26.1	Peak	Vertical
	7426.0	38.0	12.7	50.7	74.0	-23.3	Peak	Vertical
*	8590.5	36.3	13.4	49.7	89.2	-39.5	Peak	Vertical
*	9899.5	39.2	15.4	54.6	89.2	-34.6	Peak	Vertical

Note 1: "*" is not in restricted band, its limit is 20dBc of the fundamental emission level (109.2dBμV/m) or 15.209 which is higher.

Note 2: Measure Level (dBμV/m) = Reading Level (dBμV) + Factor (dB)

Factor (dB) = Cable Loss (dB) + Antenna Factor (dB/m) – Pre_Amplifier Gain (dB)

The worst case of Radiated Emission below 1GHz:

Site: AC1	Time: 2017/10/25 - 20:12
Limit: FCC_Part15.209_RE(3m)	Engineer: Kevin Ker
Probe: VULB9162_0.03-8GHz	Polarity: Horizontal
EUT: Firebird FPV	Power: By Battery
Worse Case Mode: Transmit at Channel 2405MHz by 802.15.4	

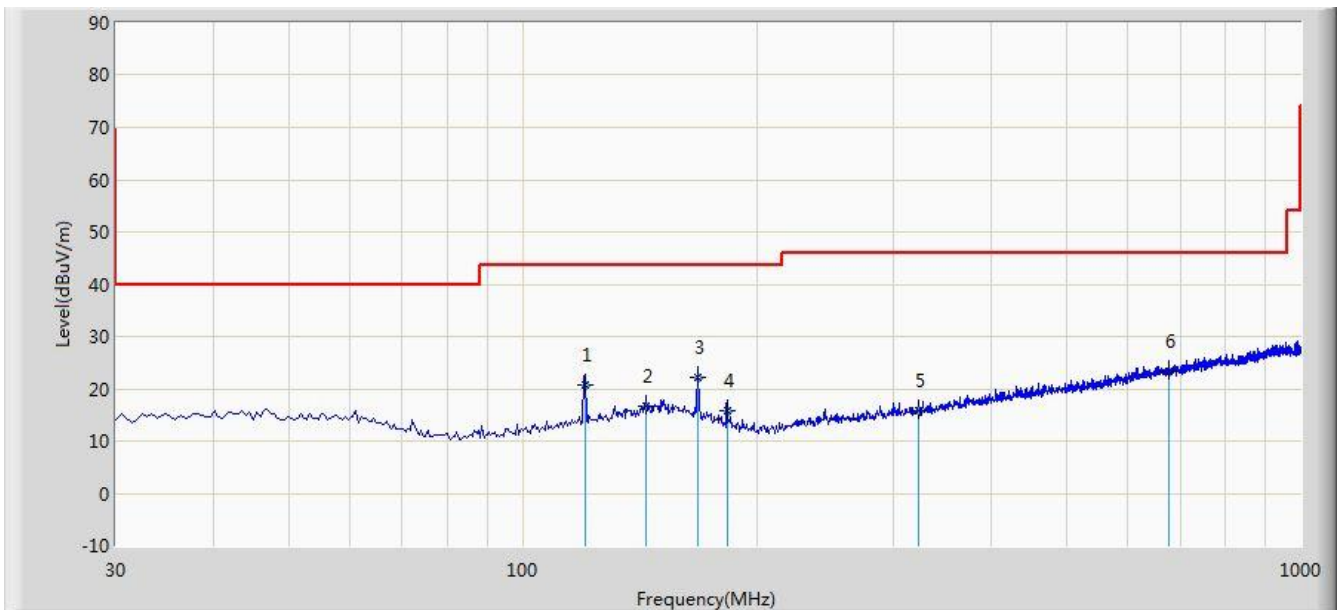

No	Flag	Mark	Frequency (MHz)	Measure Level (dBuV/m)	Reading Level (dBuV)	Over Limit (dB)	Limit (dBuV/m)	Factor (dB)	Type
1			120.210	20.764	7.634	-22.736	43.500	13.130	QP
2			143.975	16.784	2.021	-26.716	43.500	14.763	QP
3		*	167.740	22.150	7.681	-21.350	43.500	14.469	QP
4			183.260	15.776	3.356	-27.724	43.500	12.420	QP
5			322.940	15.898	0.962	-30.102	46.000	14.936	QP
6			677.475	23.367	1.610	-22.633	46.000	21.757	QP

Note 1: Measure Level (dB μ V/m) = Reading Level (dB μ V) + Factor (dB)

Factor (dB) = Cable Loss (dB) + Antenna Factor (dB/m)

Note 2: The test trace is same as the ambient noise and the amplitude of the emissions are attenuated more than 20dB below the permissible (the test frequency range: 9kHz ~ 30MHz, 18GHz ~ 25GHz), therefore no data appear in the report.

Site: AC1	Time: 2017/10/25 - 20:21
Limit: FCC_Part15.209_RE(3m)	Engineer: Kevin Ker
Probe: VULB9162_0.03-8GHz	Polarity: Vertical
EUT: Firebird FPV	Power: By Battery
Worse Case Mode: Transmit at Channel 2405MHz by 802.15.4	

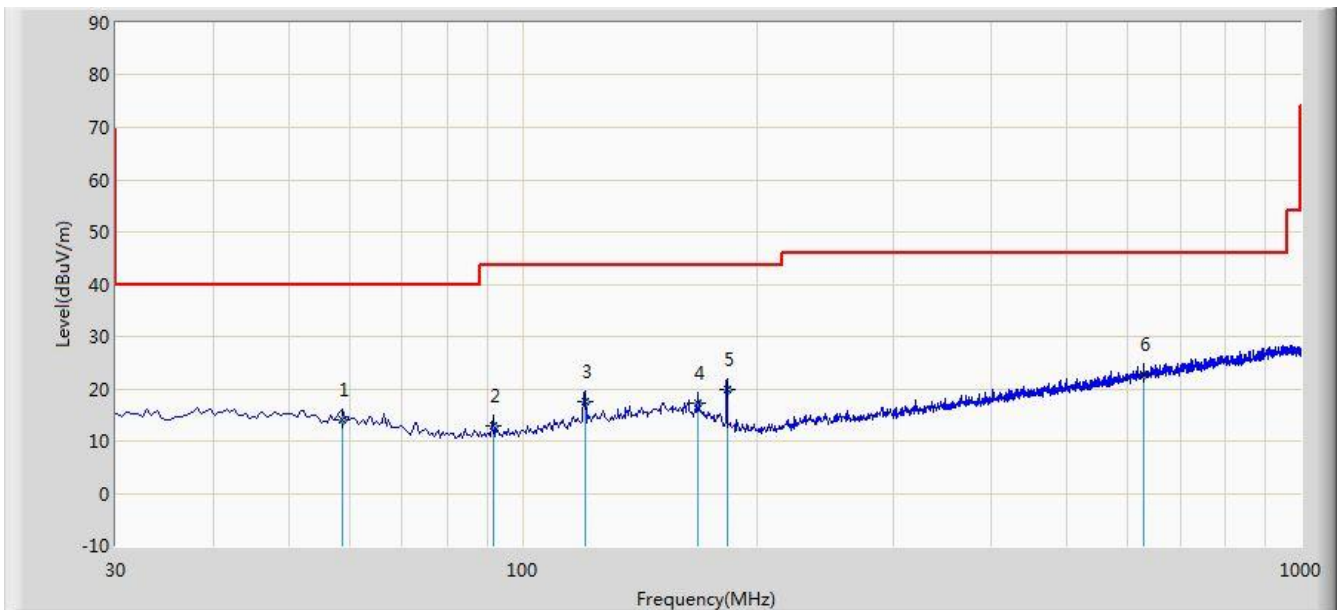

No	Flag	Mark	Frequency (MHz)	Measure Level (dBuV/m)	Reading Level (dBuV)	Over Limit (dB)	Limit (dBuV/m)	Factor (dB)	Type
1			58.615	13.975	0.517	-26.025	40.000	13.458	QP
2			91.595	12.899	2.574	-30.601	43.500	10.325	QP
3			120.210	17.476	4.346	-26.024	43.500	13.130	QP
4			168.225	17.367	2.938	-26.133	43.500	14.429	QP
5			183.260	19.797	7.377	-23.703	43.500	12.420	QP
6		*	628.975	22.663	1.573	-23.337	46.000	21.090	QP

Note 1: Measure Level (dB μ V/m) = Reading Level (dB μ V) + Factor (dB)

Factor (dB) = Cable Loss (dB) + Antenna Factor (dB/m)

Note 2: The test trace is same as the ambient noise and the amplitude of the emissions are attenuated more than 20dB below the permissible (the test frequency range: 9kHz ~ 30MHz, 18GHz ~ 25GHz), therefore no data appear in the report.

7.7. Radiated Restricted Band Edge Measurement

7.7.1. Test Limit

Radiated emissions which fall in the restricted bands, as defined in Section 15.205(a) of FCC part 15, must also comply with the radiated emission limits specified in Section 15.209(a).

Frequency (MHz)	Frequency (MHz)	Frequency (MHz)	Frequency (GHz)
0.090 - 0.110	16.42-16.423	399.9 - 410	4.5-5.15
¹ 0.495 - 0.505	16.69475-16.69525	608 - 614	5.35-5.46
2.1735-2.1905	16.80425-16.80475	960 - 1240	7.25-7.75
4.125-4.128	25.5 -25.67	1300 - 1427	8.25 - 8.5
4.17725-4.17775	37.5-38.25	1435-1626.5	9.0-9.2
4.20725-4.20775	73-74.6	1645.5-1646.5	9.3-9.5
6.215-6.218	74.8-75.2	1660 - 1710	10.6-12.7
6.26775-6.26825	108-121.94	1718.8-1722.2	13.25-13.4
6.31175-6.31225	123 - 138	2200 - 2300	14.47-14.5
8.291-8.294	149.9-150.05	2310-2390	15.35-16.2
8.362-8.366	156.52475-156.525	2483.5 - 2500	17.7-21.4
8.37625-8.38675	156.7-156.9	2690 - 2900	22.01-23.12
8.41425-8.41475	162.0125-167.17	3260 - 3267	23.6-24.0
12.29-12.293	167.72-173.2	3332 - 3339	31.2-31.8
12.51975-12.52025	240 - 285	3345.8 - 3358	36.43-36.5
12.57675-12.57725	322-335.4	3600 - 4400	(²)
13.36-13.41	--	--	--

All out of band emissions appearing in a restricted band as specified in Section 15.205 of the Title 47CFR must not exceed the limits shown in Table per Section 15.209.

FCC Part 15 Subpart C Paragraph 15.209		
Frequency [MHz]	Field Strength [uV/m]	Measured Distance [Meters]
0.009 – 0.490	2400/F (kHz)	300
0.490 – 1.705	24000/F (kHz)	30
1.705 - 30	30	30
30 - 88	100	3
88 - 216	150	3
216 - 960	200	3
Above 960	500	3

7.7.2. Test Procedure Used

ANSI C63.10 Section 6.3 (General Requirements)

ANSI C63.10 Section 6.6 (Standard test method above 1GHz)

7.7.3. Test Setting

Peak Field Strength Measurements

1. Analyzer center frequency was set to the frequency of the radiated spurious emission of interest
2. RBW = 1MHz
3. VBW = 3MHz
4. Detector = peak
5. Sweep time = auto couple
6. Trace mode = max hold
7. Trace was allowed to stabilize

Average Field Strength Measurements

1. Analyzer center frequency was set to the frequency of the radiated spurious emission of interest
2. RBW = 1MHz
3. VBW $\geq 1/T$
4. De As an alternative, the instrument may be set to linear detector mode. Ensure that video filtering is applied in linear voltage domain (rather than in a log or dB domain). Some instruments require linear display mode in order to accomplish this. Others have a setting for Average-VBW Type, which can be set to "Voltage" regardless of the display mode
5. Detector = Peak
6. Sweep time = auto
7. Trace mode = max hold
8. Allow max hold to run for at least 50 times (1/duty cycle) traces

7.7.4. Test Setup

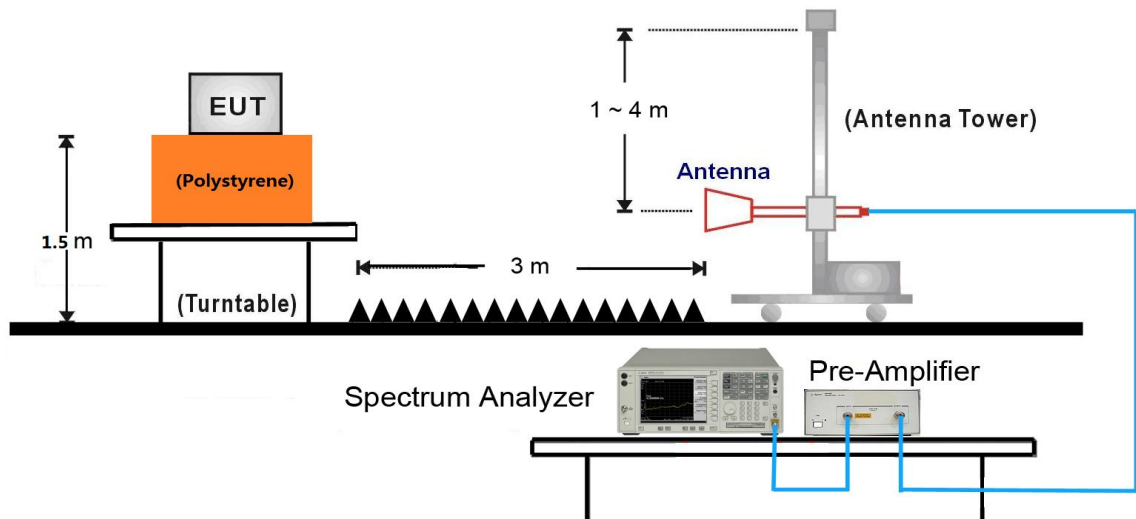

7.7.5. Test Result

Site: AC1	Time: 2017/12/16 - 11:08
Limit: FCC_Part15.209_RE(3m)	Engineer: Kevin Ker
Probe: BBHA9120D_1GHz_18GHz	Polarity: Horizontal
EUT: Firebird FPV	Power: By Battery
Test Mode: Transmit at Channel 2405MHz by 802.15.4	

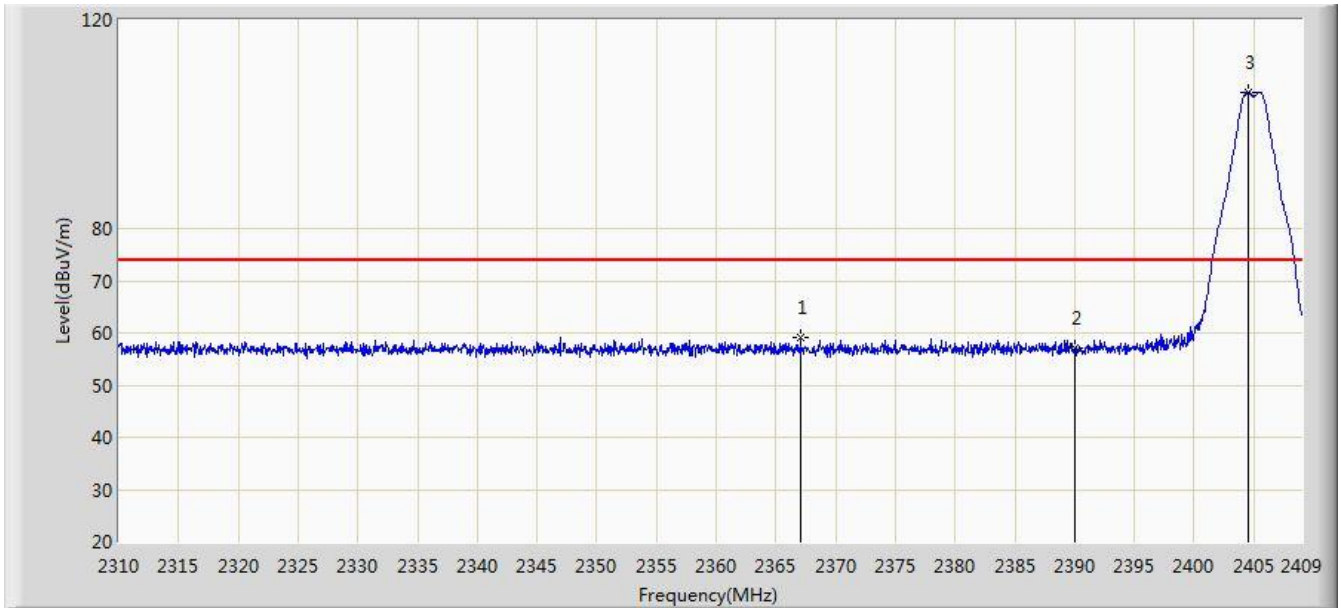

No	Flag	Mark	Frequency (MHz)	Measure Level (dBuV/m)	Reading Level (dBuV)	Over Limit (dB)	Limit (dBuV/m)	Factor (dB)	Type
1			2367.073	59.105	26.519	-14.895	74.000	32.587	PK
2			2390.000	57.057	24.503	-16.943	74.000	32.554	PK
3		*	2404.496	106.117	73.582	N/A	N/A	32.535	PK

Note: Measure Level (dB μ V/m) = Reading Level (dB μ V) + Factor (dB)

Factor (dB) = Cable Loss (dB) + Antenna Factor (dB/m)

Site: AC1	Time: 2017/12/16 - 11:12
Limit: FCC_Part15.209_RE(3m)	Engineer: Kevin Ker
Probe: BBHA9120D_1GHz_18GHz	Polarity: Horizontal
EUT: Firebird FPV	Power: By Battery
Test Mode: Transmit at Channel 2405MHz by 802.15.4	

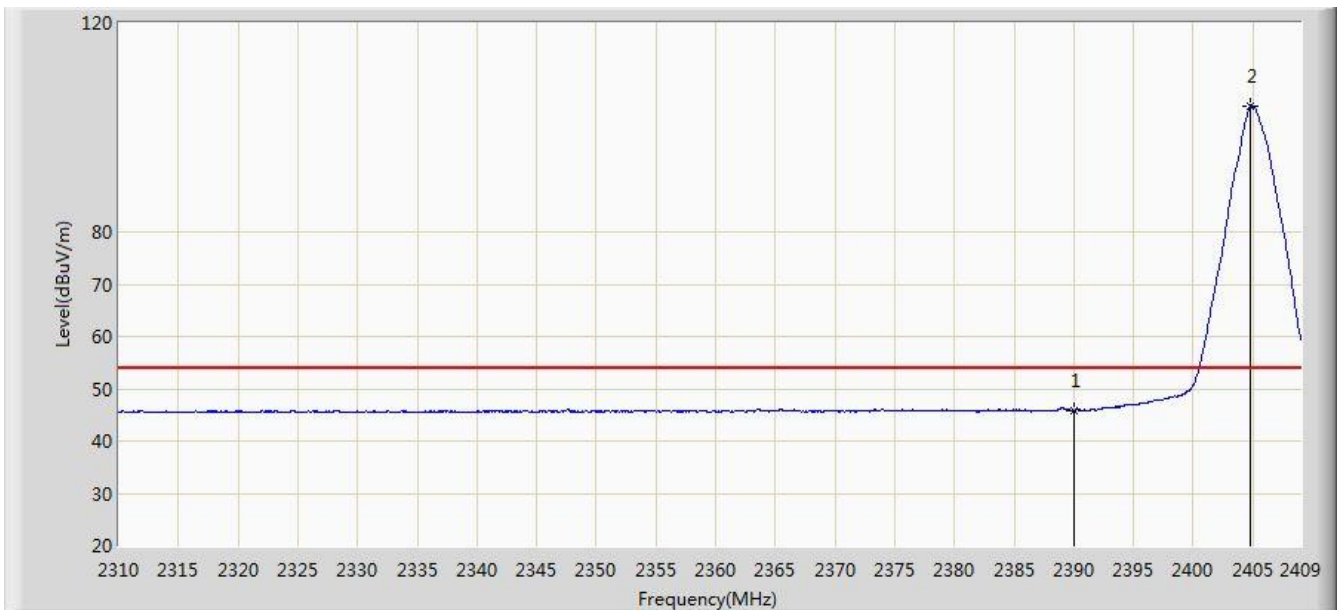

No	Flag	Mark	Frequency (MHz)	Measure Level (dBuV/m)	Reading Level (dBuV)	Over Limit (dB)	Limit (dBuV/m)	Factor (dB)	Type
1			2390.000	45.877	13.323	-8.123	54.000	32.554	AV
2		*	2404.792	104.059	71.524	N/A	N/A	32.535	AV

Note: Measure Level (dB μ V/m) = Reading Level (dB μ V) + Factor (dB)

Factor (dB) = Cable Loss (dB) + Antenna Factor (dB/m)

Site: AC1	Time: 2017/12/16 - 11:36
Limit: FCC_Part15.209_RE(3m)	Engineer: Kevin Ker
Probe: BBHA9120D_1GHz_18GHz	Polarity: Vertical
EUT: Firebird FPV	Power: By Battery
Test Mode: Transmit at Channel 2405MHz by 802.15.4	

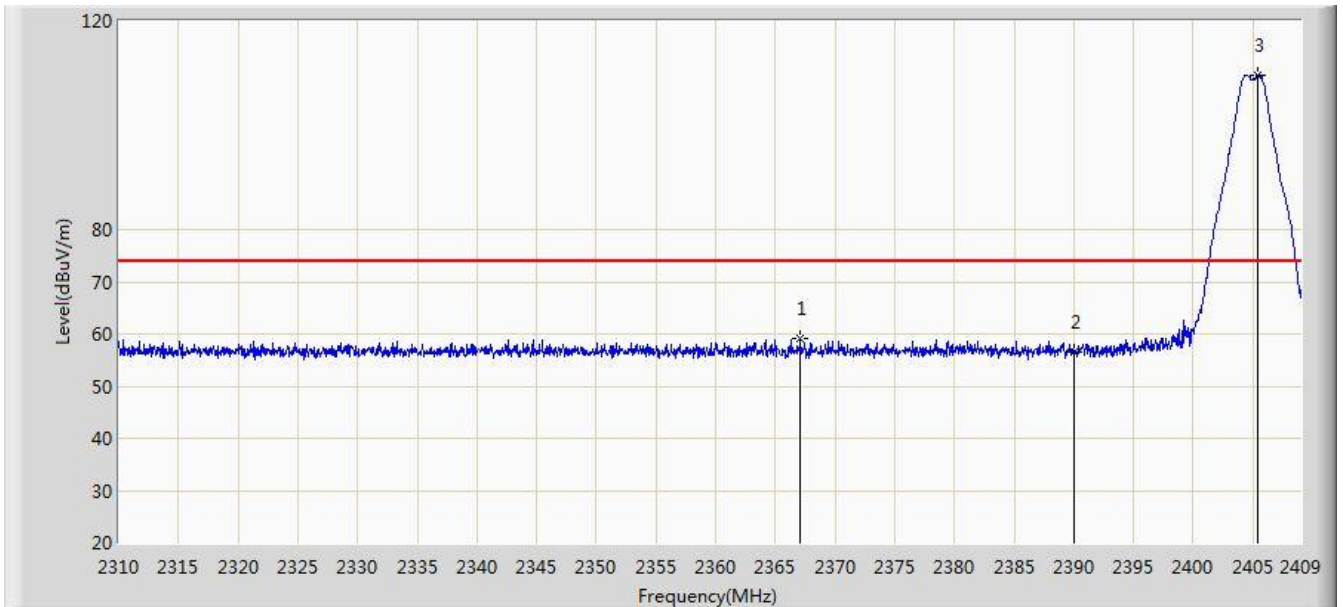

No	Flag	Mark	Frequency (MHz)	Measure Level (dBuV/m)	Reading Level (dBuV)	Over Limit (dB)	Limit (dBuV/m)	Factor (dB)	Type
1			2367.123	59.154	26.568	-14.846	74.000	32.587	PK
2			2390.000	56.416	23.862	-17.584	74.000	32.554	PK
3		*	2405.386	109.613	77.079	N/A	N/A	32.534	PK

Note: Measure Level (dB μ V/m) = Reading Level (dB μ V) + Factor (dB)

Factor (dB) = Cable Loss (dB) + Antenna Factor (dB/m)

Site: AC1	Time: 2017/12/16 - 11:39
Limit: FCC_Part15.209_RE(3m)	Engineer: Kevin Ker
Probe: BBHA9120D_1GHz_18GHz	Polarity: Vertical
EUT: Firebird FPV	Power: By Battery
Test Mode: Transmit at Channel 2405MHz by 802.15.4	

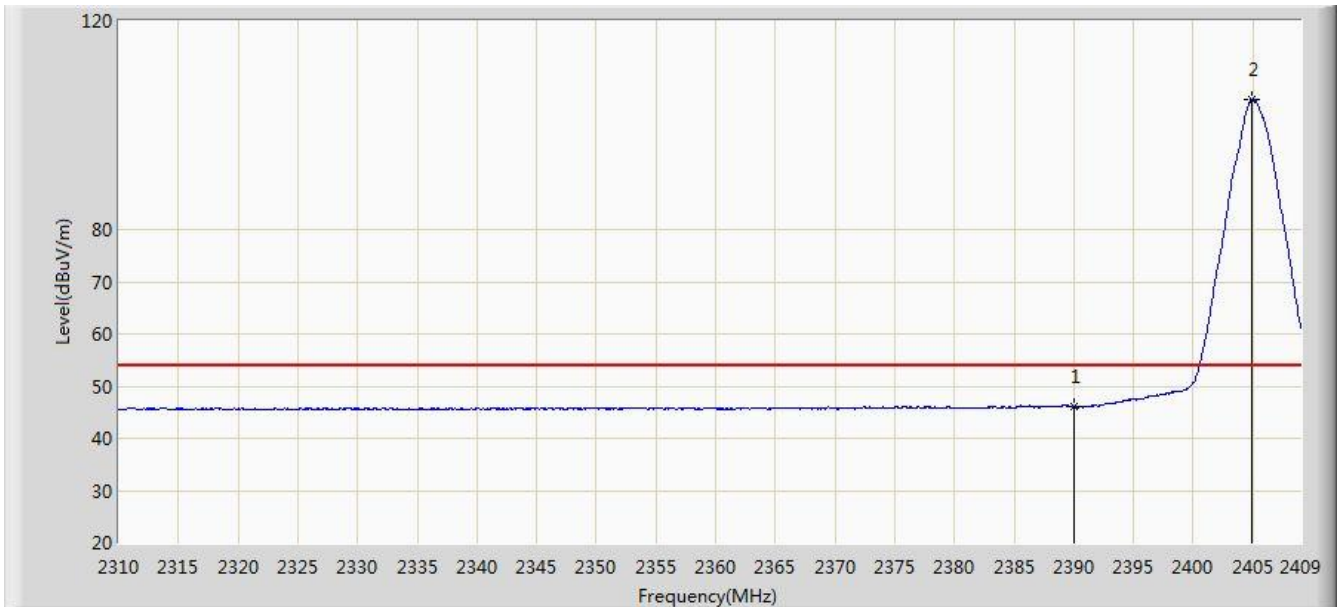

No	Flag	Mark	Frequency (MHz)	Measure Level (dBuV/m)	Reading Level (dBuV)	Over Limit (dB)	Limit (dBuV/m)	Factor (dB)	Type
1			2390.000	46.110	13.556	-7.890	54.000	32.554	AV
2		*	2404.941	105.056	72.521	N/A	N/A	32.535	AV

Note: Measure Level (dB μ V/m) = Reading Level (dB μ V) + Factor (dB)

Factor (dB) = Cable Loss (dB) + Antenna Factor (dB/m)

Site: AC1	Time: 2017/12/16 - 11:49
Limit: FCC_Part15.209_RE(3m)	Engineer: Kevin Ker
Probe: BBHA9120D_1GHz_18GHz	Polarity: Horizontal
EUT: Firebird FPV	Power: By Battery
Test Mode: Transmit at Channel 2475MHz by 802.15.4	

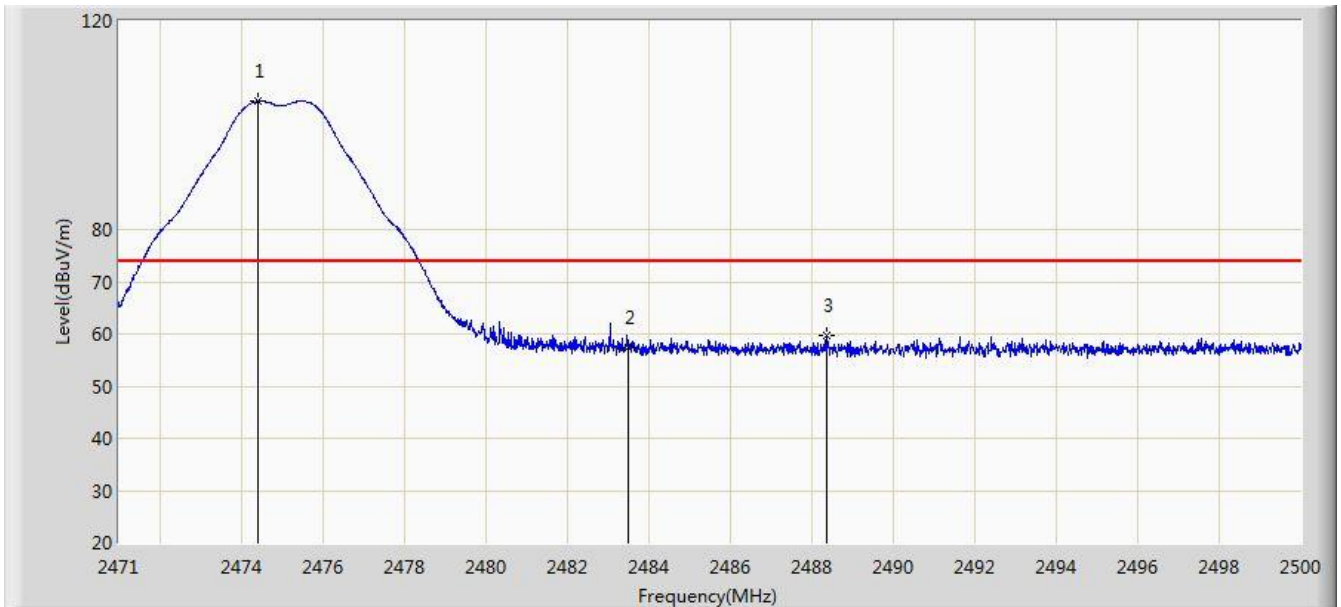

No	Flag	Mark	Frequency (MHz)	Measure Level (dBuV/m)	Reading Level (dBuV)	Over Limit (dB)	Limit (dBuV/m)	Factor (dB)	Type
1		*	2474.407	104.550	71.997	N/A	N/A	32.553	PK
2			2483.500	57.402	24.821	-16.598	74.000	32.580	PK
3			2488.385	59.738	27.143	-14.262	74.000	32.595	PK

Note: Measure Level (dB μ V/m) = Reading Level (dB μ V) + Factor (dB)

Factor (dB) = Cable Loss (dB) + Antenna Factor (dB/m)

Site: AC1	Time: 2017/12/16 - 11:57
Limit: FCC_Part15.209_RE(3m)	Engineer: Kevin Ker
Probe: BBHA9120D_1GHz_18GHz	Polarity: Horizontal
EUT: Firebird FPV	Power: By Battery
Test Mode: Transmit at Channel 2475MHz by 802.15.4	

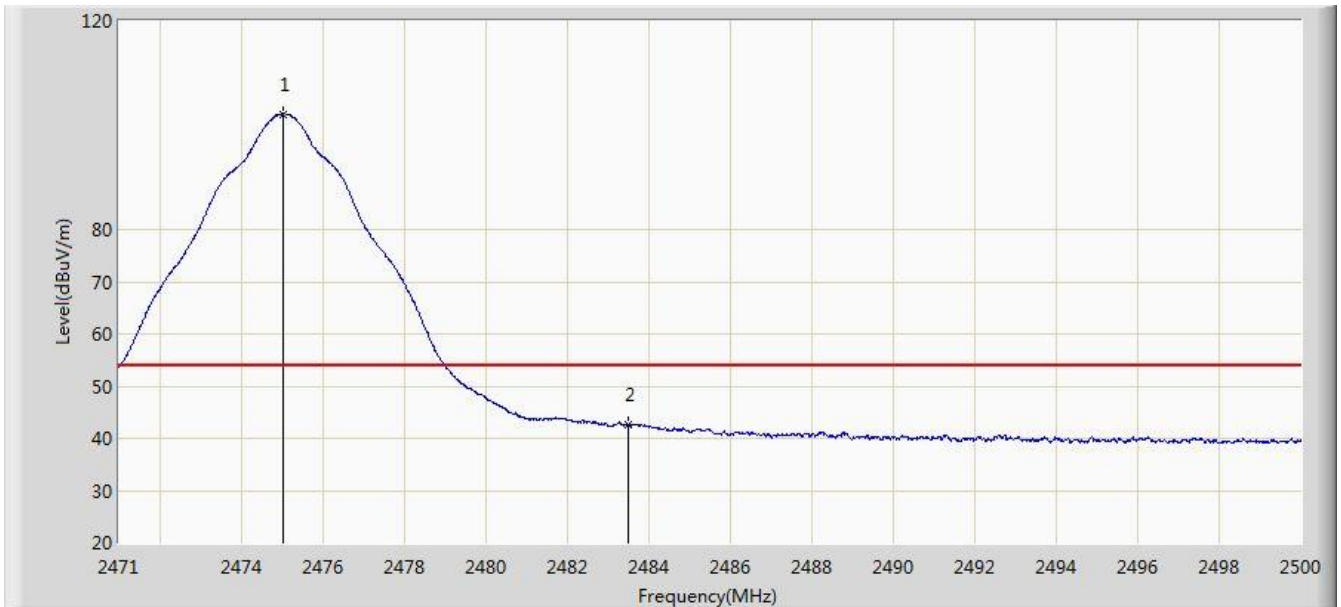

No	Flag	Mark	Frequency (MHz)	Measure Level (dBuV/m)	Reading Level (dBuV)	Over Limit (dB)	Limit (dBuV/m)	Factor (dB)	Type
1		*	2475.045	102.167	69.612	N/A	N/A	32.555	AV
2			2483.500	42.598	10.017	-11.402	54.000	32.580	AV

Note: Measure Level (dB μ V/m) = Reading Level (dB μ V) + Factor (dB)

Factor (dB) = Cable Loss (dB) + Antenna Factor (dB/m)

Site: AC1	Time: 2017/12/16 - 12:01
Limit: FCC_Part15.209_RE(3m)	Engineer: Kevin Ker
Probe: BBHA9120D_1GHz_18GHz	Polarity: Vertical
EUT: Firebird FPV	Power: By Battery
Test Mode: Transmit at Channel 2475MHz by 802.15.4	

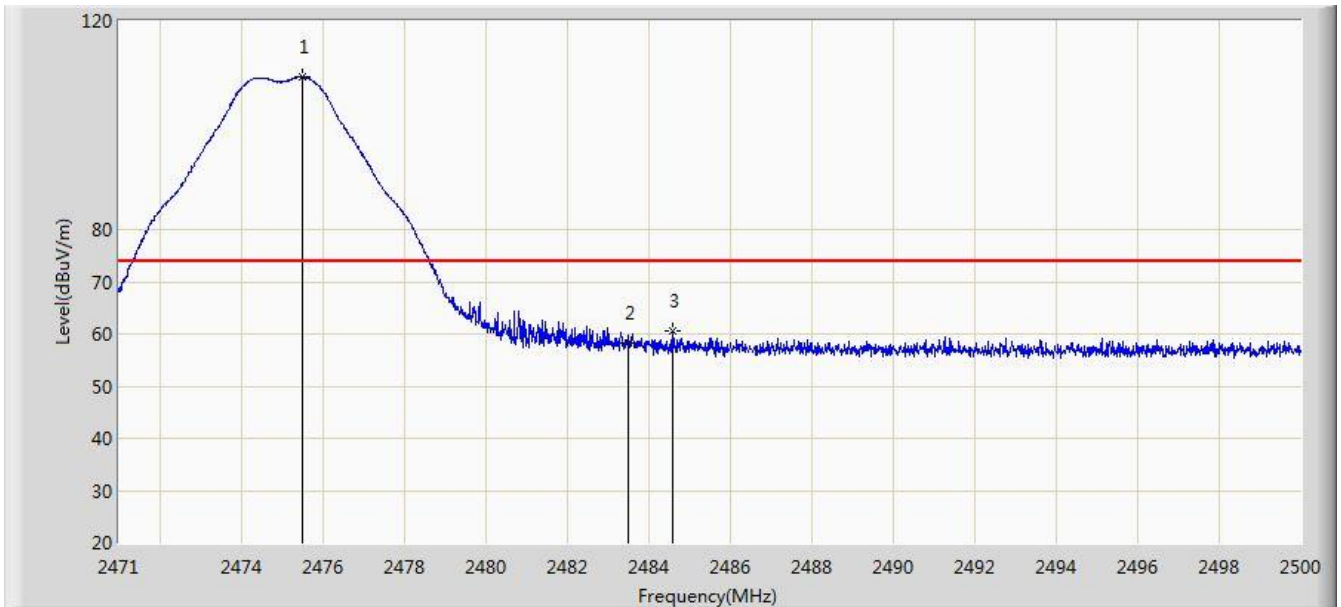

No	Flag	Mark	Frequency (MHz)	Measure Level (dBuV/m)	Reading Level (dBuV)	Over Limit (dB)	Limit (dBuV/m)	Factor (dB)	Type
1		*	2475.495	109.173	76.617	N/A	N/A	32.557	PK
2			2483.500	58.154	25.573	-15.846	74.000	32.580	PK
3			2484.601	60.654	28.070	-13.346	74.000	32.584	PK

Note: Measure Level (dB μ V/m) = Reading Level (dB μ V) + Factor (dB)

Factor (dB) = Cable Loss (dB) + Antenna Factor (dB/m)

Site: AC1	Time: 2017/12/16 - 12:02
Limit: FCC_Part15.209_RE(3m)	Engineer: Kevin Ker
Probe: BBHA9120D_1GHz_18GHz	Polarity: Vertical
EUT: Firebird FPV	Power: By Battery
Test Mode: Transmit at Channel 2475MHz by 802.15.4	

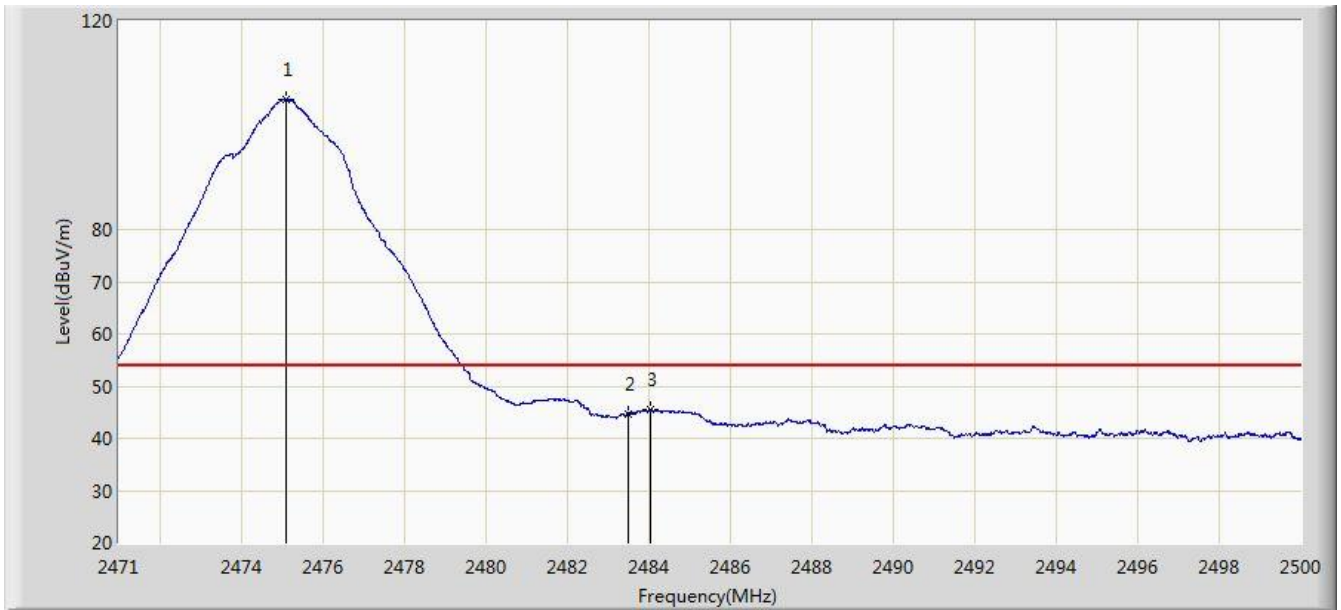

No	Flag	Mark	Frequency (MHz)	Measure Level (dBuV/m)	Reading Level (dBuV)	Over Limit (dB)	Limit (dBuV/m)	Factor (dB)	Type
1		*	2475.089	104.891	72.336	N/A	N/A	32.555	AV
2			2483.500	44.738	12.157	-9.262	54.000	32.580	AV
3			2484.064	45.461	12.879	-8.539	54.000	32.582	AV

Note: Measure Level (dB μ V/m) = Reading Level (dB μ V) + Factor (dB)

Factor (dB) = Cable Loss (dB) + Antenna Factor (dB/m)

7.8. AC Conducted Emissions Measurement

7.8.1. Test Limit

FCC 15.207 Limits		
Frequency (MHz)	QP (dBuV)	AV (dBuV)
0.15 ~ 0.50	66 ~ 56	56 ~ 46
0.50 ~ 5.0	56	46
5.0 ~ 30	60	50

Note 1: The lower limit shall apply at the transition frequencies.

Note 2: The limit decreases linearly with the logarithm of the frequency in the range 0.15MHz to 0.5MHz.

7.8.2. Test Setup

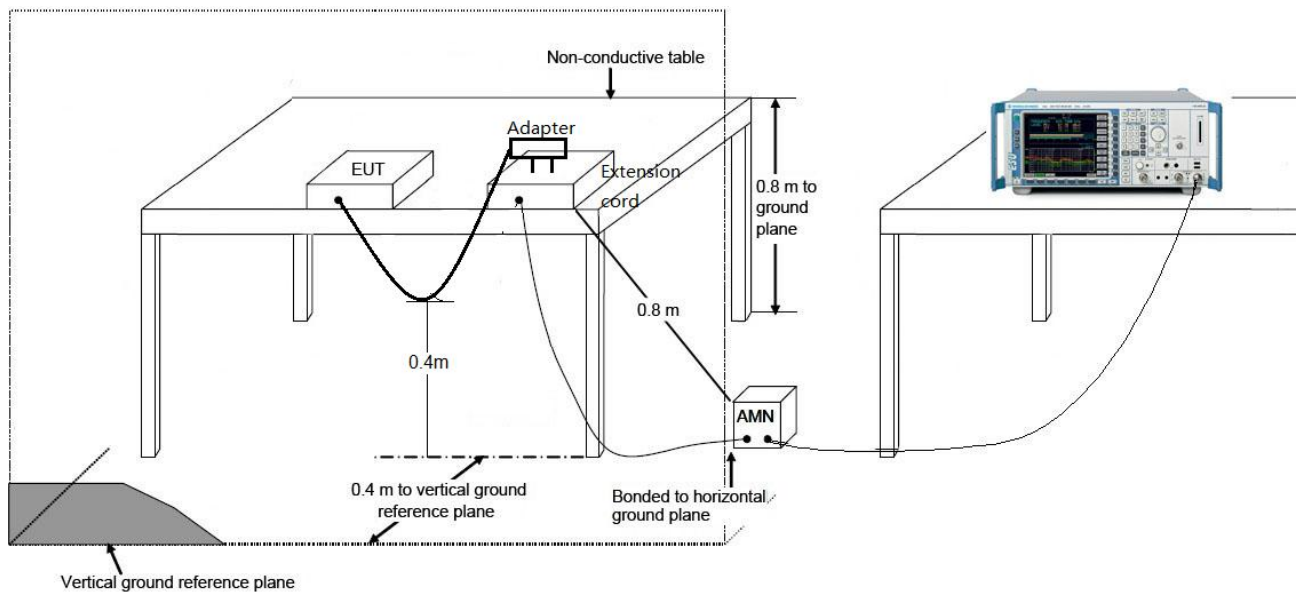

7.8.3. Test Result

The EUT is powered by battery, so this requirement does not apply.

8. CONCLUSION

The data collected relate only the item(s) tested and show that the **Firebird FPV, FCC ID: 2ACS5-YUNFBD** is in compliance with Part 15C of the FCC Rules and ISED Rules.

The End