

TEST REPORT

Applicant: Yuneec Technology Co., Limited
Address: Unit 2301,23/F,9 Chong Yip Street,Kwun Tong,Kowloon, Hong kong.
Equipment Type: Smart Remote Controller
Model Name: T-One
Brand Name: YUNEEC
FCC ID: 2ACS5-TONE
Test Standard: FCC 47 CFR Part 2.1093
(refer section 3.1)
Test Date: May 26, 2022 ~ May 28, 2022
Date of Issue: Jun. 28, 2022

ISSUED BY:

Shenzhen BALUN Technology Co., Ltd.



Tested by: Xu Rui

Checked by: Zong Liyao

Approved by: Wei Yanquan
(Chief Engineer)

Xu Rui

Liyao. Zong

Wei Yanquan

Revision History

Version	Issue Date	Revisions Content
<u>Rev. 01</u>	<u>Jun. 28, 2022</u>	<u>Initial Issue</u>

TABLE OF CONTENTS

1	GENERAL INFORMATION.....	4
1.1	Identification of the Testing Laboratory	4
1.2	Identification of the Responsible Testing Location	4
2	PRODUCT INFORMATION	5
2.1	Applicant Information	5
2.2	Manufacturer Information.....	5
2.3	Factory Information.....	5
2.4	General Description for Equipment under Test (EUT).....	5
2.5	Ancillary Equipment.....	5
2.6	Technical Information	6
3	SUMMARY OF TEST RESULT	7
3.1	Test Standards	7
3.2	Device Category and SAR Limit	8
3.3	Test Result Summary	9
3.4	Test Uncertainty	10
4	MEASUREMENT SYSTEM	12
4.1	Definition of Specific Absorption Rate (SAR)	12
4.2	SATIMO SAR System.....	13
5	MEASUREMENT PROCEDURE	22
5.1	Antenna Port Test Requirement	22
5.2	Purpose of System Check	22
5.3	System Check Setup	22
6	EUT TEST POSITION CONFIGURATUONS.....	23
6.1	Body Exposure Condition	23
6.2	Extremity Exposure Condition.....	23

7	SAR MEASUREMENT PROCEDURES.....	24
7.1	SAR Measurement Process Diagram	24
7.2	SAR Scan General Requirements	25
7.3	SAR Measurement Procedure	26
7.4	Area & Zoom Scan Procedures	26
8	CONDUCTED RF OUPUT POWER	27
8.1	WIFI.....	27
9	EUT ANTENNA LOCATION SKETCH.....	30
9.1	SAR Test Exclusion Consideration Table	31
10	TEST RESULT	33
10.1	2.4G ISM Band Body SAR.....	33
10.2	2.4G ISM Band Limbs SAR	33
10.3	WIFI 2.4G Body SAR.....	34
10.4	WIFI 2.4G Limbs SAR	34
10.5	5.8G ISM Band Body SAR.....	35
10.6	5.8G ISM Band Limbs SAR	35
10.7	WIFI 5G Body SAR.....	36
10.8	WIFI 5G Limbs SAR	36
11	SAR Measurement Variability	37
12	SIMULTANEOUS TRANSMISSION.....	38
12.1	Simultaneous Transmission Mode Consider	38
12.2	Sum SAR of Simultaneous Transmission	38
13	TEST EQUIPMENTS LIST	40
ANNEX A	SIMULATING LIQUID VERIFICATION RESULT	41
ANNEX B	SYSTEM CHECK RESULT	42
ANNEX C	TEST DATA.....	51
ANNEX D	EUT EXTERNAL PHOTOS.....	59
ANNEX E	SAR TEST SETUP PHOTOS	59
ANNEX F	CALIBRATION REPORT.....	59

1 GENERAL INFORMATION

1.1 Identification of the Testing Laboratory

Company Name	Shenzhen BALUN Technology Co., Ltd.
Address	Block B, 1/F, Baisha Science and Technology Park, Shahe West Road, Nanshan District, ShenZhen, GuangDong Province, China
Phone Number	+86 755 6685 0100

1.2 Identification of the Responsible Testing Location

Test Location	Shenzhen BALUN Technology Co., Ltd.
Address	Block B, 1/F, Baisha Science and Technology Park, Shahe West Road, Nanshan District, ShenZhen, GuangDong Province, China
Accreditation Certificate	The laboratory is a testing organization accredited by FCC as a accredited testing laboratory. The designation number is CN1196.
Description	All measurement facilities used to collect the measurement data are located at Block B, 1/F, Baisha Science and Technology Park, Shahe West Road, Nanshan District, ShenZhen, GuangDong Province, China

2 PRODUCT INFORMATION

2.1 Applicant Information

Applicant	Yunee Technology Co., Limited
Address	Unit 2301, 23/F, 9 Chong Yip Street, Kwun Tong, Kowloon, Hong Kong.

2.2 Manufacturer Information

Manufacturer	Yunee International (China) Co., Ltd
Address	No.388 East Zhengwei Road, Jinxi Town, Kunshan, Jiangsu 215324, China

2.3 Factory Information

Factory	Yunee International (China) Co., Ltd
Address	No.388 East Zhengwei Road, Jinxi Town, Kunshan, Jiangsu 215324, China

2.4 General Description for Equipment under Test (EUT)

EUT Name	Smart Remote Controller
Model Name Under Test	T-One
Series Model Name	N/A
Description of Model Name Differentiation	N/A
Serial Number	Tone20220322
Hardware Version	N/A
Software Version	N/A
Dimensions (Approx.)	N/A
Weight (Approx.)	N/A

2.5 Ancillary Equipment

Ancillary Equipment 1	Battery	
	Brand Name	N/A
	Model No.	YP-4A
	Serial No.	N/A
	Capacitance	9600mAh
	Rated Voltage	7.38V
	Limited Voltage	N/A
	Manufacturer	Yunee International (China) Co., Ltd

2.6 Technical Information

Network and Wireless connectivity	Bluetooth (BR+EDR+BLE) WIFI 802.11a, 802.11b, 802.11g, 802.11n and 802.11ac U-NII-1/2A/2C/3 2.4G ISM Band (OFDM modulation) 5.8G ISM Band (OFDM modulation)
-----------------------------------	---

The requirement for the following technical information of the EUT was tested in this report:

Operating Mode	2.4G WLAN; 5G WLAN; 2.4G ISM; 5.8G ISM; Bluetooth	
Frequency Range	802.11b/g	2400 ~ 2483.5 MHz
	802.11n(HT20)	2400 ~ 2483.5 MHz
	802.11a	5150 ~ 5350 MHz
		5470 ~ 5725 MHz
		5725 ~ 5850 MHz
	802.11n(HT20/HT40)	5150 ~ 5350 MHz
		5470 ~ 5725 MHz
		5725 ~ 5850 MHz
	802.11ac(VHT20/VHT40/VHT80)	5150 ~ 5350 MHz
		5470 ~ 5725 MHz
5725 ~ 5850 MHz		
2.4G ISM Band	2400 ~ 2483.5 MHz	
5.8G ISM Band	5725 ~ 5850 MHz	
Bluetooth	2400 ~ 2483.5 MHz	
Antenna Type	WLAN	PCB
	Bluetooth	PCB
	2.4G & 5.8G ISM	Dipole
Hotspot Function	N/A	
Exposure Category	General Population/Uncontrolled exposure	
EUT Stage	Portable Device	

3 SUMMARY OF TEST RESULT

3.1 Test Standards

No.	Identity	Document Title
1	47 CFR Part 2.1093	Radiofrequency radiation exposure evaluation: portable devices
2	ANSI/IEEE Std. C95.1-1999	IEEE Standard for Safety Levels with Respect to Human Exposure to Radio Frequency Electromagnetic Fields, 3 kHz to 300 GHz
3	IEEE Std. 1528-2013	Recommended Practice for Determining the Peak Spatial-Average Specific Absorption Rate (SAR) in the Human Head from Wireless Communications Devices: Measurement Techniques
4	FCC KDB 447498 D04	RF Exposure Procedures and Equipment Authorization Policies for Mobile and Portable Devices
5	FCC KDB 865664 D01 v01r04	SAR Measurement 100 MHz to 6 GHz
6	FCC KDB 865664 D02 v01r02	RF Exposure Reporting
7	KDB 248227 D01 v02r02	SAR Guidance for IEEE 802.11 (Wi-Fi) Transmitters

3.2 Device Category and SAR Limit

This device belongs to portable device category because its radiating structure is allowed to be used within 20 centimeters of the body of the user. Limit for General Population/Uncontrolled exposure should be applied for this device, it is 1.6 W/kg as averaged over any 1 gram of tissue.

Table of Exposure Limits:

Body Position	SAR Value (W/Kg)	
	General Population/ Uncontrolled Exposure	Occupational/ Controlled Exposure
Whole-Body SAR (averaged over the entire body)	0.08	0.4
Partial-Body SAR (averaged over any 1 gram of tissue)	1.60	8.0
SAR for hands, wrists, feet and ankles (averaged over any 10 grams of tissue)	4.0	20.0

NOTE:

General Population/Uncontrolled: Locations where there is the exposure of individuals who have no knowledge or control of their exposure. General population/uncontrolled exposure limits are applicable to situations in which the general public may be exposed or in which persons who are exposed as a consequence of their employment may not be made fully aware of the potential for exposure or cannot exercise control over their exposure. Members of the general public would come under this category when exposure is not employment-related; for example, in the case of a wireless transmitter that exposes persons in its vicinity.

Occupational/Controlled: Locations where there is exposure that may be incurred by persons who are aware of the potential for exposure, In general, occupational/controlled exposure limits are applicable to situations in which persons are exposed as a consequence of their employment, who have been made fully aware of the potential for exposure and can exercise control over their exposure. This exposure category is also applicable when the exposure is of a transient nature due to incidental passage through a location where the exposure levels may be higher than the general population/uncontrolled limits, but the exposed person is fully aware of the potential for exposure and can exercise control over his or her exposure by leaving the area or by some other appropriate means.

3.3 Test Result Summary

3.3.1 Highest SAR

Frequency Band		Maximum Report SAR(W/kg)	Maximum Report SAR(W/kg)
		1 g	10 g
		Body	Limbs
WIFI	2.4G ISM Band	0.125	0.097
	2.4G WLAN	0.008	0.012
	5.8G ISM Band	0.067	0.081
	5G WLAN	0.079	0.032
Limits (W/kg)		1.6	4.0
Test Verdict		Pass	

Note: The worst case for Simultaneous Transmission Maximum Report SAR(W/kg)

Body is 0.204(1g) 2.4G ISM Band +5G WLAN

Limbs is 0.129(10g) 2.4G ISM Band +5G WLAN

3.4 Test Uncertainty

3.4.1 Measurement uncertainty evaluation for SAR test

The following measurement uncertainty levels have been estimated for tests performed on the EUT as specified in IEEE 1528 This uncertainty represents an expanded uncertainty expressed at approximately the 95% confidence level using a coverage factor of k=2.

Uncertainty Component	Tol (+-%)	Prob. Dist.	Div.	Ci (1g)	Ci (10 g)	1g Ui (+-%)	10 g Ui (+-%)	Vi V _{eff}
Measurement System								
Probe calibration	5.8	N	1	1	1	5.80	5.80	∞
Axial Isotropy	3.5	R	$\sqrt{3}$	0.7	0.7	1.41	1.41	∞
Hemispherical Isotropy	5.9	R	$\sqrt{3}$	0.7	0.7	2.38	2.38	∞
Boundary effect	1.0	R	$\sqrt{3}$	1	1	0.58	0.58	∞
Linearity	4.7	R	$\sqrt{3}$	1	1	2.71	2.71	∞
System detection limits	1.0	R	$\sqrt{3}$	1	1	0.58	0.58	∞
Modulation response	3.0	R	$\sqrt{3}$	1	1	1.73	1.73	∞
Readout Electronics	0.5	N	1	1	1	0.50	0.50	∞
Response Time	0.0	R	$\sqrt{3}$	1	1	0.00	0.00	∞
Integration Time	1.4	R	$\sqrt{3}$	1	1	0.81	0.81	∞
RF ambient Conditions - Noise	3.0	R	$\sqrt{3}$	1	1	1.73	1.73	∞
RF ambient Conditions - Reflections	3.0	R	$\sqrt{3}$	1	1	1.73	1.73	∞
Probe positioner Mechanical Tolerance	1.4	R	$\sqrt{3}$	1	1	0.81	0.81	∞
Probe positioning with respect to Phantom Shell	1.4	R	$\sqrt{3}$	1	1	0.81	0.81	∞
Extrapolation, interpolation and integration Algorithms for Max. SAR Evaluation	2.3	R	$\sqrt{3}$	1	1	1.33	1.33	∞
Test sample Related								
Test sample positioning	2.6	N	1	1	1	2.60	2.60	N-1
Device Holder Uncertainty	3.0	N	1	1	1	3.00	3.00	N-1
Output power Variation - SAR drift measurement	5.0	R	$\sqrt{3}$	1	1	2.89	2.89	∞
SAR scaling	2.0	R	$\sqrt{3}$	1	1	1.15	1.15	∞
Phantom and Tissue Parameters								
Phantom Uncertainty (Shape and thickness tolerances)	4.0	R	$\sqrt{3}$	1	1	2.31	2.31	∞
SAR correction for deviation(in permittivity and conductivity)	2.0	N	1	1	0.84	2.00	1.68	∞
Liquid conductivity (temperature uncertainty)	2.5	R	$\sqrt{3}$	0.78	0.71	1.13	1.03	∞
Liquid conductivity - measurement uncertainty	5.0	N	1	0.78	0.71	3.90	3.55	M
Liquid permittivity (temperature uncertainty)	2.5	R	$\sqrt{3}$	0.23	0.26	0.33	0.38	∞
Liquid permittivity - measurement uncertainty	5.0	N	1	0.23	0.26	1.15	1.30	M
Combined Standard Uncertainty	-	RSS	-	-	-	10.72	10.56	-

Expanded Uncertainty (95% Confidence interval)	-	k	-	21.45	21.11	-
---	---	---	---	-------	-------	---

3.4.2 Measurement uncertainty evaluation for system check

This measurement uncertainty budget is suggested by IEEE 1528. The break down of the individual uncertainties is as follows:

Uncertainty Component	Tol (+-%)	Prob. Dist.	Div.	Ci (1g)	Ci (10g)	1g Ui (+-%)	10g Ui (+-%)	V _i
Measurement System								
Probe calibration	5.8	N	1	1	1	5.80	5.30	∞
Axial Isotropy	3.5	R	$\sqrt{3}$	1	1	2.02	2.02	∞
Hemispherical Isotropy	5.9	R	$\sqrt{3}$	0	0	0.00	0.00	∞
Boundary effect	1.0	R	$\sqrt{3}$	1	1	0.58	0.56	∞
Probe Linearity	4.7	R	$\sqrt{3}$	1	1	2.71	2.71	∞
System detection limits	1.0	R	$\sqrt{3}$	1	1	0.58	0.58	∞
Modulation response	0.0	R	$\sqrt{3}$	1	1	0.00	0.00	∞
Readout Electronics	0.5	N	1	1	1	0.50	0.50	∞
Response Time	0.0	R	$\sqrt{3}$	1	1	0.00	0.00	∞
Integration Time	1.4	R	$\sqrt{3}$	0	0	0.00	0.00	∞
RF ambient Conditions - Noise	3.0	R	$\sqrt{3}$	1	1	1.73	1.73	∞
RF ambient Conditions - Reflections	3.0	R	$\sqrt{3}$	1	1	1.73	1.73	∞
Probe positioner Mechanical Tolerance	1.4	R	$\sqrt{3}$	1	1	0.81	0.81	∞
Probe positioning with respect to Phantom Shell	1.4	R	$\sqrt{3}$	1	1	0.81	0.81	∞
Extrapolation, interpolation and integration Algorithms for Max. SAR Evaluation	2.3	R	$\sqrt{3}$	1	1	1.33	1.33	∞
Dipole								
Deviation of experimental dipole	5.5	N	1	1	1	5.00	5.00	∞
Dipole axis to liquid distance	2.0	R	$\sqrt{3}$	1	1	1.15	1.15	∞
Power drift	0.5	R	$\sqrt{3}$	1	1	0.29	0.29	∞
Phantom and Tissue Parameters								
Phantom Uncertainty (Shape and thickness tolerances)	4.0	R	$\sqrt{3}$	1	1	2.31	2.31	∞
SAR correction for deviation(in permittivity and conductivity)	2.0	N	1	1	0.84	2.00	1.68	∞
Liquid conductivity (temperature uncertainty)	2.5	R	$\sqrt{3}$	0.78	0.71	1.13	1.02	∞
Liquid conductivity - measurement uncertainty	5.0	N	1	0.78	0.71	3.90	3.55	M
Liquid permittivity (temperature uncertainty)	2.5	R	$\sqrt{3}$	0.23	0.26	0.33	0.38	∞
Liquid permittivity - measurement uncertainty	5.0	N	1	0.23	0.26	1.15	1.30	M
Combined Standard Uncertainty	-	RSS	-	-	-	10.43	10.25	-
Expanded Uncertainty (95% Confidence interval)	-	k	-	-	-	20.86	20.51	-

4 MEASUREMENT SYSTEM

4.1 Definition of Specific Absorption Rate (SAR)

SAR is related to the rate at which energy is absorbed per unit mass in an object exposed to a radio field. The SAR distribution in a biological body is complicated and is usually carried out by experimental techniques or numerical modeling. The standard recommends limits for two tiers of groups, occupational/controlled and general population/uncontrolled, based on a person's awareness and ability to exercise control over his or her exposure. In general, occupational / controlled exposure limits are higher than the limits for general population /uncontrolled.

The SAR definition is the time derivative (rate) of the incremental energy (dW) absorbed by (dissipated in) an incremental mass (dm) contained in a volume element (dv) of a given density (ρ). The equation description is as below:

$$\mathbf{SAR} = \frac{d}{dt} \left(\frac{dW}{dm} \right) = \frac{d}{dt} \left(\frac{dW}{\rho dv} \right)$$

SAR is expressed in units of Watts per kilogram (W/kg) SAR measurement can be related to the electrical field in the tissue by

$$\mathbf{SAR} = \frac{\sigma E^2}{\rho}$$

Where: σ is the conductivity of the tissue,

ρ is the mass density of the tissue and E is the RMS electrical field strength.

4.2 SATIMO SAR System

4.2.1 SATIMO SAR System Diagram

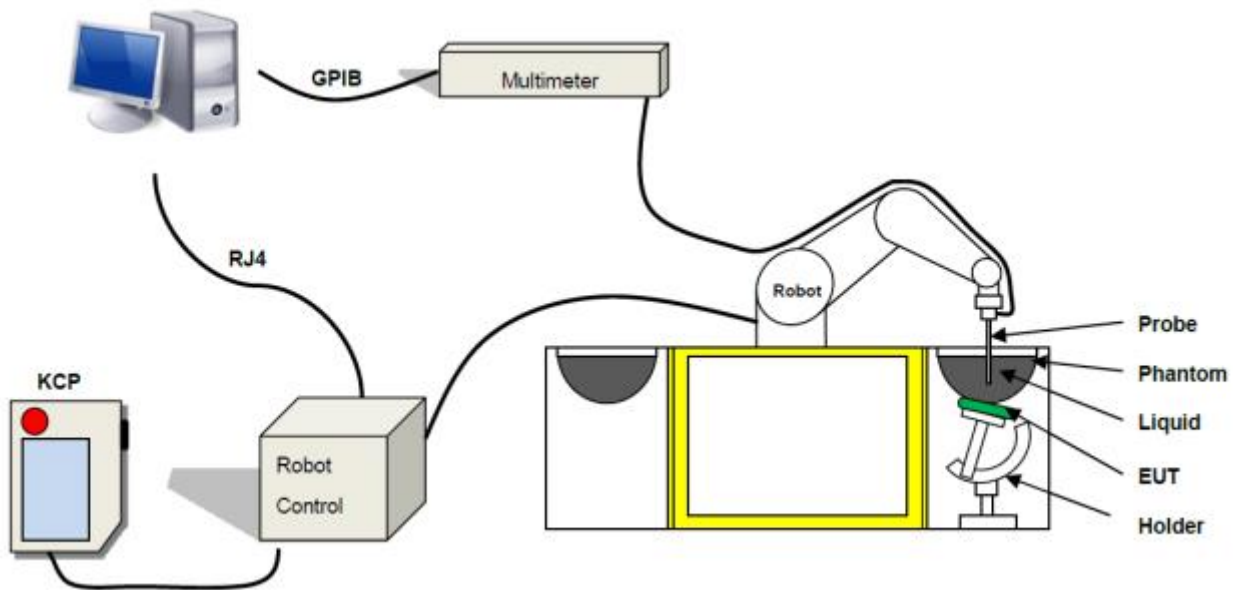

These measurements were performed with the automated near-field scanning system OPENSAR from SATIMO. The system is based on a high precision robot (working range: 850 mm), which positions the probes with a positional repeatability of better than ± 0.02 mm. Special E- and H-field probes have been developed for measurements close to material discontinuity, the sensors of which are directly loaded with a Schottky diode and connected via highly resistive lines to the data acquisition unit.

The SAR measurements were conducted with dosimetric probe (manufactured by SATIMO), designed in the classical triangular configuration and optimized for dosimetric evaluation. The probe has been calibrated according to the procedure described in SAR standard with accuracy of better than $\pm 10\%$. The spherical isotropy was evaluated with the procedure described in SAR standard and found to be better than ± 0.25 dB. The phantom used was the SAM Phantom as described in FCC supplement C, IEEE P1528.

4.2.2 Robot

The SATIMO SAR system uses the high precision robots from KUKA. For the 6-axis controller system, the robot controller version (KUKA) from KUKA is used. The KUKA robot series have many features that are important for our application:



- High precision (repeatability ± 0.035 mm)
- High reliability (industrial design)
- Jerk-free straight movements
- Low ELF interference (the closed metallic construction shields against motor control fields)

4.2.3 E-Field Probe

For the measurements the Specific Dosimetric E-Field Probe SN 39/21 EPGO 359 with following specifications is used

- Dynamic range: 0.01-100 W/kg
- Tip Diameter : 2.5 mm
- Lower detection limit : 10 mW/kg
(repeatability better than +/- 1mm)
- Probe linearity: +/- 0.07 dB
- Calibration range: 300 MHz to 6000 MHz for head & body simulating liquid.

Angle between probe axis (evaluation axis) and surface normal line: less than 30°



E-Field Probe Calibration Process

Probe calibration is realized, in compliance with CENELEC EN 62209-1/-2 and IEEE 1528 std, with CALISAR, Antennessa proprietary calibration system. The calibration is performed with the IEC62209-1/2 annexe technique using reference guide at the five frequencies.

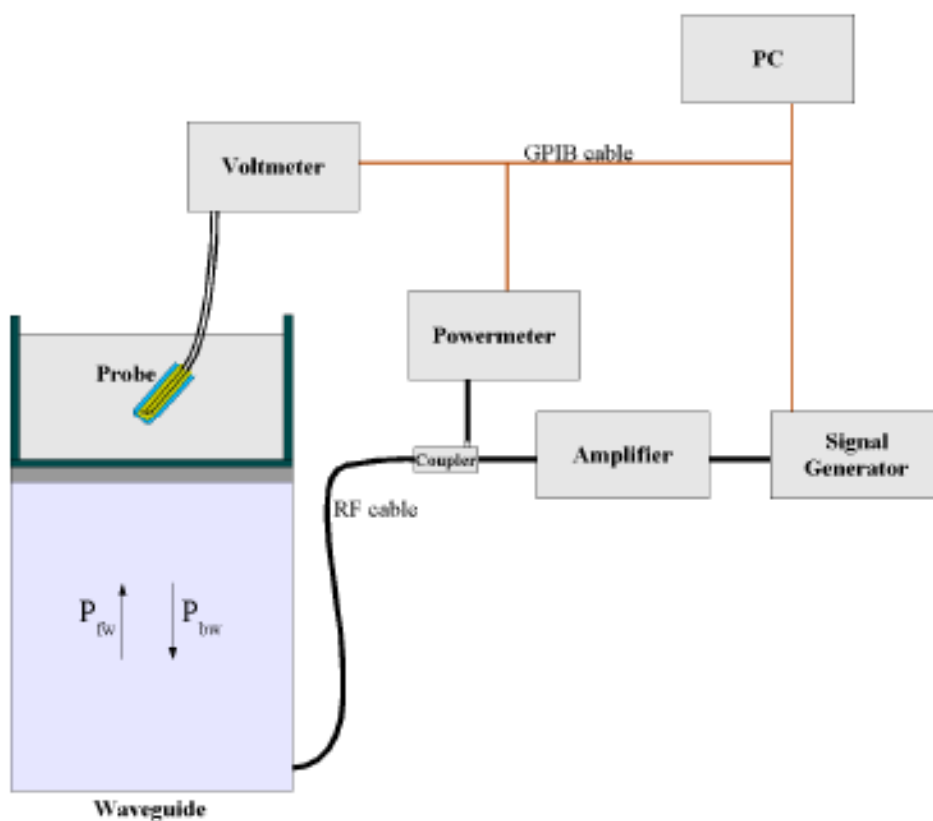

$$SAR = \frac{4(P_{fw} - P_{bw})}{ab\sigma} \cos^2 \left(\pi \frac{y}{a} \right) c^{(2\pi/\sigma)}$$

Where :

- Pfw = Forward Power
- Pbw = Backward Power
- a and b = Waveguide Dimensions
- δ = Skin Depth

Keithley configuration

Rate = Medium; Filter =ON; RDGS=10; FILTER TYPE =MOVING AVERAGE; RANGE AUTO After each calibration, a SAR measurement is performed on a validation dipole and compared with a NPL calibrated probe, to verify it.

The calibration factors, CF(N), for the 3 sensors corresponding to dipole 1, dipole 2 and dipole 3 are:

$$CF(N)=SAR(N)/V_{lin}(N) \quad (N=1,2,3)$$

The linearised output voltage $V_{lin}(N)$ is obtained from the displayed output voltage $V(N)$ using

$$V_{lin}(N)=V(N)*(1+V(N)/DCP(N)) \quad (N=1,2,3)$$

Where the DCP is the diode compression point in mV.

4.2.4 Phantoms

For the measurements the Specific Anthropomorphic Mannequin (SAM) defined by the IEEE SCC-34/SC2 group is used. The phantom is a polyurethane shell integrated in a wooden table. The thickness of the phantom amounts to 2mm +/- 0.2mm. It enables the dosimetric evaluation of left and right phone usage and includes an additional flat phantom part for the simplified performance check. The phantom set-up includes a cover, which prevents the evaporation of the liquid.

Photo of Phantom SN 30/13 SAM103



Photo of Phantom SN 30/13 SAM104



Serial Number	Positionner Material	Permittivity	Loss Tangent
SN 30/13 SAM103	Gelcoat with fiberglass	3.4	0.02
SN 30/13 SAM104	Gelcoat with fiberglass	3.4	0.02

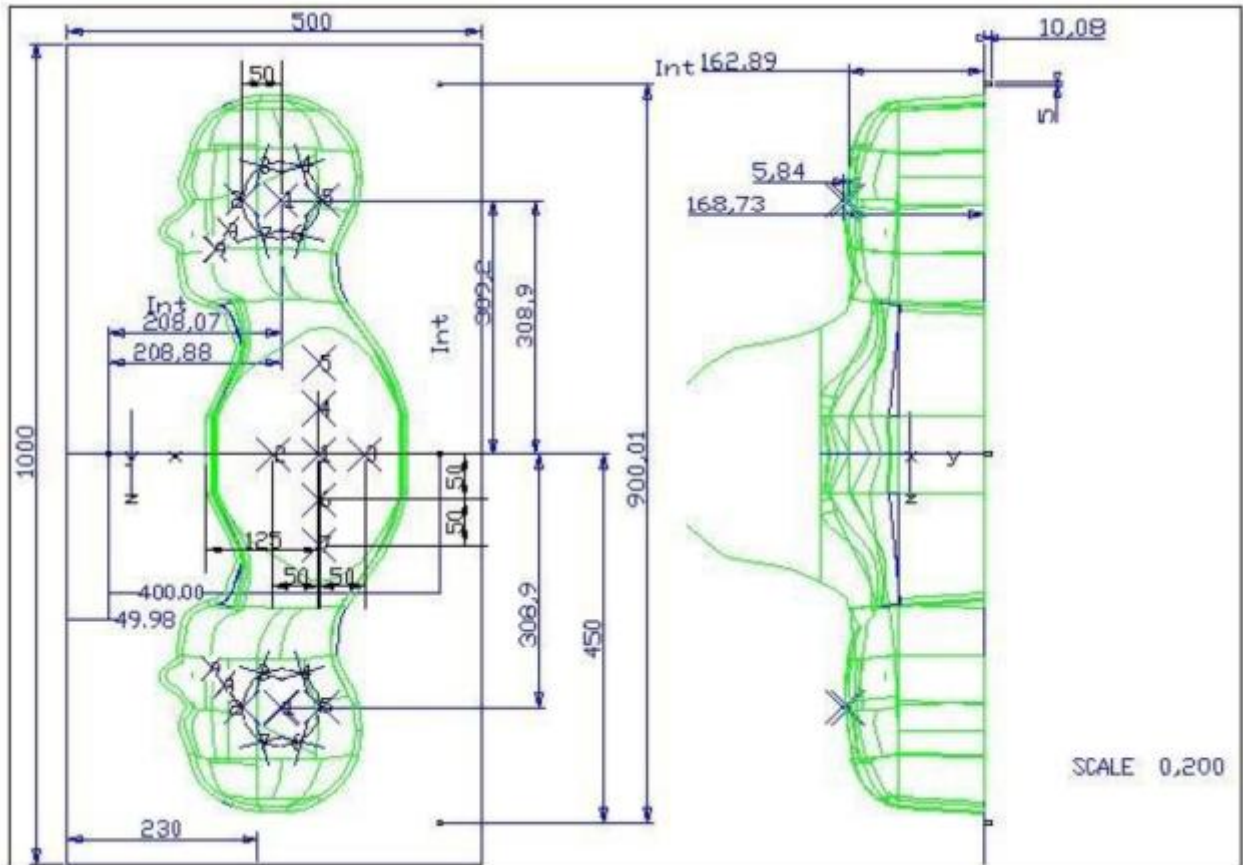

Serial Number	Left Head		Right Head		Flat Part	
SN 30/13 SAM103	2	2.00	2	2.03	1	2.09
	3	2.02	3	2.05	2	2.10
	4	2.04	4	2.04	3	2.09
	5	2.04	5	2.07	4	2.11
	6	2.02	6	2.07	5	2.11
	7	2.01	7	2.09	6	2.09
	8	2.04	8	2.10	7	2.11
	9	2.02	9	2.09	-	-
	SN 30/13 SAM104	2	2.05	2	2.06	1
3		2.08	3	2.03	2	2.03
4		2.05	4	2.03	3	2.01
5		2.06	5	2.02	4	2.03
6		2.08	6	2.02	5	2.03
7		2.06	7	2.04	6	2.00
8		2.07	8	2.04	7	1.98
9		2.07	9	2.05	-	-

4.2.5 Device Holder

The SAR in the phantom is approximately inversely proportional to the square of the distance between the source and the liquid surface. For a source at 5 mm distance, a positioning uncertainty of ± 0.5 mm would produce a SAR uncertainty of ± 20 %. Accurate device positioning is therefore crucial for accurate and repeatable measurements. The positions in which the devices must be measured are defined by the standards.



Serial Number	Holder Material	Permittivity	Loss Tangent
SN 25/13 MSH87	Deirin	3.7	0.005
SN 25/13 MSH88	Deirin	3.7	0.005

The positioning system allows obtaining cheek and tilting position with a very good accuracy. In compliance with CENELEC, the tilt angle uncertainty is lower than 1° .

4.2.6 Simulating Liquid

For SAR measurement of the field distribution inside the phantom, the phantom must be filled with homogeneous tissue simulating liquid to a depth of at least 15 cm. For head SAR testing, the liquid height from the ear reference point (ERP) of the phantom to the liquid top surface is larger than 15 cm. For body SAR testing, the liquid height from the center of the flat phantom to the liquid top surface is larger than 15 cm. The nominal dielectric values of the tissue simulating liquids in the phantom and the tolerance of 5%.

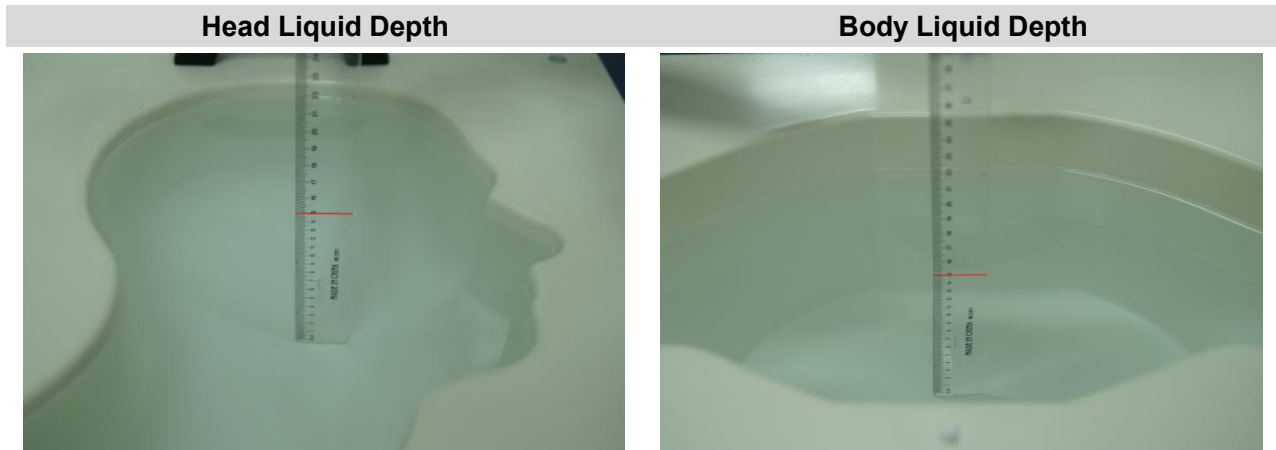

The following table gives the recipes for tissue simulating liquid and the theoretical Conductivity/Permittivity.

Head (Reference IEEE1528)								
Frequency (MHz)	Water (%)	Sugar (%)	Cellulose (%)	Salt (%)	Preventol (%)	DGBE (%)	Conductivity σ (S/m)	Permittivity ϵ
750	41.1	57.0	0.2	1.4	0.2	0	0.89	41.9
835	40.3	57.9	0.2	1.4	0.2	0	0.90	41.5
900	40.3	57.9	0.2	1.4	0.2	0	0.97	41.5
1800, 1900, 2000	55.2	0	0	0.3	0	44.5	1.4	40.0
2450	55.0	0	0	0.1	0	44.9	1.80	39.2
2600	54.9	0	0	0.1	0	45.0	1.96	39.0
Frequency(MHz)	Water (%)	Hexyl Carbitol (%)			Triton X-100 (%)		Conductivity σ (S/m)	Permittivity ϵ
5200	62.52	17.24			17.24		4.66	36.0
5800	62.52	17.24			17.24		5.27	35.3
Body (From instrument manufacturer)								
Frequency (MHz)	Water (%)	Sugar (%)	Cellulose (%)	Salt (%)	Preventol (%)	DGBE (%)	Conductivity σ (S/m)	Permittivity ϵ
750	51.7	47.2	0	0.9	0.1	0	0.96	55.5
835	50.8	48.2	0	0.9	0.1	0	0.97	55.2
900	50.8	48.2	0	0.9	0.1	0	1.05	55.0
1800, 1900, 2000	70.2	0	0	0.4	0	29.4	1.52	53.3
2450	68.6	0	0	0.1	0	31.3	1.95	52.7
2600	68.2	0	0	0.1	0	31.7	2.16	52.5

Frequency(MHz)	Water	DGBE (%)	Salt (%)	Conductivity σ (S/m)	Permittivity ϵ
5200	78.60	21.40	/	5.54	47.86
5800	78.50	21.40	0.1	6.0	48.20

5 MEASUREMENT PROCEDURE

5.1 Antenna Port Test Requirement

The SATIMO SAR system is equipped with one or more system validation kits. These units together with the predefined measurement procedures within the SATIMO software enable the user to conduct the system performance check and system validation. System validation kit includes a dipole, tripod holder to fix it underneath the flat phantom and a corresponding distance holder.

5.2 Purpose of System Check

The system performance check verifies that the system operates within its specifications. System and operator errors can be detected and corrected. It is recommended that the system performance check be performed prior to any usage of the system in order to guarantee reproducible results. The system performance check uses normal SAR measurements in a simplified setup with a well characterized source. This setup was selected to give a high sensitivity to all parameters that might fail or vary over time. The system check does not intend to replace the calibration of the components, but indicates situations where the system uncertainty is exceeded due to drift or failure.

5.3 System Check Setup

In the simplified setup for system evaluation, the EUT is replaced by a calibrated dipole and the power source is replaced by a continuous wave that comes from a signal generator. The calibrated dipole must be placed beneath the flat phantom section of the SAM twin phantom with the correct distance holder. The distance holder should touch the phantom surface with a light pressure at the reference marking and be oriented parallel to the long side of the phantom. The equipment setup is shown below:

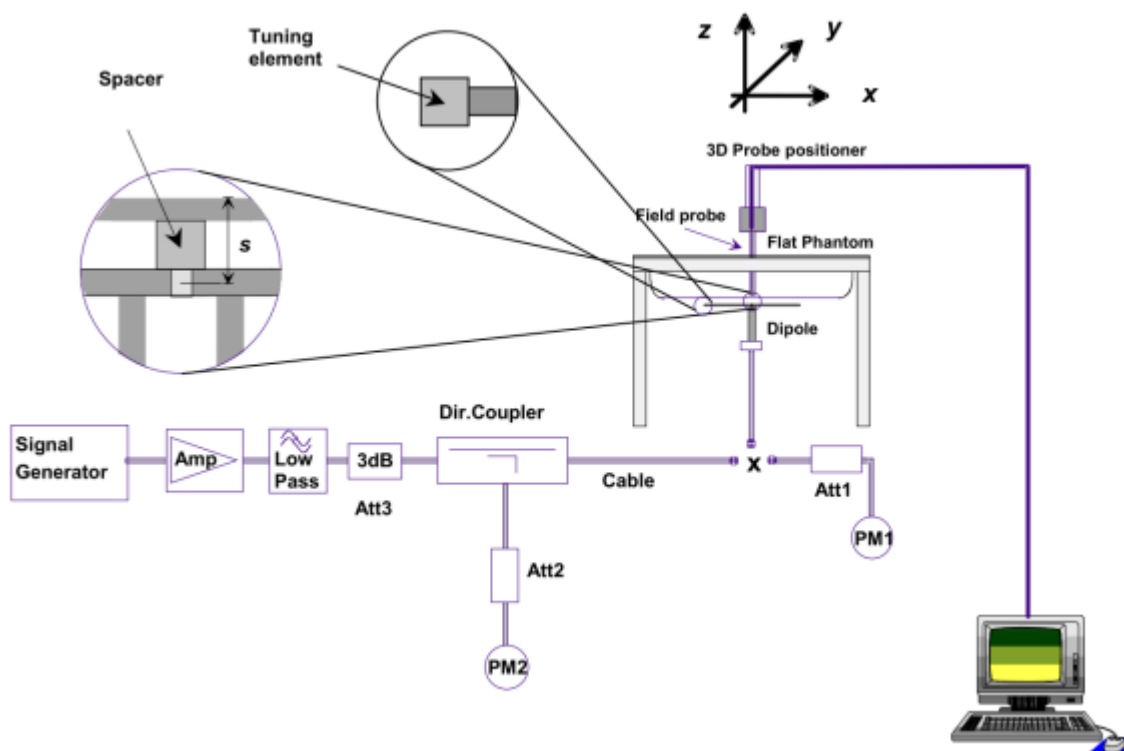

6 EUT TEST POSITION CONFIGURATIONS

According to KDB 648474 D04 Handset , handsets are tested for SAR compliance in head, body-worn accessory and other use configurations described in the following subsections.

6.1 Body Exposure Condition

For Close to Body mode(1g Body SAR) the EUT is set 10mm away from the phantom, the test distance is 10mm.

6.2 Extremity Exposure Condition

For Hand-held mode (10g Extremity SAR) the EUT (Equipment Under Test) is set directly against the phantom, the test distance is 0mm.

7 SAR MEASUREMENT PROCEDURES

7.1 SAR Measurement Process Diagram

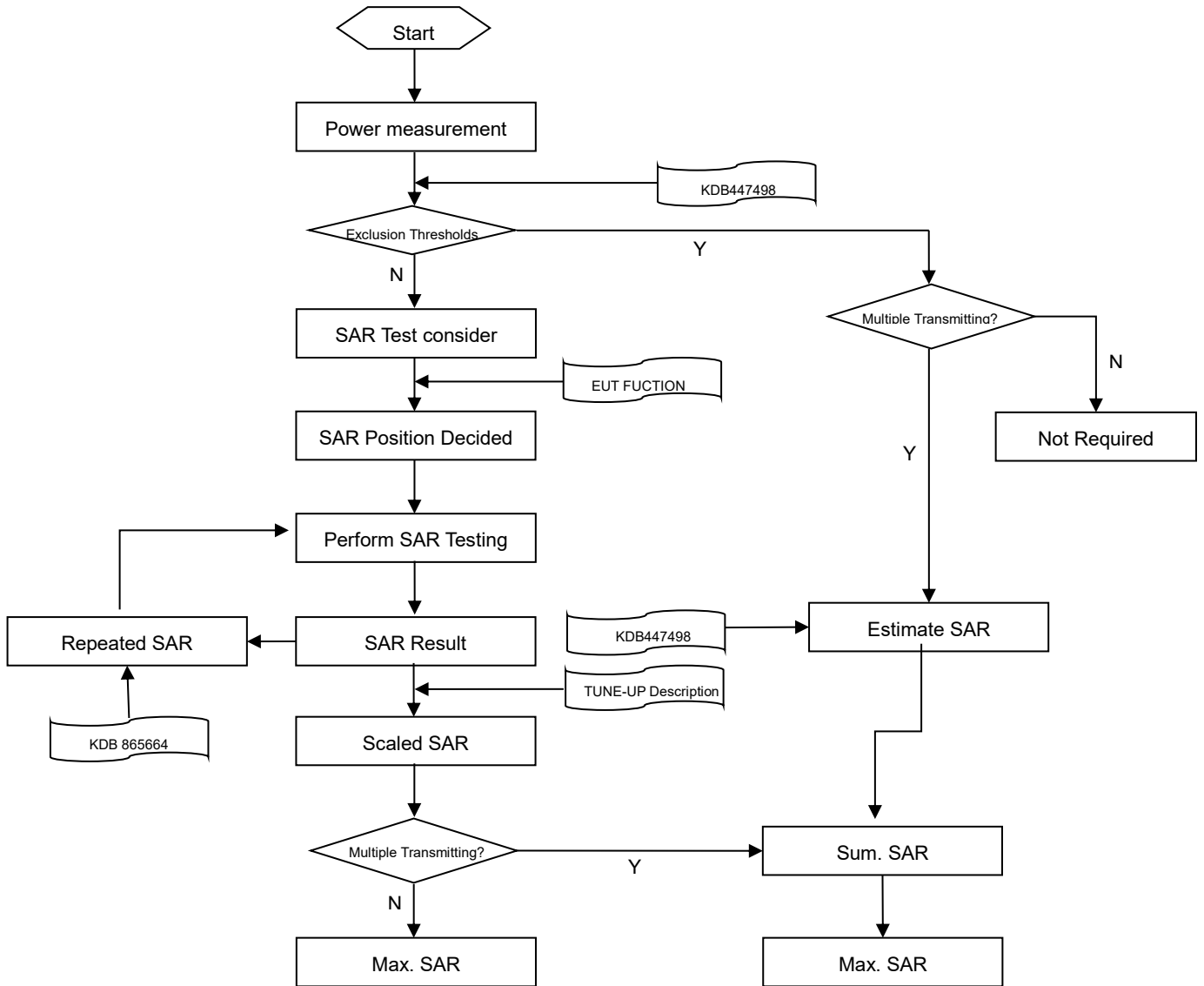

7.2 SAR Scan General Requirements

Probe boundary effect error compensation is required for measurements with the probe tip closer than half a probe tip diameter to the phantom surface. Both the probe tip diameter and sensor offset distance must satisfy measurement protocols; to ensure probe boundary effect errors are minimized and the higher fields closest to the phantom surface can be correctly measured and extrapolated to the phantom surface for computing 1-g SAR. Tolerances of the post-processing algorithms must be verified by the test laboratory for the scan resolutions used in the SAR measurements, according to the reference distribution functions specified in IEEE Std 1528-2013.

			≤3GHz	>3GHz
Maximum distance from closest measurement point (geometric center of probe sensors) to phantom surface			5±1 mm	$\frac{1}{2} \cdot \delta \cdot \ln(2) \pm 0.5$ mm
Maximum probe angle from probe axis to phantom surface normal at the measurement location			30°±1°	20°±1°
Maximum area scan spatial resolution: Δx Area , Δy Area			≤ 2 GHz: ≤ 15 mm 2 – 3 GHz: ≤ 12 mm	3–4 GHz: ≤ 12 mm 4 – 6 GHz: ≤ 10 mm
			When the x or y dimension of the test device, in the measurement plane orientation, is smaller than the above, the measurement resolution must be ≤ the corresponding x or y dimension of the test device with at least one measurement point on the test device.	
Maximum zoom scan spatial resolution: Δx Zoom , Δy Zoom			≤ 2 GHz: ≤ 8 mm 2 – 3 GHz: ≤ 5 mm*	3–4 GHz: ≤ 5 mm* 4 – 6 GHz: ≤ 4 mm*
Maximum zoom scan spatial resolution, normal to phantom surface	uniform grid: Δz Zoom (n)		≤ 5 mm	3–4 GHz: ≤ 4 mm
				4–5 GHz: ≤ 3 mm
				5–6 GHz: ≤ 2 mm
	graded grid	Δz Zoom (1): between 1st two points closest to phantom surface	≤ 4 mm	3–4 GHz: ≤ 3 mm
Δz Zoom (n>1): between subsequent points		4–5 GHz: ≤ 2.5 mm		
			5–6 GHz: ≤ 2 mm	
Minimum zoom scan volume	x, y, z		≥30 mm	3–4 GHz: ≥ 28 mm
				4–5 GHz: ≥ 25 mm
				5–6 GHz: ≥ 22 mm
Note: <ol style="list-style-type: none"> δ is the penetration depth of a plane-wave at normal incidence to the tissue medium; see draft standard IEEE P1528-2011 for details. * When zoom scan is required and the reported SAR from the area scan based 1-g SAR estimation procedures of KDB 447498 is ≤ 1.4 W/kg, ≤ 8 mm, ≤ 7 mm and ≤ 5 mm zoom scan resolution may be applied, respectively, for 2 GHz to 3GHz, 3 GHz to 4 GHz and 4 GHz to 6 GHz. 				

7.3 SAR Measurement Procedure

The following steps are used for each test position

- Establish a call with the maximum output power with a base station simulator. The connection between the mobile and the base station simulator is established via air interface
- Measurement of the local E-field value at a fixed location. This value serves as a reference value for calculating a possible power drift.
- Measurement of the SAR distribution with a grid of 8 to 16mm * 8 to 16 mm and a constant distance to the inner surface of the phantom. Since the sensors cannot directly measure at the inner phantom surface, the values between the sensors and the inner phantom surface are extrapolated. With these values the area of the maximum SAR is calculated by an interpolation scheme.
- Around this point, a cube of 30 * 30 * 30 mm or 32 * 32 * 32 mm is assessed by measuring 5 or 8 * 5 or 8*4 or 5 mm. With these data, the peak spatial-average SAR value can be calculated.

7.4 Area & Zoom Scan Procedures

First Area Scan is used to locate the approximate location(s) of the local peak SAR value(s). The measurement grid within an Area Scan is defined by the grid extent, grid step size and grid offset. Next, in order to determine the EM field distribution in a three-dimensional spatial extension, Zoom Scan is required. The Zoom Scan is performed around the highest E-field value to determine the averaged SAR-distribution over 10 g. Area scan and zoom scan resolution setting follows KDB 865664 D01 quoted below.

When the 1-g SAR of the highest peak is within 2 dB of the SAR limit, additional zoom scans are required for other peaks within 2 dB of the highest peak that have not been included in any zoom scan to ensure there is no increase in SAR.

8 CONDUCTED RF OUTPUT POWER

8.1 WIFI

8.1.1 2.4G ISM Band

Band (GHz)	Mode	Channel	Freq. (MHz)	Conducted Power (dBm)	Tune-up Power Limit (dBm)	SAR Test Require.
2.4 (2.4~2.483)	OFDM	Low	2405	17.04	17.50	Yes
		Mid.	2441	16.40	17.50	Yes
		High	2473	16.25	17.50	Yes

8.1.2 2.4G WLAN

Band (GHz)	Mode	Channel	Freq. (MHz)	Conducted Power (dBm)	Tune-up Power Limit (dBm)	SAR Test Require.
2.4 (2.4~2.483)	802.11b	1	2412	15.64	16.00	Yes
		6	2437	15.75	16.00	Yes
		11	2462	15.56	16.00	Yes
	802.11g	1	2412	15.41	15.50	No
		6	2437	15.27	15.50	No
		11	2462	15.12	15.50	No
	802.11n(HT20)	1	2412	14.28	15.00	No
		6	2437	13.97	15.00	No
		11	2462	14.84	15.00	No

Note: According KDB 248227 D01 SAR is not required for the following 2.4 GHz OFDM conditions. When the highest reported SAR for DSSS is adjusted by the ratio of OFDM to DSSS specified maximum output power and the adjusted SAR is ≤ 1.2 W/kg.

Adjusted SAR = Report SAR * (max power (OFDM)/ max power (DSSS)) = 0.125 * (35.48mW/39.81mW) = 0.111 W/Kg, so the 2.4G OFDM SAR test is not required.

8.1.3 5.8G ISM Band

Band (GHz)	Mode	Channel	Freq. (MHz)	Conducted Power (dBm)	Tune-up Power Limit (dBm)	SAR Test Require.
5 (5.745~5.825)	OFDM	Low	5745	10.75	12.00	Yes
		Mid.	5785	10.98	12.00	Yes
		High	5825	11.72	12.00	Yes

8.1.4 5G WLAN

Band (GHz)	Mode	Channel	Freq. (MHz)	Conducted Power (dBm)	Tune-up Limit (dBm)	SAR Test Require.
5.2 (5.15~5.25)	802.11a	36	5180	13.40	13.50	No
		44	5220	13.41	13.50	No
		48	5240	13.38	13.50	No
	802.11n(HT20)	36	5180	12.86	13.00	No
		44	5220	12.75	13.00	No
		48	5240	12.66	13.00	No
	802.11n(HT40)	38	5190	12.69	13.00	No
		46	5230	12.58	13.00	No
	802.11ac(VHT20)	36	5180	12.36	13.00	No
		44	5220	12.51	13.00	No
		48	5240	12.42	13.00	No
	802.11ac(VHT40)	38	5190	12.52	13.00	No
		46	5230	12.44	13.00	No
	802.11ac(VHT80)	42	5210	10.48	11.00	No
5.3 (5.25~5.35)	802.11a	52	5260	13.35	13.50	Yes
		60	5300	13.22	13.50	Yes
		64	5320	13.43	13.50	Yes
	802.11n(HT20)	52	5260	12.83	13.00	No
		60	5300	12.86	13.00	No
		64	5320	12.96	13.00	No
	802.11n(HT40)	54	5270	12.65	13.00	No
		62	5310	12.54	13.00	No
	802.11ac(VHT20)	52	5260	12.55	13.00	No
		60	5300	12.41	13.00	No
		64	5320	12.73	13.00	No
	802.11ac(VHT40)	54	5270	12.67	13.00	No
		62	5310	12.43	13.00	No
	802.11ac(VHT80)	58	5290	10.51	11.00	No
5.6 (5.47~5.725)	802.11a	100	5500	13.42	13.50	Yes
		116	5580	13.36	13.50	Yes
		140	5700	13.42	13.50	Yes
	802.11n(HT20)	100	5500	12.87	13.00	No
		116	5580	12.83	13.00	No
		140	5700	12.96	13.00	No
	802.11n(HT40)	102	5510	12.69	13.00	No
		118	5590	12.65	13.00	No

	802.11ac(VHT20)	134	5670	12.55	13.00	No	
		100	5500	12.38	13.00	No	
		116	5580	12.54	13.00	No	
		140	5700	12.72	13.00	No	
	802.11ac(VHT40)	102	5510	12.51	13.00	No	
		118	5590	12.62	13.00	No	
		134	5670	12.43	13.00	No	
	802.11ac(VHT80)	106	5530	10.47	11.00	No	
		122	5610	10.50	11.00	No	
		138	5690	10.33	11.00	No	
	5.8 (5.725~5.850)	802.11a	149	5745	13.38	13.50	Yes
			157	5785	13.32	13.50	Yes
165			5825	13.38	13.50	Yes	
802.11n(HT20)		149	5745	12.82	13.00	No	
		157	5785	12.79	13.00	No	
		165	5825	12.93	13.00	No	
802.11n(HT40)		151	5755	12.64	13.00	No	
		159	5795	12.62	13.00	No	
802.11ac(VHT20)		149	5745	12.51	13.00	No	
		157	5785	12.34	13.00	No	
		165	5825	12.50	13.00	No	
802.11ac(VHT40)		151	5755	12.69	13.00	No	
		159	5795	12.55	13.00	No	
802.11ac(VHT80)		155	5775	10.42	11.00	No	

Note: When the same maximum output power is specified for both bands, begin SAR measurement in U-NII-2A band by applying the OFDM SAR requirements. If the highest reported SAR for a test configuration is ≤ 1.2 W/kg, SAR is not required for U-NII-1 band for that configuration (802.11 mode and exposure condition); otherwise, each band is tested independently for SAR.

8.1.5 Bluetooth

Mode	GFSK			$\pi/4$ -DQPSK		
Channel	0	39	78	0	39	78
Frequency (MHz)	2402	2441	2480	2402	2441	2480
Conducted Power (dBm)	8.32	8.41	7.51	8.02	7.23	6.74
Tune-Up Limit (dBm)	8.50			8.50		
Mode	8-DPSK			BLE		
Channel	0	39	78	0	19	39
Frequency (MHz)	2402	2441	2480	2402	2440	2480
Conducted Power (dBm)	8.11	7.21	6.67	8.21	8.22	7.14
Tune-Up Limit (dBm)	8.50			8.50		

9 EUT ANTENNA LOCATION SKETCH

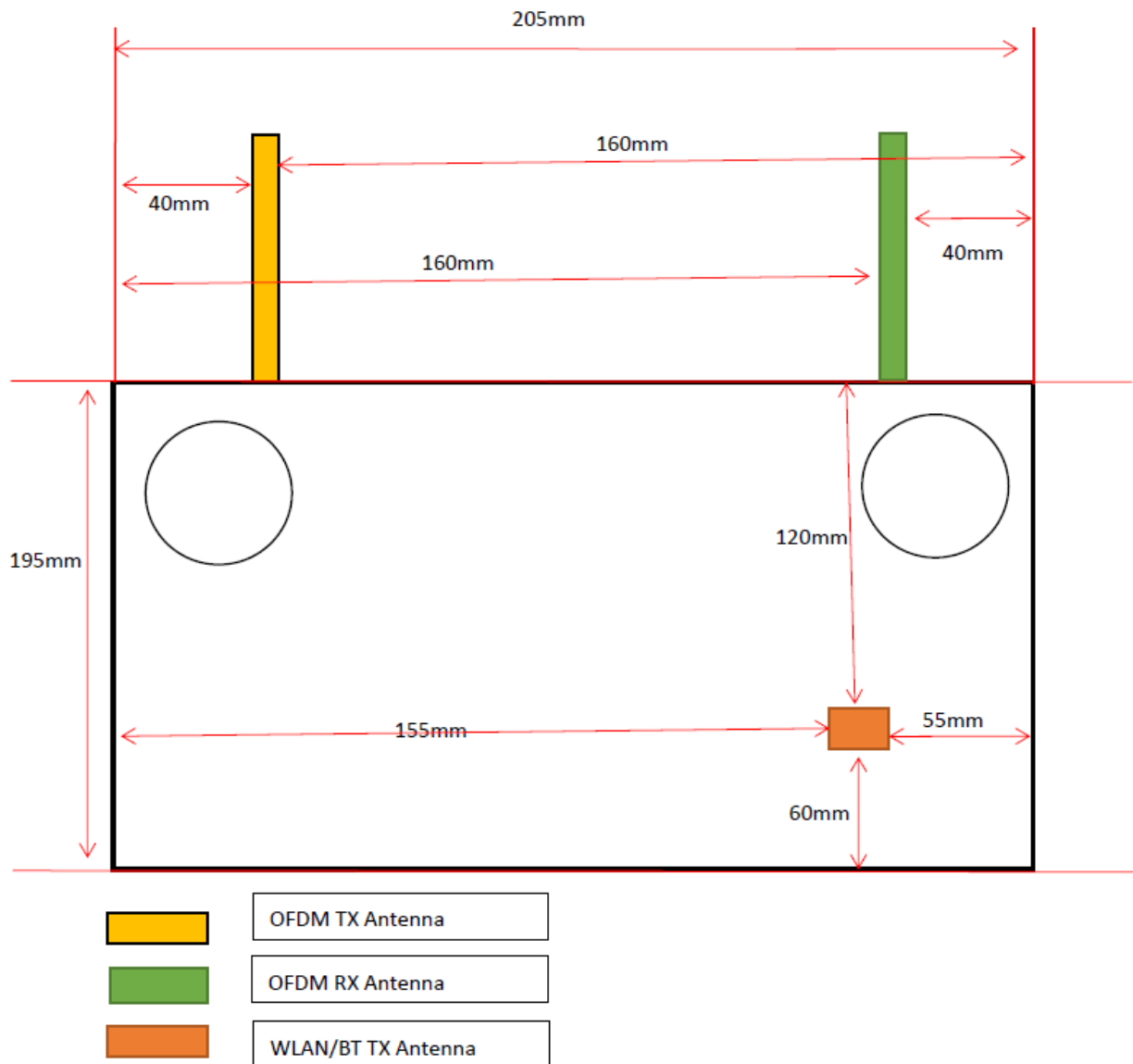

<EUT Front View>

9.1 SAR Test Exclusion Consideration Table

According with FCC KDB 447498 D04, Appendix B, The SAR-based exemption formula applies for single fixed, mobile, and portable RF sources with available maximum time-averaged power or effective radiated power (ERP), whichever is greater, of less than or equal to the threshold Pth (mW).

Band	Mode	Max. Peak Power		Test Position Configurations					
		dBm	mW	Front	Back	Left Edge	Right Edge	Top Edge	Bottom Edge
2.4G ISM Band	Distance to User			<5mm	<5mm	40mm	160mm	<5mm	195mm
	OFDM	17.50	56.23	Yes	Yes	No	No	Yes	No
2.4G WLAN	Distance to User			10mm	40mm	155mm	55mm	120mm	60mm
	802.11b	16.00	39.81	Yes	No	No	No	No	No
5.8G ISM Band	Distance to User			<5mm	<5mm	40mm	160mm	<5mm	195mm
	OFDM	12.00	15.85	Yes	Yes	No	No	Yes	No
5.2G&5.3G WLAN	Distance to User			10mm	40mm	155mm	55mm	120mm	60mm
	802.11a	13.50	22.39	Yes	No	No	No	No	No
5.6G WLAN	Distance to User			10mm	40mm	155mm	55mm	120mm	60mm
	802.11a	13.50	22.39	Yes	No	No	No	No	No
5.8G WLAN	Distance to User			10mm	40mm	155mm	55mm	120mm	60mm
	802.11a	13.50	22.39	Yes	No	No	No	No	No
Bluetooth	Distance to User			10mm	40mm	155mm	55mm	120mm	60mm
	BT	8.50	7.08	No	No	No	No	No	No

Note:

- Maximum power is the source-based time-average power and represents the maximum RF output power including tune-up tolerance among production units
- Per KDB 447498 D04, for larger devices, the test separation distance of adjacent edge configuration is determined by the closest separation between the antenna and the user.
- Per KDB 447498 D04, standalone SAR test exclusion threshold is applied; If the distance of the antenna to the user is < 5mm, 5mm is used to determine SAR exclusion threshold.
- Per KDB 447498 D04, for separation distances from 0.5 cm to 40 cm and at frequencies from 0.3 GHz to 6 GHz (inclusive), the threshold Pth (mW) is given by Following:

$$P_{th}(mW) = \begin{cases} ERP_{20cm}(d/20cm)^x & d \leq 20cm \\ ERP_{20cm} & 20cm < d \leq 40cm \end{cases}$$

where

$$x = -\log_{10} \left(\frac{60}{ERP_{20cm}\sqrt{f}} \right)$$

- f(GHz) is the RF channel transmit frequency in GHz
- d is the separation distance (cm), The result is rounded to one decimal place for comparison
- ERP_{20cm} are determined by:

$$ERP_{20cm}(mW) = f(x) = \begin{cases} 2040f & 0.3GHz \leq f < 1.5GHz \\ 3060 & 1.5GHz \leq f \leq 6GHz \end{cases}$$

- Per KDB 248227 D01, choose the highest output power channel to test SAR and determine further SAR exclusion.8. For each frequency band, testing at higher data rates and higher order modulations is not required when the

maximum average output power for each of these configurations is less than 1/4dB higher than those measured at the lowest data rate

6. Per KDB 248227 D01 SAR is not required for the following 2.4 GHz OFDM conditions.
 - a. When KDB Publication 447498 D01 SAR test exclusion applies to the OFDM configuration.
 - b. When the highest reported SAR for DSSS is adjusted by the ratio of OFDM to DSSS specified maximum output power and the adjusted SAR is ≤ 1.2 W/kg.
7. Per KDB 248227 D01 SAR is not required for the following U-NII-1 and U-NII-2A bands conditions.
 - a. When the same maximum output power is specified for both bands, begin SAR measurement in U-NII-2A band by applying the OFDM SAR requirements. If the highest reported SAR for a test configuration is ≤ 1.2 W/kg, SAR is not required for U-NII-1 band for that configuration (802.11 mode and exposure condition); otherwise, each band is tested independently for SAR.

When different maximum output power is specified for the bands, begin SAR measurement in the band with higher specified maximum output power. The highest reported SAR for the tested configuration is adjusted by the ratio of lower to higher specified maximum output power for the two bands. When the adjusted SAR is ≤ 1.2 W/kg, SAR is not required for the band with lower maximum output power in that test configuration; otherwise, each band is tested independently for SAR.

10 TEST RESULT

10.1 2.4G ISM Band Body SAR

Mode	Mode	Antenna Status	Position	Dist. (mm)	Ch.	Freq. (MHz)	Power Drift (%)	1g Meas SAR (W/kg)	Meas. Power (dBm)	Max. tune-up power (dBm)	Scaling Factor	Duty cycle (%)	Duty cycle Factor	1g Scaled SAR (W/kg)	Meas. No.
Body															
OFDM	Ground	Horizontal	Front Side	10	Low	2405	-	0.000	17.04	17.50	1.112	100	1.000	0.000	/
			Back Side	10	Low	2405	-	0.000	17.04	17.50	1.112	100	1.000	0.000	/
			Top Edge	10	Low	2405	-0.62	0.091	17.04	17.50	1.112	100	1.000	0.101	/
				10	Mid	2441	-2.11	0.097	16.40	17.50	1.288	100	1.000	0.125	1#
		Vertical	10	High	2473	3.49	0.073	16.25	17.50	1.334	100	1.000	0.097	/	
			Front Side	10	Low	2405	-	0.000	17.04	17.50	1.112	100	1.000	0.000	/
			Back Side	10	Low	2405	-0.36	0.015	17.04	17.50	1.112	100	1.000	0.017	/

Note: Refer to ANNEX C for the detailed test data for each test configuration.

10.2 2.4G ISM Band Limbs SAR

Mode	Mode	Antenna Status	Position	Dist. (mm)	Ch.	Freq. (MHz)	Power Drift (%)	10g Meas SAR (W/kg)	Meas. Power (dBm)	Max. tune-up power (dBm)	Scaling Factor	Duty cycle (%)	Duty cycle Factor	10g Scaled SAR (W/kg)	Meas. No.
Limbs															
OFDM	Ground	Horizontal	Front Side	0	Low	2405	-	0.000	17.04	17.50	1.112	100	1.000	0.000	/
			Back Side	0	Low	2405	3.54	0.014	17.04	17.50	1.112	100	1.000	0.016	/
			Top Edge	0	Low	2405	2.15	0.053	17.04	17.50	1.112	100	1.000	0.059	/
				0	Mid	2441	-4.38	0.075	16.40	17.50	1.288	100	1.000	0.097	2#
		Vertical	0	High	2473	-0.65	0.055	16.25	17.50	1.334	100	1.000	0.073	/	
			Front Side	0	Low	2405	-0.88	0.018	17.04	17.50	1.112	100	1.000	0.020	/
			Back Side	0	Low	2405	0.98	0.020	17.04	17.50	1.112	100	1.000	0.022	/

Note: Refer to ANNEX C for the detailed test data for each test configuration.

10.3 WIFI 2.4G Body SAR

Mode	Position	Dist. (mm)	Ch.	Freq. (MHz)	Power Drift (%)	1g Meas SAR (W/kg)	Meas. Power (dBm)	Max. tune-up power (dBm)	Scaling Factor	Duty cycle (%)	Duty cycle Factor	1g Scaled SAR (W/kg)	Meas. No.
Body													
802.11b	Front Side	10	6	2437	-0.62	0.008	15.75	16.00	1.059	100	1.000	0.008	3#
Note: Refer to ANNEX C for the detailed test data for each test configuration.													

10.4 WIFI 2.4G Limbs SAR

Mode	Position	Dist. (mm)	Ch.	Freq. (MHz)	Power Drift (%)	10g Meas SAR (W/kg)	Meas. Power (dBm)	Max. tune-up power (dBm)	Scaling Factor	Duty cycle (%)	Duty cycle Factor	10g Scaled SAR (W/kg)	Meas. No.
Limbs													
802.11b	Front Side	0	6	2437	-0.59	0.011	15.75	16.00	1.038	100	1.000	0.012	4#
Note: Refer to ANNEX C for the detailed test data for each test configuration.													

10.5 5.8G ISM Band Body SAR

Mode	Mode	Antenna Status	Position	Dist. (mm)	Ch.	Freq. (MHz)	Power Drift (%)	1g Meas SAR (W/kg)	Meas. Power (dBm)	Max. tune-up power (dBm)	Scaling Factor	Duty cycle (%)	Duty cycle Factor	1g Scaled SAR (W/kg)	Meas. No.
Body															
OFDM	Ground	Horizontal	Front Side	10	High	5825	-	0.000	11.72	12.00	1.067	100.00	1.000	0.000	/
			Back Side	10	High	5825	-	0.000	11.72	12.00	1.067	100.00	1.000	0.000	/
			Top Edge	10	High	5825	-1.70	0.063	11.72	12.00	1.067	100.00	1.000	0.067	5#
				10	Low	5745	-1.65	0.042	10.75	12.00	1.334	100.00	1.000	0.056	/
		Vertical	10	Mid	5785	0.35	0.045	10.98	12.00	1.265	100.00	1.000	0.057	/	
			Front Side	10	High	5825	-	0.000	11.72	12.00	1.067	100.00	1.000	0.000	/
			Back Side	10	High	5825	-	0.000	11.72	12.00	1.067	100.00	1.000	0.000	/

Note: Refer to ANNEX C for the detailed test data for each test configuration.

10.6 5.8G ISM Band Limbs SAR

Mode	Mode	Antenna Status	Position	Dist. (mm)	Ch.	Freq. (MHz)	Power Drift (%)	10g Meas SAR (W/kg)	Meas. Power (dBm)	Max. tune-up power (dBm)	Scaling Factor	Duty cycle (%)	Duty cycle Factor	10g Scaled SAR (W/kg)	Meas. No.
Limbs															
OFDM	Ground	Horizontal	Front Side	0	165	High	-	0.000	11.72	12.00	1.067	100.00	1.000	0.000	/
			Back Side	0	165	High	0.15	0.021	11.72	12.00	1.067	100.00	1.000	0.022	/
			Top Side	0	165	High	-2.61	0.043	11.72	12.00	1.067	100.00	1.000	0.046	/
				0	149	Low	0.84	0.061	10.75	12.00	1.334	100.00	1.000	0.081	6#
		Vertical	0	157	Mid	-0.95	0.033	10.98	12.00	1.265	100.00	1.000	0.042	/	
			Front Side	0	165	High	-	0.000	11.72	12.00	1.067	100.00	1.000	0.000	/
			Back Side	0	165	High	0.03	0.012	11.72	12.00	1.067	100.00	1.000	0.013	/

Note: Refer to ANNEX C for the detailed test data for each test configuration.

10.7 WIFI 5G Body SAR

Fre. Band	Mode	Position	Dist. (mm)	Ch.	Freq. (MHz)	Power Drift (%)	1g Meas SAR (W/kg)	Meas. Power (dBm)	Max. tune-up power (dBm)	Scaling Factor	Duty cycle (%)	Duty cycle Factor	1g Scaled SAR (W/kg)	Meas. No.
Body														
5.3G	802.11a	Front Side	10	60	5300	0.30	0.054	13.22	13.50	1.067	100.00	1.000	0.058	/
			10	52	5260	-0.23	0.043	13.35	13.50	1.035	100.00	1.000	0.045	/
			10	64	5320	2.31	0.039	13.43	13.50	1.016	100.00	1.000	0.040	/
5.6G	802.11a	Front Side	10	116	5580	0.06	0.071	13.36	13.50	1.033	100.00	1.000	0.073	/
			10	100	5500	2.36	0.065	13.42	13.50	1.019	100.00	1.000	0.066	/
			10	140	5700	-0.31	0.070	13.42	13.50	1.019	100.00	1.000	0.071	/
5.8G	802.11a	Front Side	10	157	5785	-2.36	0.062	13.32	13.50	1.042	100.00	1.000	0.065	/
			10	149	5745	-2.44	0.077	13.38	13.50	1.028	100.00	1.000	0.079	7#
			10	165	5825	0.01	0.040	13.38	13.50	1.028	100.00	1.000	0.041	/

Note: Refer to ANNEX C for the detailed test data for each test configuration.

10.8 WIFI 5G Limbs SAR

Fre. Band	Mode	Position	Dist. (mm)	Ch.	Freq. (MHz)	Power Drift (%)	10g Meas SAR (W/kg)	Meas. Power (dBm)	Max. tune-up power (dBm)	Scaling Factor	Duty cycle (%)	Duty cycle Factor	10g Scaled SAR (W/kg)	Meas. No.
Limbs														
5.3G	802.11a	Front Side	0	60	5300	-2.35	0.022	13.22	13.50	1.067	100.00	1.000	0.023	/
			0	52	5260	-1.50	0.015	13.35	13.50	1.035	100.00	1.000	0.016	/
			0	64	5320	3.11	0.017	13.43	13.50	1.016	100.00	1.000	0.017	/
5.6G	802.11a	Front Side	0	116	5580	-0.84	0.031	13.36	13.50	1.033	100.00	1.000	0.032	8#
			0	100	5500	0.35	0.028	13.42	13.50	1.019	100.00	1.000	0.029	/
			0	140	5700	3.98	0.023	13.42	13.50	1.019	100.00	1.000	0.023	/
5.8G	802.11a	Front Side	0	157	5785	0.15	0.026	13.32	13.50	1.042	100.00	1.000	0.027	/
			0	149	5745	4.39	0.020	13.38	13.50	1.028	100.00	1.000	0.021	/
			0	165	5825	-0.98	0.026	13.38	13.50	1.028	100.00	1.000	0.027	/

Note: Refer to ANNEX C for the detailed test data for each test configuration.

11 SAR Measurement Variability

According to KDB 865664 D01, SAR measurement variability was assessed for each frequency band, which is determined by the SAR probe calibration point and tissue-equivalent medium used for the device measurements. When both head and body tissue-equivalent media are required for SAR measurements in a frequency band, the variability measurement procedures should be applied to the tissue medium with the highest measured SAR, using the highest measured SAR configuration for that tissue-equivalent medium. Alternatively, if the highest measured SAR for both head and body tissue-equivalent media are ≤ 1.45 W/kg and the ratio of these highest SAR values, i.e., largest divided by smallest value, is ≤ 1.10 , the highest SAR configuration for either head or body tissue-equivalent medium may be used to perform the repeated measurement. These additional measurements are repeated after the completion of all measurements requiring the same head or body tissue-equivalent medium in a frequency band. The test device should be returned to ambient conditions (normal room temperature) with the battery fully charged before it is re-mounted on the device holder for the repeated measurement(s) to minimize any unexpected variations in the repeated results.

SAR repeated measurement procedure:

1. When the highest measured SAR is < 0.80 W/kg, repeated measurement is not required.
2. When the highest measured SAR is ≥ 0.80 W/kg, repeat that measurement once.
3. If the ratio of largest to smallest SAR for the original and first repeated measurements is > 1.20 , or when the original or repeated measurement is ≥ 1.45 W/kg, perform a second repeated measurement.
4. If the ratio of largest to smallest SAR for the original, first and second repeated measurements is > 1.20 , and the original, first or second repeated measurement is ≥ 1.5 W/kg, perform a third repeated measurement.

Frequency Band (MHz)	Wireless Band	RF Exposure Conditions	Test Position	Highest Measured SAR (W/kg)	Repeated SAR (Yes/No)	Highest Measured SAR (W/kg)	Largest to Smallest SAR Ratio
-	-	-	-	-	-	-	-

Note: The highest measured SAR is $0.125 < 0.80$ W/kg, repeated measurement is not required.

Note: For product specific 10g SAR, the highest measured 10g SAR is $0.097 < 2.0$ W/kg, repeated measurement is not required.

12 SIMULTANEOUS TRANSMISSION

Simultaneous transmission SAR test exclusion is determined for each operating configuration and exposure condition according to the reported standalone SAR of each applicable simultaneous transmitting antenna. When the sum of SAR 1g of all simultaneously transmitting antennas in an operating mode and exposure condition combination is within the SAR limit (SAR 1g 1.6 W/kg), the simultaneous transmission SAR is not required. When the sum of SAR 1g is greater than the SAR limit (SAR 1g 1.6 W/kg), SAR test exclusion is determined by the SAR to Peak Location Ratio (SPLSR).

12.1 Simultaneous Transmission Mode Consider

NO.	Simultaneous Tx Combination	Body	Limbs
1	2.4G ISM Band +2.4G WLAN	Yes	Yes
2	2.4G ISM Band +5G WLAN	Yes	Yes
3	2.4G ISM Band +Bluetooth	Yes	Yes
4	5.8G ISM Band +2.4G WLAN	Yes	Yes
5	5.8G ISM Band +5G WLAN	Yes	Yes
6	5.8G ISM Band + Bluetooth	Yes	Yes

12.2 Sum SAR of Simultaneous Transmission

Simultaneous Mode	Mode	Max. 1g SAR (W/kg)	1g Sum SAR (W/kg)	Limit 1g (W/Kg)
Body (Separation 10 mm)				
2.4G ISM Band +2.4G WLAN	2.4G ISM Band	0.125	0.133	1.6
	2.4G WLAN	0.008		
2.4G ISM Band +5G WLAN	2.4G ISM Band	0.125	0.204	
	5G WLAN	0.079		
2.4G ISM Band +Bluetooth	2.4G ISM Band	0.125	0.125	
	Bluetooth	0.000		
5.8G ISM Band +2.4G WLAN	5.8G ISM Band	0.067	0.075	
	2.4G WLAN	0.008		
5.8G ISM Band +5G WLAN	5.8G ISM Band	0.067	0.146	
	5G WLAN	0.079		
5.8G ISM Band + Bluetooth	5.8G ISM Band	0.067	0.067	
	Bluetooth	0.000		

Simultaneous Mode	Mode	Max. 10g SAR (W/kg)	10g Sum SAR (W/kg)	Limit 10g (W/Kg)
Limbs (Separation 0 mm)				
2.4G ISM Band +2.4G WLAN	2.4G ISM Band	0.097	0.109	4.0
	2.4G WLAN	0.012		
2.4G ISM Band +5G WLAN	2.4G ISM Band	0.097	0.129	
	5G WLAN	0.032		
2.4G ISM Band +Bluetooth	2.4G ISM Band	0.097	0.097	
	Bluetooth	0.000		
5.8G ISM Band +2.4G WLAN	5.8G ISM Band	0.081	0.093	
	2.4G WLAN	0.012		
5.8G ISM Band +5G WLAN	5.8G ISM Band	0.081	0.113	
	5G WLAN	0.032		
5.8G ISM Band + Bluetooth	5.8G ISM Band	0.081	0.081	
	Bluetooth	0.000		

13 TEST EQUIPMENTS LIST

Description	Manufacturer	Model	Serial No./Version	Cal. Date	Cal. Due
Test Software	SATIMO	OpenSAR	V4_02_31	N/A	N/A
2450MHz Dipole	SATIMO	SID 2450	S/N 08/21 DIP2G450-452	2021/03/18	2024/03/17
Waveguide	SATIMO	SWG5500	S/N 49/16 WGA42	2021/03/18	2024/03/17
E-Field Probe	MVG	SSE2	S/N 39/21 EPGO 359	2021/11/02	2022/11/02
MultiMeter	Keithley	MultiMeter 2000	4024022	2021/06/04	2022/06/03
Signal Generator	R&S	SMB100A	182396	2021/12/20	2022/12/19
Power Meter	R&S	NRVD-B2	7250BJ-0112/2011	2021/09/08	2022/09/07
Power Sensor	R&S	NRV-Z4	100381	2021/09/08	2022/09/07
Power Sensor	R&S	NRV-Z2	100211	2021/09/08	2022/09/07
Network Analyzer	Agilent	E5071B	MY42404001	2022/04/02	2023/04/01
Thermometer	Elitech	RC-4HC	EF720B004820	2021/12/01	2022/11/30
Power Amplifier	SATIMO	6552B	22374	N/A	N/A
Dielectric Probe Kit	SATIMO	SCLMP	SN 25/13 OCPG56	N/A	N/A
Antenna	SATIMO	ANTA3	SN 17/13 ZNTA45	N/A	N/A
Phantom 1	SATIMO	SAM	SN 30/13 SAM103	N/A	N/A
Attenuator	COM-MW	ZA-S1-31	1305003187	N/A	N/A
Directional coupler	AA-MCS	AAMCS-UDC	000272	N/A	N/A

Note: For dipole antennas, BALUN has adopted 3 years as calibration intervals, and on annual basis, every measurement dipole has been evaluated and is in compliance with the following criteria:

1. There is no physical damage on the dipole;
2. System validation with specific dipole is within 10% of calibrated value;
3. Return-loss in within 20% of calibrated measurement.
4. Impedance (real or imaginary parts) in within 5 Ohms of calibrated measurement.

ANNEX A SIMULATING LIQUID VERIFICATION RESULT

The dielectric parameters of the liquids were verified prior to the SAR evaluation using an SCLMP Dielectric Probe Kit.

Date	Fre. (MHz)	Temp. (°C)	Meas. Conductivity(σ) (S/m)	Meas. Permittivity(ϵ)	Target Conductivity(σ) (S/m)	Target Permittivity(ϵ)	Conductivity Tolerance (%)	Permittivity Tolerance (%)
2022.05.26	2450	22.2	1.82	40.25	1.80	39.20	1.11	2.68
2022.05.27	5200	22.3	4.72	35.12	4.66	35.97	1.29	-2.36
2022.05.27	5600	22.3	5.21	34.38	5.07	35.50	2.76	-3.15
2022.05.28	5800	22.2	5.51	33.78	5.28	35.30	4.36	-4.31

Note: The tolerances limit of Conductivity and Permittivity is $\pm 5\%$.

ANNEX B SYSTEM CHECK RESULT

Comparing to the original SAR value provided by SATIMO, the validation data should be within its specification of 10%(for 1 g).

Date	Freq. (MHz)	Power (mW)	Measured SAR (W/kg)	Normalized SAR (W/kg)	Dipole SAR (W/kg)	Tolerance (%)
2022.05.26	2450	100	5.35	53.50	51.44	4.00
2022.05.27	5200	100	15.72	157.20	164.06	-4.18
2022.05.27	5600	100	17.24	172.40	175.86	-1.97
2022.05.28	5800	100	18.33	183.30	182.49	0.44

Note: The tolerance limit of System validation $\pm 10\%$.

Comparing to the original SAR value provided by SATIMO, the validation data should be within its specification of 10%(for 10 g).

Date	Freq. (MHz)	Power (mW)	Measured SAR (W/kg)	Normalized SAR (W/kg)	Dipole SAR (W/kg)	Tolerance (%)
2022.05.26	2450	100	2.44	24.40	23.18	5.26
2022.05.27	5200	100	5.29	52.90	57.20	-7.52
2022.05.27	5600	100	5.84	58.40	59.97	-2.62
2022.05.28	5800	100	6.14	61.40	61.35	0.08

Note: The tolerance limit of System validation $\pm 10\%$.

System Performance Check Data(2450MHz)

Type: Phone measurement (Complete)
 E-Field Probe: SN 39/21 EPGO359
 Area scan resolution: dx=8mm,dy=8mm
 Zoom scan resolution: dx=5mm, dy=5mm, dz=5mm
 Date of measurement: 2022.05.26
 Measurement duration: 17 minutes 59 seconds

Experimental conditions.

Phantom File	surf_sam_plan.txt
Phantom	Validation plane
Band	2450MHz
Signal	CW
Frequency (MHz)	2450.000000
Relative permittivity (real part)	40.249600
Conductivity (S/m)	1.819367
Power drift (%)	-0.090000
Ambient Temperature:	22.8°C
Liquid Temperature:	22.2°C
ConvF:	2.21
Crest factor:	1:1

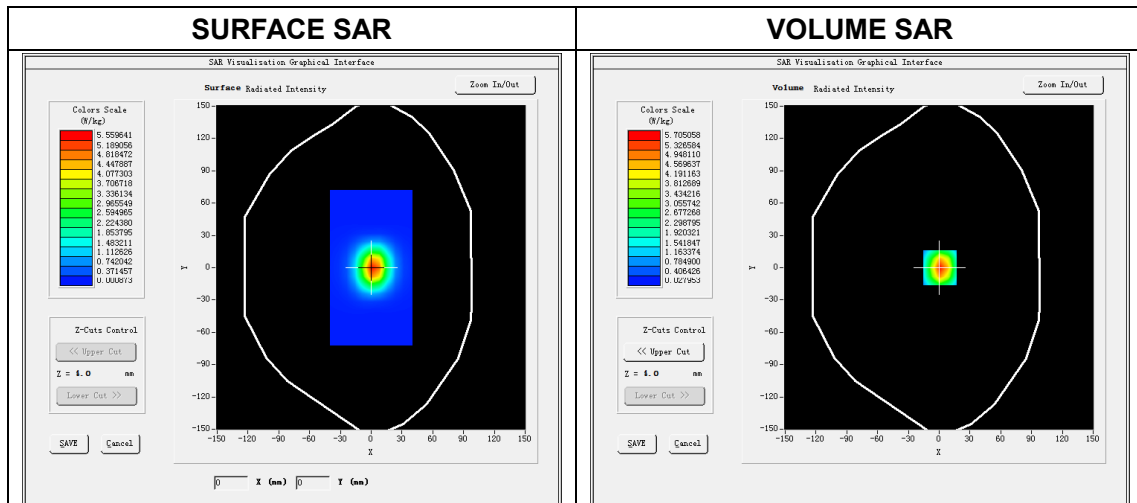

Maximum location: X=1.00, Y=0.00

SAR Peak: 9.72 W/kg

SAR 10g (W/Kg)	2.444082
SAR 1g (W/Kg)	5.351502

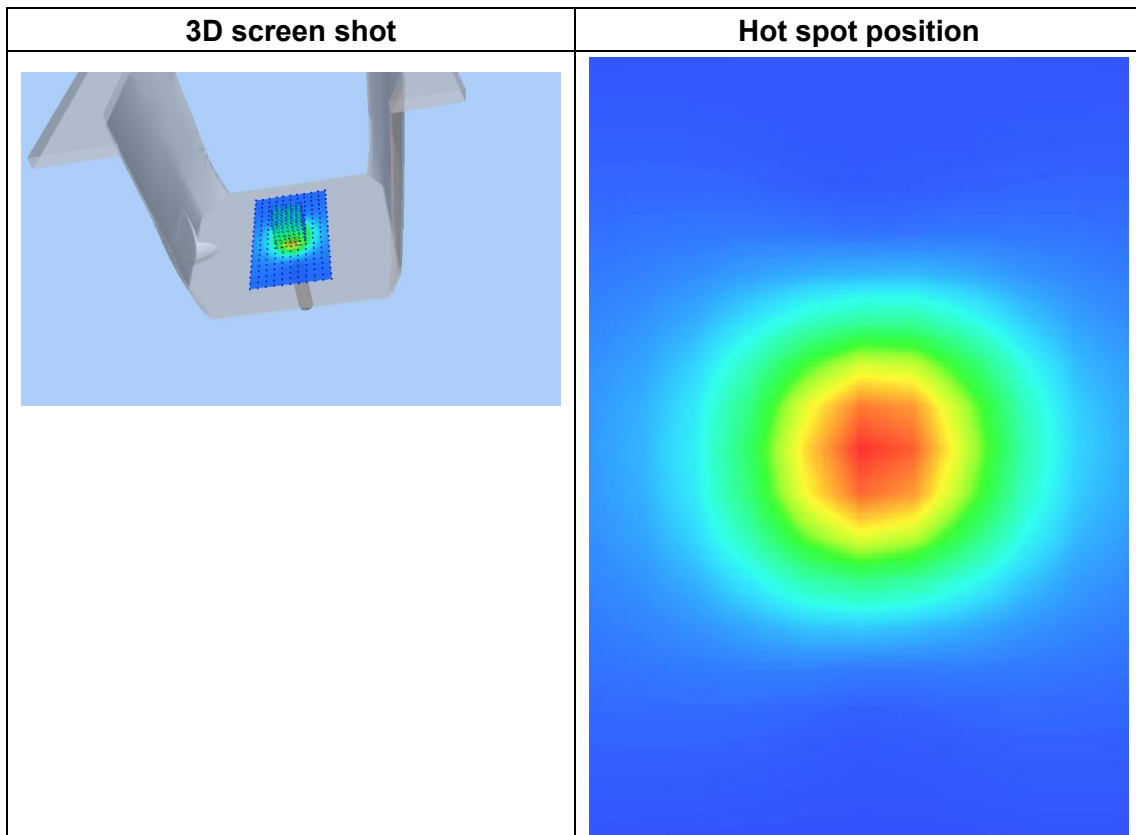
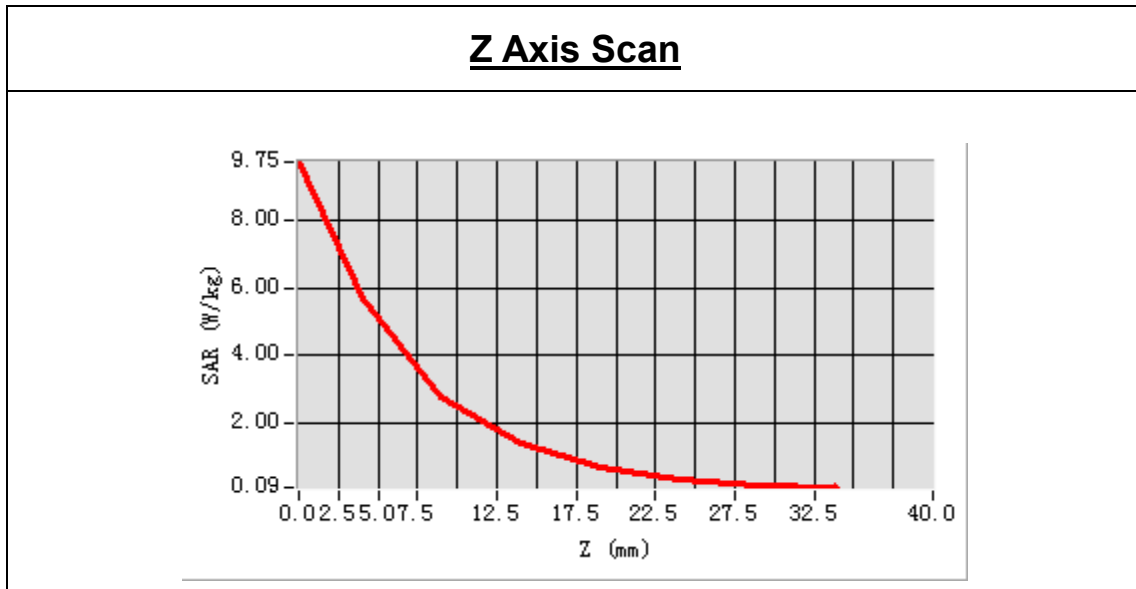

System Performance Check Data(5200 MHz)

Type: Phone measurement (Complete)
 E-Field Probe: SN 39/21 EPGO359
 Area scan resolution: dx=8 mm,dy=8 mm
 Zoom scan resolution: dx=4 mm, dy=4 mm, dz=2 mm
 Date of measurement: 2022.05.27
 Measurement duration: 29 minutes 32 seconds

Experimental conditions.

Phantom File	surf_sam_plan.txt
Phantom	Validation plane
Band	5200 MHz
Signal	CW
Frequency (MHz)	5200.000000
Relative permittivity (real part)	35.123451
Conductivity (S/m)	4.715484
Power drift (%)	0.790000
Ambient Temperature:	22.9°C
Liquid Temperature:	22.3°C
ConvF:	1.32
Crest factor:	1:1

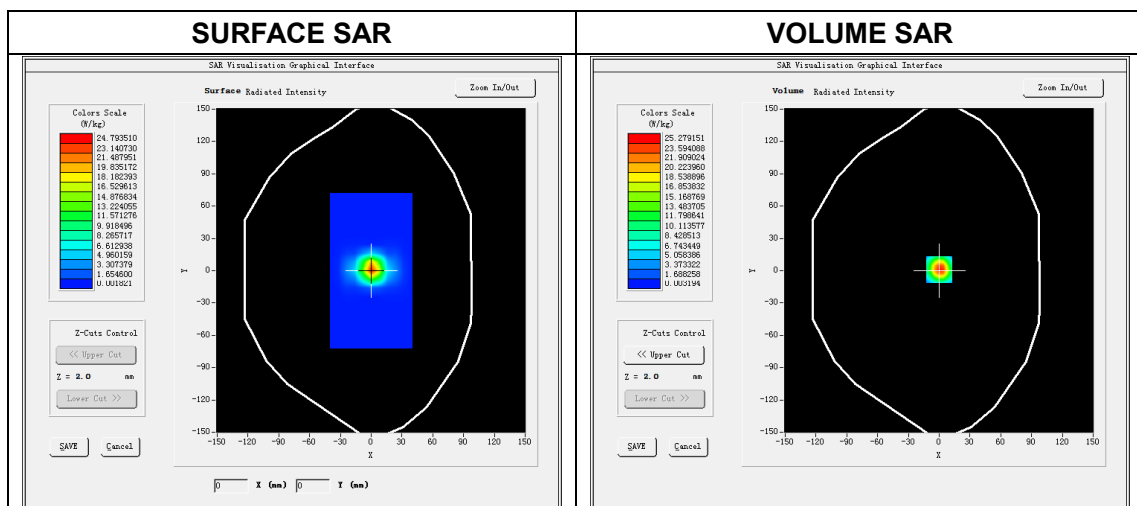

Maximum location: X=0.00, Y=1.00

SAR Peak: 39.61 W/kg

SAR 10 g (W/Kg)	5.293793
SAR 1 g (W/Kg)	15.722962

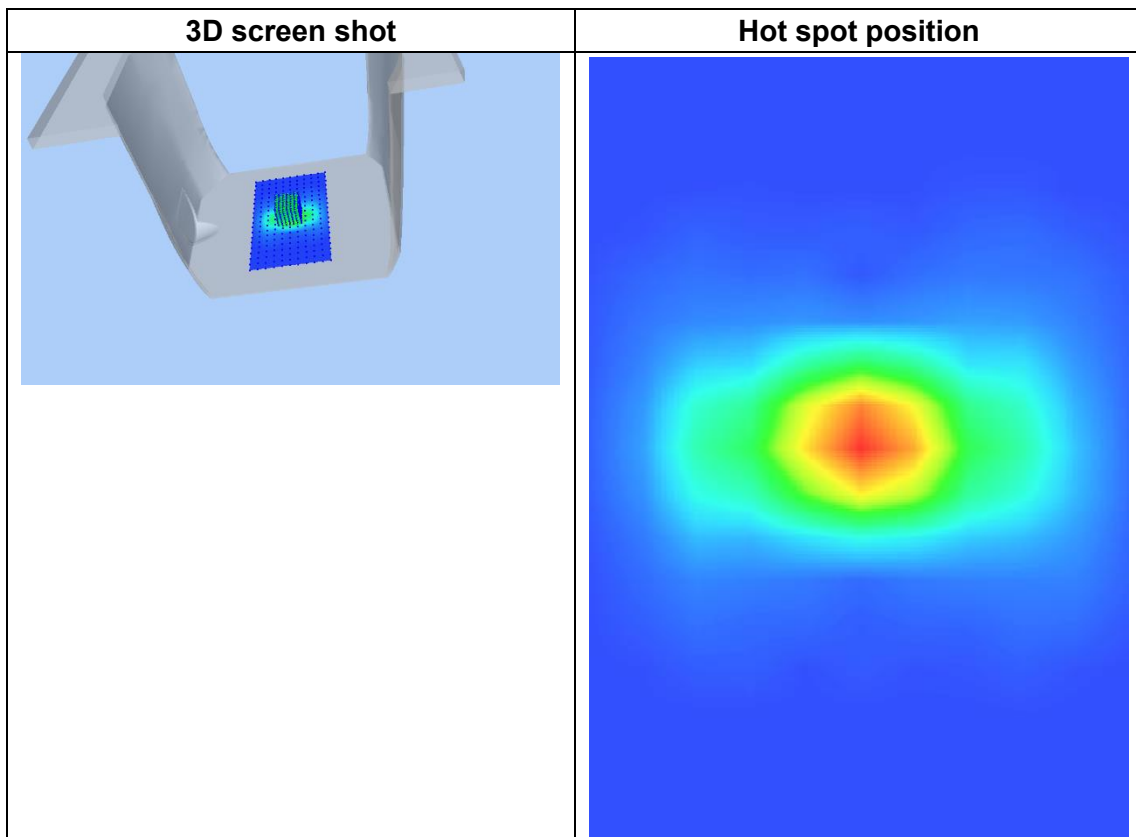
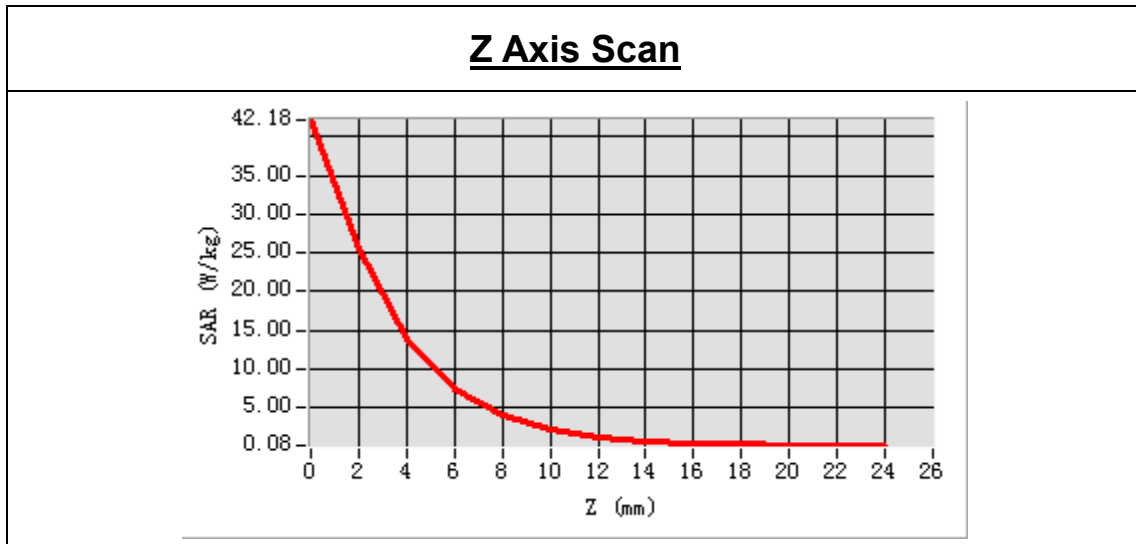

System Performance Check Data(5600 MHz)

Type: Phone measurement (Complete)
 E-Field Probe: SN 39/21 EPGO359
 Area scan resolution: dx=8 mm,dy=8 mm
 Zoom scan resolution: dx=4 mm, dy=4 mm, dz=2 mm
 Date of measurement: 2022.05.27
 Measurement duration: 27 minutes 28 seconds

Experimental conditions.

Phantom File	surf_sam_plan.txt
Phantom	Validation plane
Band	5600 MHz
Signal	CW
Frequency (MHz)	5600.000000
Relative permittivity (real part)	34.381241
Conductivity (S/m)	5.211521
Power drift (%)	0.390000
Ambient Temperature:	22.8°C
Liquid Temperature:	22.3°C
ConvF:	2.15
Crest factor:	1:1

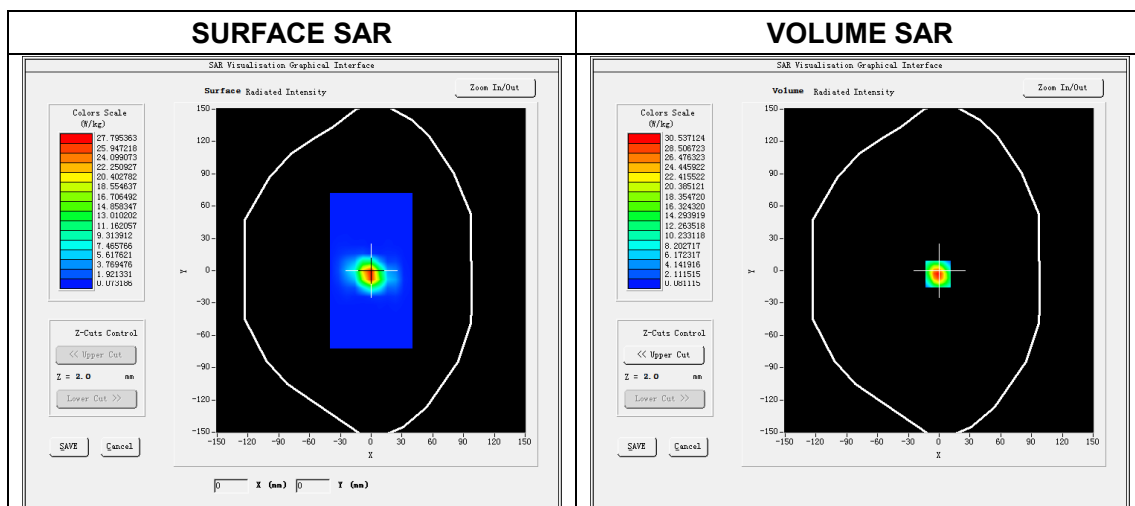

Maximum location: X=0.00, Y=0.00

SAR Peak: 52.24 W/kg

SAR 10 g (W/Kg)	5.844205
SAR 1 g (W/Kg)	17.239801



3D screen shot	Hot spot position

System Performance Check Data(5800 MHz)

Type: Phone measurement (Complete)
 E-Field Probe: SN 39/21 EPG0359
 Area scan resolution: dx=8 mm,dy=8 mm
 Zoom scan resolution: dx=4 mm, dy=4 mm, dz=2 mm
 Date of measurement: 2022.05.28
 Measurement duration: 27 minutes 40 seconds

Experimental conditions.

Phantom File	surf_sam_plan.txt
Phantom	Validation plane
Band	5800 MHz
Signal	CW
Frequency (MHz)	5800.000000
Relative permittivity (real part)	33.783216
Conductivity (S/m)	5.512125
Power drift (%)	-0.120000
Ambient Temperature:	22.8°C
Liquid Temperature:	22.2°C
ConvF:	1.93
Crest factor:	1:1

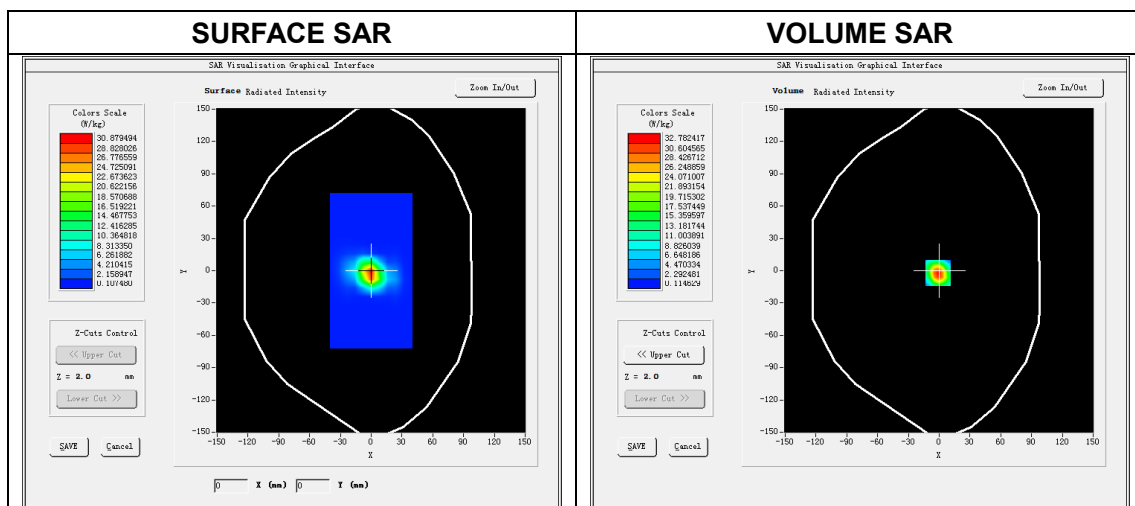

Maximum location: X=0.00, Y=0.00

SAR Peak: 57.41 W/kg

SAR 10 g (W/Kg)	6.137030
SAR 1 g (W/Kg)	18.334424

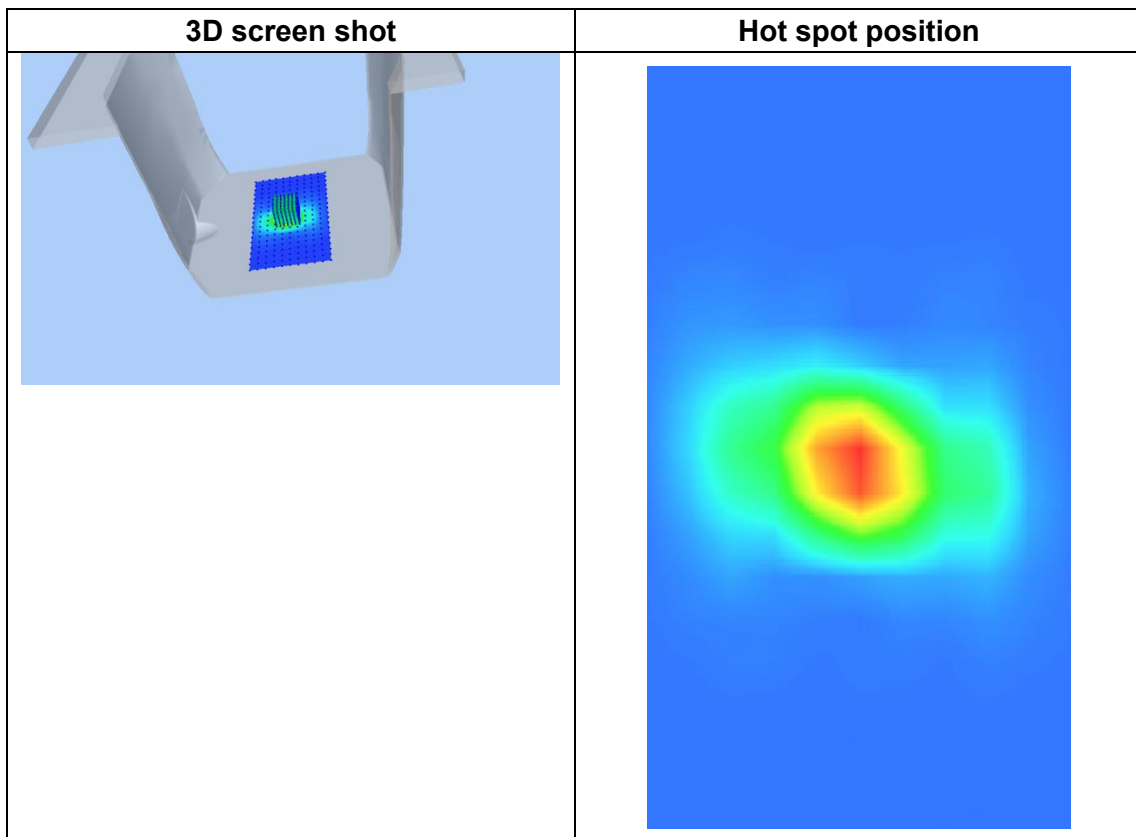
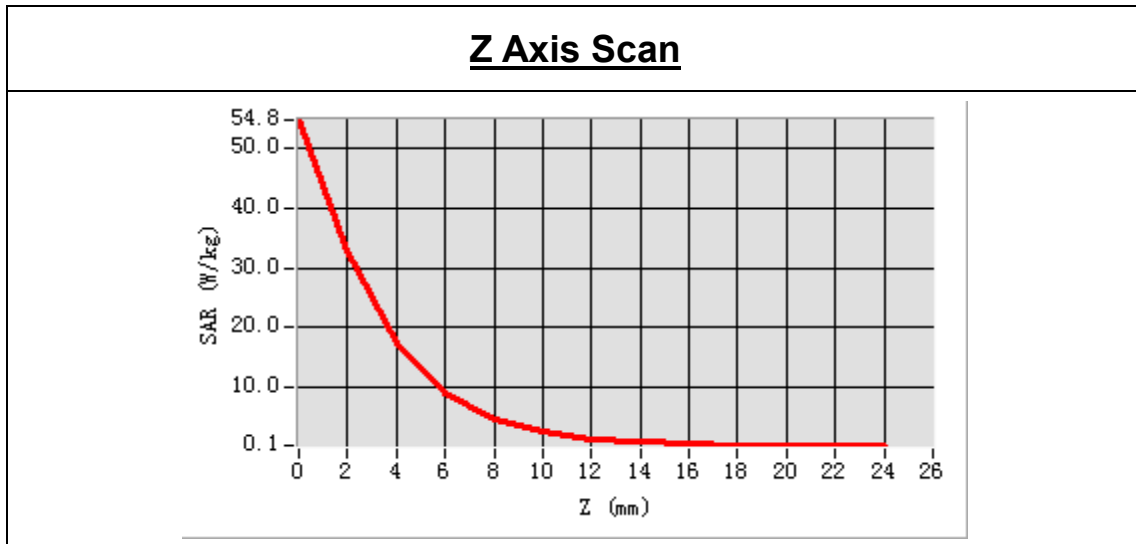

ANNEX C TEST DATA

MEAS. 1 Body Plane with H-Top Edge 10mm on Mid Channel in OFDM mode

Test Date: 26/05/2022
Measurement duration: 15 minutes 12 seconds
Signal: 802.11b, f=2441.0 MHz, Duty Cycle: 1:1.0
Liquid Parameters: Permittivity: 39.22; Conductivity: 1.79 S/m
Test condition: Ambient Temperature: 22.8°C, Liquid Temperature: 22.2°C
Probe: SN_3921_EPGO359, ConvF: 2.25
Area Scan: sam_direct_droit2_surf8mm.txt, h= 5.00 mm
Zoom Scan: 5x5x7,dx=8mm, dy=8mm, dz=5mm,Complete
Maximum location: X=0.000000, Y=-8.000000
SAR 10g (W/Kg): 0.048156
SAR 1g (W/Kg): 0.097295
Power drift (%): -2.11
3D screen shot

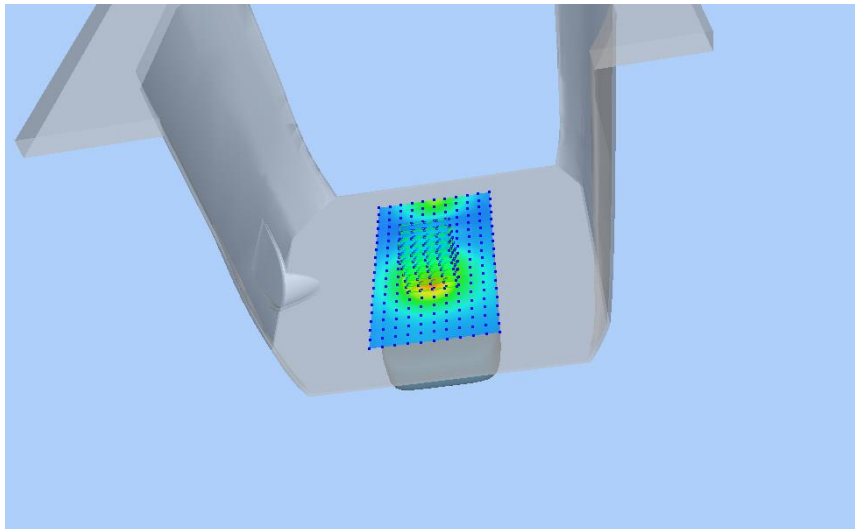

Z Axis Scan

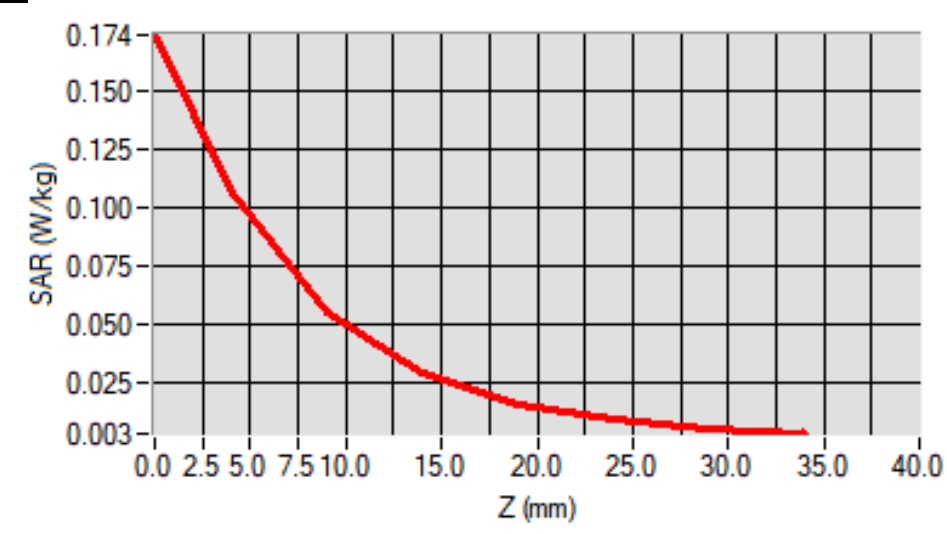

MEAS. 2 Body Plane with H-Top Edge 0mm on Mid Channel in OFDM mode

Test Date: 26/05/2022
Measurement duration: 15 minutes 27 seconds
Signal: 802.11b, f=2441.0 MHz, Duty Cycle: 1:1.0
Liquid Parameters: Permittivity: 39.22; Conductivity: 1.79 S/m
Test condition: Ambient Temperature: 22.8°C, Liquid Temperature: 22.2°C
Probe: SN_3921_EPGO359, ConvF: 2.25
Area Scan: sam_direct_droit2_surf8mm.txt, h= 5.00 mm
Zoom Scan: 5x5x7,dx=8mm, dy=8mm, dz=5mm,Complete
Maximum location: X=0.000000, Y=-16.000000
SAR 10g (W/Kg): 0.074608
SAR 1g (W/Kg): 0.163921
Power drift (%): -4.38
3D screen shot

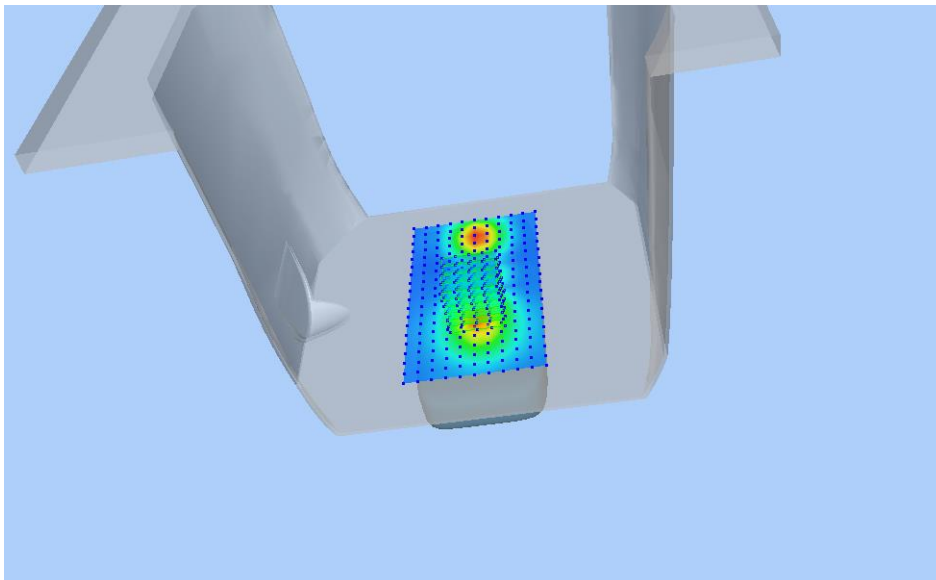

Z Axis Scan

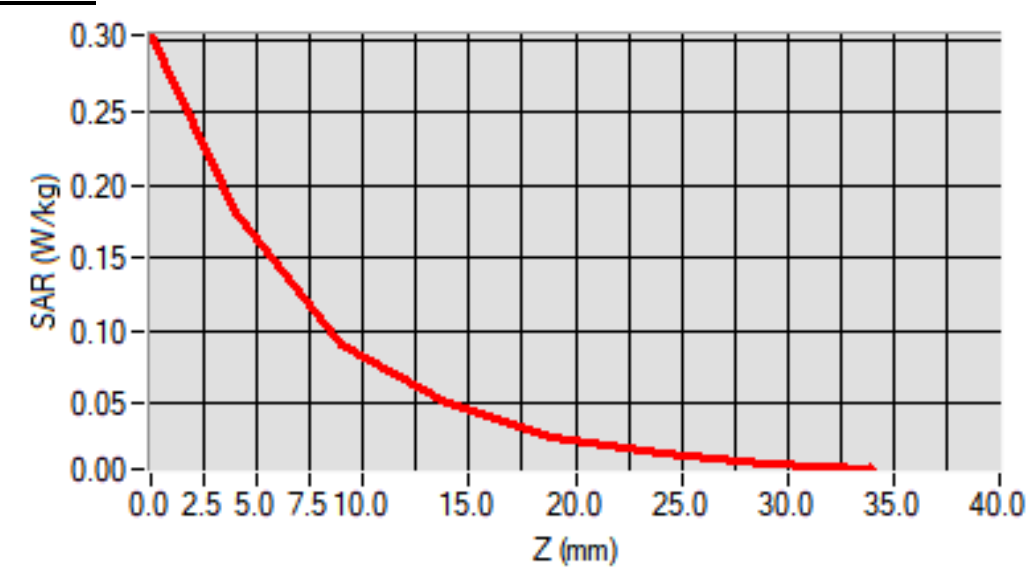

MEAS. 3 Body Plane with Right Side 10mm on Mid Channel in IEEE 802.11b mode

Test Date: 26/05/2022
Measurement duration: 16 minutes 2 seconds
Signal: 802.11b, f=2437.0 MHz, Duty Cycle: 1:1.0
Liquid Parameters: Permittivity: 39.22; Conductivity: 1.79 S/m
Test condition: Ambient Temperature: 22.8°C, Liquid Temperature: 22.2°C
Probe: SN_3921_EPGO359, ConvF: 2.25
Area Scan: sam_direct_droit2_surf8mm.txt, h= 5.00 mm
Zoom Scan: 5x5x7,dx=8mm, dy=8mm, dz=5mm,Complete
Maximum location: X=8.000000, Y=16.000000
SAR 10g (W/Kg): 0.004488
SAR 1g (W/Kg): 0.007885
Power drift (%): -0.62
3D screen shot

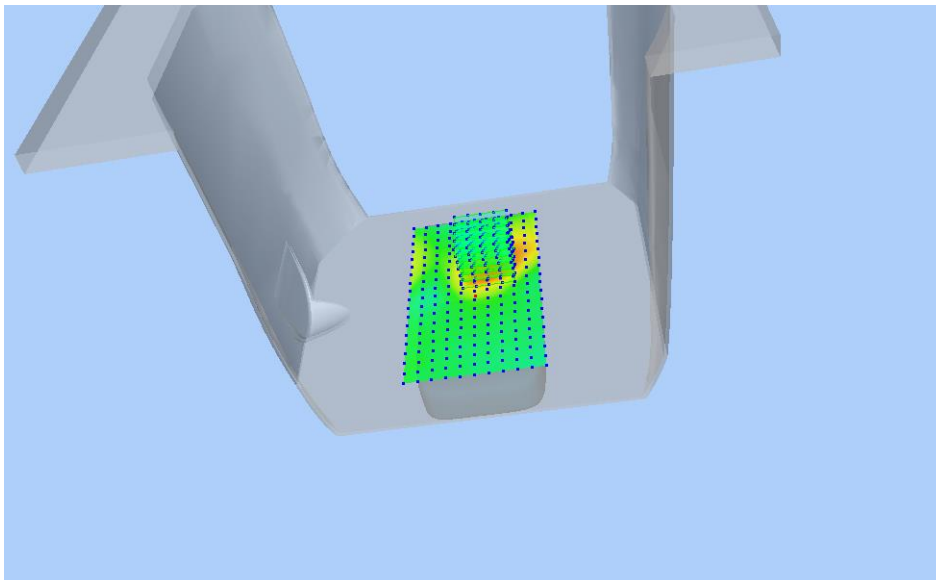

Z Axis Scan

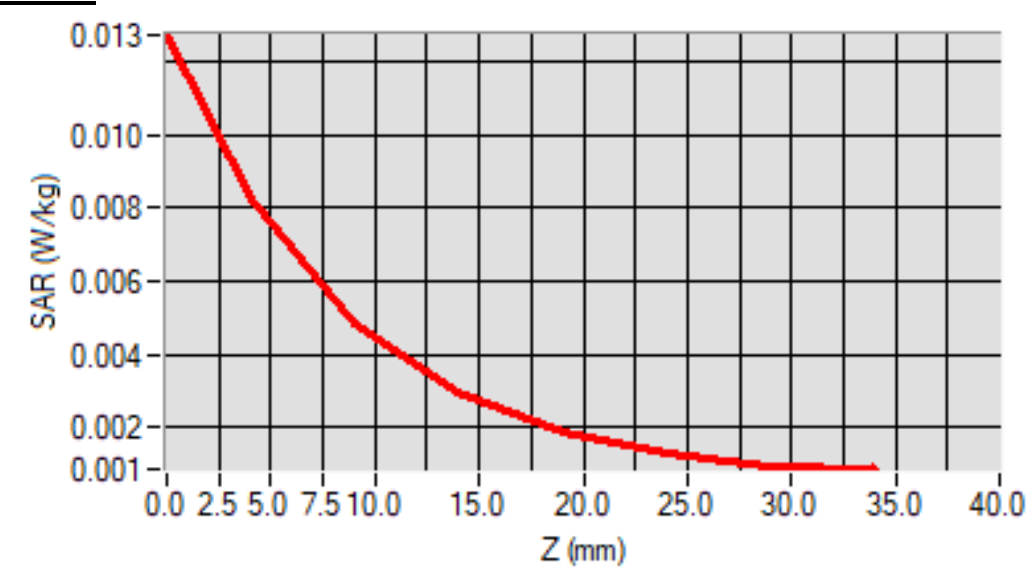

MEAS. 4 Body Plane with Back Side 0mm on Low Channel in IEEE 802.11b mode

Test Date: 26/05/2022
Measurement duration: 14 minutes 52 seconds
Signal: 802.11b, f=2437.0 MHz, Duty Cycle: 1:1.0
Liquid Parameters: Permittivity: 39.22; Conductivity: 1.79 S/m
Test condition: Ambient Temperature: 22.8°C, Liquid Temperature: 22.2°C
Probe: SN_3921_EPGO359, ConvF: 2.25
Area Scan: sam_direct_droit2_surf8mm.txt, h= 5.00 mm
Zoom Scan: 5x5x7,dx=8mm, dy=8mm, dz=5mm,Complete
Maximum location: X=-8.000000, Y=0.000000
SAR 10g (W/Kg): 0.011310
SAR 1g (W/Kg): 0.027269
Power drift (%): -0.59
3D screen shot

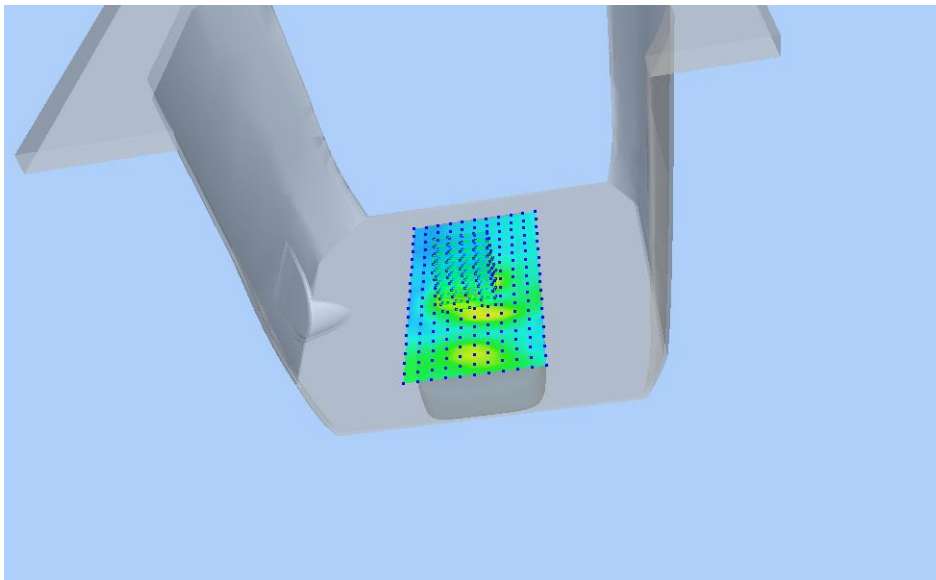

Z Axis Scan

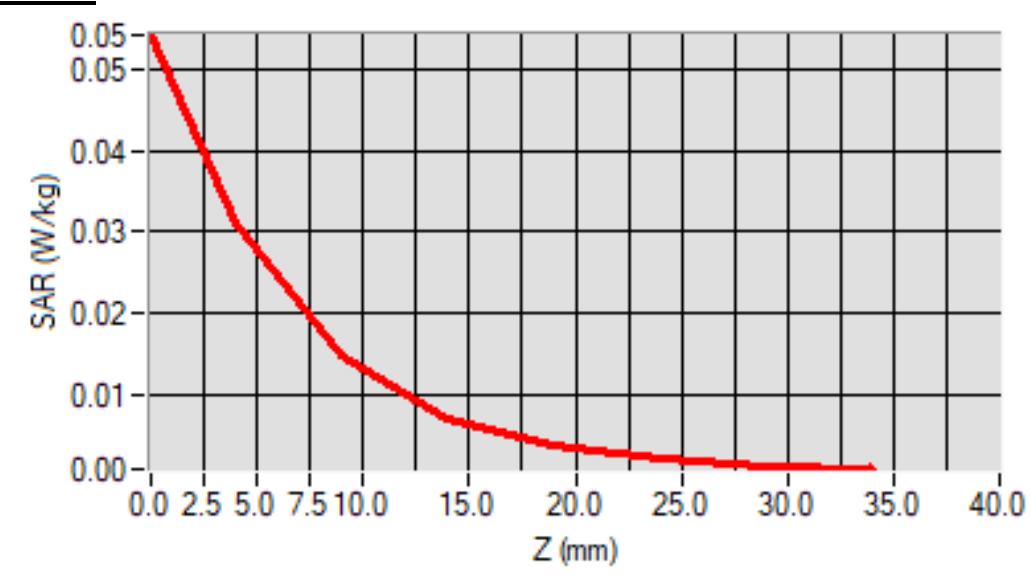

MEAS. 5 Body Plane with H-Top Edge 10mm on High Channel in OFDM mode

Test Date: 28/05/2022
Measurement duration: 18 minutes 41 seconds
Signal: 802.11a , f=5825.0 MHz, Duty Cycle: 1:1.0
Liquid Parameters: Permittivity: 35.33; Conductivity: 5.25 S/m
Test condition: Ambient Temperature: 22.8°C, Liquid Temperature: 22.2°C
Probe: SN_3921_EPGO359, ConvF: 1.92
Area Scan: sam_direct_droit2_surf10mm.txt, h= 5.00 mm
Zoom Scan: 7x7x12,dx=4mm, dy=4mm, dz=2mm,Complete
Maximum location: X=-20.000000, Y=28.000000
SAR 10g (W/Kg): 0.020999
SAR 1g (W/Kg): 0.062568
Power drift (%): -1.70
3D screen shot

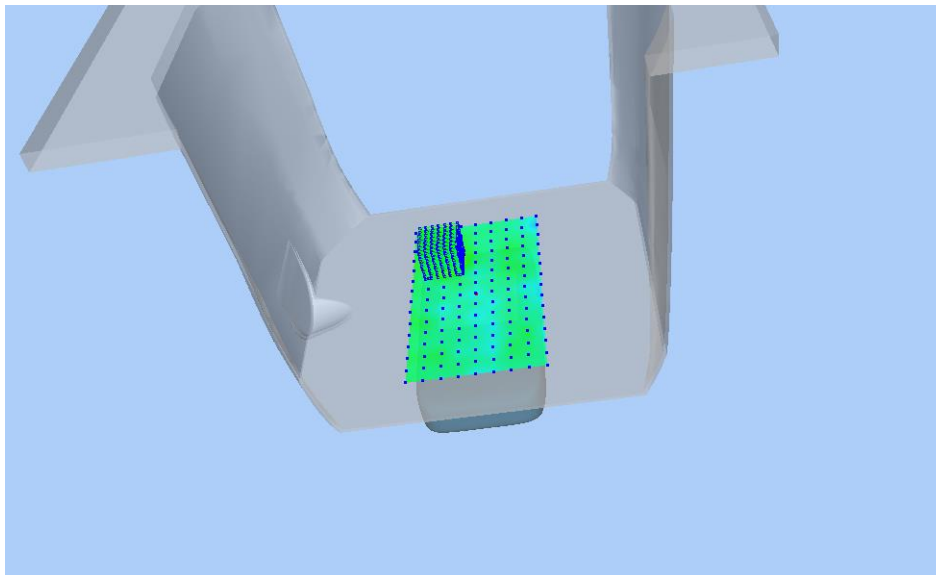

Z Axis Scan

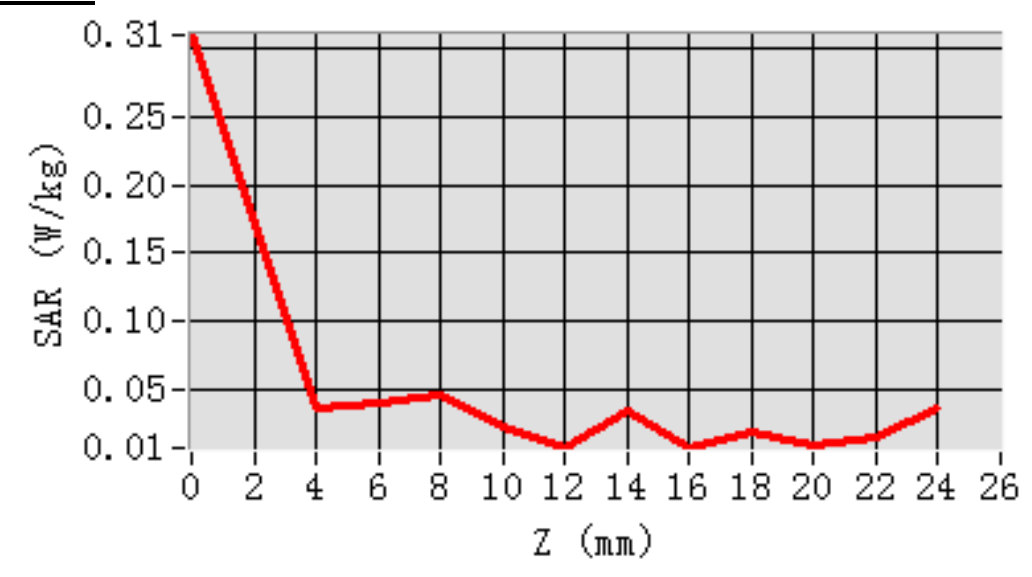

MEAS. 6 Body Plane with H-Top Edge 0mm on Low Channel in OFDM mode

Test Date: 28/05/2022
Measurement duration: 15 minutes 20 seconds
Signal: 802.11a, f=5745.0 MHz, Duty Cycle: 1:1.0
Liquid Parameters: Permittivity: 39.22; Conductivity: 1.79 S/m
Test condition: Ambient Temperature: 22.8°C, Liquid Temperature: 22.2°C
Probe: SN_3921_EPGO359, ConvF: 1.92
Area Scan: sam_direct_droit2_surf10mm.txt, h= 5.00 mm
Zoom Scan: 7x7x12,dx=4mm, dy=4mm, dz=2mm,Complete
Maximum location: X=0.000000, Y=40.000000
SAR 10g (W/Kg): 0.061292
SAR 1g (W/Kg): 0.183213
Power drift (%): 0.84
3D screen shot

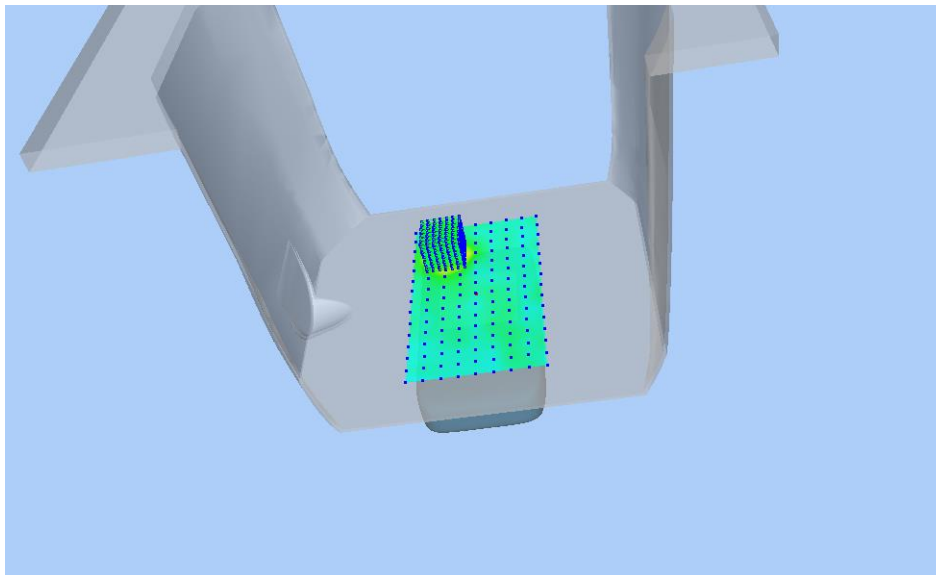

Z Axis Scan

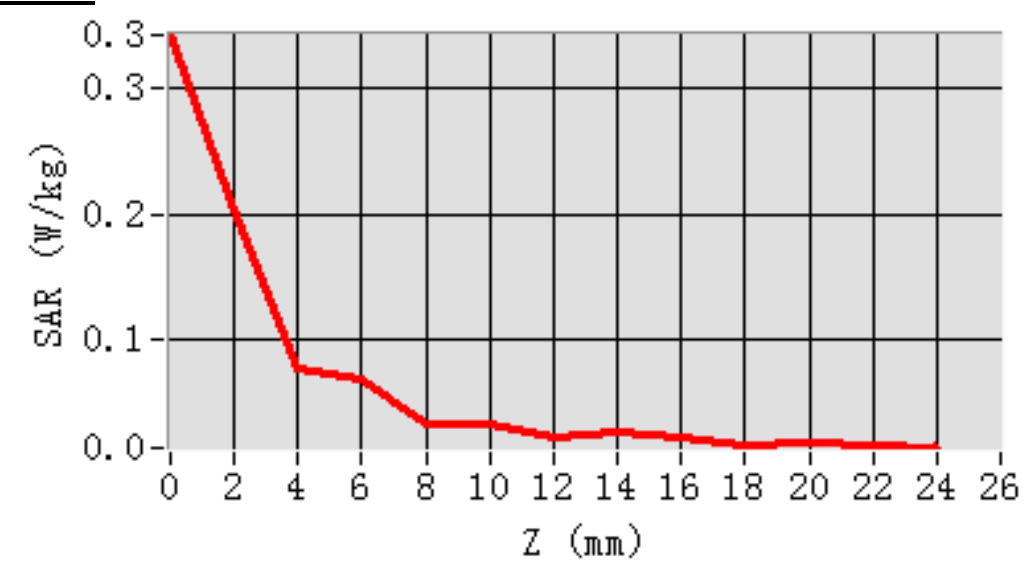

MEAS. 7 Body Plane with Back Side 10mm on Low Channel in IEEE 802.11a mode

Test Date: 28/05/2022
Measurement duration: 13 minutes 39 seconds
Signal: 802.11a, f=5745.0 MHz, Duty Cycle: 1:1.0
Liquid Parameters: Permittivity: 39.22; Conductivity: 1.79 S/m
Test condition: Ambient Temperature: 22.8°C, Liquid Temperature: 22.2°C
Probe: SN_3921_EPGO359, ConvF: 1.92
Area Scan: sam_direct_droit2_surf10mm.txt, h= 5.00 mm
Zoom Scan: 7x7x12,dx=4mm, dy=4mm, dz=2mm,Complete
Maximum location: X=-8.000000, Y=8.000000
SAR 10g (W/Kg): 0.018273
SAR 1g (W/Kg): 0.077146
Power drift (%): -2.44
3D screen shot

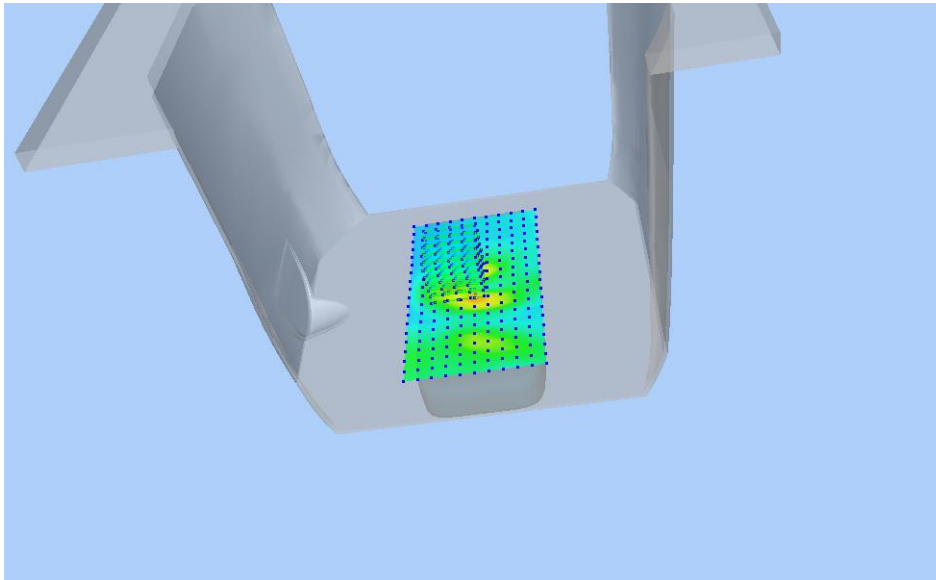

Z Axis Scan

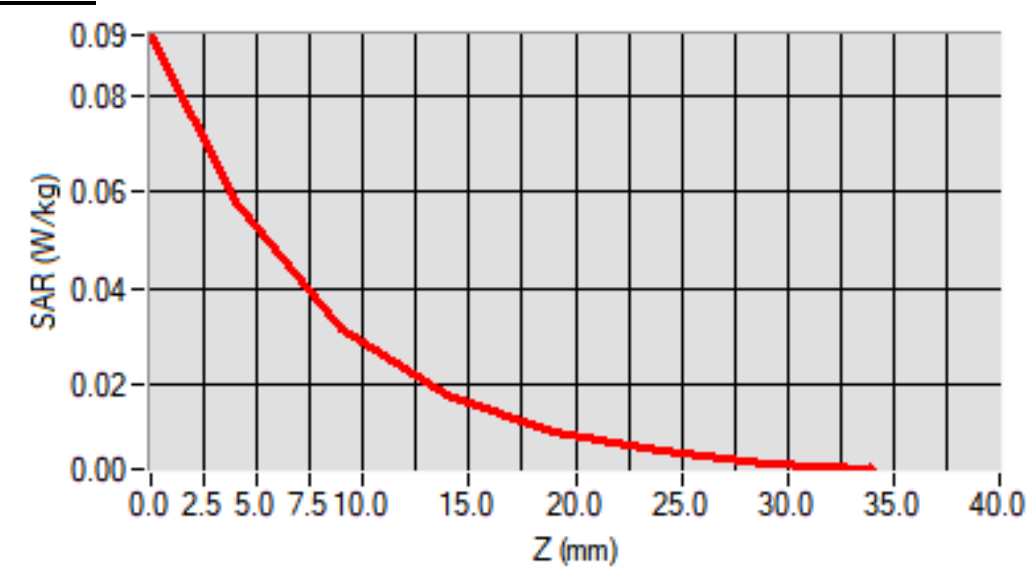

MEAS. 8 Body Plane with Back Side 0mm on Mid Channel in IEEE 802.11a mode

Test Date: 27/05/2022
Measurement duration: 15 minutes 16 seconds
Signal: 802.11a, f=5580.0 MHz, Duty Cycle: 1:1.0
Liquid Parameters: Permittivity: 39.28; Conductivity: 1.77 S/m
Test condition: Ambient Temperature: 22.8°C, Liquid Temperature: 22.3°C
Probe: SN_3921_EPGO359, ConvF: 2.12
Area Scan: sam_direct_droit2_surf10mm.txt, h= 5.00 mm
Zoom Scan: 7x7x12,dx=4mm, dy=4mm, dz=2mm,Complete
Maximum location: X=0.000000, Y=-8.000000
SAR 10g (W/Kg): 0.031264
SAR 1g (W/Kg): 0.093253
Power drift (%): -0.84
3D screen shot

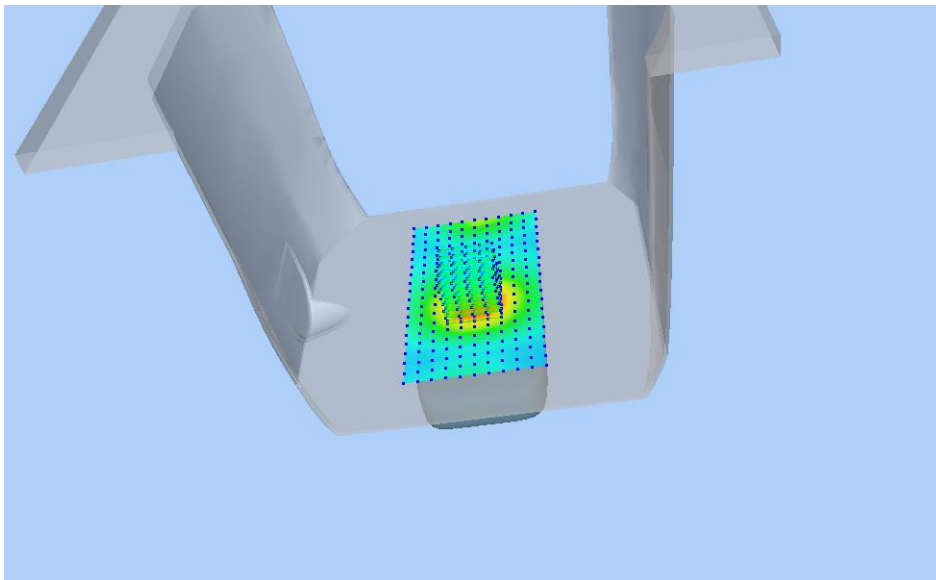

Z Axis Scan

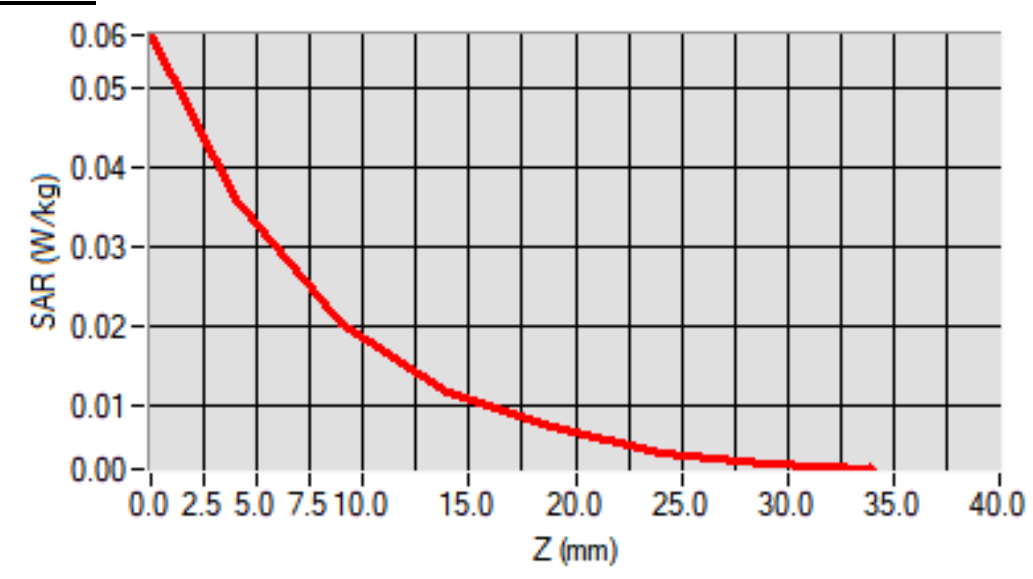

ANNEX D EUT EXTERNAL PHOTOS

Please refer the document “BL-EC2220625-AW.pdf”.

ANNEX E SAR TEST SETUP PHOTOS

Please refer the document “BL-EC2220625-AS.pdf”.

ANNEX F CALIBRATION REPORT

Please refer the document “CALIBRATION REPORT.pdf”.

Statement

1. The laboratory guarantees the scientificity, accuracy and impartiality of the test, and is responsible for all the information in the report, except the information provided by the customer. The customer is responsible for the impact of the information provided on the validity of the results.
2. The report without China inspection body and laboratory Mandatory Approval (CMA) mark has no effect of proving to the society.
3. For the report with CNAS mark or A2LA mark, the items marked with "☆" are not within the accredited scope.
4. This report is invalid if it is altered, without the signature of the testing and approval personnel, or without the "inspection and testing dedicated stamp" or test report stamp.
5. The test data and results are only valid for the tested samples provided by the customer.
6. This report shall not be partially reproduced without the written permission of the laboratory.
7. Any objection shall be raised to the laboratory within 30 days after receiving the report.

--END OF REPORT--