

## H520E/H520E-RTK OVERVIEW

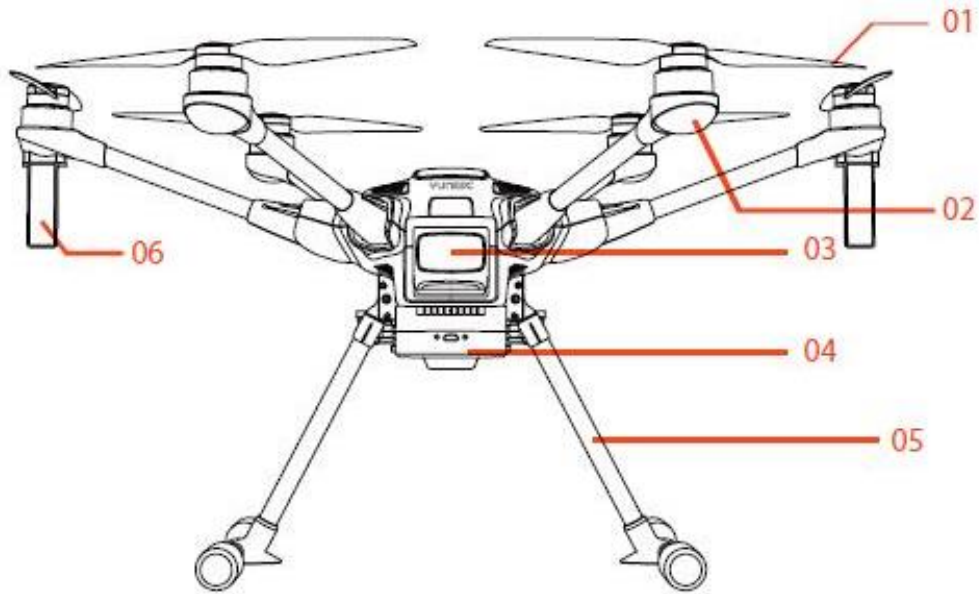

### H520E/H520E-RTK

**01** Propeller

**02** LED Status Indicator

**03** Battery Chamber

**04** OFDM Module

**05** Retractable Lander Gear

**06** OFDM Antennas

**07** RKT Antennas

(H520E-RTK only)

RTK 天线用灰色虚线画出

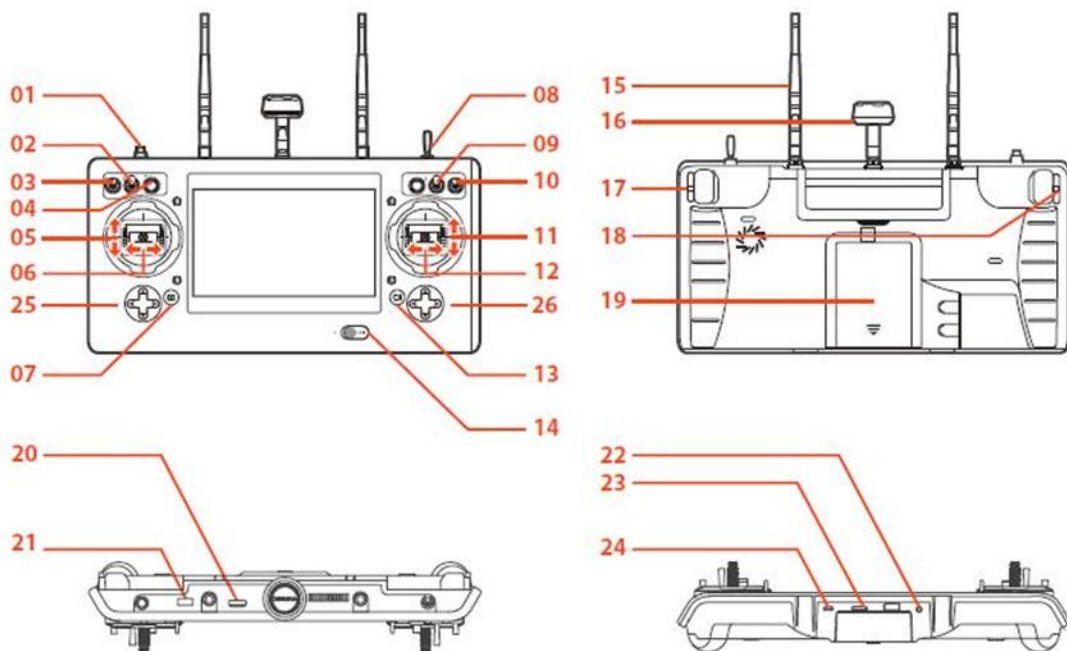

## ST16E

- |   |   |
|---|---|
| <b>01</b> Start/Stop Motors Button  | <b>13</b> Start/Stop Video Recording Button                       |
| <b>02</b> Gimbal Pan Mode Switch<br>(Follow Mode/ Follow Pan Controllable<br>Mode/ Global Mode) | <b>14</b> Power Switch  |
| <b>03</b> Gimbal Tilt Mode Switch<br>(Angle Mode/ Velocity Mode)                                | <b>15</b> 2.4GHz Antenna  |
| <b>04</b> Gimbal Pan Control Knob   | <b>16</b> 5GHz Antenna  |
| <b>05</b> Throttle/ Altitude Control (Mode 2)<br>Elevator/pitch control (Mode 1)                | <b>17</b> Proportional Control Rate Slider                        |
| <b>06</b> Rudder/ Yaw Control<br>(Mode 2 and Mode 1)  | <b>18</b> Gimbal Tilt Control Slider                              |
| <b>07</b> Take Still Photo Button   | <b>19</b> Battery   |
| <b>08</b> Landing Gear Switch   | <b>20</b> HDMI  |
| <b>09</b> Obstacle Avoidance Switch   | <b>21</b> USB Port  |
| <b>10</b> Flight Mode Selection Switch  | <b>22</b> Headset Port  |
| <b>11</b> Elevator/ Pitch Control (Mode2)<br>Throttle/Altitude Control (Mode 1)                 | <b>23</b> Micro SD Slot   |
| <b>12</b> Aileron/Roll Control<br>(Mode 2 and Mode 1)   | <b>24</b> Micro USB Port  |
| <b>13</b> Start/Stop Video Recording Button   | <b>25</b> Left Trim<br>(Up/Down EV)<br>(Left/Right Wight Balance) |
|   | <b>26</b> Right Trim<br>(Up/Down Zoom)                            |

### Charge the Batteries

#### Charge the flight battery

Power the SC4000-4E charger from a 100-240V AC outlet using the AC adapter/power supply, or from a 12V-17.4V DC accessory socket/cigarette lighter receptacle in a vehicle using the included adapter.

Plug the aircraft battery into the charger port as illustrated.

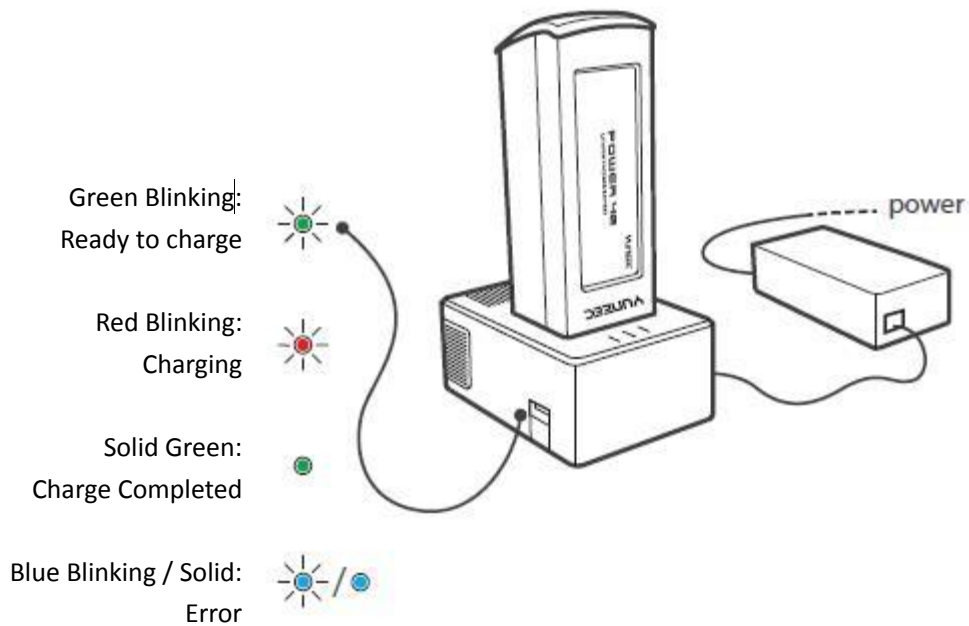

**Notice:** The batteries are a consumable material and that they have to be replaced after they show weakness.

**Notice:** Voltage for a long time storage shall be 14.4V~15.6V range. Full charged storage is prohibited

### Charge the ST16E battery

Charge the ST16E battery by using supplied USB cable and inserting it into the USB port on the charger. It will take approximately five hours to charge a fully discharged battery.

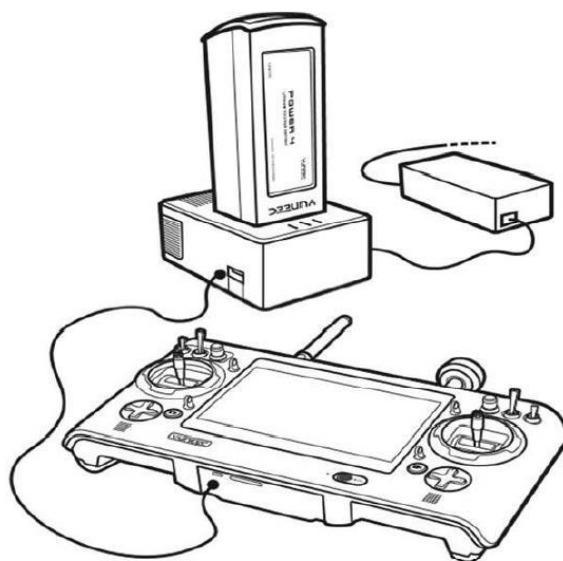

**NOTICE:** To check the charge status of the ST16E, simply tap the screen twice.

## Assembly

### ASSEMBLING THE ARMS

Unfold the motor arms and secure them until hearing a 'click'.

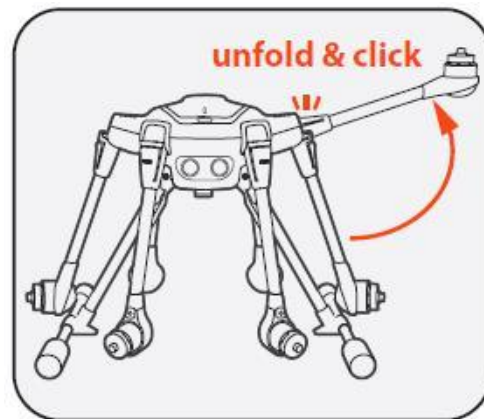

### INSTALLING THE PROPELLERS

Mount propeller 'A' on motor 'A' and propeller 'B' on motor 'B'.

Press and rotate propellers in the direction the [🔒] points to until the propellers locked.

Cross-check to be sure propellers are properly locked in place.

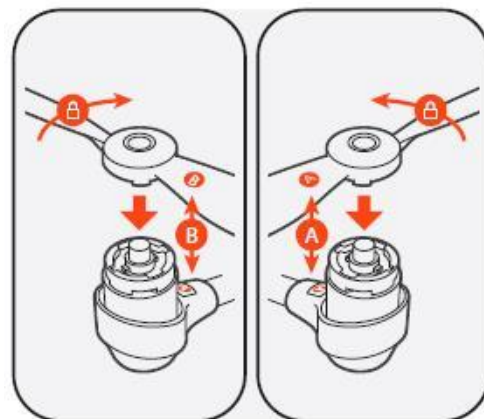

### Installing the RTK Antenna (H520E-RTK only)

Screw the Antenna onto the upper cover of the drone. Ensure the Antenna has been secured before takeoff.

### INSTALLING THE FLIGHT BATTERIES

Push the battery into the battery compartment until hearing a 'click'.

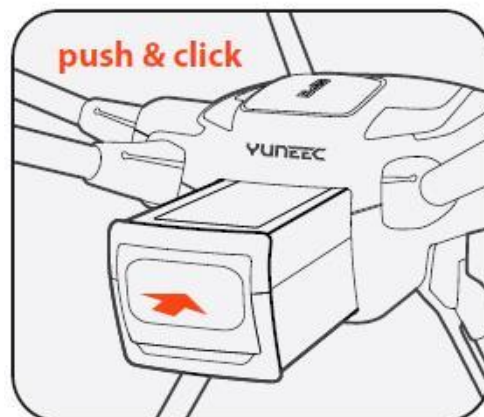

## Ground Station

### App User Interface Over view

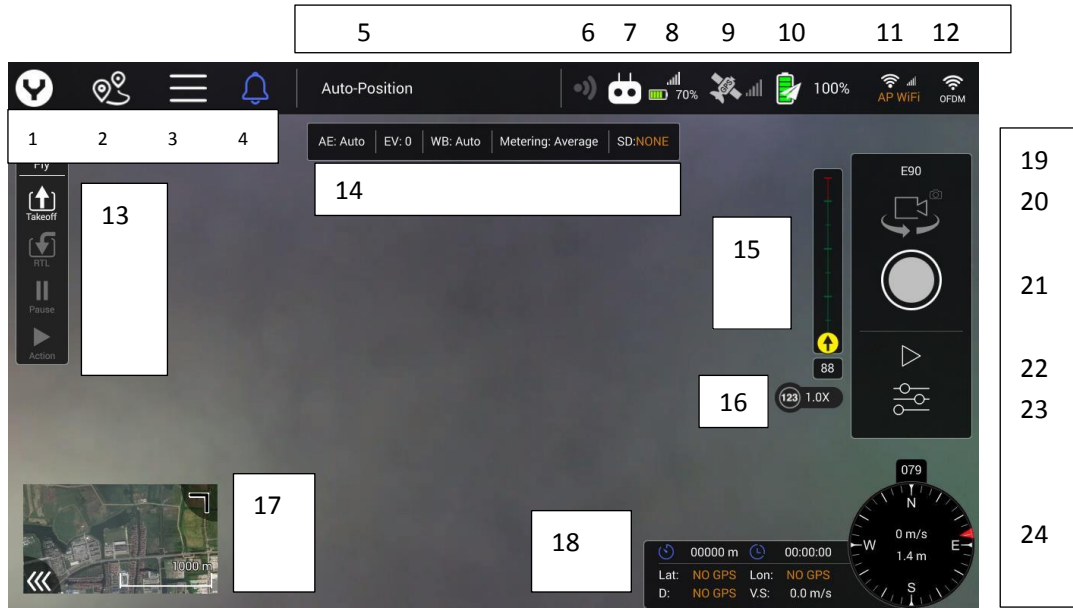

- |                                  |                                      |                                    |
|----------------------------------|--------------------------------------|------------------------------------|
| <b>01</b> Main Interface button  | <b>09</b> Drone GPS indicator        | <b>17</b> Map /Video Switch        |
| <b>02</b> Mission Route Setting  | <b>10</b> Drone Battery indicator    | <b>18</b> Flight Parameter Display |
| <b>03</b> System Setting button  | <b>11</b> Wi-Fi Setting button       | <b>19</b> Camera Type              |
| <b>04</b> Warning Message button | <b>12</b> OFDM Setting button        | <b>20</b> Photo/Video Mode         |
| <b>05</b> Flight Mode Indicator  | <b>13</b> Flight quick control panel | Switch                             |
| <b>06</b> Obstacle Avoidance     | <b>14</b> Camera quick setting       | <b>21</b> Shutter/Record button    |
| Indicator                        | <b>15</b> Gimbal attitude indicator  | <b>22</b> Gallery                  |
| <b>07</b> Controller Mark        | <b>16</b> zoom indicator             | <b>23</b> Camera Setting Button    |
| <b>08</b> ST16E Battery & RSSI   |                                      | <b>24</b> Compass                  |

### Common Setting functions for Ground Station

#### RC Monitor

Tap the System setting button then Select the RC Monitor Item.

Move the Joysticks, Knobs, and Sliders or press the buttons to check the controller hardware input.

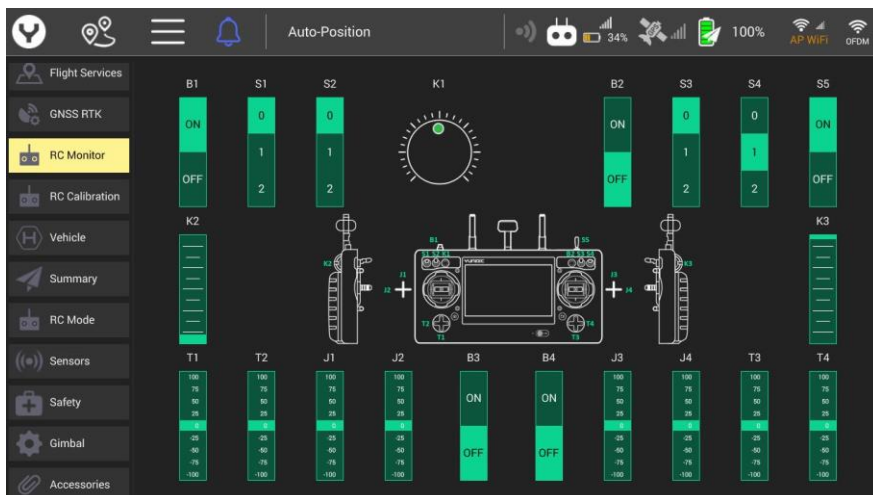

## RC Calibration

Tap the System setting button then Select the RC Calibration Item.

Then tap the Start Calibration button

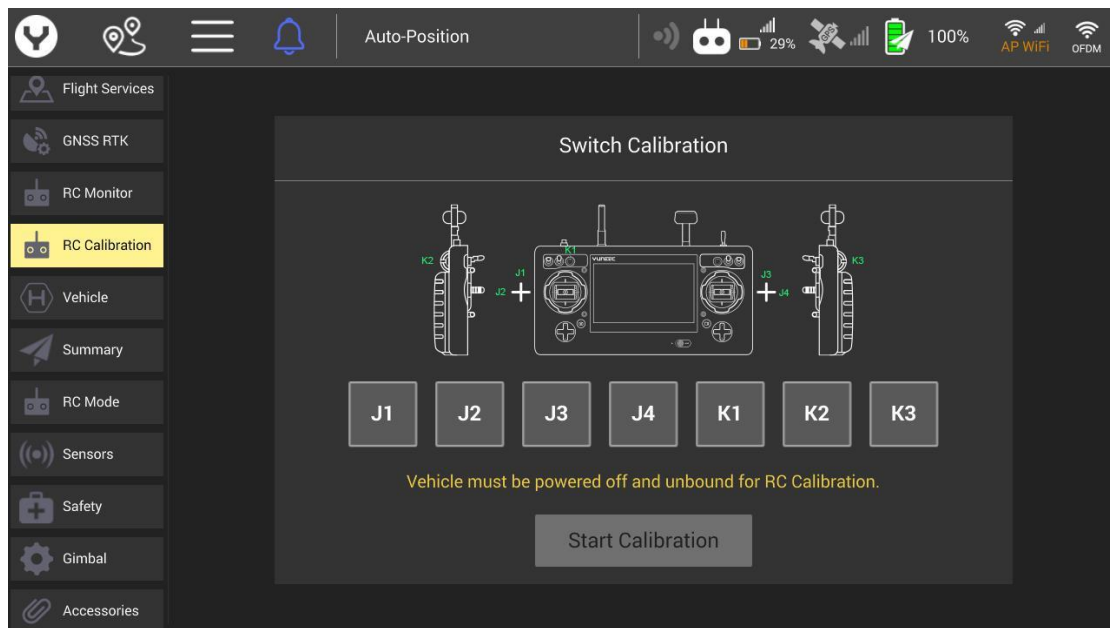

## RC Mode

Tap the System setting button then Select the RC Mode Item.

Select the Joysticks mode as your wish

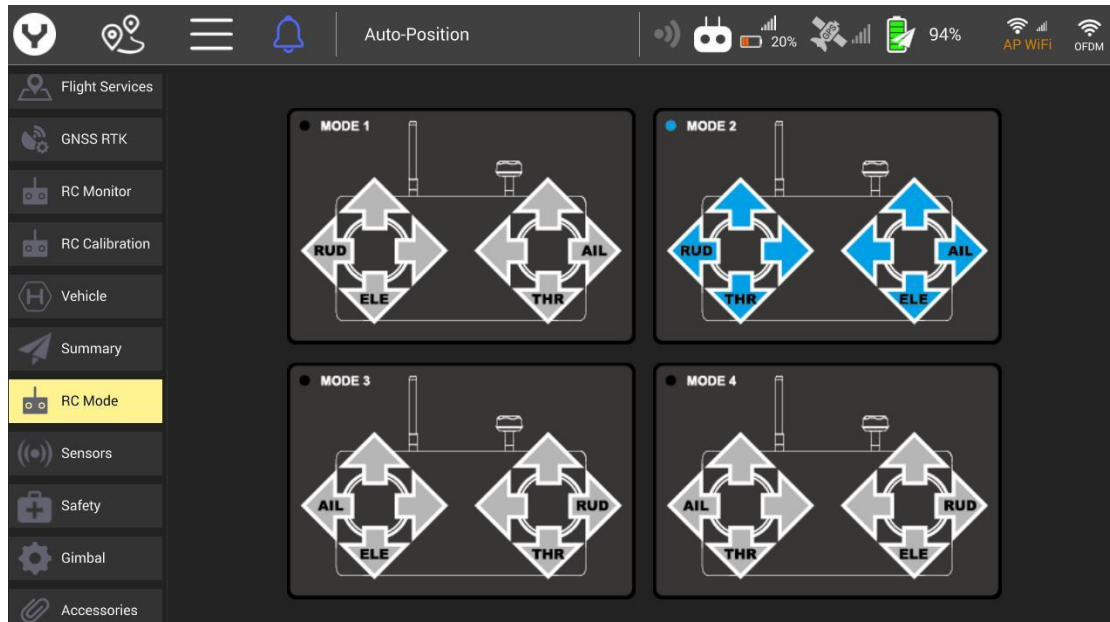



## Payload

### Assembly and Disassembly the X connector gimbals

Assembling

#### Step 1.

Find the Unlocked Mark etched on the Gimbal Yaw Motor and align the Mark Line with the front of the damping plate.

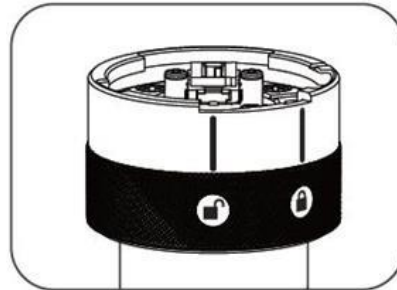

Step 1

#### Step 2.

Insert the Gimbal Yaw Motor into the damping plate and rotate it counterclockwise until the Mark Line of the Locked Mark aligns with the front of the damping plate to secure the gimbal.

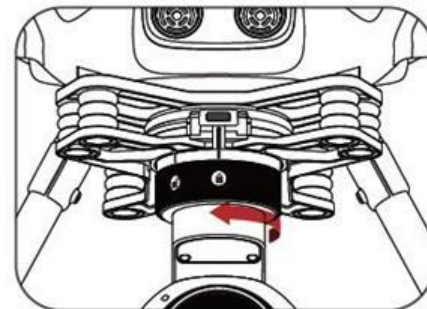
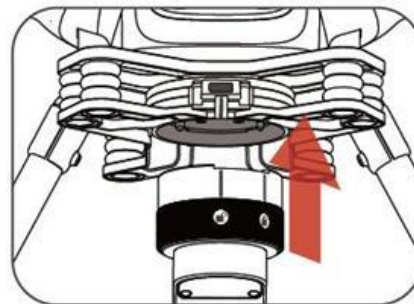

#### Step 3.

Remove the lens protector

Disassembling

#### Step 1.

Hold the gimbal release button and rotate the Gimbal Yaw Motor clockwise until the Mark Line of the Unlocked Mark aligns with the front of the damping plate.

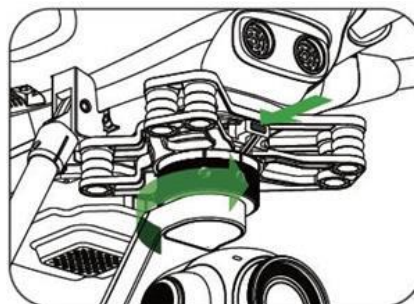

#### Step 2.

Pull the gimbal out from the damping plate.

**Notice:** The X-connector series gimbal needn't bind separately. If the re-binding is needed please refer to the corresponding section in the OFDM Module binding chapter.

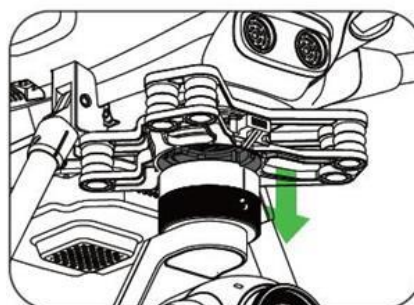

## Visible light Camera

E90X

Yuneec's E90X camera is a one-inch CMOS sensor to capture high quality images with 4k 10 bit in camera color processing. Images may be captured in formats of JPEG or DNG format, or simultaneous capture of both formats. Video may be recorded in UHD, 2K, or HD resolutions at a variety of frame rates.

When the Gimbal was connected successfully the gimbal type will be shown correctly on the screen.

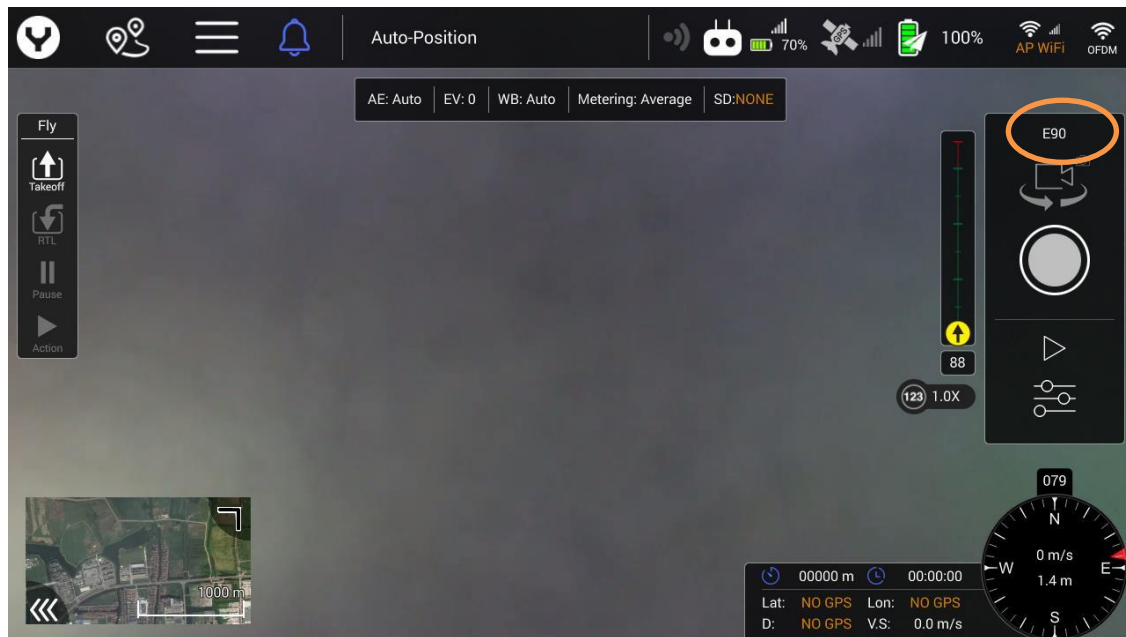

Tap the Camera Setting Button to set more photographic parameters.

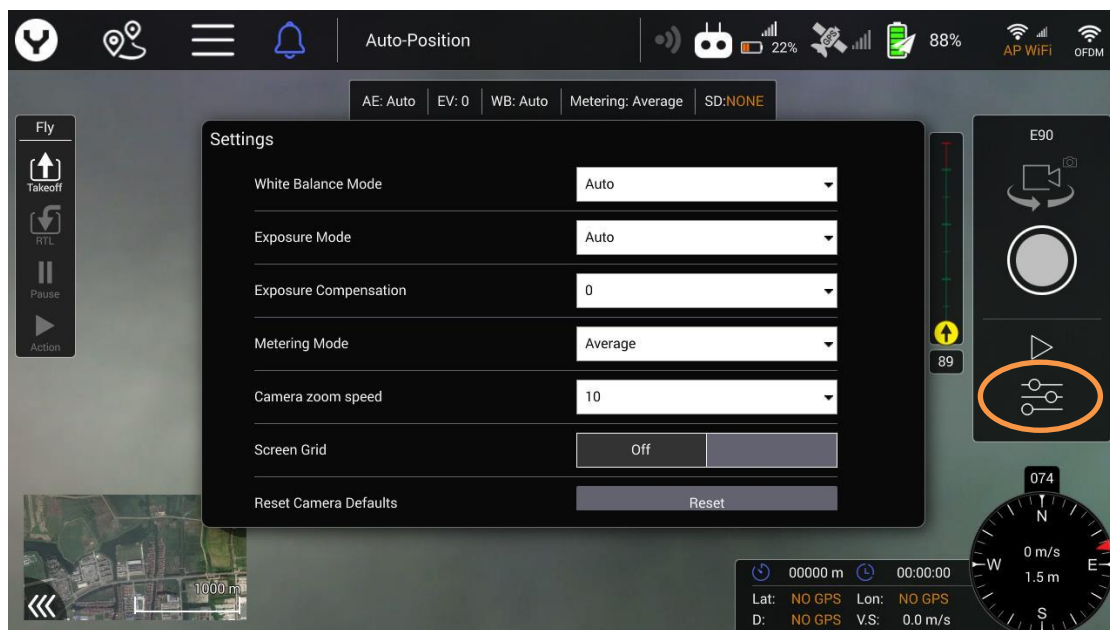

**Notice:** For more detailed introduction please refer to the corresponding Gimbal User Manual.



## Thermal imaging camera

ETx/E10Tx/E10Tvx

This series are innovative combination of 3-axis gimbals, thermal imaging camera and low-light camera. While the thermal imaging camera selectively measures the temperature in the image enabling it to display relative temperature differences, the low-light RGB camera has a 20 times higher sensitivity than the human eye and can still take excellent shots even in low light conditions. Both images are streamed live on the remote control at the same time, and can be viewed separately as a picture-in-picture or as an overlay.

As same as the E90x gimbal, When the Gimbal was connected successfully the gimbal type will be shown correctly on the screen, also tap the Camera Setting Button to set more photographic parameters both for thermal imaging and visible light camera.

**Notice:** For more detailed introduction please refer to the corresponding Gimbal User Manual.

## Variable-focus camera

E30Zx

The E30Zx is a powerful 30x zoom drone camera and makes it easy to zoom in on distant objects to gain valuable details. The compact camera housing contains a 1/2.8" CMOS sensor, which provides high-quality and stabilized recordings even in low light conditions. In addition to the 30x optical zoom, the camera offers a 6x digital zoom for flexible application options such as inspection, search and rescue operations, monitoring, people search, and much more.

As same as the E90x gimbal, When the Gimbal was connected successfully the gimbal type will be shown correctly on the screen, also tap the Camera Setting Button to set more photographic parameters.

### Zoom function for E30Zx

#### Zoom in

Press and hold the zoom in button to increase the optical zoom. When increasing to 30X optical zoom, if presses the zoom in button again, the camera begins to increase digital zoom. The digital zoom can increase to 6X at the most.

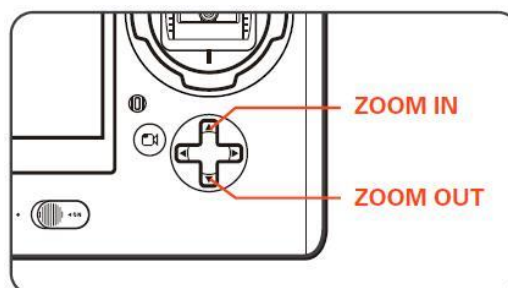

#### Zoom out

Press and hold the zoom out button to decrease the optical zoom. When decreasing to 1X digital zoom, if presses the zoom out button again, the camera begins to decrease optical zoom.

### One Key to 1x Image

Tap the [  ] on the screen you can return the camera to 1X zoom

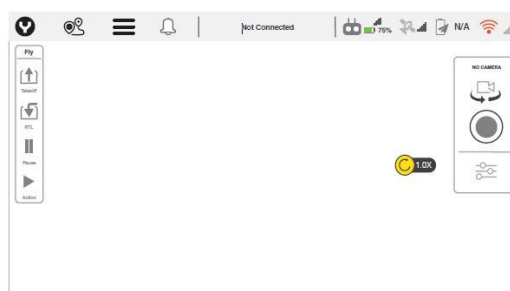

**Notice:** For more detailed introduction please refer to the corresponding Gimbal User Manual.

### Other payloads

Yuneec has several different camera/payload devices for use on the H520E/H520E-RTK.

Get more information on [www.yuneec.com](http://www.yuneec.com).

### SD CARD SELECTION

Yuneec recommend using a SDXC Class 10 UHS-3 micro SD card for recording 4k video. Using the UHS-3 card allows the camera buffer to record to the micro SD card faster resulting in fewer buffers overrun.

### Per-Flight Preparation

#### Environment Requirements

Always operate the Drone in open areas (approximately 10000 square feet/930 square meters or more) that are free from people, vehicles, trees and other obstructions. Never fly near or above crowds, airports or buildings.

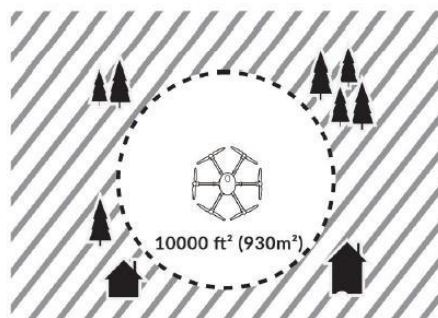

Never attempt to operate the drone near tall buildings/obstructions that do not offer a clear view of the sky (a minimum clearance of 100°).

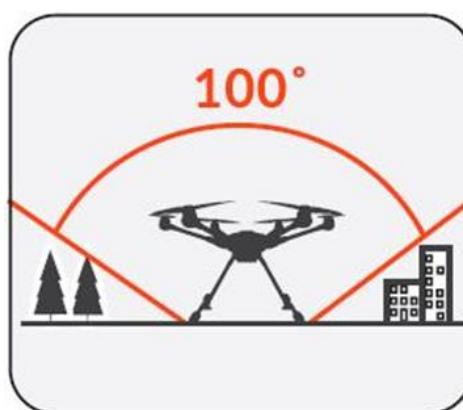

### Power ON/OFF

Turn on the ST16E, and then press the power button on H520E/H520E-RTK. Release the button when the aircraft emits a rising tune. Power the ST16E before powering on the UAS.

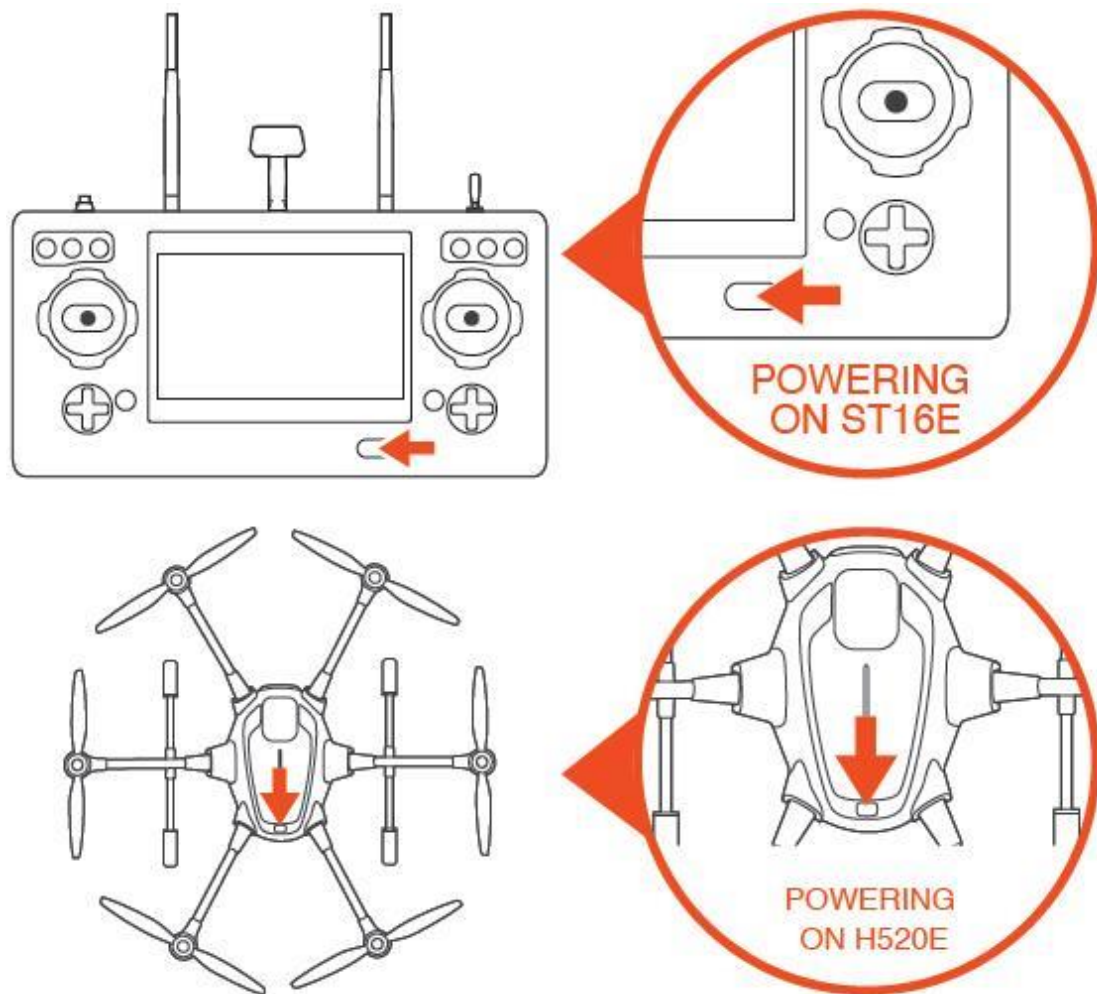

### OFDM Module Re-bind

The aircraft and ST16E Ground Station are already bound out of factory. There is no need to bind them. Pilot can follow the steps below if rebinding is needed.

**Step 1:** Power on the ST16E. Wait a few seconds for all systems to be boot up.

**Step 2:** Tap the OFDM logo on the top right corner, then Tap the unbind button.



**Step 3:** Tap the Unbind Confirm button to finish the unbind process.

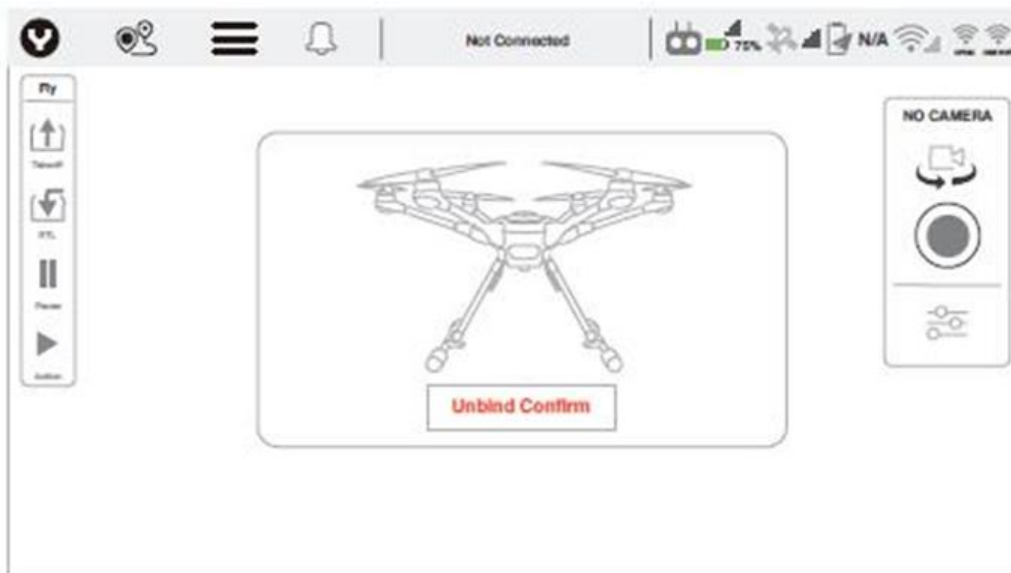

**Step 4:** Tap the OFDM logo on the top right corner again.

**Step 5:** Power on the drone until see the dialog box shown below.

**Step 6 :** After initialization completes, Use a paperclip or something like a needle to push the bind button inside the right hole of the OFDM module. Release the button until the LED blink quickly.

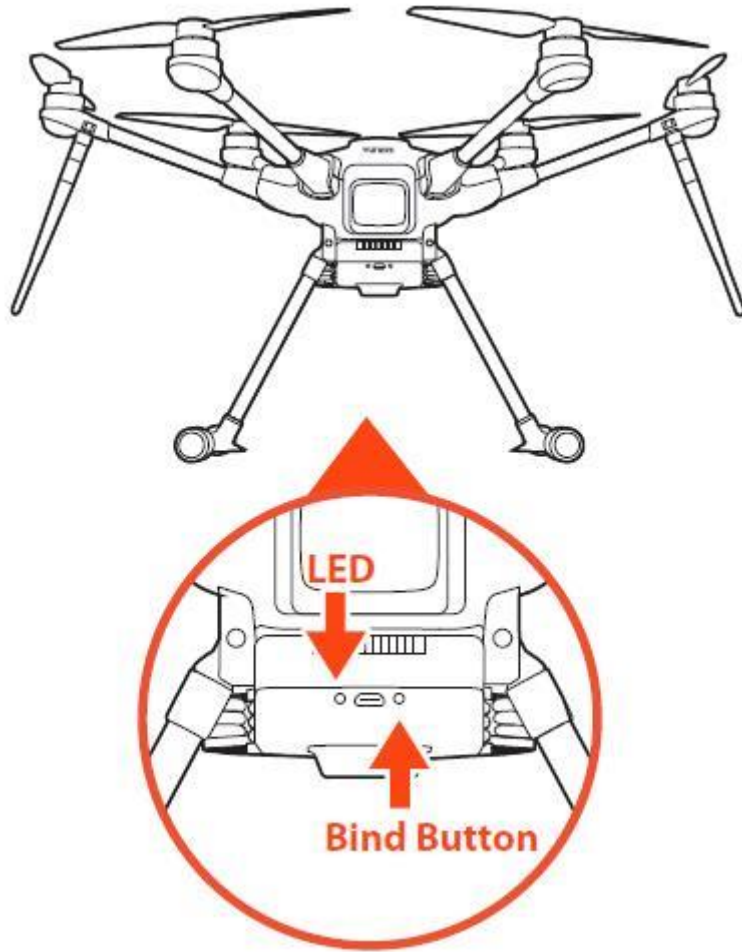

**Step 7:** Tap the Next button on the ST16E screen.

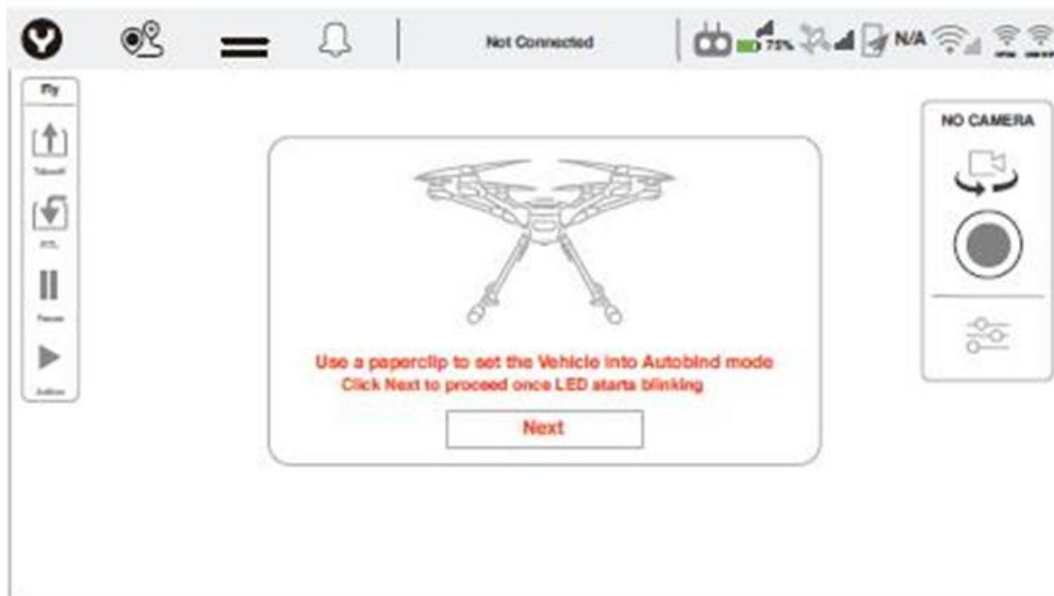

**Step 8:** Waiting for connect finished.

**Step 9:** Tap Finish to complete the binding process.

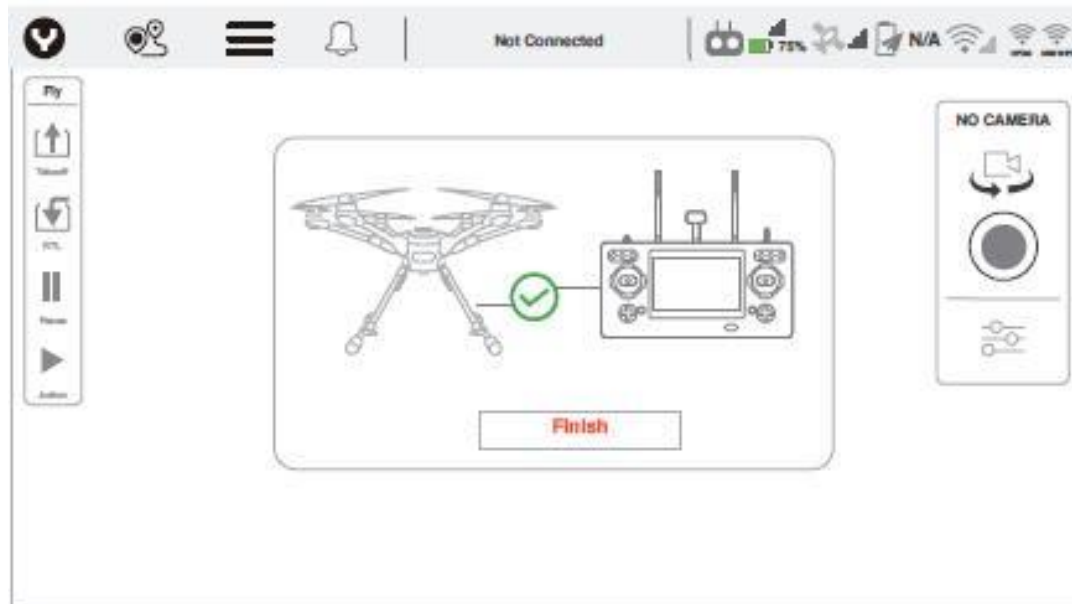

### **CALIBRATING THE COMPASS**

In the following situations recalibrating the Compass is suggested for flight safety:

1. Before the first flight when you take the drone out of the box;
2. After a long distance trip;
3. Every time the payload has been replaced;
4. The drone alarms a compass warning.

#### **Calibrating**

In the Settings Menu, tap Sensors | Compass. Follow the onscreen display and instructions.

During Compass calibration, the H520E/H520E-RTK will need to rotate along the specific axis which shown by the LED under the Motor Arm until a tone is heard and the display turns green. Repeat this procedure for all six positions. If Compass calibration fails, ensure there are no electronic devices or metal objects within ten feet of the H520E/H520E-RTK. A yellow box with a red arrow indicates the current calibration. A green box indicates a completed position.

**Notice:** If all six led lights flash Red rapidly, the Compass calibration has failed. Restart the procedure. If the issue persists, move the H520E/H520E-RTK to a different location. Or contact Yuneec customer service via <https://yuneec.kayako.com>.

**Notice:** After Compass calibration was finished, Please reboot the drone.



## During Calibration

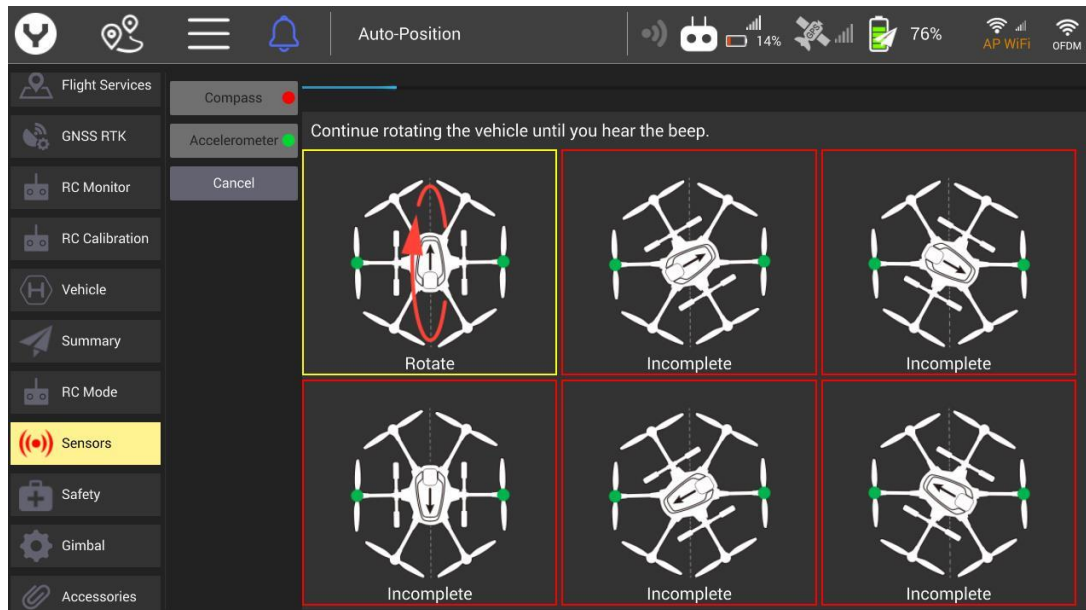

## Calibration Finished

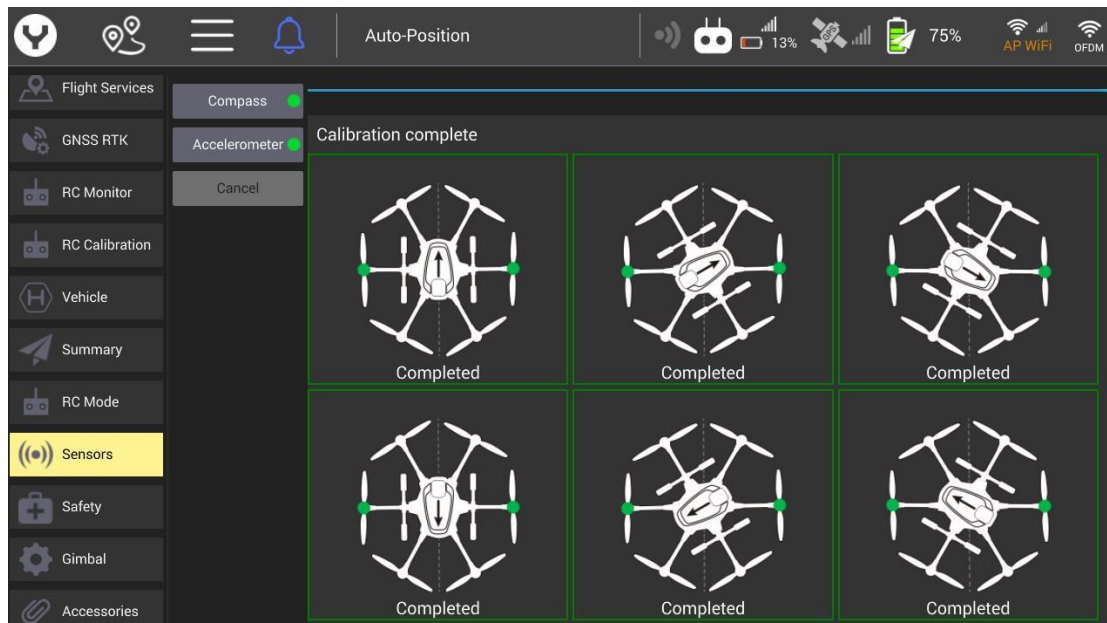

## Download the Map

In order to download the map the ST16E need to be connected to the internet via Wi-Fi  
Tap the Wi-Fi mark then select a hotspot

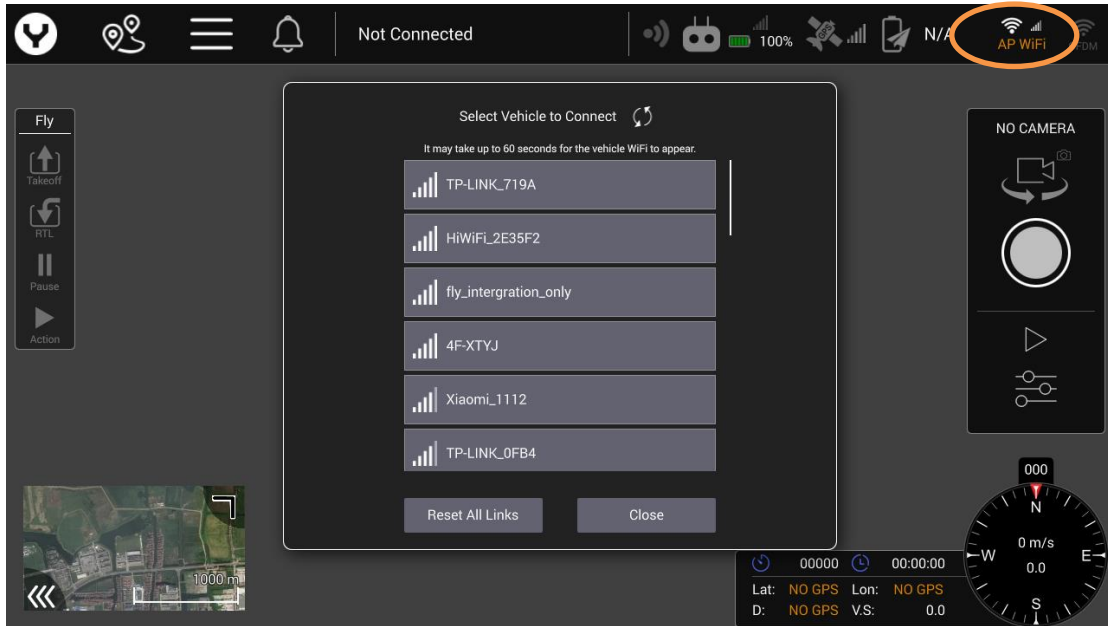

When the ST16E was connected with Wi-Fi it will download the map automatically, Slide the screen to move the map to arrive your required area for downloading. To Switching the map or video as main interface by tapping the rectangular window on the lower left corner of the screen.

## RTK data binding (For H520E-RTK only)

### Option 1

#### CORS Network Binding:

**Notice:** Please download the map first then connect the ST16E to the RTK data link.

**Step 1:** After the ST16E and drone are bound, tap the **Wi-Fi** logo and select a Hotspot to make connect the ST16E to the internet.



**Notice:** If conditions permit, please use the 5 GHz Wi-Fi to transfer the RTK data between the hotspot with ST16E for stable communication quality.

**Step 2:** Tap the **Settings** icon then tap **GNSS RTK**. Select **NTRIP** as the RTCM source, then tick **Auto Reconnect**.

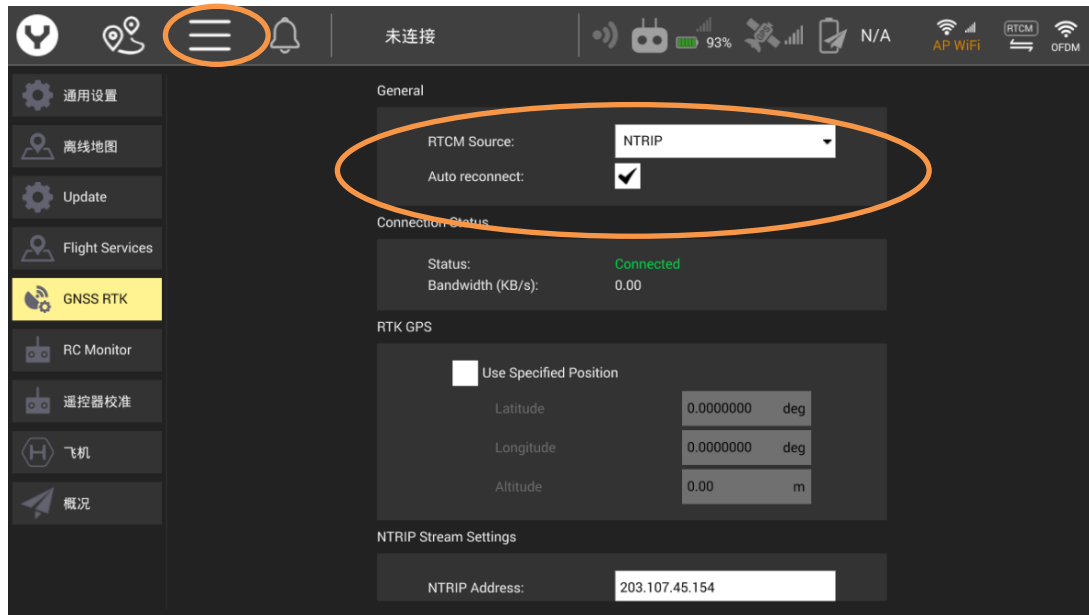

**Step 3:** Fill the following NTRIP Stream Settings parameters according to your CORS Network

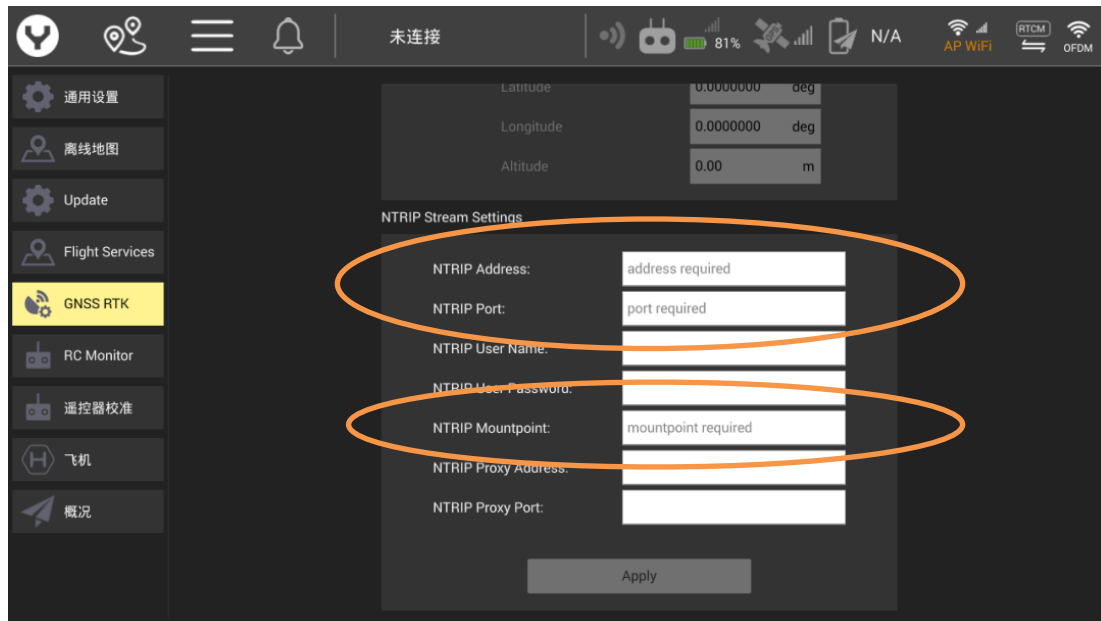

**Notice:** You must fill out the Required Tagging Form

**Step 4:** Tap Apply to finish the connection process.

**Notice:** When connection to the CORS Network has been successful, the Connection Status display will display a green "Connected".

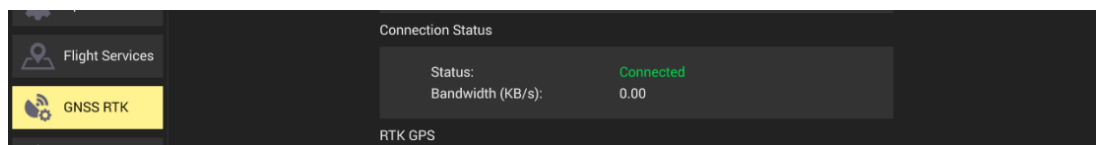

**Option 2:**

**RTK GPS Station Binding:**

The binding instruction of each RTG GPS Station will be attached with the GPS Station Kit. Please refer to the corresponding sections to bind.

**Take Off**

**OPTION 1**

Press and hold the START/STOP button for about 3 seconds to start the motors in angle mode.

Slowly raise the left-hand stick to take off



**OPTION 2**

Tap the Take Off and slide on the screen to take off. There is also a Landing soft key beneath the takeoff soft key that may be used for Auto-Landing.

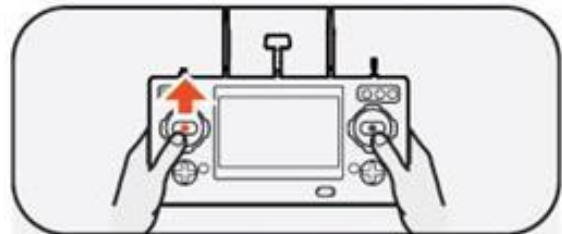

**Retract Landing Gears**

Raise the landing gear control using the landing gear control switch on the ST16E.



## Control the drone

### Normal Flight Control

Out door flight

Flight Mode Switch Overview

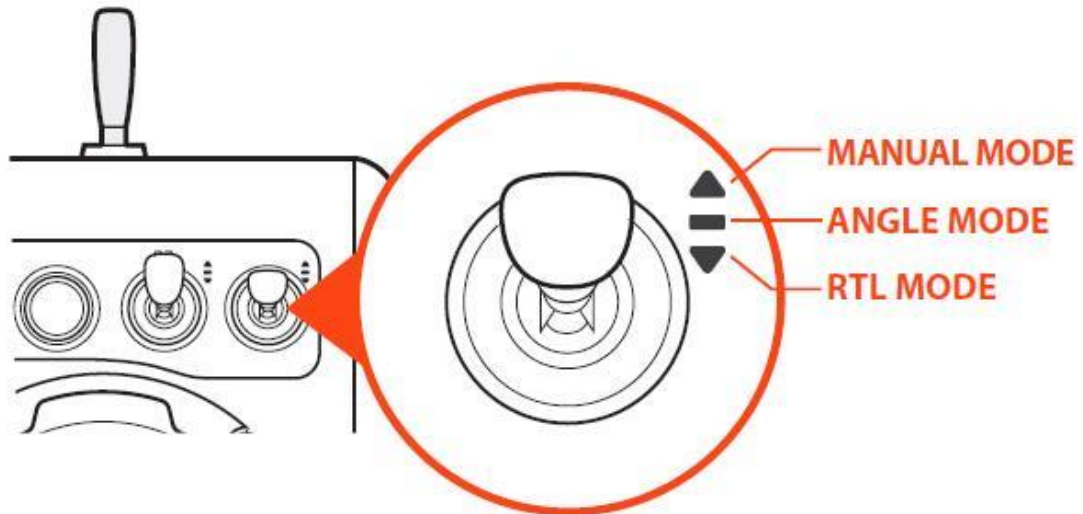

### ANGLE MODE

When in Angle Mode and GPS is available, the drone will respond according to the ST16E remote controller.

**Tips:** Fly low and slowly initially.

Slow (Lo Speed) position is ideal for precision flight. High-speed (Hi Speed) position is used when transiting broad areas.

### RTL MODE

When in RTL Mode, the drone will return to the home point and automatically lower the retractable gear to land.

### MANUAL MODE

When in Manual Mode, GPS will be deactivated. The aircraft will only use its barometer for positioning to control the altitude. In the Manual Mode, the maximum horizontal speed of the drone can reach 33.6mph (15m/s).

**Tips:** Manual mode is not recommended for first-time pilots. Without GPS, the aircraft will drift in slight winds and will not maintain position.

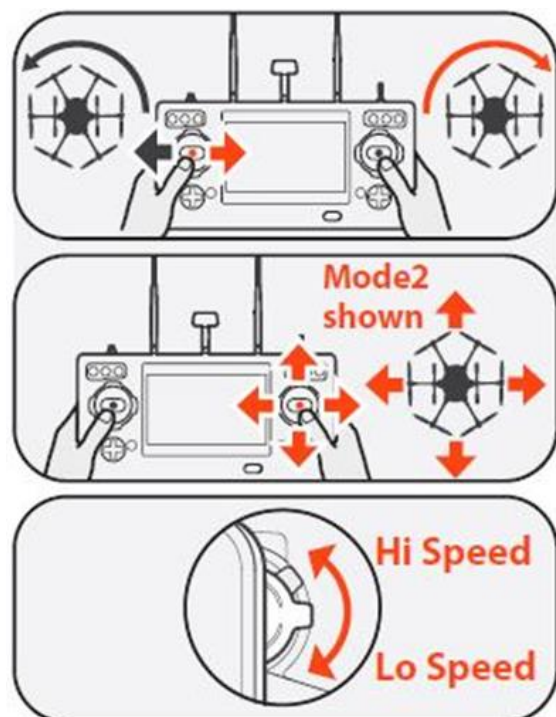

## Indoor flight

When fly the drone without GPS signal, please switch to the indoor flight mode first then start the motors

**Step 1:** After the drone and ST16E was connected tap the system setting button then select the Vehicle item, tap the Indoor Mode button.

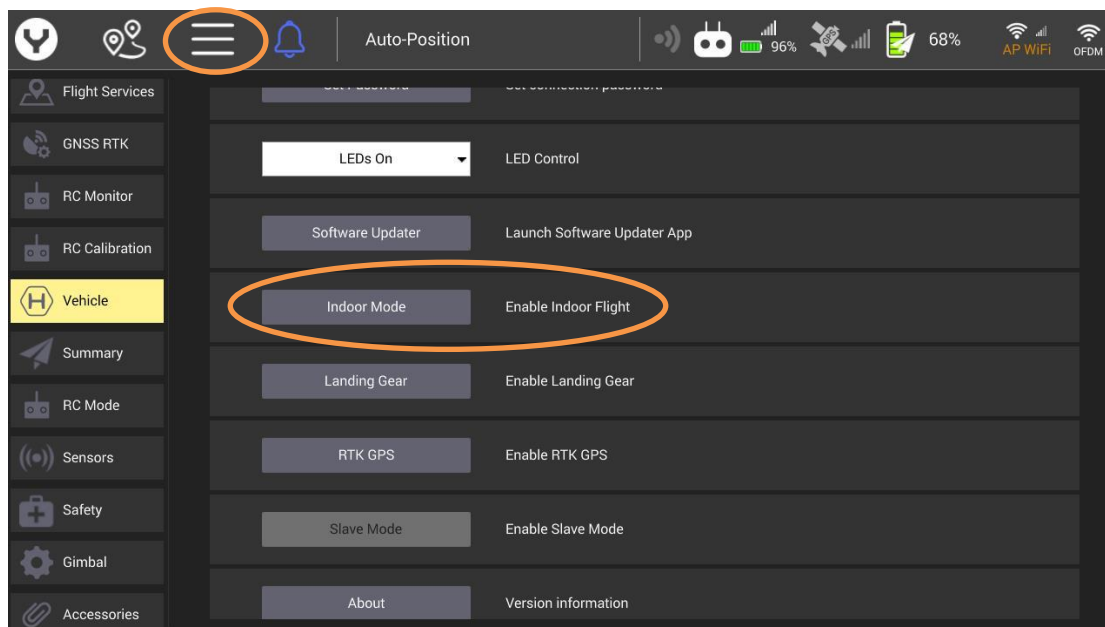

**Step2:** Tick the Enable Indoor Flight

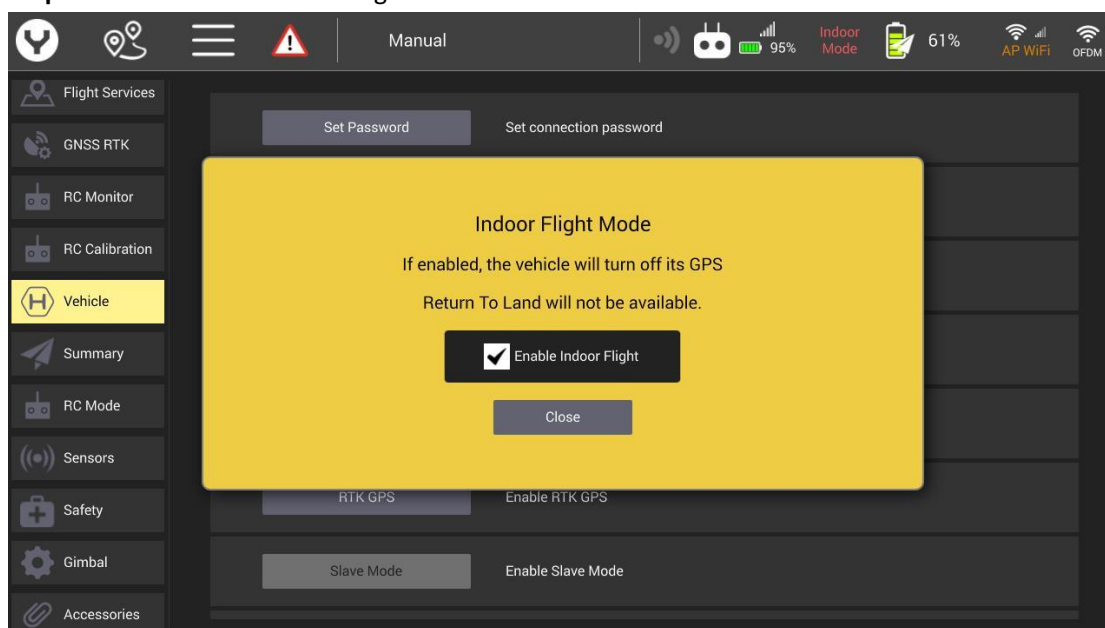

**Step 3:** Push the Flight Mode Selection Switch to the Manual Flight Mode then press and hold the START/STOP button for about 3 seconds to start the motors.

**Notice:** Please switch back to outdoor flight mode after each indoor flight; otherwise the drone won't get GPS lock when flying outdoor next time.



## Gimbal Control

### GIMBAL CAMERA TILT CONTROL

There is a gimbal tilt mode switch on ST16E. When the switch is in up/middle position, the gimbal camera is in Tilt Angle Mode. Use the Gimbal Tilt Control Slider on the left side of the ST16 to set the tilt position of the gimbal camera.

When the Switch is in bottom position, the gimbal camera is in Velocity Mode. When the Gimbal Tilt Control Slider is in the middle position, it means the Tilt velocity rate is 0 for the gimbal, and it will stop tilting up/down

When the Gimbal Tilt Control Slider is above the middle position, the gimbal will start tilting up.

When the Gimbal Tilt Control Slider is below the middle position, the gimbal will start tilting down. The distance between the Gimbal Tilt Control Slider and the middle position decides the velocity rate, the further distance, the higher velocity it would be.

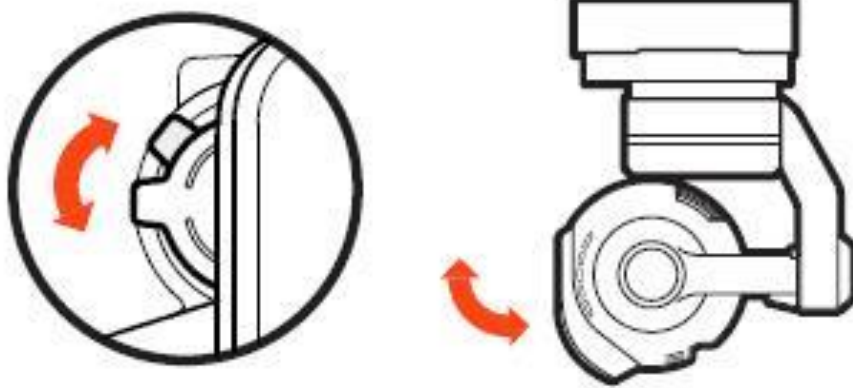

### GIMBAL CAMERA PAN CONTROL

There is a gimbal pan mode switch on ST16E. When the switch position is up, the gimbal camera is in Follow Mode. The pan control of the gimbal camera is now disabled. The gimbal camera will adjust its pan direction according to the aircraft's movements.

When the switch is in the middle position, the gimbal camera is in Follow Pan Controllable Mode, the gimbal camera will adjust its pan direction according to the aircraft's movements.

Meanwhile, the pan control is activated, use the Pan Control Knob to set the pan position of the gimbal camera. When the switch position is down, the gimbal camera is in Global Mode. The pan direction of the gimbal camera will be fixed regardless of the aircraft's movements in the range of  $\pm 165^\circ$ . Use the Pan Control Knob to set the pan position of the gimbal camera.

## Land

Lower the landing gear using the same control as used for retracting landing gear. Lower the landing gear at least 12' above the landing area.

Slowly lower the Throttle stick below the center position, the drone will descend slowly and land. After lands, the motors will stop after 2 seconds without any operation.

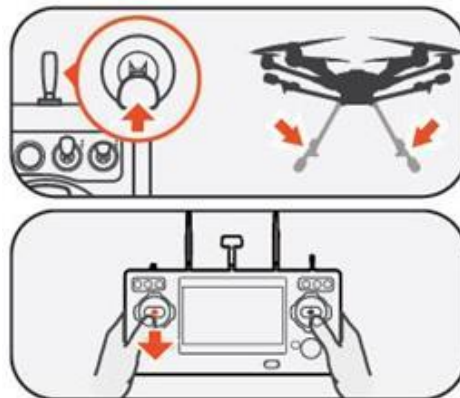

## Mission Flight Mode

To enter Mission planning mode, tap the Mission Route Setting icon[  ] on the top of the DataPilot™ home screen. The PLAN window will open, allowing users to create Waypoint and Survey missions, sync missions between desktop, ST16E, and the drone, store/recall missions, and Center a mission around a particular point on the ST16E screen.

### Waypoint

A waypoint defines a specific location and behavior at a specific point in time, allowing for intelligent auto-functions during flight. Waypoint flight is ideal for capturing oblique images, perimeter monitoring, and many other uses.

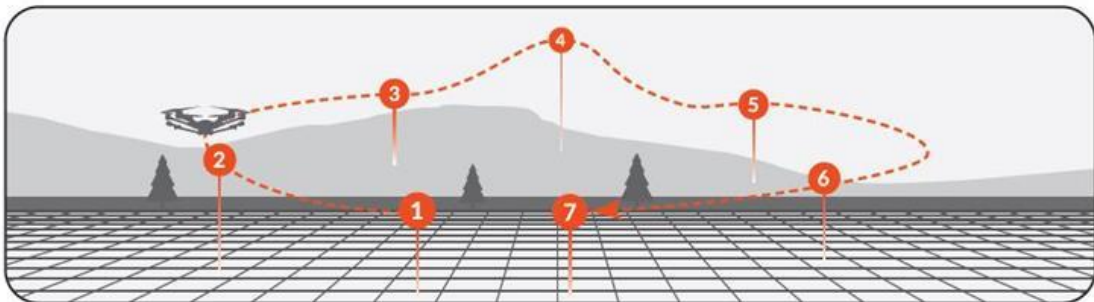

### Add Waypoints

After entered the Mission planning mode, select the waypoint function and tap the location on the screen where the waypoint is needed to add a waypoint.

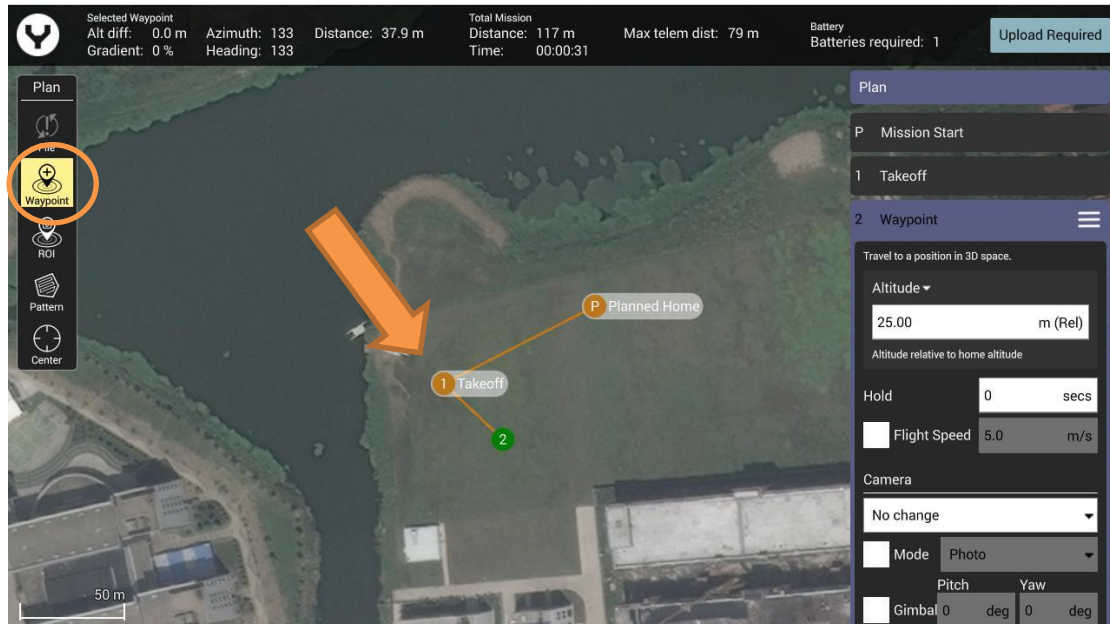

### Adjust the waypoint

Drag the selected waypoint directly to adjust the position roughly. Each waypoint has its own setting panel for further settings

### Waypoint Setting Panel

Once a waypoint was set and selected, the screen will pop up the Way point Setting Panel on the right side. In this panel almost every parameter of a waypoint can be set freely, such as Altitude, Flight speed, Hold Time, etc. Even the direction of the gimbal and the camera behaviors was also included.

**Notice:** To set the Planned Home Position Parameters and the behavior when mission was finished, or other global settings of the mission please open the Mission Start Setting Panel Which above all the Waypoint Setting Panel.

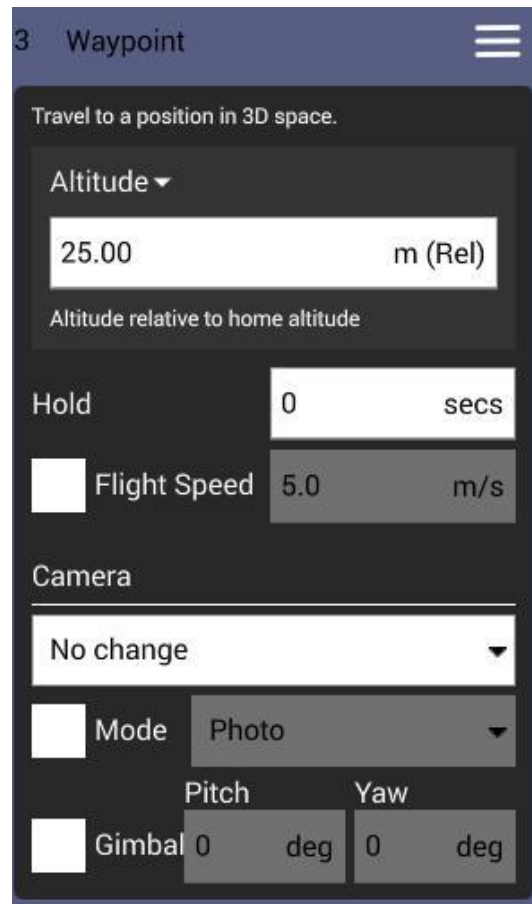

### Others Setting Menu

There is an Others Setting Menu Switch [  ] on the title of each waypoint setting panel, tap this switch to insert a new waypoint or a pattern after the specific waypoint, delete this waypoint, or type in the accurate Geographical coordinates Under the Edit position menu for the selected waypoint.

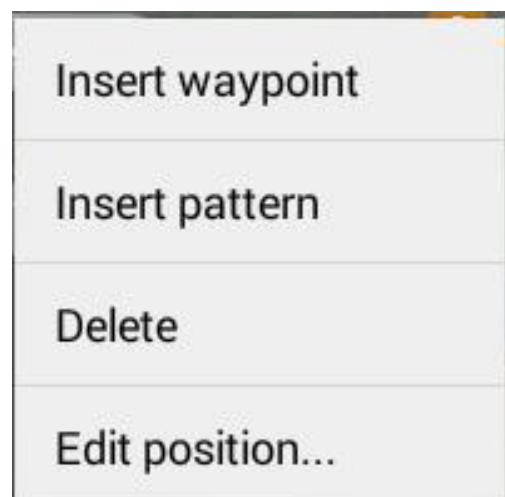

## Pattern

Pattern is designed for mapping and 3D scanning of ground-based objects.

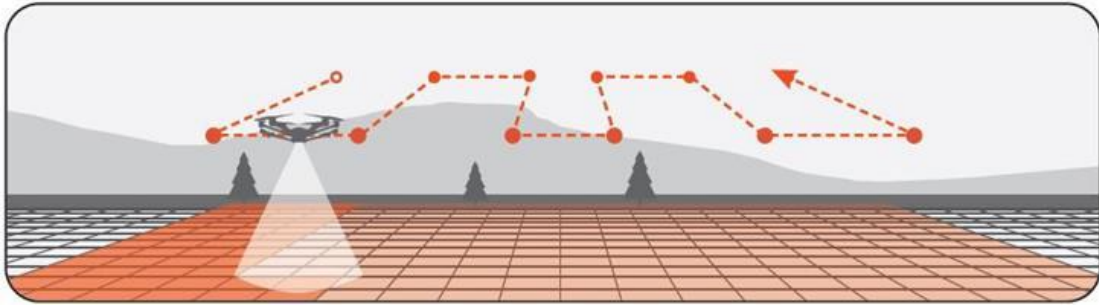

## Survey Mode

Survey mode allows the Pilot to quickly place a survey grid over a desired area. To select a survey grid mission, tap the Pattern Icon in the Plan panel and select Survey function.

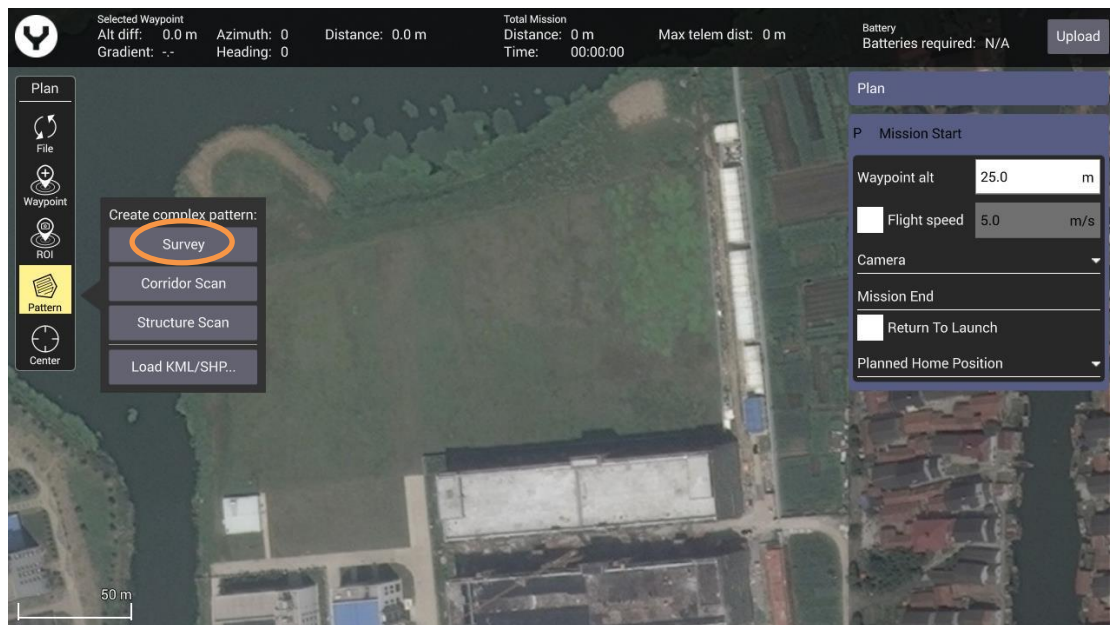

This will place a green survey grid in the middle of the screen over the map. To move the survey grid around the map, hold and drag the white dot in the center of the survey grid. Tapping and dragging a white dot on the outside of the survey grid allows the dimensions of the survey grid to be adjusted. Tapping a '+' dot allows the Pilot to add more white dots to the edge of the survey grid for finer flight paths.



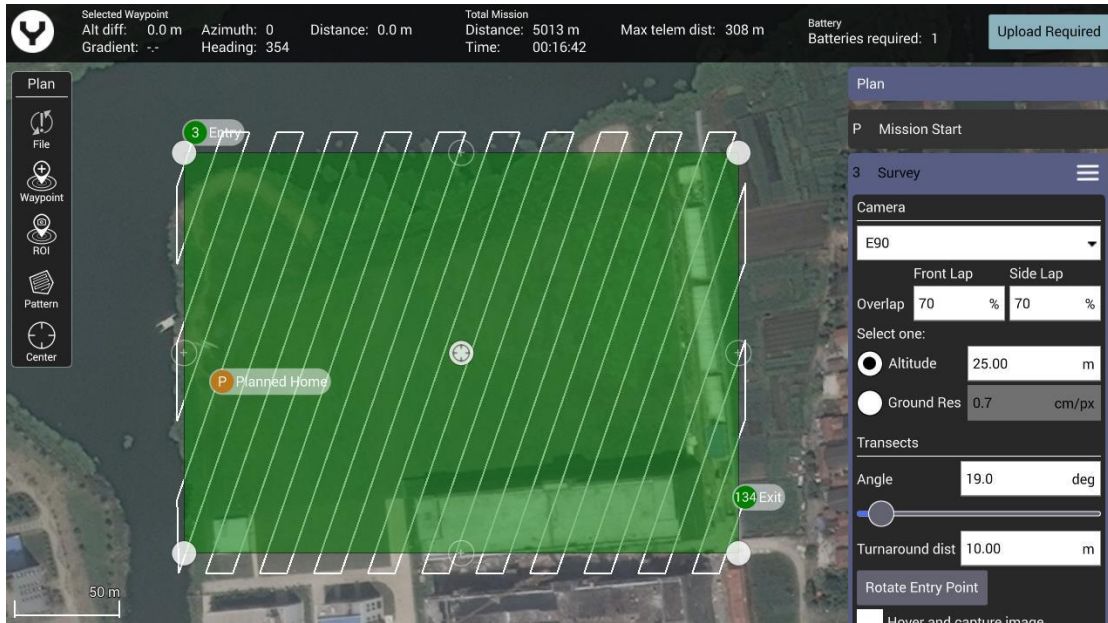

**Notice:** As same as the Waypoint function there is also a Survey Setting Panel on the right side. Through this panel users can set all the Survey parameters. Drag the panel up and down to view more items.

### CORRIDOR SCANS

Roadways, power lines, train tracks, footpaths, and other narrow winding areas may be set up as “corridor scans.” Corridor scans enable the drone to fly long pathways with overlap for these sorts of missions



*This is an example of a corridor scan*

To create the CORRIDOR SCAN, tap the “Pattern” soft key, and select CORRIDOR SCAN.

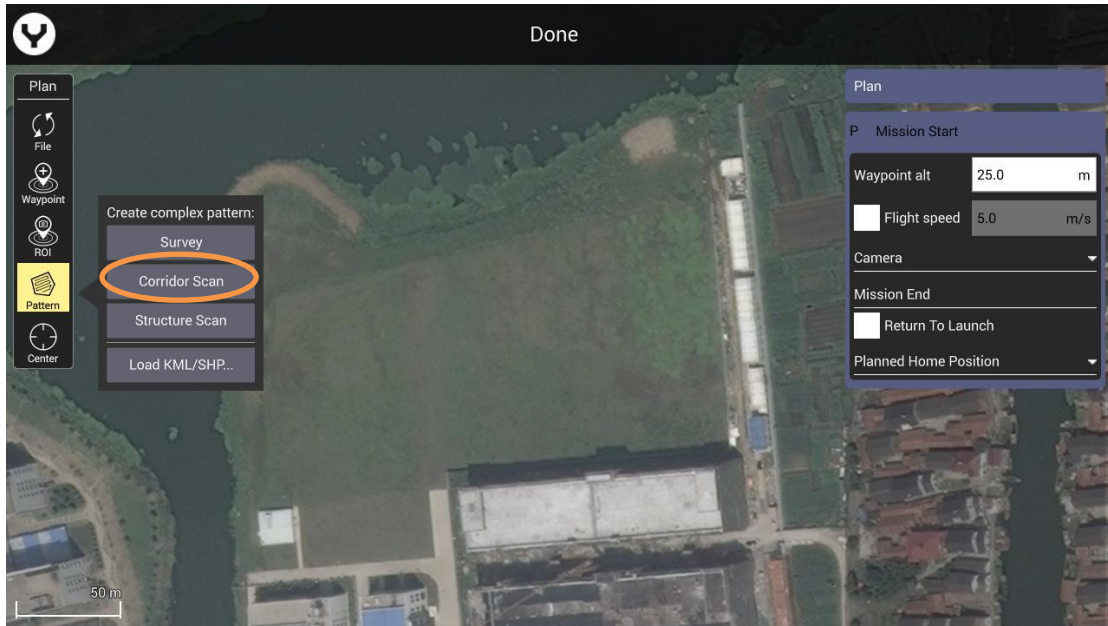

The CORRIDOR SCAN Setting Panel will open with a base, straight, CORRIDOR SCAN in place. The small "+" symbol in the vertex allows additional vertices to be created/inserted in the pathway, allowing for numerous angles to follow the road (as seen in the image on the previous page). The aircraft will fly the white lines detailed in the pathway.



*In this image, seven vertices have been inserted, allowing the Drone to follow the curvature of the roadway.*

**Notice:** Be similar with the Waypoint function the CORRIDOR SCAN Setting Panel shown on the right side. Through this panel users can set all the CORRIDOR SCAN parameters. Drag the panel up and down to view more items.



## STRUCTURE SCANS



A *Structure Scan* allows users to create a grid flight pattern that captures images over *vertical surfaces* (e.g. walls) around a structure with an arbitrary polygonal (or circular) ground footprint. Structure Scans may be combined with nadir/survey flights to better serve architects, engineers, and construction companies looking to create accurate 3D models, or output .las files to products such as Revit or Autodesk workflows.

Structure scans may also be used for virtually any vertical scan element, and may be combined with other automated flight profiles

The concept of the STRUCTURE SCANS  
Function ->

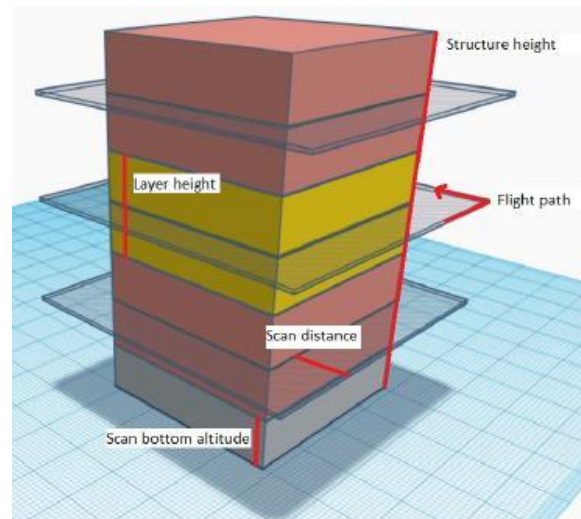

Structure Scans may be inserted into a mission using the Plan view **PLAN | PATTERN | Structure Scan** tool.

Using the map function, zoom to the geographic area to be scanned, and center it on the screen for best access.

After opening the PATTERN dialog, choose Structure Scan from the dropdown menu.

A green overlay will appear with four corners. The region shown in green must be modified so that it surrounds the structure.

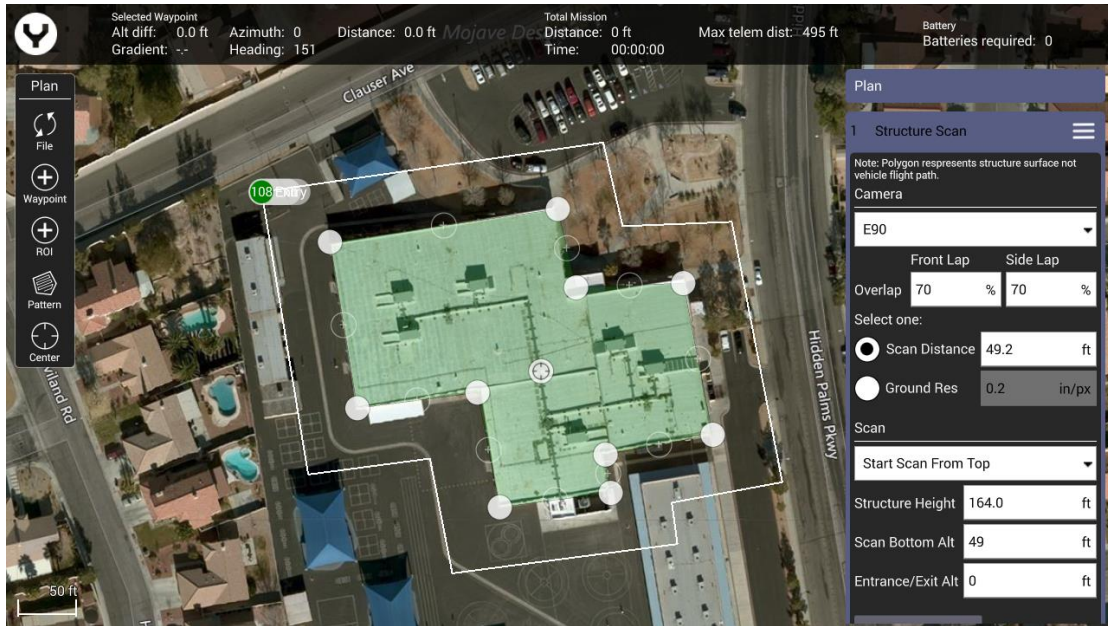

- Drag the opaque vertices on the map to the edge of the structure.
- If the structure footprint is more than a simple square, click the semi-transparent circles between the vertices to create a new vertex. This allows for complex shapes such as the one seen above.

### Update/Save the Flight Mission

No matter what kind of the flight mission function you are using, after the flight path has been set, tap the file button to save the mission in the ST16E or upload the mission to the drone directly if the controller is connected with drone.

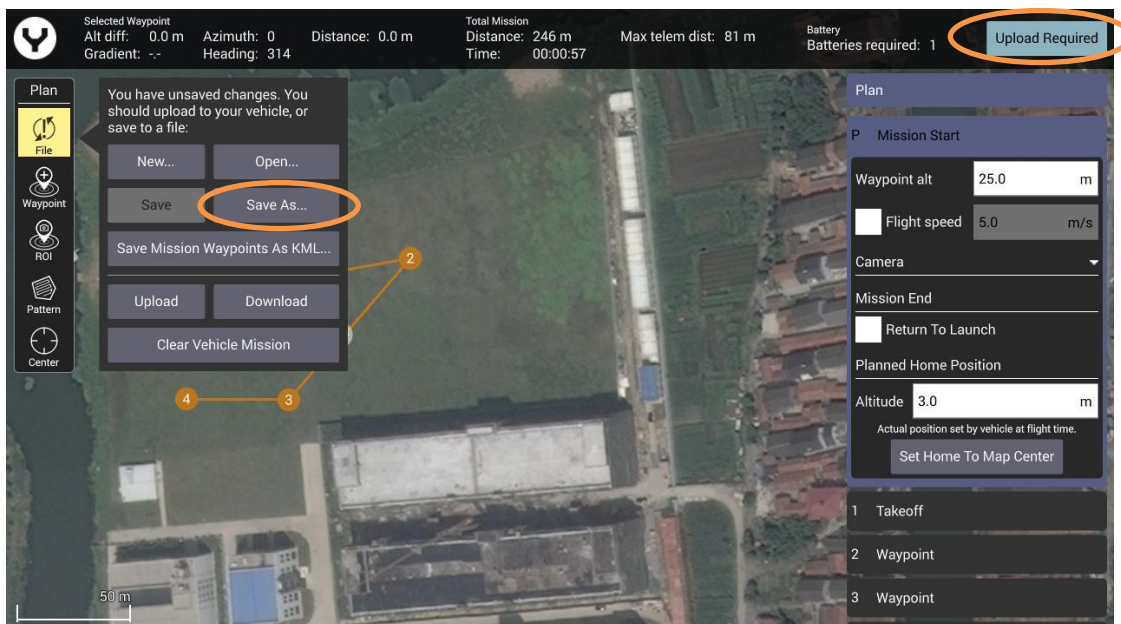

### Execute the Flight Mission

In the condition of GPS Locked in Angel Flight Mode, after the flight path has been uploaded to the drone tap the Main Interface button [  ] to switch back then slide the slider. The drone will execute the mission automatically.

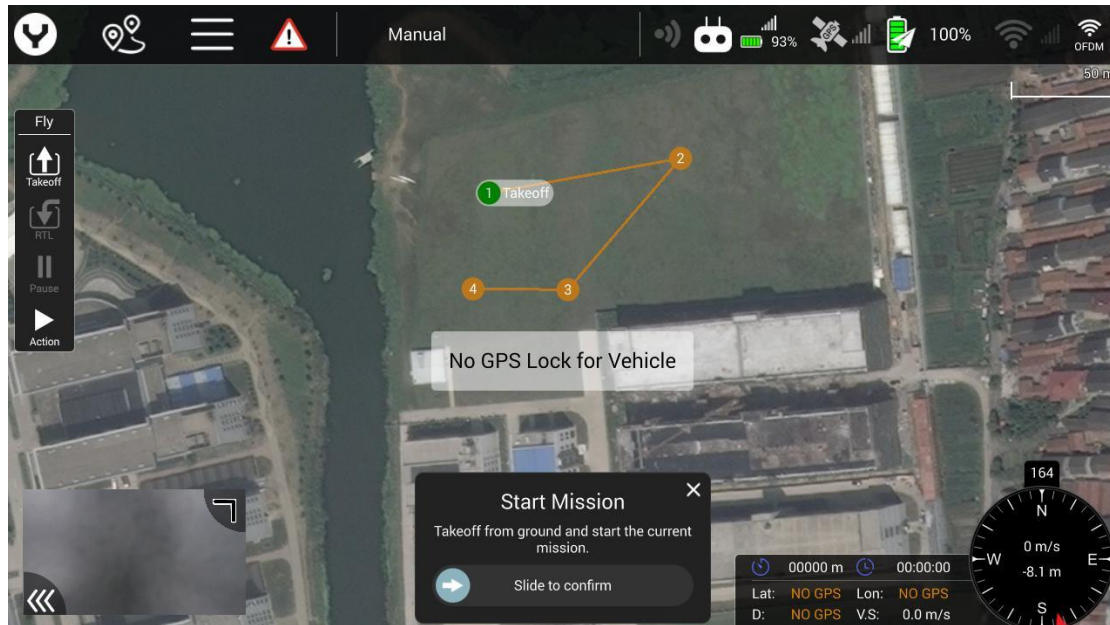

## Attachment

### Specification

#### Drone

Type	H520E	H520E-RTK
Weight	1856g(Without Camera)	1892g(Without Camera)
Diagonal Size	520mm	520mm
Max Angular Velocity	120°/s	120°/s
Max Ascend Speed	4m/s	4m/s
Max Descent Speed	2.5m/s	2.5m/s
Max Horizontal Speed	13.5m/s	13.5m/s
Max Flight Height	500m	500m
Max Takeoff Sea Level	5000m	5000m
Max Flight Time	30min(With E90)	25min(With E90)
The propeller diameter	248mm	248mm
The Motor Type	BL3210	BL3210
The Motor KV Value	730	730
Battery	LiHv 4s 6200mAh	LiHv 4s 6200mAh
Charger	SC4000-4E	SC4000-4E
Recharge Time	2 hours	2 hours
Hovering Accuracy	Horizon:±1.5m;Vertical:±0.5m	Horizon:±1.5m;Vertical:±0.5m
DGPS(RMS) Accuracy	N/A	Horizon:±0.4m;Vertical:±0.8m
RTK(RMS) Accuracy	N/A	1cm +1ppm(H); 1.5cm+1ppm(V)
Operating Temperature	0°C -40°C	0°C -40°C
Payload	X Connector Series Gimbals	X Connector Series Gimbals

#### ST16E Ground Station

Operating System	Android
Operating Frequency	2.400 - 2.483 GHz
Transmission Power (EIRP)	2.4 GHz CE<20dBm FCC <30dBm
Max Transmitting Distance (unobstructed, free of interference)	CE: 4km FCC: 6km
Video Output Ports	HDMI
OSD Supported	Yes
Built-in Screen Size	7 inch
Video Link Resolution	720P
Operating Temperature	0°C -40°C ( 32 degree to 104 degree F )
Battery	3.6V 8700mAh 31.32Wh Li-ion
USB Supply Power	5V



## LED Status Indication

All the LEDs mentioned are numbered as shown.

The color of the icon indicates the color of the LED.

☀ indicates the LED flashing.

● indicates the LED solid on.

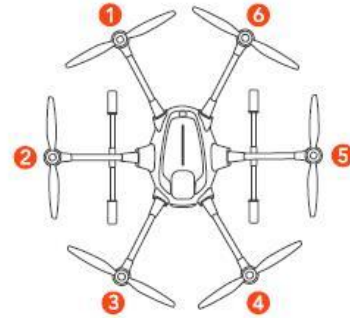

## Disclaimer

Yuneec International (China) Co., Ltd shall not be held liable for any damage, injury or for use of the product in violation with legal regulations, especially in the following circumstances:

Damage and/or injury as well violation of legal regulations resulting from a failure to comply with the operating instructions or the instructions at [www.yuneec.com](http://www.yuneec.com), product information, user manual and other legally binding information;

Damage and/or injury as well violation of legal regulations brought about by the influence of alcohol, drugs, medication or other narcotics which may impact on the concentration of the user; The same applies to illnesses effecting the concentration of the user (dizziness, tiredness, nausea etc.) or other factors compromising mental and physical capabilities.

Intentionally caused damage, injury or violation of legal regulations;

Any request for compensation caused by an accident resulting from use of the product;

Malfunction of the product caused by retrofitting or replacement with components which did not come from Yuneec;

Damage and/or injury caused by the use of replica parts (non-original parts);

Damage and/or injury as well as violation of legal regulations caused by incorrect operation or misjudgment;

Damage and/or injury caused by damaged spare parts or not using original Yuneec spare parts;

Damage and/or injury caused by unauthorized change settings and/or parameters;

Damage and/or injury caused by modify and/or add parts;

Damage and/or injury as well as violation of legal regulations caused by ignoring the low voltage battery warning;

Damage and/or injury caused by knowingly and negligibly flying with a damaged model or one which is unfit to fly, e.g. due to dirt, water penetration, coarse particles, oil or a model which has not been correctly or completely assembled or if the main components exhibit visible damage, defects or missing parts;

Damage and/or injury as well as violation of legal regulations caused by use of the product in a no-fly zone, e.g. next to an airfield, above a motorway or a natural conservation area;

Damage and/or injury as well as violation of legal regulations caused by operating the model in a magnetic field (e.g. high voltage lines, electricity/ transformer stations, radio towers, mobile phone masts etc.), a strong wireless signal environment, no-fly zones, poor visibility and in the event of vision impairments or other impacts on the pilot which are left unchecked etc. ;

Damage and/or injury brought about through a violation of the legal regulations for operating the model, in unsuitable weather conditions, e.g. rain, wind, snow, hail, storms, hurricanes etc. ;

Damage and/or injury as well as violation of legal regulations caused by force majeure, e.g.

collision, fire, explosion, flooding, tsunami, landslide, avalanche, earthquake or other forces of nature;

Damage and/or injury as well as violation of legal regulations caused by the illegal or immoral use of the model, e.g. capturing videos or recording data which infringes upon/harms the privacy of other people;

Damage and/or injury as well as violation of legal regulations caused by incorrect use of the batteries, protection systems, chargers or aircraft;

Consequential damage caused by the incorrect operation of any kind of system components and accessory parts, especially memory cards, whereby image or video material from the camera can become defect;

Any non-compliance with legal obligations, personal injury, material damage and environmental damage caused by use and a failure to comply with the local laws and regulations;

Damage and/or injury as well as violation of legal regulations caused by hazardous use without sufficient practical experience;

Damage and/or injury as well as violation of legal regulations caused by flying in legally defined no-fly zones.

Further losses which do not fall within the scope of use defined by Yuneec as improper.

This product is designed for both professional use and personal private use. The national and international laws and regulations in force as the time of taking off must be adhered to.

### **Collection and Processing of Data**

Yuneec may collect navigation information such as GPS data to help improve our products.

We may also collect Depth Map information and Infrared Image information from your drone delivered to our service center for repair and maintenance service or any other service.

We may also collect other information such as device information, server log information, etc.

We may also collect personal information used in registration if you choose to become a registered user and any other information user provided to Yuneec. We may also collect information which users send to other users, and the recipients and senders of such information.

We reserve the right to disclose your information if required to do so by law or in the good-faith belief that such disclosure is needed to comply with applicable laws, for example in response to a court order, judicial subpoena, warrant or request from government, or otherwise cooperating with government agencies or law enforcement.

We also reserve the right to disclose your information that we believe in good faith is necessary or appropriate to: (i) protect ourselves or others from fraudulent, unlawful, or abusive activities; (ii) take precautions against potential liability; (iii) protect the security of the Yuneec Apps embedded into or downloaded onto your drone or any associated equipment and services; (iv) protect the legal rights of ourselves or any others.

Any information we collected maybe disclosed or transferred to an acquirer, successor or assignee as part of any potential merger, acquisition, debt financing or other activities that involves transfer of business assets.

We may make the aggregated non-personal information of the users available to third parties for various purposes, including (i) complying with various report obligations; (ii) marketing efforts; (iii) analyzing product safety; (iv) understanding and analyzing our users' interests, habits, usage pattern for certain functionalities, services, content, etc.



## Battery Warnings and Usage Guidelines

**WARNING:** Lithium Polymer (LiPo) batteries are significantly more volatile than alkaline, NiCd or NiMH batteries. All instructions and warnings must be followed exactly to prevent property damage and/or serious injury as the mishandling of LiPo batteries can result in \_re. By handling, charging or using the included LiPo battery you assume all risks associated with LiPo batteries. If you do not agree with these conditions please return the complete product in new, unused condition to the place of purchase immediately.

You must always charge the LiPo battery in a safe, well-ventilated area away from flammable materials.

Never charge the LiPo battery unattended at any time. When charging the battery, you must always remain in constant observation to monitor the charging process and react immediately to any potential problems that may occur.

After flying/discharging the LiPo battery you must allow it to cool to ambient/room temperature before recharging.

To charge the LiPo battery you must use only the included charger or a suitably compatible LiPo battery charger. Failure to do so may result in a fire causing property damage and/or serious injury.

If at any time the LiPo battery begins to balloon or swell, discontinue charging or discharging immediately.

Quickly and safely disconnect the battery, then place it in a safe, open area away from flammable materials to observe it for at least 15 minutes. Continuing to charge or discharge a battery that has begun to balloon or swell can result in a \_re. A battery that has ballooned or swollen even a small amount must be removed from service completely.

Do not over-discharge the LiPo battery. Discharging the battery too low can cause damage to the battery resulting in reduced power, flight duration or failure of the battery entirely. LiPo cells should not be discharged to below 3.0V each under load.

Store the LiPo battery at room temperature and in a dry area for best results.

When charging, transporting or temporarily storing the LiPo battery the temperature range should be from approximately 40–120 ° F (5–49 ° C). Do not store the battery or aircraft in a hot garage, car or direct sunlight. If stored in a hot garage or car the battery can be damaged or even catch fire.

Never leave batteries, chargers and power supplies unattended during use.

Never attempt to charge low voltage, ballooned/swollen, damaged or wet batteries.

Never allow children less than 14 years of age to charge batteries.

Never charge a battery if any of the wire leads have been damaged or shorted.

Never attempt to disassemble the battery, charger or power supply.

Never drop batteries, chargers or power supplies.

Always inspect the battery, charger and power supply before charging.

Always ensure correct polarity before connecting batteries, chargers and power supplies.

Always disconnect the battery after charging.

Always terminate all processes if the battery, charger or power supply malfunctions.

## General Safety Precautions and Warnings

**WARNING:** Failure to use this product in the intended manner as described in the quick start guide and instruction manual can result in damage to the product, property and/or cause serious injury.

A Radio Controlled (RC) multirotor aircraft, APV platform, drone, etc. is not a toy! If misused it can cause serious bodily harm and damage to property.

**WARNING:** As the user of this product you are solely and wholly responsible for operating it in a manner that does not endanger yourself and others or result in damage to the product or the property of others.

Keep your hands, face and other parts of your body away from the spinning propellers/rotor blades and other moving parts at all times. Keep items that could impact or become entangled away from the propellers/rotor blades including debris, parts, tools, loose clothing, etc.

Always operate your aircraft in open areas that are free from people, vehicles and other obstructions.

Never fly near or above crowds, airports or buildings.

To ensure proper operation and safe flight performance never attempt to operate your aircraft nearby buildings or other obstructions that do not offer a clear view of the sky and can restrict GPS reception.

Do not attempt to operate your aircraft in areas with potential magnetic and/or radio interference including areas nearby broadcast towers, power transmission stations, high voltage power lines, etc.

Always keep a safe distance in all directions around your aircraft to avoid collisions and/or injury. This aircraft is controlled by a radio signal subject to interference from many sources outside your control.

Interference can cause momentary loss of control.

To ensure proper and safe operation of the automatic landing function in Return Home Mode you must start the motors with the aircraft in an open space and achieve a proper GPS lock.

Do not attempt to operate your aircraft with any worn and/or damaged components, parts, etc. including, but not limited to, damaged propellers/rotor blades, old batteries, etc.

Never operate your aircraft in poor or severe weather conditions including heavy winds, precipitation, lightning, etc.

Always begin to operate your aircraft with a fully charged battery. Always land as soon as possible after the first level low voltage battery warning or land immediately after the second level low voltage battery warning.

Always operate your aircraft when the voltage of the battery in the transmitter/personal ground station is in a safe range (as indicated by the LED status indicator light of the transmitter/personal ground station).

Always keep the aircraft in clear line of sight and under control, and keep the transmitter/personal ground station powered on while the aircraft is powered on.

Always move the throttle control stick down fully and turn off the power in the event the propellers/rotor blades come into contact with any objects.

Always allow components and parts to cool after use before touching them and flying again.

Always remove batteries after use and store/transport them per the corresponding guidelines.

Avoid water exposure to all electronic components, parts, etc. not specifically designed and protected for use in water. Moisture causes damage to electronic components and parts.

Never place any portion of the aircraft or any related accessories, components or parts in your mouth as doing so could cause serious injury or even death.

Always keep chemicals, small parts and electronic components out of the reach of children.

To ensure safe fly, it is recommended to install the propeller protectors when operating the aircraft indoors or nearby crowds.

Carefully follow the instructions and warnings included with this aircraft and any related accessories, components or parts (including, but not limited to, chargers, rechargeable batteries, etc.).

### **FCC Statement**

This device complies with part 15 of the FCC rules. Operation is subject to the following two conditions: (1) This device may not cause harmful interference, and (2) this device must accept any interference received, including interference that may cause undesired operation.

**NOTE:** The manufacturer is not responsible for any radio or TV interference caused by unauthorized modifications to this equipment. Such modifications could void the user's authority to operate the equipment.

This equipment has been tested and found to comply with the limits for Part 15 of the FCC rules. These limits are designed to provide reasonable protection against harmful interference in a residential installation. This equipment generates, uses and can radiate radio frequency energy and, if not installed and used in accordance with the instructions, may cause harmful interference to radio communications.

However, there is no guarantee that interference will not occur in a particular installation.

If this equipment does cause harmful interference to radio or television reception, which can be determined by turning the equipment off and on, the user is encouraged to try to correct the interference by one or more of the following measures:

- Reorient or relocate the receiving antenna.
- Increase the separation between the equipment and receiver.
- Connect the equipment to an outlet on a circuit different from that to which the receiver is connected.
- Consult the dealer or an experienced radio/TV technician for help.

### **RF Exposure Warning for FCC ID: 2ACS5-ST16E Personal Ground Station**

The SAR limit of USA (FCC) is 1.6 W/kg averaged over one gram of tissue. Device has also been tested against this SAR limit.

End-users and installers must be provided with antenna installation instructions and transmitter operating conditions for satisfying RF exposure compliance.

### **RF Exposure Warning for H520E, H520E-RTK**

This equipment must be installed and operated in accordance with provided instructions and the antenna(s) used for this transmitter must be installed to provide a separation distance of at least 20 cm from all persons and must not be co-located or operating in conjunction with any other antenna or transmitter. End-users and installers must be provided with antenna installation instructions and transmitter operating conditions for satisfying RF exposure compliance.

### **IC Radiation Exposure Statement for Canada**

This device complies with Industry Canada license-exempt RSS standard (s). Operation is subject to the following two conditions: (1) this device may not cause interference, and (2) this device must accept any interference, including interference that may cause undesired operation of the device. Le présent appareil est conforme aux CNR d'Industrie Canada applicables aux appareils radio exempts de licence. L'exploitation est autorisée aux deux conditions suivantes : (1) l'appareil ne doit pas produire de brouillage, et (2) l'utilisateur de l'appareil doit accepter tout brouillage radioélectrique subi, même si le brouillage est susceptible d'en compromettre le fonctionnement.

This equipment complies with IC RSS-102 radiation exposure limit set forth for an uncontrolled environment. Cet équipement respecte les limites d'exposition aux rayonnements IC définies pour un environnement non contrôlé.

### **NCC Warning Statement**

本產品符合低功率電波輻射性電機管理辦法 第十二條~ 第十四條等條文規定：

\* 經型式認證合格之低功率射頻電機，非經許可，公司、商號或使用者均不得擅自變更頻率、加大功率或變更

原設計之特性及功能。

\* 低功率射頻電機之使用不得影響飛航安全及干擾合法通信；經發現有干擾現象時，應立即停用，並改善至無

干擾時方得繼續使用。

前項合法通信，指依電信法規定作業之無線電通信。低功率射頻電機須忍受合法通信或工業、科學及醫療用電

波輻射性電機設備之干擾。

### **EU COMPLIANCE STATEMENT**

Hereby, Yuneec International (China) Co., Ltd. declares that this device is in compliance with the essential requirements and other relevant provisions of the RED Directive 2014/53/EU.

The full text of the EU Declaration of Conformity is available at the following internet address:

<http://yuneec/de-downloads> please visits the address above and enters into corresponding product page.

**H520E/ H520E-RTK**



## **Yuneeec Support**

<https://yuneeec.kayako.com>

This content subject to change downloads the latest version from [www.yuneeec.com](http://www.yuneeec.com)

If you have any questions about this document, please contact us by Start a conversation on <https://yuneeec.kayako.com>