

# 20/08 MK58 USER MANUAL

## WARNING!

- Do not bend the antenna!
- Do not operate the MK58 in the rain!
- Do not fly in winds that exceed 17MPH (28KPH)!
- Do not expose the MK58 to fire sources!
- Do not expose the MK58 to excessive heat or sun light!

The text described in the User Manual takes TYPHOON Q500 series, GB203 and ST10+ from YUNEEC as example. You should read the User Manual completely before proceeding.

## USING YOUR MK58

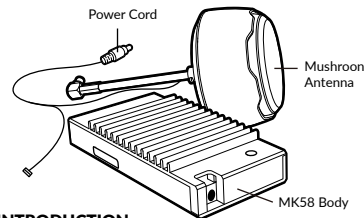

### 1. INTRODUCTION

The MK58 is a professional digital video downlink module, especially designed for GoPro Camera. Without any other extra module, real-time images can be directly transferred to the Ground Station/Controller with almost no delay. The MK58 is portable in size and allows for easy installation.

### 2. SPECIFICATIONS

Dimensions (without antenna): 2.48 X 1.19 X 0.45 in (63 X 30.2 X 11.5 mm)  
 Weight (With antenna, connector): 36 g (1.27 oz)  
 Compatible Camera : GoPro Hero 3, Hero 3+, Hero 4 Black Hero 4 Silver  
 Working Voltage: 5V (+/-0.5V)  
 Working Current: 1A  
 Video Transmission Range: 400m

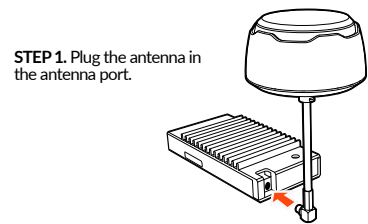

**STEP 1.** Plug the antenna in the antenna port.

**NOTICE:** When plugging the antenna in and out of the antenna port, it should be in vertical position (see illustration above).

**STEP 2.** Plug the power cord in the audio port.

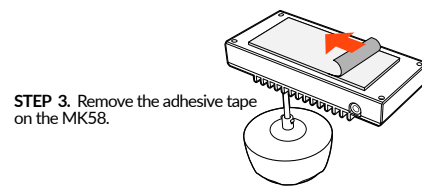
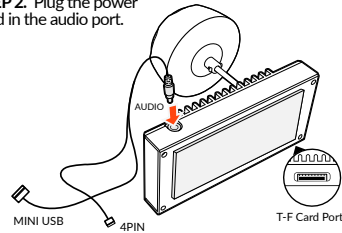

**STEP 3.** Remove the adhesive tape on the MK58.

**STEP 4.** Paste the MK58 within the red marked area.

**NOTICE:** The inappropriate pasting position may cause electronic interference or poor ventilation.

### 3. LED STATUS:

**Upon Powering On:** Blue LED solid.  
**After Powering On:** Red LED solid.  
**After binding to Personal Ground Station/ Remote Controller:** Red LED blinking.

## 4. POWERING ON

**Step 1)** Plug the audio connector into audio port of the MK58; then plug the 4PIN power connector into power output port of GB203.

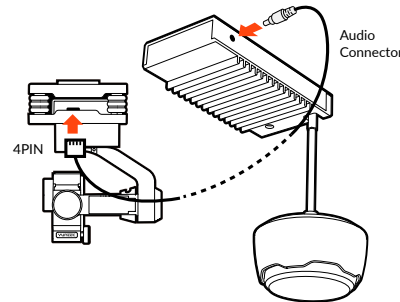

**IMPORTANT NOTE:** In this User Manual, the TYPHOON is taken as an example. If you have any other compatible power supply equipment or wearable equipment, you can plug the 4PIN power connector of the MK58 into power output port of other equipment as well.

**Step 2)** Switch on the aircraft and the MK58 will be supplied with power. Then the blue LED of the MK58 is on.

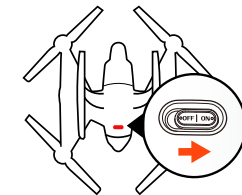

**NOTICE:** After about 30 seconds, the red LED of the MK58 is on, which indicates the MK58 is ready to work.

## 5. POWERING OFF

Switch off the aircraft and the MK58 powers off. The blue and red LED of the MK58 will be off.

**YUNEEC**  
ELECTRIC AVIATION

## 6. CONTROLLING THE MK58

Controlling the MK58 by Personal Ground Station/Remote Controller

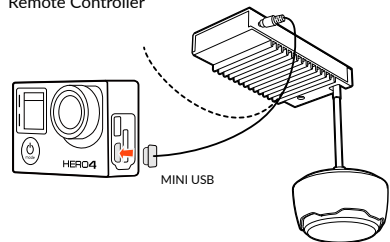

**STEP 1.** Plug the MINI USB connector into USB interface of GoPro Camera

**STEP 2.** Switch on the GoPro Camera. Power on the MK58.

**IMPORTANT NOTE:** In this User Manual, the TYPHOON is taken as an example. If you have any other compatible power supply equipment or wearable equipment, you can plug the 4PIN power connector of the MK58 into power output port of other equipment as well.

**STEP 3.** Bind the MK58 to the Personal Ground Station/Remote Controller. Switch on the Personal

Ground Station/Remote Controller and tap "Flight Setting".



**STEP 4.** Select "Camera Select".



**STEP 5.** Select "GoPro", tap "Select" and then tap "OK". Then the Camera Mode is chosen.

**STEP 6.** Back to the previous interface and tap "Bind".

**STEP 7.** Select the MK58 in "Camera" interface.

**STEP 8.** Input password "12345678" and then tap "OK". The binding succeeds.

**STEP 9.** After the Ground Station/ Controller and the MK58 are bound, the red LED of the MK58 will blink. Press to return to the main interface of the Ground Station/Controller. The real-time images can be shown on the interface of the Ground Station/ Controller.

Any information above might be changed due to the software update. For the latest documents, please check the official website.

## NOTICES AND WARNINGS

**IMPORTANT NOTE:** All safety precautions and warnings, instructions, warranties and other collateral information is subject to change at the sole discretion of Yuneec. For the most up-to-date information please visit the corresponding product page at [www.Yuneec.com](http://www.Yuneec.com) or contact the nearest Yuneec office or authorized distributor.

The following special language terms are used throughout the product literature to indicate various levels of potential harm when operating this product:

**NOTICE:** Procedures, which if not properly followed, create a possibility of property damage and/or little to no possibility of injury.

**CAUTION:** Procedures, which if not properly followed, create the probability of property damage and/or a possibility of serious injury.

**WARNING:** Procedures, which if not properly followed, create the probability of property damage, collateral damage and/or serious injury or create a high probability of superficial injury.

**WARNING:** Read the ENTIRE instruction manual to become familiar with the features of the product before operating. Failure to operate the product correctly can result in damage to the product, property and/or cause serious injury.

**WARNING:** This is a sophisticated consumer product. It must be operated with caution and common sense, and requires some basic mechanical ability. Failure to operate this product in a safe and responsible manner could result in damage to the product, property and/or cause serious injury. This product is not intended for use by children without direct adult supervision. Do not use with incompatible components or alter this product in any way outside of the instructions provided by Yuneec. The instruction manual contain instructions for safety, operation and maintenance.

It is essential to read and follow all the instructions and warnings prior to assembly, setup and/or use in order to operate the product correctly and avoid damage or serious injury.  
 Age recommendation: not for children under 14 years. This is not a toy.

### GENERAL SAFETY PRECAUTIONS AND WARNINGS

**WARNING:** Failure to use this product in the intended manner as described in instruction manual can result in damage to the product, property and/or cause serious injury. This product is not a toy! If misused it can cause serious bodily harm and damage to property.

**WARNING:** As the user of this product you are solely and wholly responsible for operating it in a manner that does not endanger yourself and others or result in damage to the product or the property of others. Do not attempt to operate your equipment in areas with potential magnetic and/or radio interference including areas nearby broadcast towers, power transmission stations, high voltage power lines, etc.

### FCC STATEMENT:

This equipment has been tested and found to comply with the limits for Part 15 of the FCC rules. These limits are designed to provide reasonable protection against harmful interference in a residential installation. This equipment generates, uses and can radiate radio frequency energy and, if not installed and used in accordance with the instructions, may cause harmful interference to radio communications. However, there is no guarantee that interference will not occur in a particular installation. If this equipment does cause harmful interference to radio or television reception, which can be determined by turning the equipment off and on, the user is encouraged to try to correct the interference by one or more of the following measures:

Reorient or relocate the receiving antenna.  
 Increase the separation between the equipment and receiver.  
 Connect the equipment to an outlet on a circuit different from that to which the receiver is connected.

This device complies with part 15 of the FCC rules. Operation is subject to the following two conditions:  
 (1) This device may not cause harmful interference, and (2) this device must accept any interference received, including interference that may cause undesired operation.

**NOTE:** This equipment has been tested and found to comply with the limits for a Class B digital device, pursuant to part 15 of the FCC Rules. These limits are designed to provide reasonable protection against harmful interference in a residential installation. This equipment generates, uses and can radiate radio frequency energy and, if not installed and used in accordance with the instructions, may cause harmful interference to radio communications. However, there is no guarantee that interference will not occur in a particular installation. If this equipment does cause harmful interference to radio or television reception, which can be determined by turning the equipment off and on, the user is encouraged to try to correct the interference by one or more of the following measures:

- Reorient or relocate the receiving antenna.
- Increase the separation between the equipment and receiver.
- Connect the equipment into an outlet on a circuit different from that to which the receiver is connected.
- Consult the dealer or an experienced radio/TV technician for help.

### RF EXPOSURE WARNING

This equipment must be installed and operated in accordance with provided instructions and the antenna(s) used for this transmitter must be installed to provide a separation distance of at least 20 cm from all persons and must not be co-located or operating in conjunction with any other antenna or transmitter. End-users and installers must be provide with antenna installation instructions

and transmitter operating conditions for satisfying RF exposure compliance.

### IC RADIATION EXPOSURE STATEMENT FOR CANADA

This device complies with Industry Canada licence-exempt RSS standard(s).  
 Operation is subject to the following two conditions: (1) this device may not cause interference, and (2) this device must accept any interference, including interference that may cause undesired operation of the device.

Le présent appareil est conforme aux CNR d'Industrie Canada applicables aux appareils radio exempts de licence. L'exploitation est autorisée aux deux conditions suivantes : (1) l'appareil ne doit pas produire de brouillage, et (2) l'utilisateur de l'appareil doit accepter tout brouillage radioélectrique subi, même si le brouillage est susceptible d'en compromettre le fonctionnement. Cet équipement respecte les limites d'exposition aux rayonnements IC définies pour un environnement non contrôlé.

This radio transmitter (11554B-MK58) has been approved by Industry Canada to operate with the antenna types listed below with the maximum permissible gain indicated. Antenna types not included in this list, having a gain greater than the maximum gain indicated for that type, are strictly prohibited for use with this device.

Le présent émetteur radio (11554B-MK58) a été approuvé par Industrie Canada pour fonctionner avec les types d'antenne énumérés ci-dessous et ayant un gain admissible maximal. Les types d'antenne non inclus dans cette liste, et dont le gain est supérieur au gain maximal indiqué, sont strictement interdits pour l'exploitation de l'émetteur.

**MK58**  
DIGITAL VIDEO DOWNLINK MODULE

USER MANUAL

