

# FCC Test Report

Product Name	FLIC HUB
Model No.	FLIC HUB
FCC ID.	2ACR9-FLHB

Applicant	Shortcut Labs AB
Address	Drottning Kristinas Vag 41, 11428, Stockholm, Sweden

Date of Receipt	Jan. 15, 2018
Issued Date	Feb. 02, 2018
Report No.	1810194R-RFUSP04V00
Report Version	V1.0



The test results relate only to the samples tested.

The test results shown in the test report are traceable to the national/international standard through the calibration report of the equipment and evaluated measurement uncertainty herein.

This report must not be used to claim product endorsement by TAF or any agency of the government.

The test report shall not be reproduced without the written approval of DEKRA Testing and Certification Co., Ltd.

# Test Report


Issued Date: Feb. 02, 2018

Report No.: 1810194R-RFUSP04V00



Product Name	FLIC HUB
Applicant	Shortcut Labs AB
Address	Drottning Kristinas Vag 41, 11428, Stockholm, Sweden
Manufacturer	DEXATEK TECHNOLOGY
Model No.	FLIC HUB
FCC ID.	2ACR9-FLHB
EUT Rated Voltage	DC 5V
EUT Test Voltage	AC 120V/60Hz
Trade Name	FLIC HUB
Applicable Standard	FCC CFR Title 47 Part 15 Subpart C: 2016 ANSI C63.4: 2014, ANSI C63.10: 2013
Test Result	Complied

Documented By :



( Senior Adm. Specialist / Rita Huang )

Tested By :



( Engineer / Tom Chiu )

Approved By :



( Director / Vincent Lin )

## TABLE OF CONTENTS

Description	Page
<b>1. GENERAL INFORMATION .....</b>	<b>5</b>
1.1. EUT Description.....	5
1.2. Operational Description.....	7
1.3. Tested System Details.....	8
1.4. Configuration of Tested System .....	8
1.5. EUT Exercise Software .....	8
1.6. Test Facility .....	9
1.7. List of Test Equipment.....	10
<b>2. CONDUCTED EMISSION .....</b>	<b>11</b>
2.1. Test Setup .....	11
2.2. Limits.....	12
2.3. Test Procedure .....	12
2.4. Uncertainty .....	12
2.5. Test Result of Conducted Emission.....	13
<b>3. PEAK POWER OUTPUT .....</b>	<b>15</b>
3.1. Test Setup .....	15
3.2. Limit .....	15
3.3. Test Procedure .....	15
3.4. Uncertainty .....	15
3.5. Test Result of Peak Power Output.....	16
<b>4. RADIATED EMISSION .....</b>	<b>18</b>
4.1. Test Setup .....	18
4.2. Limits.....	19
4.3. Test Procedure .....	20
4.4. Uncertainty .....	20
4.5. Test Result of Radiated Emission.....	21
<b>5. RF ANTENNA CONDUCTED TEST.....</b>	<b>29</b>
5.1. Test Setup .....	29
5.2. Limits.....	29
5.3. Test Procedure .....	29
5.4. Uncertainty .....	29
5.5. Test Result of RF Antenna Conducted Test.....	30
<b>6. BAND EDGE .....</b>	<b>32</b>
6.1. Test Setup .....	32
6.2. Limit .....	32
6.3. Test Procedure .....	33
6.4. Uncertainty .....	33
6.5. Test Result of Band Edge .....	34
<b>7. CHANNEL NUMBER.....</b>	<b>46</b>
7.1. Test Setup .....	46
7.2. Limit .....	46

---

7.3.	Test Procedure .....	46
7.4.	Uncertainty .....	46
7.5.	Test Result of Channel Number.....	47
<b>8.</b>	<b>CHANNEL SEPARATION.....</b>	<b>49</b>
8.1.	Test Setup .....	49
8.2.	Limit .....	49
8.3.	Test Procedure .....	49
8.4.	Uncertainty .....	49
8.5.	Test Result of Channel Separation.....	50
<b>9.</b>	<b>DWELL TIME.....</b>	<b>54</b>
9.1.	Test Setup .....	54
9.2.	Limit .....	54
9.3.	Test Procedure .....	54
9.4.	Uncertainty .....	54
9.5.	Test Result of Dwell Time .....	55
<b>10.</b>	<b>OCCUPIED BANDWIDTH .....</b>	<b>59</b>
10.1.	Test Setup .....	59
10.2.	Limits.....	59
10.3.	Test Procedure .....	59
10.4.	Uncertainty .....	59
10.5.	Test Result of Occupied Bandwidth .....	60
<b>11.</b>	<b>EMI REDUCTION METHOD DURING COMPLIANCE TESTING .....</b>	<b>64</b>

Attachment 1: EUT Test Photographs  
Attachment 2: EUT Detailed Photographs

## 1. GENERAL INFORMATION

### 1.1. EUT Description

Product Name	FLIC HUB
Trade Name	FLIC HUB
Model No.	FLIC HUB
FCC ID.	2ACR9-FLHB
Frequency Range	2402-2480MHz
Channel Number	79
Type of Modulation	FHSS: GFSK(1Mbps) / $\pi$ /4DQPSK(2Mbps) / 8DPSK(3Mbps)
Antenna Type	Chip Antenna
Channel Control	Auto
Antenna Gain	Refer to the table "Antenna List"
Contain Module	Realtek / RTL8723DS-CG

#### Antenna List

No.	Manufacturer	Part No.	Antenna Type	Peak Gain
1	ACX	AT3216-T2R4PAA	Chip Antenna	1.8 dBi for 2.4 GHz

Note:

1. The antenna of EUT conforms to FCC 15.203.

Center Frequency of Each Channel:

Channel	Frequency	Channel	Frequency	Channel	Frequency	Channel	Frequency
Channel 00:	2402 MHz	Channel 20:	2422 MHz	Channel 40:	2442 MHz	Channel 60:	2462 MHz
Channel 01:	2403 MHz	Channel 21:	2423 MHz	Channel 41:	2443 MHz	Channel 61:	2463 MHz
Channel 02:	2404 MHz	Channel 22:	2424 MHz	Channel 42:	2444 MHz	Channel 62:	2464 MHz
Channel 03:	2405 MHz	Channel 23:	2425 MHz	Channel 43:	2445 MHz	Channel 63:	2465 MHz
Channel 04:	2406 MHz	Channel 24:	2426 MHz	Channel 44:	2446 MHz	Channel 64:	2466 MHz
Channel 05:	2407 MHz	Channel 25:	2427 MHz	Channel 45:	2447 MHz	Channel 65:	2467 MHz
Channel 06:	2408 MHz	Channel 26:	2428 MHz	Channel 46:	2448 MHz	Channel 66:	2468 MHz
Channel 07:	2409 MHz	Channel 27:	2429 MHz	Channel 47:	2449 MHz	Channel 67:	2469 MHz
Channel 08:	2410 MHz	Channel 28:	2430 MHz	Channel 48:	2450 MHz	Channel 68:	2470 MHz
Channel 09:	2411 MHz	Channel 29:	2431 MHz	Channel 49:	2451 MHz	Channel 69:	2471 MHz
Channel 10:	2412 MHz	Channel 30:	2432 MHz	Channel 50:	2452 MHz	Channel 70:	2472 MHz
Channel 11:	2413 MHz	Channel 31:	2433 MHz	Channel 51:	2453 MHz	Channel 71:	2473 MHz
Channel 12:	2414 MHz	Channel 32:	2434 MHz	Channel 52:	2454 MHz	Channel 72:	2474 MHz
Channel 13:	2415 MHz	Channel 33:	2435 MHz	Channel 53:	2455 MHz	Channel 73:	2475 MHz
Channel 14:	2416 MHz	Channel 34:	2436 MHz	Channel 54:	2456 MHz	Channel 74:	2476 MHz
Channel 15:	2417 MHz	Channel 35:	2437 MHz	Channel 55:	2457 MHz	Channel 75:	2477 MHz
Channel 16:	2418 MHz	Channel 36:	2438 MHz	Channel 56:	2458 MHz	Channel 76:	2478 MHz
Channel 17:	2419 MHz	Channel 37:	2439 MHz	Channel 57:	2459 MHz	Channel 77:	2479 MHz
Channel 18:	2420 MHz	Channel 38:	2440 MHz	Channel 58:	2460 MHz	Channel 78:	2480 MHz
Channel 19:	2421 MHz	Channel 39:	2441 MHz	Channel 59:	2461 MHz		

Note:

1. The EUT is a FLIC HUB with a built-in WLAN 、Bluetooth V2.1+EDR transceiver, this report for Bluetooth V2.1+EDR.
2. These tests were conducted on a sample for the purpose of demonstrating compliance of Bluetooth transmitter with Part 15 Subpart C Paragraph 15.247 for spread spectrum devices.
3. Regarding to the operation frequency, the lowest, middle and highest frequency are selected to perform the test
4. Bluetooth operation was evaluated at both 1Mb/s and 3Mb/s data rates. 2Mb/s data rate was found, through pre-testing, to produce emissions similar to those for 3Mb/s.

Test Mode	Mode 1: Transmit - 1Mbps (GFSK) Mode 2: Transmit - 3Mbps (8DPSK)
-----------	---------------------------------------------------------------------

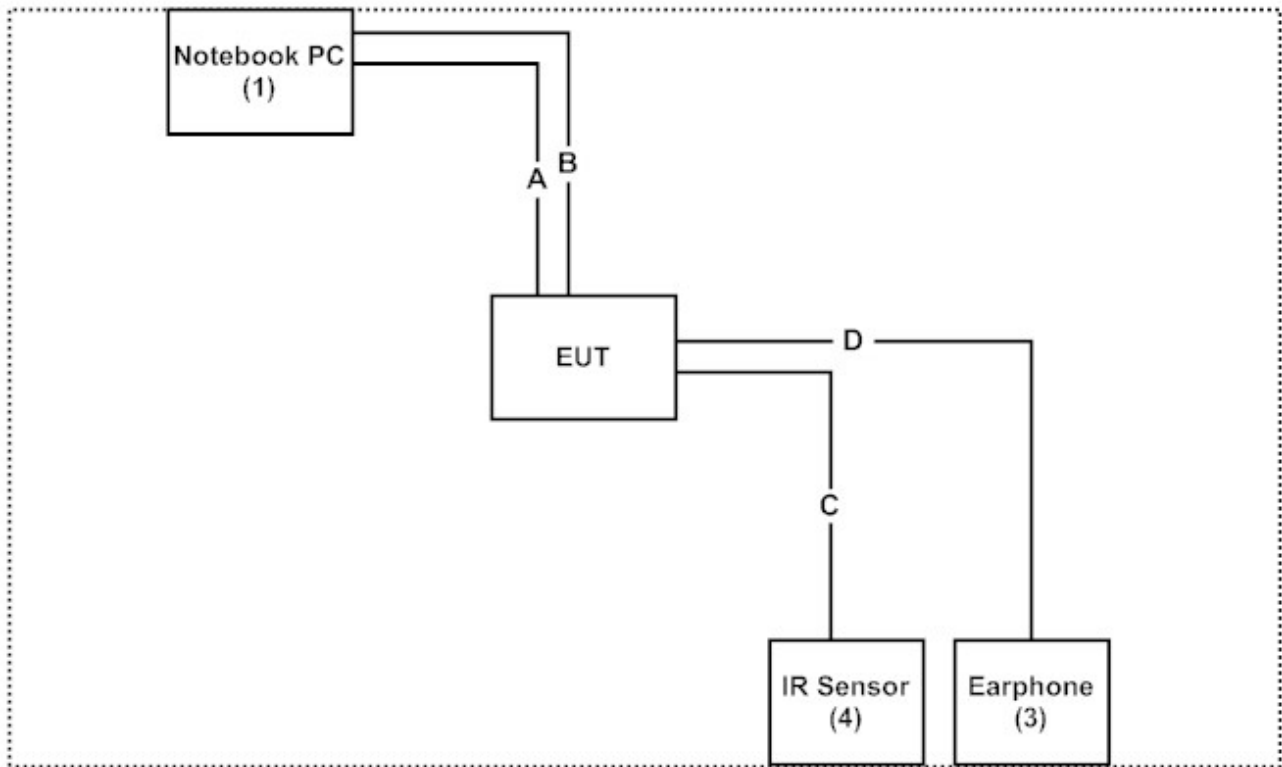
### 1.3. Tested System Details

The types for all equipment, plus descriptions of all cables used in the tested system (including inserted cards) are:

Product	Manufacturer	Model No.	Serial No.	Power Cord	
1	Notebook PC	DELL	Latitude E5440	74BTK32	Non-Shielded, 0.8m
2	Earphone	AIWA	N/A	N/A	N/A
3	IR Sensor	N/A	N/A	N/A	N/A

Signal Cable Type	Signal cable Description
A	USB Cable Non-Shielded, 0.5m
B	LAN Cable Non-Shielded, 1.0m
C	Single Cable Non-Shielded, 1.0m
D	Audio Cable Non-Shielded, 1.7m

### 1.4. Configuration of Tested System



### 1.5. EUT Exercise Software

1. Setup the EUT as shown in Section 1.4.
2. Execute software "Putty V0.63" on the Notebook PC.
3. Configure the test mode, the test channel, and the data rate.
4. Press "OK" to start the continuous Transmit.
5. Verify that the EUT works properly.

## 1.6. Test Facility

Ambient conditions in the laboratory:

Items	Required (IEC 68-1)	Actual
Temperature (°C)	15-35	20-35
Humidity (%RH)	25-75	30-65
Barometric pressure (mbar)	860-1060	950-1000

The related certificate for our laboratories about the test site and management system can be downloaded from DEKRA Testing and Certification Co., Ltd. Web Site:

<http://www.dekra.com.tw/english/about/certificates.aspx?bval=5>

The address and introduction of DEKRA Testing and Certification Co., Ltd. laboratories can be founded in our Web site: [http://www.dekra.com.tw/index\\_en.aspx](http://www.dekra.com.tw/index_en.aspx)

Site Description: Accredited by TAF  
Accredited Number: 3023

Site Name: DEKRA Testing and Certification Co., Ltd  
Site Address: No.5-22, Ruishukeng, Linkou Dist., New Taipei City 24451,  
Taiwan, R.O.C.  
TEL : 886-2-8601-3788 / FAX : 886-2-8601-3789  
E-Mail : [info.tw@dekra.com](mailto:info.tw@dekra.com)

FCC Accreditation Number: TW3023



## 1.7. List of Test Equipment

### For Conducted measurements /CB3/SR8

	Equipment	Manufacturer	Model No.	Serial No.	Cali. Date	Due. Date
	Temperature Chamber	WIT GROUP	TH-1S-B	EQ-201-00146	2017/11/28	2018/11/27
X	Spectrum Analyzer	Agilent	N9010A	MY48030495	2017/7/22	2018/7/21
X	Power Meter	Anritsu	ML2495A	6K00003357	2017/6/23	2018/6/22
X	Pulse power sensor	Anritsu	MA2411B	0846193	2017/6/23	2018/6/22
X	EMI Test Receiver	R&S	ESCS 30	100369	2017/10/13	2018/10/12
X	LISN	R&S	ESH3-Z5	836679/017	2018/1/18	2019/1/17
X	LISN	R&S	ENV216	100097	2018/1/18	2019/1/17
X	Coaxial Cable	QTK(Armist)	RG 400	LC018-RG	2017/6/25	2018/6/24

Note:

1. All equipments are calibrated every one year.
2. The test instruments marked with "X" are used to measure the final test results.
3. Test Software version : QuieTek Conduction Test System V8.0.113.

### For Radiated measurements /Site3/CB8

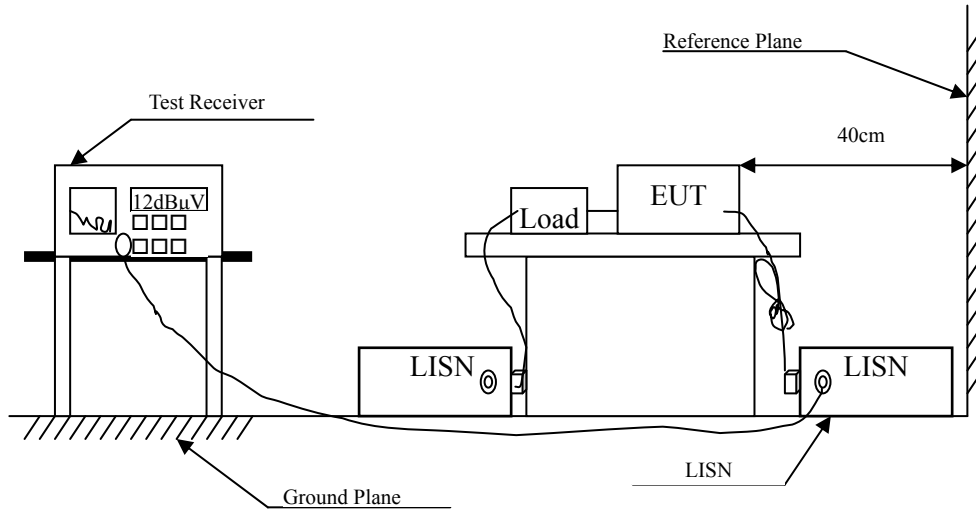
	Equipment	Manufacturer	Model No.	Serial No.	Cali. Date	Due. Date
X	Spectrum Analyzer	R&S	FSP40	100170	2018/1/18	2019/1/17
X	Loop Antenna	Teseq	HLA6121	37133	2017/3/18	2018/3/17
X	Bi-Log Antenna	Schaffner Chase	CBL6112B	2707	2017/6/11	2018/6/10
X	Horn Antenna	ETS-Lindgren	3117	00135205	2017/4/6	2018/4/5
X	Horn Antenna	Schwarzbeck	BBHA9170	9170430	2017/4/14	2018/4/13
X	Pre-Amplifier	QTK	AP/0100A	CHM/0901069	2017/6/23	2018/6/22
X	Pre-Amplifier	EMCI	EMC012630SE	980210	2018/1/26	2018/1/24
X	Pre-Amplifier	NARDA WE	DBL-1840N506	013	2017/9/30	2018/9/29
X	Filter	MicroTRON	BRM50701	019	2017/11/2	2018/11/1
X	Filter	Microwave Circuits	N0257881	36681	2018/1/3	2019/1/2
X	EMI Test Receiver	R&S	ESR26	101385	2017/9/29	2018/9/28
X	Coaxial Cable	QTK(Armist)	SUCOFLEX 106	L1606-015C	2017/6/23	2018/6/22
X	EMI Test Receiver	R&S	ESCS 30	838251/001	2017/7/21	2018/7/20
X	Coaxial Cable	QTK(Armist)	RG 214	LC003-RG	2017/6/16	2018/6/15
X	Coaxial signal switch	Anritsu	MP59B	6201415889	2017/6/16	2018/6/15

Note:

1. All equipments are calibrated every one year.
2. The test instruments marked with "X" are used to measure the final test results.
3. Test Software version : QuieTek EMI 2.0 V2.1.113.

## 2. Conducted Emission

### 2.1. Test Setup



## 2.2. Limits

<b>FCC Part 15 Subpart C Paragraph 15.207 (dB<math>\mu</math>V) Limit</b>		
Frequency MHz	Limits	
	QP	AV
0.15 - 0.50	66-56	56-46
0.50-5.0	56	46
5.0 - 30	60	50

Remarks: In the above table, the tighter limit applies at the band edges.

## 2.3. Test Procedure

The EUT and Peripherals are connected to the main power through a line impedance stabilization network (L.I.S.N.). This provides a 50 ohm /50uH coupling impedance for the measuring equipment. The peripheral devices are also connected to the main power through a LISN that provides a 50ohm /50uH coupling impedance with 50ohm termination. (Please refer to the block diagram of the test setup and photographs.)

Both sides of A.C. line are checked for maximum conducted interference. In order to find the maximum emission, the relative positions of equipment and all the interface cables must be changed according to ANSI C63.4: 2014 on conducted measurement.

Conducted emissions were investigated over the frequency range from 0.15MHz to 30MHz using a receiver bandwidth of 9kHz.

The EUT was setup to ANSI C63.4, 2014; tested to FHSS test procedure of FCC Public Notice DA 00-705 for compliance to FCC 47CFR 15.247 requirements.

## 2.4. Uncertainty

$\pm 2.26$  dB

## 2.5. Test Result of Conducted Emission

Product : FLIC HUB  
 Test Item : Conducted Emission Test  
 Power Line : Line 1  
 Test date : 2018/01/17  
 Test Mode : Mode 2: Transmit - 3Mbps (8DPSK) (2441MHz)

Frequency MHz	Correct Factor dB	Reading Level dB $\mu$ V	Measurement Level dB $\mu$ V	Margin dB	Limit dB $\mu$ V
<b>LINE 1</b>					
<b>Quasi-Peak</b>					
0.201	9.772	33.140	42.912	-21.631	64.543
0.255	9.764	29.660	39.424	-23.576	63.000
0.533	9.743	21.460	31.203	-24.797	56.000
0.841	9.763	15.980	25.743	-30.257	56.000
6.998	9.944	14.140	24.084	-35.916	60.000
23.892	10.089	33.200	43.289	-16.711	60.000
<b>Average</b>					
0.201	9.772	26.490	36.262	-18.281	54.543
0.255	9.764	20.930	30.694	-22.306	53.000
0.533	9.743	13.530	23.273	-22.727	46.000
0.841	9.763	5.680	15.443	-30.557	46.000
6.998	9.944	8.760	18.704	-31.296	50.000
23.892	10.089	24.190	34.279	-15.721	50.000

### Note:

1. All Reading Levels are Quasi-Peak and average value.
2. "■" means the worst emission level.
3. Measurement Level = Reading Level + Correct Factor

Product : FLIC HUB  
 Test Item : Conducted Emission Test  
 Power Line : Line 2  
 Test date : 2018/01/17  
 Test Mode : Mode 2: Transmit - 3Mbps (8DPSK) (2441MHz)

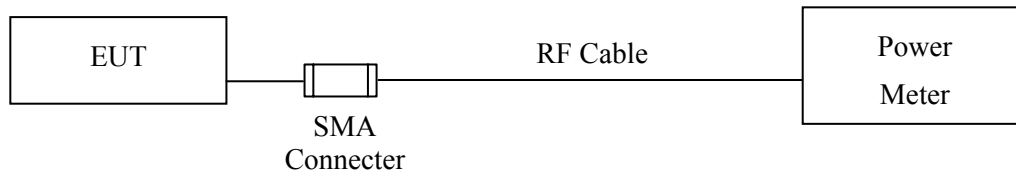
Frequency MHz	Correct Factor dB	Reading Level dB $\mu$ V	Measurement Level dB $\mu$ V	Margin dB	Limit dB $\mu$ V
<b>LINE 2</b>					
<b>Quasi-Peak</b>					
0.150	9.717	33.960	43.677	-22.323	66.000
0.248	9.755	29.900	39.655	-23.545	63.200
0.638	9.820	20.880	30.700	-25.300	56.000
1.068	9.887	16.480	26.367	-29.633	56.000
7.380	10.007	19.220	29.227	-30.773	60.000
24.021	10.259	21.660	31.919	-28.081	60.000
<b>Average</b>					
0.150	9.717	30.560	40.277	-15.723	56.000
0.248	9.755	20.610	30.365	-22.835	53.200
0.638	9.820	12.410	22.230	-23.770	46.000
1.068	9.887	7.280	17.167	-28.833	46.000
7.380	10.007	13.530	23.537	-26.463	50.000
24.021	10.259	15.530	25.789	-24.211	50.000

Note:

1. All Reading Levels are Quasi-Peak and average value.
2. "■" means the worst emission level.
3. Measurement Level = Reading Level + Correct Factor

### 3. Peak Power Output

#### 3.1. Test Setup



#### 3.2. Limit

The maximum peak power shall be less 1Watt.

#### 3.3. Test Procedure

The EUT was setup to ANSI C63.4, 2014; tested to FHSS test procedure of FCC Public Notice DA 00-705 for compliance to FCC 47CFR 15.247 requirements.

#### 3.4. Uncertainty

$\pm 1.19$  dB

### 3.5. Test Result of Peak Power Output

Product : FLIC HUB  
Test Item : Peak Power Output  
Test Site : No.3 OATS  
Test date : 2018/01/26  
Test Mode : Mode 1: Transmit - 1Mbps (GFSK)

Channel No.	Frequency (MHz)	Measurement (dBm)	Required Limit	Result
Channel 00	2402.00	7.19	1 Watt= 30 dBm	Pass
Channel 39	2441.00	7.01	1 Watt= 30 dBm	Pass
Channel 78	2480.00	6.96	1 Watt= 30 dBm	Pass

Product : FLIC HUB  
Test Item : Peak Power Output  
Test Site : No.3 OATS  
Test date : 2018/01/26  
Test Mode : Mode 2: Transmit - 3Mbps (8DPSK)

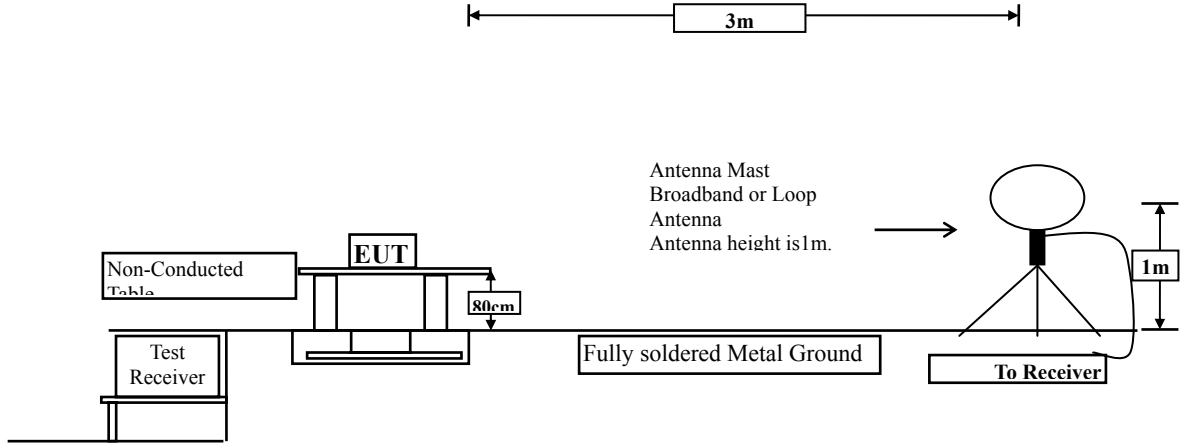
Channel No.	Frequency (MHz)	Measurement (dBm)	Required Limit	Result
Channel 00	2402.00	8.82	1 Watt= 30 dBm	Pass
Channel 39	2441.00	8.46	1 Watt= 30 dBm	Pass
Channel 78	2480.00	8.35	1 Watt= 30 dBm	Pass



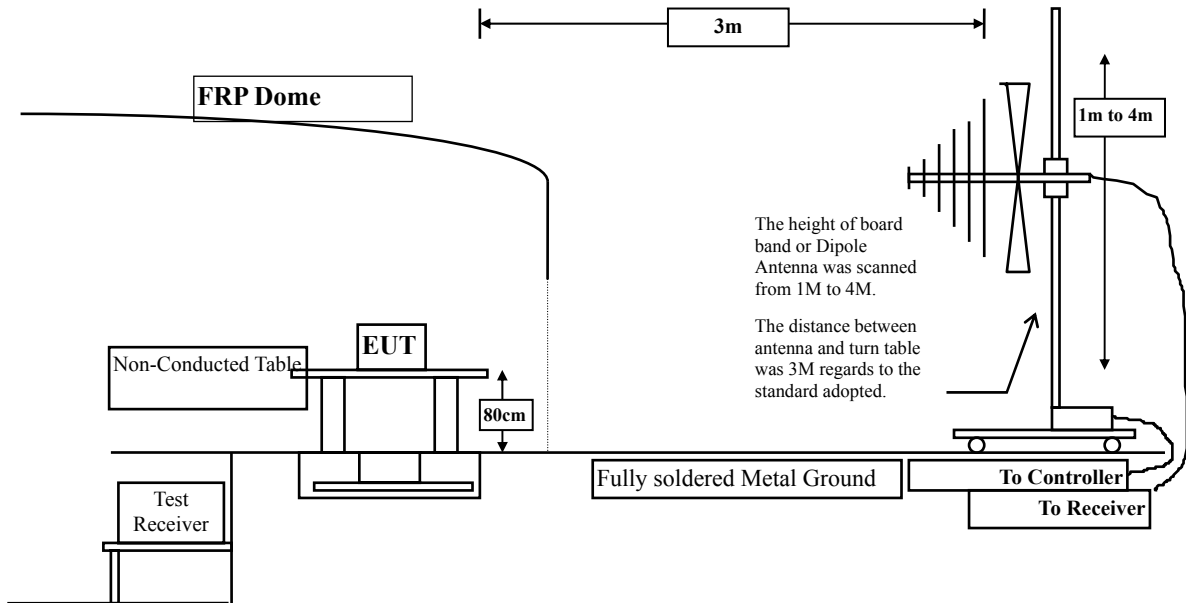
#### 4. Radiated Emission

##### 4.1. Test Setup

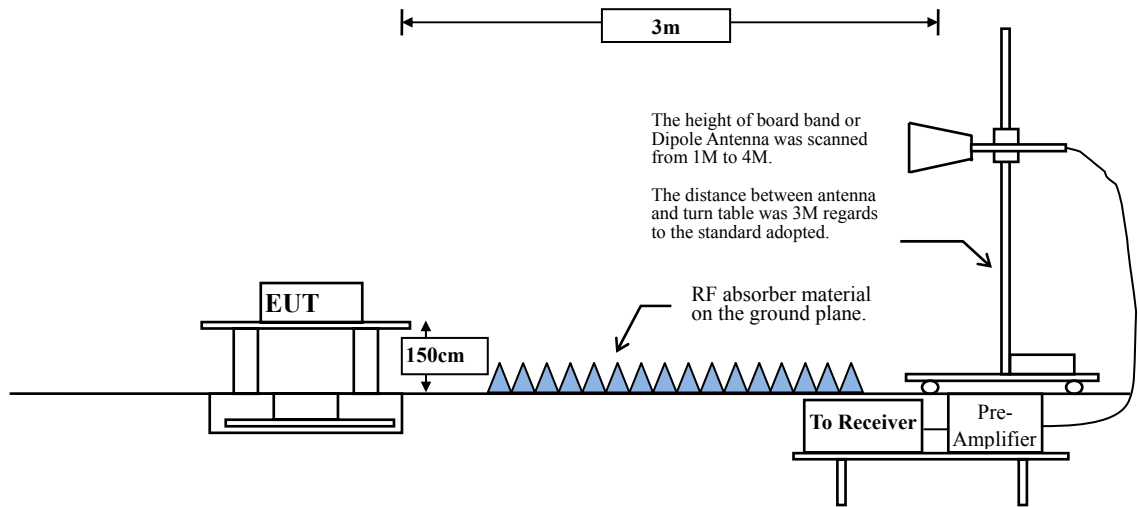
Under 30MHz



Below 1GHz



Above 1GHz



## 4.2. Limits

### ➤ General Radiated Emission Limits

Emissions radiated outside of the specified frequency bands, except for harmonics, shall be attenuated by at least 20dB below the level of the fundamental or to the general radiated emission limits in paragraph 15.209, whichever is the lesser attenuation.

FCC Part 15 Subpart C Paragraph 15.209 Limits		
Frequency MHz	Field strength (microvolts/meter)	Measurement distance (meter)
0.009-0.490	2400/F(kHz)	300
0.490-1.705	24000/F(kHz)	30
1.705-30	30	30
30-88	100	3
88-216	150	3
216-960	200	3
Above 960	500	3

- Remarks:
1. RF Voltage (dB $\mu$ V) = 20 log RF Voltage (uV)
  2. In the Above Table, the tighter limit applies at the band edges.
  3. Distance refers to the distance in meters between the measuring instrument antenna and the closed point of any part of the device or system.

### 4.3. Test Procedure

The EUT was setup according to ANSI C63.10, 2013 and tested compliance to FCC 47CFR 15.247 requirements.

Measuring the frequency range below 1GHz, the EUT is placed on a turn table which is 0.8 meter above ground, when measuring the frequency range above 1GHz, the EUT is placed on a turn table which is 1.5 meter above ground.

The turn table is rotated 360 degrees to determine the position of the maximum emission level.

The EUT was positioned such that the distance from antenna to the EUT was 3 meters.

The antenna is scanned between 1 meter and 4 meters to find out the maximum emission level. This is repeated for both horizontal and vertical polarization of the antenna. In order to find the maximum emission, all of the interface cables were manipulated according to ANSI C63.10: 2013 on radiated measurement.

The resolution bandwidth below 30MHz setting on the field strength meter is 9kHz and 30MHz~1GHz is 120kHz and above 1GHz is 1MHz.

Radiated emission measurements below 30MHz are made using Loop Antenna and 30MHz~1GHz are made using broadband Bilog antenna and above 1GHz are made using Horn Antennas.

The measurement is divided into the Preliminary Measurement and the Final Measurement.

The suspected frequencies are searched for in Preliminary Measurement with the measurement antenna kept pointed at the source of the emission both in azimuth and elevation, with the polarization of the antenna oriented for maximum response. The antenna is pointed at an angle towards the source of the emission, and the EUT is rotated in both height and polarization to maximize the measured emission. The emission is kept within the illumination area of the 3 dB bandwidth of the antenna.

The worst radiated emission is measured in the Open Area Test Site on the Final Measurement.

The measurement frequency range from 9kHz - 10th Harmonic of fundamental was investigated.

### 4.4. Uncertainty

± 4.08 dB above 1GHz

± 4.22 dB below 1GHz

#### 4.5. Test Result of Radiated Emission

Product : FLIC HUB  
 Test Item : Harmonic Radiated Emission  
 Test Site : No.3 OATS  
 Test date : 201/01/30  
 Test Mode : Mode 1: Transmit - 1Mbps (GFSK)(2402MHz)

Frequency MHz	Correct Factor dB	Reading Level dB $\mu$ V	Measurement Level dB $\mu$ V/m	Margin dB	Limit dB $\mu$ V/m
<b>Horizontal</b>					
<b>Peak Detector:</b>					
4804.000	2.511	40.240	42.750	-31.250	74.000
7206.000	9.511	37.577	47.088	-26.912	74.000
9608.000	10.394	36.810	47.204	-26.796	74.000
<b>Average Detector:</b>					
--					
<b>Vertical</b>					
<b>Peak Detector:</b>					
4804.000	2.923	40.970	43.892	-30.108	74.000
7206.000	9.988	37.766	47.755	-26.245	74.000
9608.000	10.847	36.827	47.674	-26.326	74.000
<b>Average Detector:</b>					
--					

Note:

1. All Readings below 1GHz are Quasi-Peak, above 1GHz are performed with peak and/or average measurements as necessary.
2. Peak measurements: RBW = 1MHz, VBW = 3 MHz, Sweep: Auto.
3. Average measurements: RBW = 1MHz, VBW = 10 Hz, Sweep: Auto.
4. Measurement Level = Reading Level + Correct Factor.
5. Correct Factor = Antenna factor + Cable loss – Amplifier gain.
6. The average measurement was not performed when the peak measured data under the limit of average detection.
7. The emission levels of other frequencies are very lower than the limit and not show in test report.

Product : FLIC HUB  
 Test Item : Harmonic Radiated Emission  
 Test Site : No.3 OATS  
 Test date : 201/01/30  
 Test Mode : Mode 1: Transmit - 1Mbps (GFSK)(2441MHz)

Frequency MHz	Correct Factor dB	Reading Level dB $\mu$ V	Measurement Level dB $\mu$ V/m	Margin dB	Limit dB $\mu$ V/m
<b>Horizontal</b>					
<b>Peak Detector:</b>					
4882.000	2.025	38.034	40.059	-33.941	74.000
7323.000	9.762	36.280	46.041	-27.959	74.000
9764.000	9.682	36.543	46.224	-27.776	74.000
<b>Average Detector:</b>					
--					
<b>Vertical</b>					
<b>Peak Detector:</b>					
4882.000	2.488	38.920	41.408	-32.592	74.000
7323.000	10.375	36.623	46.997	-27.003	74.000
9764.000	10.315	37.022	47.337	-26.663	74.000
<b>Average Detector:</b>					
--					

## Note:

- All Readings below 1GHz are Quasi-Peak, above 1GHz are performed with peak and/or average measurements as necessary.
- Peak measurements: RBW = 1MHz, VBW = 3 MHz, Sweep: Auto.
- Average measurements: RBW = 1MHz, VBW = 10 Hz, Sweep: Auto.
- Measurement Level = Reading Level + Correct Factor.
- Correct Factor = Antenna factor + Cable loss – Amplifier gain.
- The average measurement was not performed when the peak measured data under the limit of average detection.
- The emission levels of other frequencies are very lower than the limit and not show in test report.

Product : FLIC HUB  
 Test Item : Harmonic Radiated Emission  
 Test Site : No.3 OATS  
 Test date : 201/01/30  
 Test Mode : Mode 1: Transmit - 1Mbps (GFSK)(2480MHz)

Frequency MHz	Correct Factor dB	Reading Level dB $\mu$ V	Measurement Level dB $\mu$ V/m	Margin dB	Limit dB $\mu$ V/m
<b>Horizontal</b>					
<b>Peak Detector:</b>					
4960.000	2.582	39.240	41.822	-32.178	74.000
7440.000	10.555	35.297	45.852	-28.148	74.000
9920.000	10.206	37.377	47.583	-26.417	74.000
<b>Average Detector:</b>					
--					
<b>Vertical</b>					
<b>Peak Detector:</b>					
4960.000	3.398	39.224	42.623	-31.377	74.000
7440.000	11.214	35.723	46.937	-27.063	74.000
9920.000	11.245	37.083	48.328	-25.672	74.000
<b>Average Detector:</b>					
--					

## Note:

- All Readings below 1GHz are Quasi-Peak, above 1GHz are performed with peak and/or average measurements as necessary.
- Peak measurements: RBW = 1MHz, VBW = 3 MHz, Sweep: Auto.
- Average measurements: RBW = 1MHz, VBW = 10 Hz, Sweep: Auto.
- Measurement Level = Reading Level + Correct Factor.
- Correct Factor = Antenna factor + Cable loss – Amplifier gain.
- The average measurement was not performed when the peak measured data under the limit of average detection.
- The emission levels of other frequencies are very lower than the limit and not show in test report.

Product : FLIC HUB  
 Test Item : Harmonic Radiated Emission  
 Test Site : No.3 OATS  
 Test date : 201/01/30  
 Test Mode : Mode 2: Transmit - 3Mbps (8DPSK)(2402MHz)

Frequency MHz	Correct Factor dB	Reading Level dB $\mu$ V	Measurement Level dB $\mu$ V/m	Margin dB	Limit dB $\mu$ V/m
<b>Horizontal</b>					
<b>Peak Detector:</b>					
4804.000	2.511	40.543	43.053	-30.947	74.000
7206.000	9.511	37.149	46.660	-27.340	74.000
9608.000	10.394	36.070	46.464	-27.536	74.000
<b>Average Detector:</b>					
--					
<b>Vertical</b>					
<b>Peak Detector:</b>					
4804.000	2.923	39.715	42.637	-31.363	74.000
7206.000	9.988	37.260	47.249	-26.751	74.000
9608.000	10.847	36.260	47.107	-26.893	74.000
<b>Average Detector:</b>					
--					

## Note:

- All Readings below 1GHz are Quasi-Peak, above 1GHz are performed with peak and/or average measurements as necessary.
- Peak measurements: RBW = 1MHz, VBW = 3 MHz, Sweep: Auto.
- Average measurements: RBW = 1MHz, VBW = 10 Hz, Sweep: Auto.
- Measurement Level = Reading Level + Correct Factor.
- Correct Factor = Antenna factor + Cable loss – Amplifier gain.
- The average measurement was not performed when the peak measured data under the limit of average detection.
- The emission levels of other frequencies are very lower than the limit and not show in test report.

Product : FLIC HUB  
 Test Item : Harmonic Radiated Emission  
 Test Site : No.3 OATS  
 Test date : 201/01/30  
 Test Mode : Mode 2: Transmit - 3Mbps (8DPSK) (2441MHz)

Frequency MHz	Correct Factor dB	Reading Level dB $\mu$ V	Measurement Level dB $\mu$ V/m	Margin dB	Limit dB $\mu$ V/m
<b>Horizontal</b>					
<b>Peak Detector:</b>					
4882.000	2.025	38.999	41.024	-32.976	74.000
7323.000	9.762	36.259	46.020	-27.980	74.000
9764.000	9.682	36.860	46.541	-27.459	74.000
<b>Average Detector:</b>					
--					
<b>Vertical</b>					
<b>Peak Detector:</b>					
4882.000	2.488	38.754	41.242	-32.758	74.000
7323.000	10.375	36.618	46.992	-27.008	74.000
9764.000	10.315	36.914	47.229	-26.771	74.000
<b>Average Detector:</b>					
--					

## Note:

1. All Readings below 1GHz are Quasi-Peak, above 1GHz are performed with peak and/or average measurements as necessary.
2. Peak measurements: RBW = 1MHz, VBW = 3 MHz, Sweep: Auto.
3. Average measurements: RBW = 1MHz, VBW = 10 Hz, Sweep: Auto.
4. Measurement Level = Reading Level + Correct Factor.
5. Correct Factor = Antenna factor + Cable loss – Amplifier gain.
6. The average measurement was not performed when the peak measured data under the limit of average detection.
7. The emission levels of other frequencies are very lower than the limit and not show in test report.



Product : FLIC HUB  
 Test Item : Harmonic Radiated Emission  
 Test Site : No.3 OATS  
 Test date : 201/01/30  
 Test Mode : Mode 2: Transmit - 3Mbps (8DPSK) (2480MHz)

Frequency MHz	Correct Factor dB	Reading Level dB $\mu$ V	Measurement Level dB $\mu$ V/m	Margin dB	Limit dB $\mu$ V/m
<b>Horizontal</b>					
<b>Peak Detector:</b>					
4960.000	2.582	39.291	41.873	-32.127	74.000
7440.000	10.555	35.659	46.214	-27.786	74.000
9920.000	10.206	36.672	46.878	-27.122	74.000
<b>Average Detector:</b>					
--					
<b>Vertical</b>					
<b>Peak Detector:</b>					
4960.000	3.398	39.050	42.449	-31.551	74.000
7440.000	11.214	35.735	46.949	-27.051	74.000
9920.000	11.245	38.408	49.653	-24.347	74.000
<b>Average Detector:</b>					
--					

## Note:

- All Readings below 1GHz are Quasi-Peak, above 1GHz are performed with peak and/or average measurements as necessary.
- Peak measurements: RBW = 1MHz, VBW = 3 MHz, Sweep: Auto.
- Average measurements: RBW = 1MHz, VBW = 10 Hz, Sweep: Auto.
- Measurement Level = Reading Level + Correct Factor.
- Correct Factor = Antenna factor + Cable loss – Amplifier gain.
- The average measurement was not performed when the peak measured data under the limit of average detection.
- The emission levels of other frequencies are very lower than the limit and not show in test report.

Product : FLIC HUB  
 Test Item : General Radiated Emission  
 Test Site : No.3 OATS  
 Test date : 201/01/30  
 Test Mode : Mode 1: Transmit - 1Mbps (GFSK) (2441MHz)

Frequency MHz	Correct Factor dB	Reading Level dB $\mu$ V	Measurement Level dB $\mu$ V/m	Margin dB	Limit dB $\mu$ V/m
<b>Horizontal</b>					
103.720	-8.230	41.275	33.044	-10.456	43.500
301.600	-4.465	42.894	38.429	-7.571	46.000
400.540	0.942	37.854	38.796	-7.204	46.000
511.120	3.173	37.008	40.181	-5.819	46.000
649.830	1.857	35.844	37.701	-8.299	46.000
874.870	5.765	30.642	36.407	-9.593	46.000
<b>Vertical</b>					
181.320	-1.910	37.808	35.898	-7.602	43.500
343.310	-0.765	42.464	41.699	-4.301	46.000
510.150	0.919	37.189	38.108	-7.892	46.000
600.360	1.302	39.367	40.669	-5.331	46.000
749.740	2.023	36.723	38.746	-7.254	46.000
849.650	-0.249	34.307	34.058	-11.942	46.000

## Note:

1. All Readings below 1GHz are Quasi-Peak, above 1GHz are performed with peak and/or average measurements as necessary.
2. Peak measurements: RBW = 1MHz, VBW = 3 MHz, Sweep: Auto.
3. Average measurements: RBW = 1MHz, VBW = 10 Hz, Sweep: Auto.
4. Measurement Level = Reading Level + Correct Factor.
5. Correct Factor = Antenna factor + Cable loss – Amplifier gain.
6. The average measurement was not performed when the peak measured data under the limit of average detection.
7. The emission levels of other frequencies are very lower than the limit and not show in test report.

Product : FLIC HUB  
 Test Item : General Radiated Emission  
 Test Site : No.3 OATS  
 Test date : 201/01/30  
 Test Mode : Mode 2: Transmit - 3Mbps (8DPSK) (2441MHz)

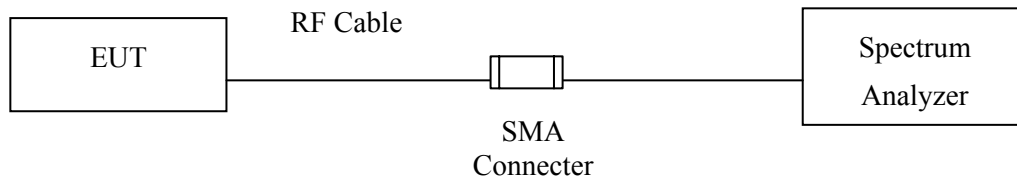
Frequency MHz	Correct Factor dB	Reading Level dB $\mu$ V	Measurement Level dB $\mu$ V/m	Margin dB	Limit dB $\mu$ V/m
<b>Horizontal</b>					
199.750	-9.827	49.233	39.406	-4.094	43.500
330.700	-4.284	42.398	38.115	-7.885	46.000
471.350	3.261	37.451	40.712	-5.288	46.000
600.360	3.472	39.009	42.481	-3.519	46.000
760.410	5.151	31.787	36.938	-9.062	46.000
930.160	7.530	31.499	39.029	-6.971	46.000
<b>Vertical</b>					
182.290	-2.827	38.777	35.950	-7.550	43.500
380.170	0.962	36.425	37.387	-8.613	46.000
500.450	-0.115	39.009	38.894	-7.106	46.000
549.920	-0.478	45.820	45.341	-0.659	46.000
749.740	2.023	35.414	37.437	-8.563	46.000
800.180	2.637	33.179	35.816	-10.184	46.000

## Note:

1. All Readings below 1GHz are Quasi-Peak, above 1GHz are performed with peak and/or average measurements as necessary.
2. Peak measurements: RBW = 1MHz, VBW = 3 MHz, Sweep: Auto.
3. Average measurements: RBW = 1MHz, VBW = 10 Hz, Sweep: Auto.
4. Measurement Level = Reading Level + Correct Factor.
5. Correct Factor = Antenna factor + Cable loss – Amplifier gain.
6. The average measurement was not performed when the peak measured data under the limit of average detection.
7. The emission levels of other frequencies are very lower than the limit and not show in test report.
8. No emission found between lowest internal used/generated frequency to 30MHz.

## 5. RF Antenna Conducted Test

### 5.1. Test Setup



### 5.2. Limits

According to FCC Section 15.247(d). In any 100 kHz bandwidth outside the frequency band in which the spread spectrum or digitally modulated intentional radiator is operating, the radio frequency power that is produced by the intentional radiator shall be at least 20 dB below that in the 100 kHz bandwidth within the band that contains the highest level of the desired power, based on either an RF conducted or measurement, provided the transmitter demonstrates compliance with the peak conducted power limits. If the transmitter complies with the conducted power limits based on the use of RMS averaging over a time interval, the attenuation required under this paragraph shall be 30 dB instead of 20 dB.

### 5.3. Test Procedure

The EUT was setup to ANSI C63.4, 2014; tested to FHSS test procedure of FCC Public Notice DA 00-705 for compliance to FCC 47CFR 15.247 requirements.

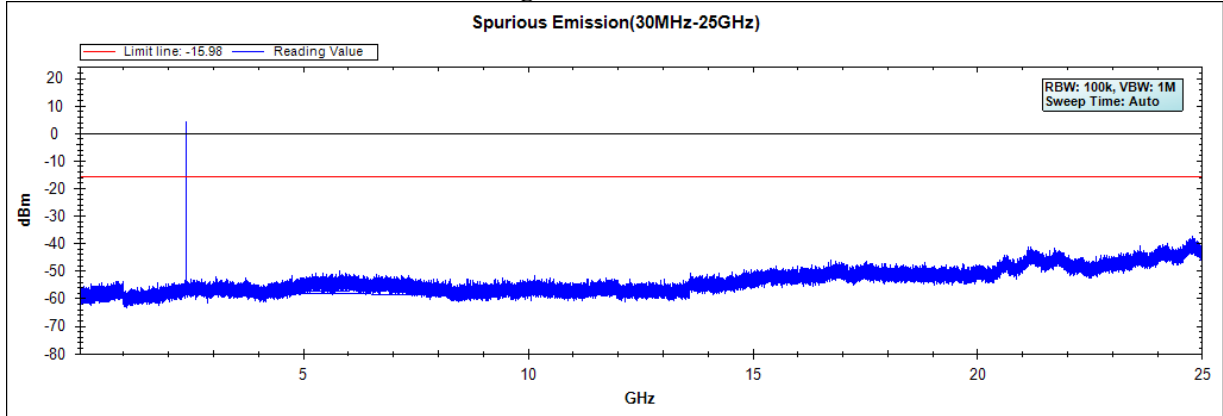
### 5.4. Uncertainty

$\pm 1.20\text{dB}$

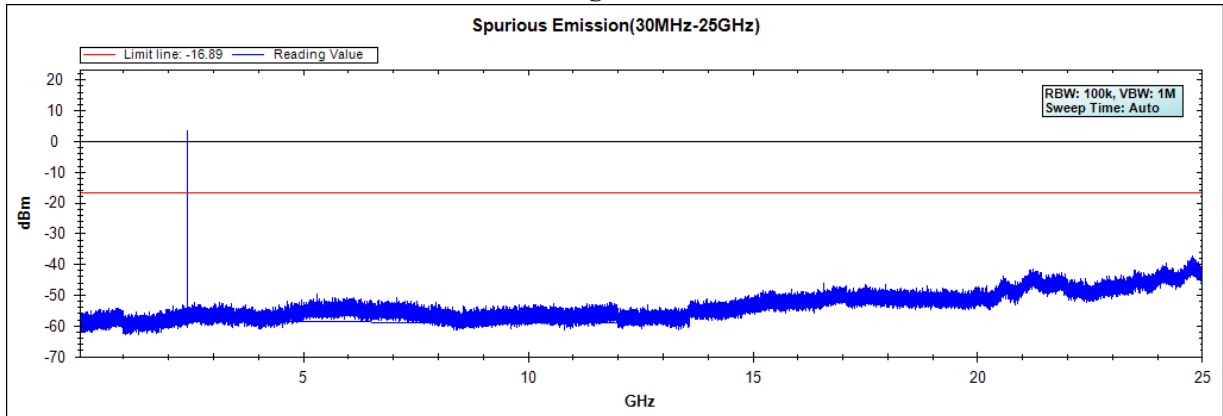
### 5.5. Test Result of RF Antenna Conducted Test

Product : FLIC HUB  
 Test Item : RF Antenna Conducted Test  
 Test Site : No.3 OATS  
 Test date : 2018/01/30  
 Test Mode : Mode 1: Transmit - 1Mbps (GFSK)

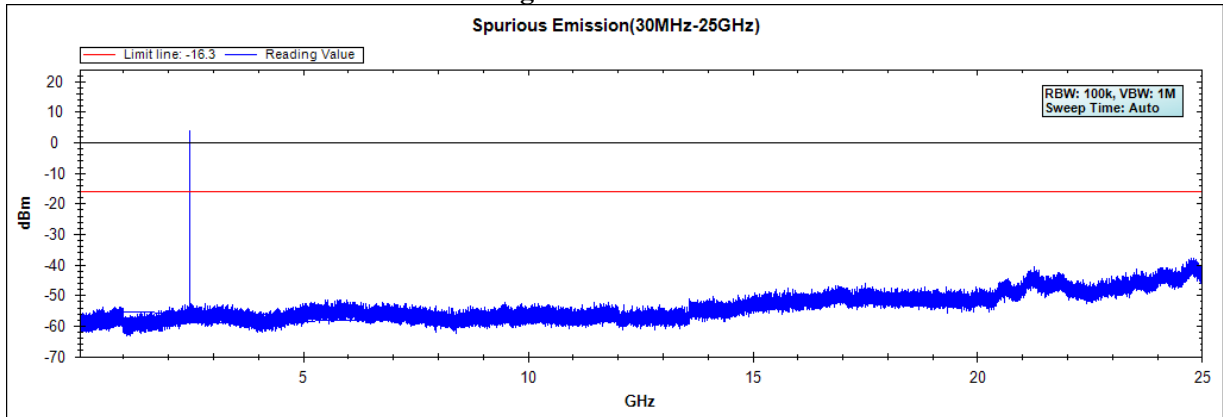
**Figure Channel 00:**



**Figure Channel 39:**



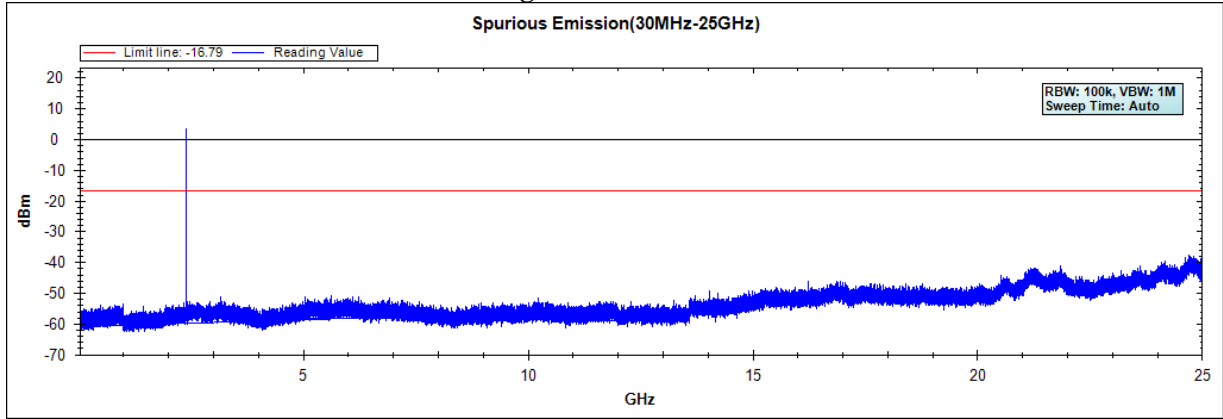
**Figure Channel 78:**



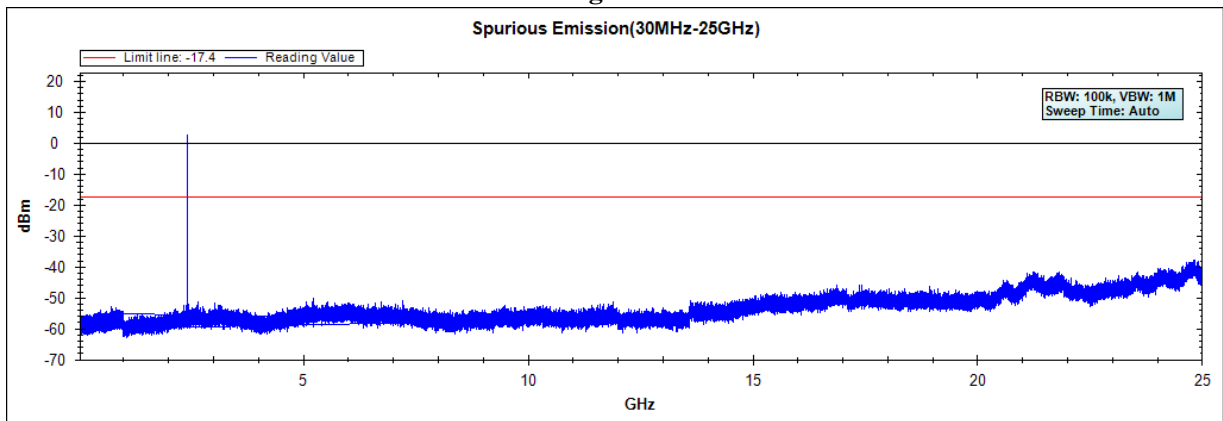
Note: The above test pattern is synthesized by multiple of the frequency range.

Product : FLIC HUB  
Test Item : RF Antenna Conducted Test  
Test Site : No.3 OATS  
Test date : 2018/01/30  
Test Mode : Mode 2: Transmit - 3Mbps (8DPSK)

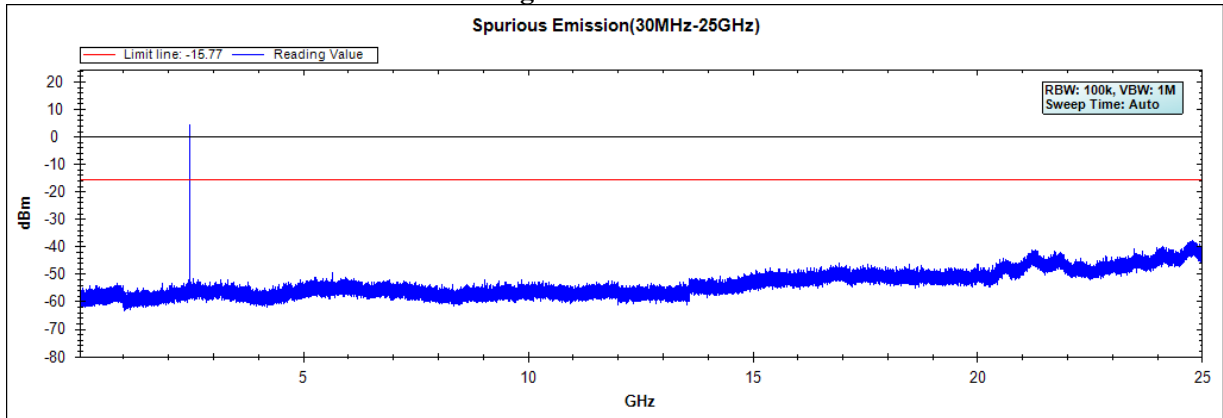
**Figure Channel 00:**



**Figure Channel 39:**



**Figure Channel 78:**



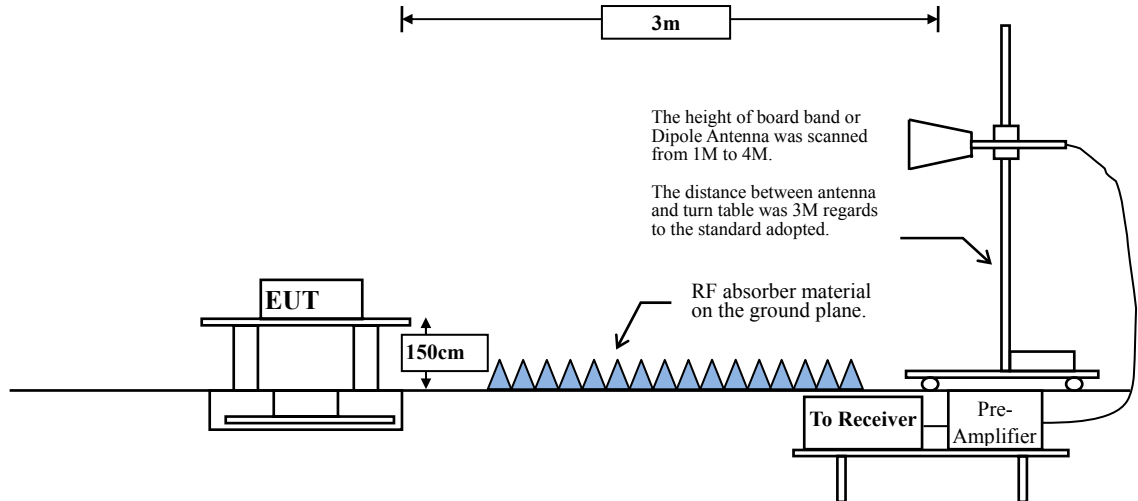
Note: The above test pattern is synthesized by multiple of the frequency range.

## 6. Band Edge

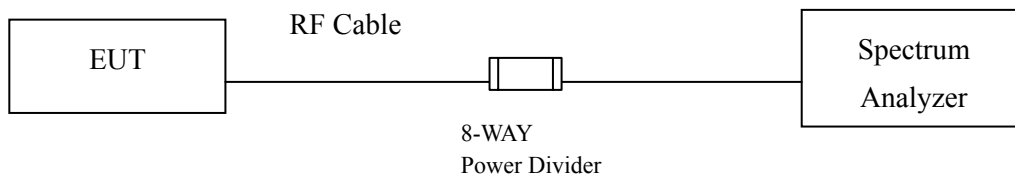
### 6.1. Test Setup

#### RF Radiated Measurement:

Above 1GHz



#### RF Conducted Measurement



### 6.2. Limit

In any 100 kHz bandwidth outside the frequency band in which the spread spectrum intentional radiator is operating, the radio frequency power that is produced by the intentional radiator shall be at least 20 dB below that in the 100 kHz bandwidth within the band that contains the highest level of the desired power, based on either an RF conducted or a radiated measurement. Attenuation below the general limits specified in Section 15.209(a) is not required. In addition, radiated emissions which fall in the restricted bands, as defined in Section 15.205(a), must also comply with the radiated emission limits specified in Section 15.209(a) (see Section 15.205(c)).

### 6.3. Test Procedure

The EUT is placed on a turn table which is 1.5 meter above ground. The turn table is rotated 360 degrees to determine the position of the maximum emission level. The EUT was positioned such that the distance from antenna to the EUT was 3 meters.

The antenna can move up and down between 1 meter and 4 meters to find out the maximum emission level.

Both horizontal and vertical polarization of the antenna are set on measurement. In order to find the maximum emission, all of the interface cables must be manipulated according to ANSI C63.10: 2013 on radiated measurement.

The bandwidth setting below 1GHz and above 1GHz on the field strength meter is 120 kHz and 1MHz, respectively.

### 6.4. Uncertainty

± 4.08 dB above 1GHz

± 4.22 dB below 1GHz



### 6.5. Test Result of Band Edge

Product : FLIC HUB  
 Test Item : Band Edge  
 Test Site : No.3 OATS  
 Test date : 2018/01/26  
 Test Mode : Mode 1: Transmit - 1Mbps (GFSK) (2402MHz)

#### RF Radiated Measurement (Horizontal):

Channel No.	Frequency (MHz)	Correct Factor (dB)	Reading Level (dBμV)	Emission Level (dBμV/m)	Peak Limit (dBμV/m)	Average Limit (dBμV/m)	Result
00 (Peak)	2377.700	6.421	39.110	45.530	74.00	54.00	Pass
00 (Peak)	2390.000	6.474	37.395	43.870	74.00	54.00	Pass
00 (Peak)	2400.000	6.528	52.587	59.115	--	--	--
00 (Peak)	2402.200	6.541	93.343	99.884	--	--	--
00 (Average)	2378.400	6.424	26.929	33.353	74.00	54.00	Pass
00 (Average)	2390.000	6.474	25.500	31.975	74.00	54.00	Pass
00 (Average)	2400.000	6.528	38.597	45.125	--	--	--
00 (Average)	2402.100	6.541	79.029	85.570	--	--	--

Figure Channel 00: Horizontal (Peak)

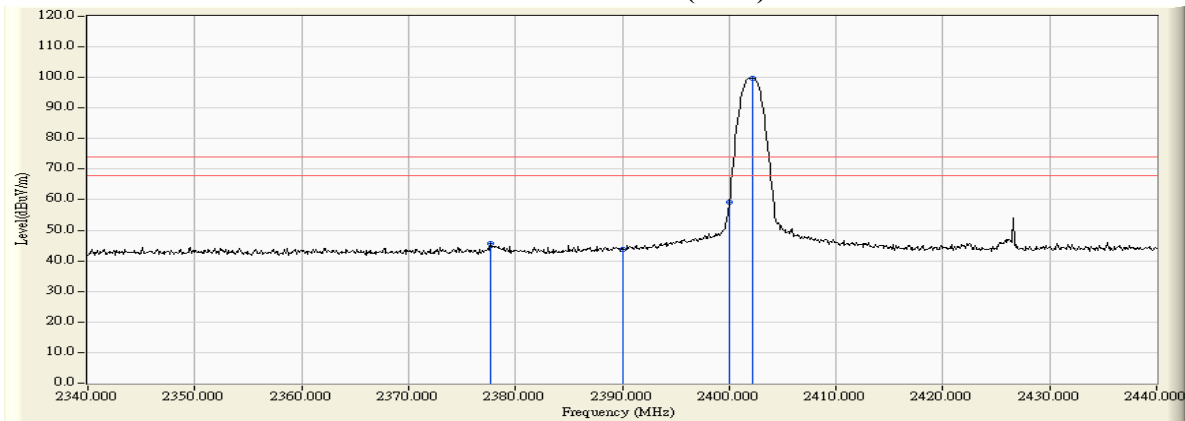
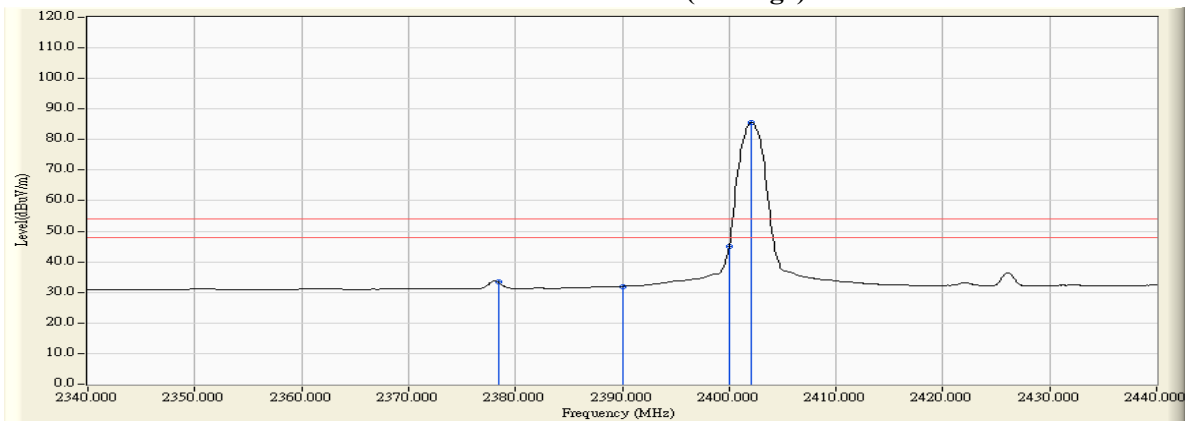


Figure Channel 00: Horizontal (Average)



Note:

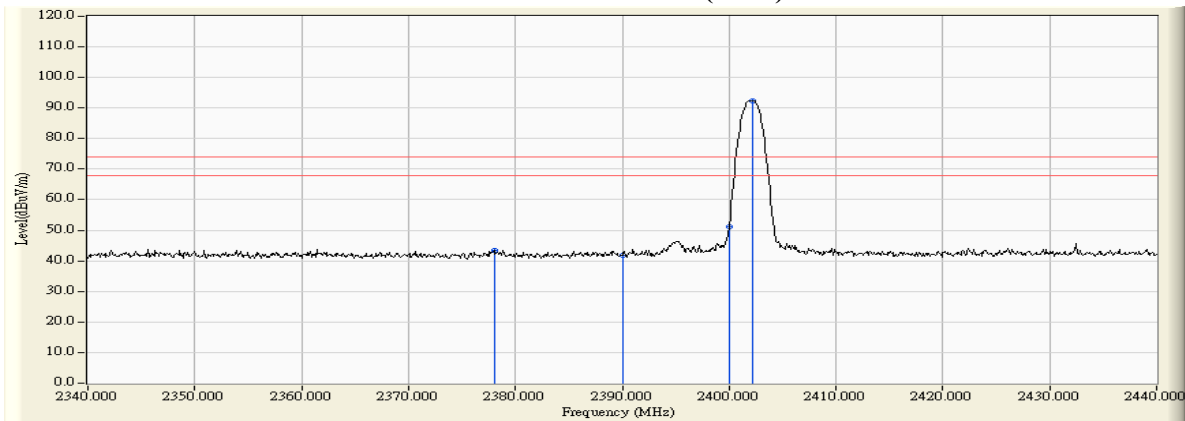
1. All readings above 1GHz are performed with peak and/or average measurements as necessary.
2. Peak measurements: RBW = 1MHz, VBW = 3 MHz, Sweep: Auto.
3. Average measurements: RBW = 1MHz, VBW = 10 Hz, Sweep: Auto.
4. “ \* ”, means this data is the worst emission level.
5. Measurement Level = Reading Level + Correction Factor.
6. The average measurement was not performed when the peak measured data is under the limit of average detection.

Product : FLIC HUB  
 Test Item : Band Edge  
 Test Site : No.3 OATS  
 Test date : 2018/01/26  
 Test Mode : Mode 1: Transmit - 1Mbps (GFSK) (2402MHz)

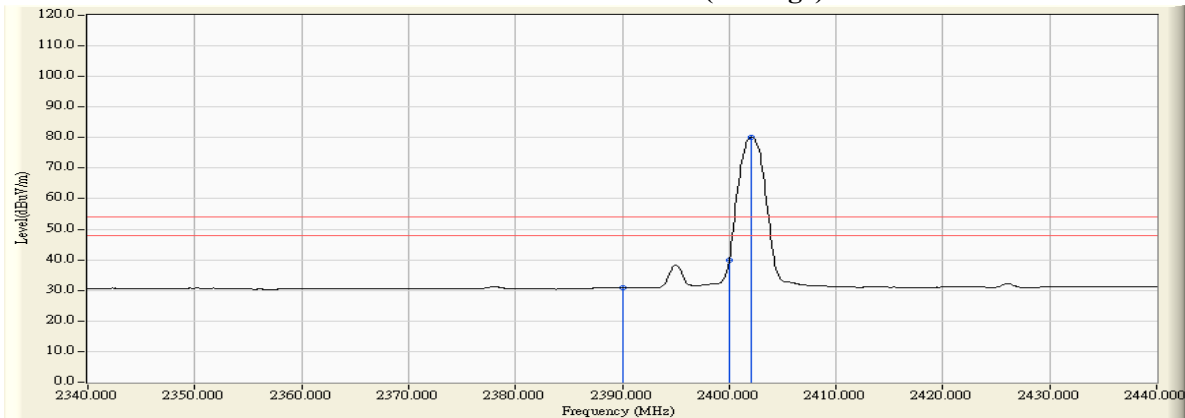
**RF Radiated Measurement (VERTICAL):**

Channel No.	Frequency (MHz)	Correct Factor (dB)	Reading Level (dBμV)	Emission Level (dBμV/m)	Peak Limit (dBμV/m)	Average Limit (dBμV/m)	Result
00 (Peak)	2378.000	5.930	37.499	43.429	74.00	54.00	Pass
00 (Peak)	2390.000	5.880	35.917	41.798	74.00	54.00	Pass
00 (Peak)	2400.000	5.879	45.143	51.022	--	--	--
00 (Peak)	2402.200	5.884	86.589	92.473	--	--	--
00 (Average)	2390.000	5.880	24.962	30.843	74.00	54.00	Pass
00 (Average)	2400.000	5.879	33.971	39.850	--	--	--
00 (Average)	2402.100	5.884	74.264	80.148	--	--	--

**Figure Channel 00: VERTICAL (Peak)**



**Figure Channel 00: VERTICAL (Average)**



**Note:**

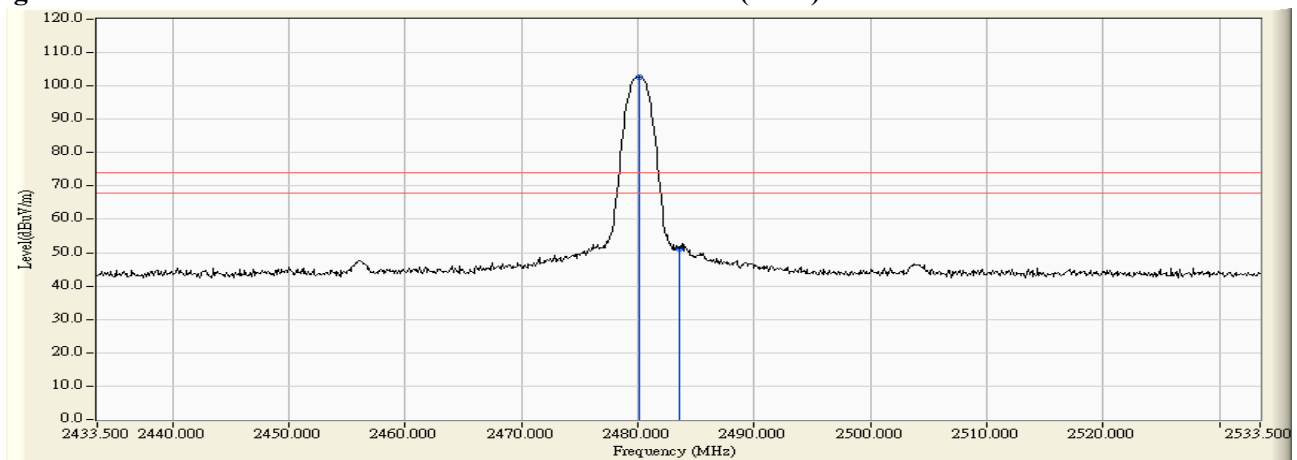
1. All readings above 1GHz are performed with peak and/or average measurements as necessary.
2. Peak measurements: RBW = 1MHz, VBW = 3 MHz, Sweep: Auto.
3. Average measurements: RBW = 1MHz, VBW = 10 Hz, Sweep: Auto.
4. “ \* ”, means this data is the worst emission level.
5. Measurement Level = Reading Level + Correction Factor.
6. The average measurement was not performed when the peak measured data is under the limit of average detection.

Product : FLIC HUB  
 Test Item : Band Edge  
 Test Site : No.3 OATS  
 Test date : 2018/01/26  
 Test Mode : Mode 1: Transmit - 1Mbps (GFSK) (2480MHz)

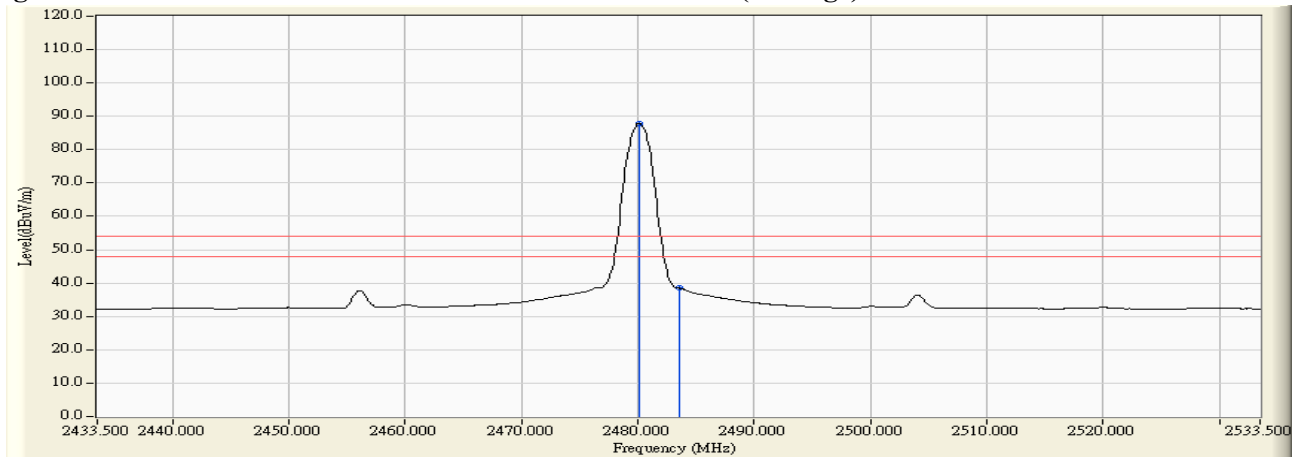
**RF Radiated Measurement (Horizontal):**

Channel No.	Frequency (MHz)	Correct Factor (dB)	Reading Level (dBμV)	Emission Level (dBμV/m)	Peak Limit (dBμV/m)	Average Limit (dBμV/m)	Result
78 (Peak)	2480.100	7.086	95.427	102.513	--	--	Pass
78 (Peak)	2483.500	7.110	44.067	51.177	74.00	54.00	Pass
78 (Average)	2480.100	7.086	80.848	87.934	--	--	Pass
78 (Average)	2483.500	7.110	31.387	38.497	74.00	54.00	Pass

**Figure Channel 78: Horizontal (Peak)**



**Figure Channel 78: Horizontal (Average)**



**Note:**

1. All readings above 1GHz are performed with peak and/or average measurements as necessary.
2. Peak measurements: RBW = 1MHz, VBW = 3 MHz, Sweep: Auto.
3. Average measurements: RBW = 1MHz, VBW = 10 Hz, Sweep: Auto.
4. “\*” means this data is the worst emission level.
5. Measurement Level = Reading Level + Correction Factor.
6. The average measurement was not performed when the peak measured data is under the limit of average detection.

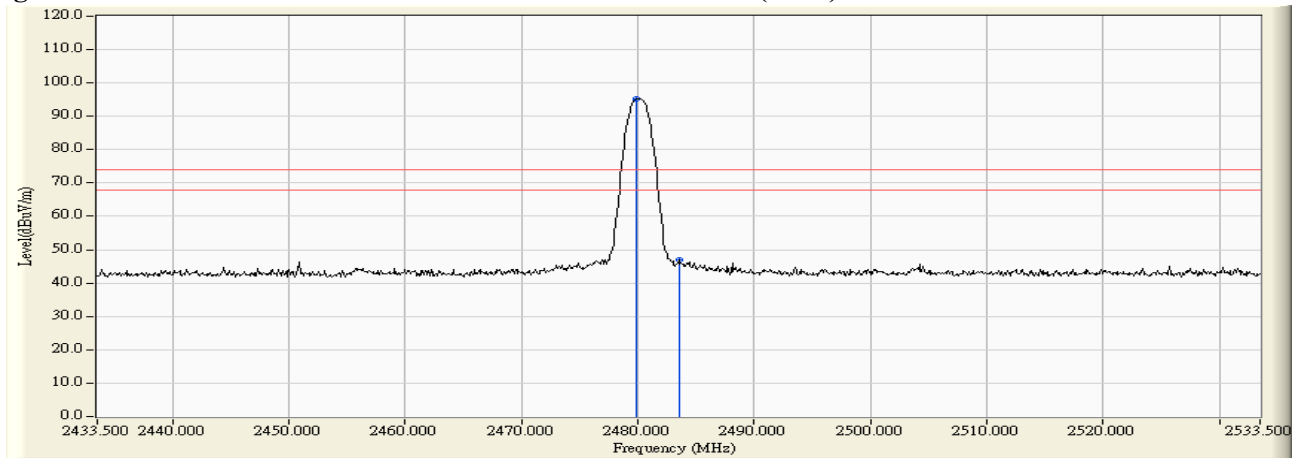
Product : FLIC HUB  
 Test Item : Band Edge  
 Test Site : No.3 OATS  
 Test date : 2018/01/26  
 Test Mode : Mode 1: Transmit - 1Mbps (GFSK) (2480MHz)

**RF Radiated Measurement (VERTICAL):**

Channel No.	Frequency (MHz)	Correct Factor (dB)	Reading Level (dBμV)	Emission Level (dBμV/m)	Peak Limit (dBμV/m)	Average Limit (dBμV/m)	Result
78 (Peak)	2479.900	6.341	88.915	95.256	--	--	Pass
78 (Peak)	2483.500	6.363	40.461	46.824	74.00	54.00	Pass
78 (Average)	2480.100	6.342	75.629	81.971	--	--	Pass
78 (Average)	2483.500	6.363	27.619	33.982	74.00	54.00	Pass

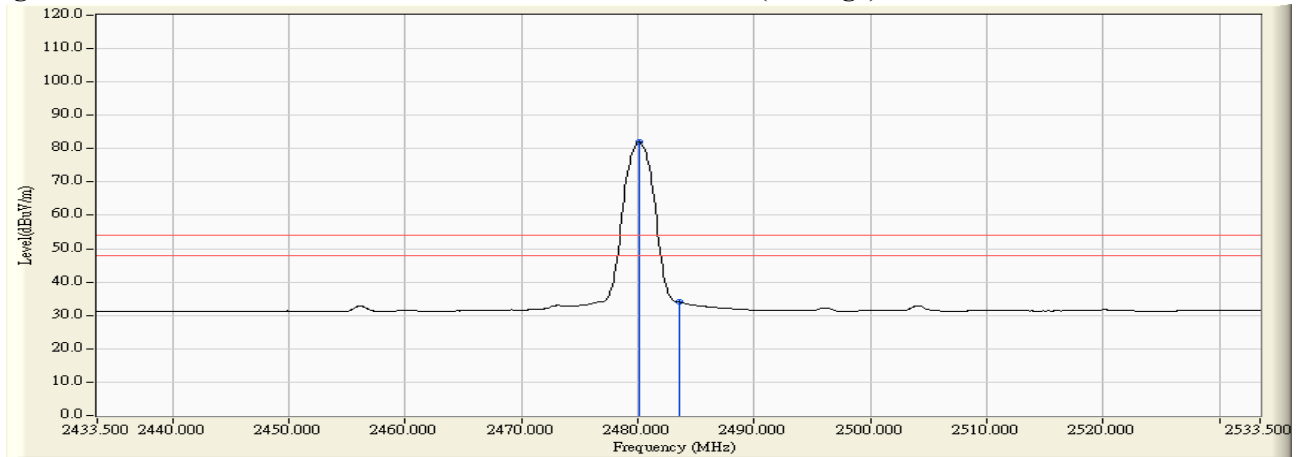
**Figure Channel 78:**

**VERTICAL (Peak)**



**Figure Channel 78:**

**VERTICAL (Average)**



**Note:**

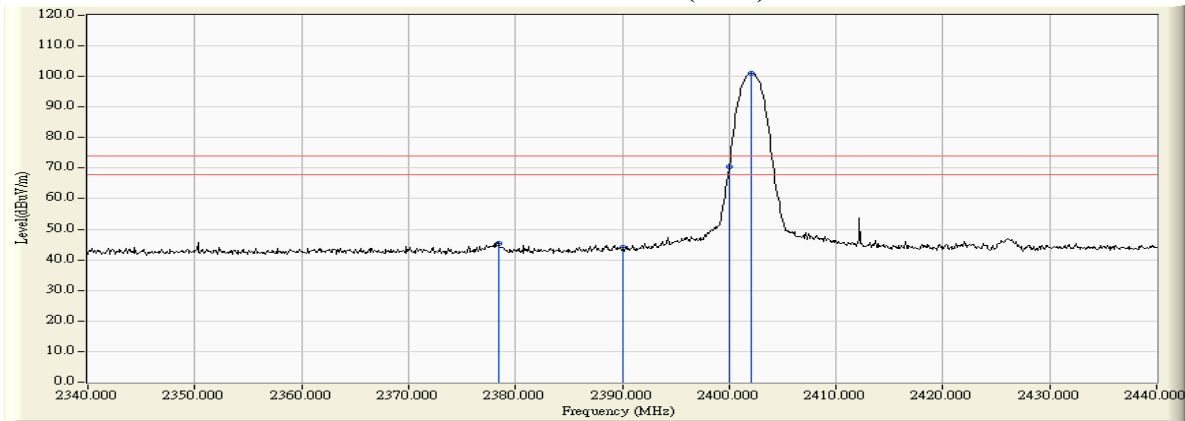
1. All readings above 1GHz are performed with peak and/or average measurements as necessary.
2. Peak measurements: RBW = 1MHz, VBW = 3 MHz, Sweep: Auto.
3. Average measurements: RBW = 1MHz, VBW = 10 Hz, Sweep: Auto.
4. “ \* ”, means this data is the worst emission level.
5. Measurement Level = Reading Level + Correction Factor.
6. The average measurement was not performed when the peak measured data is under the limit of average detection.

Product : FLIC HUB  
 Test Item : Band Edge  
 Test Site : No.3 OATS  
 Test date : 2018/01/26  
 Test Mode : Mode 2: Transmit - 3Mbps (8DPSK) (2402MHz)

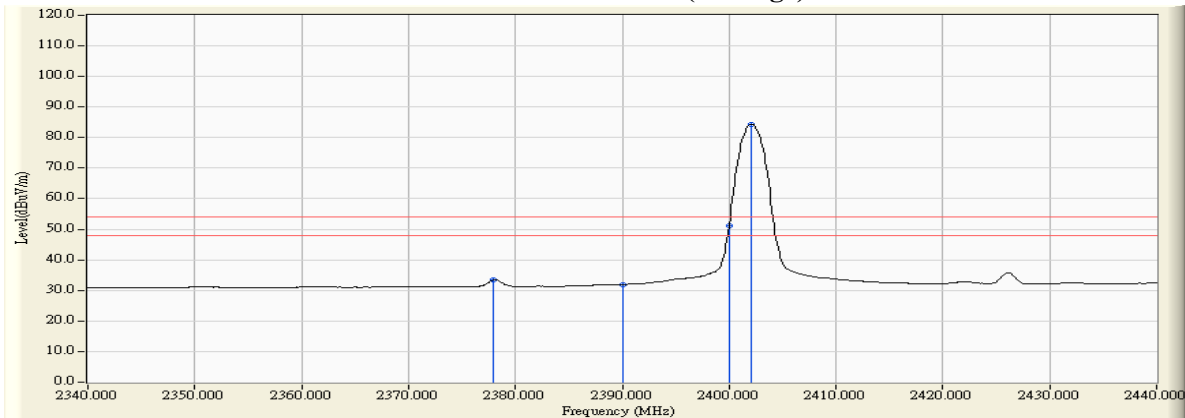
**RF Radiated Measurement (Horizontal):**

Channel No.	Frequency (MHz)	Correct Factor (dB)	Reading Level (dBμV)	Emission Level (dBμV/m)	Peak Limit (dBμV/m)	Average Limit (dBμV/m)	Result
00 (Peak)	2378.400	6.424	38.894	45.318	74.00	54.00	Pass
00 (Peak)	2390.000	6.474	37.604	44.079	74.00	54.00	Pass
00 (Peak)	2400.000	6.528	63.778	70.306	--	--	--
00 (Peak)	2402.100	6.541	94.492	101.033	--	--	--
00 (Average)	2377.900	6.422	26.906	33.327	74.00	54.00	Pass
00 (Average)	2390.000	6.474	25.478	31.953	74.00	54.00	Pass
00 (Average)	2400.000	6.528	44.718	51.246	--	--	--
00 (Average)	2402.100	6.541	77.872	84.413	--	--	--

**Figure Channel 00: Horizontal (Peak)**



**Figure Channel 00: Horizontal (Average)**



**Note:**

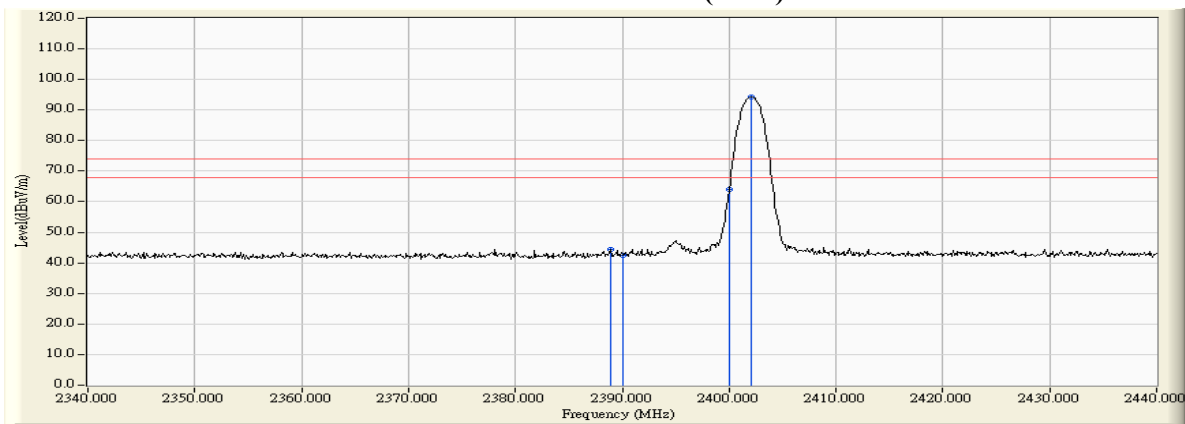
1. All readings above 1GHz are performed with peak and/or average measurements as necessary.
2. Peak measurements: RBW = 1MHz, VBW = 3 MHz, Sweep: Auto.
3. Average measurements: RBW = 1MHz, VBW = 10 Hz, Sweep: Auto.
4. “ \* ”, means this data is the worst emission level.
5. Measurement Level = Reading Level + Correction Factor.
6. The average measurement was not performed when the peak measured data is under the limit of average detection.

Product : FLIC HUB  
 Test Item : Band Edge  
 Test Site : No.3 OATS  
 Test date : 2018/01/26  
 Test Mode : Mode 2: Transmit - 3Mbps (8DPSK) (2402MHz)

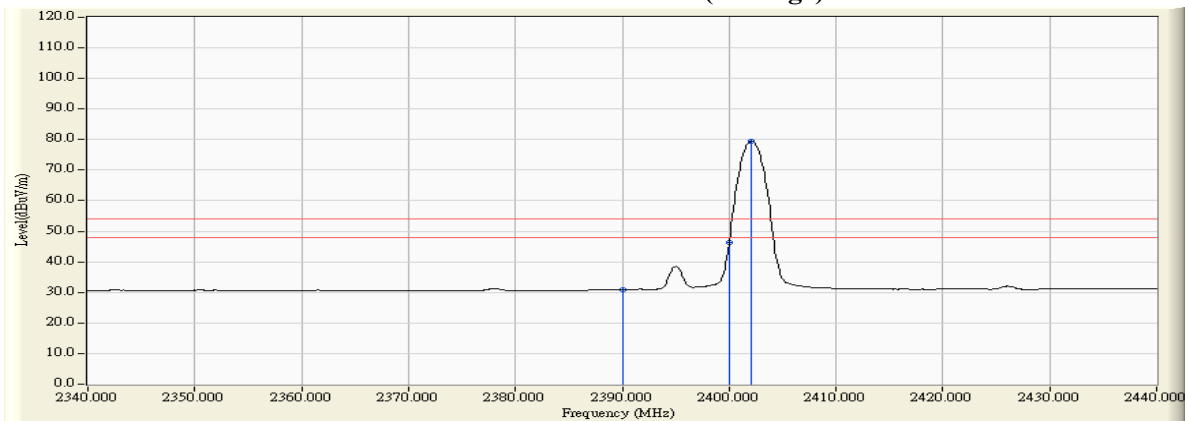
**RF Radiated Measurement (VERTICAL):**

Channel No.	Frequency (MHz)	Correct Factor (dB)	Reading Level (dBμV)	Emission Level (dBμV/m)	Peak Limit (dBμV/m)	Average Limit (dBμV/m)	Result
00 (Peak)	2388.900	5.885	38.497	44.382	74.00	54.00	Pass
00 (Peak)	2390.000	5.880	36.633	42.514	74.00	54.00	Pass
00 (Peak)	2400.000	5.879	57.982	63.861	--	--	--
00 (Peak)	2402.100	5.884	88.474	94.358	--	--	--
00 (Average)	2390.000	5.880	25.048	30.929	74.00	54.00	Pass
00 (Average)	2400.000	5.879	40.321	46.200	--	--	--
00 (Average)	2402.100	5.884	73.574	79.458	--	--	--

**Figure Channel 00: VERTICAL (Peak)**



**Figure Channel 00: VERTICAL (Average)**



**Note:**

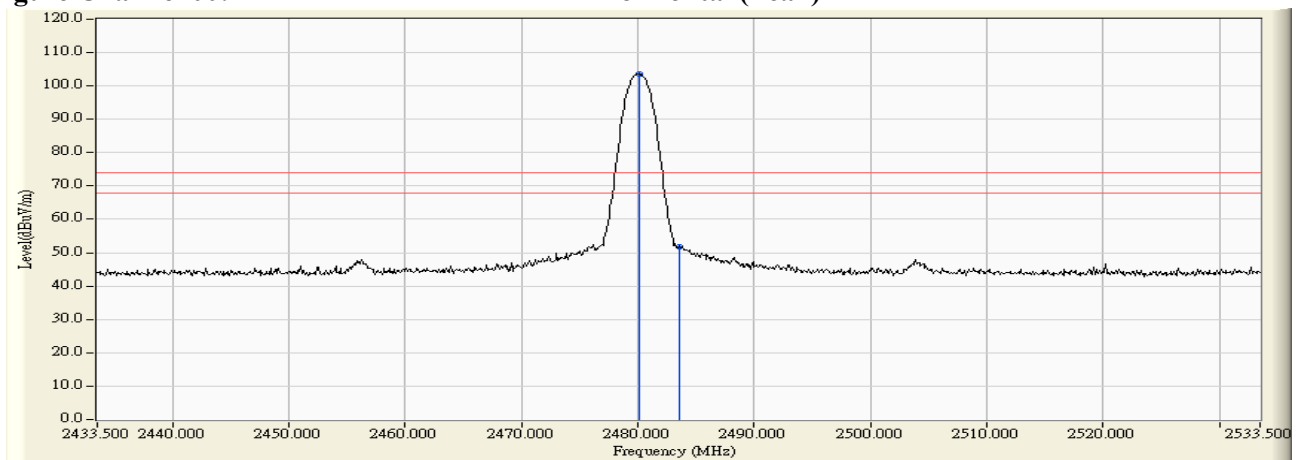
1. All readings above 1GHz are performed with peak and/or average measurements as necessary.
2. Peak measurements: RBW = 1MHz, VBW = 3 MHz, Sweep: Auto.
3. Average measurements: RBW = 1MHz, VBW = 10 Hz, Sweep: Auto.
4. “ \* ”, means this data is the worst emission level.
5. Measurement Level = Reading Level + Correction Factor.
6. The average measurement was not performed when the peak measured data is under the limit of average detection.

Product : FLIC HUB  
 Test Item : Band Edge  
 Test Site : No.3 OATS  
 Test date : 2018/01/26  
 Test Mode : Mode 2: Transmit - 3Mbps (8DPSK) (2480MHz)

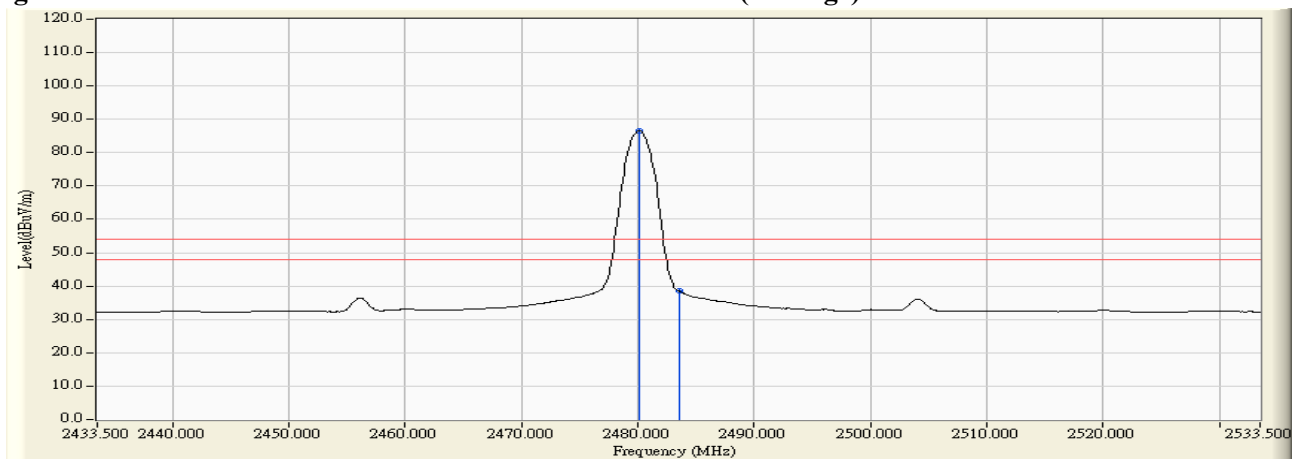
**RF Radiated Measurement (Horizontal):**

Channel No.	Frequency (MHz)	Correct Factor (dB)	Reading Level (dBμV)	Emission Level (dBμV/m)	Peak Limit (dBμV/m)	Average Limit (dBμV/m)	Result
78 (Peak)	2480.100	7.086	96.633	103.719	--	--	Pass
78 (Peak)	2483.500	7.110	44.669	51.779	74.00	54.00	Pass
78 (Average)	2480.100	7.086	79.487	86.573	--	--	Pass
78 (Average)	2483.500	7.110	31.375	38.485	74.00	54.00	Pass

**Figure Channel 00: Horizontal (Peak)**



**Figure Channel 00: Horizontal (Average)**



**Note:**

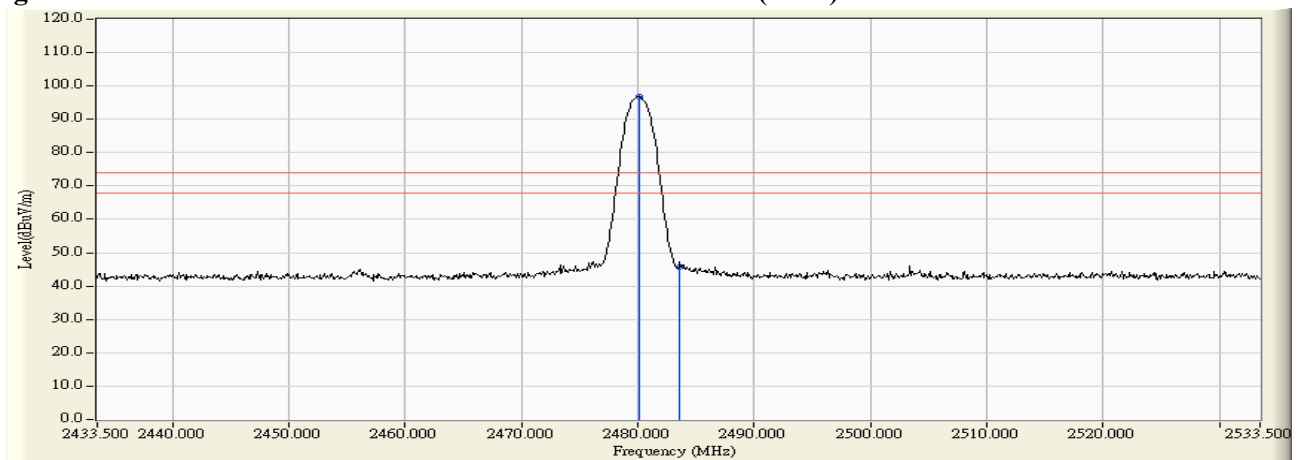
1. All readings above 1GHz are performed with peak and/or average measurements as necessary.
2. Peak measurements: RBW = 1MHz, VBW = 3 MHz, Sweep: Auto.
3. Average measurements: RBW = 1MHz, VBW = 10 Hz, Sweep: Auto.
4. “ \* ”, means this data is the worst emission level.
5. Measurement Level = Reading Level + Correction Factor.
6. The average measurement was not performed when the peak measured data is under the limit of average detection.

Product : FLIC HUB  
 Test Item : Band Edge  
 Test Site : No.3 OATS  
 Test date : 2018/01/26  
 Test Mode : Mode 2: Transmit - 3Mbps (8DPSK) (2480MHz)

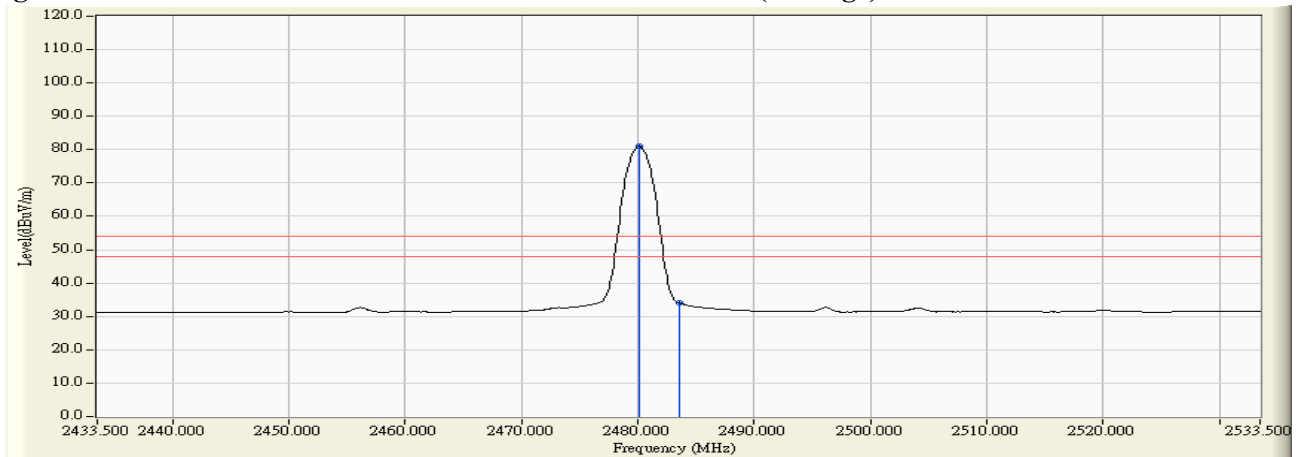
**RF Radiated Measurement (VERTICAL):**

Channel No.	Frequency (MHz)	Correct Factor (dB)	Reading Level (dBμV)	Emission Level (dBμV/m)	Peak Limit (dBμV/m)	Average Limit (dBμV/m)	Result
78 (Peak)	2480.100	6.342	90.400	96.742	--	--	Pass
78 (Peak)	2483.500	6.363	39.225	45.588	74.00	54.00	Pass
78 (Average)	2480.100	6.342	74.729	81.071	--	--	Pass
78 (Average)	2483.500	6.363	27.712	34.075	74.00	54.00	Pass

**Figure Channel 78: VERTICAL (Peak)**



**Figure Channel 78: VERTICAL (Average)**



**Note:**

1. All readings above 1GHz are performed with peak and/or average measurements as necessary.
2. Peak measurements: RBW = 1MHz, VBW = 3 MHz, Sweep: Auto.
3. Average measurements: RBW = 1MHz, VBW = 10 Hz, Sweep: Auto.
4. “\*” means this data is the worst emission level.
5. Measurement Level = Reading Level + Correction Factor.
6. The average measurement was not performed when the peak measured data is under the limit of average detection.



Product : FLIC HUB  
 Test Item : Band Edge  
 Test Site : No.3 OATS  
 Test Mode : Mode 1: Transmit - 1Mbps (GFSK)(Hopping off)

Measurement Level	Result
$\Delta$ (dB)	
> 20	PASS

Figure Channel 00:

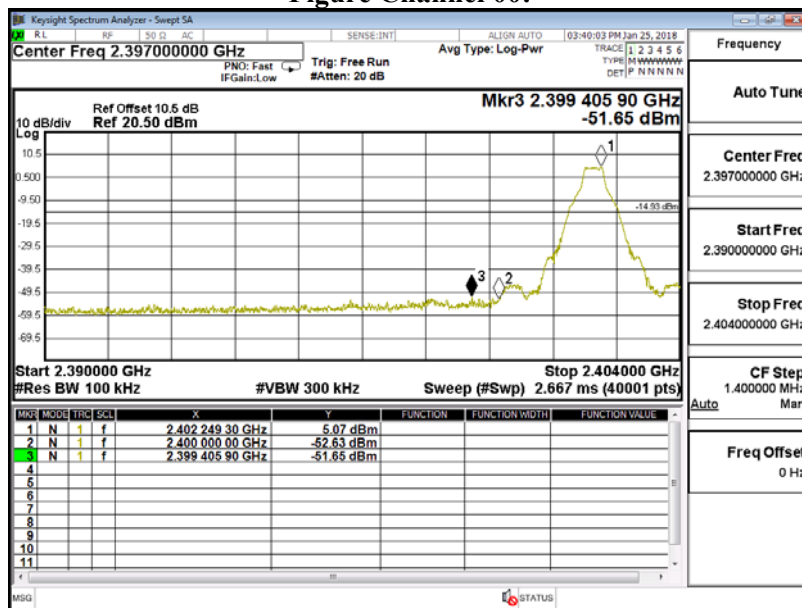
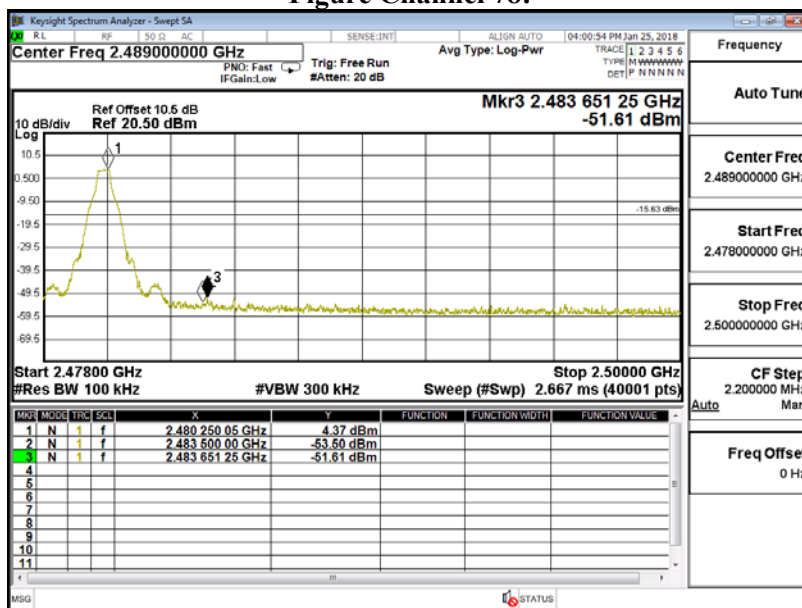


Figure Channel 78:



Product : FLIC HUB  
 Test Item : Band Edge  
 Test Site : No.3 OATS  
 Test Mode : Mode 2: Transmit - 3Mbps (8DPSK) (Hopping off)

Measurement Level	Result
$\Delta$ (dB)	
> 20	PASS

Figure Channel 00:

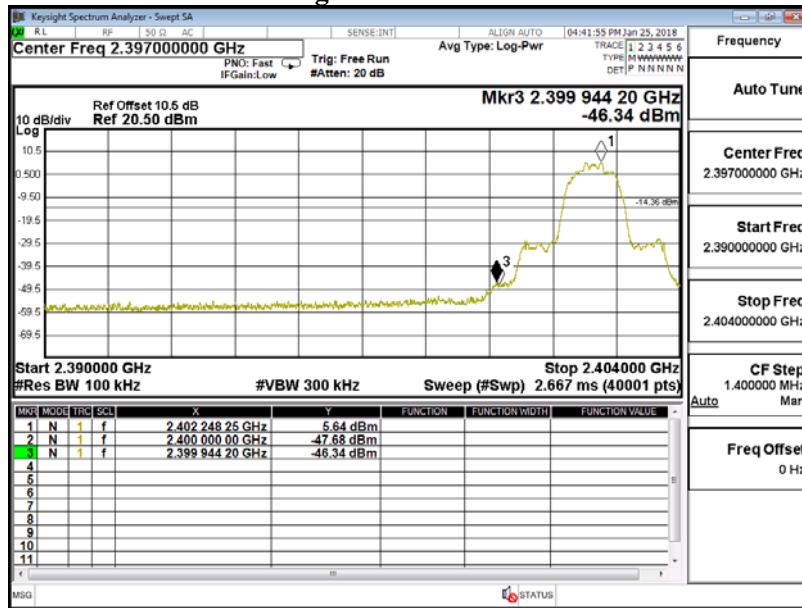
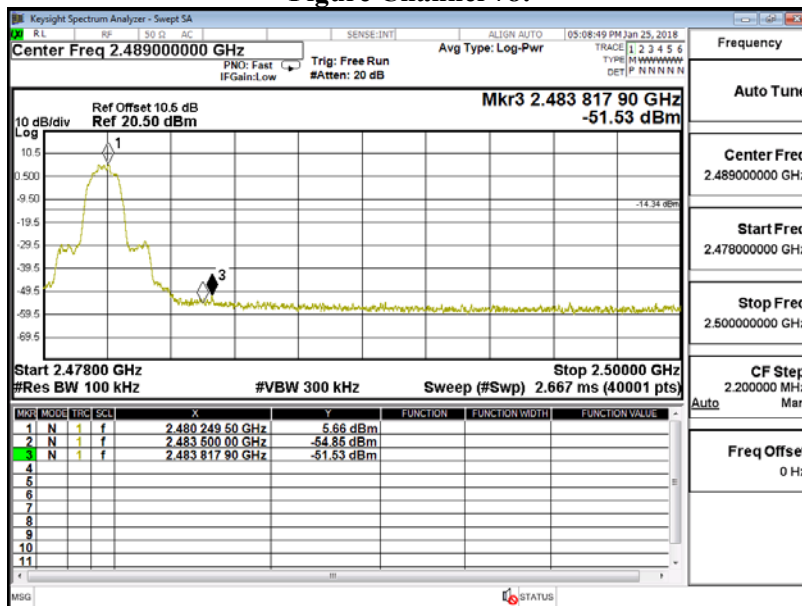


Figure Channel 78:



Product : FLIC HUB  
 Test Item : Band Edge  
 Test Site : No.3 OATS  
 Test Mode : Mode 1: Transmit - 1Mbps (GFSK)(Hopping on)

Measurement Level	Result
$\Delta$ (dB)	
> 20	PASS

Figure Channel 00 Hopping:

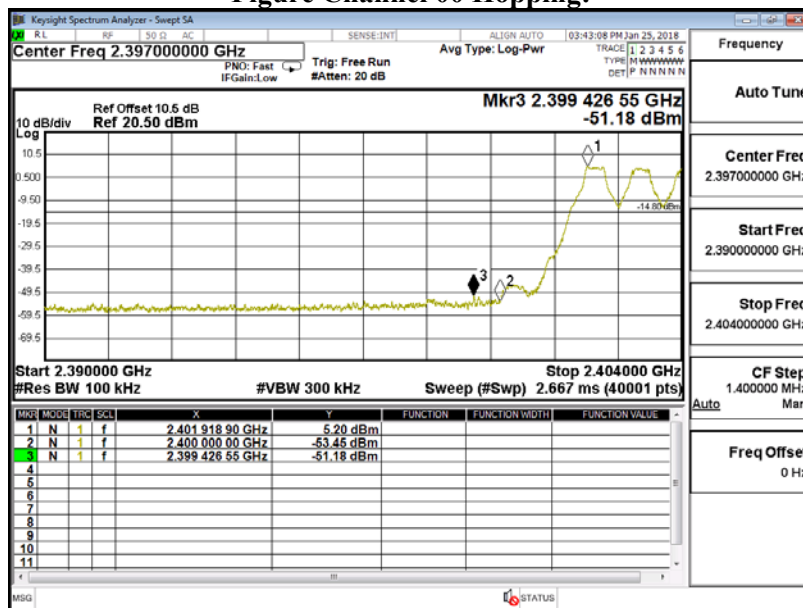
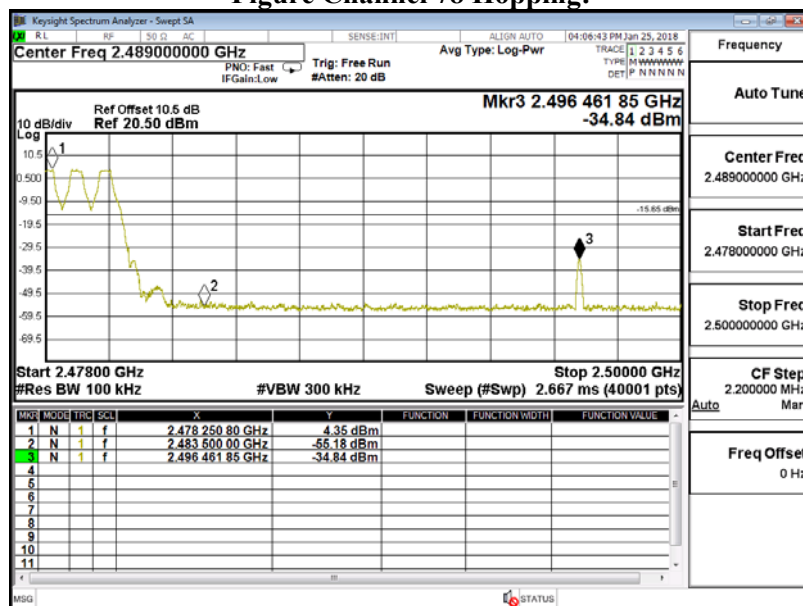


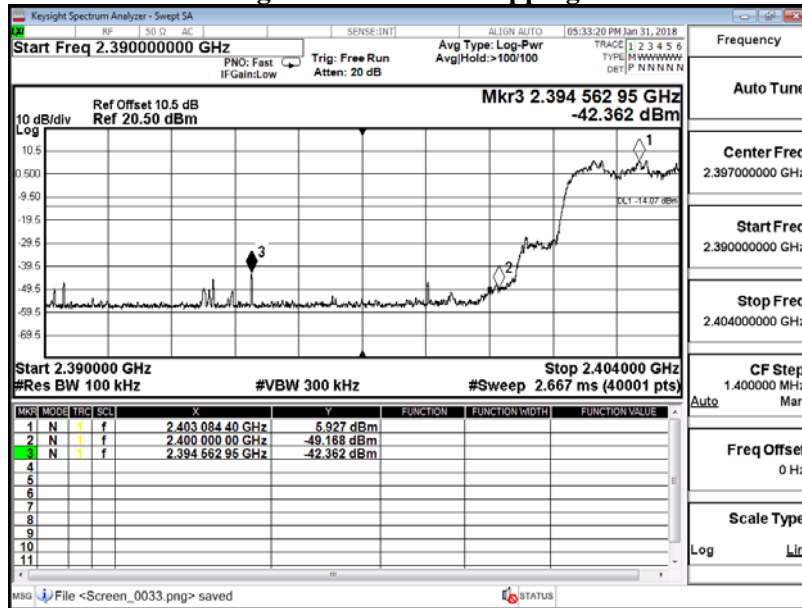
Figure Channel 78 Hopping:



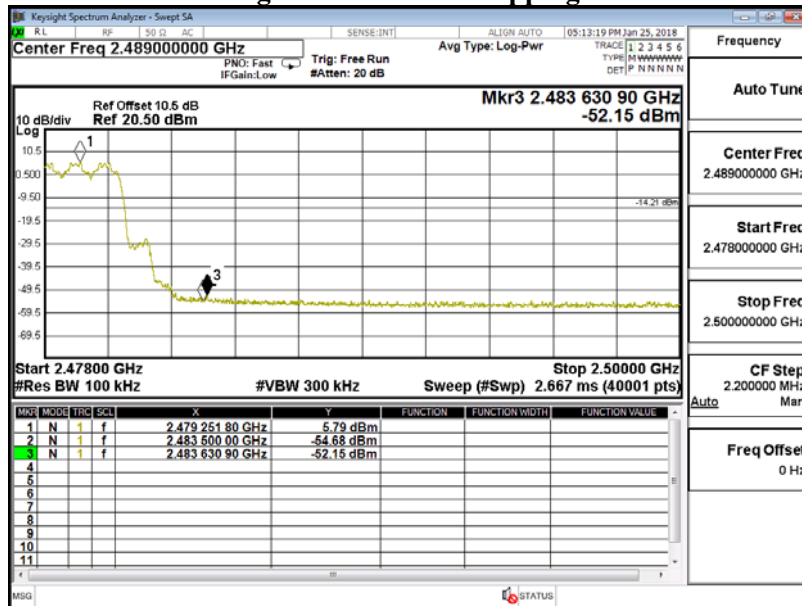
Product : FLIC HUB  
 Test Item : Band Edge  
 Test Site : No.3 OATS  
 Test Mode : Mode 2: Transmit - 3Mbps (8DPSK) (Hopping on)

Measurement Level	Result
$\Delta$ (dB)	
> 20	PASS

**Figure Channel 00 Hopping:**

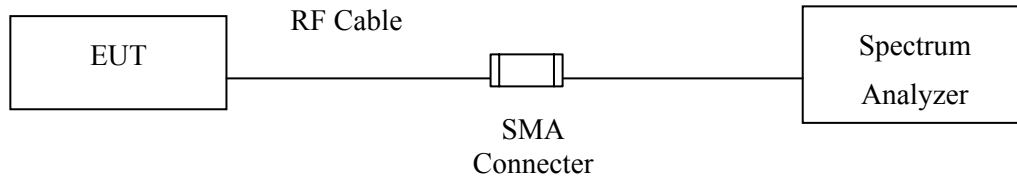


**Figure Channel 78 Hopping:**



## 7. Channel Number

### 7.1. Test Setup



### 7.2. Limit

Frequency hopping systems operating in the 2400-2483.5 MHz bands shall use at least 75 hopping frequencies.

### 7.3. Test Procedure

The EUT was setup to ANSI C63.4, 2014; tested to FHSS test procedure of FCC Public Notice DA 00-705 for compliance to FCC 47CFR 15.247 requirements.

### 7.4. Uncertainty

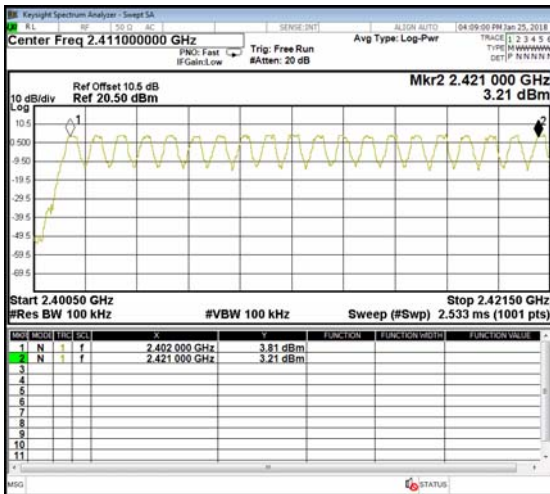
N/A

### 7.5. Test Result of Channel Number

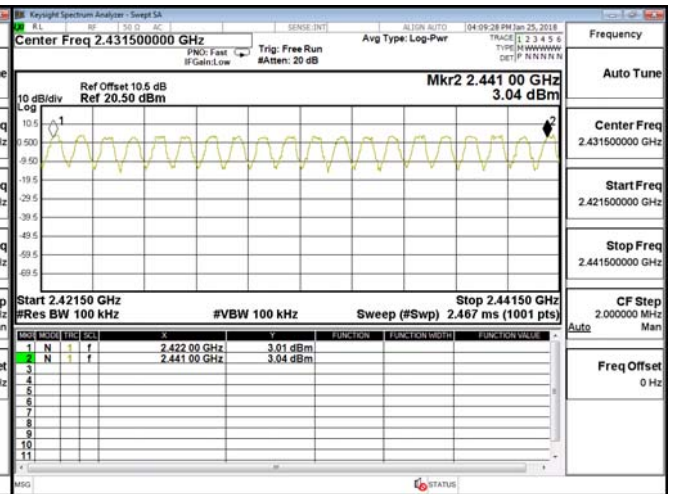
Product : FLIC HUB  
 Test Item : Channel Number  
 Test Site : No.3 OATS  
 Test Mode : Mode 1: Transmit - 1Mbps (GFSK)

Frequency Range (MHz)	Measurement (Hopping Channel)	Required Limit (Hopping Channel)	Result
2402 ~ 2480	79	>75	Pass

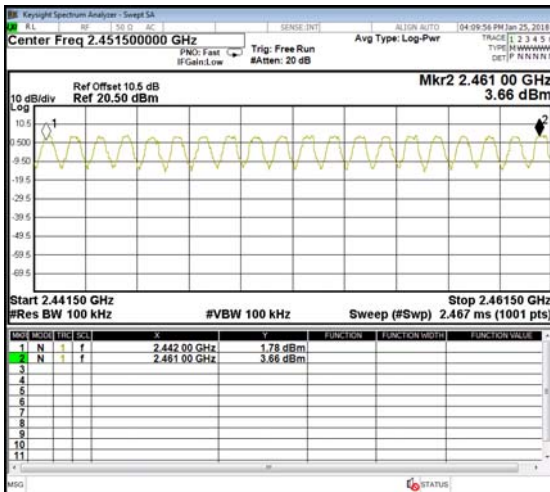
2402-2421MHz



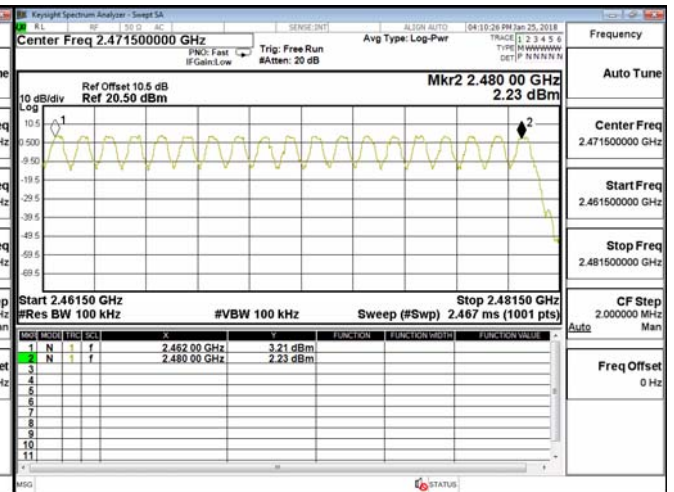
2422-2441MHz



2442-2461MHz



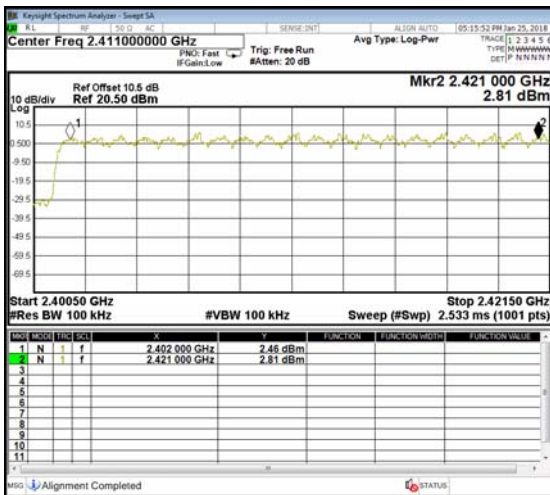
2462-2480MHz



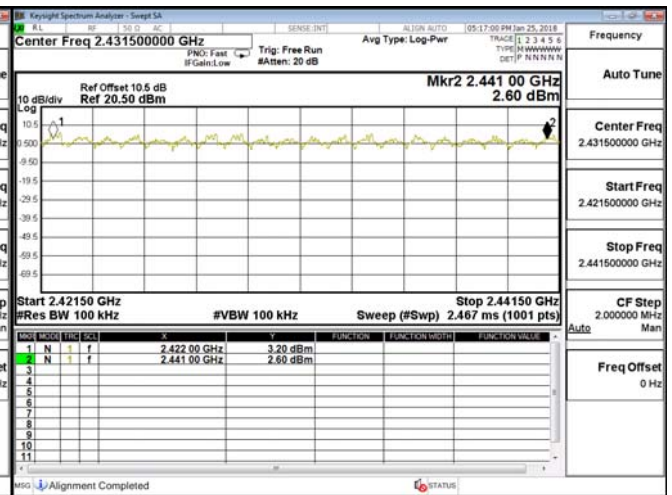
Product : FLIC HUB  
 Test Item : Channel Number  
 Test Site : No.3 OATS  
 Test Mode : Mode 2: Transmit - 3Mbps (8DPSK)

Frequency Range (MHz)	Measurement (Hopping Channel)	Required Limit (Hopping Channel)	Result
2402 ~ 2480	79	>75	Pass

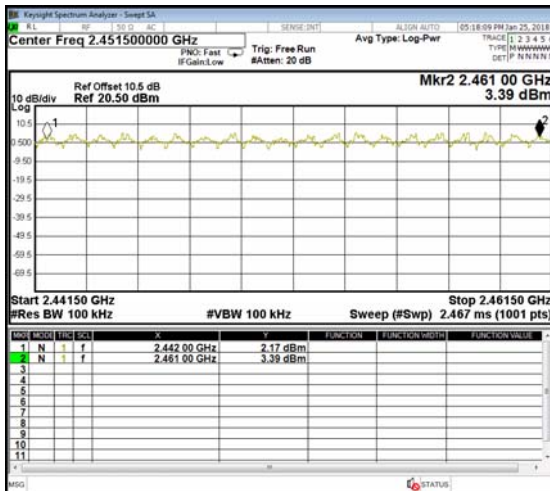
2402-2421MHz



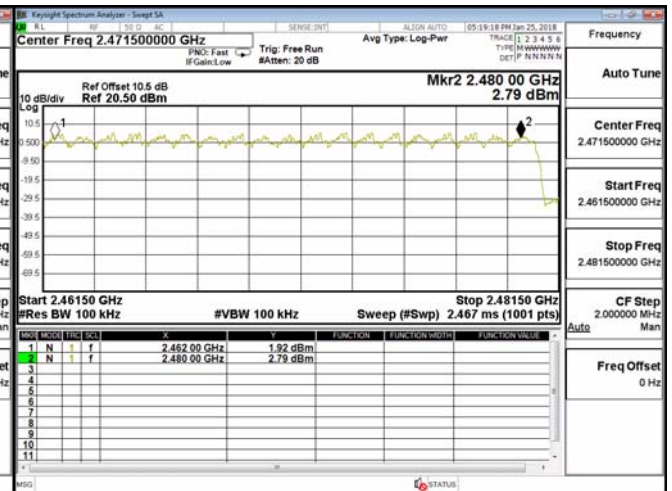
2422-2441MHz



2442-2461MHz

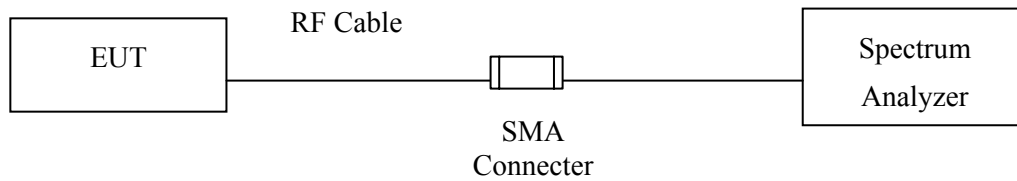


2462-2480MHz



## 8. Channel Separation

### 8.1. Test Setup



### 8.2. Limit

Frequency hopping systems shall have hopping channel carrier frequencies separated by a minimum of 25 kHz or the 20 dB bandwidth of the hopping channel, whichever is greater.

### 8.3. Test Procedure

The EUT was setup to ANSI C63.4, 2014; tested to FHSS test procedure of FCC Public Notice DA 00-705 for compliance to FCC 47CFR 15.247 requirements.

### 8.4. Uncertainty

$\pm 283\text{Hz}$



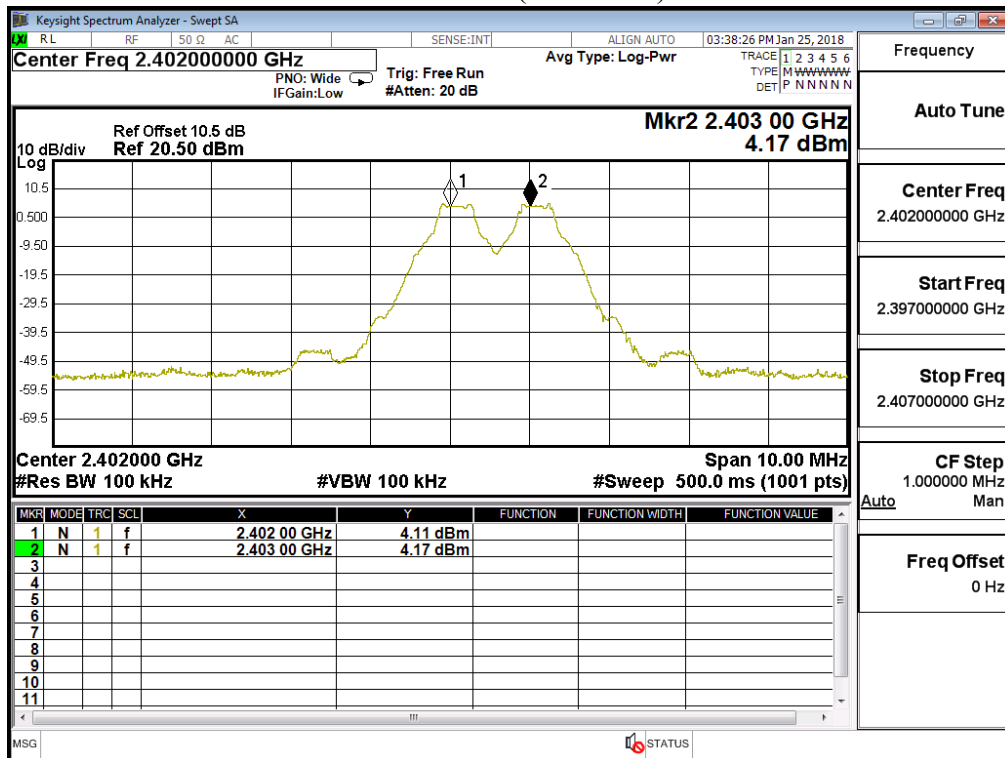
### 8.5. Test Result of Channel Separation

Product : FLIC HUB  
 Test Item : Channel Separation  
 Test Site : No.3 OATS  
 Test Mode : Mode 1: Transmit - 1Mbps (GFSK)

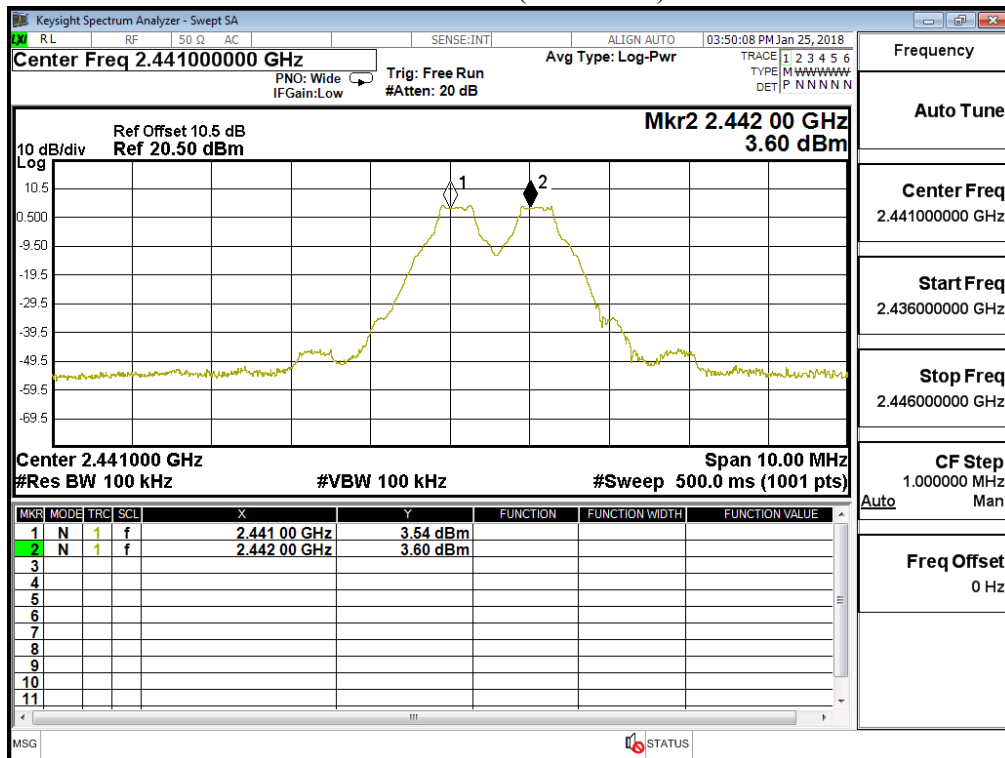
Channel No.	Frequency (MHz)	Measurement Level (kHz)	Limit (kHz)	Limit of (2/3)*20dB Bandwidth (kHz)	Result
00	2402	1000	>25 kHz	638.0	Pass
39	2441	1000	>25 kHz	638.0	Pass
78	2480	1000	>25 kHz	638.0	Pass

NOTE: The 20dB Bandwidth is refer to section 10.

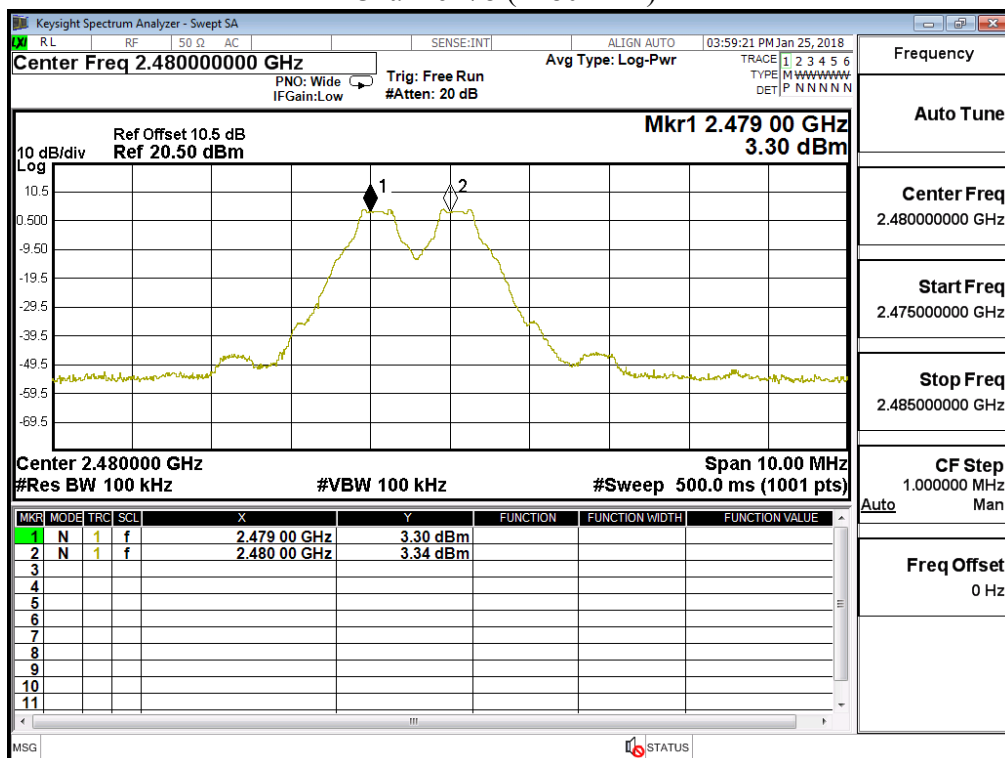
Channel 00 (2402MHz)



### Channel 39 (2441MHz)



### Channel 78 (2480MHz)

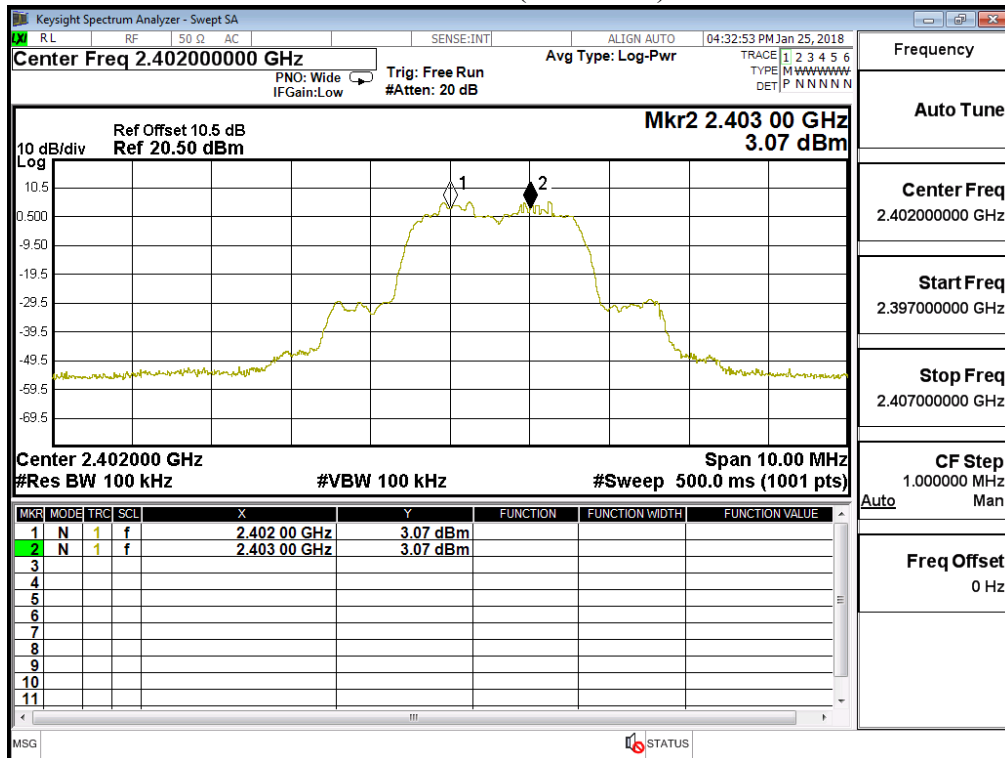


Product : FLIC HUB  
 Test Item : Channel Separation  
 Test Site : No.3 OATS  
 Test Mode : Mode 2: Transmit - 3Mbps (8DPSK)

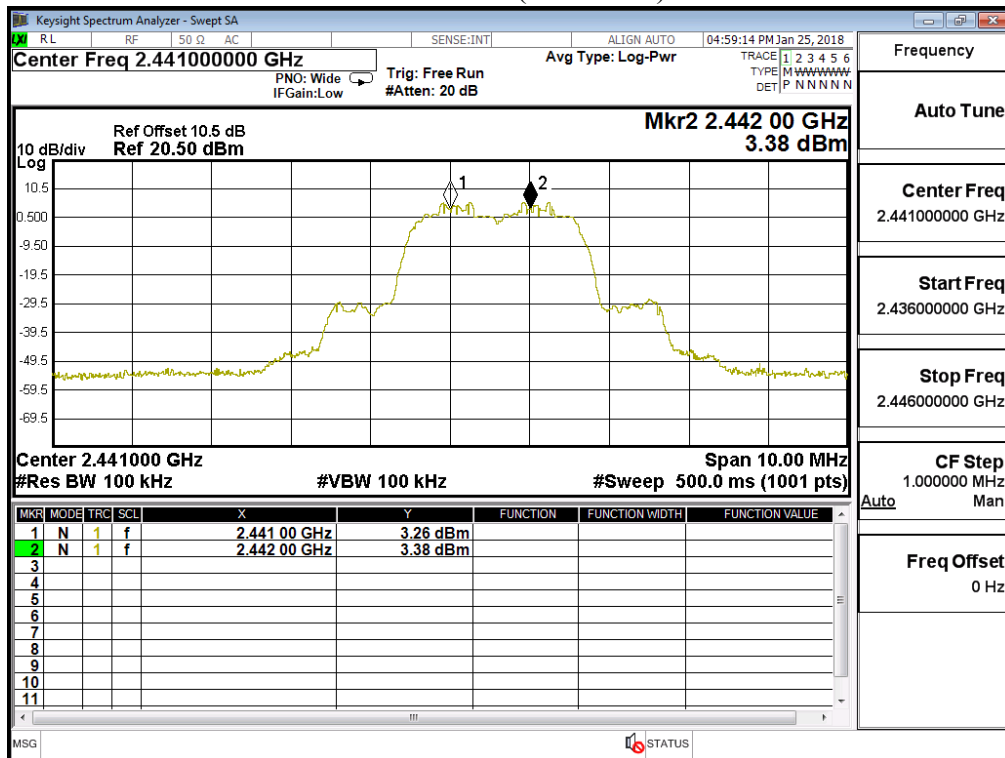
Channel No.	Frequency (MHz)	Measurement Level (kHz)	Limit (kHz)	Limit of (2/3)*20dB Bandwidth (kHz)	Result
00	2402	1000	>25 kHz	868.0	Pass
39	2441	1000	>25 kHz	870.0	Pass
78	2480	1000	>25 kHz	868.0	Pass

NOTE: The 20dB Bandwidth is refer to section 10.

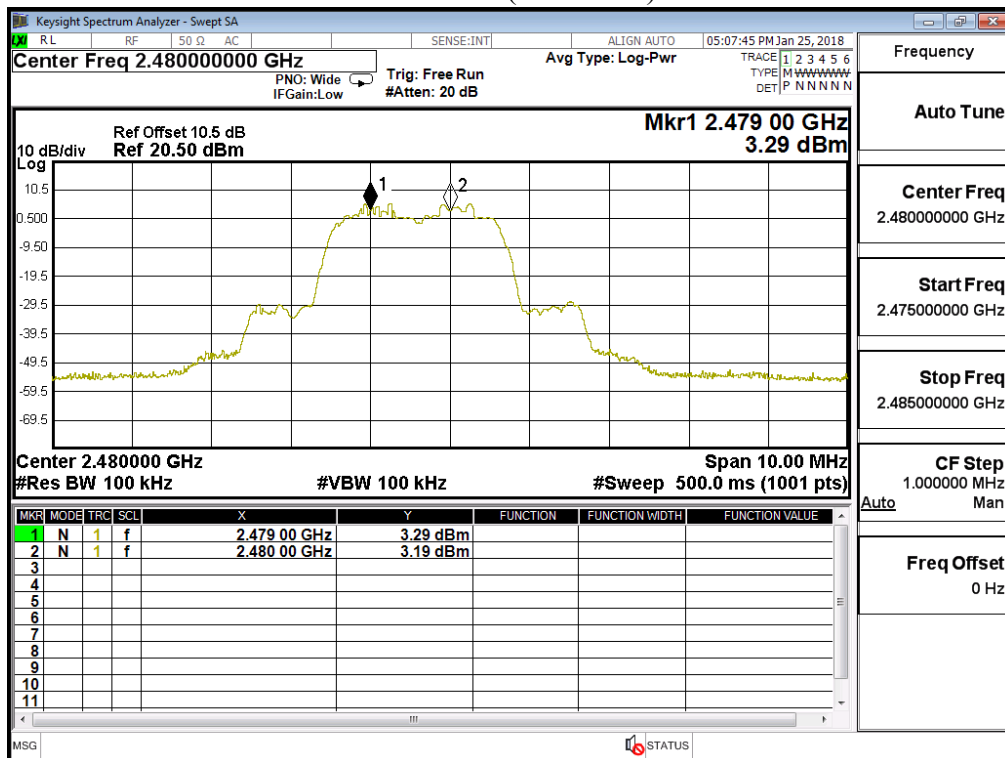
Channel 00 (2402MHz)



### Channel 39 (2441MHz)

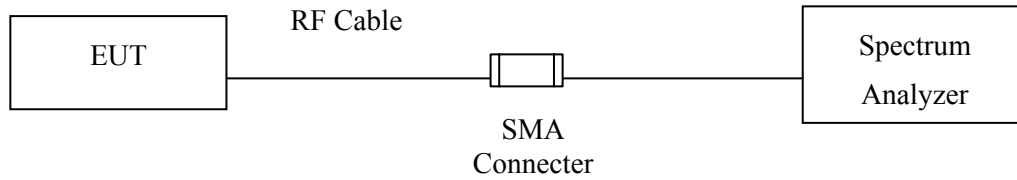


### Channel 78 (2480MHz)



## 9. Dwell Time

### 9.1. Test Setup



### 9.2. Limit

The average time of occupancy on any channel shall not be greater than 0.4 seconds within a period of 0.4 seconds multiplied by the number of hopping channels employed.

### 9.3. Test Procedure

The EUT was setup to ANSI C63.4, 2014; tested to FHSS test procedure of FCC Public Notice DA 00-705 for compliance to FCC 47CFR 15.247 requirements.

### 9.4. Uncertainty

$\pm 25\text{msec}$

### 9.5. Test Result of Dwell Time

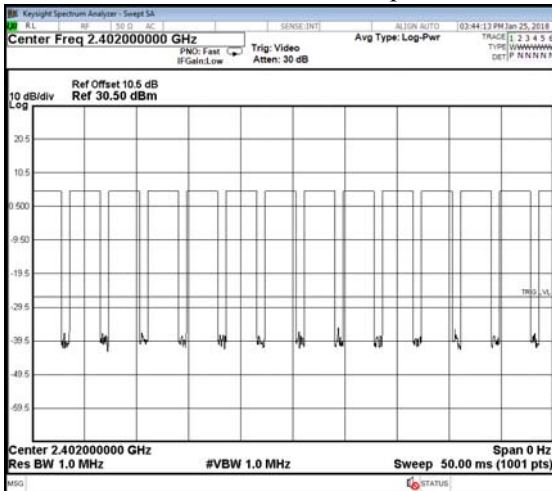
Product : FLIC HUB  
 Test Item : Dwell Time  
 Test Site : No.3 OATS  
 Test Mode : Mode 1: Transmit - 1Mbps (GFSK) (Channel 00,39,78 –DH5)

Frequency (MHz)	Time slot length (ms)	Hopping of Number	Sweep time (ms)	Duty cycle	Dwell Time (Sec)	Limit (Sec)	Result
2402	2.887	13	50	0.75	0.300	0.4	Pass
2441	2.887	13	50	0.75	0.300	0.4	Pass
2480	2.887	13	50	0.75	0.300	0.4	Pass

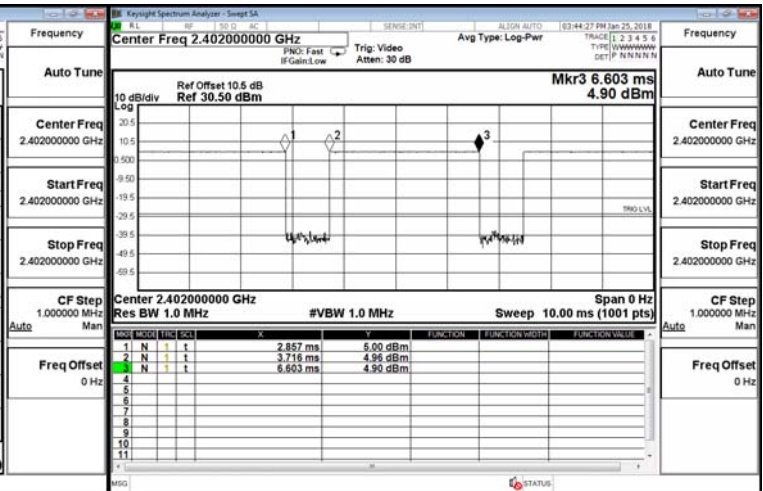
Duty cycle = ((Time slot length(ms)\*Hopping of Number) / Sweep time (ms))

Dwell time = (Duty cycle /79) \* (79\*0.4)

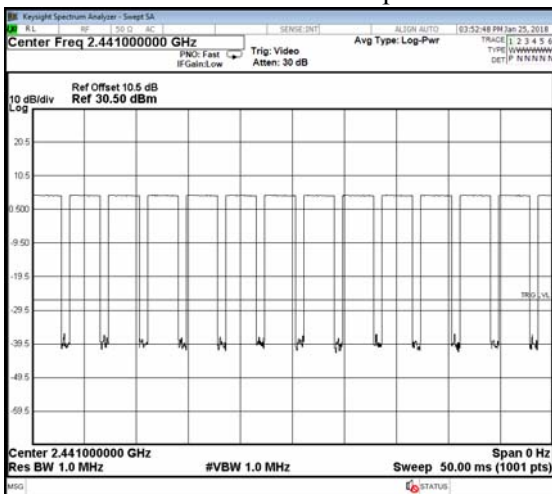
CH 00 Time Interval between hops



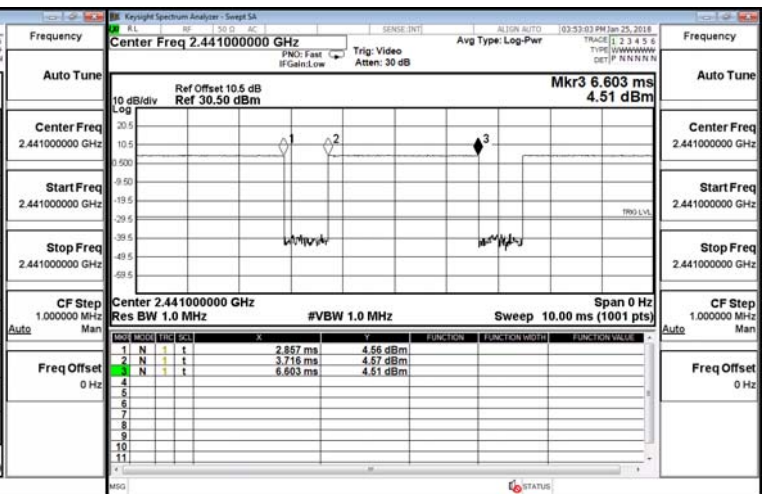
CH 00 Transmission Time



CH39 Time Interval between hops

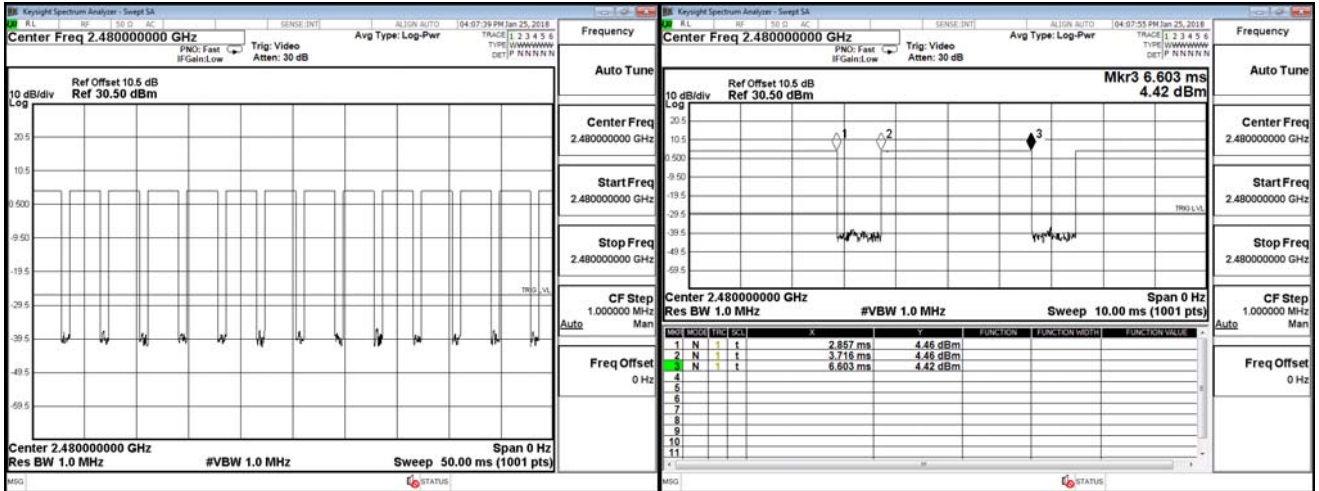


CH 39Transmission Time



CH 78 Time Interval between hops

CH 78 Transmission Time



Note:

The dwell times of the packet type of DH1, DH3, and DH5 are tested. Only the worst case is shown on the report.

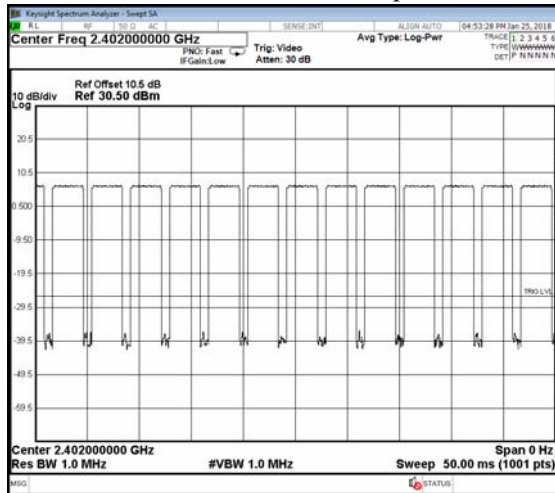
Product : FLIC HUB  
 Test Item : Dwell Time  
 Test Site : No.3 OATS  
 Test Mode : Mode 2: Transmit - 3Mbps (8DPSK) (Channel 00,39,78 –DH5)

Frequency (MHz)	Time slot length (ms)	Hopping of Number	Sweep time (ms)	Duty cycle	Dwell Time (Sec)	Limit (Sec)	Result
2402	2.887	13	50	0.75	0.300	0.4	Pass
2441	2.888	13	50	0.75	0.300	0.4	Pass
2480	2.887	13	50	0.75	0.300	0.4	Pass

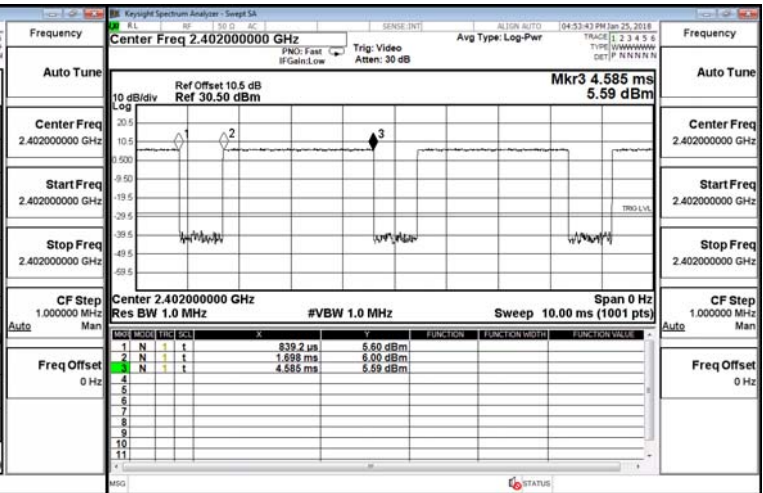
Duty cycle = ((Time slot length(ms)\*Hopping of Number) / Sweep time (ms))

Dwell time = (Duty cycle / 79) \* (79\*0.4)

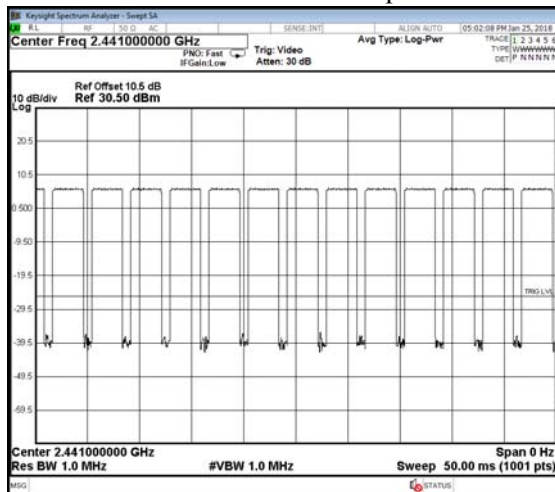
CH 00 Time Interval between hops



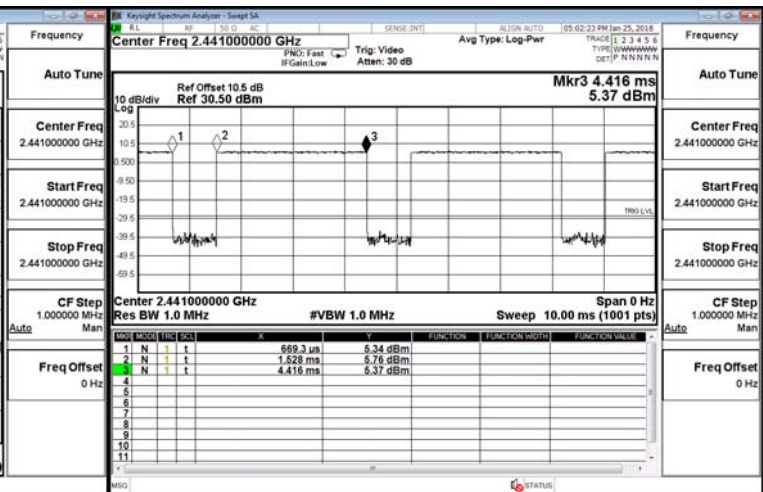
CH 00 Transmission Time



CH39 Time Interval between hops



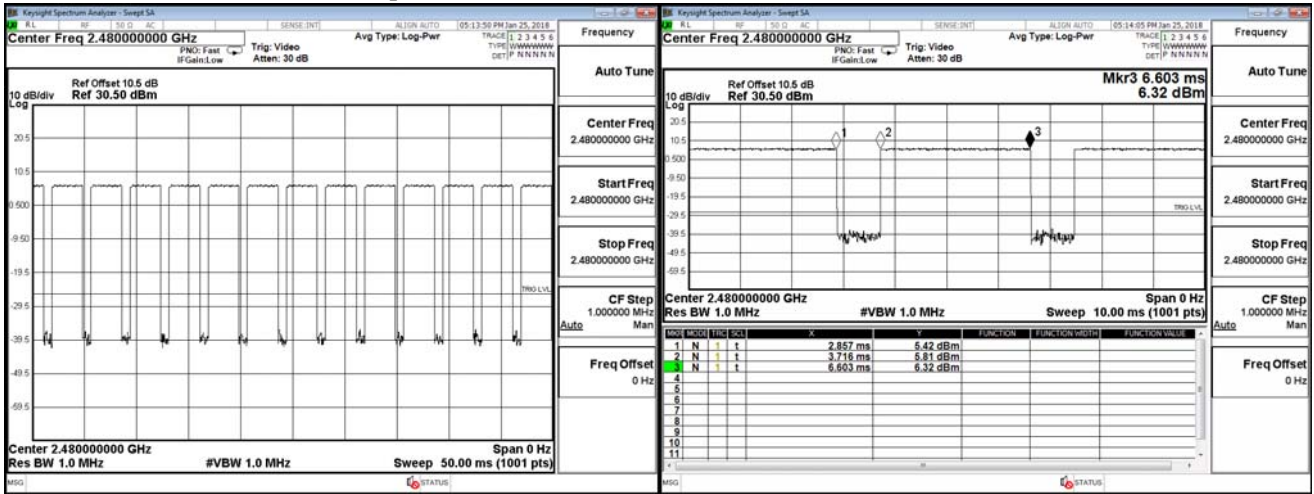
CH 39 Transmission Time





CH 78 Time Interval between hops

CH 78 Transmission Time

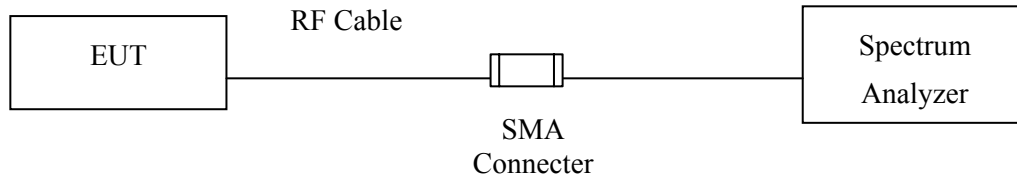


Note:

The dwell times of the packet type of DH1, DH3, and DH5 are tested. Only the worst case is shown on the report.

## 10. Occupied Bandwidth

### 10.1. Test Setup



### 10.2. Limits

N/A

### 10.3. Test Procedure

The EUT was setup to ANSI C63.4, 2014; tested to FHSS test procedure of FCC Public Notice DA 00-705 for compliance to FCC 47CFR 15.247 requirements.

### 10.4. Uncertainty

$\pm 283\text{Hz}$

### 10.5. Test Result of Occupied Bandwidth

Product : FLIC HUB  
 Test Item : Occupied Bandwidth Data  
 Test Site : No.3 OATS  
 Test Mode : Mode 1: Transmit - 1Mbps (GFSK)

Channel No.	Frequency (MHz)	Measurement Level (kHz)	Required Limit (kHz)	Result
00	2402	957	--	NA
39	2441	957	--	NA
78	2480	957	--	NA

Figure Channel 00:

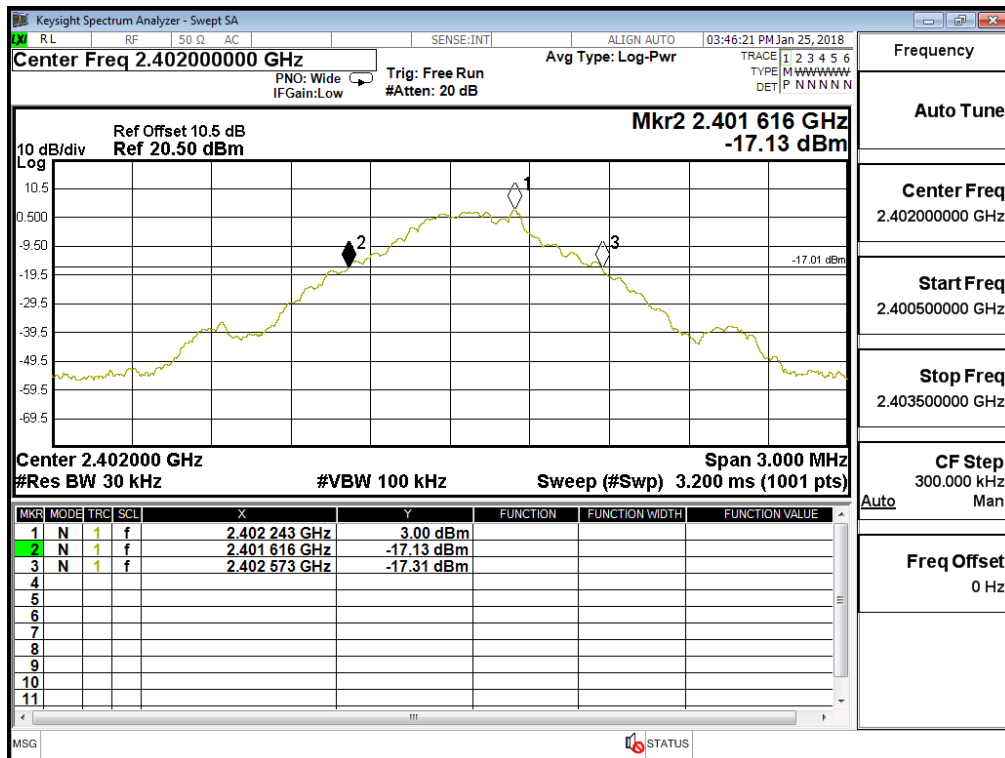


Figure Channel 39:

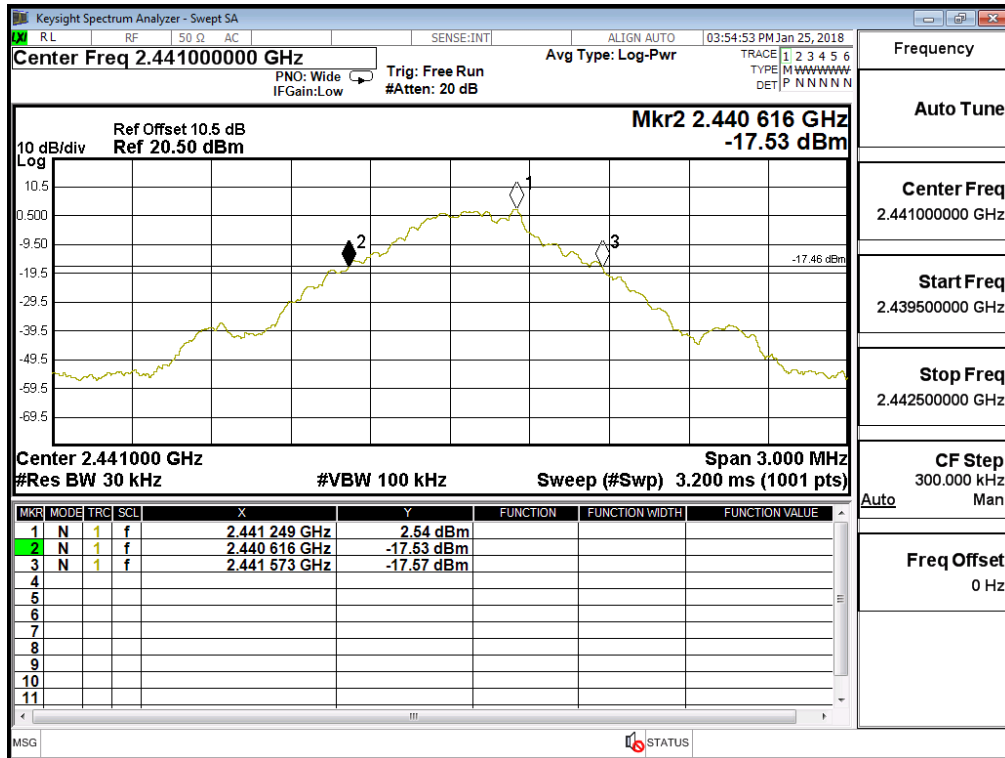
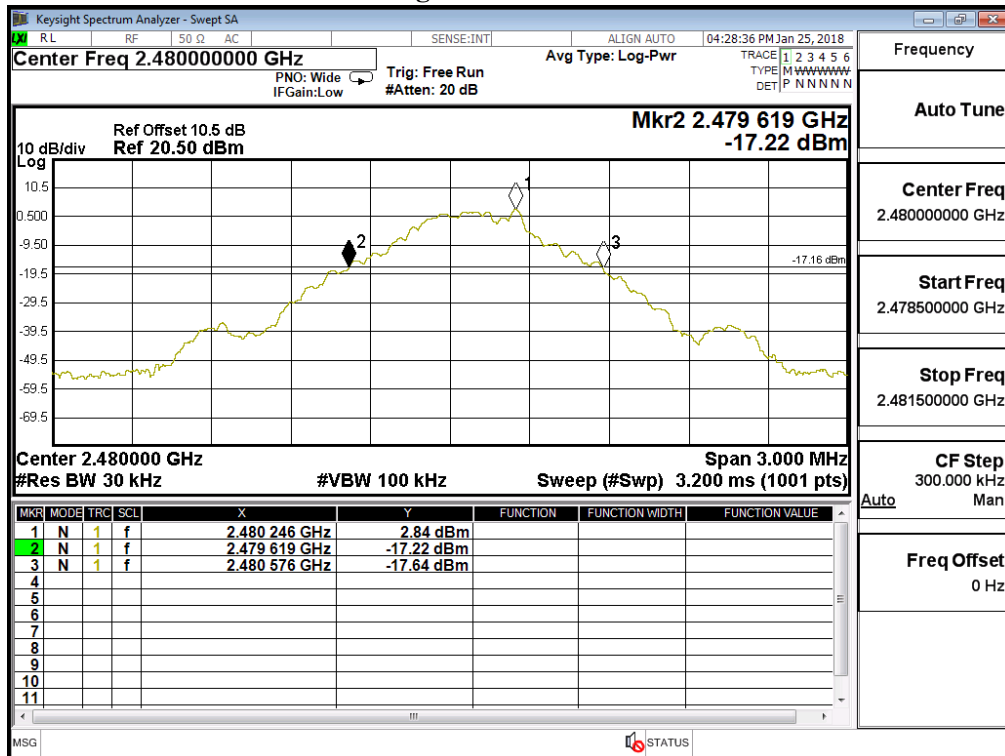


Figure Channel 78:



Product : FLIC HUB  
 Test Item : Occupied Bandwidth Data  
 Test Site : No.3 OATS  
 Test Mode : Mode 2: Transmit - 3Mbps (8DPSK) (2402MHz)

Channel No.	Frequency (MHz)	Measurement Level (kHz)	Required Limit (kHz)	Result
00	2402	1302	--	NA
39	2441	1305	--	NA
78	2480	1302	--	NA

Figure Channel 00:

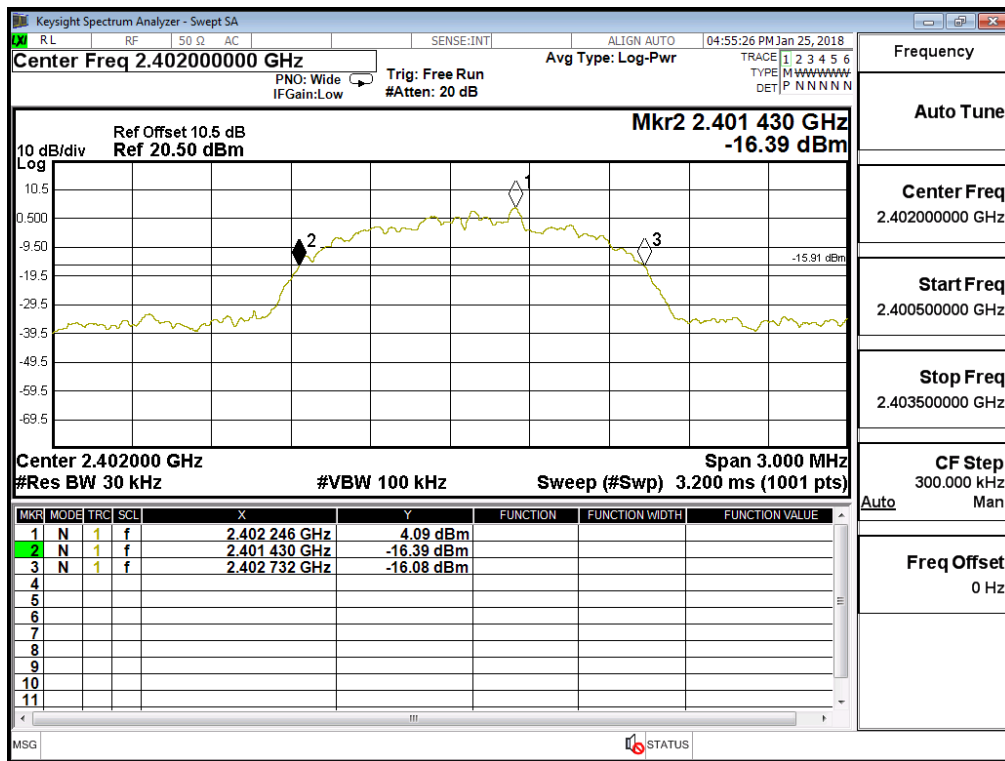


Figure Channel 39:

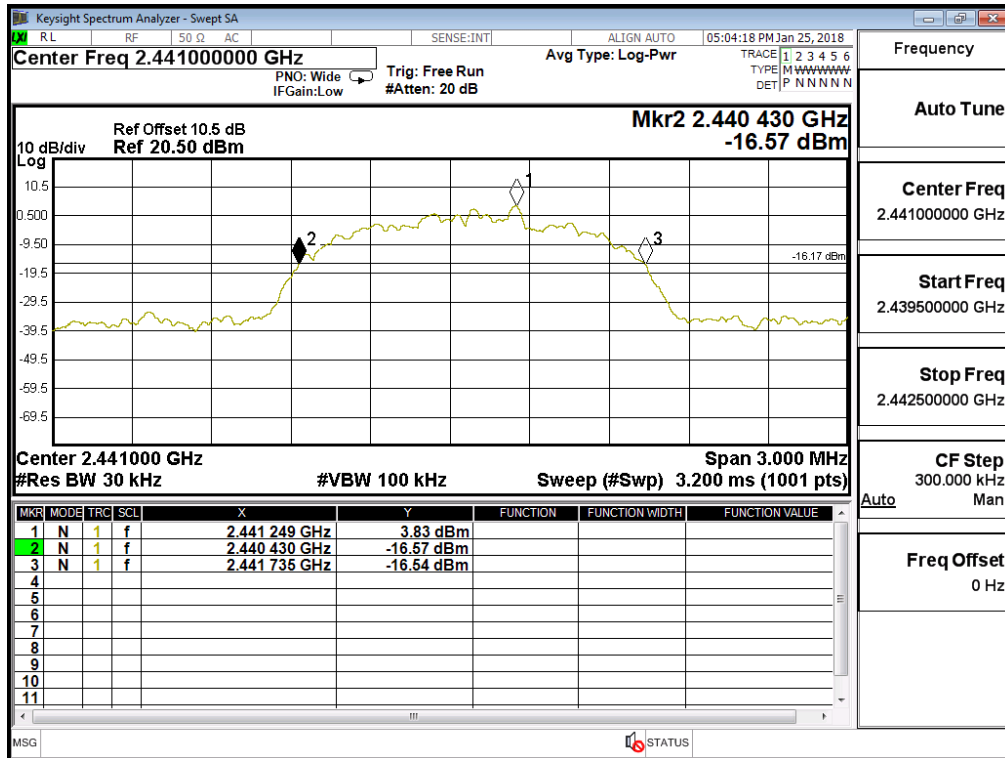
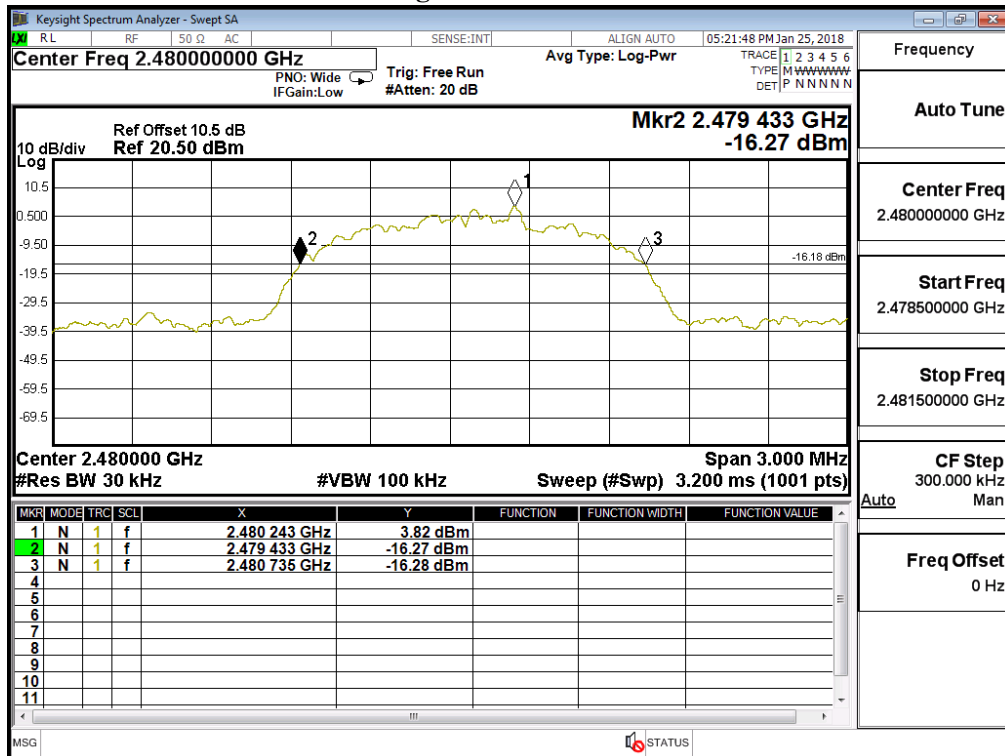


Figure Channel 78:



## **11. EMI Reduction Method During Compliance Testing**

No modification was made during testing.