

**S****T****S****L****A****B**

---

## FCC TEST REPORT

---

Report No: STS1412057F03

Issued for

MOVILTELCO TRADE, S.L.

Street: ABTAO, 25-1 Floor A-office MADRID, Spain

Product Name:	Smart Phone
Brand Name:	MTT
Model No.:	A2
Series Model:	A02,A05,A06,A08
FCC ID:	2ACQKTELCO006
Test Standard:	FCC Part 15.247

Any reproduction of this document must be done in full. No single part of this document may be reproduced without permission from STS, All Test Data Presented in this report is only applicable to presented Test sample.

Shenzhen STS Test Services Co., Ltd.

1/F, Building B, Zhuoke Science Park, Chongqing Road, Fuyong, Baoan District, Shenzhen, China

TEL: +86-755 3688 6288 FAX: +86-755 3688 6277 E-mail: sts@stsapp.com





### TEST RESULT CERTIFICATION

**Applicant's name**.....: MOVILTELCO TRADE, S.L.  
**Address** .....: Street: ABTAO, 25-1 Floor A-office MADRID, Spain  
**Manufacture's Name** .....: OTOT Group  
**Address** .....: The third Industrial Zone, Jiuwei, Yusheng Industrial Park, Xixiang, Baoan District, Shenzhen City, China

**Product description**

**Product name** .....: Smart Phone  
**Model and/or type reference** ..: MTT  
**Serial Model** .....: A2

**Standards** .....: FCC Part15.247

**Test procedure**.....: ANSI C63.10-2009

This device described above has been tested by STS, and the test results show that the equipment under test (EUT) is in compliance with the FCC requirements. And it is applicable only to the tested sample identified in the report.

This report shall not be reproduced except in full, without the written approval of STS, this document may be altered or revised by STS, personal only, and shall be noted in the revision of the document.

**Date of Test**.....:   
**Date (s) of performance of tests** .....: 22 Dec. 2014 ~29 Dec. 2014  
**Date of Issue**.....: 30 Dec. 2014  
**Test Result** .....: **Pass**

Testing Engineer :   
 \_\_\_\_\_  
 (Tony Liu)

Technical Manager :   
 \_\_\_\_\_  
 (Vita Li)

Authorized Signatory :   
 \_\_\_\_\_  
 (Bovey Yang)





<b>Table of Contents</b>	<b>Page</b>
<b>1. SUMMARY OF TEST RESULTS</b>	<b>5</b>
1.1 TEST FACILITY	5
1.2 MEASUREMENT UNCERTAINTY	5
<b>2. GENERAL INFORMATION</b>	<b>6</b>
2.1 GENERAL DESCRIPTION OF EUT	6
2.2 DESCRIPTION OF TEST MODES	8
2.3 BLOCK DIGRAM SHOWING THE CONFIGURATION OF SYSTEM TEST	9
2.4 DESCRIPTION OF SUPPORT UNITS	9
2.5 EQUIPMENTS LIST FOR ALL TEST ITEMS	10
<b>3. EMC EMISSION TEST</b>	<b>11</b>
3.1 CONDUCTED EMISSION MEASUREMENT	11
3.1.1 POWER LINE CONDUCTED EMISSION LIMITS	11
3.1.2 TEST RESULTS	12
3.2 RADIATED EMISSION MEASUREMENT	14
3.2.1 RADIATED EMISSION LIMITS	14
3.2.2 TEST PROCEDURE	15
3.2.3 TEST SETUP	16
3.2.4 EUT OPERATING CONDITIONS	17
3.2.5 TEST RESULT	18
3.2.6 TEST RESULTS (BAND EDGE)	33
<b>4. CONDUCTED SPURIOUS EMISSIONS</b>	<b>41</b>
4.1 APPLIED PROCEDURES / LIMIT	41
4.2 TEST PROCEDURE	41
4.3 DEVIATION FROM STANDARD	41
4.4 TEST SETUP	41
4.5 EUT OPERATION CONDITIONS	41
4.6 TEST RESULTS	42
<b>5. POWER SPECTRAL DENSITY TEST</b>	<b>54</b>
5.1 APPLIED PROCEDURES / LIMIT	54
5.2 TEST PROCEDURE	54
5.3 DEVIATION FROM STANDARD	54
5.4 TEST SETUP	54
5.5 EUT OPERATION CONDITIONS	54
5.6 TEST RESULTS	55



<b>Table of Contents</b>	<b>Page</b>
<b>6. BANDWIDTH TEST</b>	<b>63</b>
6.1 APPLIED PROCEDURES / LIMIT	63
6.2 TEST PROCEDURE	63
6.3 DEVIATION FROM STANDARD	63
6.4 TEST SETUP	63
6.5 EUT OPERATION CONDITIONS	63
6.6 TEST RESULTS	64
<b>7. PEAK OUTPUT POWER TEST</b>	<b>72</b>
7.1 APPLIED PROCEDURES / LIMIT	72
7.2 TEST PROCEDURE	72
7.3 DEVIATION FROM STANDARD	72
7.4 TEST SETUP	72
7.4 EUT OPERATION CONDITIONS	72
7.5 TEST RESULTS	73
<b>8. ANTENNA REQUIREMENT</b>	<b>74</b>
8.1 STANDARD REQUIREMENT	74
8.2 EUT ANTENNA	74
<b>APPENDIX - PHOTOS OF TEST SETUP</b>	<b>75</b>



## 1. SUMMARY OF TEST RESULTS

Test procedures according to the technical standards:

FCC Part15 (15.247) , Subpart C			
Standard Section	Test Item	Judgment	Remark
15.207	Conducted Emission	PASS	
15.247 (a)(2)	6dB Bandwidth	PASS	
15.247 (b) (reference KDB 558074 d05 v02. /9.1.2)	Peak Output Power	PASS	
15.247 (c)	Radiated Spurious Emission	PASS	
15.247 (d)	Conducted Spurious Emission	PASS	
15.247 (e)	Power Spectral Density	PASS	
15.205	Band Edge Emission	PASS	
15.203	Antenna Requirement	PASS	

NOTE:

(1) "N/A" denotes test is not applicable in this Test Report

### 1.1 TEST FACILITY

Shenzhen STS Test Services Co., Ltd.

Add. : 1/F, Building 2, Zhuoke Science Park, Chongqing Road, Fuyong, Baoan District, Shenzhen, China.

FCC Registration No.: 842334; IC Registration No.: 12108A-1

### 1.2 MEASUREMENT UNCERTAINTY

The reported uncertainty of measurement  $y \pm U$ , where expanded uncertainty  $U$  is based on a standard uncertainty multiplied by a coverage factor of  $k=2$ , providing a level of confidence of approximately **95 %**.

No.	Item	Uncertainty
1	Conducted Emission Test	$\pm 1.38\text{dB}$
2	RF power,conducted	$\pm 0.16\text{dB}$
3	Spurious emissions,conducted	$\pm 0.21\text{dB}$
4	All emissions,radiated(<1G)	$\pm 4.68\text{dB}$
5	All emissions,radiated(>1G)	$\pm 4.89\text{dB}$
6	Temperature	$\pm 0.5^{\circ}\text{C}$
7	Humidity	$\pm 2\%$



2. GENERAL INFORMATION

2.1 GENERAL DESCRIPTION OF EUT

Equipment	Smart Phone	
Trade Name	MTT	
Model Name	A2	
Serial Model	A02,A05,A06,A08	
Model Difference	Only different in model name	
Product Description	The EUT is a Smart Phone	
	Operation Frequency:	802.11b/g/n 20: 2412~2462 MHz 802.11n 40: 2422~2452MHz
	Modulation Type:	CCK/OFDM/DBPSK/DAPSK
	Bit Rate of Transmitter	802.11b:11/5.5/2/1 Mbps 802.11g:54/48/36/24/18/12/9/6Mbps 802.11n(20/40MHz):300/150/144.44/130/117/115.56/104/86.67/78/52/6.5Mbps
	Number Of Channel	802.11b/g/n20: 11CH 802.11n 40: 7CH
	Antenna Designation:	Please see Note 3.
	Antenna Gain (dBi)	0 dbi
	Channel List	Please refer to the Note 2.
Ratings	DC 3.7V from battery	
Adapter	Power supply and ADP ( rating ) : Input:110-240V AC,50/60Hz 0.15A Output:5.0V,500mA	
Battery	Rated Voltage: 3.7V Charge Limit: 4.2V capacity :1700mAh	
Hardware version number	M801_MB_V1.1	
Software versioning number	M801KK_mtt_T2_1G_V1.0_20141217	
Connecting I/O Port(s)	Please refer to the User's Manual	

Note:

1. For a more detailed features description, please refer to the manufacturer's specifications or the User's Manual.

2.

Channel	Frequency (MHz)	Channel	Frequency (MHz)	Channel	Frequency (MHz)	Channel	Frequency (MHz)
01	2412	04	2427	07	2442	10	2457
02	2417	05	2432	08	2447	11	2462
03	2422	06	2437	09	2452		



Channel List for 802.11n(40MHz)							
Channel	Frequency (MHz)	Channel	Frequency (MHz)	Channel	Frequency (MHz)	Channel	Frequency (MHz)
03	2422	06	2437	09	2452		
04	2427	07	2442				
05	2432	08	2447				

## 3. Table for Filed Antenna

Ant	Brand	Model Name	Antenna Type	Connector	Gain (dBi)	NOTE
A	N/A	N/A	PIFA Antenna	N/A	0	N/A





## 2.2 DESCRIPTION OF TEST MODES

To investigate the maximum EMI emission characteristics generated from EUT, the test system was pre-scanning tested based on the consideration of following EUT operation mode or test configuration mode which possibly have effect on EMI emission level. Each of these EUT operation mode(s) or test configuration mode(s) mentioned above was evaluated respectively.

Pretest Mode	Description
Mode 1	802.11b CH1/ CH6/ CH11
Mode 2	802.11g CH1/ CH6/ CH11
Mode 3	802.11n(20)CH1/ CH6/ CH11
Mode 4	802.11n(40) CH3/ CH6/ CH9
Mode 5	Link Mode

For Conducted Emission	
Final Test Mode	Description
Mode 5	Link Mode

For Radiated Emission	
Final Test Mode	Description
Mode 1	802.11b CH1/ CH6/ CH11
Mode 2	802.11g CH1/ CH6/ CH11
Mode 3	802.11n CH1/ CH6/ CH11
Mode 4	802.11n(40) CH3/ CH6/ CH9
Mode 5	Link Mode

Note:

- (1) The measurements are performed at the highest, middle, lowest available channels.
- (2) The measurements are performed at all Bit Rate of Transmitter, the worst data was reported



### 2.3 BLOCK DIGRAM SHOWING THE CONFIGURATION OF SYSTEM TEST

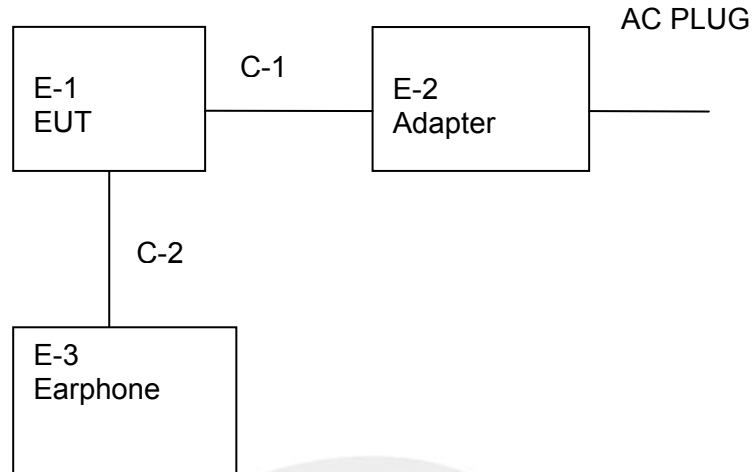

### 2.4 DESCRIPTION OF SUPPORT UNITS

The EUT has been tested as an independent unit together with other necessary accessories or support units. The following support units or accessories were used to form a representative test configuration during the tests.

Item	Equipment	Mfr/Brand	Model/Type No.	Series No.	Note
E-1	Smart Phone	MTT	A2	N/A	EUT
E-2	Adapter	mtt	A2	N/A	
E-3	Earphone	N/A	N/A	N/A	

Item	Shielded Type	Ferrite Core	Length	Note
C-1	NO	YES	1.5m	
C-2	NO	NO	1.2m	

Note:

- (1) The support equipment was authorized by Declaration of Confirmation.
- (2) For detachable type I/O cable should be specified the length in cm in 『Length』 column.



## 2.5 EQUIPMENTS LIST FOR ALL TEST ITEMS

## Radiation Test equipment

Kind of Equipment	Manufacturer	Type No.	Serial No.	Last calibration	Calibrated until
Spectrum Analyzer	Agilent	E4407B	MY50140340	2014.10.25	2015.10.24
Test Receiver	R&S	ESCI	101427	2014.10.25	2015.10.24
Bilog Antenna	TESEQ	CBL6111D	34678	2014.10.27	2015.10.26
Horn Antenna	R&S	9120D	152265	2014.10.27	2015.10.26
Horn Ant	Schwarzbeck	BBHA 9170	9170-181	2014.07.06	2015.07.05
Amplifier	Agilent	8449B	60538	2014.10.25	2015.10.24
Loop Antenna	ARA	PLA-1030/B	1029	2014.06.08	2015.06.07
Power Meter	Anritsu	ML2495A	1204003	2014.10.25	2015.10.24
Power Sensor	Anritsu	MA2411B	100309	2014.10.25	2015.10.24
Low frequency cable	N/A	R01	N/A	2014.10.25	2015.10.24
High frequency cable	N/A	R02	N/A	2014.10.25	2015.10.24

## Conduction Test equipment

Kind of Equipment	Manufacturer	Type No.	Serial No.	Last calibration	Calibrated until
Test Receiver	R&S	ESCI	102086	2014.10.25	2015.10.24
LISN	R&S	ENV216	101242	2014.10.25	2015.10.24
LISN	EMCO	3810/2NM	000-23625	2014.10.25	2015.10.24
Conduction Cable	HUBER+SU HNER	C01	N/A	2014.10.25	2015.10.24



### 3. EMC EMISSION TEST

#### 3.1 CONDUCTED EMISSION MEASUREMENT

##### 3.1.1 POWER LINE CONDUCTED EMISSION LIMITS

Operating frequency band. In case the emission fall within the restricted band specified on Part 15.247&207(a) limit in the table below has to be followed.

FREQUENCY (MHz)	Class B (dBuV)		Standard
	Quasi-peak	Average	
0.15 -0.5	66 - 56 *	56 - 46 *	CISPR
0.50 -5.0	56.00	46.00	CISPR
5.0 -30.0	60.00	50.00	CISPR

0.15 -0.5	66 - 56 *	56 - 46 *	FCC
0.50 -5.0	56.00	46.00	FCC
5.0 -30.0	60.00	50.00	FCC

Note:

- (1) The tighter limit applies at the band edges.
- (2) The limit of " \* " marked band means the limitation decreases linearly with the logarithm of the frequency in the range.

The following table is the setting of the receiver



3.1.2 TEST RESULTS

EUT :	mobile phone	Model Name. :	A2
Temperature :	23 °C	Relative Humidity :	50%
Pressure :	1010hPa	Phase :	L
Test Voltage :	DC 5V from Adapter AC 120V/60Hz	Test Mode :	Link Mode

Frequency (MHz)	Reading (dBuV)	Correct Factor(dB)	Result (dBuV)	Limit (dBuV)	Margin (dB)	Remark
0.1833	44.13	10.44	54.57	64.33	-9.76	QP
0.1833	33.59	10.44	44.03	54.33	-10.30	AVG
0.2220	36.65	10.44	47.09	62.74	-15.65	QP
0.2220	24.01	10.44	34.45	52.74	-18.29	AVG
0.3700	38.59	10.42	49.01	58.50	-9.49	QP
0.3700	27.80	10.42	38.22	48.50	-10.28	AVG
0.4460	32.17	10.41	42.58	56.95	-14.37	QP
0.4460	21.42	10.41	31.83	46.95	-15.12	AVG
0.5940	35.29	10.40	45.69	56.00	-10.31	QP
0.5940	24.22	10.40	34.62	46.00	-11.38	AVG
2.0660	30.80	10.42	41.22	56.00	-14.78	QP
2.0660	18.42	10.42	28.84	46.00	-17.16	AVG

Remark:

1. All readings are Quasi-Peak and Average values.
2. Factor = Insertion Loss + Cable Loss.

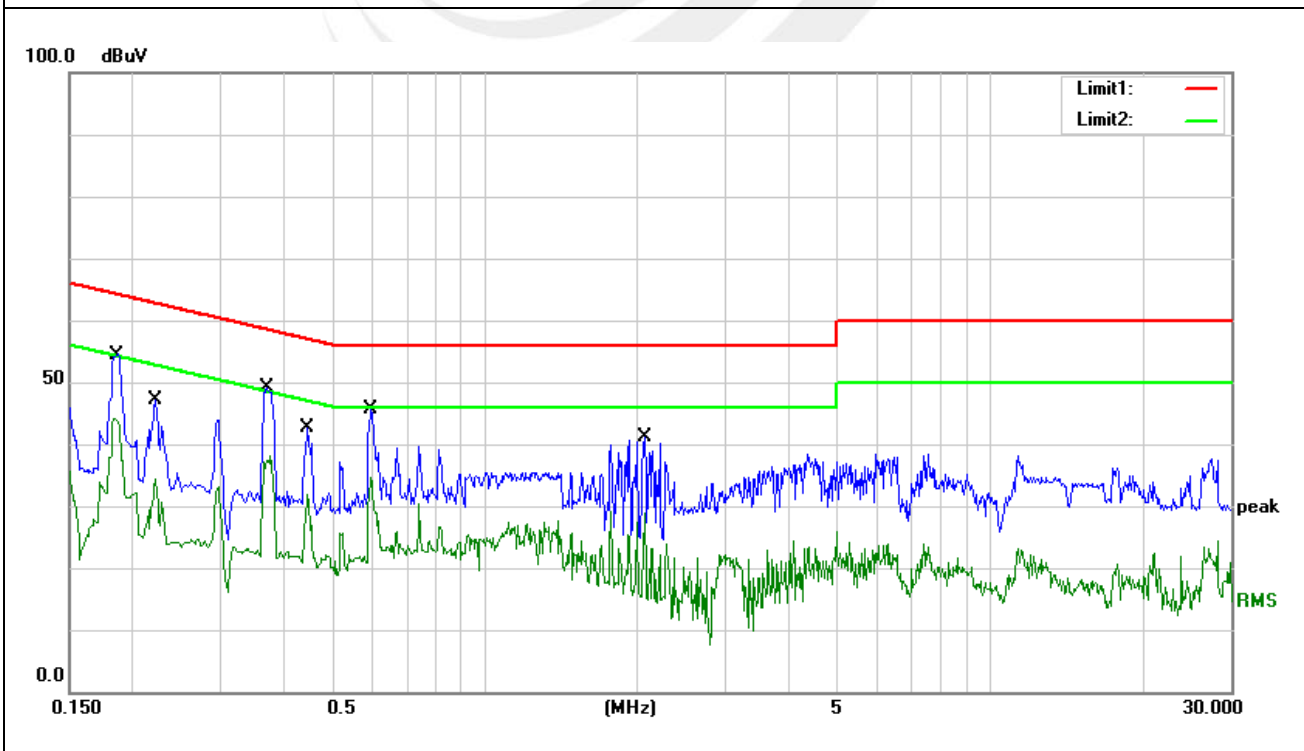



EUT :	mobile phone	Model Name. :	G5006
Temperature :	23 °C	Relative Humidity :	50%
Pressure :	1010hPa	Phase :	N
Test Voltage :	DC 5V from Adapter AC 120V/60Hz	Test Mode :	Link Mode

Frequency (MHz)	Reading (dBuV)	Correct Factor(dB)	Result (dBuV)	Limit (dBuV)	Margin (dB)	Remark
0.1711	37.07	10.35	47.42	64.91	-17.49	QP
0.1711	28.66	10.35	39.01	54.91	-15.90	AVG
0.2268	38.82	10.43	49.25	62.57	-13.32	QP
0.2268	28.52	10.43	38.95	52.57	-13.62	AVG
0.3340	35.03	10.42	45.45	59.35	-13.90	QP
0.3340	26.24	10.42	36.66	49.35	-12.69	AVG
0.5220	34.30	10.41	44.71	56.00	-11.29	QP
0.5220	28.00	10.41	38.41	46.00	-7.59	AVG
1.0380	31.56	10.45	42.01	56.00	-13.99	QP
1.0380	20.67	10.45	31.12	46.00	-14.88	AVG
4.3580	31.17	10.66	41.83	56.00	-14.17	QP
4.3580	15.50	10.66	26.16	46.00	-19.84	AVG

Remark:

1. All readings are Quasi-Peak and Average values.
2. Factor = Insertion Loss + Cable Loss.

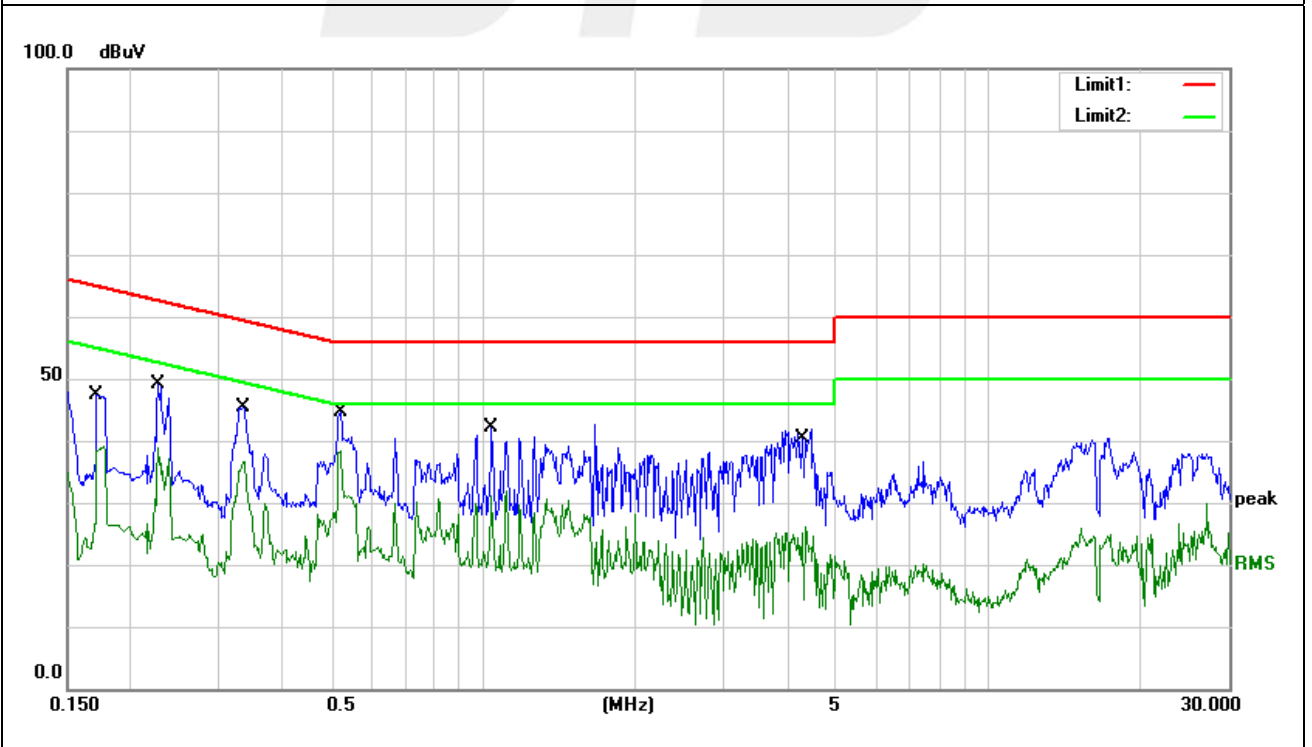



3.2 RADIATED EMISSION MEASUREMENT

3.2.1 RADIATED EMISSION LIMITS

6 dBc in any 100 kHz bandwidth outside the operating frequency band. In case the emission fall within the restricted band specified on Part 15.247&205(a), then the Part 15.247&209(a) limit in the table below has to be followed.

Frequencies (MHz)	Field Strength (micovolts/meter)	Measurement Distance (meters)
0.009~0.490	2400/F(KHz)	300
0.490~1.705	24000/F(KHz)	30
1.705~30.0	30	30
30~88	100	3
88~216	150	3
216~960	200	3
Above 960	500	3

LIMITS OF RADIATED EMISSION MEASUREMENT (Above 1000MHz)

FREQUENCY (MHz)	Class B (dBuV/m) (at 3M)	
	PEAK	AVERAGE
Above 1000	74	54

Notes:

- (1) The limit for radiated test was performed according to FCC PART 15C.
- (2) The tighter limit applies at the band edges.
- (3) Emission level (dBuV/m)=20log Emission level (uV/m).

FREQUENCY RANGE OF RADIATED MEASUREMENT (For unintentional radiators)

Highest frequency generated or Upper frequency of measurement used in the device or on which the device operates or tunes (MHz)	Range (MHz)
Below 1.705	30
1.705 – 108	1000
108 – 500	2000
500 – 1000	5000
Above 1000	5 <sup>th</sup> harmonic of the highest frequency or 40 GHz, whichever is lower



Spectrum Parameter	Setting
Attenuation	Auto
Detector	Peak
Start Frequency	1000 MHz(Peak/AV)
Stop Frequency	10th carrier harmonic(Peak/AV)
RB / VB (emission in restricted band)	1 MHz / 1 MHz, AV=1 MHz / 10Hz

Receiver Parameter	Setting
Attenuation	Auto
Start ~ Stop Frequency	9kHz~150kHz / RB 200Hz for QP
Start ~ Stop Frequency	150kHz~30MHz / RB 9kHz for QP
Start ~ Stop Frequency	30MHz~1000MHz / RB 120kHz for QP

### 3.2.2 TEST PROCEDURE

- The measuring distance of at 3 m shall be used for measurements at frequency up to 1GHz. For frequencies above 1GHz, any suitable measuring distance may be used.
- The EUT was placed on the top of a rotating table 0.8 meters above the ground at a 3 meter open area test site. The table was rotated 360 degrees to determine the position of the highest radiation.
- The height of the equipment or of the substitution antenna shall be 0.8 m; the height of the test antenna shall vary between 1 m to 4 m. Both horizontal and vertical polarizations of the antenna are set to make the measurement.
- The initial step in collecting conducted emission data is a spectrum analyzer peak detector mode pre-scanning the measurement frequency range. Significant peaks are then marked and then Quasi Peak detector mode re-measured.
- If the Peak Mode measured value compliance with and lower than Quasi Peak Mode Limit, the EUT shall be deemed to meet QP Limits and then no additional QP Mode measurement performed.
- For the actual test configuration, please refer to the related Item –EUT Test Photos.

Note:

Both horizontal and vertical antenna polarities were tested and performed pretest to three orthogonal axis. The worst case emissions were reported

### 3.2.3 TEST SETUP

#### (A) Radiated Emission Test-Up Frequency Below 30MHz

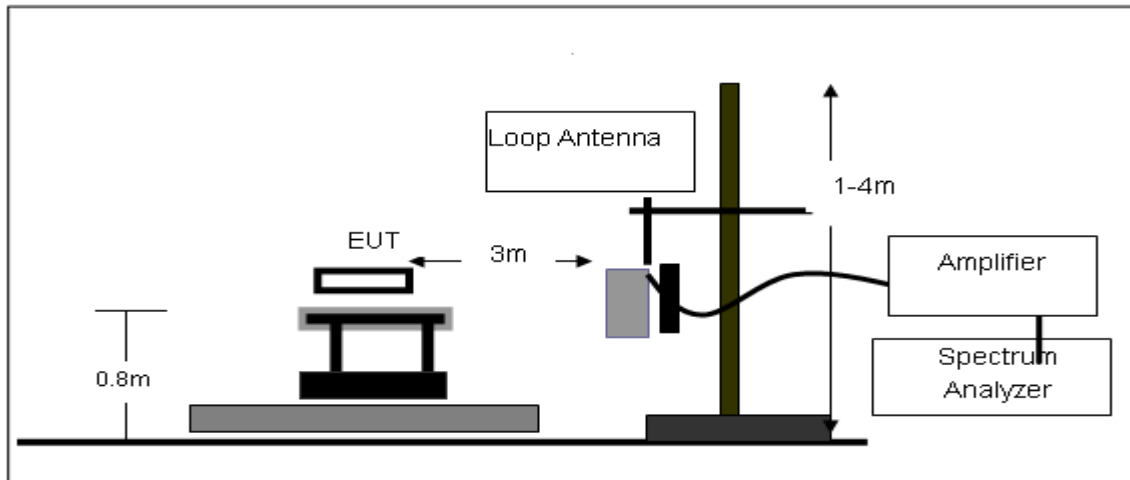

#### (B) Radiated Emission Test-Up Frequency 30MHz~1GHz

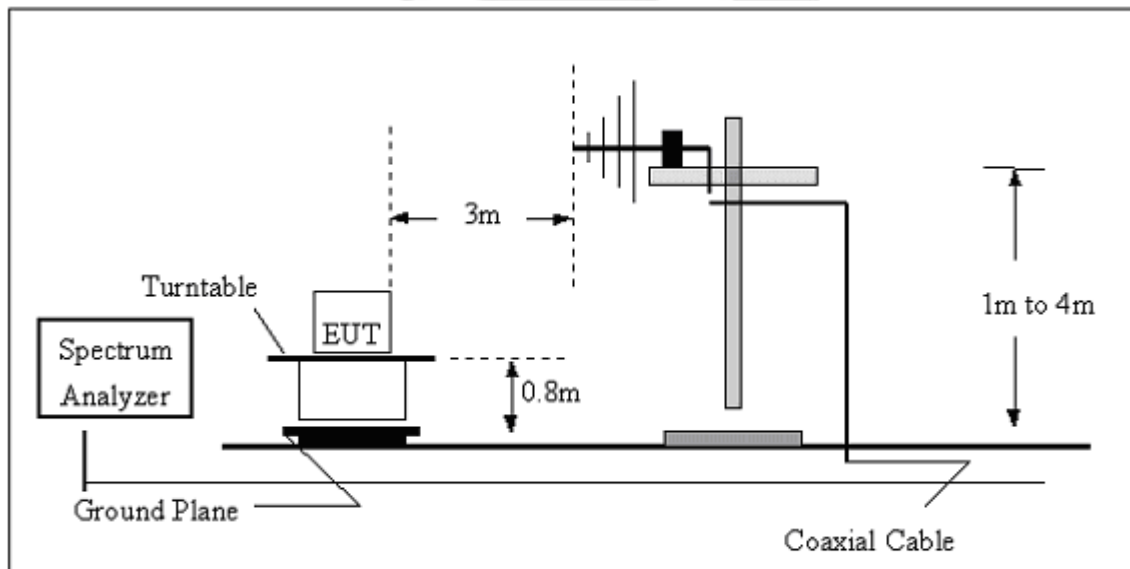



## (C) Radiated Emission Test-Up Frequency Above 1GHz

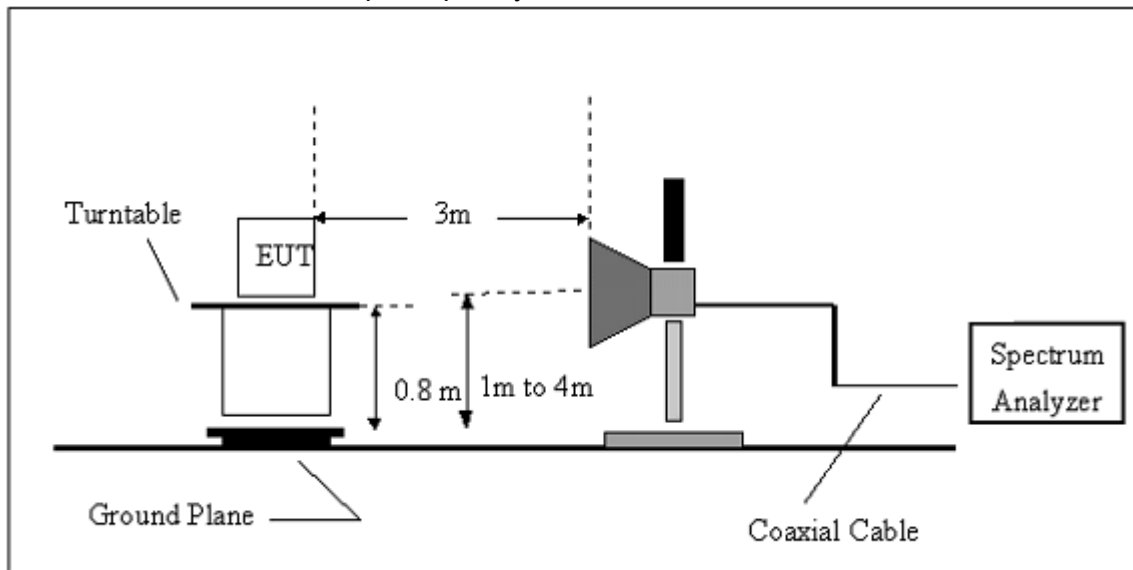

### 3.2.4 EUT OPERATING CONDITIONS

The EUT tested system was configured as the statements of 2.3 Unless otherwise a special operating condition is specified in the follows during the testing.



### 3.2.5 TEST RESULT

9KHz-30MHz

EUT:	Smart Phone	Model Name. :	A2
Temperature:	20 °C	Relative Humidity:	48%
Pressure:	1010 hPa	Test Voltage :	DC 5V from Adapter with AC 120V/60Hz
Test Mode :	Link mode	Polarization :	--

Freq. (MHz)	Reading (dBuV/m)	Limit (dBuV/m)	Margin (dB)	State P/F
--	--	--	--	PASS
--	--	--	--	PASS

**NOTE:**

The amplitude of spurious emissions which are attenuated by more than 20dB below the permissible value has no need to be reported.

Distance extrapolation factor =  $40 \log (\text{specific distance}/\text{test distance})$ (dB);

Limit line = specific limits(dBuv) + distance extrapolation factor.



30MHz - 1000MHz

EUT :	Smart Phone	Model Name :	A2
Temperature :	20 °C	Relative Humidity :	48%
Pressure :	1010 hPa	Test Voltage :	DC 5V from Adapter with AC 120V/60Hz
Test Mode :	Link mode	Polarization :	Horizontal

Frequency (MHz)	Reading (dBuV)	Correct Factor(dB/m)	Result (dBuV/m)	Limit (dBuV/m)	Margin (dB)	Remark
30.2110	4.83	18.84	23.67	40.00	-16.33	QP
61.3462	9.92	5.72	15.64	40.00	-24.36	QP
115.3204	13.70	12.47	26.17	43.50	-17.33	QP
202.1005	7.85	9.46	17.31	43.50	-26.19	QP
499.4246	4.34	20.69	25.03	46.00	-20.97	QP
689.5643	7.49	23.95	31.44	46.00	-14.56	QP

Remark:

1. Factor = Antenna Factor + Cable Loss – Pre-amplifier.

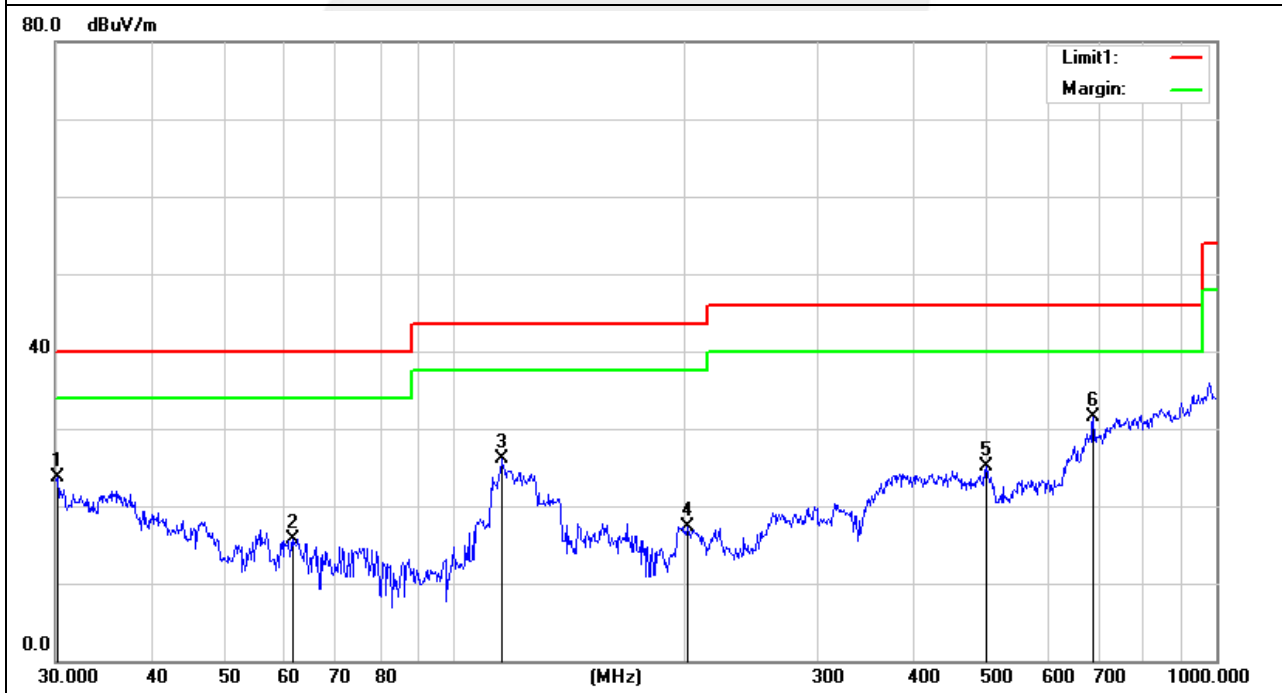



EUT :	Smart Phone	Model Name :	A2
Temperature :	20 °C	Relative Humidity :	48%
Pressure :	1010 hPa	Test Voltage :	DC 5V from Adapter with AC 120V/60Hz
Test Mode :	Link mode	Polarization :	Vertical

Frequency (MHz)	Reading (dBuV)	Correct Factor(dB/m)	Result (dBuV/m)	Limit (dBuV/m)	Margin (dB)	Remark
64.6594	18.30	5.82	24.12	40.00	-15.88	QP
77.0503	15.88	7.69	23.57	40.00	-16.43	QP
97.1148	13.97	10.52	24.49	43.50	-19.01	QP
120.6991	16.05	12.67	28.72	43.50	-14.78	QP
189.0741	11.48	9.61	21.09	43.50	-22.41	QP
375.9384	7.21	17.63	24.84	46.00	-21.16	QP

Remark:

1. Factor = Antenna Factor + Cable Loss – Pre-amplifier.

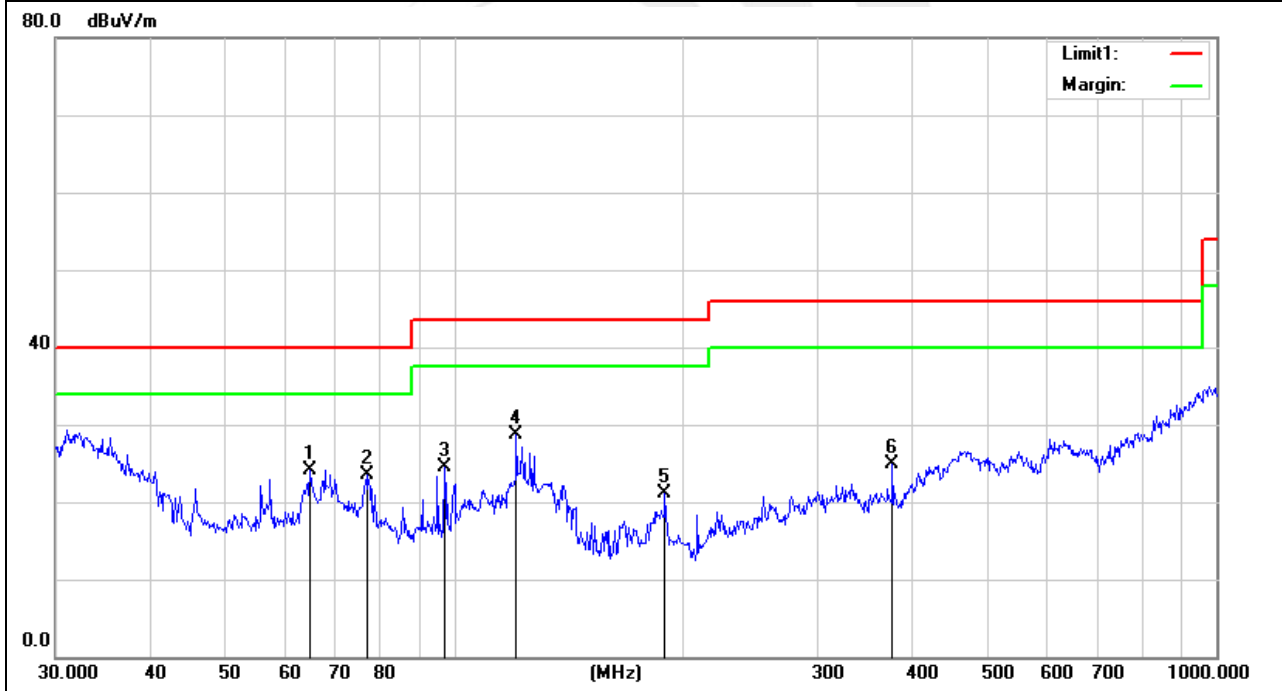



Above 1000MHz

EUT :	mobile phone	Model Name :	G5006
Temperature :	20 °C	Relative Humidity :	48%
Pressure :	1010 hPa	Test Voltage :	DC 5V from Adapter with AC 120V/60Hz
Test Mode :	CH1 (802.11b Mode)/2412	Polarization :	Vertical

Frequency (MHz)	Meter Reading (dBµV)	Factor (dB)	Emission Level (dBµV/m)	Limits (dBµV/m)	Margin (dB)	Value Type
4824.079	46.93	10.44	57.37	74	-16.63	peak
4824.079	31.36	10.44	41.8	54	-12.2	AVG
7236.079	43.28	12.39	55.67	74	-18.33	peak
7236.079	33.73	12.39	46.12	54	-7.88	AVG

Remark:

Factor = Antenna Factor + Cable Loss – Pre-amplifier.

EUT :	Smart Phone	Model Name :	A2
Temperature :	20 °C	Relative Humidity :	48%
Pressure :	1010 hPa	Test Voltage :	DC 5V from Adapter with AC 120V/60Hz
Test Mode :	CH1 (802.11b Mode)/2412	Polarization :	Horizontal

Frequency (MHz)	Meter Reading (dBµV)	Factor (dB)	Emission Level (dBµV/m)	Limits (dBµV/m)	Margin (dB)	Value Type
4824.14	46.72	10.44	57.16	74	-16.84	peak
4824.14	31.56	10.44	42	54	-12	AVG
7236.12	43.24	12.39	55.63	74	-18.37	peak
7236.12	33.73	12.39	46.12	54	-7.88	AVG

Remark:

Factor = Antenna Factor + Cable Loss – Pre-amplifier.



EUT :	Smart Phone	Model Name :	A2
Temperature :	20 °C	Relative Humidity :	48%
Pressure :	1010 hPa	Test Voltage :	DC 5V from Adapter with AC 120V/60Hz
Test Mode :	CH6 (802.11b Mode)/2437	Polarization :	Horizontal

Frequency (MHz)	Meter Reading (dBµV)	Factor (dB)	Emission Level (dBµV/m)	Limits (dBµV/m)	Margin (dB)	Value Type
4874.108	45.25	10.4	55.65	74	-18.35	peak
4874.120	26.37	10.4	36.77	54	-17.23	AVG
7311.098	44.78	12.75	57.53	74	-16.47	peak
7311.099	25.86	12.75	38.61	54	-15.39	AVG

Remark:

Factor = Antenna Factor + Cable Loss – Pre-amplifier.

EUT :	Smart Phone	Model Name :	A2
Temperature :	20 °C	Relative Humidity :	48%
Pressure :	1010 hPa	Test Voltage :	DC 5V from Adapter with AC 120V/60Hz
Test Mode :	CH6 (802.11b Mode)/2437	Polarization :	Vertical

Frequency (MHz)	Meter Reading (dBµV)	Factor (dB)	Emission Level (dBµV/m)	Limits (dBµV/m)	Margin (dB)	Value Type
4874.103	45.33	10.4	55.73	74	-18.27	peak
4874.117	26.59	10.4	36.99	54	-17.01	AVG
7311.096	44.67	12.75	57.42	74	-16.58	peak
7311.103	25.92	12.75	38.67	54	-15.33	AVG

Remark:

Factor = Antenna Factor + Cable Loss – Pre-amplifier.



EUT :	Smart Phone	Model Name :	A2
Temperature :	20 °C	Relative Humidity :	48%
Pressure :	1010 hPa	Test Voltage :	DC 5V from Adapter with AC 120V/60Hz
Test Mode :	CH11 (802.11b Mode)/2462	Polarization :	Horizontal

Frequency (MHz)	Meter Reading (dBμV)	Factor (dB)	Emission Level (dBμV/m)	Limits (dBμV/m)	Margin (dB)	Value Type
4924.094	49.45	10.39	59.84	74	-14.16	peak
4924.113	33.43	10.39	43.82	54	-10.18	AVG
7386.062	48.69	12.68	61.37	74	-12.63	peak
7386.119	30.71	12.68	43.39	54	-10.61	AVG

Remark:  
Factor = Antenna Factor + Cable Loss – Pre-amplifier.

EUT :	Smart Phone	Model Name :	A2
Temperature :	20 °C	Relative Humidity :	48%
Pressure :	1010 hPa	Test Voltage :	DC 5V from Adapter with AC 120V/60Hz
Test Mode :	CH11 (802.11b Mode)/2462	Polarization :	Vertical

Frequency (MHz)	Meter Reading (dBμV)	Factor (dB)	Emission Level (dBμV/m)	Limits (dBμV/m)	Margin (dB)	Value Type
4924.105	49.48	10.39	59.87	74	-14.13	peak
4924.050	33.29	10.39	43.68	54	-10.32	AVG
7386.070	48.21	12.68	60.89	74	-13.11	peak
7386.111	30.87	12.68	43.55	54	-10.45	AVG

Remark:  
Factor = Antenna Factor + Cable Loss – Pre-amplifier.



EUT :	Smart Phone	Model Name :	A2
Temperature :	20 °C	Relative Humidity :	48%
Pressure :	1010 hPa	Test Voltage :	DC 5V from Adapter with AC 120V/60Hz
Test Mode :	CH1 (802.11g Mode)/2412	Polarization :	Horizontal

Frequency (MHz)	Meter Reading (dBµV)	Factor (dB)	Emission Level (dBµV/m)	Limits (dBµV/m)	Margin (dB)	Value Type
4824.074	46.19	10.44	56.63	74	-17.37	peak
4824.121	36.51	10.44	46.95	54	-7.05	AVG
7236.024	42.46	12.39	54.85	74	-19.15	peak
7236.034	28.21	12.39	40.6	54	-13.4	AVG

Remark:

Factor = Antenna Factor + Cable Loss – Pre-amplifier.

EUT :	Smart Phone	Model Name :	A2
Temperature :	20 °C	Relative Humidity :	48%
Pressure :	1010 hPa	Test Voltage :	DC 5V from Adapter with AC 120V/60Hz
Test Mode :	CH1 (802.11g Mode)/2412	Polarization :	Vertical

Frequency (MHz)	Meter Reading (dBµV)	Factor (dB)	Emission Level (dBµV/m)	Limits (dBµV/m)	Margin (dB)	Value Type
4824.091	46.89	10.44	57.33	74	-16.67	peak
4824.085	36.51	10.44	46.95	54	-7.05	AVG
7236.036	42.58	12.39	54.97	74	-19.03	peak
7236.110	28.27	12.39	40.66	54	-13.34	AVG

Remark:

Factor = Antenna Factor + Cable Loss – Pre-amplifier.





EUT :	Smart Phone	Model Name :	A2
Temperature :	20 °C	Relative Humidity :	48%
Pressure :	1010 hPa	Test Voltage :	DC 5V from Adapter with AC 120V/60Hz
Test Mode :	CH6 (802.11g Mode)/2437	Polarization :	Horizontal

Frequency (MHz)	Meter Reading (dB $\mu$ V)	Factor (dB)	Emission Level (dB $\mu$ V/m)	Limits (dB $\mu$ V/m)	Margin (dB)	Value Type
4874.073	45.19	10.4	55.59	74	-18.41	peak
4874.049	26.37	10.4	36.77	54	-17.23	AVG
7311.093	44.73	12.75	57.48	74	-16.52	peak
7311.091	25.78	12.75	38.53	54	-15.47	AVG

Remark:

Factor = Antenna Factor + Cable Loss – Pre-amplifier.

EUT :	Smart Phone	Model Name :	A2
Temperature :	20 °C	Relative Humidity :	48%
Pressure :	1010 hPa	Test Voltage :	DC 5V from Adapter with AC 120V/60Hz
Test Mode :	CH6 (802.11g Mode)/2437	Polarization :	Vertical

Frequency (MHz)	Meter Reading (dB $\mu$ V)	Factor (dB)	Emission Level (dB $\mu$ V/m)	Limits (dB $\mu$ V/m)	Margin (dB)	Value Type
4874.078	48.46	10.4	58.86	74	-15.14	peak
4874.061	35.21	10.4	45.61	54	-8.39	AVG
7311.066	48.27	12.75	61.02	74	-12.98	peak
7311.067	33.43	12.75	46.18	54	-7.82	AVG

Remark:

Factor = Antenna Factor + Cable Loss – Pre-amplifier.



EUT :	Smart Phone	Model Name :	A2
Temperature :	20 °C	Relative Humidity :	48%
Pressure :	1010 hPa	Test Voltage :	DC 5V from Adapter with AC 120V/60Hz
Test Mode :	CH11 (802.11g Mode)/2462	Polarization :	Horizontal

Frequency (MHz)	Meter Reading (dBµV)	Factor (dB)	Emission Level (dBµV/m)	Limits (dBµV/m)	Margin (dB)	Value Type
4924.045	49.19	10.39	59.58	74	-14.42	peak
4924.101	33.45	10.39	43.84	54	-10.16	AVG
7386.104	48.21	12.68	60.89	74	-13.11	peak
7386.067	30.88	12.68	43.56	54	-10.44	AVG

Remark:

Factor = Antenna Factor + Cable Loss – Pre-amplifier.

EUT :	Smart Phone	Model Name :	A2
Temperature :	20 °C	Relative Humidity :	48%
Pressure :	1010 hPa	Test Voltage :	DC 5V from Adapter with AC 120V/60Hz
Test Mode :	CH11(802.11g Mode)/2462	Polarization :	Vertical

Frequency (MHz)	Meter Reading (dBµV)	Factor (dB)	Emission Level (dBµV/m)	Limits (dBµV/m)	Margin (dB)	Value Type
4924.138	46.78	10.39	57.17	74	-16.83	peak
4924.140	34.52	10.39	44.91	54	-9.09	AVG
7386.102	46.49	12.68	59.17	74	-14.83	peak
7386.119	33.91	12.68	46.59	54	-7.41	AVG

Remark:

Factor = Antenna Factor + Cable Loss – Pre-amplifier.



EUT :	Smart Phone	Model Name :	A2
Temperature :	20 °C	Relative Humidity :	48%
Pressure :	1010 hPa	Test Voltage :	DC 5V from Adapter with AC 120V/60Hz
Test Mode :	CH1(802.11n Mode)/20MHz	Polarization :	Horizontal

Frequency (MHz)	Meter Reading (dBµV)	Factor (dB)	Emission Level (dBµV/m)	Limits (dBµV/m)	Margin (dB)	Value Type
4824.117	46.21	10.44	56.65	74	-17.35	peak
4824.113	36.51	10.44	46.95	54	-7.05	AVG
7236.107	42.35	12.39	54.74	74	-19.26	peak
7236.022	28.21	12.39	40.6	54	-13.4	AVG

Remark:  
Factor = Antenna Factor + Cable Loss – Pre-amplifier.

EUT :	Smart Phone	Model Name :	A2
Temperature :	20 °C	Relative Humidity :	48%
Pressure :	1010 hPa	Test Voltage :	DC 5V from Adapter with AC 120V/60Hz
Test Mode :	CH1(802.11n Mode)/20MHz	Polarization :	Vertical

Frequency (MHz)	Meter Reading (dBµV)	Factor (dB)	Emission Level (dBµV/m)	Limits (dBµV/m)	Margin (dB)	Value Type
4824.098	46.74	10.44	57.18	74	-16.82	peak
4824.120	37.23	10.44	47.67	54	-6.33	AVG
7236.062	51.48	12.39	63.87	74	-10.13	peak
7236.129	31.12	12.39	43.51	54	-10.49	AVG

Remark:  
Factor = Antenna Factor + Cable Loss – Pre-amplifier.



EUT :	Smart Phone	Model Name :	A2
Temperature :	20 °C	Relative Humidity :	48%
Pressure :	1010 hPa	Test Voltage :	DC 5V from Adapter with AC 120V/60Hz
Test Mode :	CH6(802.11n Mode)/20MHz	Polarization :	Horizontal

Frequency (MHz)	Meter Reading (dBµV)	Factor (dB)	Emission Level (dBµV/m)	Limits (dBµV/m)	Margin (dB)	Value Type
4874.077	51.59	10.4	61.99	74	-12.01	peak
4874.104	32.36	10.4	42.76	54	-11.24	AVG
7311.029	48.54	12.75	61.29	74	-12.71	peak
7311.071	27.33	12.75	40.08	54	-13.92	AVG

Remark:

Factor = Antenna Factor + Cable Loss – Pre-amplifier.

EUT :	Smart Phone	Model Name :	A2
Temperature :	20 °C	Relative Humidity :	48%
Pressure :	1010 hPa	Test Voltage :	DC 5V from Adapter with AC 120V/60Hz
Test Mode :	CH6(802.11n Mode)/20MHz	Polarization :	Vertical

Frequency (MHz)	Meter Reading (dBµV)	Factor (dB)	Emission Level (dBµV/m)	Limits (dBµV/m)	Margin (dB)	Value Type
4874.101	48.44	10.4	58.84	74	-15.16	peak
4874.122	32.59	10.4	42.99	54	-11.01	AVG
7311.136	47.46	12.75	60.21	74	-13.79	peak
7311.133	26.62	12.75	39.37	54	-14.63	AVG

Remark:

Factor = Antenna Factor + Cable Loss – Pre-amplifier.



EUT :	Smart Phone	Model Name :	A2
Temperature :	20 °C	Relative Humidity :	48%
Pressure :	1010 hPa	Test Voltage :	DC 5V from Adapter with AC 120V/60Hz
Test Mode :	CH11(802.11n Mode)/20MHz	Polarization :	Horizontal

Frequency (MHz)	Meter (dBµV)	Factor (dB)	Emission (dBµV/m)	Limits (dBµV/m)	Margin (dB)	Value Type
4924.105	50.89	10.39	61.28	74	-12.72	peak
4924.089	35.15	10.39	45.54	54	-8.46	AVG
7386.105	43.83	12.68	56.51	74	-17.49	peak
7386.148	31.32	12.68	44	54	-10	AVG

Remark:

Factor = Antenna Factor + Cable Loss – Pre-amplifier.

EUT :	Smart Phone	Model Name :	A2
Temperature :	20 °C	Relative Humidity :	48%
Pressure :	1010 hPa	Test Voltage :	DC 5V from Adapter with AC 120V/60Hz
Test Mode :	CH11(802.11n Mode)/20MHz	Polarization :	Vertical

Frequency (MHz)	Meter Reading (dBµV)	Factor (dB)	Emission Level (dBµV/m)	Limits (dBµV/m)	Margin (dB)	Value Type
4924.136	51.92	10.39	62.31	74	-11.69	peak
4924.062	35.73	10.39	46.12	54	-7.88	AVG
7386.094	42.32	12.68	55	74	-19	peak
7386.105	28.57	12.68	41.25	54	-12.75	AVG

Remark:

Factor = Antenna Factor + Cable Loss – Pre-amplifier.



EUT :	Smart Phone	Model Name :	A2
Temperature :	20 °C	Relative Humidity :	48%
Pressure :	1010 hPa	Test Voltage :	DC 5V from Adapter with AC 120V/60Hz
Test Mode :	CH3(802.11n Mode)/40MHz	Polarization :	Horizontal

Frequency (MHz)	Meter Reading (dB $\mu$ V)	Factor (dB)	Emission Level (dB $\mu$ V/m)	Limits (dB $\mu$ V/m)	Margin (dB)	Value Type
4844.127	47.69	10.5	58.19	74	-15.81	peak
4844.135	31.63	10.5	42.13	54	-11.87	AVG
7266.233	48.48	12.5	60.98	74	-13.02	peak
7266.223	31.25	12.5	43.75	54	-10.25	AVG

Remark:

Factor = Antenna Factor + Cable Loss – Pre-amplifier.

EUT :	Smart Phone	Model Name :	A2
Temperature :	20 °C	Relative Humidity :	48%
Pressure :	1010 hPa	Test Voltage :	DC 5V from Adapter with AC 120V/60Hz
Test Mode :	CH3(802.11n Mode)/40MHz	Polarization :	Vertical

Frequency (MHz)	Meter Reading (dB $\mu$ V)	Factor (dB)	Emission Level (dB $\mu$ V/m)	Limits (dB $\mu$ V/m)	Margin (dB)	Value Type
4844.296	47.59	10.5	58.09	74	-15.91	peak
4844.320	30.64	10.5	41.14	54	-12.86	AVG
7266.239	48.82	12.5	61.32	74	-12.68	peak
7266.247	29.41	12.5	41.91	54	-12.09	AVG

Remark:

Factor = Antenna Factor + Cable Loss – Pre-amplifier.



EUT :	Smart Phone	Model Name :	A2
Temperature :	20 °C	Relative Humidity :	48%
Pressure :	1010 hPa	Test Voltage :	DC 5V from Adapter with AC 120V/60Hz
Test Mode :	CH6(802.11n Mode)/40MHz	Polarization :	Horizontal

Frequency (MHz)	Meter Reading (dBµV)	Factor (dB)	Emission Level (dBµV/m)	Limits (dBµV/m)	Margin (dB)	Value Type
4874.236	48.77	10.4	59.17	74	-14.83	peak
4874.201	33.49	10.4	43.89	54	-10.11	AVG
7311.060	47.23	12.75	59.98	74	-14.02	peak
7311.159	32.54	12.75	45.29	54	-8.71	AVG

Remark:

Factor = Antenna Factor + Cable Loss – Pre-amplifier.

EUT :	Smart Phone	Model Name :	A2
Temperature :	20 °C	Relative Humidity :	48%
Pressure :	1010 hPa	Test Voltage :	DC 5V from Adapter with AC 120V/60Hz
Test Mode :	CH6(802.11n Mode)/40MHz	Polarization :	Vertical

Frequency (MHz)	Meter Reading (dBµV)	Factor (dB)	Emission Level (dBµV/m)	Limits (dBµV/m)	Margin (dB)	Value Type
4874.534	47.39	10.4	57.79	74	-16.21	peak
4874.460	34.56	10.4	44.96	54	-9.04	AVG
7311.582	46.72	12.75	59.47	74	-14.53	peak
7311.590	35.36	12.75	48.11	54	-5.89	AVG

Remark:

Factor = Antenna Factor + Cable Loss – Pre-amplifier.





EUT :	Smart Phone	Model Name :	A2
Temperature :	20 °C	Relative Humidity :	48%
Pressure :	1010 hPa	Test Voltage :	DC 5V from Adapter with AC 120V/60Hz
Test Mode :	CH9(802.11n Mode)/40MHz	Polarization :	Horizontal

Frequency (MHz)	Meter Reading (dB $\mu$ V)	Factor (dB)	Emission Level (dB $\mu$ V/m)	Limits (dB $\mu$ V/m)	Margin (dB)	Value Type
4904.246	49.57	10.29	59.86	74	-14.14	peak
4904.271	35.89	10.29	46.18	54	-7.82	AVG
7356.190	48.45	12.79	61.24	74	-12.76	peak
7356.165	31.59	12.79	44.38	54	-9.62	AVG

Remark:

Factor = Antenna Factor + Cable Loss – Pre-amplifier.

EUT :	Smart Phone	Model Name :	A2
Temperature :	20 °C	Relative Humidity :	48%
Pressure :	1010 hPa	Test Voltage :	DC 5V from Adapter with AC 120V/60Hz
Test Mode :	CH9(802.11n Mode)/40MHz	Polarization :	Vertical

Frequency (MHz)	Meter Reading (dB $\mu$ V)	Factor (dB)	Emission Level (dB $\mu$ V/m)	Limits (dB $\mu$ V/m)	Margin (dB)	Value Type
4904.064	50.82	10.29	61.11	74	-12.89	peak
4904.150	34.56	10.29	44.85	54	-9.15	AVG
7356.352	48.55	12.79	61.34	74	-12.66	peak
7356.412	32.29	12.79	45.08	54	-8.92	AVG

Remark:

Factor = Antenna Factor + Cable Loss – Pre-amplifier.





## 3.2.6 TEST RESULTS (BAND EDGE)

EUT :	Smart Phone	Model Name :	A2
Temperature :	20 °C	Relative Humidity :	48%
Pressure :	1010 hPa	Test Voltage :	DC 5V from Adapter with AC 120V/60Hz
Test Mode :	CH1(802.11b Mode)	Polarization :	Horizontal

Frequency (MHz)	Meter Reading (dB $\mu$ V)	Factor (dB)	Emission Level (dB $\mu$ V/m)	Limits (dB $\mu$ V/m)	Margin (dB)	Value Type
2399.900	80.52	-13	67.52	74	-6.48	peak
2399.900	61.48	-13	48.48	54	-5.54	AVG
2400.000	82.32	-12.99	69.33	74	-4.41	peak
2400.000	61.29	-12.99	48.3	54	-5.74	AVG
Remark:						
Factor = Antenna Factor + Cable Loss – Pre-amplifier.						

EUT :	Smart Phone	Model Name :	A2
Temperature :	20 °C	Relative Humidity :	48%
Pressure :	1010 hPa	Test Voltage :	DC 5V from Adapter with AC 120V/60Hz
Test Mode :	CH1(802.11b Mode)	Polarization :	Vertical

Frequency (MHz)	Meter Reading (dB $\mu$ V)	Factor (dB)	Emission Level (dB $\mu$ V/m)	Limits (dB $\mu$ V/m)	Margin (dB)	Value Type
2399.900	81.63	-13	68.63	74	-5.37	peak
2399.900	61.29	-13	48.29	54	-5.71	AVG
2400.000	78.45	-12.99	65.46	74	-8.54	peak
2400.000	59.47	-12.99	46.48	54	-7.52	AVG
Remark:						
Factor = Antenna Factor + Cable Loss – Pre-amplifier.						



EUT :	Smart Phone	Model Name :	A2
Temperature :	20 °C	Relative Humidity :	48%
Pressure :	1010 hPa	Test Voltage :	DC 5V from Adapter with AC 120V/60Hz
Test Mode :	CH11(802.11b Mode)	Polarization :	Horizontal

Frequency (MHz)	Meter Reading (dBμV)	Factor (dB)	Emission Level (dBμV/m)	Limits (dBμV/m)	Margin (dB)	Value Type
2483.500	78.59	-12.78	65.81	74	-8.19	peak
2483.500	60.32	-12.78	47.54	54	-6.46	AVG
2483.600	79.63	-12.77	66.86	74	-7.14	peak
2483.600	60.54	-12.78	47.76	54	-6.24	AVG

Remark:

Factor = Antenna Factor + Cable Loss – Pre-amplifier.

EUT :	Smart Phone	Model Name :	A2
Temperature :	20 °C	Relative Humidity :	48%
Pressure :	1010 hPa	Test Voltage :	DC 5V from Adapter with AC 120V/60Hz
Test Mode :	CH11(802.11b Mode)	Polarization :	Vertical

Frequency (MHz)	Meter Reading (dBμV)	Factor (dB)	Emission Level (dBμV/m)	Limits (dBμV/m)	Margin (dB)	Value Type
2483.500	77.83	-12.78	65.05	74	-8.95	peak
2483.500	60.32	-12.78	47.54	54	-6.46	AVG
2483.600	78.52	-12.77	65.75	74	-8.25	peak
2483.600	59.41	-12.77	46.64	54	-7.36	AVG

Remark:

Factor = Antenna Factor + Cable Loss – Pre-amplifier.



EUT :	Smart Phone	Model Name :	A2
Temperature :	20 °C	Relative Humidity :	48%
Pressure :	1010 hPa	Test Voltage :	DC 5V from Adapter with AC 120V/60Hz
Test Mode :	CH1(802.11g Mode)	Polarization :	Horizontal

Frequency (MHz)	Meter (dBµV)	Factor (dB)	Emission (dBµV/m)	Limits (dBµV/m)	Margin (dB)	Value Type
2399.900	76.26	-13	63.26	74	-10.74	peak
2399.900	59.45	-13	46.45	54	-7.55	AVG
2400.000	78.19	-12.99	65.2	74	-8.8	peak
2400.000	58.44	-12.99	45.45	54	-8.55	AVG

Remark:

Factor = Antenna Factor + Cable Loss – Pre-amplifier.

EUT :	Smart Phone	Model Name :	A2
Temperature :	20 °C	Relative Humidity :	48%
Pressure :	1010 hPa	Test Voltage :	DC 5V from Adapter with AC 120V/60Hz
Test Mode :	CH1(802.11gMode)	Polarization :	Vertical

Frequency (MHz)	Meter Reading (dBµV)	Factor (dB)	Emission Level (dBµV/m)	Limits (dBµV/m)	Margin (dB)	Value Type
2399.900	77.79	-13	64.79	74	-9.21	peak
2399.900	60.28	-13	47.28	54	-6.72	AVG
2400.000	78.82	-12.99	65.83	74	-8.17	peak
2400.000	62.24	-12.99	49.25	54	-4.75	AVG

Remark:

Factor = Antenna Factor + Cable Loss – Pre-amplifier.



EUT :	Smart Phone	Model Name :	A2
Temperature :	20 °C	Relative Humidity :	48%
Pressure :	1010 hPa	Test Voltage :	DC 5V from Adapter with AC 120V/60Hz
Test Mode :	CH11(802.11g Mode)	Polarization :	Horizontal

Frequency (MHz)	Meter Reading (dB $\mu$ V)	Factor (dB)	Emission Level (dB $\mu$ V/m)	Limits (dB $\mu$ V/m)	Margin (dB)	Value Type
2483.500	77.12	-12.78	64.34	74	-9.66	peak
2483.500	63.23	-12.78	50.45	54	-3.55	AVG
2483.600	76.48	-12.77	63.71	74	-10.29	peak
2483.600	61.64	-12.77	48.87	54	-5.13	AVG

Remark:

Factor = Antenna Factor + Cable Loss – Pre-amplifier.

EUT :	Smart Phone	Model Name :	A2
Temperature :	20 °C	Relative Humidity :	48%
Pressure :	1010 hPa	Test Voltage :	DC 5V from Adapter with AC 120V/60Hz
Test Mode :	CH11(802.11g Mode)	Polarization :	Vertical

Frequency (MHz)	Meter Reading (dB $\mu$ V)	Factor (dB)	Emission Level (dB $\mu$ V/m)	Limits (dB $\mu$ V/m)	Margin (dB)	Value Type
2483.500	76.07	-12.78	63.29	74	-10.71	peak
2483.500	60.49	-12.78	47.71	54	-6.29	AVG
2483.600	75.03	-12.77	62.26	74	-11.74	peak
2483.600	61.34	-12.77	48.57	54	-5.43	AVG

Remark:

Factor = Antenna Factor + Cable Loss – Pre-amplifier.



EUT :	Smart Phone	Model Name :	A2
Temperature :	20 °C	Relative Humidity :	48%
Pressure :	1010 hPa	Test Voltage :	DC 5V from Adapter with AC 120V/60Hz
Test Mode :	CH1(802.11n Mode)/20MHz	Polarization :	Horizontal

Frequency (MHz)	Meter Reading (dBµV)	Factor (dB)	Emission Level (dBµV/m)	Limits (dBµV/m)	Margin (dB)	Value Type
2399.900	76.35	-13	63.35	74	-10.65	peak
2399.900	58.24	-13	45.24	54	-8.76	AVG
2400.000	78.29	-12.99	65.3	74	-8.7	peak
2400.000	58.52	-12.99	45.53	54	-8.47	AVG

Remark:

Factor = Antenna Factor + Cable Loss – Pre-amplifier.

EUT :	Smart Phone	Model Name :	A2
Temperature :	20 °C	Relative Humidity :	48%
Pressure :	1010 hPa	Test Voltage :	DC 5V from Adapter with AC 120V/60Hz
Test Mode :	CH1(802.11n Mode)/20M	Polarization :	Vertical

Frequency (MHz)	Meter Reading (dBµV)	Factor (dB)	Emission Level (dBµV/m)	Limits (dBµV/m)	Margin (dB)	Value Type
2399.900	77.93	-13	64.93	74	-9.07	peak
2399.900	58.34	-13	45.34	54	-8.66	AVG
2400.000	76.37	-12.99	63.38	74	-10.62	peak
2400.000	59.45	-12.99	46.46	54	-7.54	AVG

Remark:

Factor = Antenna Factor + Cable Loss – Pre-amplifier.



EUT :	Smart Phone	Model Name :	A2
Temperature :	20 °C	Relative Humidity :	48%
Pressure :	1010 hPa	Test Voltage :	DC 5V from Adapter with AC 120V/60Hz
Test Mode :	CH11(802.11n Mode)/20MHz	Polarization :	Horizontal

Frequency (MHz)	Meter Reading (dBµV)	Factor (dB)	Emission Level (dBµV/m)	Limits (dBµV/m)	Margin (dB)	Value Type
2483.500	77.89	-12.78	65.11	74	-8.89	peak
2483.500	56.75	-12.78	43.97	54	-10.03	AVG
2483.600	75.32	-12.77	62.55	74	-11.45	peak
2483.600	57.67	-12.77	44.9	54	-9.1	AVG

Remark:  
Factor = Antenna Factor + Cable Loss – Pre-amplifier.

EUT :	Smart Phone	Model Name :	A2
Temperature :	20 °C	Relative Humidity :	48%
Pressure :	1010 hPa	Test Voltage :	DC 5V from Adapter with AC 120V/60Hz
Test Mode :	CH11(802.11n Mode)/20MHz	Polarization :	Vertical

Frequency (MHz)	Meter Reading (dBµV)	Factor (dB)	Emission Level (dBµV/m)	Limits (dBµV/m)	Margin (dB)	Value Type
2483.500	73.79	-12.78	60.45	74	-13.55	peak
2483.500	59.55	-12.78	46.84	54	-7.16	AVG
2483.600	73.69	-12.78	60.45	74	-13.55	peak
2483.600	59.45	-12.78	46.84	54	-7.16	AVG

Remark:  
Factor = Antenna Factor + Cable Loss – Pre-amplifier.



EUT :	Smart Phone	Model Name :	A2
Temperature :	20 °C	Relative Humidity :	48%
Pressure :	1010 hPa	Test Voltage :	DC 5V from Adapter with AC 120V/60Hz
Test Mode :	CH3(802.11n Mode)/40M	Polarization :	Horizontal

Frequency (MHz)	Meter Reading (dBμV)	Factor (dB)	Emission Level (dBμV/m)	Limits (dBμV/m)	Margin (dB)	Value Type
2399.900	77.83	-13	64.83	74	-9.17	peak
2399.900	58.21	-13	45.21	54	-8.79	AVG
2400.000	77.96	-12.99	64.97	74	-9.03	peak
2400.000	59.51	-12.99	46.52	54	-7.48	AVG

Remark:

Factor = Antenna Factor + Cable Loss – Pre-amplifier.

EUT :	Smart Phone	Model Name :	A2
Temperature :	20 °C	Relative Humidity :	48%
Pressure :	1010 hPa	Test Voltage :	DC 5V from Adapter with AC 120V/60Hz
Test Mode :	CH3(802.11n Mode)/40MHz	Polarization :	Vertical

Frequency (MHz)	Meter Reading (dBμV)	Factor (dB)	Emission Level (dBμV/m)	Limits (dBμV/m)	Margin (dB)	Value Type
2399.900	80.58	-13	67.58	74	-6.42	peak
2399.900	55.36	-13	42.36	54	-11.64	AVG
2400.000	78.34	-12.99	65.35	74	-8.65	peak
2400.000	55.49	-12.99	42.5	54	-11.5	AVG

Remark:

Factor = Antenna Factor + Cable Loss – Pre-amplifier.





EUT :	Smart Phone	Model Name :	A2
Temperature :	20 °C	Relative Humidity :	48%
Pressure :	1010 hPa	Test Voltage :	DC 5V from Adapter with AC 120V/60Hz
Test Mode :	CH9(802.11n Mode)/40MHz	Polarization :	Horizontal

Frequency (MHz)	Meter Reading (dBµV)	Factor (dB)	Emission Level (dBµV/m)	Limits (dBµV/m)	Margin (dB)	Value Type
2483.500	76.32	-12.78	63.54	74	-10.46	peak
2483.500	59.14	-12.78	46.36	54	-7.64	AVG
2483.600	77.23	-12.77	64.46	74	-9.54	peak
2483.600	61.18	-12.77	48.41	54	-5.59	AVG

Remark:  
Factor = Antenna Factor + Cable Loss – Pre-amplifier.

EUT :	Smart Phone	Model Name :	A2
Temperature :	20 °C	Relative Humidity :	48%
Pressure :	1010 hPa	Test Voltage :	DC 5V from Adapter with AC 120V/60Hz
Test Mode :	CH9(802.11n Mode)/40MHz	Polarization :	Vertical

Frequency (MHz)	Meter Reading (dBµV)	Factor (dB)	Emission Level (dBµV/m)	Limits (dBµV/m)	Margin (dB)	Value Type
2483.500	77.45	-12.78	64.67	74	-9.33	peak
2483.500	60.41	-12.78	47.63	54	-6.37	AVG
2483.600	78.28	-12.78	65.5	74	-8.5	peak
2483.600	59.36	-12.78	46.58	54	-7.42	AVG

Remark:  
Factor = Antenna Factor + Cable Loss – Pre-amplifier.



#### 4. CONDUCTED SPURIOUS EMISSIONS

##### 4.1 APPLIED PROCEDURES / LIMIT

In any 100 kHz bandwidth outside the frequency band in which the spread spectrum or digitally modulated intentional radiator is operating, the radio frequency power that is produced by the intentional radiator shall be at least 20 dB below that in the 100 kHz bandwidth within the band that contains the highest level of the desired power, based on either an RF conducted or a radiated measurement. Attenuation below the general limits specified in Section 15.209(a) is not required. In addition, radiated emissions which fall in the restricted bands, as defined in §15.205(a), must also comply with the radiated emission limits specified in §15.209(a) (see §15.205(c)).

##### 4.2 TEST PROCEDURE

Spectrum Parameter	Setting
Detector	Peak
Start/Stop Frequency	30 MHz to 10th carrier harmonic
RB / VB (emission in restricted band)	100 KHz/300 KHz
Trace-Mode:	Max hold

For Band edge

Spectrum Parameter	Setting
Detector	Peak
Start/Stop Frequency	Lower Band Edge: 2300 to 2430 MHz Upper Band Edge: 2450 to 2500 MHz
RB / VB (emission in restricted band)	100 KHz/300 KHz
Trace-Mode:	Max hold

##### 4.3 DEVIATION FROM STANDARD

No deviation.

##### 4.4 TEST SETUP

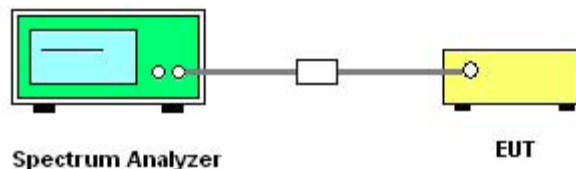

The EUT which is powered by the Battery, is coupled to the Spectrum Analyzer; the RF load attached to the EUT antenna terminal is 50Ohm; the path loss as the factor is calibrated to correct the reading. Make the measurement with the spectrum analyzer's resolution bandwidth (RBW) = 100 kHz. In order to make an accurate measurement, set the span greater than RBW.

##### 4.5 EUT OPERATION CONDITIONS

The EUT tested system was configured as the statements of 2.3 Unless otherwise a special operating condition is specified in the follows during the testing.



4.6 TEST RESULTS

EUT :	Smart Phone	Model Name :	A2
Temperature :	25 °C	Relative Humidity :	60%
Pressure :	1015 hPa	Test Voltage :	DC 5V from Adapter with AC 120V/60Hz
Test Mode :	TX b Mode /CH01, CH06, CH11		

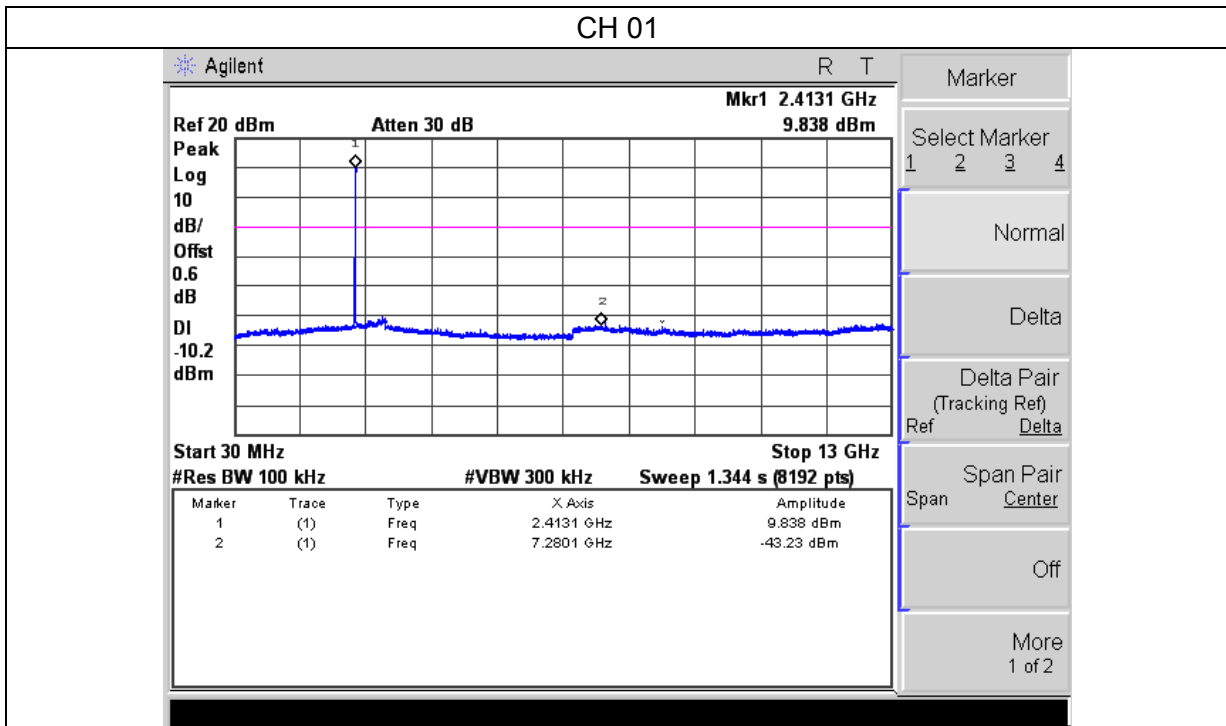

13 g – 25g spurious emissions amplitude decay of the more than 20 db lower than the allowable values do not need the data.

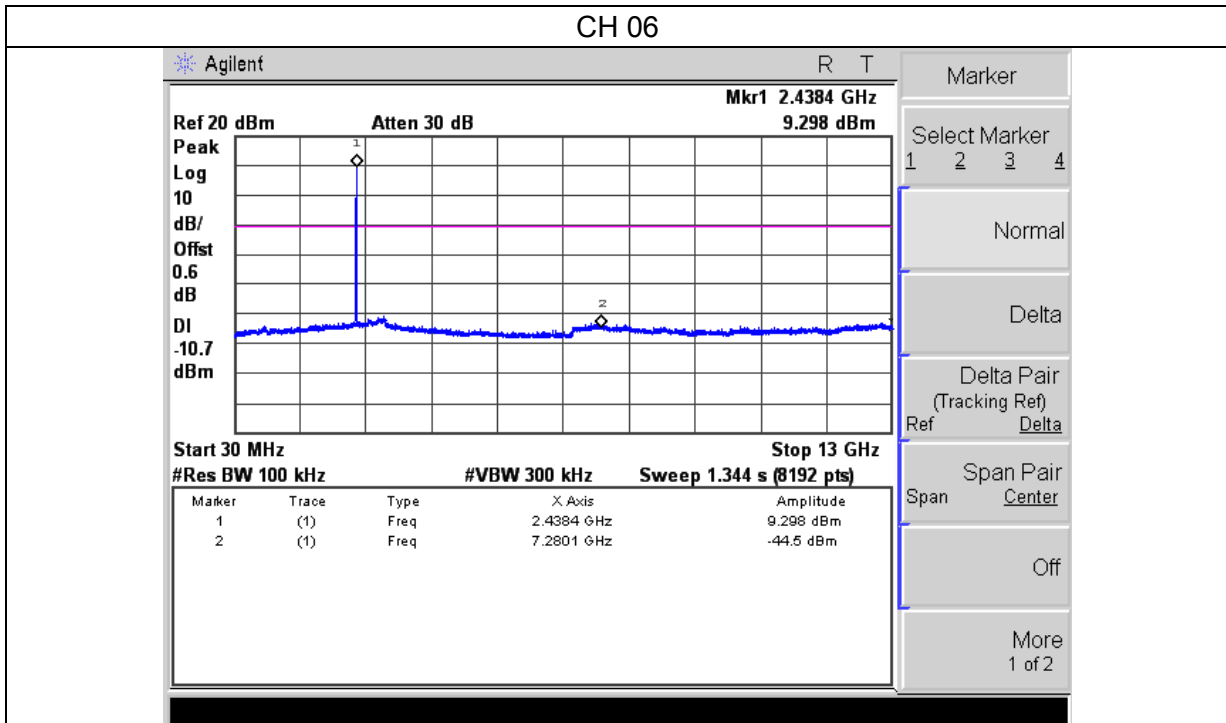

13 g – 25g spurious emissions amplitude decay of the more than 20 db lower than the allowable values do not need the data.

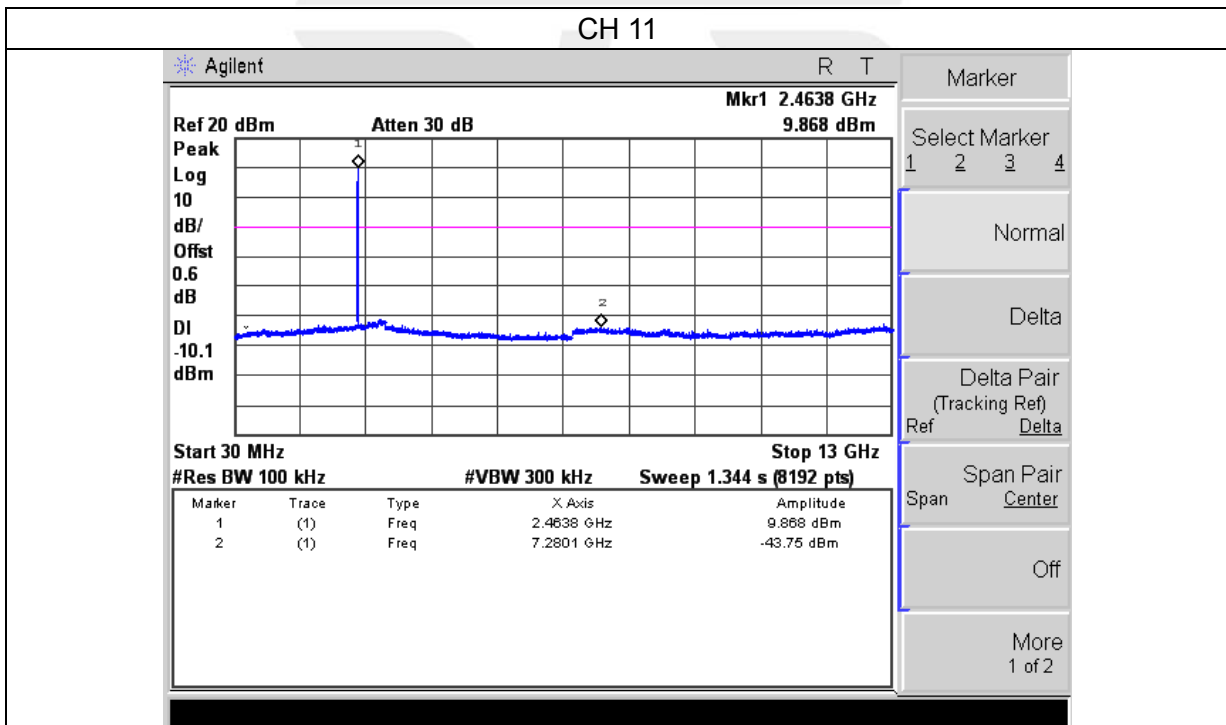

13 g – 25g spurious emissions amplitude decay of the more than 20 db lower than the allowable values do not need the data.



Band edge

CH 01

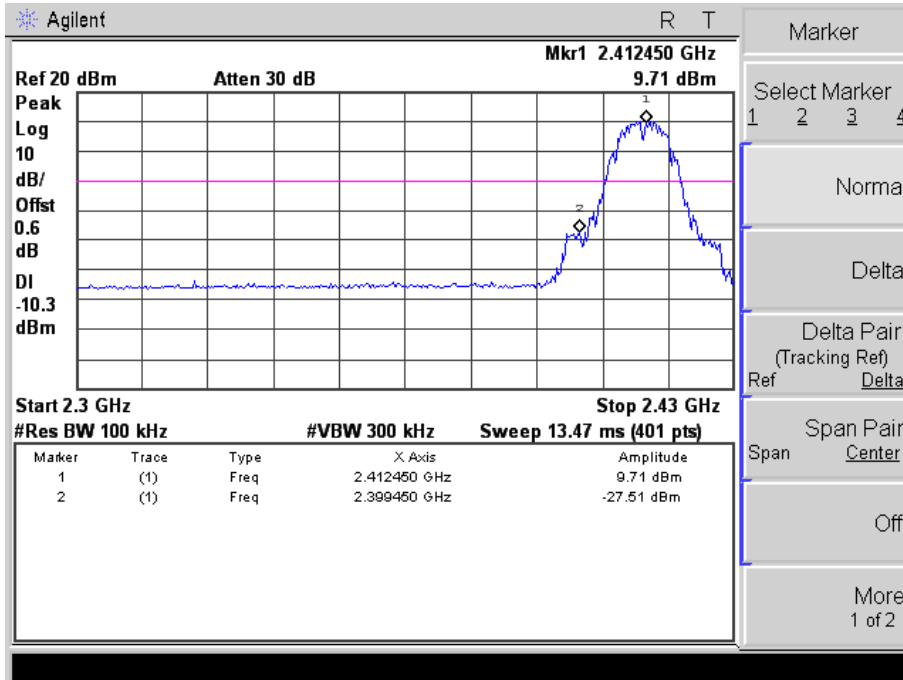

CH 11

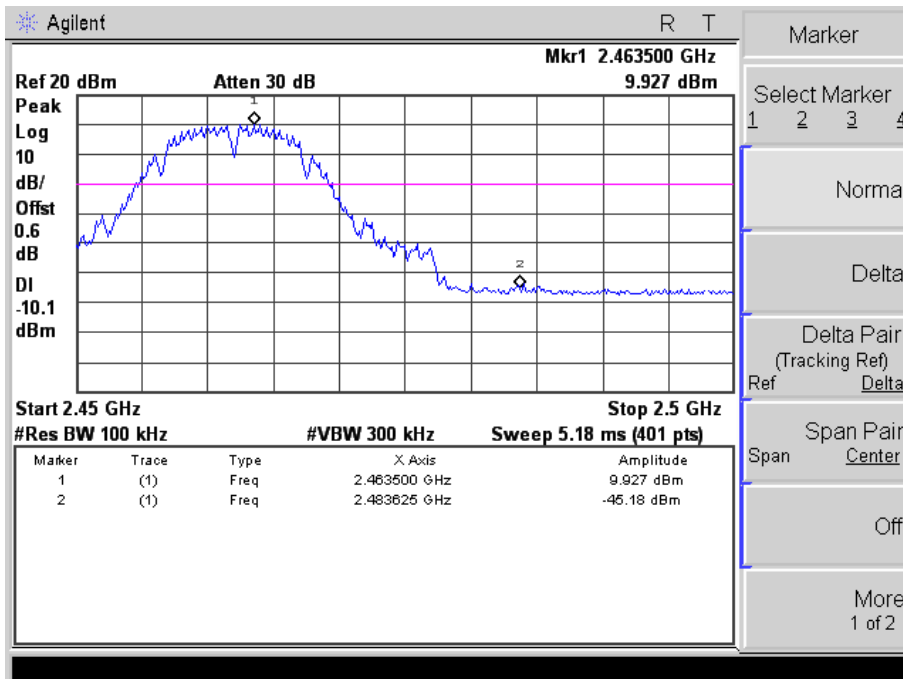



EUT :	Smart Phone	Model Name :	A2
Temperature :	25 °C	Relative Humidity :	60%
Pressure :	1015 hPa	Test Voltage :	DC 5V from Adapter with AC 120V/60Hz
Test Mode :	TX g Mode /CH01, CH06, CH11		

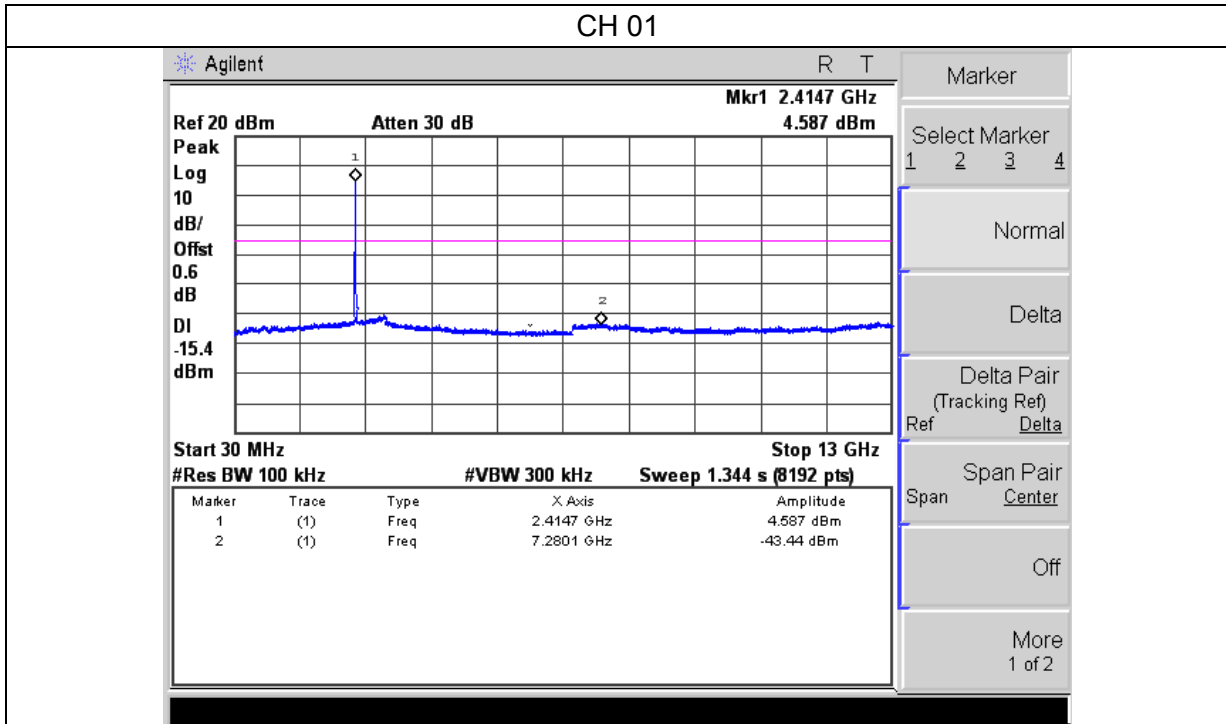

13 g – 25g spurious emissions amplitude decay of the more than 20 db lower than the allowable values do not need the data.

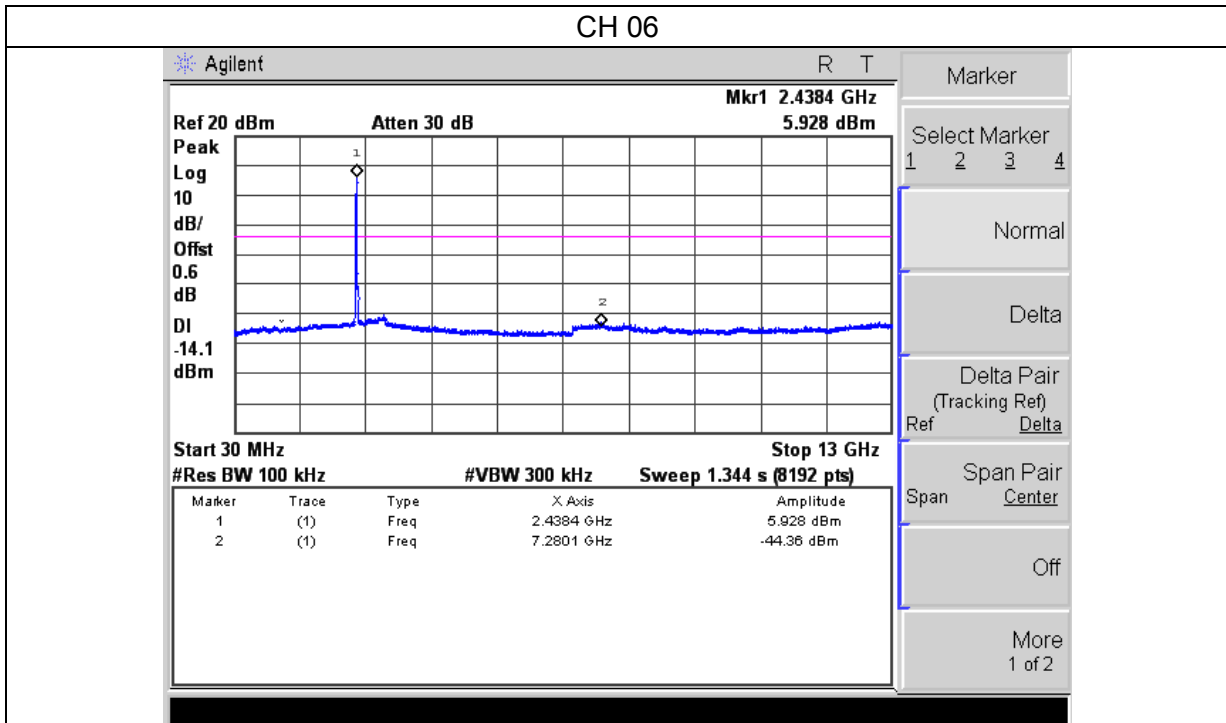

13 g – 25g spurious emissions amplitude decay of the more than 20 db lower than the allowable values do not need the data.

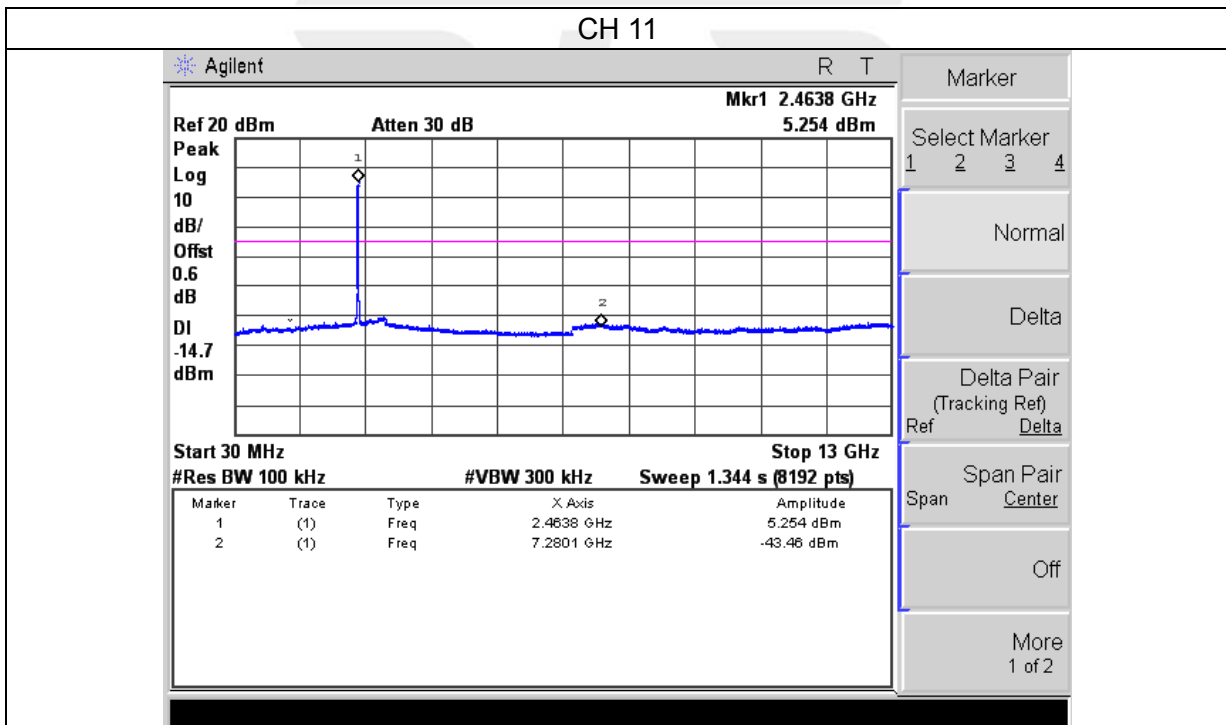

13 g – 25g spurious emissions amplitude decay of the more than 20 db lower than the allowable values do not need the data.



Band edge

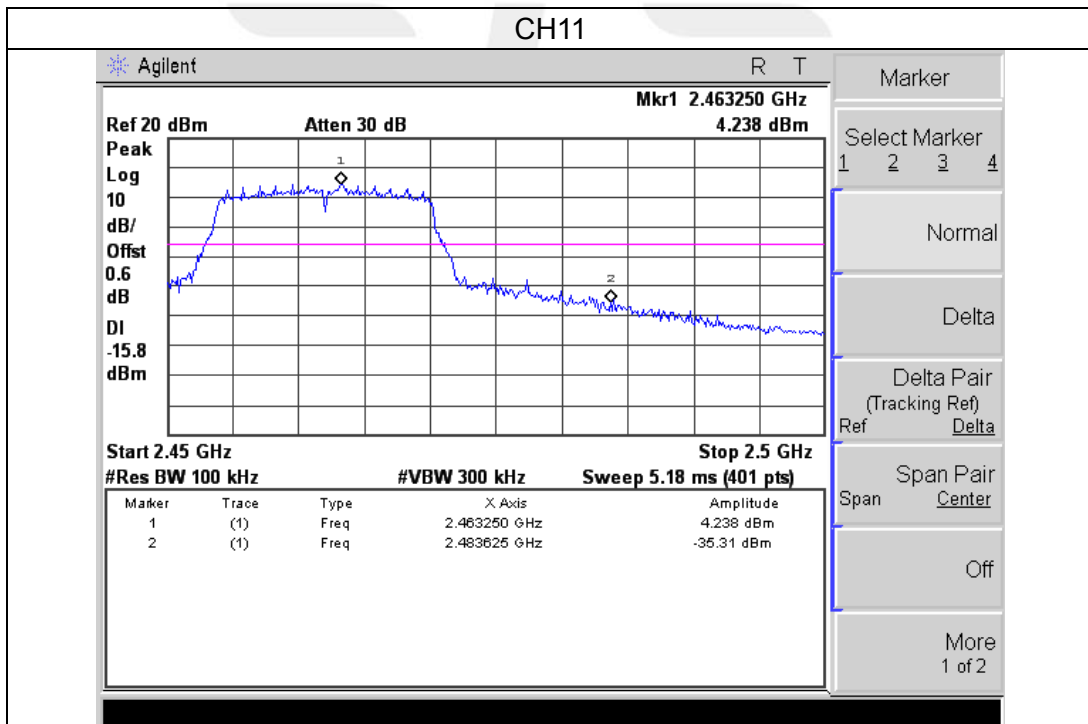
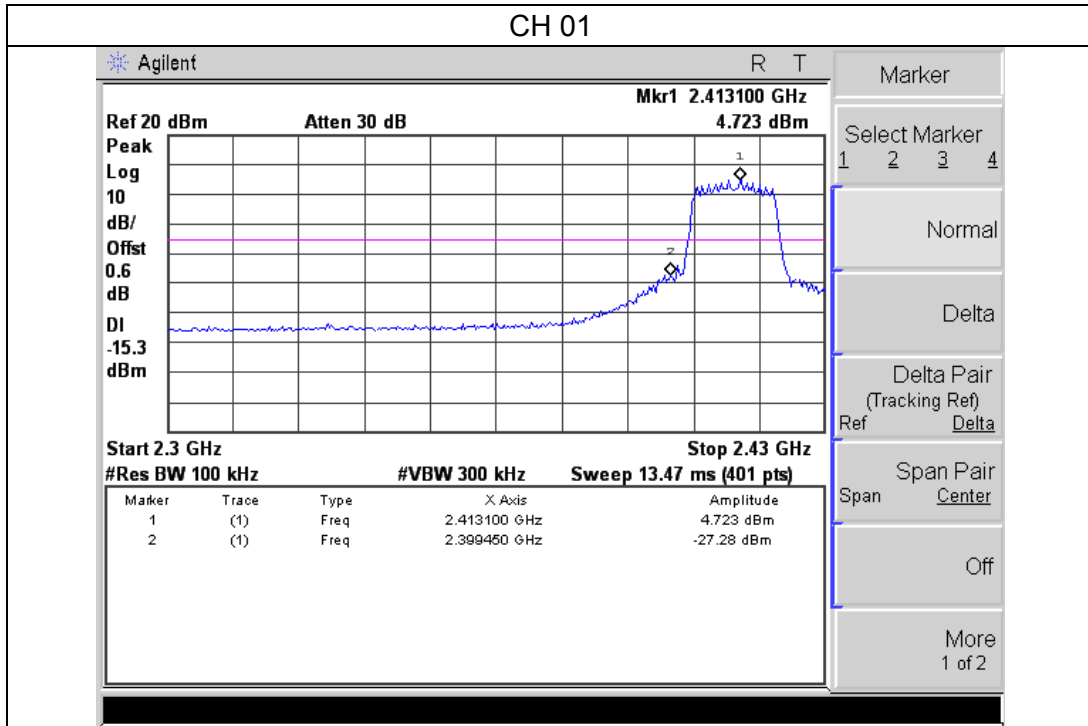



EUT :	Smart Phone	Model Name :	A2
Temperature :	25 °C	Relative Humidity :	60%
Pressure :	1015 hPa	Test Voltage :	DC 5V from Adapter with AC 120V/60Hz
Test Mode :	TX n Mode(20M) /CH01, CH06, CH11		

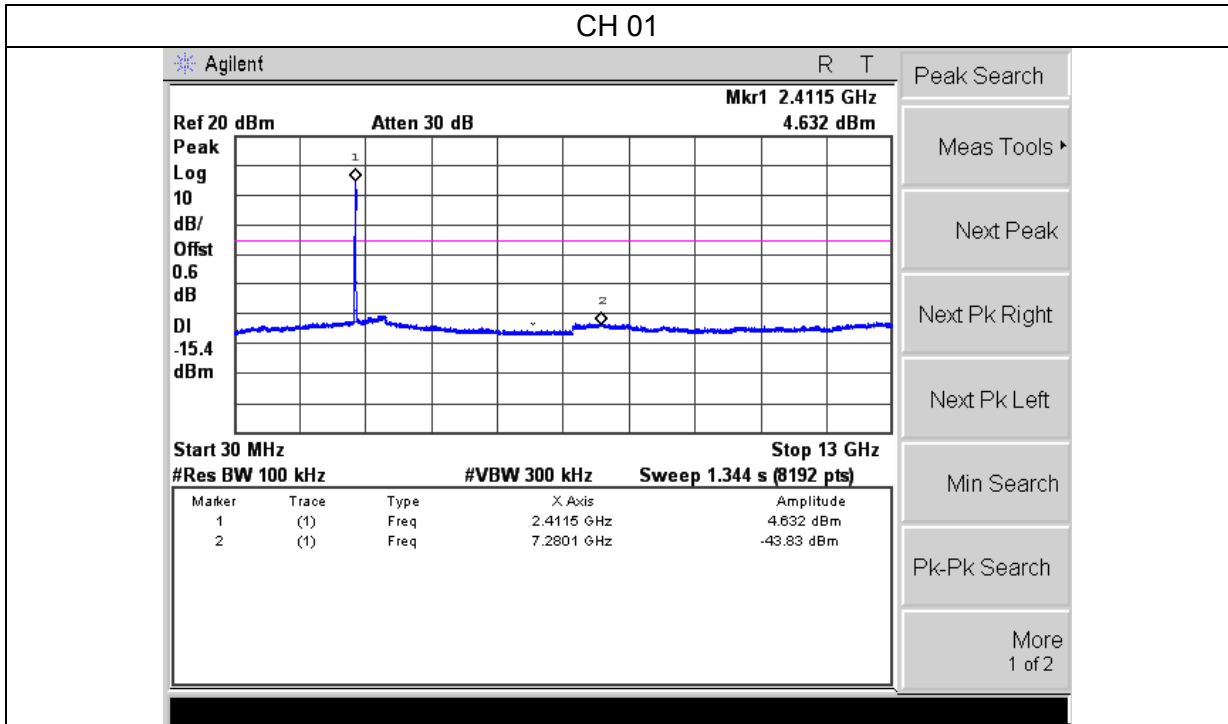

13 g – 25g spurious emissions amplitude decay of the more than 20 db lower than the allowable values do not need the data.



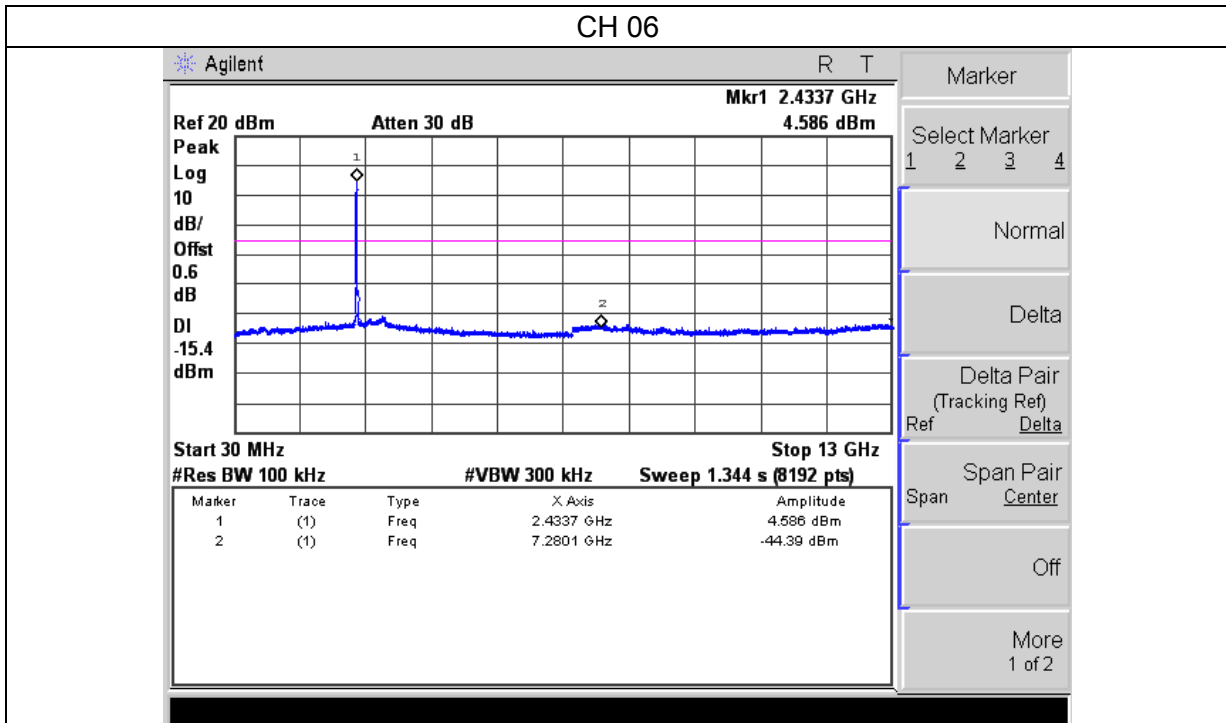

13 g – 25g spurious emissions amplitude decay of the more than 20 db lower than the allowable values do not need the data.

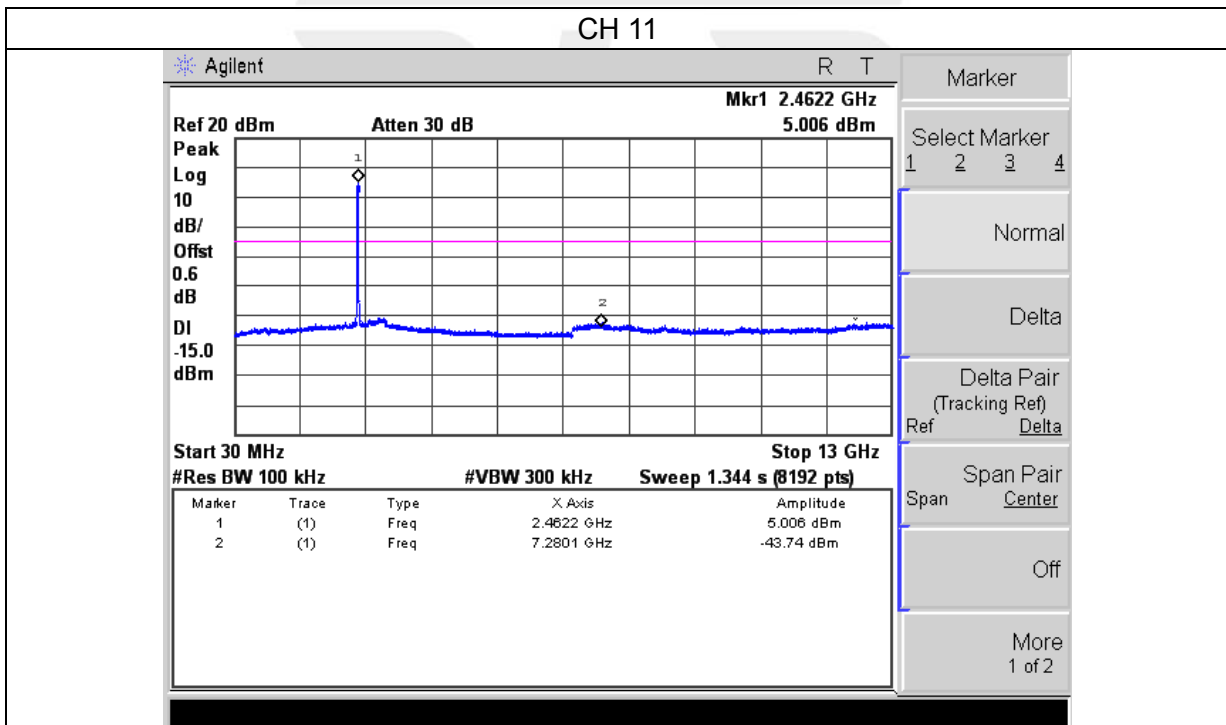

13 g – 25g spurious emissions amplitude decay of the more than 20 db lower than the allowable values do not need the data.



Band edge

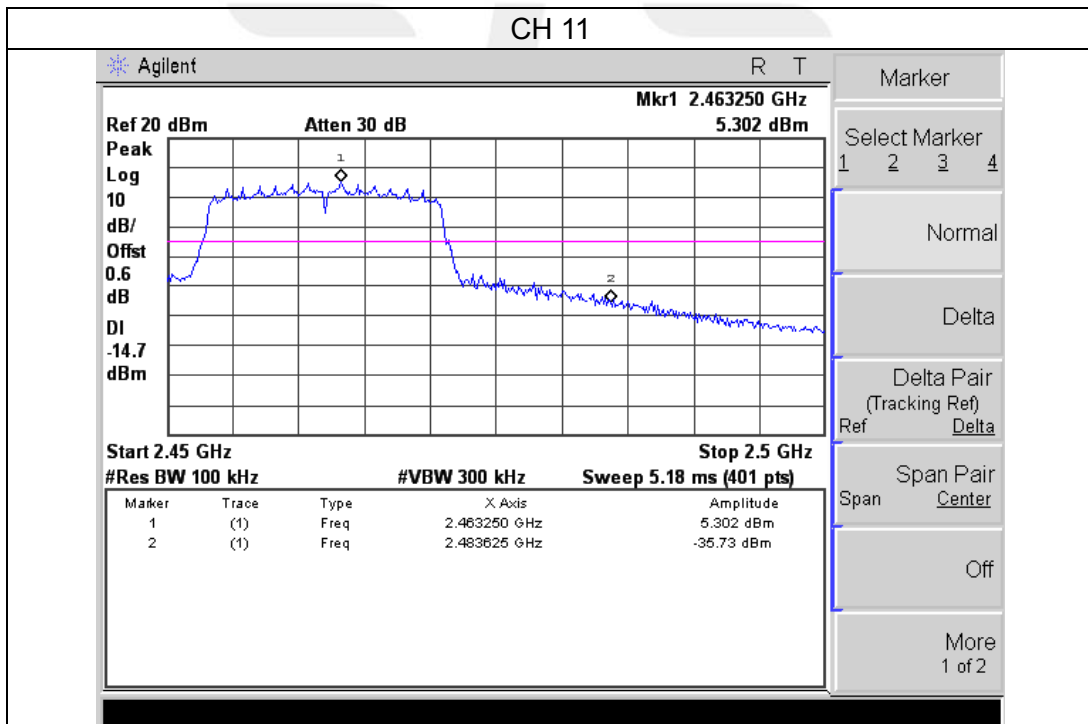
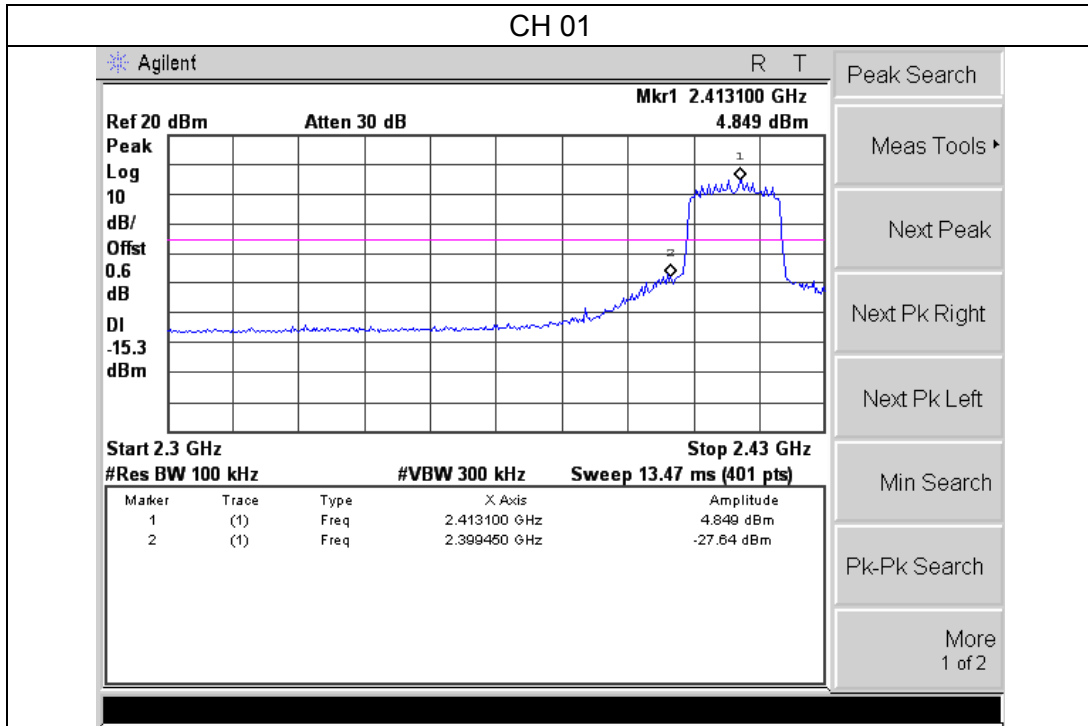



EUT :	Smart Phone	Model Name :	A2
Temperature :	25 °C	Relative Humidity :	60%
Pressure :	1015 hPa	Test Voltage :	DC 5V from Adapter with AC 120V/60Hz
Test Mode :	TX n Mode(40M) /CH03, CH06, CH09		

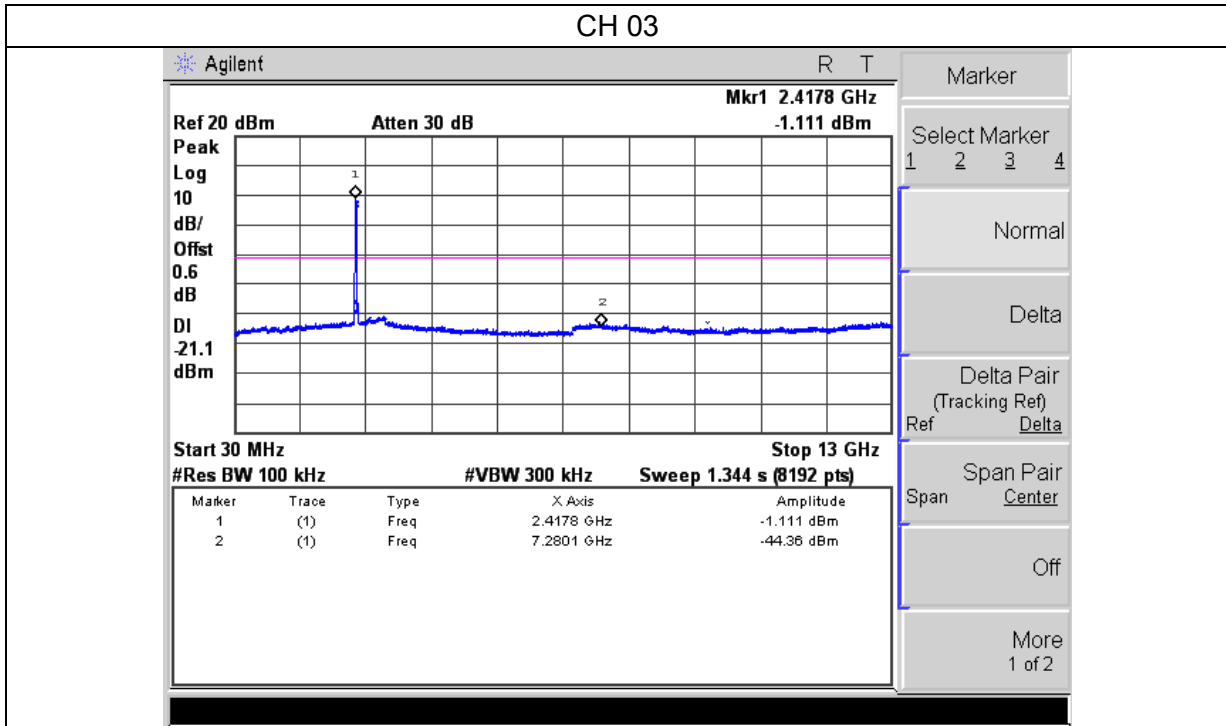

13 g – 25g spurious emissions amplitude decay of the more than 20 db lower than the allowable values do not need the data.

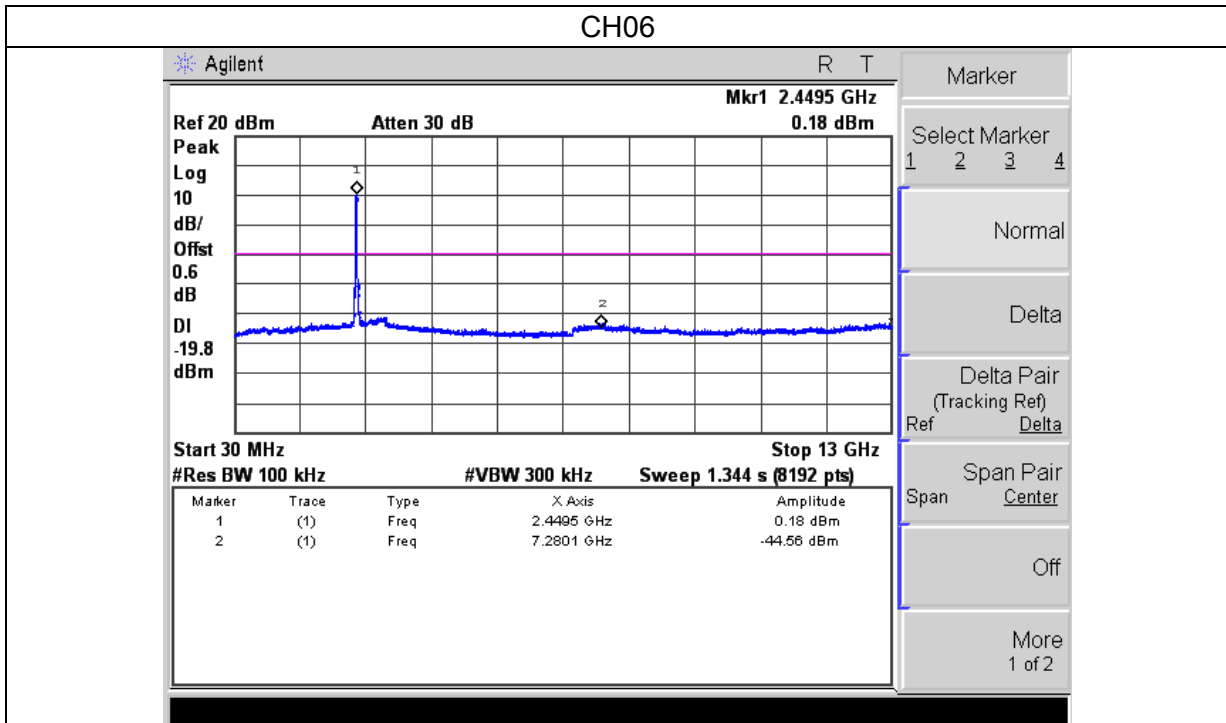

13 g – 25g spurious emissions amplitude decay of the more than 20 db lower than the allowable values do not need the data.

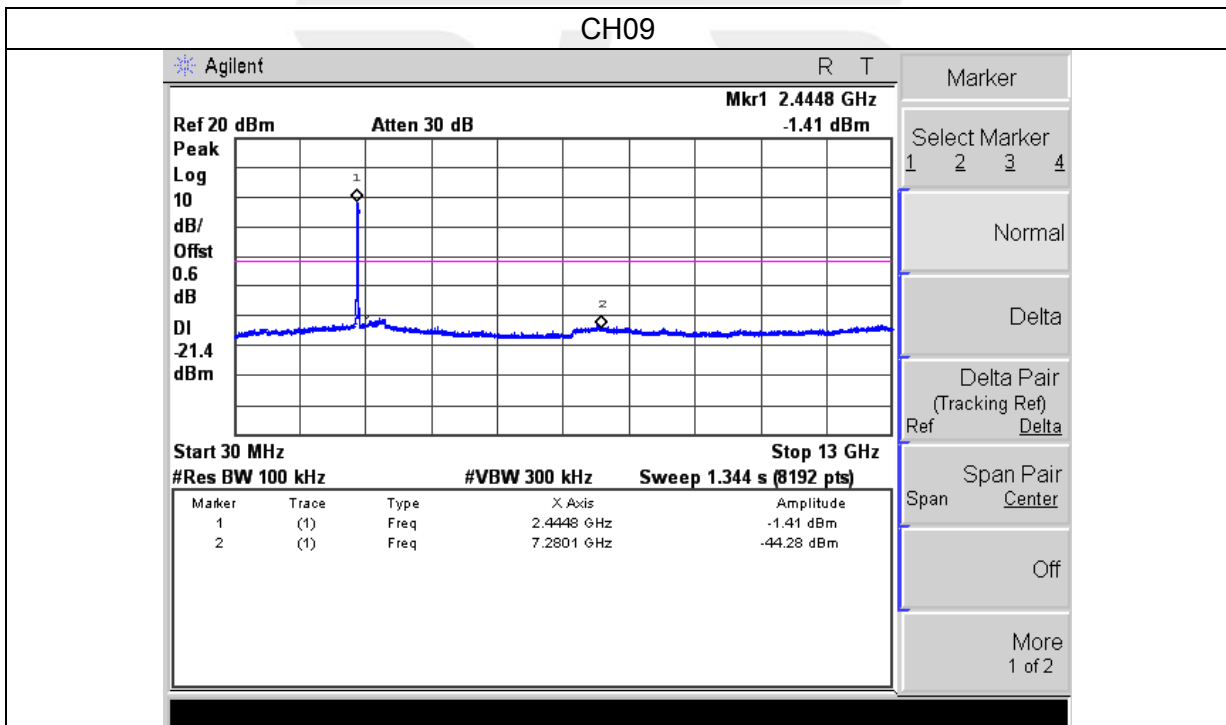

13 g – 25g spurious emissions amplitude decay of the more than 20 db lower than the allowable values do not need the data.



Band edge

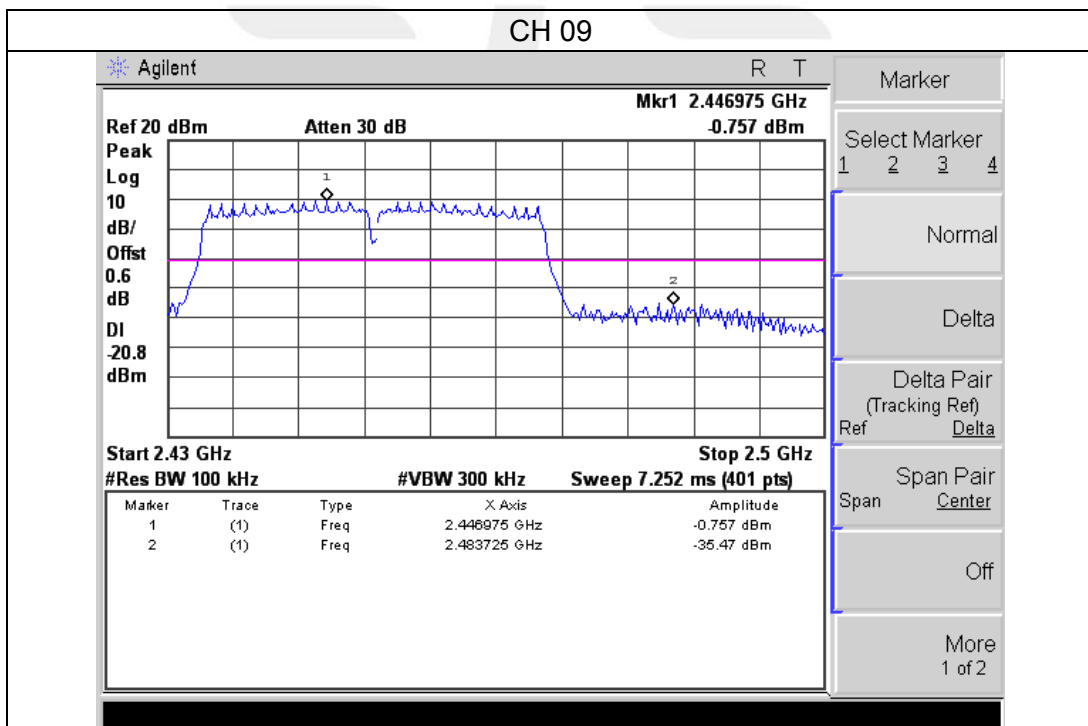
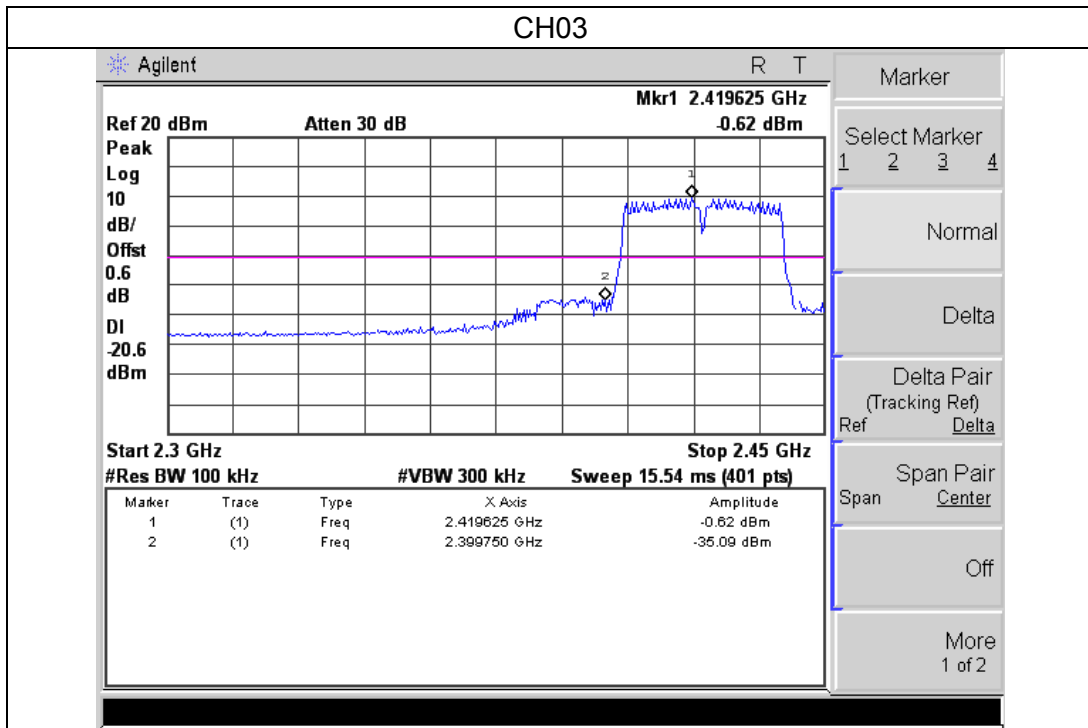

## 5. POWER SPECTRAL DENSITY TEST

### 5.1 APPLIED PROCEDURES / LIMIT

FCC Part15 (15.247) , Subpart C				
Section	Test Item	Limit	Frequency Range (MHz)	Result
15.247	Power Spectral Density	8 dBm (in any 3KHz)	2400-2483.5	PASS

### 5.2 TEST PROCEDURE

1. Set analyzer center frequency to DTS channel center frequency.
2. Set the span to 1.5 times the DTS channel bandwidth.
3. Set the RBW  $\geq$  3 kHz.
4. Set the VBW  $\geq$  3 x RBW.
5. Detector = peak.
6. Sweep time = auto couple.
7. Trace mode = max hold.
8. Allow trace to fully stabilize.
9. Use the peak marker function to determine the maximum amplitude level.
10. If measured value exceeds limit, reduce RBW (no less than 3 kHz) and repeat.

### 5.3 DEVIATION FROM STANDARD

No deviation.

### 5.4 TEST SETUP

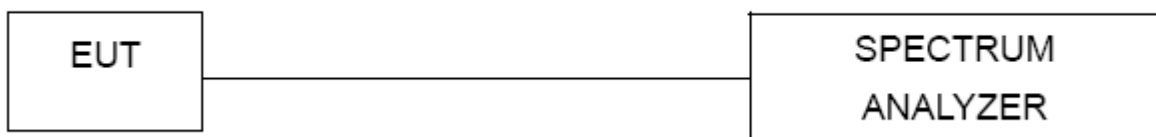

### 5.5 EUT OPERATION CONDITIONS

The EUT tested system was configured as the statements of 2.3 Unless otherwise a special operating condition is specified in the follows during the testing.



5.6 TEST RESULTS

EUT :	Smart Phone	Model Name :	A2
Temperature :	25 °C	Relative Humidity :	60%
Pressure :	1015 hPa	Test Voltage :	DC 5V from Adapter with AC 120V/60Hz
Test Mode :	TX b Mode /CH01, CH06, CH11		

Frequency	Power Density (dBm)	Limit (dBm)	Result
2412 MHz	-4.13	8	<b>PASS</b>
2437 MHz	-3.903	8	<b>PASS</b>
2462 MHz	-4.472	8	<b>PASS</b>

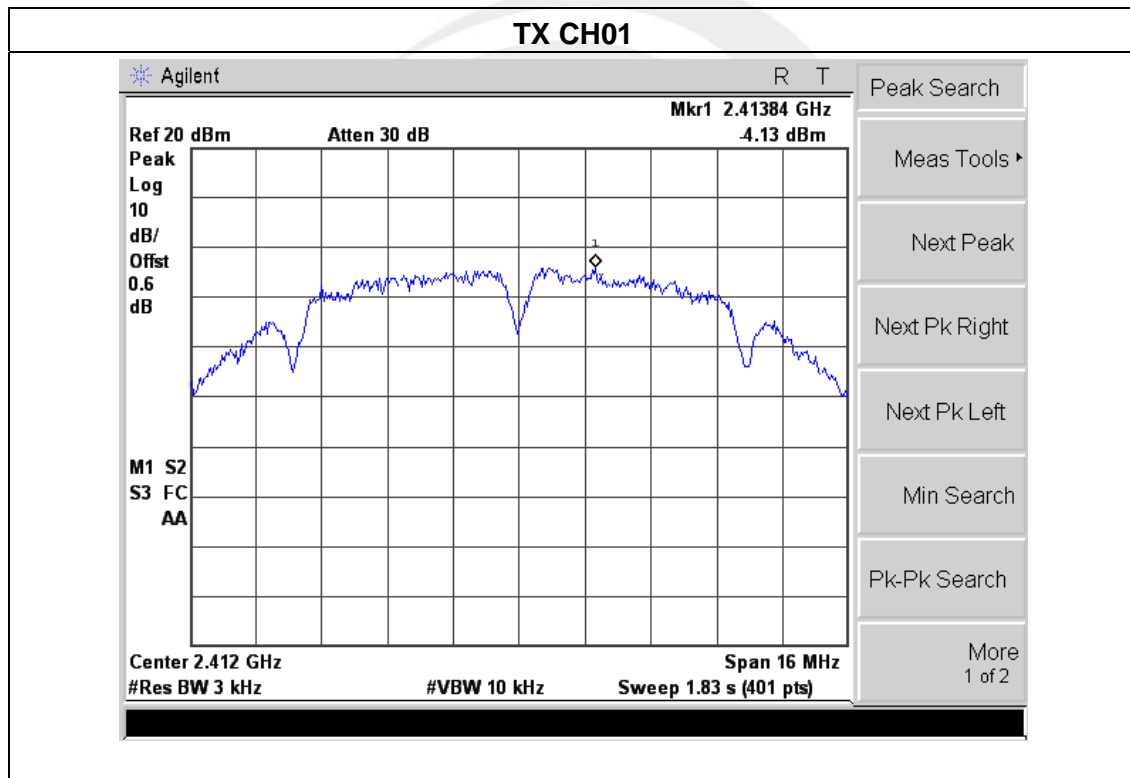

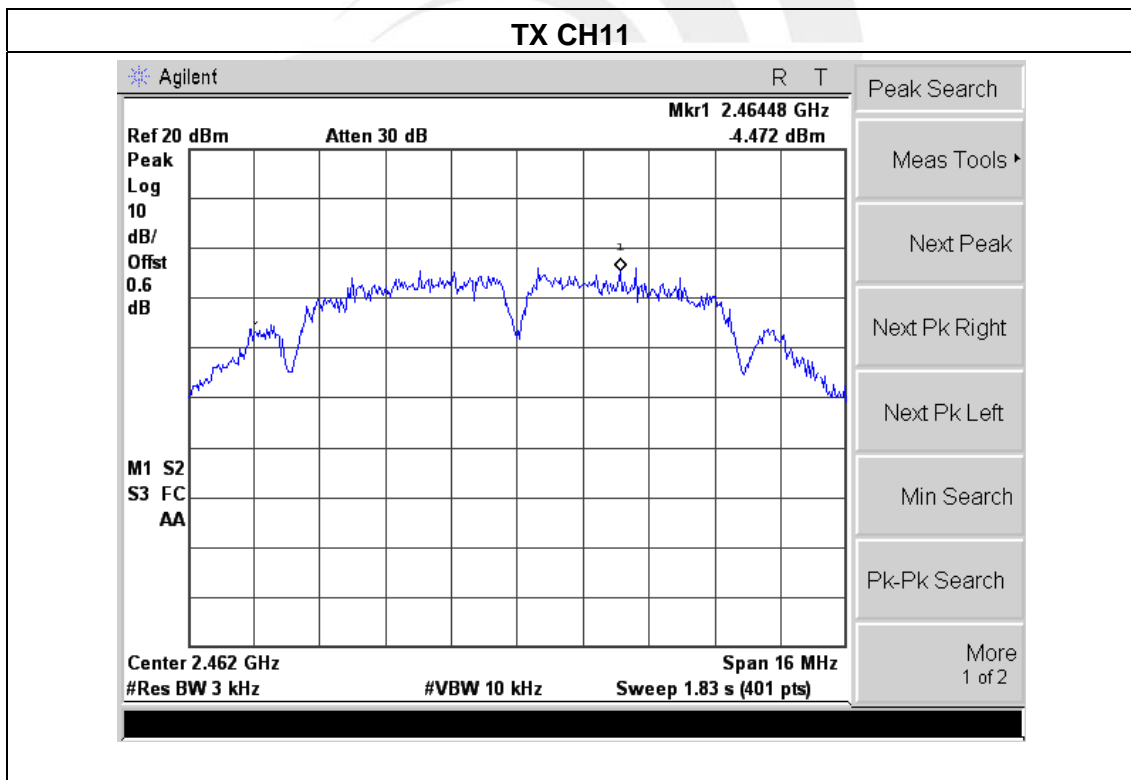
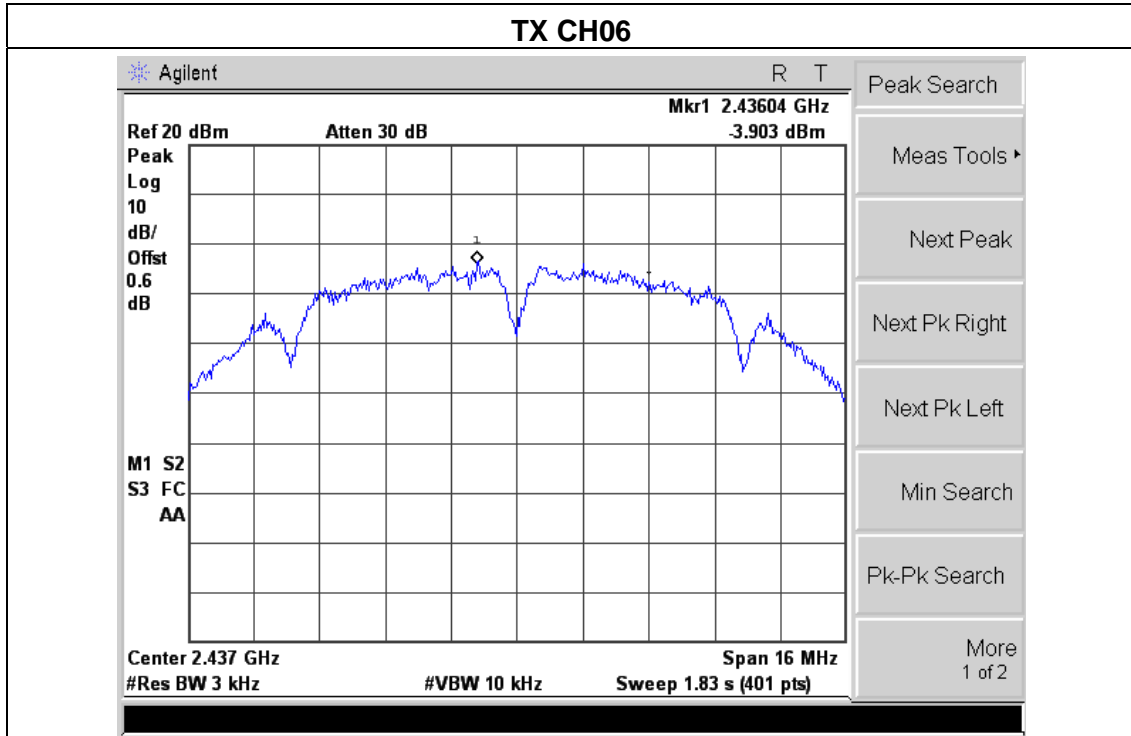





EUT :	Smart Phone	Model Name :	A2
Temperature :	25 °C	Relative Humidity :	60%
Pressure :	1015 hPa	Test Voltage :	DC 5V from Adapter with AC 120V/60Hz
Test Mode :	TX g Mode /CH01, CH06, CH11		

Frequency	Power Density (dBm)	Limit (dBm)	Result
2412 MHz	-9.362	8	<b>PASS</b>
2437 MHz	-9	8	<b>PASS</b>
2462 MHz	-9.011	8	<b>PASS</b>

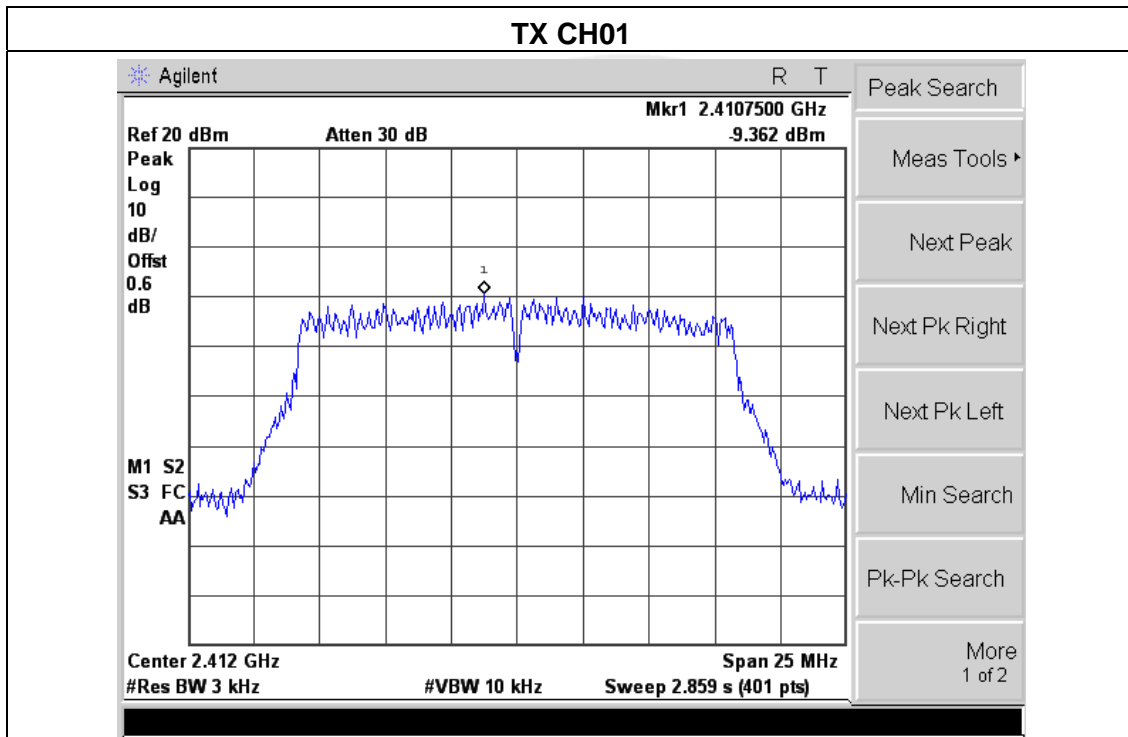

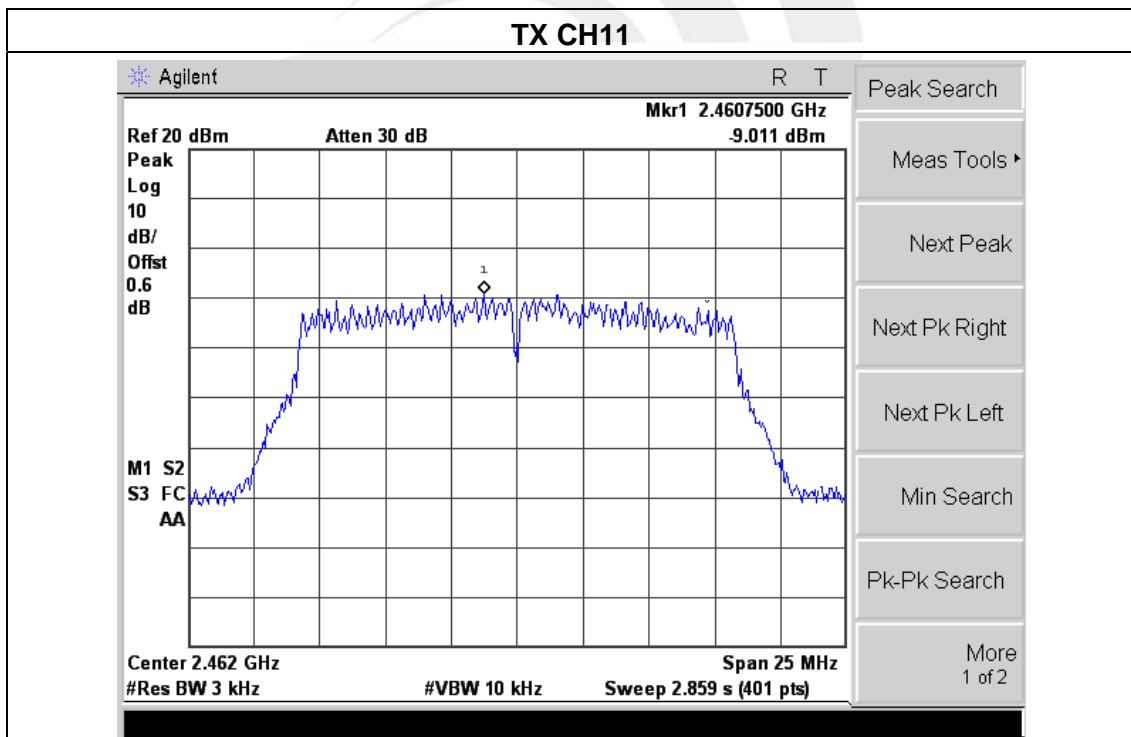
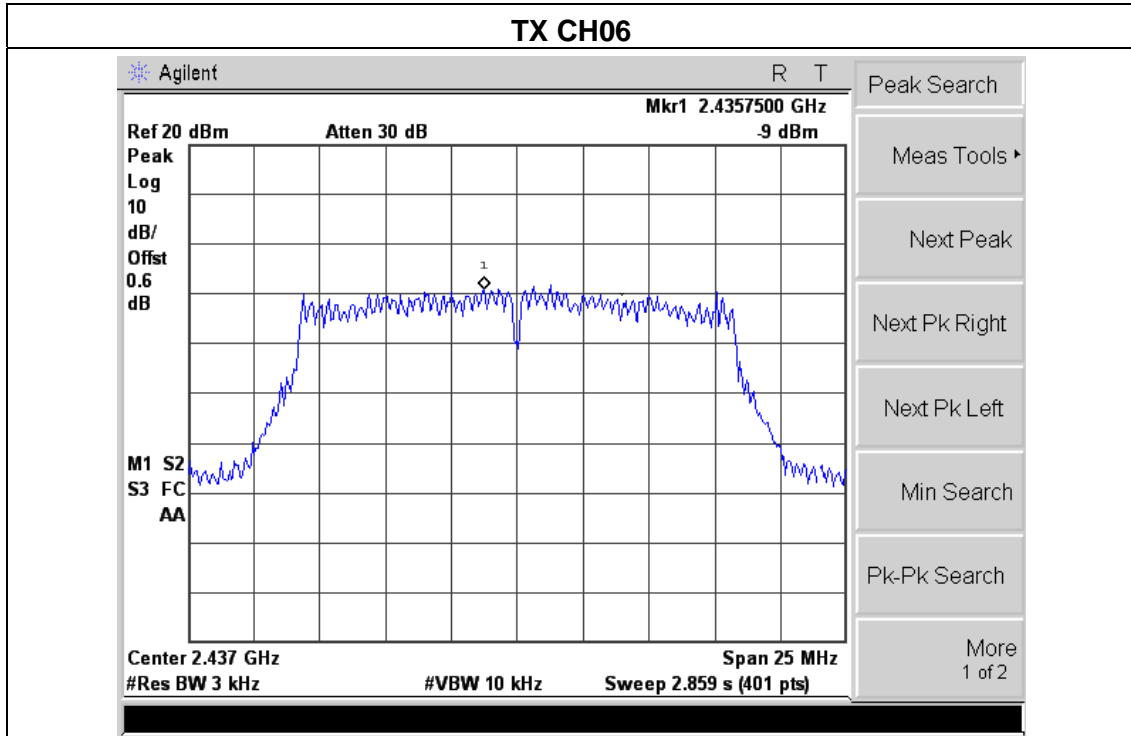



EUT :	Smart Phone	Model Name :	A2
Temperature :	25 °C	Relative Humidity :	60%
Pressure :	1015 hPa	Test Voltage :	DC 5V from Adapter with AC 120V/60Hz
Test Mode :	TX n Mode(20M) /CH01, CH06, CH11		

Frequency	Power Density (dBm)	Limit (dBm)	Result
2412 MHz	-9.121	8	<b>PASS</b>
2437 MHz	-8.697	8	<b>PASS</b>
2462 MHz	-9.249	8	<b>PASS</b>

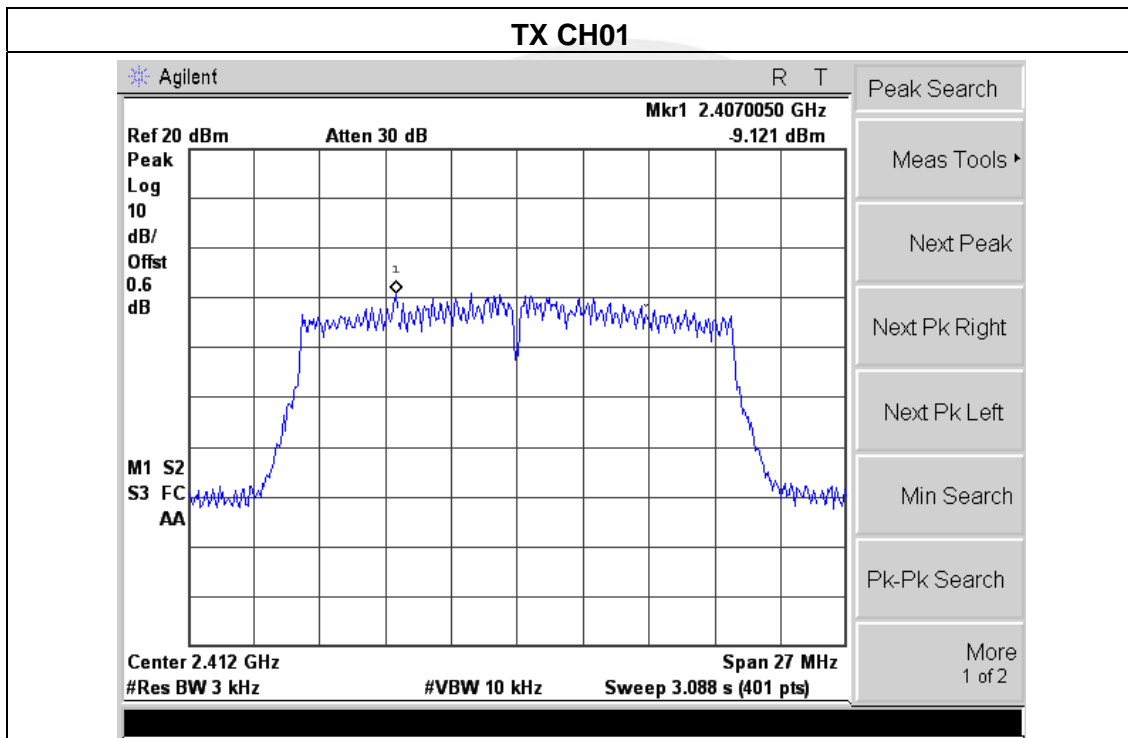

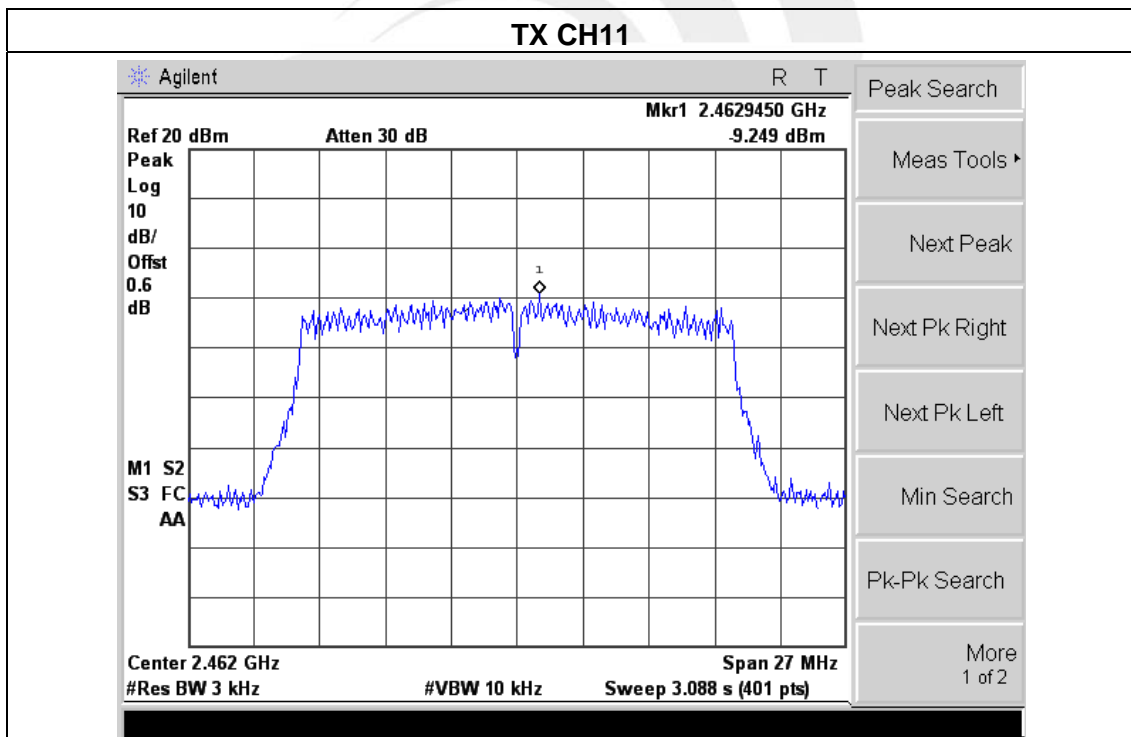
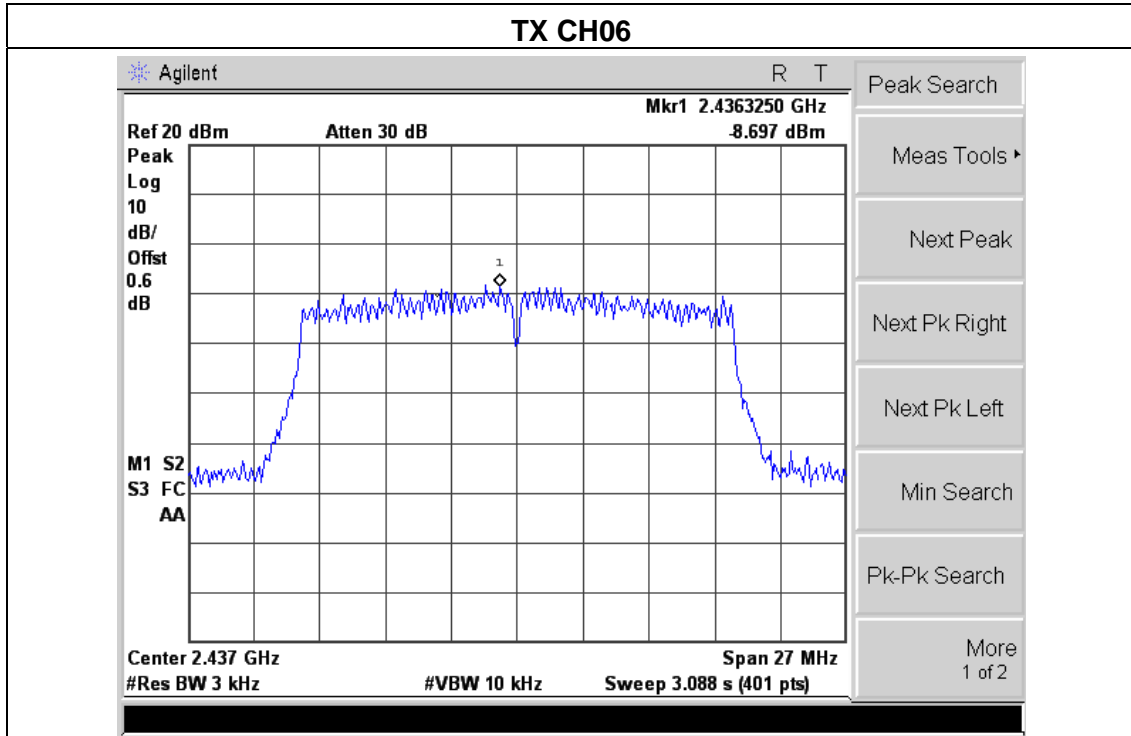



EUT :	Smart Phone	Model Name :	A2
Temperature :	25 °C	Relative Humidity :	60%
Pressure :	1015 hPa	Test Voltage :	DC 5V from Adapter with AC 120V/60Hz
Test Mode :	TX n Mode(40M) /CH03, CH06, CH09		

Frequency	Power Density (dBm)	Limit (dBm)	Result
2422 MHz	-15.57	8	PASS
2437 MHz	-13.97	8	PASS
2452 MHz	-13.97	8	PASS

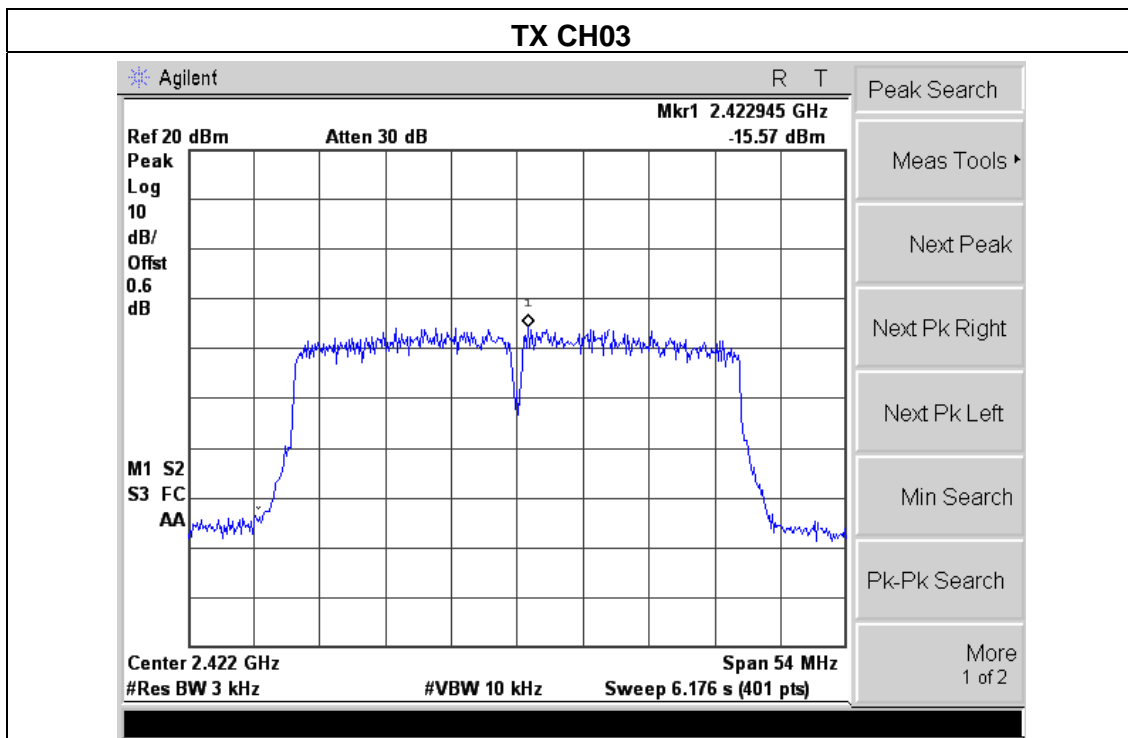

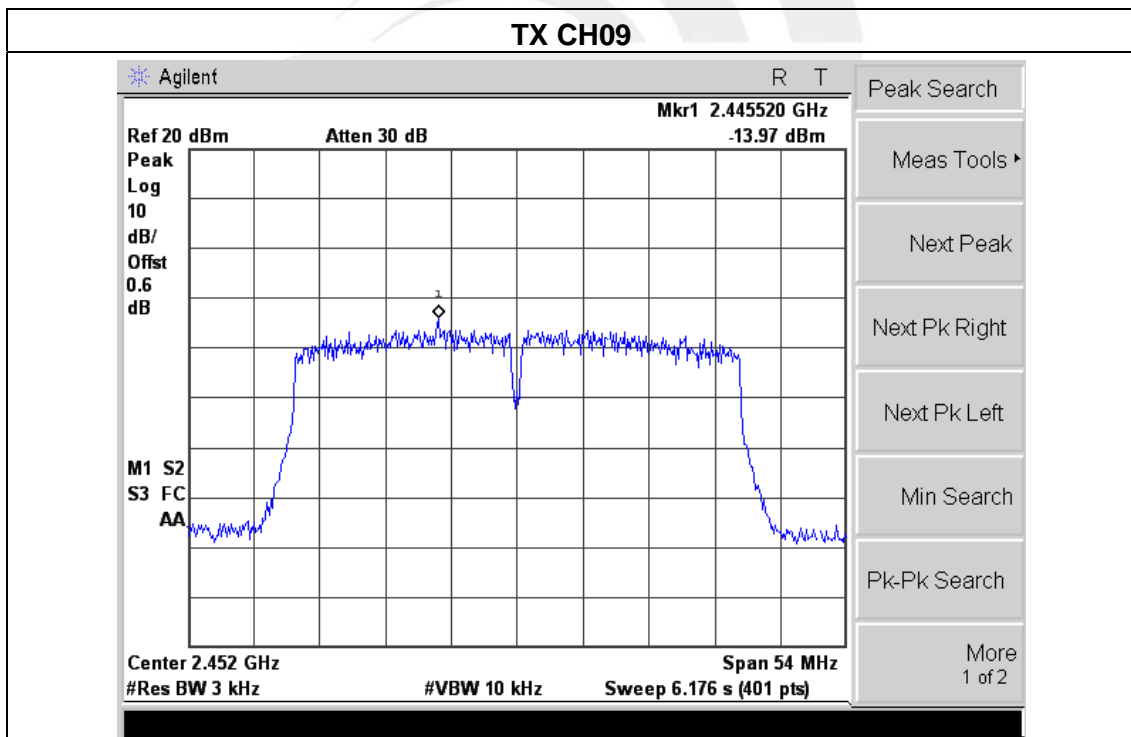
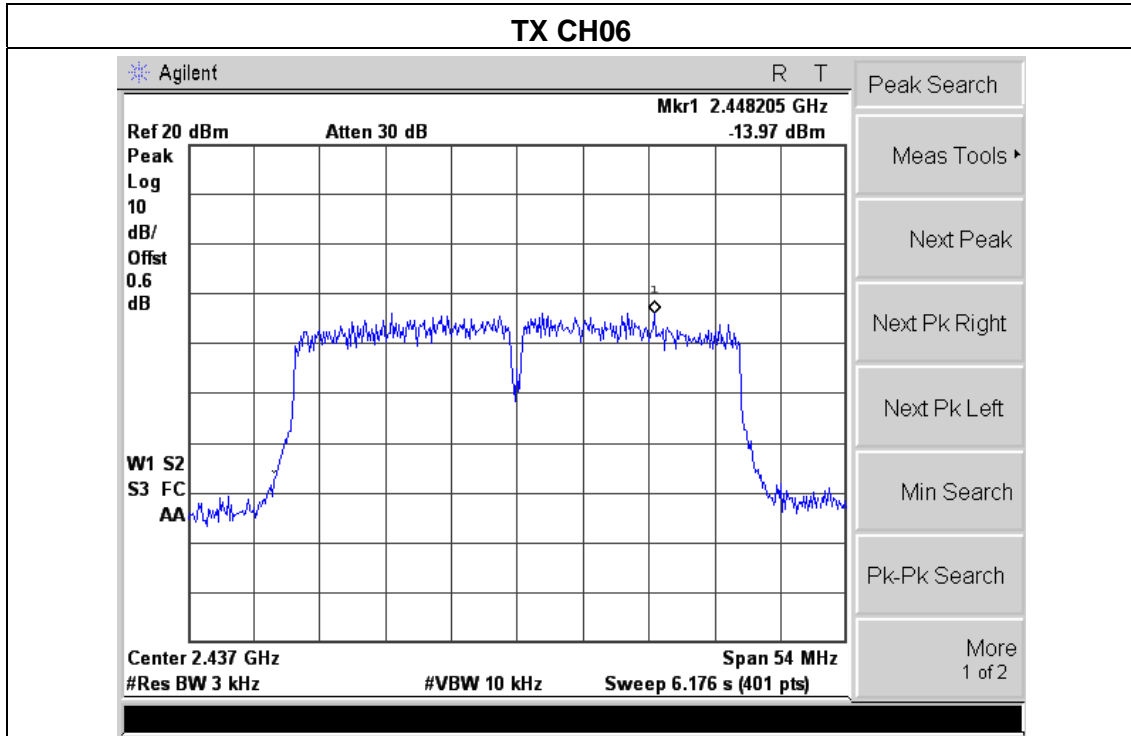

## 6. BANDWIDTH TEST

### 6.1 APPLIED PROCEDURES / LIMIT

FCC Part15 (15.247) , Subpart C				
Section	Test Item	Limit	Frequency Range (MHz)	Result
15.247(a)(2)	Bandwidth	$\geq 500\text{KHz}$ (6dB bandwidth)	2400-2483.5	PASS

### 6.2 TEST PROCEDURE

1. Set RBW = 100 kHz.
2. Set the video bandwidth (VBW)  $\geq 3 \times$  RBW.
3. Detector = Peak.
4. Trace mode = max hold.
5. Sweep = auto couple.
6. Allow the trace to stabilize.
7. Measure the maximum width of the emission that is constrained by the frequencies associated with the two outermost amplitude points (upper and lower frequencies) that are attenuated by 6 dB relative to the maximum level measured in the fundamental emission.

### 6.3 DEVIATION FROM STANDARD

No deviation.

### 6.4 TEST SETUP



### 6.5 EUT OPERATION CONDITIONS

The EUT tested system was configured as the statements of 2.3 Unless otherwise a special operating condition is specified in the follows during the testing.



6.6 TEST RESULTS

EUT :	Smart Phone	Model Name :	A2
Temperature :	25 °C	Relative Humidity :	60%
Pressure :	1012 hPa	Test Voltage :	DC 5V from Adapter with AC 120V/60Hz
Test Mode :	TX b Mode /CH01, CH06, CH11		

Frequency	6dB Bandwidth (MHz)	Channel Separation (MHz)	Result
2412 MHz	10.0500	>=500KHz	<b>PASS</b>
2437 MHz	10.0500	>=500KHz	<b>PASS</b>
2462 MHz	10.0500	>=500KHz	<b>PASS</b>

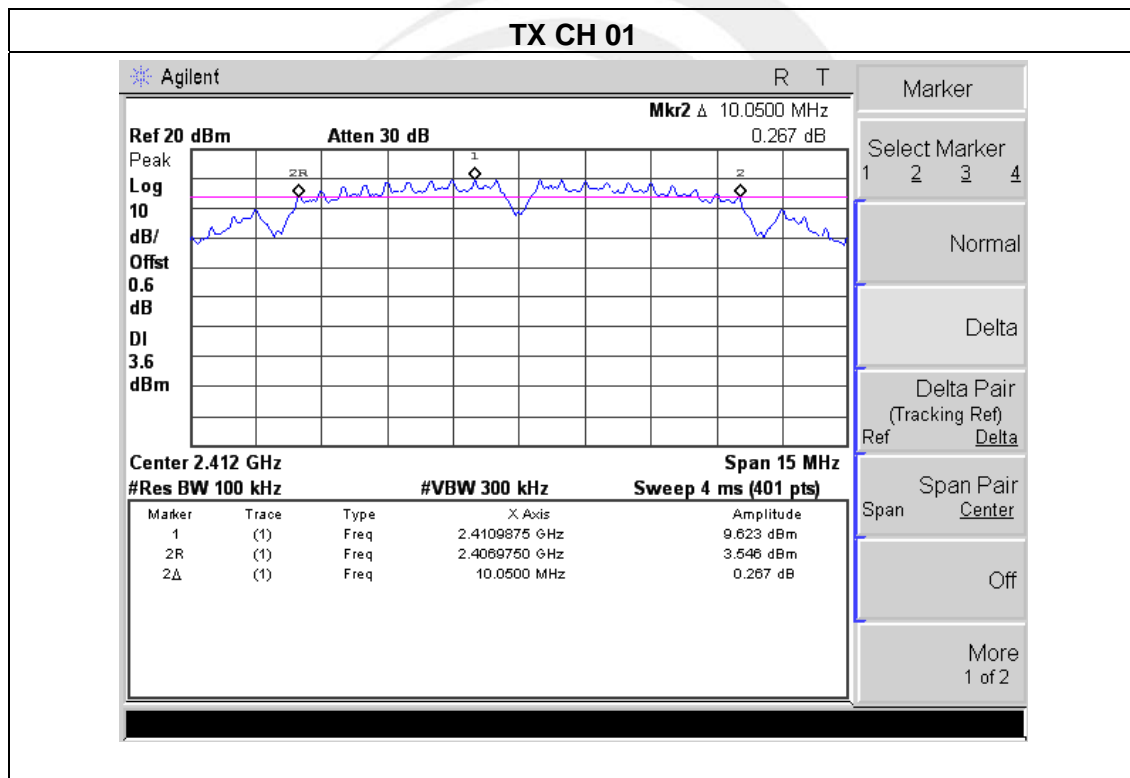



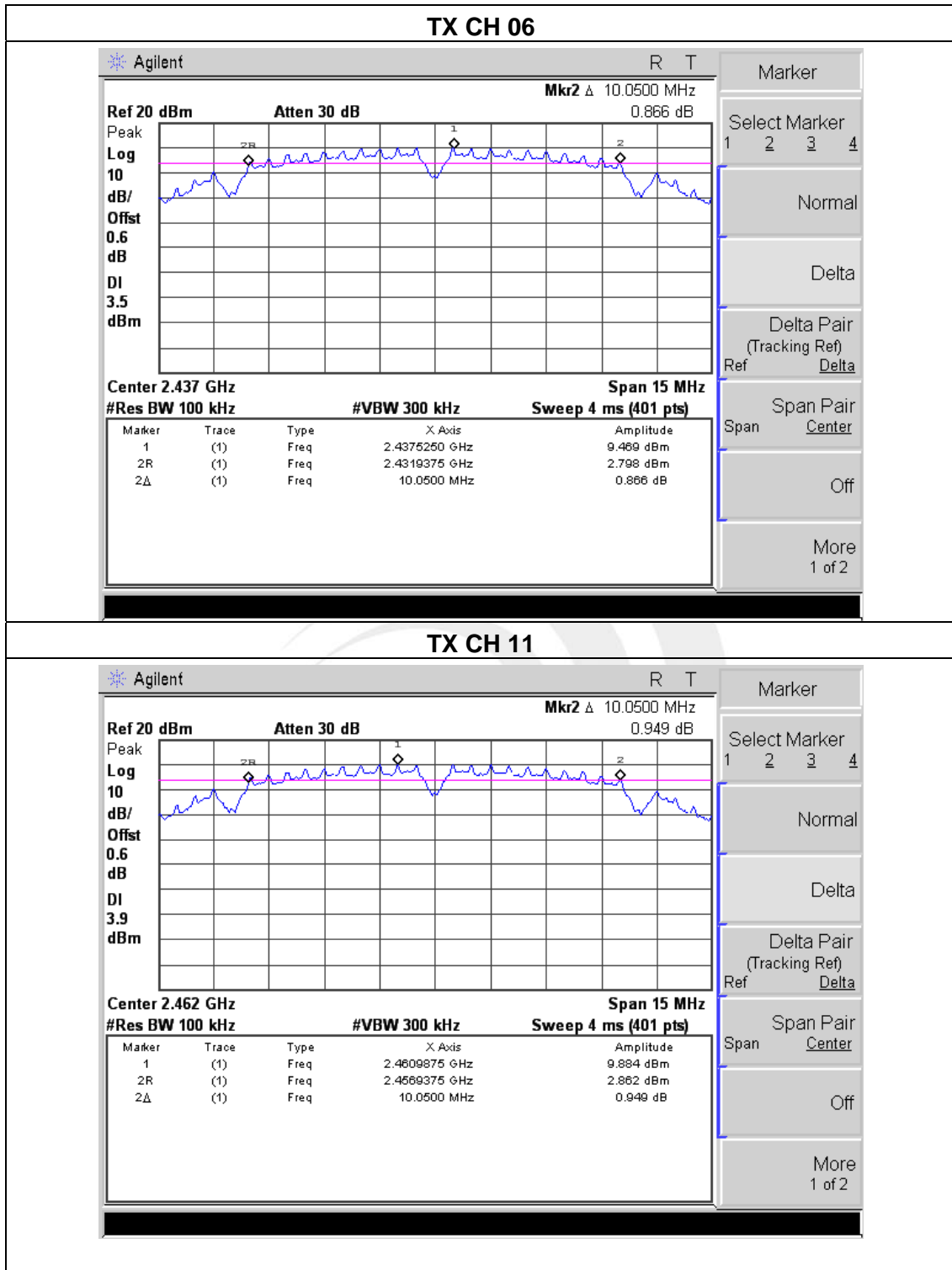

Agilent
R T

**Mkr2** Δ 10.0500 MHz  
0.949 dB

Ref 20 dBm
Atten 30 dB

Center 2.462 GHz
Span 15 MHz

#Res BW 100 kHz
#VBW 300 kHz
Sweep 4 ms (401 pts)

Marker	Trace	Type	X Axis	Amplitude
1	(1)	Freq	2.4609875 GHz	9.884 dBm
2R	(1)	Freq	2.4569375 GHz	2.882 dBm
2Δ	(1)	Freq	10.0500 MHz	0.949 dB

Marker

Select Marker  
1 2 3 4

Normal

Delta

Delta Pair  
(Tracking Ref)  
Ref Delta

Span Pair  
Span Center

Off

More  
1 of 2



EUT :	Smart Phone	Model Name :	A2
Temperature :	25 °C	Relative Humidity :	60%
Pressure :	1012 hPa	Test Voltage :	DC 5V from Adapter with AC 120V/60Hz
Test Mode :	TX g Mode /CH01, CH06, CH11		

Frequency	6dB Bandwidth (MHz)	Channel Separation (MHz)	Result
2412 MHz	16.02	>=500KHz	<b>PASS</b>
2437 MHz	16.02	>=500KHz	<b>PASS</b>
2462 MHz	16.02	>=500KHz	<b>PASS</b>

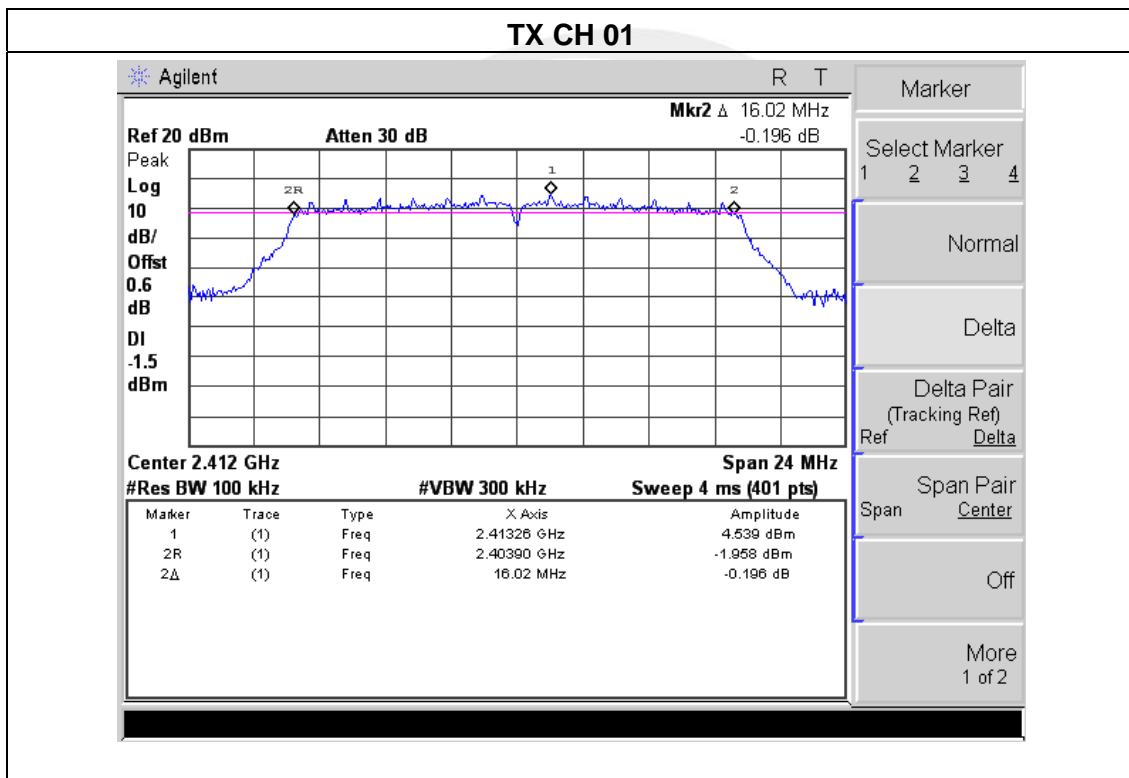

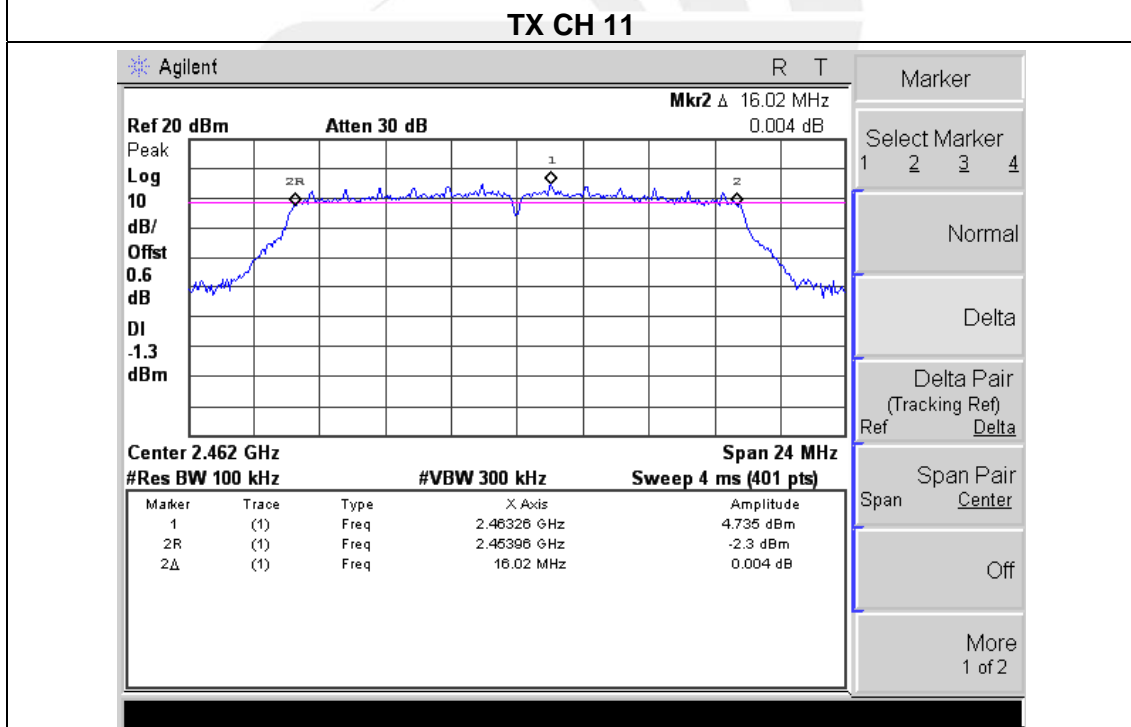
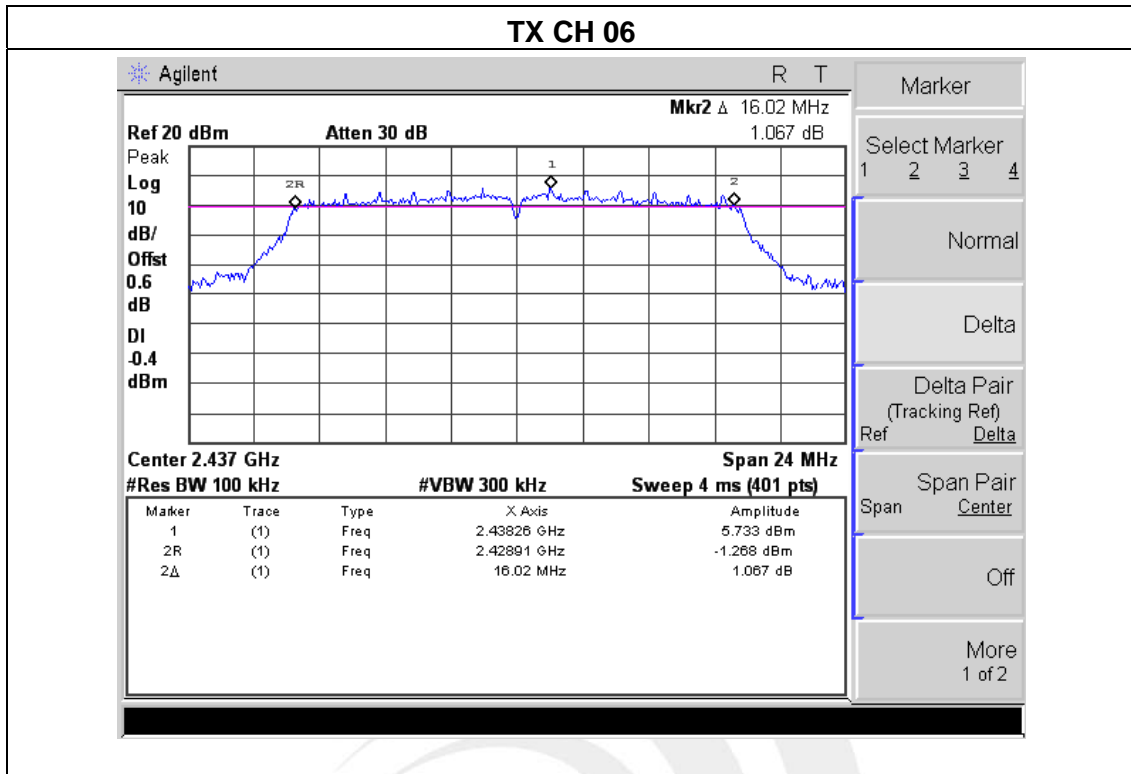



EUT :	Smart Phone	Model Name :	A2
Temperature :	25 °C	Relative Humidity :	60%
Pressure :	1012 hPa	Test Voltage :	DC 5V from Adapter with AC 120V/60Hz
Test Mode :	TX n Mode(20M) /CH01, CH06, CH11		

Frequency	6dB Bandwidth (MHz)	Channel Separation (MHz)	Result
2412 MHz	17.030	>=500KHz	<b>PASS</b>
2437 MHz	17.160	>=500KHz	<b>PASS</b>
2462 MHz	17.290	>=500KHz	<b>PASS</b>

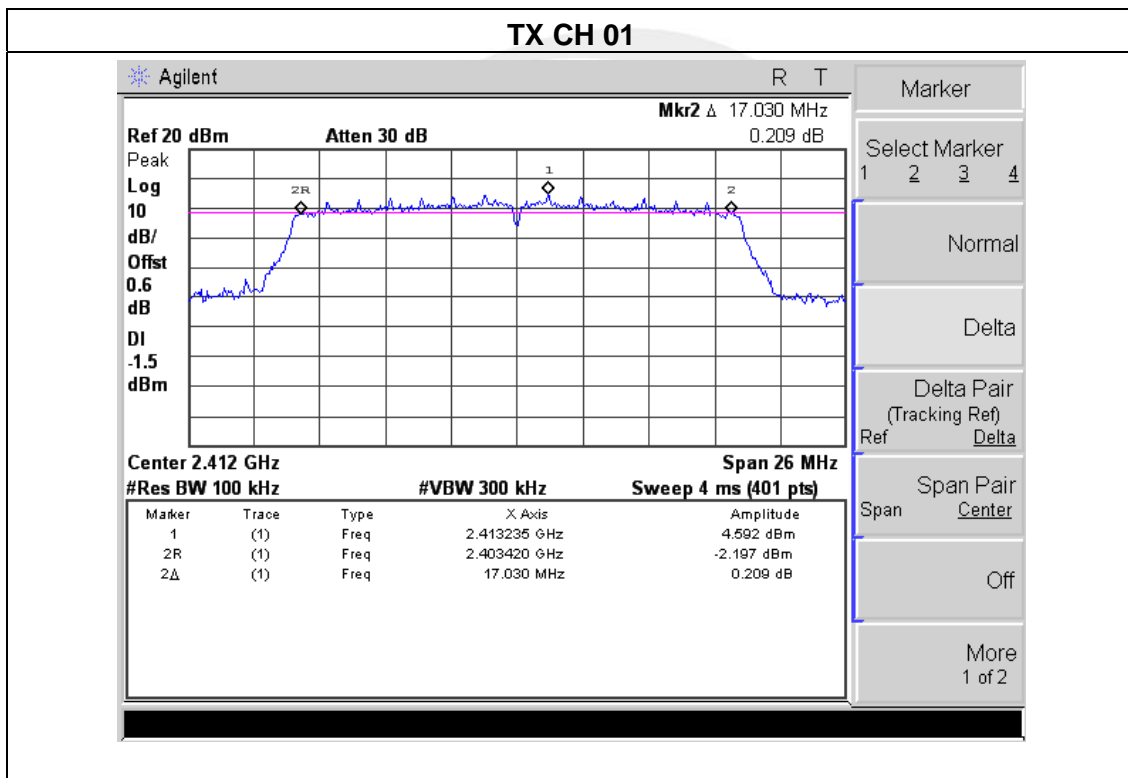

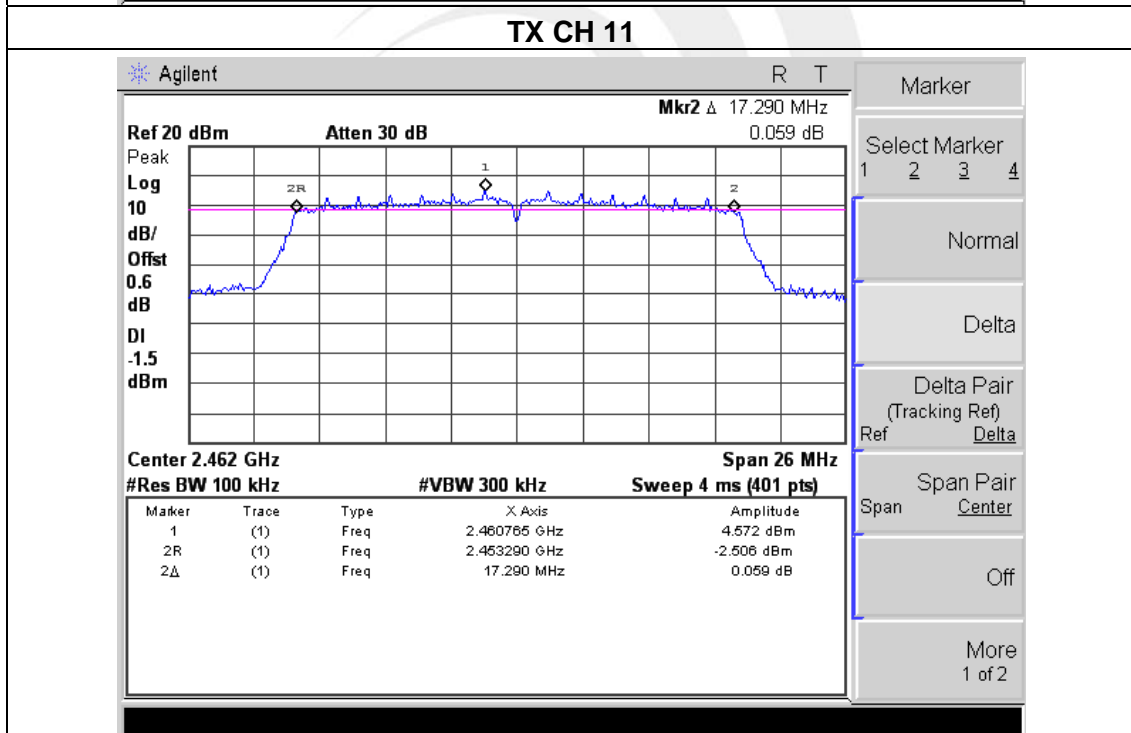
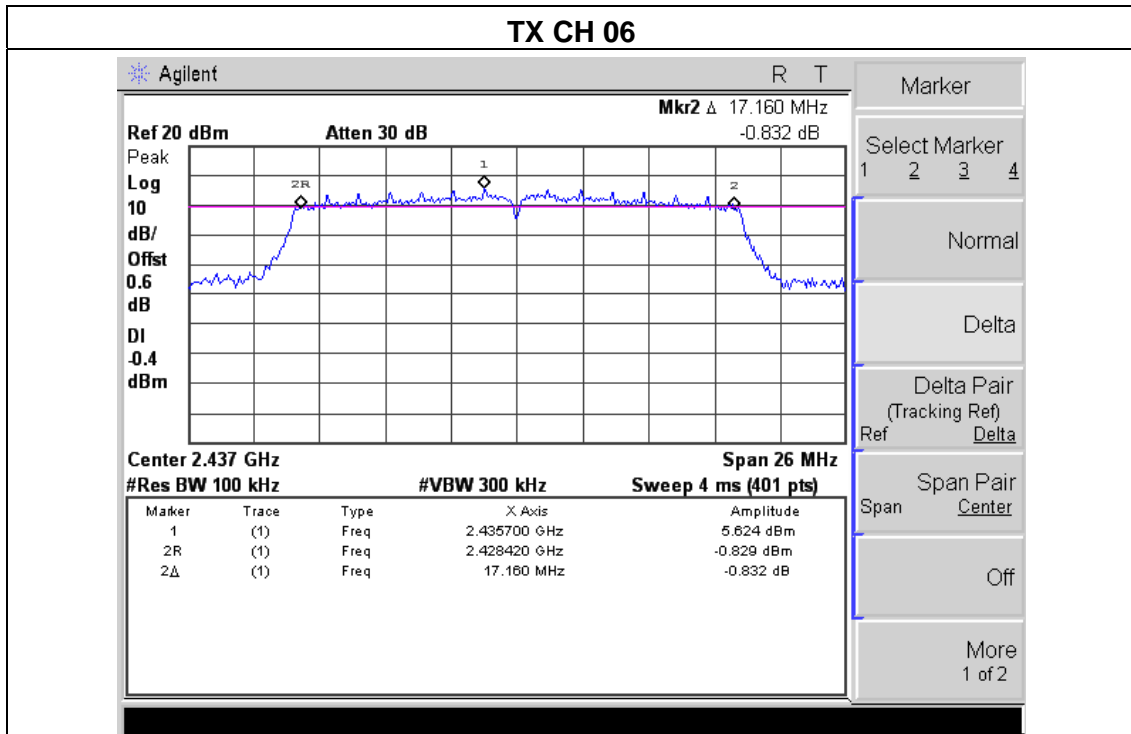



EUT :	Smart Phone	Model Name :	A2
Temperature :	25 °C	Relative Humidity :	60%
Pressure :	1012 hPa	Test Voltage :	DC 5V from Adapter with AC 120V/60Hz
Test Mode :	TX n Mode(40M) /CH03, CH06, CH09		

Frequency	6dB Bandwidth (MHz)	Channel Separation (MHz)	Result
2422 MHz	35.640	>=500KHz	<b>PASS</b>
2437 MHz	35.640	>=500KHz	<b>PASS</b>
2452 MHz	35.640	>=500KHz	<b>PASS</b>

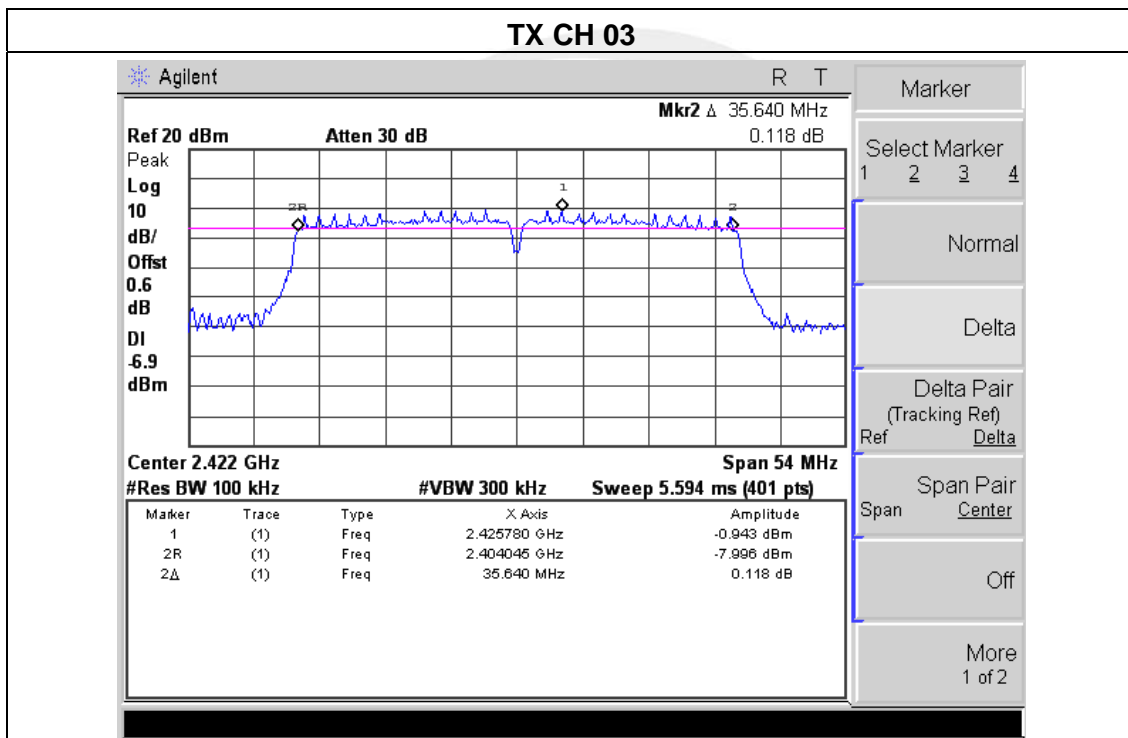

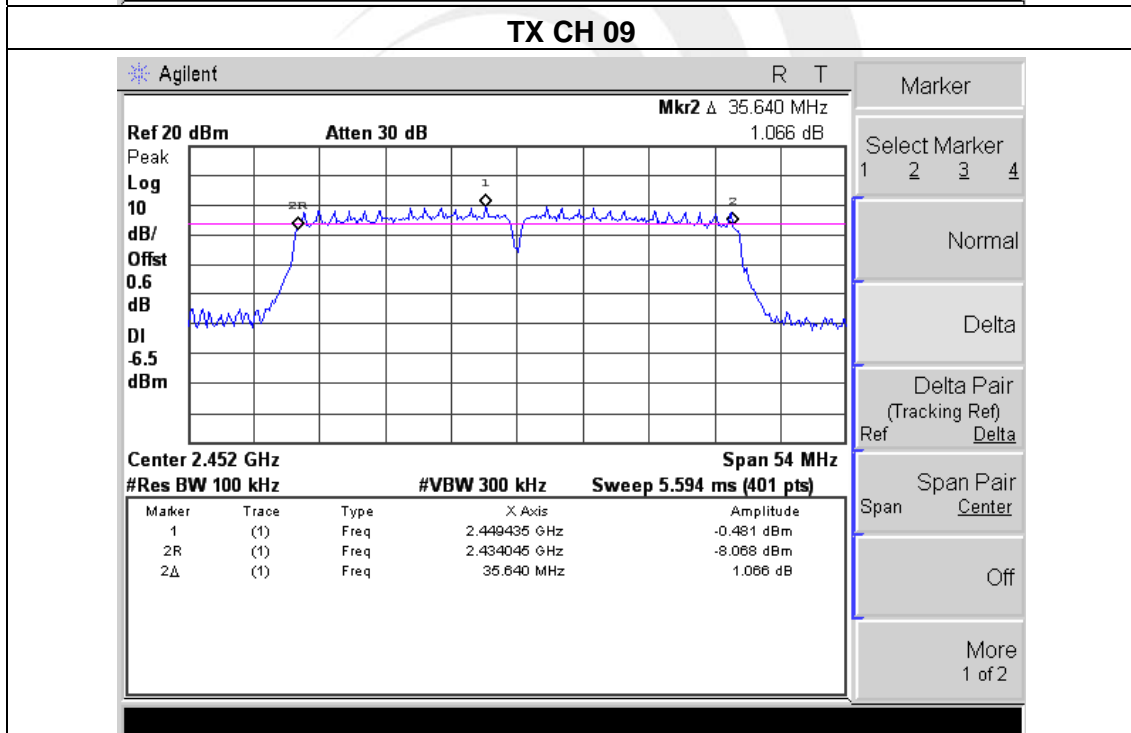
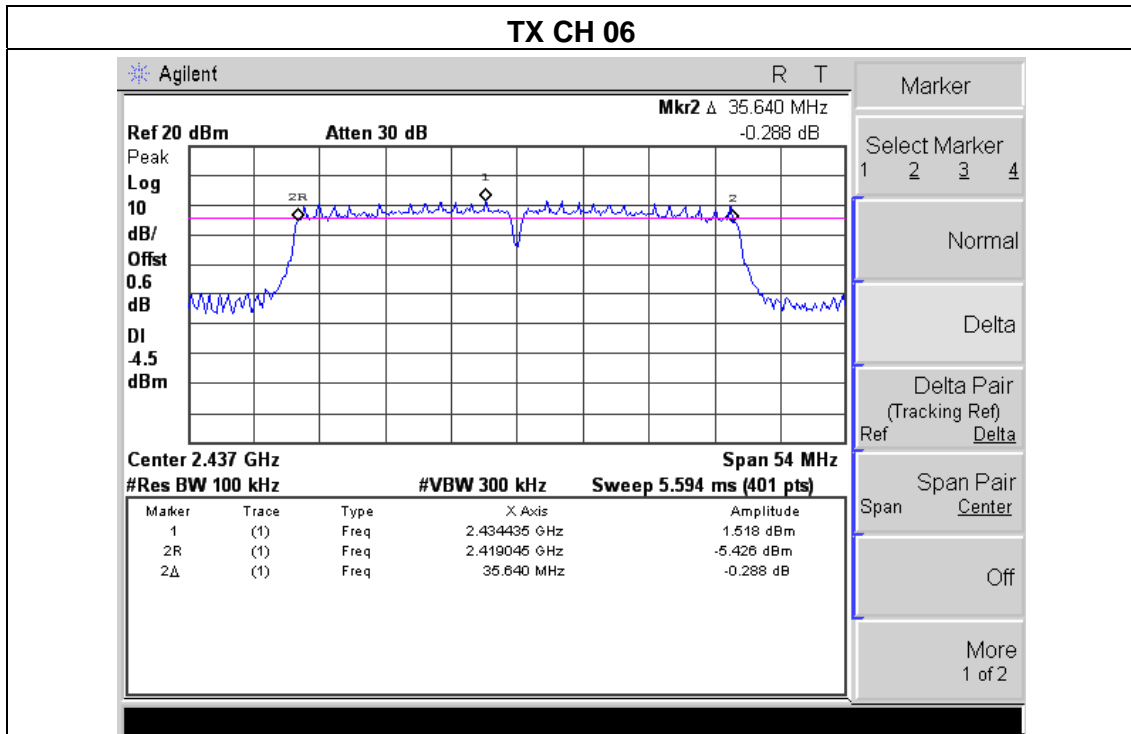



## 7. PEAK OUTPUT POWER TEST

### 7.1 APPLIED PROCEDURES / LIMIT

FCC Part15 (15.247) , Subpart C				
Section	Test Item	Limit	Frequency Range (MHz)	Result
15.247(b)(3)	Peak Output Power	1 watt or 30dBm	2400-2483.5	PASS

### 7.2 TEST PROCEDURE

- a. The EUT was directly connected to the Power Sensor&Power meter

### 7.3 DEVIATION FROM STANDARD

No deviation.

### 7.4 TEST SETUP



### 7.4 EUT OPERATION CONDITIONS

The EUT tested system was configured as the statements of 2.3 Unless otherwise a special operating condition is specified in the follows during the testing.





## 7.5 TEST RESULTS

EUT :	Smart Phone	Model Name :	A2
Temperature :	25 °C	Relative Humidity :	60%
Pressure :	1012 hPa	Test Voltage :	DC 5V from Adapter with AC 120V/60Hz
Test Mode :	TX b/g/n(20M,40M) Mode /CH01, CH06, CH11		

TX 802.11b Mode			
Test Channel	Frequency	Peak Conducted Output Power	LIMIT
	(MHz)	(dBm)	dBm
CH01	2412	17.44	30
CH06	2437	17.90	30
CH11	2462	17.90	30

TX 802.11g Mode			
Test Channel	Frequency	Peak Conducted Output Power	LIMIT
	(MHz)	(dBm)	dBm
CH01	2412	13.70	30
CH06	2437	14.94	30
CH11	2462	13.72	30

TX 802.11n20 Mode			
Test Channel	Frequency	Peak Conducted Output Power	LIMIT
	(MHz)	(dBm)	dBm
CH01	2412	13.15	30
CH06	2437	14.50	30
CH11	2462	13.89	30

TX 802.11n40 Mode			
Test Channel	Frequency	Peak Conducted Output Power	LIMIT
	(MHz)	(dBm)	dBm
CH03	2422	10.96	30
CH06	2437	11.30	30
CH09	2452	11.12	30



## 8. ANTENNA REQUIREMENT

### 8.1 STANDARD REQUIREMENT

15.203 requirement: For intentional device, according to 15.203: an intentional radiator shall be designed to ensure that no antenna other than that furnished by the responsible party shall be used with the device.

### 8.2 EUT ANTENNA

The EUT antenna is PIFA Antenna. It comply with the standard requirement.



APPENDIX - PHOTOS OF TEST SETUP

**Radiated Measurement Photos**

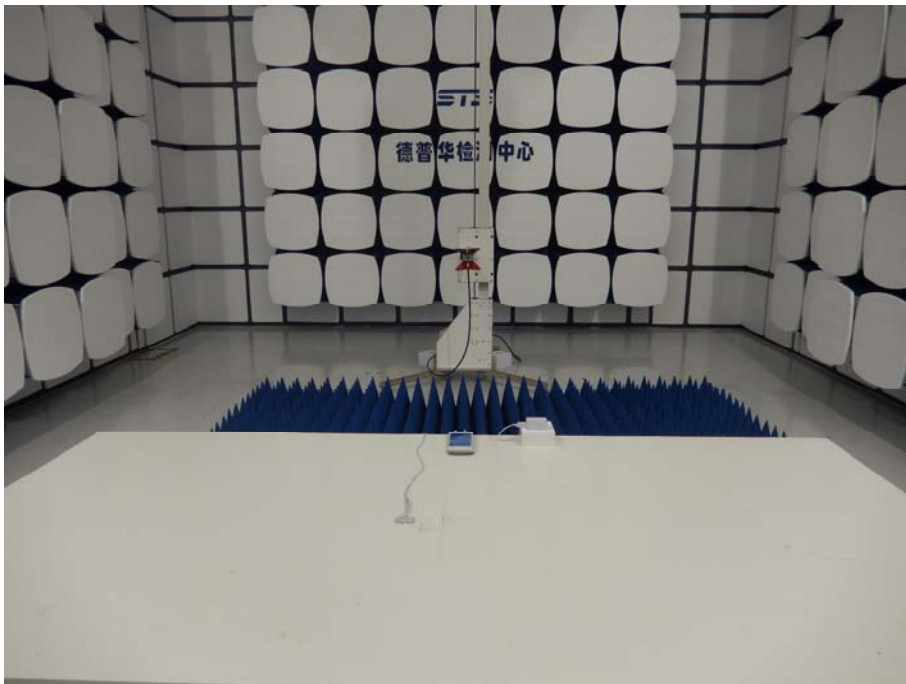
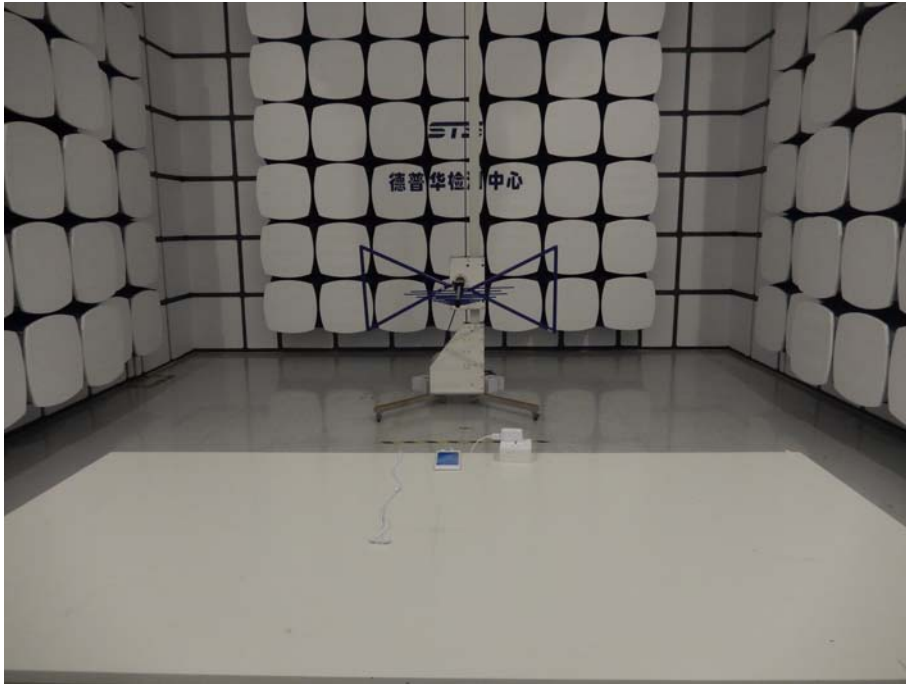

### Conducted Measurement Photos

