

S

T

S

L

A

B



---

## FCC PART 15B REPORT

---

Report No: STS1412058E01

Issued for

MOVILTELCO TRADE, S.L.

Street: ABTAO, 25-1 Floor A-office MADRID, Spain

Product Name:	Smart Phone
Brand Name:	MTT
Model No.:	A071
Series Model:	A71,A051,A061,A081
FCC ID:	2ACQKTELCO005
Test Standard:	FCC Part 15B

Any reproduction of this document must be done in full. No single part of this document may be reproduced without permission from STS, All Test Data Presented in this report is only applicable to presented Test sample.





### TEST RESULT CERTIFICATION

**Applicant's name** ..... MOVILTELCO TRADE, S.L.  
**Address** ..... Street: ABTAO, 25-1 Floor A-office MADRID, Spain  
**Manufacture's Name** ..... OTOT Group  
**Address** ..... The third Industrial Zone, Jiuwei, Yusheng Industrial Park, Xixiang, Baoan District, Shenzhen City, China

**Product description**  
**Product name** ..... Smart Phone  
**Band name** ..... MTT  
**Model and/or type reference**..... A071

**Standards** ..... FCC Part 15B

**Test procedure**..... ANSI C63.4-2009

This device described above has been tested by STS, and the test results show that the equipment under test (EUT) is in compliance with the FCC requirements. And it is applicable only to the tested sample identified in the report.

This report shall not be reproduced except in full, without the written approval of STS, this document may be altered or revised by STS, personal only, and shall be noted in the revision of the document.

**Date of Test** .....

**Date of performance of tests** ..... 22 Dec. 2014 ~29 Dec. 2014  
**Date of Issue** ..... 30 Dec. 2014  
**Test Result**..... Pass

Testing Engineer :   
 \_\_\_\_\_  
 (Tony Liu)

Technical Manager :   
 \_\_\_\_\_  
 (Vita Li)

Authorized Signatory :   
 \_\_\_\_\_  
 (Bovey Yang)





Table of Contents	Page
1. SUMMARY OF TEST RESULTS	4
1.1 TEST FACILITY	4
1.2 MEASUREMENT UNCERTAINTY	4
2. GENERAL INFORMATION	5
2.1 GENERAL DESCRIPTION OF EUT	5
2.2 DESCRIPTION OF TEST MODES	6
2.3 BLOCK DIGRAM SHOWING THE CONFIGURATION OF SYSTEM TESTED	6
2.4 DESCRIPTION OF SUPPORT UNITS	7
2.5 EQUIPMENTS LIST FOR ALL TEST ITEMS	8
3. EMC EMISSION TEST	9
3.1 CONDUCTED EMISSION MEASUREMENT	9
3.1.1 POWER LINE CONDUCTED EMISSION LIMITS	9
3.1.2 TEST PROCEDURE	10
3.1.3 DEVIATION FROM TEST STANDARD	10
3.1.4 TEST SETUP	10
3.1.5 EUT OPERATING CONDITIONS	10
3.1.6 TEST RESULTS	11
3.2 RADIATED EMISSION MEASUREMENT	13
3.2.1 RADIATED EMISSION LIMITS	13
3.2.2 TEST PROCEDURE	14
3.2.3 DEVIATION FROM TEST STANDARD	14
3.2.4 TEST SETUP	15
3.2.5 EUT OPERATING CONDITIONS	16
3.2.6 TEST RESULTS	17
4. PHOTOS OF TEST SETUP	21



## 1. SUMMARY OF TEST RESULTS

Test procedures according to the technical standards:

EMISSION			
Standard	Item	Result	Remarks
FCC 47 CFR Part 15 Subpart B (10-1-05 Edition)	Conducted Emission	PASS	Meet Class B limit
	Radiated Emission	PASS	Meet Class B limit

NOTE:

(1) "N/A" denotes test is not applicable in this Test Report

### 1.1 TEST FACILITY

Shenzhen STS Test Services Co., Ltd.

Add.: 1/F, Building 2, Zhuoke Science Park, Chongqing Road, Fuyong, Baoan District, Shenzhen, China.

FCC Registration No.: 842334; IC Registration No.: 12108A-1

### 1.2 MEASUREMENT UNCERTAINTY

The reported uncertainty of measurement  $y \pm U$ , where expanded uncertainty  $U$  is based on a standard uncertainty multiplied by a coverage factor of  $k=2$ , providing a level of confidence of approximately 95 %.

No.	Item	Uncertainty
1	Conducted Emission Test	$\pm 1.38\text{dB}$
2	RF power,conducted	$\pm 0.16\text{dB}$
3	Spurious emissions,conducted	$\pm 0.21\text{dB}$
4	All emissions,radiated(<1G)	$\pm 4.68\text{dB}$
5	All emissions,radiated(>1G)	$\pm 4.89\text{dB}$
6	Temperature	$\pm 0.5^{\circ}\text{C}$
7	Humidity	$\pm 2\%$



## 2. GENERAL INFORMATION

### 2.1 GENERAL DESCRIPTION OF EUT

Equipment	Smart Phone
Trade Name	MTT
Model Name	A071
Serial Model	A71,A051,A061,A081
Model Difference	Only different in model name
Channel List	Please refer to the Note 2.
Adapter	Input:AC 100-240V,50/60Hz,0.15A Output:DC 5V,500mA
Battery	Rated Voltage:3.7V Charge Limit: 4.2V capacity :1500mAh
Hardware version number	M715_MB_V3.0
Software versioning number	M715KK_mtt_T071E_V1.0_20141211
Connecting I/O Port(s)	Please refer to the User's Manual

Note:

1. For a more detailed features description, please refer to the manufacturer's specifications or the User's Manual.

## 2.2 DESCRIPTION OF TEST MODES

To investigate the maximum EMI emission characteristics generated from EUT, the test system was pre-scanning tested based on the consideration of following EUT operation mode or test configuration mode which possibly have effect on EMI emission level. Each of these EUT operation mode(s) or test configuration mode(s) mentioned above was evaluated respectively.

Pretest Mode	Description
Mode 1	USB Model
Mode 2	MP3/MP4 Mode
Mode 3	Idle Mode

For Conducted Emission	
Final Test Mode	Description
Mode1	USB Model

For Radiated Emission	
Final Test Mode	Description
Mode 1	USB Model

Note:

(1) Due to the different configuration and test, in this list only some worse mode. The worst test data of the worse modes is reported by this report.

## 2.3 BLOCK DIAGRAM SHOWING THE CONFIGURATION OF SYSTEM TESTED

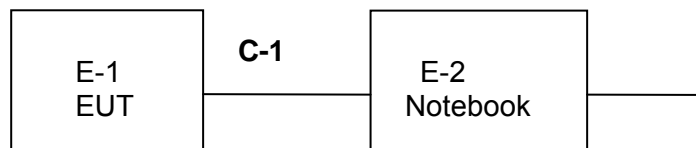



## 2.4 DESCRIPTION OF SUPPORT UNITS

The EUT has been tested as an independent unit together with other necessary accessories or support units. The following support units or accessories were used to form a representative test configuration during the tests.

Item	Equipment	Mfr/Brand	Model/Type No.	Series No.	Note
E-1	Smart Phone	MTT	A071	N/A	EUT
E-2	Notebook	Lenovo	B460	WB03928113	

Item	Shielded Type	Ferrite Core	Length	Note
C-1	NO	NO	0.5m	
C-2	NO	NO	1.2m	

Note:

- (1) The support equipment was authorized by Declaration of Confirmation.
- (2) For detachable type I/O cable should be specified the length in cm in 『Length』 column.
- (3) “YES” is means “shielded” “with core”; “NO” is means “unshielded” “without core”.



## 2.5 EQUIPMENTS LIST FOR ALL TEST ITEMS

The EUT has been tested as an independent unit together with other necessary accessories or support units. The following support units or accessories were used to form a representative test configuration during the tests.

### Radiation Test equipment

Kind of Equipment	Manufacturer	Type No.	Serial No.	Last Calibration	Calibrated Until
Universal Radio Communication Tester	R&S	CMU200	112012	2014.10.25	2015.10.24
Bilog Antenna	TESEQ	CBL6111D	34678	2014.10.25	2015.10.24
Test Cable	N/A	R-01	N/A	2014.10.25	2015.10.24
Test Cable	N/A	R-02	N/A	2014.10.25	2015.10.24
EMI Test Receiver	R&S	ESCI	101427	2014.10.25	2015.10.24
Antenna Mast	EM	SC100_1	N/A	N/A	N/A
Turn Table	EM	SC100	060531	N/A	N/A
50Ω Switch	Anritsu Corp	MP59B	6200983705	2014.07.06	2015.07.05
Spectrum Analyzer	Aglient	E4407B	MY50140340	2014.10.25	2015.10.24
Horn Antenna	Schwarbeck	BBHA 9120D	9120D-963	2014.10.25	2015.10.24
Pre-Amplifier	DASY 5	NO. WL-42W	9638	2014.10.25	2015.10.24

### Conduction Test equipment

Kind of Equipment	Manufacturer	Type No.	Serial No.	Last Calibration	Calibrated Until
EMI Test Receiver	R&S	ESPI	102086	2014.10.25	2015.10.24
LISN	R&S	ENV216	101242	2014.10.25	2015.10.24
LISN	EMCO	3810/2NM	000-23625	2014.10.25	2015.10.24
Absorbing clamp	R&S	MDS-21	100668	2014.10.27	2015.10.26
Temperature & Humidity Chamber	Mieo	HH660	N/A	2014.10.27	2015.10.26
Conduction Cable	EM	C01	N/A	2014.10.25	2015.10.24
Clamp Cable	EM	C02	N/A	2014.10.25	2015.10.24





### 3. EMC EMISSION TEST

#### 3.1 CONDUCTED EMISSION MEASUREMENT

##### 3.1.1 POWER LINE CONDUCTED EMISSION Limits

FREQUENCY (MHz)	Class A (dBuV)		Class B (dBuV)		Standard
	Quasi-peak	Average	Quasi-peak	Average	
0.15 -0.5	79.00	66.00	66 - 56 *	56 - 46 *	CISPR
0.50 -5.0	73.00	60.00	56.00	46.00	CISPR
5.0 -30.0	73.00	60.00	60.00	50.00	CISPR

0.15 -0.5	79.00	66.00	66 - 56 *	56 - 46 *	FCC
0.50 -5.0	73.00	60.00	56.00	46.00	FCC
5.0 -30.0	73.00	60.00	60.00	50.00	FCC

Note:

- (1) The tighter limit applies at the band edges.
- (2) The limit of " \* " marked band means the limitation decreases linearly with the logarithm of the frequency in the range.

The following table is the setting of the receiver

Receiver Parameters	Setting
Attenuation	10 dB
Start Frequency	0.15 MHz
Stop Frequency	30 MHz
IF Bandwidth	9 kHz

### 3.1.2 TEST PROCEDURE

- a. The EUT was placed 0.4 meters from the horizontal ground plane with EUT being connected to the power mains through a line impedance stabilization network (LISN). All other support equipments powered from additional LISN(s). The LISN provide 50 Ohm/ 50uH of coupling impedance for the measuring instrument.
- b. Interconnecting cables that hang closer than 40 cm to the ground plane shall be folded back and forth in the center forming a bundle 30 to 40 cm long.
- c. I/O cables that are not connected to a peripheral shall be bundled in the center. The end of the cable may be terminated, if required, using the correct terminating impedance. The overall length shall not exceed 1 m.
- d. LISN at least 80 cm from nearest part of EUT chassis.
- e. For the actual test configuration, please refer to the related Item –EUT Test Photos.

### 3.1.3 DEVIATION FROM TEST STANDARD

No deviation

### 3.1.4 TEST SETUP

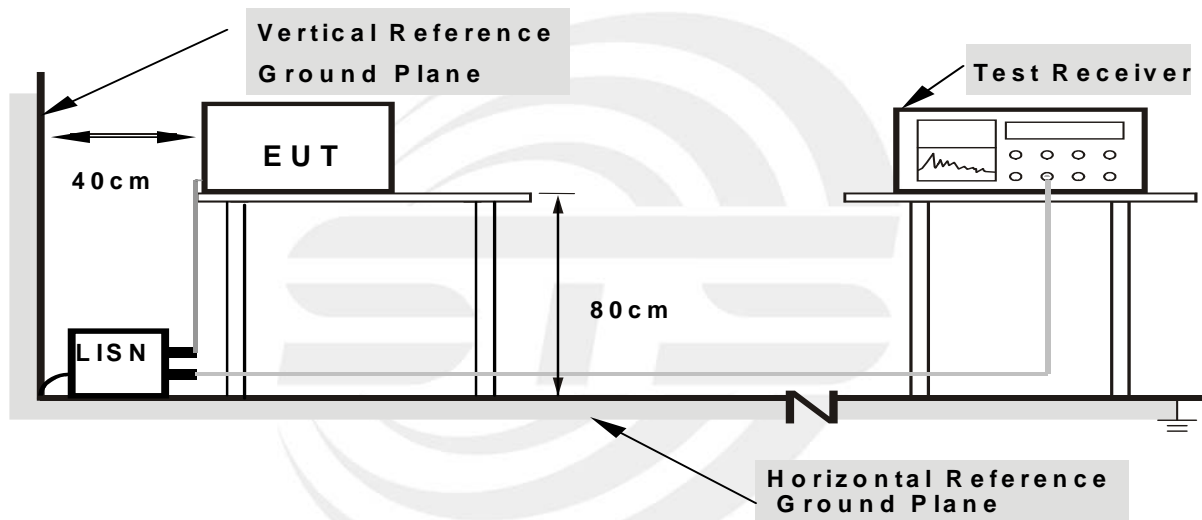

- Note: 1.Support units were connected to second LISN.**  
**2.Both of LISNs (AMN) are 80 cm from EUT and at least 80 from other units and other metal planes**

### 3.1.5 EUT OPERATING CONDITIONS

The EUT was configured for testing in a typical fashion (as a customer would normally use it). The EUT has been programmed to continuously transmit during test. This operating condition was tested and used to collect the included data.



3.1.6 TEST RESULTS

EUT :	Smart Phone	Model Name. :	A071
Temperature :	26 °C	Relative Humidity :	54%
Pressure :	1010hPa	Phase :	L
Test Voltage :	DC 5V from Adapter with AC 120V/60Hz	Test Mode :	1

Frequency (MHz)	Reading (dBuV)	Correct Factor(dB)	Result (dBuV)	Limit (dBuV)	Margin (dB)	Remark
0.1565	49.52	1.22	50.74	65.65	-14.91	QP
0.1565	30.27	1.22	31.49	55.65	-24.16	AVG
0.1980	51.73	0.80	52.53	63.69	-11.16	QP
0.1980	33.66	0.80	34.46	53.69	-19.23	AVG
0.2420	46.62	0.80	47.42	62.03	-14.61	QP
0.2420	30.99	0.80	31.79	52.03	-20.24	AVG
4.3220	40.29	1.00	41.29	56.00	-14.71	QP
4.3220	22.46	1.00	23.46	46.00	-22.54	AVG
13.0220	38.81	1.00	39.81	60.00	-20.19	QP
13.0220	25.62	1.00	26.62	50.00	-23.38	AVG
16.7780	39.20	1.00	40.20	60.00	-19.80	QP
16.7780	31.89	1.00	32.89	50.00	-17.11	AVG

Remark:

1. Factor = Antenna Factor + Cable Loss – Pre-amplifier.

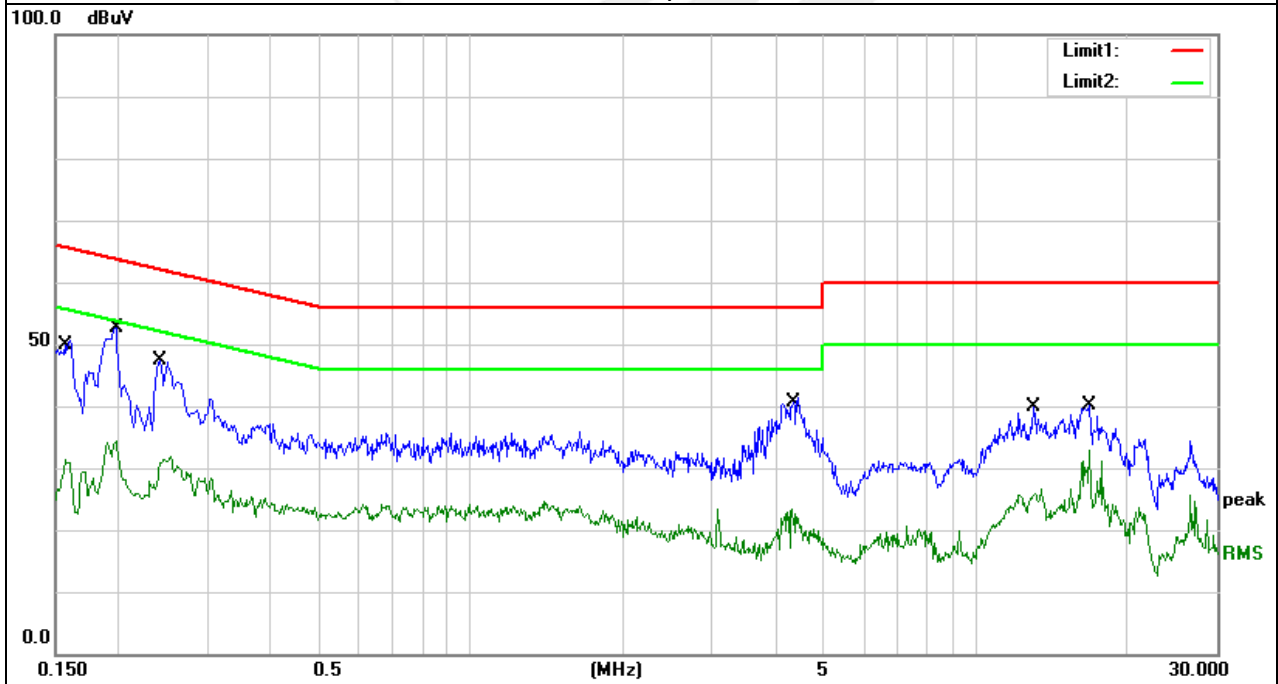



EUT :	Smart Phone	Model Name. :	A071
Temperature :	26 °C	Relative Humidity :	54%
Pressure :	1010hPa	Phase :	N
Test Voltage :	DC 5V from Adapter with AC 120V/60Hz	Test Mode :	1

Frequency (MHz)	Reading (dBUV)	Correct Factor(dB)	Result (dBUV)	Limit (dBUV)	Margin (dB)	Remark
0.1580	51.03	1.04	52.07	65.57	-13.50	QP
0.1580	29.61	1.04	30.65	55.57	-24.92	AVG
0.1860	52.45	0.80	53.25	64.21	-10.96	QP
0.1860	38.54	0.80	39.34	54.21	-14.87	AVG
0.2430	46.49	0.80	47.29	61.99	-14.70	QP
0.2430	36.33	0.80	37.13	51.99	-14.86	AVG
0.3780	43.44	0.80	44.24	58.32	-14.08	QP
0.3780	30.37	0.80	31.17	48.32	-17.15	AVG
11.5260	37.87	1.00	38.87	60.00	-21.13	QP
11.5260	25.20	1.00	26.20	50.00	-23.80	AVG
14.7780	38.40	1.00	39.40	60.00	-20.60	QP
14.7780	25.91	1.00	26.91	50.00	-23.09	AVG

Remark:

1. Factor = Antenna Factor + Cable Loss – Pre-amplifier.

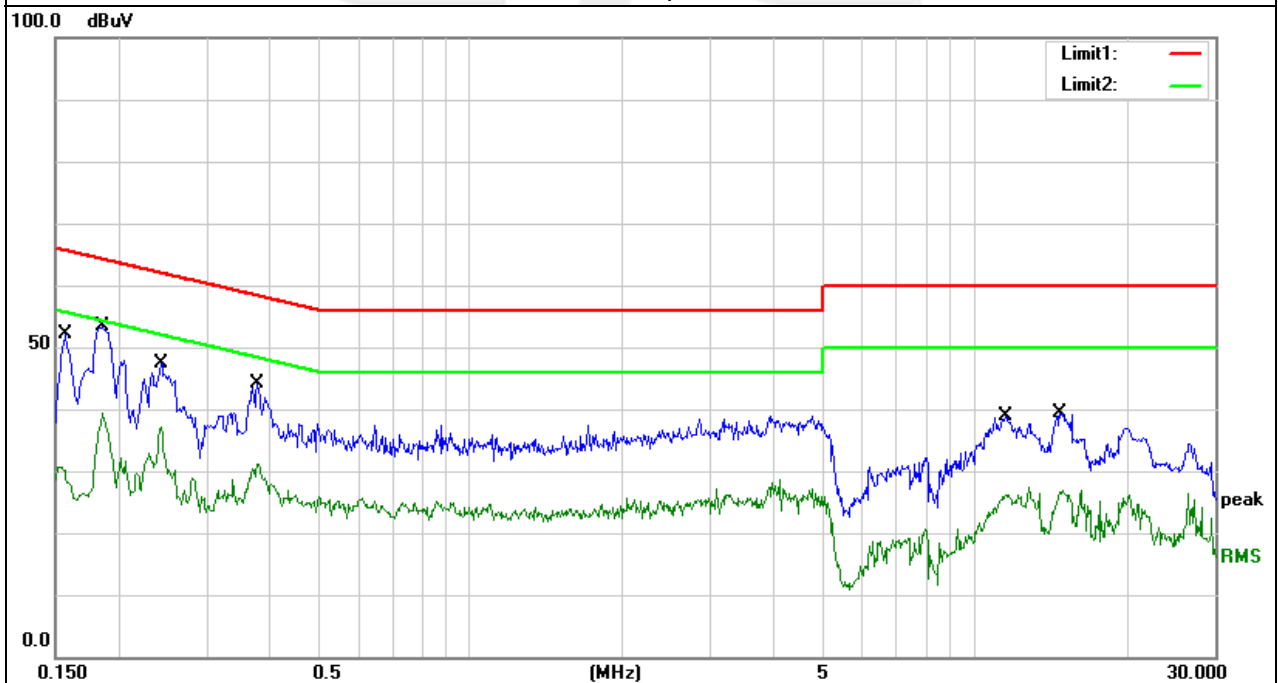



3.2 RADIATED EMISSION MEASUREMENT

3.2.1 Radiated Emission Limits

20dBc in any 100 kHz bandwidth outside the operating frequency band. In case the emission fall within the restricted band specified on 15.205(a), then the 15.209(a) limit in the table below has to be followed.

Frequencies (MHz)	Field Strength (micorvolts/meter)	Measurement Distance (meters)
0.009~0.490	2400/F(KHz)	300
0.490~1.705	24000/F(KHz)	30
1.705~30.0	30	30
30~88	100	3
88~216	150	3
216~960	200	3
Above 960	500	3

LIMITS OF RADIATED EMISSION MEASUREMENT (Above 1000MHz)

FREQUENCY (MHz)	Class A (dBuV/m) (at 3M)		Class B (dBuV/m) (at 3M)	
	PEAK	AVERAGE	PEAK	AVERAGE
Above 1000	80	60	74	54

Notes:

- (1) The limit for radiated test was performed according to FCC PART 15C.
- (2) The tighter limit applies at the band edges.
- (3) Emission level (dBuV/m)=20log Emission level (uV/m).

FREQUENCY RANGE OF RADIATED MEASUREMENT (For unintentional radiators)

Highest frequency generated or Upper frequency of measurement used in the device or on which the device operates or tunes (MHz)	Range (MHz)
Below 1.705	30
1.705 – 108	1000
108 – 500	2000
500 – 1000	5000
Above 1000	5 <sup>th</sup> harmonic of the highest frequency or 40 GHz, whichever is lower



Spectrum Parameter	Setting
Attenuation	Auto
Detector	Peak
Start Frequency	1000 MHz(Peak/AV)
Stop Frequency	10th carrier harmonic(Peak/AV)
RB / VB (emission in restricted band)	1 MHz / 1 MHz, AV=1 MHz / 10Hz

Receiver Parameter	Setting
Attenuation	Auto
Start ~ Stop Frequency	9kHz~150kHz/RB 200Hz for QP
Start ~ Stop Frequency	150kHz~30MHz/RB 9kHz for QP
Start ~ Stop Frequency	30MHz~1000MHz/RB 120kHz for QP

### 3.2.2 TEST PROCEDURE

- The measuring distance of at 3 m shall be used for measurements at frequency up to 1GHz. For frequencies above 1GHz, any suitable measuring distance may be used.
- The EUT was placed on the top of a rotating table 1 meters above the ground at a 3 meter open area test site. The table was rotated 360 degrees to determine the position of the highest radiation.
- The height of the equipment or of the substitution antenna shall be 1 m; the height of the test antenna shall vary between 1 m to 4 m. Both horizontal and vertical polarizations of the antenna are set to make the measurement.
- The initial step in collecting conducted emission data is a spectrum analyzer peak detector mode pre-scanning the measurement frequency range. Significant peaks are then marked and then Quasi Peak detector mode re-measured.
- If the Peak Mode measured value compliance with and lower than Quasi Peak Mode Limit, the EUT shall be deemed to meet QP Limits and then no additional QP Mode measurement performed.
- For the actual test configuration, please refer to the related Item –EUT Test Photos.

Note:

Both horizontal and vertical antenna polarities were tested and performed pretest to three orthogonal axis. The worst case emissions were reported

### 3.2.3 DEVIATION FROM TEST STANDARD

No deviation

### 3.2.4 TEST SETUP

#### (A) Radiated Emission Test-Up Frequency Below 30MHz

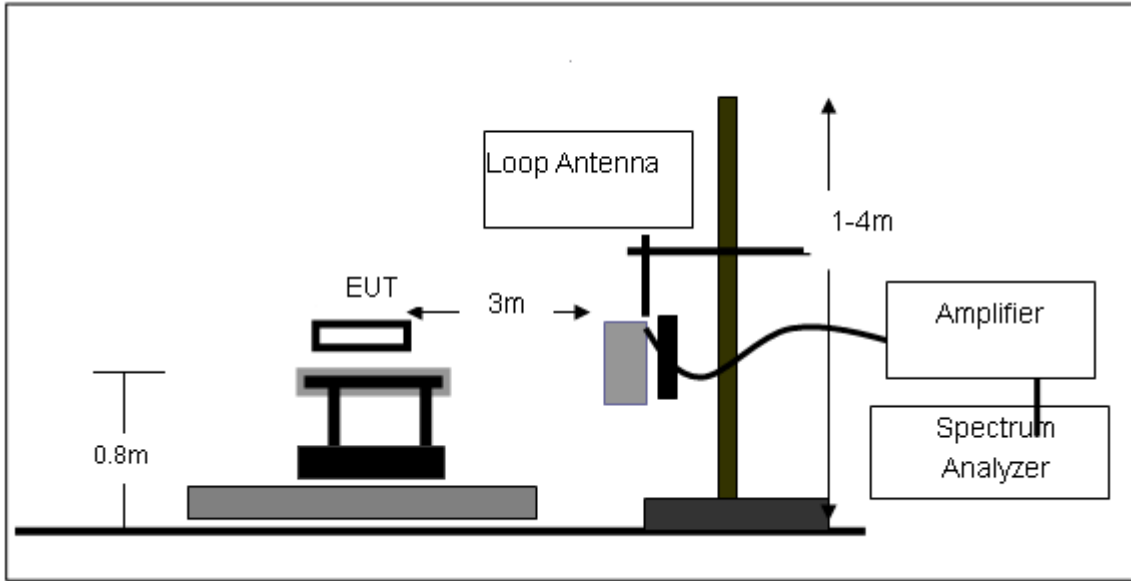

#### (B) Radiated Emission Test-Up Frequency 30MHz~1GHz

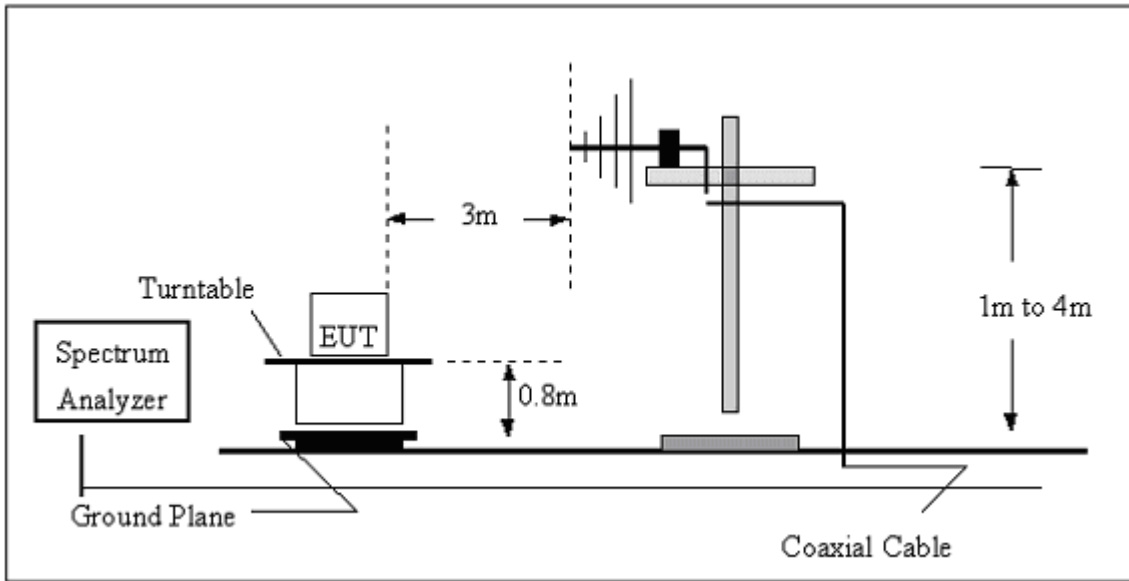

(C) Radiated Emission Test-Up Frequency Above 1GHz

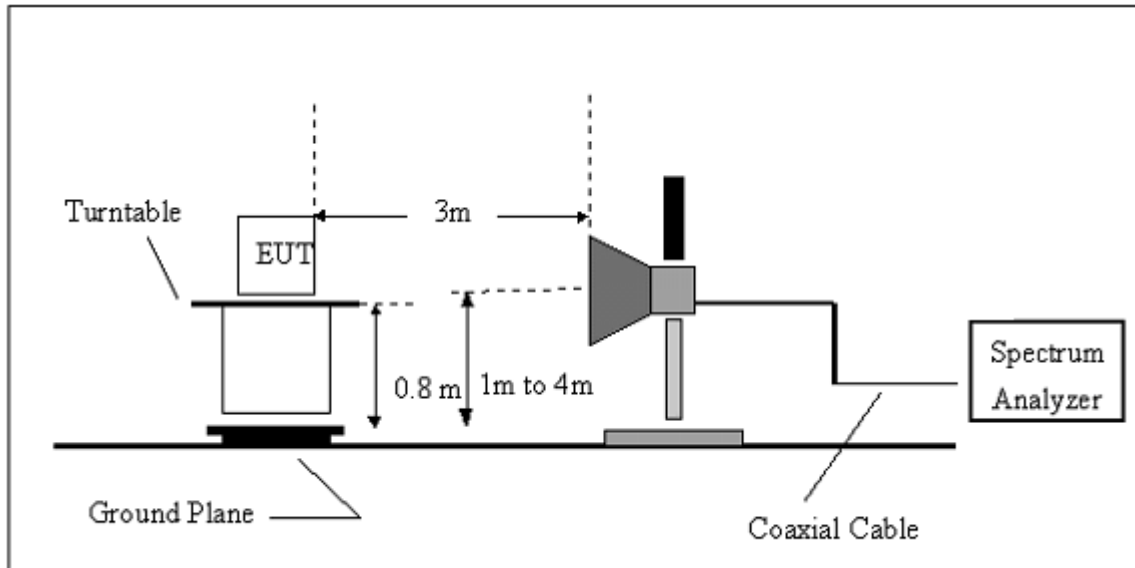

### 3.2.5 EUT OPERATING CONDITIONS

The EUT tested system was configured as the statements of 2.4 Unless otherwise a special operating condition is specified in the follows during the testing.





## 3.2.6 TEST RESULTS

Below 30MHz

EUT :	Smart Phone	Model Name. :	A071
Temperature :	20 °C	Relative Humidity :	48%
Pressure :	1010 hPa	Polarization :	---
Test Voltage :	DC 5V from Adapter AC 120V/60Hz		
Test Mode :	Mode 1		

Freq.	Reading	Limit	Margin	State
(MHz)	(dBuV/m)	(dBuV/m)	(dB)	P/F
--	--	--	--	PASS
--	--	--	--	PASS

## NOTE:

The amplitude of spurious emissions which are attenuated by more than 20dB below the permissible value has no need to be reported.

Distance extrapolation factor =  $40 \log(\text{specific distance}/\text{test distance})(\text{dB})$ ;

Limit line = specific limits(dBuV) + distance extrapolation factor.

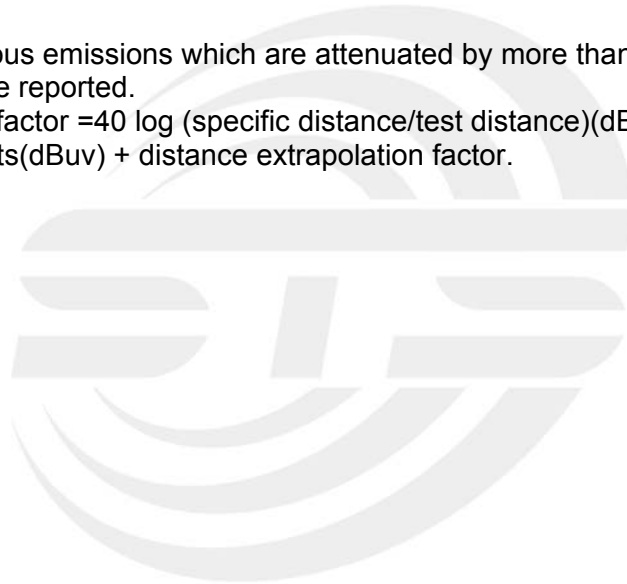



Between 30MHz – 1000 MHz

EUT :	Smart Phone	Model Name. :	A071
Temperature :	20 °C	Relative Humidity :	48%
Pressure :	1010 hPa	Polarization :	Horizontal
Test Voltage :	DC 5V from Adapter AC 120V/60Hz		
Test Mode :	Mode 1		

Frequency (MHz)	Reading (dBuV)	Correct Factor(dB/m)	Result (dBuV/m)	Limit (dBuV/m)	Margin (dB)	Remark
154.8204	14.08	12.19	26.27	43.50	-17.23	QP
181.9202	17.69	10.36	28.05	43.50	-15.45	QP
235.8164	22.35	11.63	33.98	46.00	-12.02	QP
283.9791	22.67	14.68	37.35	46.00	-8.65	QP
480.5276	22.86	20.40	43.26	46.00	-2.74	QP
962.1623	14.90	29.32	44.22	54.00	-9.78	QP

Remark:

1. Factor = Antenna Factor + Cable Loss – Pre-amplifier.

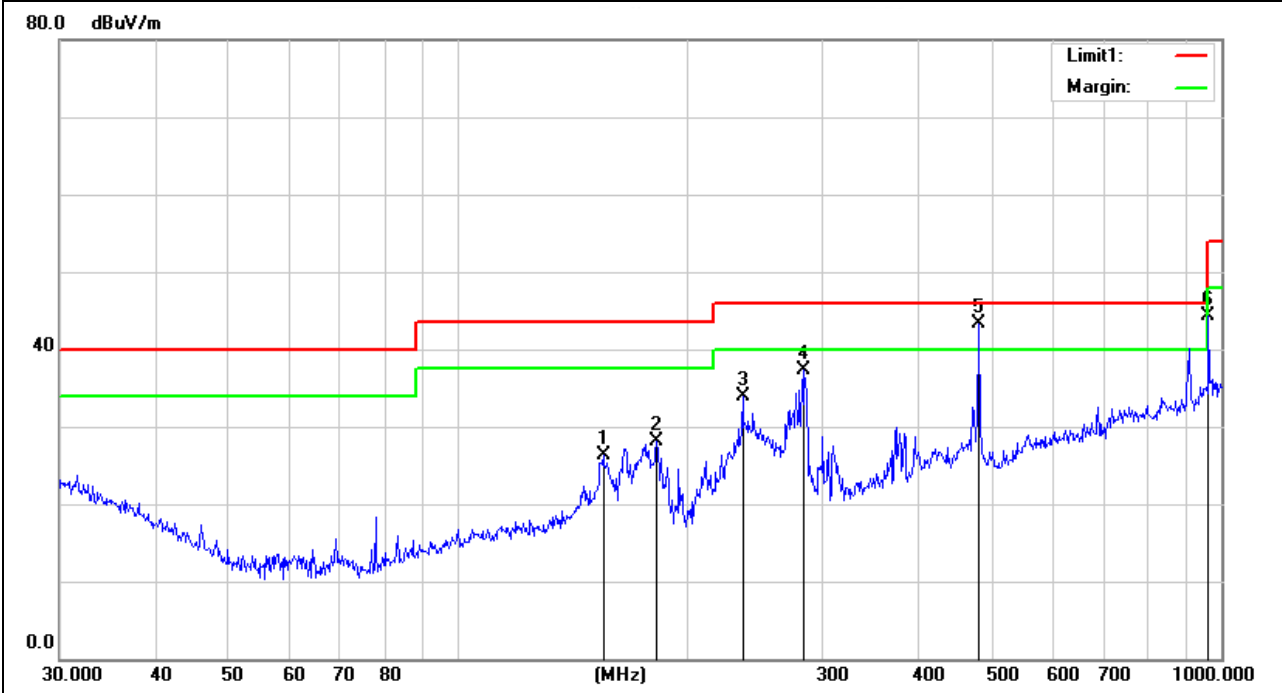



EUT :	Smart Phone	Model Name. :	A071
Temperature :	20 °C	Relative Humidity :	48%
Pressure :	1010 hPa	Polarization :	Vertical
Test Voltage :	DC 5V from Adapter AC 120V/60Hz		
Test Mode :	Mode 1		

Frequency (MHz)	Reading (dBuV)	Correct Factor(dB/m)	Result (dBuV/m)	Limit (dBuV/m)	Margin (dB)	Remark
31.1798	5.47	18.34	23.81	40.00	-16.19	QP
99.8777	10.05	10.90	20.95	43.50	-22.55	QP
165.4866	13.98	11.30	25.28	43.50	-18.22	QP
239.9873	24.19	12.15	36.34	46.00	-9.66	QP
283.9791	16.36	14.68	31.04	46.00	-14.96	QP
480.5276	22.67	20.40	43.07	46.00	-2.93	QP

Remark:

1. Factor = Antenna Factor + Cable Loss – Pre-amplifier.

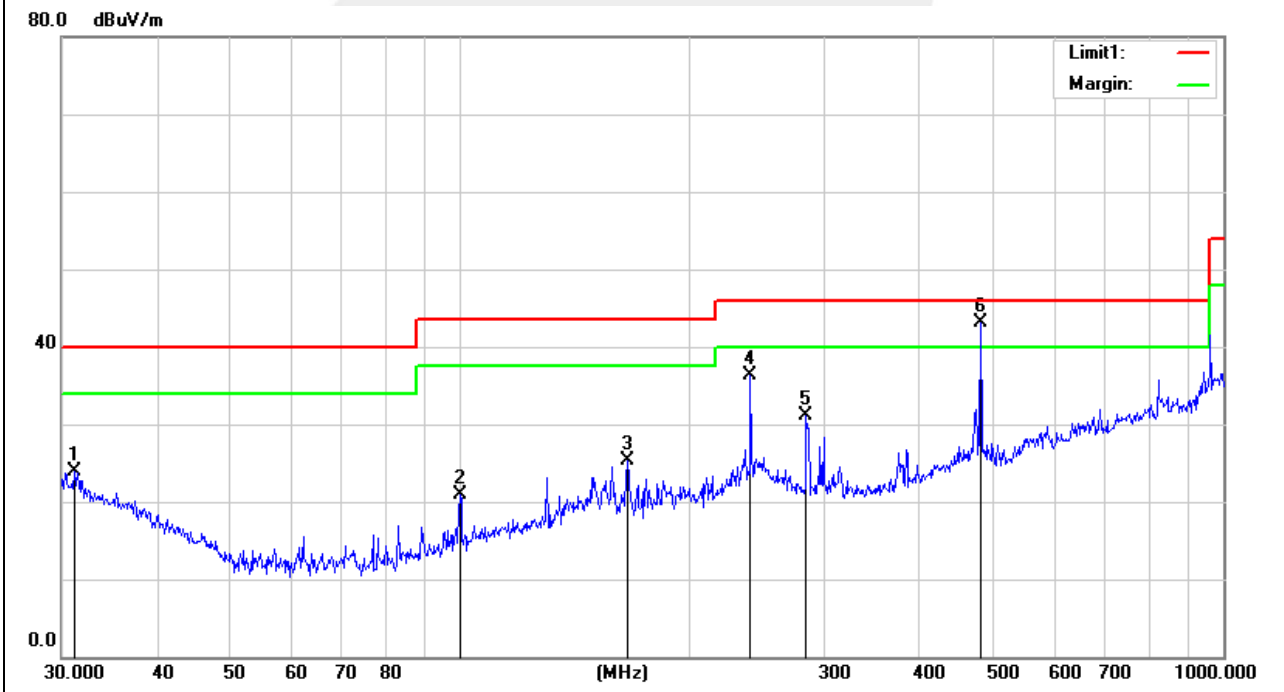



Above 1GHz

The worst test data above 1 GHz was showed as thefollow:

EUT :	Smart Phone	Model Name. :	A071
Temperature :	20 °C	Relative Humidity :	48%
Pressure :	1010 hPa	Test Mode :	Mode 1
Test Voltage :	DC 5V from Adapter AC 120V/60Hz		

Freq. (MHz)	Ant. Pol H/V	Peak Reading (dBuV)	AV Reading (dBuV)	Ant./CL CF (dB)	Actual Fs		Peak Limit (dBuV/m)	AV Limit (dBuV/m)	Peak margin (dBuV/m)	AV margin (dBuV/m)
					Peak (dBuV/m)	AV (dBuV/m)				
1097.22	H	57.46	41.32	5.15	62.61	46.47	74	54	-11.39	-7.53
2866.4	H	52.89	38.24	9.45	62.34	47.69	74	54	-11.66	-6.31
N/A										
1069.22	V	52.37	37.55	5.15	57.52	42.7	74	54	-16.48	-11.3
2896.40	V	49.64	32.14	9.45	59.09	41.59	74	54	-14.91	-12.41
N/A										

Notes:

1. Measuring frequencies from 1 GHz to 6GHz.
2. Radiated emissions measured in frequency above 1000MHz were made with an instrument using Peak detector mode of the emission shown in Actual FS column.
3. The frequency that above 3GHz is mainly from the environment noise.

#### 4. PHOTOS OF TEST SETUP

##### Radiated Measurement Photos 30MHz- 1GHz

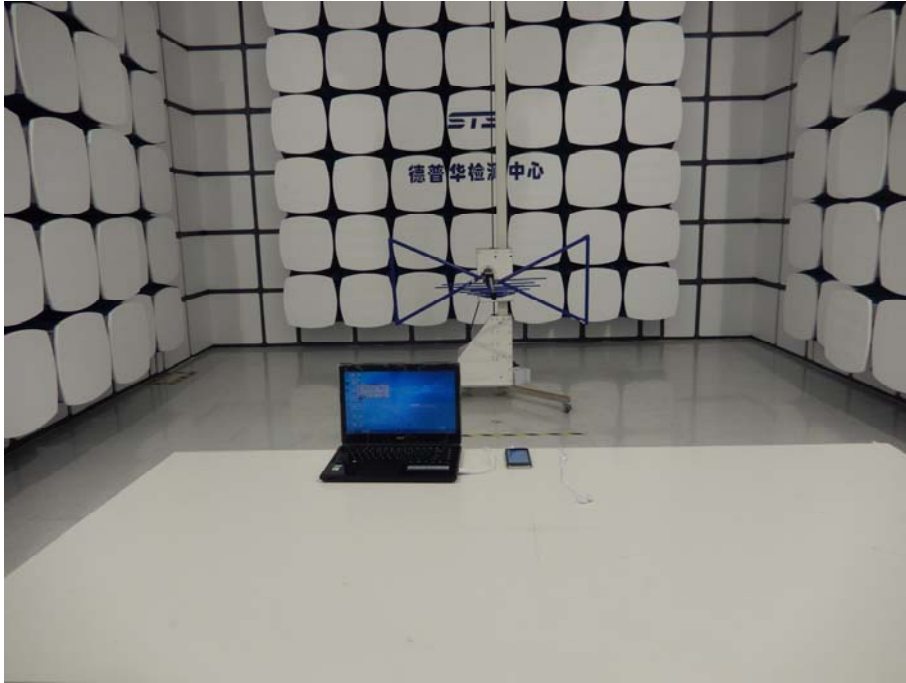

##### Above 1GHz

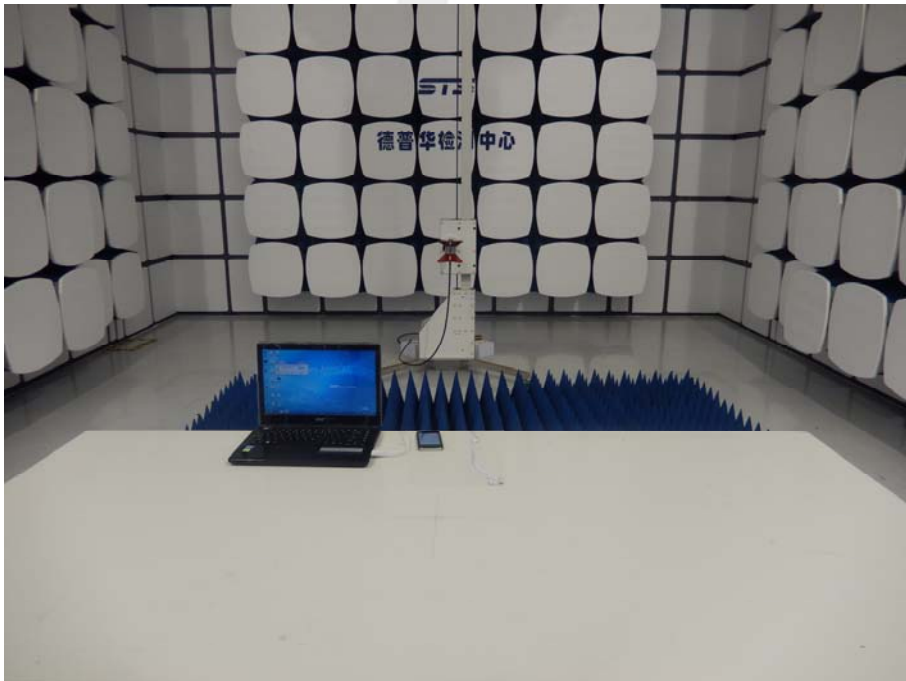

### Conducted Measurement Photos

