A26
User Manual

INTRODUCTION

Thanks for choosing our Android smart phone. If you'd like your phone to live a long and fruitful life, please read this guide carefully and keep it for future reference. You never know when you might need it.

And don't worry if the pictures we use to demonstrate your phone's functions look a little different from what you see on its screen. It's the functions that matter.

Disclaimer

Mtt Mobiles reserves all the rights to change the specifications and the content of this manual without any prior information.

Some contents and services accessible through this device belong to third parties and are protected by copyright, patent, trademark and or other intellectual laws.

Third Party services may be terminated or interrupted at any time. Mtt does not bear any responsibility or authority for the warranty or usage of these applications.

Never attempt to disassemble your phone. You alone are responsible for how you use your phone and any consequences of its use.

Table of Contents

1 Safety	4
2 Understanding your Phone	9
3 Using your Phone	18
4 Inputting Text	24
5 Maintenance	25
6 Taking Care of your Device	26



1.1 Safety Precautions



Please read through the following briefings carefully, and act in accordance with these rules, so as to prevent causing any danger or violating any law.

SAR Value

- Use cell phone when the signal strength is good. Keep your calls short or instead use headset or send a text message. This advice applies especially to children, adolescents and pregnant women.
- If you are using a Bluetooth headset device, please make sure it has a low power emitter.

1.2 Using your phone safely



On The Road

Using a phone while driving is illegal in many countries. Please follow local laws and drive safely at all times.



Near Sensitive Electronics

Don't use your phone near sensitive electronic equipment – particularly medical devices such as pacemakers – as it could cause them to malfunction. It can also interfere with the operation of fire detectors and other automatic-control equipment.

For more information about how your phone affects pacemakers or other electronic equipment, please contact the manufacturer or your local distributor.

Your phone may cause interference when used near TVs, radios or automated office equipment.



While Flying

Your phone can cause interference with aircraft equipment. So

it's essential you follow airline regulations. And if airline personnel ask you to switch off your phone, or disable its wireless functions, please do as they say.



In Hospital

Your phone may interfere with the normal operation of medical equipment. Follow all hospital regulations and turn it off when you're asked to by posted warnings or medical staff.



At a Petrol Station

Don't use your phone at petrol stations. In fact, it's always best to switch off whenever you're near fuels, chemicals or explosives.



Around Water

Keep your phone away from water (or any other liquid). It's not a waterproof model.



Making Repairs

Never take your phone apart. Please leave that to the professionals. Unauthorised repairs could break the terms of your warranty.



Broken Antenna

Don't use your phone if the antenna is damaged, as it could cause injury.



Around Children

Keep your mobile out of children's reach. It should never be used as a toy and it might not be good for their health.



Original Accessories

Only use the original accessories supplied with your phone or those approved by the manufacturer. Using unapproved accessories may affect performance, make the warranty void,

break national regulations on the use of mobile phones, or even cause injury.



Near Explosives

Turn off your phone in or near areas where explosive materials are used. Always obey local laws and turn off your phone when requested.



Emergency Calls

To make an emergency call your phone must be turned on and in an area where there's network coverage. Dial the national emergency number and press 'send'. Explain exactly where you are and don't hang up until help has arrived.

Working Temperature

The working temperature for the phone is between 0 Degree and 40 Degree Celcius. Please don't use the phone outside the range. Using the phone under too high or too low temperature might cause problems.



At very high volume, prolonged listening to a mobile phone can damage your hearing.



Understanding your Phone

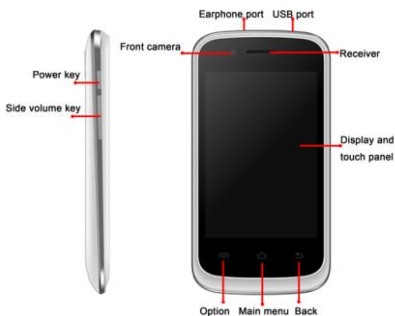















2.1 Your Phone





2.2 Description Icons

Note: Icons are only for demonstration; they may differ in actual device.

Icons	Descriptions	Icons	Descriptions
	Shows the phone's network signal strength.		Show the phone's battery capacity.
	Speaker has been activated.		You have unread SMS.
	Call on hold		USB storage Turned on.
	The ringing type is set on Vibration.		Flight Mode
	Wi fi is ON		Data network in use.
	You have missed calls.		A clock alarm is active.
	In call		Bluetooth ON

2.3 Inserting & Removing SIM cards,T-flash & Battery

Inserting the Battery

-  Open the battery cover on the back of your phone.
-  Align the battery's contact points with those of the phone and gently press the battery down into place.
-  Replace the battery cover clicking it back into position

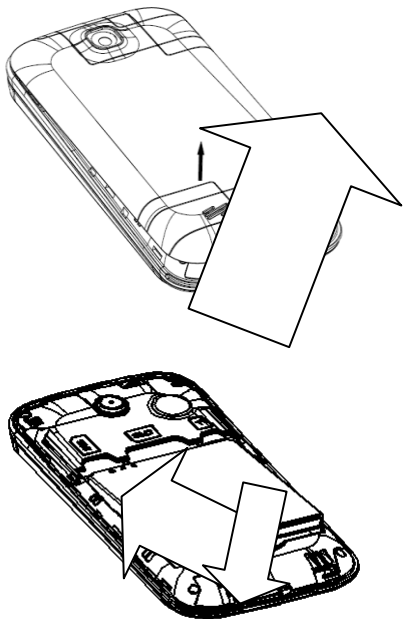

Removing the battery

1. Switch off your phone.
2. Open the battery cover. Gently shift the cover and open
3. Lift the battery up and out of your phone.

To install the SIM card

Your device supports 2 SIM cards

- 1) Remove the battery if it is installed.
- 2) Locate the SIM card slot, and then insert the SIM card with its gold contacts facing down and its cut-off corner facing out the card slot.

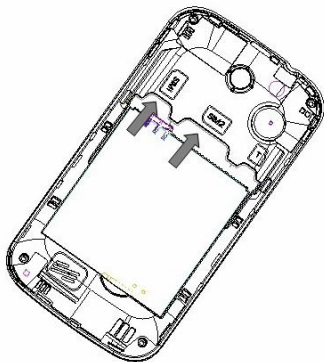

- 3) Slide the SIM card completely into the slot.

To install the T-Flash card

To have additional storage for your images, videos, music, and files, you can purchase a memory card and install it into your device.

- 1) Make sure that your device is turned off, and then remove the back cover.
- 2) Remove the battery if it is installed.
- 3) Locate the memory card slot on the upper part of the

exposed right panel.

- 4) Insert the memory card into the slot according to the

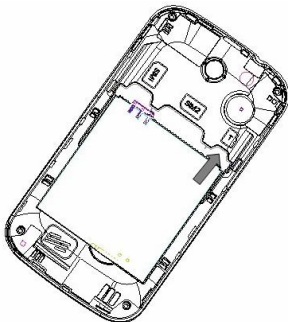





indication icon.

To remove the memory card, perform converse installations.

Note: make sure the power is off before inserting or removing the SIM cards and memory card to avoid damages.

2.4 Charging the battery

The rechargeable Li-ion battery that comes with your phone is ready to be used, but is not charged. It is easy to do & can be done in 3 simple steps below:

-  Connect the charger to your phone, and plug it into a socket.
-  The battery indicator in the corner of the screen will scroll to show you it's charging.
-  When fully charged, the battery indicator will stop scrolling.
-  Disconnect the charger from your mobile, and unplug.

2.5 Power ON/OFF

Press the power key to power-ON/OFF the phone.

When you turn your phone on, it'll automatically check the SIM and show the following information on screen:

- **Input SIM1 PIN:** If you've set a PIN for your SIM1.
- **Input SIM2 PIN:** If you've set a PIN for your SIM2.

Note:

The PIN is supplied with your SIM. Please replace it with your own PIN code as soon as possible. Enter the wrong PIN three times, and your SIM will be locked. Then you'll need to contact your network service provider to ask for a PUK code to unlock it. It is applicable for both the SIMs if you are using 2 SIM Cards.

2.6 Enter Main Menu

In Idle mode, press the Menu key  to enter the main menu on the desktop and click the Home key to return.

2.7 Enter Sub Menu

Once at the main menu, click the icon to select the submenu, press **Back Key** to return to the previous menu, and press the **Home Screen** to return to the home screen.

2.8 Use Notification Panel

As a new notification appears in the notification area, slide down in the area to view the contents of the notification.

2.9 Expand Main Interface

The main interface may extend and exceed the screen width to provide more space for newly added shortcuts and tools.

Slide your finger horizontally on the main interface to extend to the left or right area of the main interface.

2.10 Add icons on the main interface

You can long press the icon on the main menu until it's enlarged and the mobile phone vibrates, and copies the icons in the main menu to the main interface.

2.11 Move icons on the main interface

1. Long press the icon on the main interface until it's enlarged and the mobile phone vibrates.
2. Drag the icon to the desired position and then release it.

2.12 Delete icons on the main interface

1. Long press the icon on the main interface until it's enlarged and the mobile phone vibrates.
2. Drag the icon to "Remove" to delete it.

2.13 Change wallpapers

 Long press screen in idle interface to open the menu.

 Choose from "Gallery /"Live Wallpapers"/ "Wallpapers", and Select the wallpaper and press "Set wallpaper" to complete.

2.14 Install APK through File Manager

APK is a supported file format for the [Android](#) mobile [operating system](#).

- a) Please copy the downloaded APK file into the SD card, and

then insert the SD card into the phone.

- b) In Idle mode, click Main Menu to enter the main menu.
- c) Click “File Manager” to enter the directory of SD card.
- d) Click the APK file you wish to install, and follow the installation wizard.



Using your Phone

3.1 Main Menu & Its Functions

Select  to enter the main menu...

Allows you to view a list of features available in your phone-

 **Clock**

Allows you to set the Alarm from Clock.

 **Browser**

Browse the internet. Search engine- default set as Google.

 **Calculator**

Allows you to make tedious calculations quickly.

 **Calendar**

View the calendar & add events.

 **Camera**

Allows you to click pictures anytime you want. Your smart phone has High Definition camera which ensures you always click good quality of pictures and stores them under the Gallery folder. In Camera, easily choose Camcorder to record Video Files.

F



Contact

To see your list of Contacts. Access phonebook through this function.



Email

Allows you set up your POP/IFMAP email accounts.

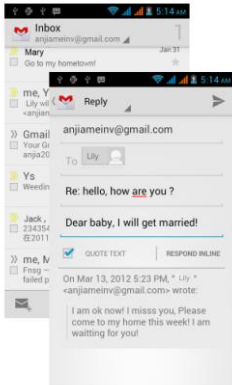

 **Gallery**

Allows you to save & view photos & videos.

 **Play Store**

Log in to your Gmail account to view all the applications & download from thousands of applications available under the Google Market called Play Store.

Note:

To use this app please connect to an internet connection.

 **Messaging**

Allow you to view messages sent & received as a thread.

 **Music**

View the list of songs available in your phone. View the artists, albums, playlists & more.

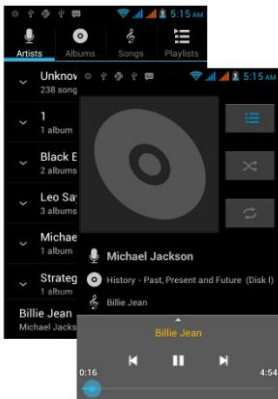

Phone

Allow you to make quick outgoing calls.



File Manager

You could install the files in APK format & also view your files.



Settings

Modify settings under the following-

- SIM management
- Wi-Fi
- Bluetooth
- Data Usage
- Audio profiles
- Display
- Storage
- Battery
- Apps
- Location access

- Security
- Language & Input
- Backup & Reset
- Date & Time
- Schedule power on & off
- Accessibility
- Developer options
- About phone



SIM Toolkit

This service is provided by the operator. It provides many types of personalized message services.



Sound Recorder

Allows you to record sounds.



Video player

View from list of videos.

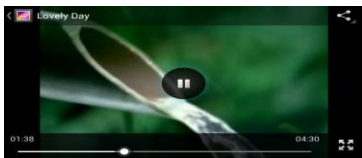

3.2 Wi-Fi

Your Smart Phone supports Wi-Fi which allows you to connect with a Wireless connection. This is useful for surfing internet on phone

1. Go to Settings--Wifi, activate the WiFi.
2. Enter WiFi, select the hotspot you want to connect.
3. If the the hotspot needs password, you have to enter the right password first, and then use the

WiFi properly.



Inputting Text

Intelligent keyboard

Your smart phone automatically corrects and suggests words as you type.

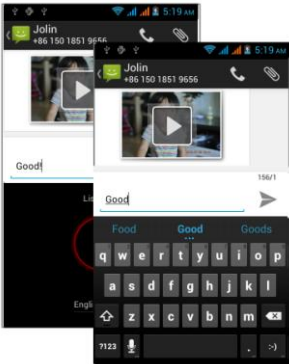

Cut, Copy and Paste

Touch and hold text content to bring up the magnifying glass, and then slide your finger to move the insertion points. Then choose to cut, copy, or paste. It is very easy to copy text from web pages, email, or text messages.



Maintenance

Use a dry soft cloth to wipe general dirt.

Do not use a hard cloth, benzene or thinner to wipe the phone, otherwise, the surface of the phone will be scratched or could even result in the fading of colour.



Taking Care of your Device

Your device is a product of superior design and craftsmanship and should be handled with care: The following suggestions will help you protect your phone:

- Always keep the small parts of the phone away from children.
- Keep the device dry. Precipitation, humidity, and all types of liquids or moisture can contain minerals that will rust electronic circuits. If your device does get wet, remove the battery, and allow the device to dry completely before replacing it.
- Do not use or store the device in dusty, dirty areas. Its moving parts and electronic components can be damaged.
- Do not store the device in high or cold temperature. High temperatures can shorten the life of electronic devices and damage batteries.
- Do not attempt to open the device other than as instructed in this guide.
- Do not drop, knock, or shake the device. Rough handling can break internal circuit boards and fine mechanics.
- Do not use harsh chemicals, cleaning solvents, or strong detergents to clean the device. Only use a soft, clean, dry cloth to clean the surface of the device.
- Do not paint the device. Paint can clog the moving parts and prevent proper operation.

Use indoor chargers.

- FCC Statement
 1. This device complies with Part 15 of the FCC Rules. Operation is subject to the following two conditions:
 - (1) This device may not cause harmful interference.

(2) This device must accept any interference received, including interference that may cause undesired operation.

2. Changes or modifications not expressly approved by the party responsible for compliance could void the user's authority to operate the equipment.

NOTE:

This equipment has been tested and found to comply with the limits for a Class B digital device, pursuant to Part 15 of the FCC Rules. These limits are designed to provide reasonable protection against harmful interference in a residential installation.

This equipment generates uses and can radiate radio frequency energy and, if not installed and used in accordance with the instructions, may cause harmful interference to radio communications. However, there is no guarantee that interference will not occur in a particular installation. If this equipment does cause harmful interference to radio or television reception, which can be determined by turning the equipment off and on, the user is encouraged to try to correct the interference by one or more of the following measures:

Reorient or relocate the receiving antenna.

Increase the separation between the equipment and receiver.

Connect the equipment into an outlet on a circuit different from that to which the receiver is connected.

Consult the dealer or an experienced radio/TV technician for help.

SAR Information Statement

Your wireless phone is a radio transmitter and receiver. It is designed and manufactured not to exceed the emission limits for exposure to radiofrequency (RF) energy set by the Federal Communications Commission of the U.S. Government. These limits are part of comprehensive guidelines and establish permitted levels of RF energy for the general population. The guidelines

are based on standards that were developed by independent scientific organizations through periodic and thorough evaluation of scientific studies. The standards include a substantial safety margin designed to assure the safety of all persons, regardless of age and health. The exposure standard for wireless mobile phones employs a unit of measurement known as the Specific Absorption Rate, or SAR. The SAR limit set by the FCC is 1.6 W/kg. * Tests for SAR are conducted with the phone transmitting at its highest certified power level in all tested frequency bands. Although the SAR is determined at the highest certified power level, the actual SAR level of the phone while operating can be well below the maximum value. This is because the phone is designed to operate at multiple power levels so as to use only the power required to reach the network. In general, the closer you are to a wireless base station antenna, the lower the power output. Before a phone model is available for sale to the public, it must be tested and certified to the FCC that it does not exceed the limit established by the government adopted requirement for safe exposure. The tests are performed in positions and locations (e.g., at the ear and worn on the body) as required by the FCC for each model. The highest SAR value for this model phone when tested for use at the ear is 0.638W/Kg and when worn on the body, as described in this user guide, is 0.654W/Kg(Body-worn measurements differ among phone models, depending upon available accessories and FCC requirements). The maximum scaled SAR in hotspot mode is 1.113W/Kg.While there may be differences between the SAR levels of various phones and at various positions, they all meet the government requirement for safe exposure. The FCC has granted an Equipment Authorization for this model phone with all reported SAR levels evaluated as in compliance with the FCC Rfexposure guidelines. SAR information on this model phone is on file with the FCC and can be found under the Display Grant section of <http://www.fcc.gov/oet/fccid> after searching on

- FCC ID: 2ACQK TELCO003 Additional information on Specific Absorption Rates (SAR) can be found on the

Cellular Telecommunications Industry Association (CTIA) web-site at <http://www.wow-com.com>. * In the United States and Canada, the SAR limit for mobile phones used by the public is 1.6 watts/kg (W/kg) averaged over one gram of tissue. The standard incorporates a substantial margin of safety to give additional protection for the public and to account for any variations in measurements.

Body-worn Operation

This device was tested for typical body-worn operations. To comply with RF exposure requirements, a minimum separation distance of 10mm must be maintained between the user's body and the handset, including the antenna. Third-party belt-clips, holsters, and similar accessories used by this device should not contain any metallic components. Body-worn accessories that do not meet these requirements may not comply with RF exposure requirements and should be avoided. Use only the supplied or an approved antenna.