



FCC RADIO TEST REPORT-WIFI

FCC ID: 2ACPR-W7421

Product : Tablet PC

Trade Name : Bmorn

Model Name : W7421

Serial Model : W7413,W7406,W740,W7405,W7409,
W7416,W7422,W7423,W7424,W7425,
W7426,W7427,W7428,W7429,W8419,
W8420,W8407,W8410 ,W1415

Report No. : NTEK-2015NT08242551F1

Prepared for

Shenzhen Bmorn Technology Co.,Ltd.
5/F, Hengfang Verteran Industrial Park,Xingye Road, Xixiang,
Bao'an,Shenzhen, Guangdong,China

Prepared by

Shenzhen NTEK Testing Technology Co., Ltd.
1/F, Building E, Fenda Science Park, Sanwei Community, Xixiang Street
Bao'an District, Shenzhen P.R. China
Tel.: +86-0755-61156588 Fax.: +86-0755-61156599
Website:www.ntek.org.cn

TEST RESULT CERTIFICATION

Applicant's name Shenzhen Bmorn Technology Co.,Ltd.
Address 5/F, Hengfang Verteran Industrial Park,Xingye Road, Xixiang,
Bao'an,Shenzhen, Guangdong,China

Manufacture's Name... Shenzhen Bmorn Technology Co.,Ltd.
Address 5/F, Hengfang Verteran Industrial Park,Xingye Road, Xixiang,
Bao'an,Shenzhen, Guangdong,China

Product description

Product name Tablet PC
Model and/or type reference W7421
Serial Model W7413,W7406,W740,W7405,W7409,W7416,W7422,
W7423,W7424,W7425,W7426,W7427,W7428,W7429,W8419,
W8420,W8407,W8410 ,W1415

Standards FCC Part15.247 01 Oct. 2014

Test procedure ANSI C63.10-2013 and KDB 558074: June 5, 2014

This device described above has been tested by NTEK, and the test results show that the equipment under test (EUT) is in compliance with the FCC requirements. And it is applicable only to the tested sample identified in the report.

This report shall not be reproduced except in full, without the written approval of NTEK, this document may be altered or revised by NTEK, personnel only, and shall be noted in the revision of the document.

Date of Test

Date (s) of performance of tests 24 Aug. 2015 ~06 Sep. 2015

Date of Issue..... 06 Sep. 2015

Test Result..... **Pass**

Testing Engineer : Eileen Liu.
(Eileen Liu)

Technical Manager : Brown Lu
(Brown Lu)

Authorized Signatory : Sam. Chen
(Sam Chen)

Table of Contents

	Page
1 . SUMMARY OF TEST RESULTS	5
1.1 TEST FACILITY	6
1.2 MEASUREMENT UNCERTAINTY	6
2 . GENERAL INFORMATION	7
2.1 GENERAL DESCRIPTION OF EUT	7
2.2 DESCRIPTION OF TEST MODES	9
2.3 BLOCK DIGRAM SHOWING THE CONFIGURATION OF SYSTEM TESTED	10
2.4 DESCRIPTION OF SUPPORT UNITS(CONDUCTED MODE)	11
2.5 EQUIPMENTS LIST FOR ALL TEST ITEMS	12
3 . EMC EMISSION TEST	13
3.1 CONDUCTED EMISSION MEASUREMENT	13
3.1.1 POWER LINE CONDUCTED EMISSION LIMITS	13
3.1.2 TEST PROCEDURE	14
3.1.3 DEVIATION FROM TEST STANDARD	14
3.1.4 TEST SETUP	14
3.1.5 EUT OPERATING CONDITIONS	14
3.1.6 TEST RESULTS	15
3.2 RADIATED EMISSION MEASUREMENT	23
3.2.1 RADIATED EMISSION LIMITS	23
3.2.2 TEST PROCEDURE	24
3.2.3 DEVIATION FROM TEST STANDARD	24
3.2.4 TEST SETUP	25
3.2.5 EUT OPERATING CONDITIONS	26
3.2.6 TEST RESULTS (BETWEEN 9KHZ – 30 MHZ)	27
3.2.7 TEST RESULTS (BETWEEN 30MHZ – 1GHZ)	28
3.2.8 TEST RESULTS (ABOVE 1000 MHZ)	30
4 . POWER SPECTRAL DENSITY TEST	31
4.1 APPLIED PROCEDURES / LIMIT	31
4.1.1 TEST PROCEDURE	31
4.1.2 DEVIATION FROM STANDARD	31
4.1.3 TEST SETUP	31
4.1.4 EUT OPERATION CONDITIONS	31
4.1.5 TEST RESULTS	32
5 . BANDWIDTH TEST	38
5.1 APPLIED PROCEDURES / LIMIT	38
5.1.1 TEST PROCEDURE	38

Table of Contents

	Page
TEST SETUP	38
5.1.2 EUT OPERATION CONDITIONS	38
5.1.3 TEST RESULTS	39
6 . PEAK OUTPUT POWER TEST	45
6.1 APPLIED PROCEDURES / LIMIT	45
6.1.1 TEST PROCEDURE	45
6.1.2 DEVIATION FROM STANDARD	45
6.1.3 TEST SETUP	45
6.1.4 EUT OPERATION CONDITIONS	45
6.1.5 TEST RESULTS	46
7 . 100 KHZ BANDWIDTH OF FREQUENCY BAND EDGE	47
7.1 DEVIATION FROM STANDARD	47
7.2 TEST SETUP	47
7.3 EUT OPERATION CONDITIONS	47
7.4 TEST RESULTS	48
8 . ANTENNA REQUIREMENT	53
8.1 STANDARD REQUIREMENT	53
8.2 EUT ANTENNA	53
9 . EUT TEST PHOTO	54
APPENDIX-PHOTOGRAPHS OF EUT CONSTRUCTIONAL DETAILS	

1. SUMMARY OF TEST RESULTS

Test procedures according to the technical standards:

FCC Part15 (15.247) , Subpart C			
Standard Section	Test Item	Judgment	Remark
15.207	Conducted Emission	PASS	
15.247 (a)(2)	6dB Bandwidth	PASS	
15.247 (b)	Peak Output Power	PASS	
15.247 (c)	Radiated Spurious Emission	PASS	
15.247 (d)	Power Spectral Density	PASS	
15.205	Band Edge Emission	PASS	
15.203	Antenna Requirement	PASS	

NOTE:

(1) "N/A" denotes test is not applicable in this Test Report

1.1 TEST FACILITY

NTEK Testing Technology Co., Ltd
 Add.:1/F, Building E, Fenda Science Park, Sanwei Community, Xixiang Street, Bao'an District, Shenzhen P.R. China.
 FCC Registration No.:238937; IC Registration No.:9270A-1
 CNAS Registration No.:L5516

1.2 MEASUREMENT UNCERTAINTY

The reported uncertainty of measurement $y \pm U$, where expanded uncertainty U is based on a standard uncertainty multiplied by a coverage factor of $k=2$, providing a level of confidence of approximately 95 %.

No.	Item	Uncertainty
1	Conducted Emission Test	$\pm 1.38\text{dB}$
2	RF power,conducted	$\pm 0.16\text{dB}$
3	Spurious emissions,conducted	$\pm 0.21\text{dB}$
4	All emissions,radiated(<1G)	$\pm 4.68\text{dB}$
5	All emissions,radiated(>1G)	$\pm 4.89\text{dB}$
6	Temperature	$\pm 0.5^\circ\text{C}$
7	Humidity	$\pm 2\%$

2. GENERAL INFORMATION

2.1 GENERAL DESCRIPTION OF EUT

Equipment	Tablet PC	
Trade Name	Bmorn	
Model Name	W7421	
Serial Model	W7413,W7406,W740,W7405,W7409, W7416,W7422,W7423,W7424,W7425, W7426,W7427,W7428,W7429,W8419, W8420,W8407,W8410 ,W1415	
Model Difference	All the model are the same circuit and RF module, except the model name and colour.	
Product Description	The EUT is a Tablet PC	
	Operation Frequency:	802.11b/g/n(20MHz): 2412~2462MHz
	Modulation Type:	IEEE 802.11b : DSSS (CCK, QPSK, DBPSK) IEEE 802.11g/n (HT20) : OFDM (64QAM, 16QAM, QPSK, BPSK)
	Bit Rate of Transmitter	802.11b:11/5.5/2/1 Mbps 802.11g:54/48/36/24/18/12/9/6Mbps 802.11n(20MHz):150/144.44/130/117/ 115.56/104/86.67/78/52/6.5Mbps
	Number Of Channel	802.11b/g/n20MHz:11CH
	Antenna Designation:	Please see Note 3.
	Antenna Gain (dBi)	1.0 dBi
	Based on the application, features, or specification exhibited in User's Manual, the EUT is considered as an ITE/Computing Device. More details of EUT technical specification, please refer to the User's Manual.	
Channel List	Please refer to the Note 2.	
Ratings	DC 3.7V	
Adapter	Model:SA/12PA/05FUS050200 Input: 100-240V~,50/60 Hz,0.5A Output: 5.0V---,2A	
Battery	DC 3.7V ,2800mAh	
Connecting I/O Port(s)	Please refer to the User's Manual	

Note:

1. For a more detailed features description, please refer to the manufacturer's specifications or the User's Manual.

2.

Channel List for 802.11b/g/n(20 MHz)							
Channel	Frequency (MHz)	Channel	Frequency (MHz)	Channel	Frequency (MHz)	Channel	Frequency (MHz)
01	2412	04	2427	07	2442	10	2457
02	2417	05	2432	08	2447	11	2462
03	2422	06	2437	09	2452		

3.

Table for Filed Antenna

Ant	Brand	Model Name	Antenna Type	Connector	Gain (dBi)	NOTE
A	N/A	N/A	FPCBAntenna	N/A	1.0	Wifi Antenna

2.2 DESCRIPTION OF TEST MODES

To investigate the maximum EMI emission characteristics generates from EUT, the test system was pre-scanning tested base on the consideration of following EUT operation mode or test configuration mode which possible have effect on EMI emission level. Each of these EUT operation mode(s) or test configuration mode(s) mentioned above was evaluated respectively.

Pretest Mode	Description
Mode 1	802.11b CH1/ CH6/ CH11
Mode 2	802.11g CH1/ CH6/ CH11
Mode 3	802.11n/20MHz CH1/ CH6/ CH11
Mode 4	Link Mode

For Conducted Emission	
Final Test Mode	Description
Mode 4	Link Mode

For Radiated Emission	
Final Test Mode	Description
Mode 1	802.11b CH1/ CH6/ CH11
Mode 2	802.11g CH1/ CH6/ CH11
Mode 3	802.11n/20MHz CH1/ CH6/ CH11

Note:

- (1) The measurements are performed at the highest, middle, lowest available channels.
- (2) The measurements are performed at all Bit Rate of Transmitter, the worst data was reported
- (3) EUT configured to transmit continuously:

Operated Mode for Worst Duty Cycle	
Test Signal Duty Cycle (x)	Average correction factor (dB)
100% - IEEE 802.11b	0
100% - IEEE 802.11g	0
100% - IEEE 802.11n (HT20)	0

2.3 BLOCK DIGRAM SHOWING THE CONFIGURATION OF SYSTEM TESTED

Conducted Emission Test

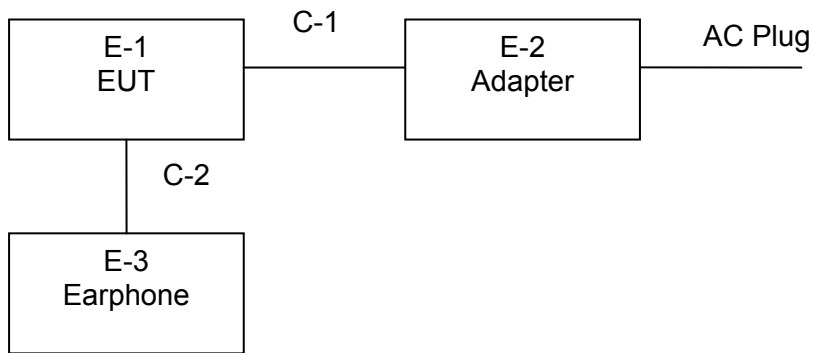

Radiated Spurious Emission Test

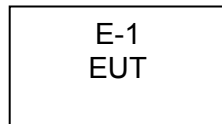

2.4 DESCRIPTION OF SUPPORT UNITS(CONDUCTED MODE)

The EUT has been tested as an independent unit together with other necessary accessories or support units. The following support units or accessories were used to form a representative test configuration during the tests.

Item	Equipment	Brand	Model/Type No.	Series No.	Note
E-1	Tablet PC	Bmorn	W7421	N/A	EUT
E-2	ADAPTER	N/A	SA/12PA/05FUS050200	N/A	
E-3	Earphone	N/A	2688	N/A	

Item	Shielded Type	Ferrite Core	Length	Note
C-1	NO	NO	1.2m	
C-2	NO	NO	1.0m	

Note:

- (1) The support equipment was authorized by Declaration of Confirmation.
- (2) For detachable type I/O cable should be specified the length in cm in 『Length』 column.

2.5 EQUIPMENTS LIST FOR ALL TEST ITEMS

Radiation Test equipment

Item	Kind of Equipment	Manufacturer	Type No.	Serial No.	Last calibration	Calibrated until	Calibration period
1	Spectrum Analyzer	Agilent	E4407B	MY45108040	2015.07.06	2016.07.05	1 year
2	Test Receiver	R&S	ESPI	101318	2015.06.07	2016.06.06	1 year
3	Bilog Antenna	TESEQ	CBL6111D	31216	2015.07.06	2016.07.05	1 year
4	50Ω Coaxial Switch	Anritsu	MP59B	6200264416	2015.06.07	2016.06.06	1 year
5	Spectrum Analyzer	ADVANTEST	R3132	150900201	2015.06.07	2016.06.06	1 year
6	Horn Antenna	EM	EM-AH-10180	2011071402	2015.07.06	2016.07.05	1 year
7	Horn Ant	Schwarzbeck	BBHA 9170	9170-181	2015.07.06	2016.07.05	1 year
8	Amplifier	EM	EM-30180	060538	2014.12.22	2015.12.21	1 year
9	Loop Antenna	ARA	PLA-1030/B	1029	2015.06.08	2016.06.07	1 year
10	Power Meter	R&S	NRVS	100696	2015.07.06	2016.07.05	1 year
11	Power Sensor	R&S	URV5-Z4	0395.1619.05	2015.07.06	2016.07.05	1 year
12	Test Cable	N/A	R-01	N/A	2015.07.06	2016.07.05	1 year
13	Test Cable	N/A	R-02	N/A	2015.06.07	2016.06.06	1 year

Conduction Test equipment

Item	Kind of Equipment	Manufacturer	Type No.	Serial No.	Last calibration	Calibrated until	Calibration period
1	Test Receiver	R&S	ESCI	101160	2015.06.06	2016.06.05	1 year
2	LISN	R&S	ENV216	101313	2015.08.24	2016.08.23	1 year
3	LISN	EMCO	3816/2	00042990	2015.08.24	2016.08.23	1 year
4	50Ω Coaxial Switch	Anritsu	MP59B	6200264417	2015.06.07	2016.06.06	1 year
5	Passive Voltage Probe	R&S	ESH2-Z3	100196	2015.06.07	2016.06.06	1 year
6	Absorbing clamp	R&S	MOS-21	100423	2015.06.08	2016.06.07	1 year
7	Test Cable	N/A	C01	N/A	2014.06.08	2015.06.07	1 year
8	Test Cable	N/A	C02	N/A	2014.06.08	2015.06.07	1 year
9	Test Cable	N/A	C03	N/A	2014.06.08	2015.06.07	1 year

1	Attenuation	MCE	24-10-34	BN9258	2015.06.08	2016.06.07	1 year
---	-------------	-----	----------	--------	------------	------------	--------

3. EMC EMISSION TEST

3.1 CONDUCTED EMISSION MEASUREMENT

3.1.1 POWER LINE CONDUCTED EMISSION Limits (Frequency Range 150KHz-30MHz)

FREQUENCY (MHz)	Class A (dBuV)		Class B (dBuV)		Standard
	Quasi-peak	Average	Quasi-peak	Average	
0.15 -0.5	79.00	66.00	66 - 56 *	56 - 46 *	CISPR
0.50 -5.0	73.00	60.00	56.00	46.00	CISPR
5.0 -30.0	73.00	60.00	60.00	50.00	CISPR

0.15 -0.5	79.00	66.00	66 - 56 *	56 - 46 *	FCC
0.50 -5.0	73.00	60.00	56.00	46.00	FCC
5.0 -30.0	73.00	60.00	60.00	50.00	FCC

Note:

- (1) The tighter limit applies at the band edges.
- (2) The limit of " * " marked band means the limitation decreases linearly with the logarithm of the frequency in the range.

The following table is the setting of the receiver

Receiver Parameters	Setting
Attenuation	10 dB
Start Frequency	0.15 MHz
Stop Frequency	30 MHz
IF Bandwidth	9 kHz

3.1.2 TEST PROCEDURE

- a. The EUT was placed 0.8 meters from the horizontal ground plane with EUT being connected to the power mains through a line impedance stabilization network (LISN). All other support equipments powered from additional LISN(s). The LISN provide 50 Ohm/ 50uH of coupling impedance for the measuring instrument.
- b. Interconnecting cables that hang closer than 40 cm to the ground plane shall be folded back and forth in the center forming a bundle 30 to 40 cm long.
- c. I/O cables that are not connected to a peripheral shall be bundled in the center. The end of the cable may be terminated, if required, using the correct terminating impedance. The overall length shall not exceed 1 m.
- d. LISN at least 80 cm from nearest part of EUT chassis.
- e. For the actual test configuration, please refer to the related Item –EUT Test Photos.

3.1.3 DEVIATION FROM TEST STANDARD

No deviation

3.1.4 TEST SETUP

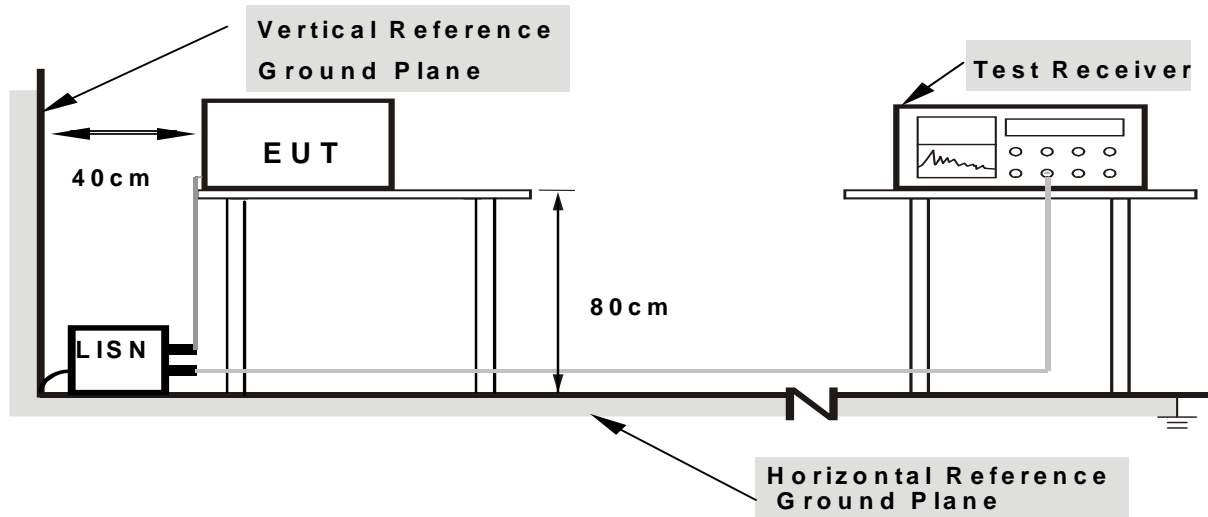

- Note:**
- 1. Support units were connected to second LISN.
 - 2. Both of LISNs (AMN) are 80 cm from EUT and at least 80 from other units and other metal planes

3.1.5 EUT OPERATING CONDITIONS

The EUT was configured for testing in a typical fashion (as a customer would normally use it). The EUT has been programmed to continuously transmit during test. This operating condition was tested and used to collect the included data.

3.1.6 TEST RESULTS

EUT :	Tablet PC	Model Name. :	W7421
Temperature :	26 °C	Relative Humidity :	56%
Pressure :	1010hPa	Phase :	L
Test Voltage :	DC 5V form Adapter AC 120V/60Hz	Test Mode :	Mode 4

Frequency	Reading Level	Correct Factor	Measure-ment	Limits	Margin	Remark
(MHz)	(dBμV)	(dB)	(dBμV)	(dBμV)	(dB)	
0.1900	44.62	9.61	54.23	64.03	-9.80	QP
0.1900	37.32	9.61	46.93	54.03	-7.10	AVG
0.2540	43.25	9.61	52.86	61.62	-8.76	QP
0.2540	34.95	9.61	44.56	51.62	-7.06	AVG
0.3820	40.46	9.63	50.09	58.23	-8.14	QP
0.3820	33.82	9.63	43.45	48.23	-4.78	AVG
0.5738	40.23	9.67	49.90	56.00	-6.10	QP
0.5738	32.58	9.67	42.25	46.00	-3.75	AVG
0.6979	40.33	9.64	49.97	56.00	-6.03	QP
0.6979	32.54	9.64	42.18	46.00	-3.82	AVG
1.1140	40.93	9.60	50.53	56.00	-5.47	QP
1.1140	31.29	9.60	40.89	46.00	-5.11	AVG

Remark:

1. All readings are Quasi-Peak and Average values.
2. Factor = Insertion Loss + Cable Loss.

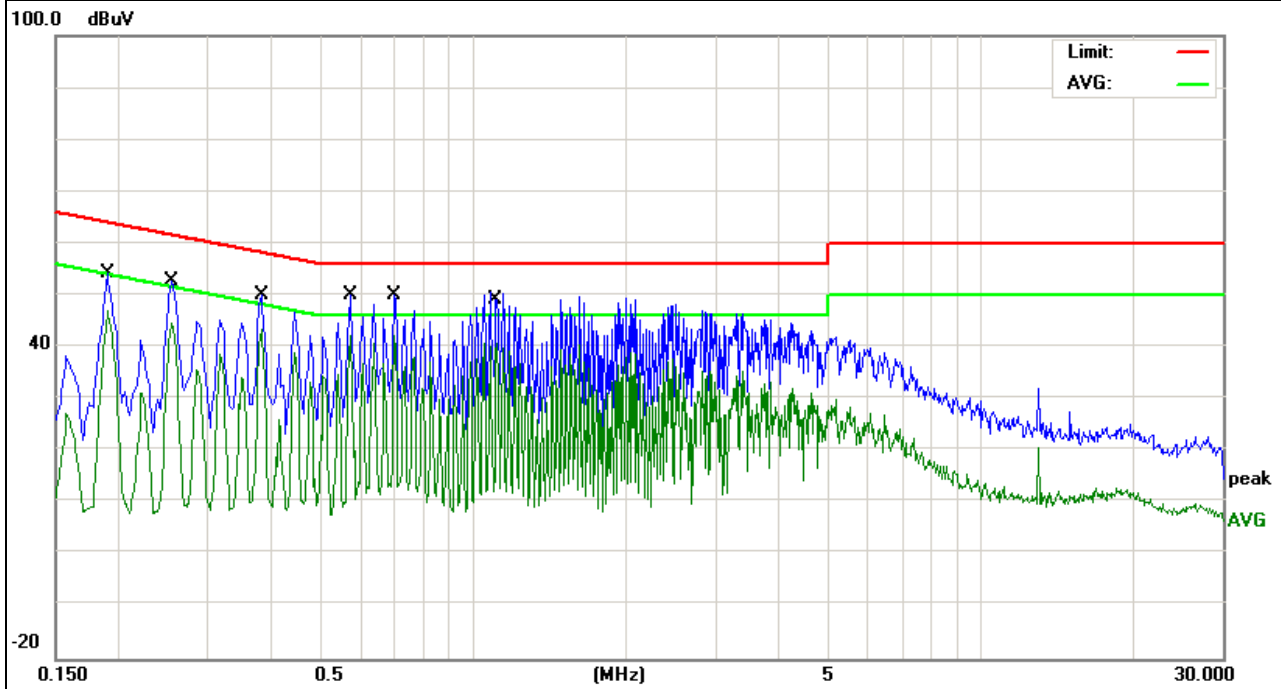

EUT :	Tablet PC	Model Name. :	W7421
Temperature :	26 °C	Relative Humidity :	56%
Pressure :	1010hPa	Phase :	N
Test Voltage :	DC 5V form Adapter AC 120V/60Hz	Test Mode :	Mode 4

Frequency (MHz)	Meter Reading (dBμV)	Factor (dB)	Emission Level (dBμV)	Limits (dBμV)	Margin (dB)	Remark
0.2540	38.43	9.61	48.04	61.62	-13.58	QP
0.2540	28.90	9.61	38.51	51.62	-13.11	AVG
0.3820	36.60	9.63	46.23	58.23	-12.00	QP
0.3820	27.18	9.63	36.81	48.23	-11.42	AVG
0.4460	35.06	9.66	44.72	56.95	-12.23	QP
0.4460	25.04	9.66	34.70	46.95	-12.25	AVG
0.7019	36.05	9.64	45.69	56.00	-10.31	QP
0.7019	27.08	9.64	36.72	46.00	-9.28	AVG
1.2380	33.93	9.59	43.52	56.00	-12.48	QP
1.2380	24.09	9.59	33.68	46.00	-12.32	AVG
2.4820	30.68	9.53	40.21	56.00	-15.79	QP
2.4820	22.17	9.53	31.70	46.00	-14.30	AVG

Remark:
 1. All readings are Quasi-Peak and Average values.
 2. Factor = Insertion Loss + Cable Loss.

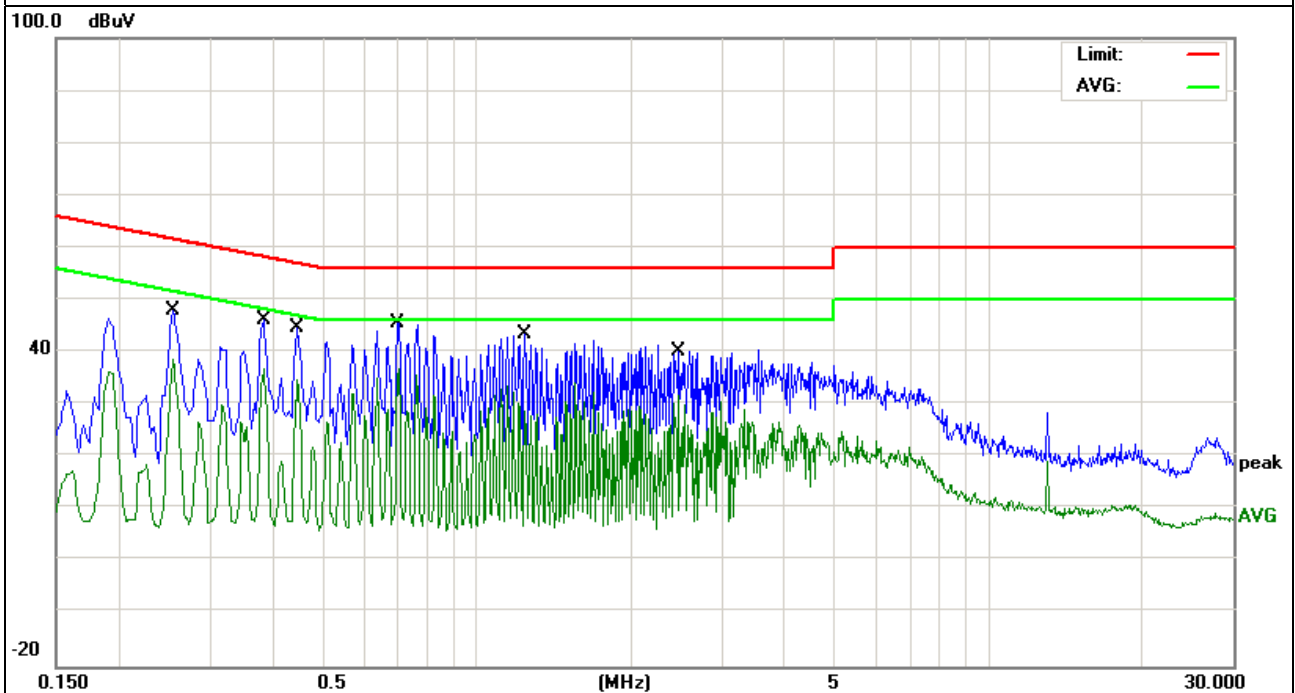

EUT :	Tablet PC	Model Name :	W7421
Temperature :	26 °C	Relative Humidity :	54%
Pressure :	1010hPa	Phase :	L
Test Voltage :	DC 5.0V from adapter AC 240V/60Hz	Test Mode :	Mode 4

Frequency (MHz)	Reading Level (dBμV)	Correct Factor (dB)	Measure-ment (dBμV)	Limits (dBμV)	Margin (dB)	Remark
0.1900	44.60	9.61	54.21	64.03	-9.82	QP
0.1900	36.74	9.61	46.35	54.03	-7.68	AVG
0.2540	43.24	9.61	52.85	61.62	-8.77	QP
0.2540	36.34	9.61	45.95	51.62	-5.67	AVG
0.3820	38.99	9.63	48.62	58.23	-9.61	QP
0.3820	32.27	9.63	41.90	48.23	-6.33	AVG
0.6979	41.89	9.64	51.53	56.00	-4.47	QP
0.6979	33.19	9.64	42.83	46.00	-3.17	AVG
1.1140	39.44	9.60	49.04	56.00	-6.96	QP
1.1140	28.91	9.60	38.51	46.00	-7.49	AVG
1.6180	40.00	9.57	49.57	56.00	-6.43	QP
1.6180	30.13	9.57	39.70	46.00	-6.30	AVG

Remark:

1. All readings are Quasi-Peak and Average values.
2. Factor = Insertion Loss + Cable Loss.

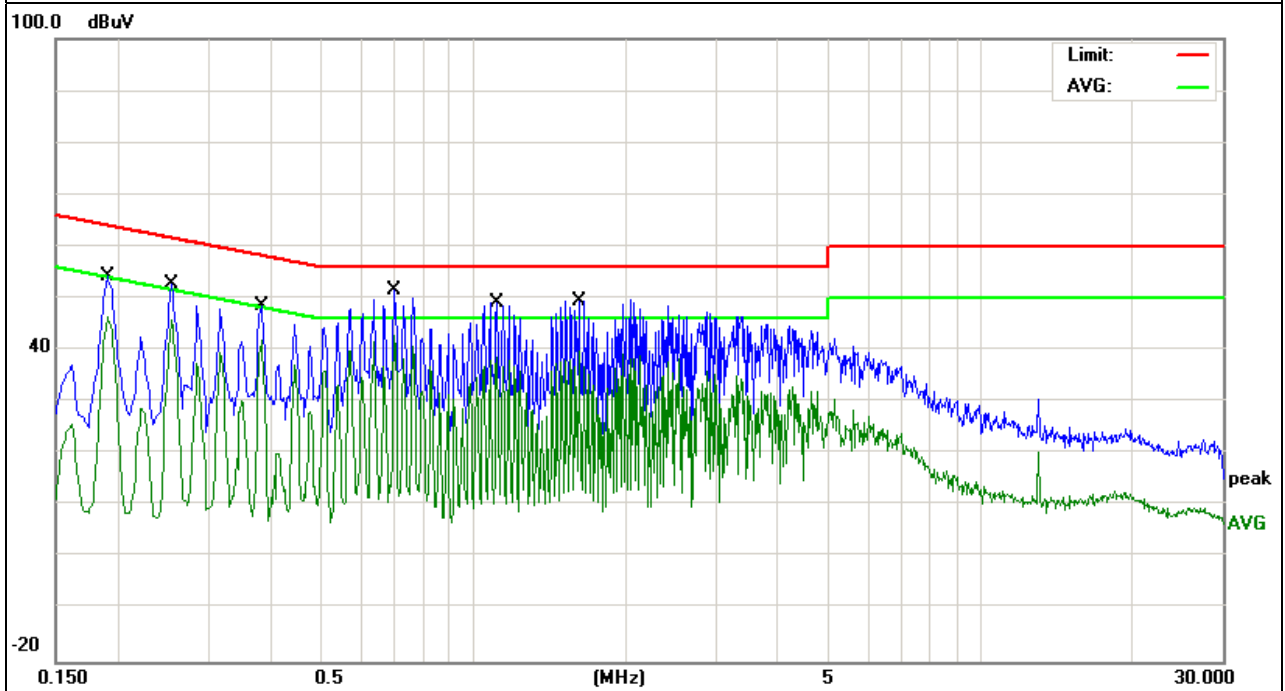

EUT :	Tablet PC	Model Name :	W7421
Temperature :	26 °C	Relative Humidity :	54%
Pressure :	1010hPa	Phase :	N
Test Voltage :	DC 5.0V from adapter AC 240V/60Hz	Test Mode :	Mode 4

Frequency (MHz)	Reading Level (dBμV)	Correct Factor (dB)	Measure-ment (dBμV)	Limits (dBμV)	Margin (dB)	Remark
0.1900	37.71	9.61	47.32	64.03	-16.71	QP
0.1900	28.71	9.61	38.32	54.03	-15.71	AVG
0.2540	37.59	9.61	47.20	61.62	-14.42	QP
0.2540	26.39	9.61	36.00	51.62	-15.62	AVG
0.3820	38.58	9.63	48.21	58.23	-10.02	QP
0.3820	29.06	9.63	38.69	48.23	-9.54	AVG
0.6980	37.23	9.64	46.87	56.00	-9.13	QP
0.6980	27.12	9.64	36.76	46.00	-9.24	AVG
1.2700	34.85	9.59	44.44	56.00	-11.56	QP
1.2700	23.83	9.59	33.42	46.00	-12.58	AVG
2.1580	32.29	9.54	41.83	56.00	-14.17	QP
2.1580	22.19	9.54	31.73	46.00	-14.27	AVG

Remark:

1. All readings are Quasi-Peak and Average values.
2. Factor = Insertion Loss + Cable Loss.

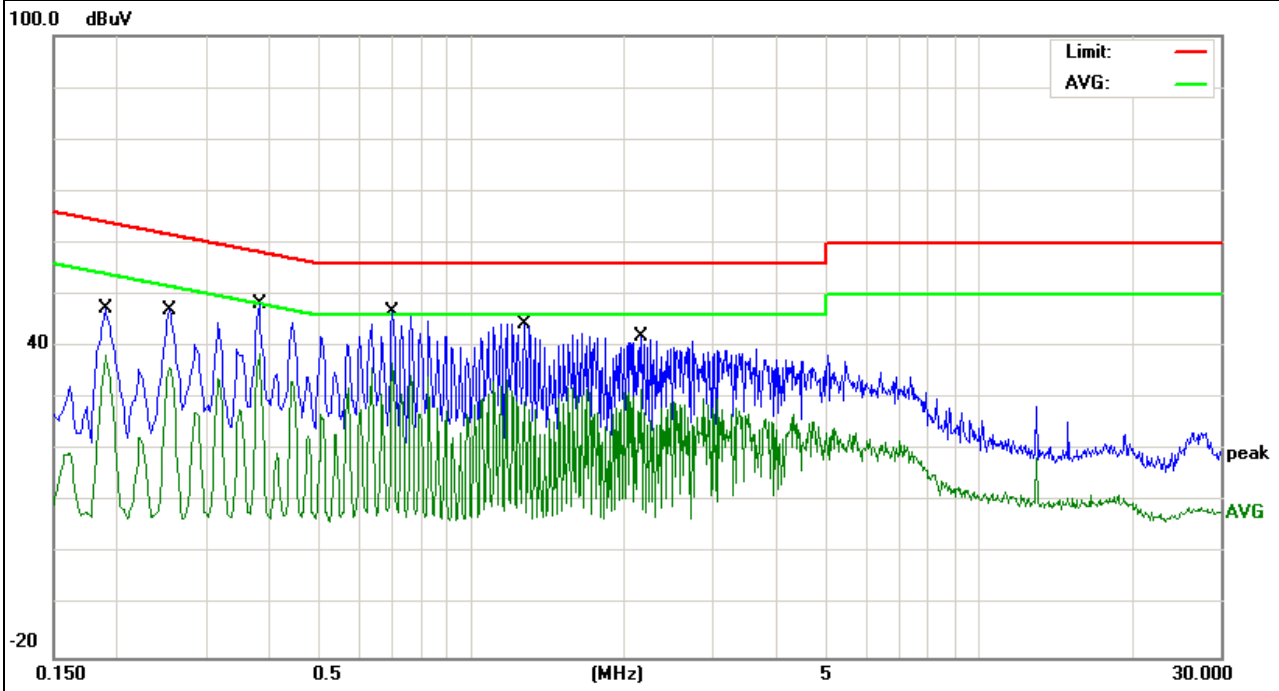

EUT :	Tablet PC	Model Name. :	W7421
Temperature :	26 °C	Relative Humidity :	56%
Pressure :	1010hPa	Phase :	L
Test Voltage :	DC 5.0V form PC AC 120V/60Hz	Test Mode :	Mode 4

Frequency (MHz)	Meter Reading (dBμV)	Factor (dB)	Emission Level (dBμV)	Limits (dBμV)	Margin (dB)	Remark
0.1500	40.77	9.60	50.37	65.99	-15.62	QP
0.1500	29.01	9.60	38.61	55.99	-17.38	AVG
0.1940	34.82	9.61	44.43	63.86	-19.43	QP
0.1940	25.36	9.61	34.97	53.86	-18.89	AVG
0.6900	34.09	9.64	43.73	56.00	-12.27	QP
0.6900	23.68	9.64	33.32	46.00	-12.68	AVG
3.5580	34.33	9.52	43.85	56.00	-12.15	QP
3.5580	23.00	9.52	32.52	46.00	-13.48	AVG
7.4419	30.62	9.53	40.15	60.00	-19.85	QP
7.4419	21.08	9.53	30.61	50.00	-19.39	AVG
17.9500	36.10	9.80	45.90	60.00	-14.10	QP
17.9500	24.32	9.80	34.12	50.00	-15.88	AVG

Remark:
 1. All readings are Quasi-Peak and Average values.
 2. Factor = Insertion Loss + Cable Loss.

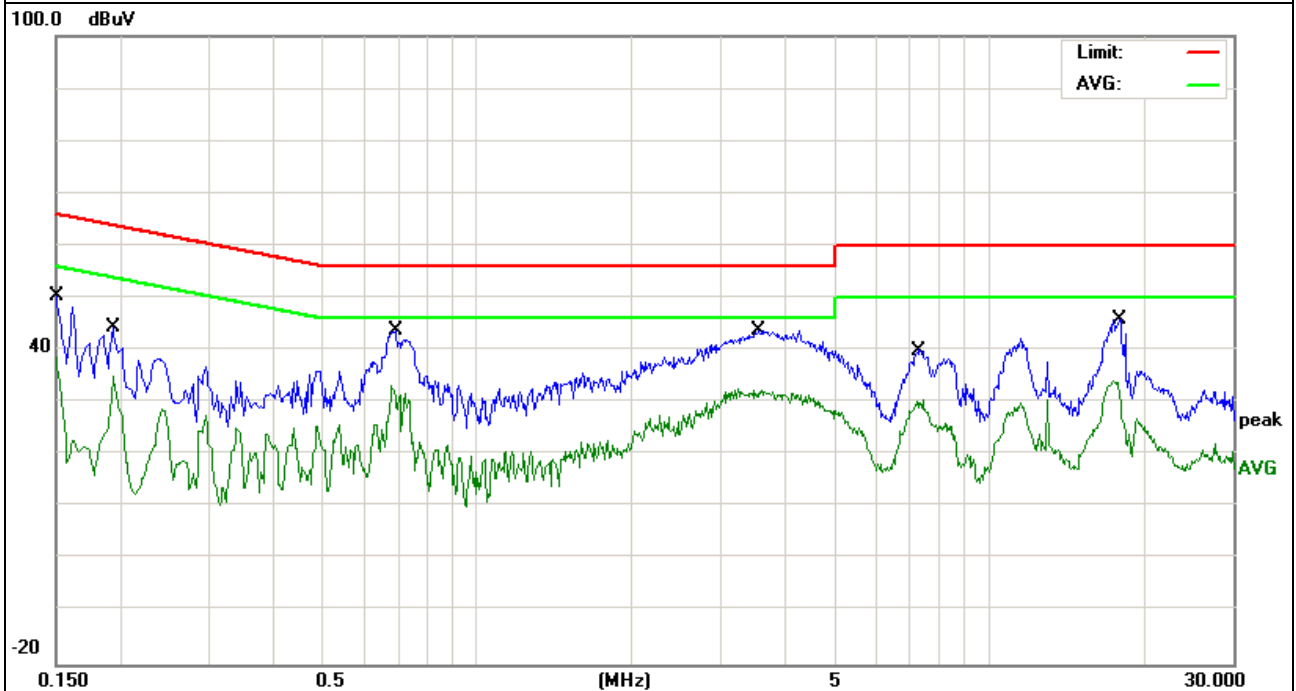

EUT :	Tablet PC	Model Name. :	W7421
Temperature :	26 °C	Relative Humidity :	56%
Pressure :	1010hPa	Phase :	N
Test Voltage :	DC 5.0V form PC AC 120V/60Hz	Test Mode :	Mode 4

Frequency (MHz)	Meter Reading (dBμV)	Factor (dB)	Emission Level (dBμV)	Limits (dBμV)	Margin (dB)	Remark
0.1580	42.39	9.60	51.99	65.56	-13.57	QP
0.1580	29.75	9.60	39.35	55.56	-16.21	AVG
0.1940	34.90	9.61	44.51	63.86	-19.35	QP
0.1940	24.76	9.61	34.37	53.86	-19.49	AVG
0.7180	35.34	9.64	44.98	56.00	-11.02	QP
0.7180	23.50	9.64	33.14	46.00	-12.86	AVG
1.5020	31.41	9.57	40.98	56.00	-15.02	QP
1.5020	20.52	9.57	30.09	46.00	-15.91	AVG
4.8859	32.57	9.51	42.08	56.00	-13.92	QP
4.8859	22.68	9.51	32.19	46.00	-13.81	AVG
17.6020	34.08	9.80	43.88	60.00	-16.12	QP
17.6020	23.05	9.80	32.85	50.00	-17.15	AVG

Remark:
 1. All readings are Quasi-Peak and Average values.
 2. Factor = Insertion Loss + Cable Loss.

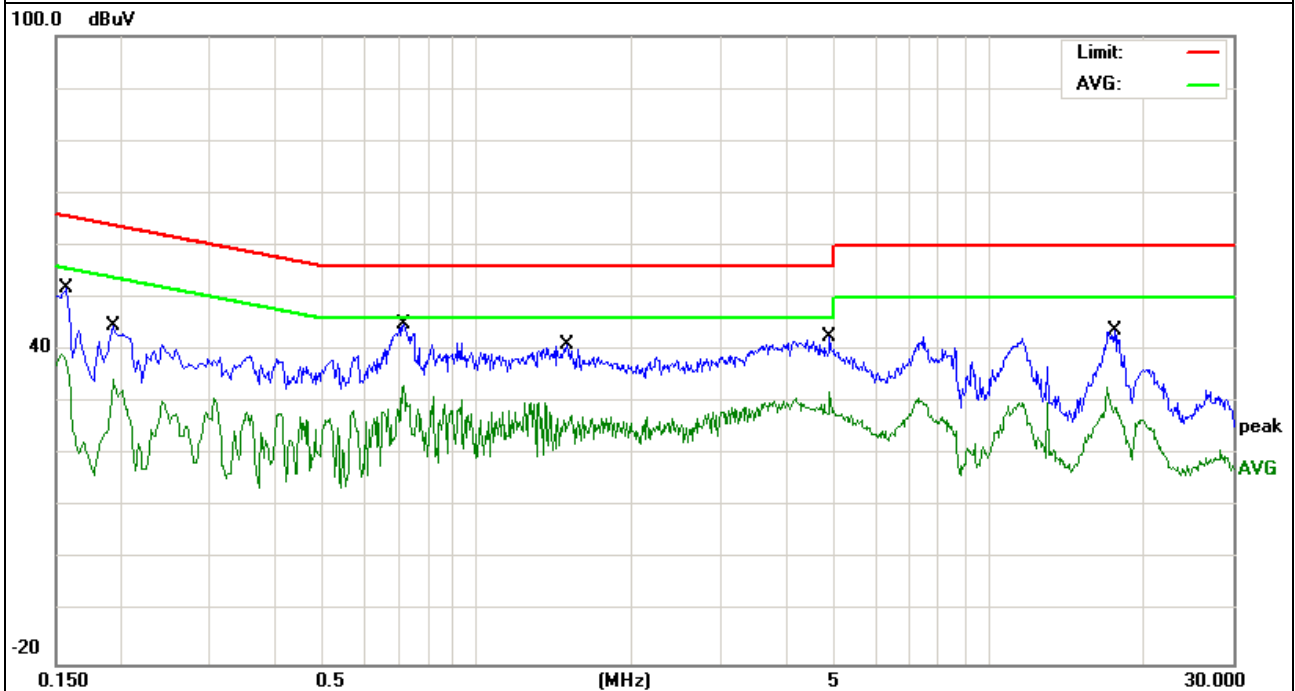

EUT :	Tablet PC	Model Name :	W7421
Temperature :	26 °C	Relative Humidity :	54%
Pressure :	1010hPa	Phase :	L
Test Voltage :	DC 5.0V from PC AC 240V/60Hz	Test Mode :	Mode 4

Frequency (MHz)	Reading Level (dBμV)	Correct Factor (dB)	Measure-ment (dBμV)	Limits (dBμV)	Margin (dB)	Remark
0.1500	40.77	9.60	50.37	65.99	-15.62	QP
0.1500	29.01	9.60	38.61	55.99	-17.38	AVG
0.1940	34.82	9.61	44.43	63.86	-19.43	QP
0.1940	25.36	9.61	34.97	53.86	-18.89	AVG
0.6900	34.09	9.64	43.73	56.00	-12.27	QP
0.6900	23.68	9.64	33.32	46.00	-12.68	AVG
3.5580	34.33	9.52	43.85	56.00	-12.15	QP
3.5580	23.00	9.52	32.52	46.00	-13.48	AVG
7.4419	30.62	9.53	40.15	60.00	-19.85	QP
7.4419	21.08	9.53	30.61	50.00	-19.39	AVG
17.9500	36.10	9.80	45.90	60.00	-14.10	QP
17.9500	24.32	9.80	34.12	50.00	-15.88	AVG

Remark:

1. All readings are Quasi-Peak and Average values.
2. Factor = Insertion Loss + Cable Loss.

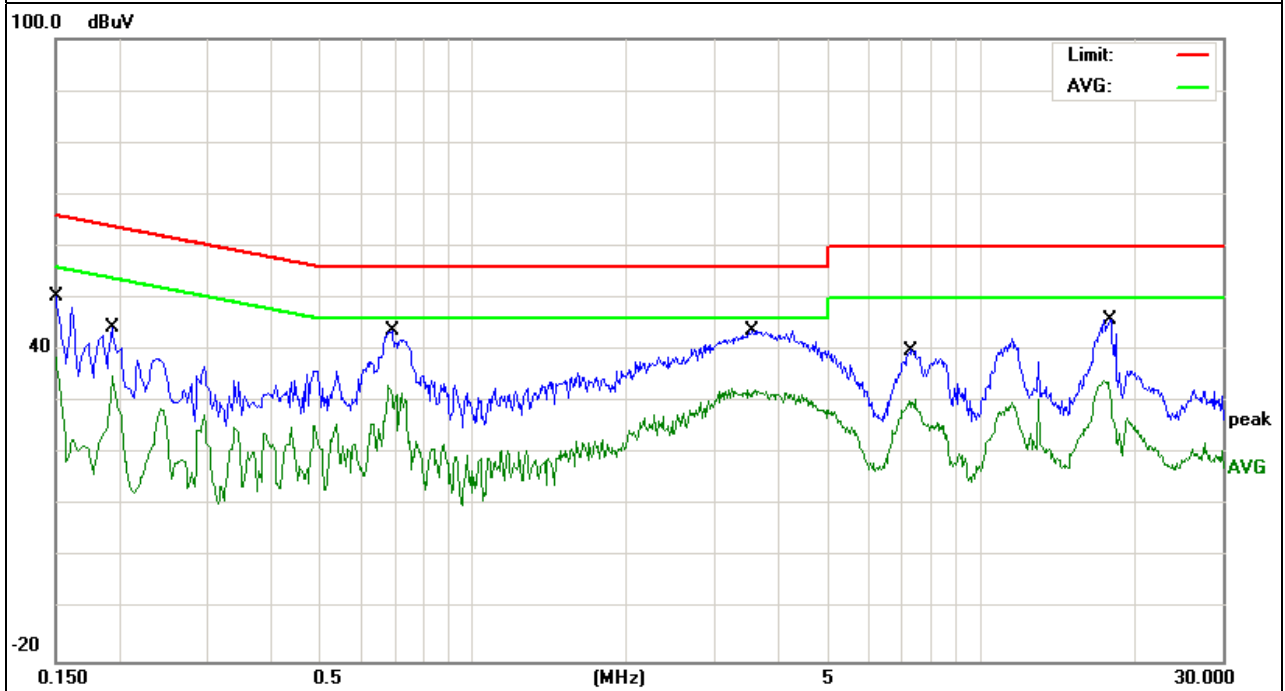

EUT :	Tablet PC	Model Name :	W7421
Temperature :	26 °C	Relative Humidity :	54%
Pressure :	1010hPa	Phase :	N
Test Voltage :	DC 5.0V from PC AC 240V/60Hz	Test Mode :	Mode 4

Frequency (MHz)	Reading Level (dBμV)	Correct Factor (dB)	Measure-ment (dBμV)	Limits (dBμV)	Margin (dB)	Remark
0.1539	38.17	9.60	47.77	65.78	-18.01	QP
0.1539	24.36	9.60	33.96	55.78	-21.82	AVG
0.1940	36.38	9.61	45.99	63.86	-17.87	QP
0.1940	24.66	9.61	34.27	53.86	-19.59	AVG
0.2419	29.27	9.61	38.88	62.03	-23.15	QP
0.2419	20.11	9.61	29.72	52.03	-22.31	AVG
0.6820	33.80	9.64	43.44	56.00	-12.56	QP
0.6820	21.96	9.64	31.60	46.00	-14.40	AVG
3.7700	33.87	9.51	43.38	56.00	-12.62	QP
3.7700	23.23	9.51	32.74	46.00	-13.26	AVG
11.7619	33.12	9.70	42.82	60.00	-17.18	QP
11.7619	19.09	9.70	28.79	50.00	-21.21	AVG

Remark:

1. All readings are Quasi-Peak and Average values.
2. Factor = Insertion Loss + Cable Loss.

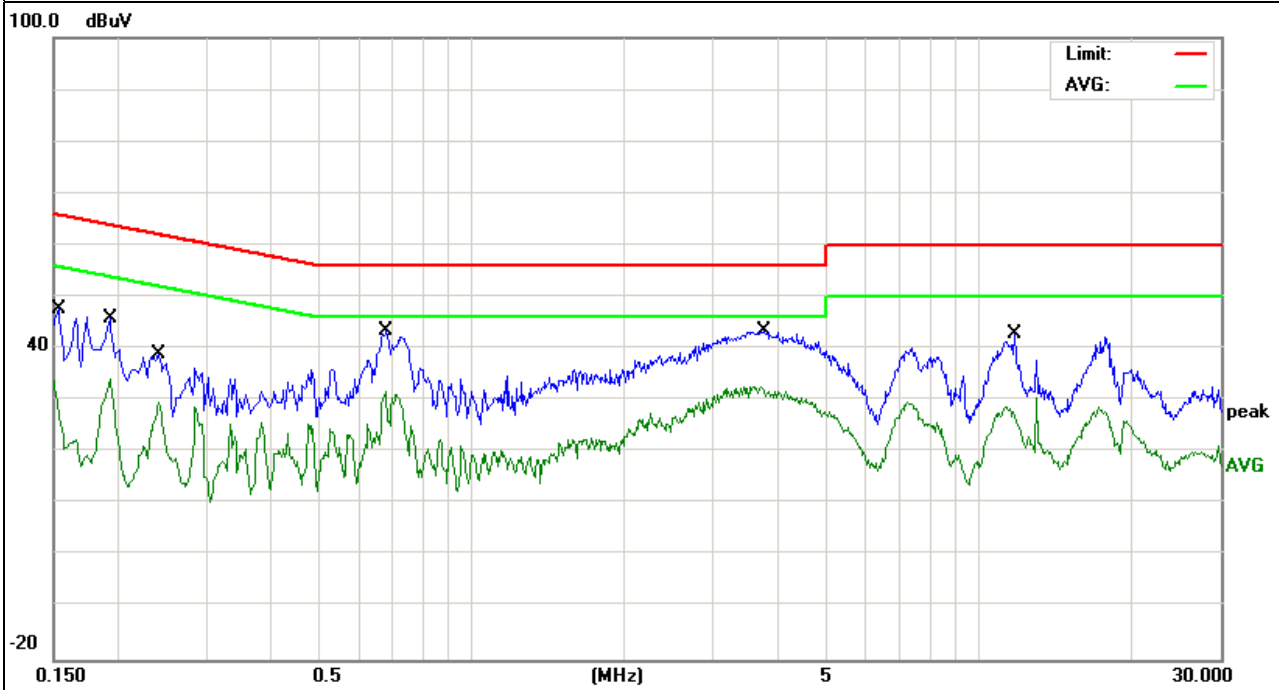

3.2 RADIATED EMISSION MEASUREMENT

3.2.1 RADIATED EMISSION LIMITS (Frequency Range 9kHz-1000MHz)

20dBc in any 100 kHz bandwidth outside the operating frequency band. In case the emission fall within the restricted band specified on 15.205(a), then the 15.209(a) limit in the table below has to be followed.

Frequencies (MHz)	Field Strength (microrvolts/meter)	Measurement Distance (meters)
0.009~0.490	2400/F(KHz)	300
0.490~1.705	24000/F(KHz)	30
1.705~30.0	30	30
30~88	100	3
88~216	150	3
216~960	200	3
Above 960	500	3

LIMITS OF RADIATED EMISSION MEASUREMENT (Above 1000MHz)

FREQUENCY (MHz)	Class B (dBuV/m) (at 3M)	
	PEAK	AVERAGE
Above 1000	74	54

Notes:

- (1) The limit for radiated test was performed according to FCC PART 15C.
- (2) The tighter limit applies at the band edges.
- (3) Emission level (dBuV/m)=20log Emission level (uV/m).

Spectrum Parameter	Setting
Attenuation	Auto
Start Frequency	1000 MHz
Stop Frequency	10th carrier harmonic
RB / VB (emission in restricted band)	1 MHz / 1 MHz for Peak, 1 MHz / 10Hz for Average

Receiver Parameter	Setting
Attenuation	Auto
Start ~ Stop Frequency	9kHz~150kHz / RB 200Hz for QP
Start ~ Stop Frequency	150kHz~30MHz / RB 9kHz for QP
Start ~ Stop Frequency	30MHz~1000MHz / RB 120kHz for QP

3.2.2 TEST PROCEDURE

- a. The measuring distance of at 3 m shall be used for measurements at frequency up to 1GHz. For frequencies above 1GHz, any suitable measuring distance may be used.
- b. The EUT was placed on the top of a rotating table 0.8 m for below 1GHz and 1.5m for above 1GHz the ground at a 3 meter open area test site. The table was rotated 360 degrees to determine the position of the highest radiation.
- c. The height of the equipment or of the substitution antenna shall be 0.8 m for below 1GHz and 1.5m for above 1GHz; the height of the test antenna shall vary between 1 m to 4 m. Both horizontal and vertical polarizations of the antenna are set to make the measurement.
- d. The initial step in collecting conducted emission data is a spectrum analyzer peak detector mode pre-scanning the measurement frequency range. Significant peaks are then marked and then Quasi Peak detector mode re-measured.
- e. If the Peak Mode measured value compliance with and lower than Quasi Peak Mode Limit, the EUT shall be deemed to meet QP Limits and then no additional QP Mode measurement performed.
- f. For the actual test configuration, please refer to the related Item –EUT Test Photos.

Note:

Both horizontal and vertical antenna polarities were tested and performed pretest to three orthogonal axis. The worst case emissions were reported

During the radiated emission test, the Spectrum Analyzer was set with the following configurations:

Frequency Band (MHz)	Function	Resolution bandwidth	Video Bandwidth
30 to 1000	QP	100 kHz	100 kHz
Above 1000	Peak	1 MHz	1 MHz
	Peak	1 MHz	10 Hz

3.2.3 DEVIATION FROM TEST STANDARD

No deviation

3.2.4 TEST SETUP

(A) Radiated Emission Test-Up Frequency Below 30MHz

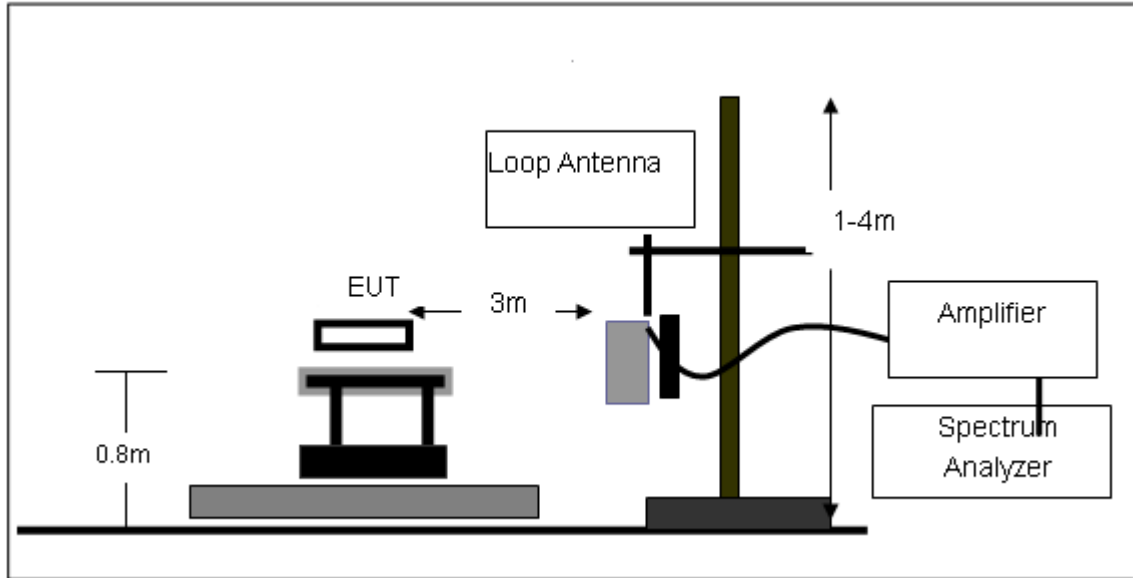

(B) Radiated Emission Test-Up Frequency 30MHz~1GHz

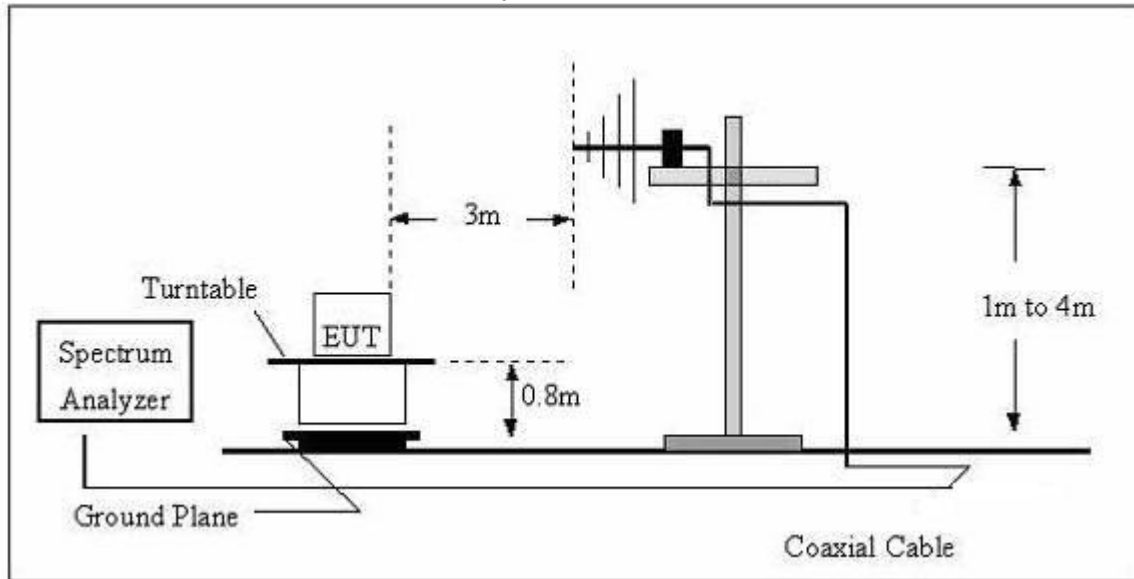

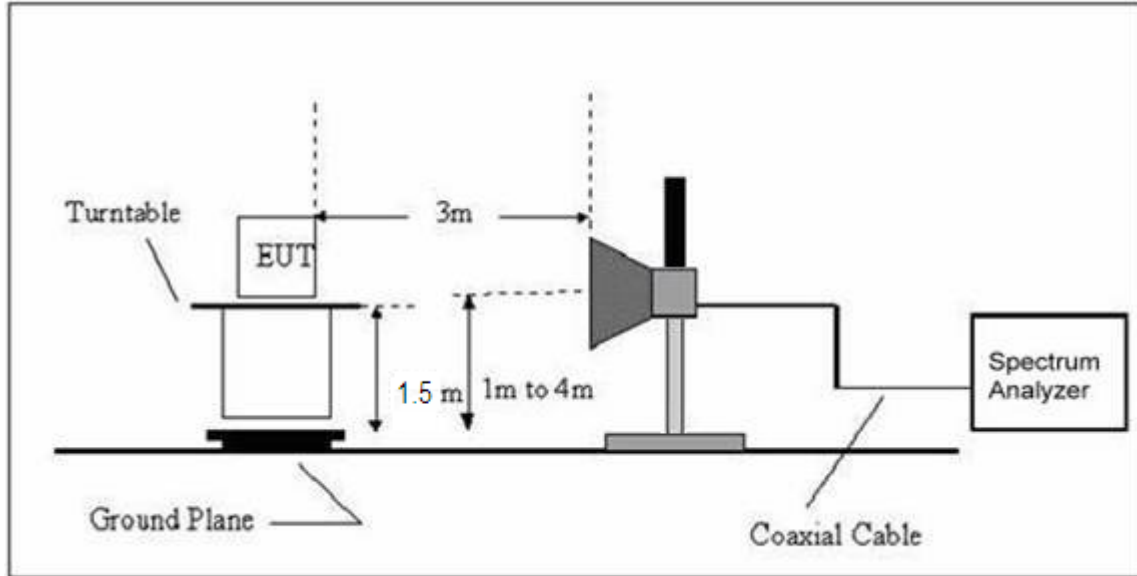
(C) Radiated Emission Test-Up Frequency Above 1GHz**3.2.5 EUT OPERATING CONDITIONS**

The EUT tested system was configured as the statements of 2.4 Unless otherwise a special operating condition is specified in the follows during the testing.

3.2.6 TEST RESULTS (BETWEEN 9KHZ – 30 MHZ)

EUT:	Tablet PC	Model Name. :	W7421
Temperature:	20 °C	Relative Humidity:	48%
Pressure:	1010 hPa	Test Voltage :	DC 3.7V
Test Mode :	TX	Polarization :	--

Freq. (MHz)	Reading (dBuV/m)	Limit (dBuV/m)	Margin (dB)	State P/F
--	--	--	--	P
--	--	--	--	P

NOTE:

The amplitude of spurious emissions which are attenuated by more than 20dB below the permissible value has no need to be reported.

Distance extrapolation factor = $40 \log (\text{specific distance}/\text{test distance})(\text{dB})$;

Limit line = specific limits(dBuv) + distance extrapolation factor.

3.2.7 TEST RESULTS (BETWEEN 30MHZ – 1GHZ)

EUT :	Tablet PC	Model Name :	W7421
Temperature :	20 °C	Relative Humidity :	48%
Pressure:	1010 hPa	Test Voltage :	DC 3.7V
Test Mode :	TX		

Polar (H/V)	Frequency	Meter Reading	Factor	Emission Level	Limits	Margin	Remark
	(MHz)	(dBuV)	(dB)	(dBuV/m)	(dBuV/m)	(dB)	
V	32.6340	16.98	18.43	35.41	40.00	-4.59	QP
V	41.2765	16.74	13.86	30.60	40.00	-9.40	QP
V	72.8465	14.17	9.72	23.89	40.00	-16.11	QP
V	109.4116	16.20	10.24	26.44	43.50	-17.06	QP
V	162.6106	19.60	11.60	31.20	43.50	-12.30	QP
V	326.7395	13.24	13.50	26.74	46.00	-19.26	QP

Remark:

Absolute Level= ReadingLevel+ Factor, Margin= Absolute Level - Limit

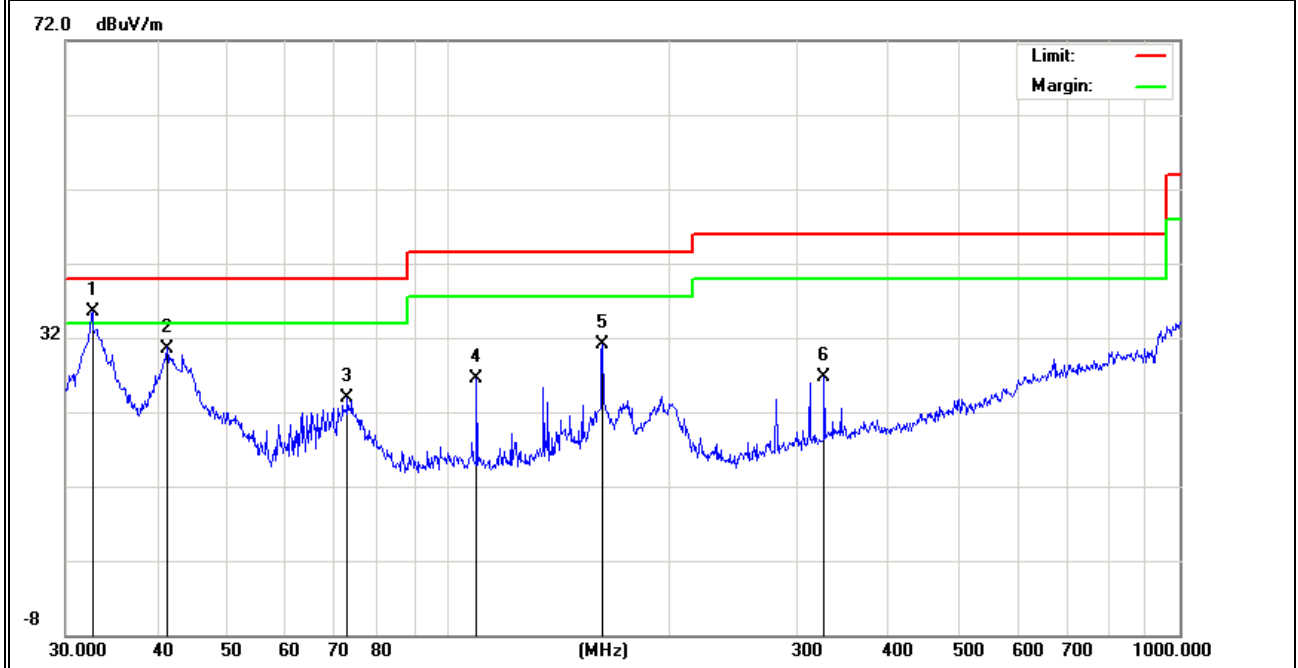

Polar (H/V)	Frequency	Meter Reading	Factor	Emission Level	Limits	Margin	Remark
	(MHz)	(dBuV)	(dB)	(dBuV/m)	(dBuV/m)	(dB)	
H	78.1389	8.67	9.48	18.15	40.00	-21.85	QP
H	162.6106	13.49	11.60	25.09	43.50	-18.41	QP
H	196.5098	10.94	11.44	22.38	43.50	-21.12	QP
H	312.1792	15.97	13.05	29.02	46.00	-16.98	QP
H	344.3854	13.63	14.00	27.63	46.00	-18.37	QP
H	390.7225	10.92	14.76	25.68	46.00	-20.32	QP

Remark:

Absolute Level= ReadingLevel+ Factor, Margin= Absolute Level - Limit

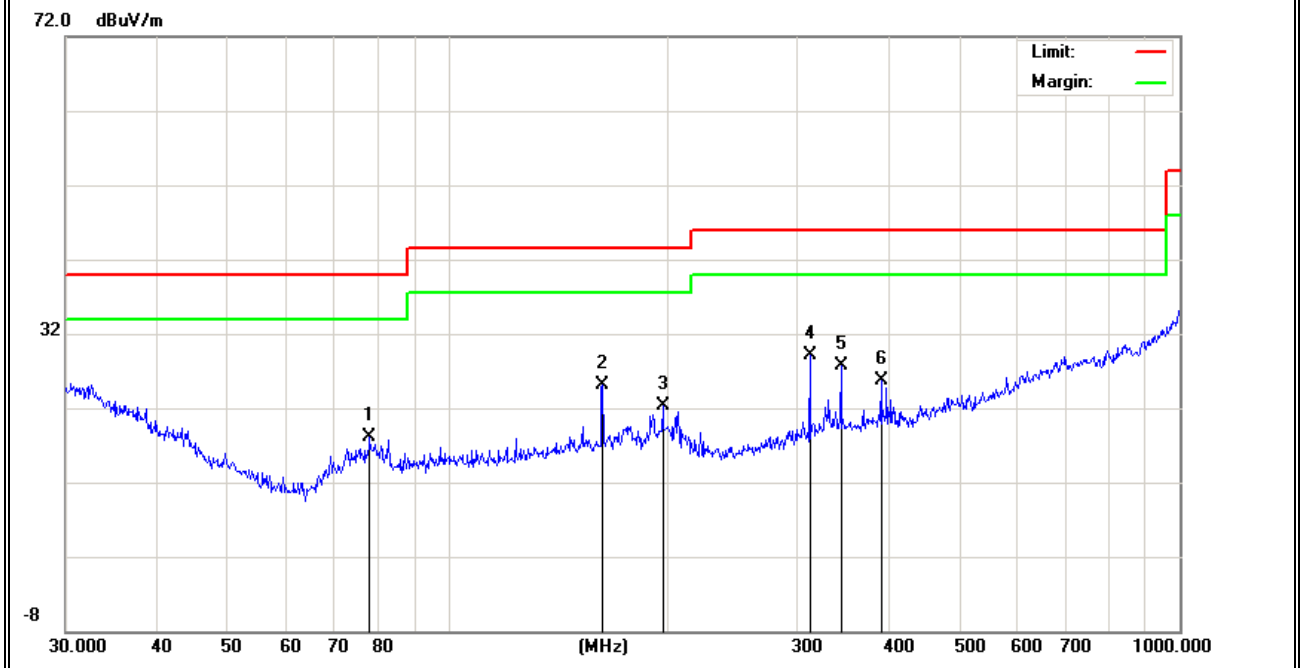

3.2.8 TEST RESULTS (ABOVE 1000 MHZ)

EUT :	Tablet PC	Model Name :	W7421
Temperature :	20 °C	Relative Humidity :	48%
Pressure:	1010 hPa	Test Voltage :	DC 3.7V
Test Mode :	TX		

Frequency (MHz)	Meter Reading (dBµV)	Factor (dB)	Emission Level (dBµV/m)	Limits (dBµV/m)	Margin (dB)	Remark	Comment
Low Channel (2412 MHz)							
4824.208	52.3	10.44	62.74	74.00	-11.26	Pk	Vertical
4824.208	34.55	10.44	44.99	54.00	-9.01	Av	Vertical
7236.195	48.78	12.39	61.17	74.00	-12.83	Pk	Vertical
7236.195	32.66	12.39	45.05	54.00	-8.95	Av	Vertical
4824.341	50.48	10.44	60.92	74.00	-13.08	Pk	Horizontal
4824.341	30.74	10.44	41.18	54.00	-12.82	Av	Horizontal
7236.116	45.62	12.39	58.01	74.00	-15.99	Pk	Horizontal
7236.116	29.13	12.39	41.52	54.00	-12.48	Av	Horizontal
Middel Channel (2437 MHz)							
4874.184	53.26	10.40	63.66	74.00	-10.34	Pk	Vertical
4874.184	31.22	10.40	41.62	54.00	-12.38	Av	Vertical
7311.123	47.87	12.75	60.62	74.00	-13.38	Pk	Vertical
7311.123	31.62	12.75	44.37	54.00	-9.63	Av	Vertical
4874.219	52.04	10.40	62.44	74.00	-11.56	Pk	Horizontal
4874.219	32.95	10.40	43.35	54.00	-10.65	Av	Horizontal
7311.137	47.76	12.75	60.51	74.00	-13.49	Pk	Horizontal
7311.137	30.92	12.75	43.67	54.00	-10.33	Av	Horizontal
High Channel (2462 MHz)							
4924.297	50.12	10.39	60.51	74.00	-13.49	Pk	Vertical
4924.297	31.47	10.39	41.86	54.00	-12.14	Av	Vertical
7386.116	45.65	12.68	58.33	74.00	-15.67	Pk	Vertical
7386.116	29.57	12.68	42.25	54.00	-11.75	Av	Vertical
4924.263	50.71	10.39	61.10	74.00	-12.90	Pk	Horizontal
4924.263	31.02	10.39	41.41	54.00	-12.59	Av	Horizontal
7386.192	48.93	12.68	61.61	74.00	-12.39	Pk	Horizontal
7386.192	32.24	12.68	44.92	54.00	-9.08	Av	Horizontal

Note: 802.11b mode is worse case.

4. POWER SPECTRAL DENSITY TEST

4.1 APPLIED PROCEDURES / LIMIT

FCC Part15 (15.247) , Subpart C				
Section	Test Item	Limit	Frequency Range (MHz)	Result
15.247	Power Spectral Density	8 dBm (in any 3KHz)	2400-2483.5	PASS

4.1.1 TEST PROCEDURE

1. Set analyzer center frequency to DTS channel center frequency.
2. Set the span to 1.5 times the DTS channel bandwidth.
3. 3 kHz ≤ Set the RBW ≤ 100 kHz.
4. Set the VBW ≥ 3 x RBW.
5. Detector = peak.
6. Sweep time = auto couple.
7. Trace mode = max hold.
8. Allow trace to fully stabilize.
9. Use the peak marker function to determine the maximum amplitude level within the RBW.
10. If measured value exceeds limit, reduce RBW (no less than 3 kHz) and repeat.

4.1.2 DEVIATION FROM STANDARD

No deviation.

4.1.3 TEST SETUP

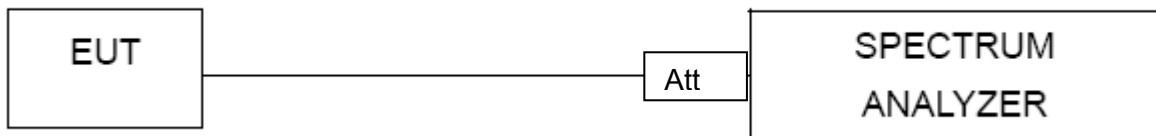

4.1.4 EUT OPERATION CONDITIONS

The EUT tested system was configured as the statements of 2.1 Unless otherwise a special operating condition is specified in the follows during the testing.

4.1.5 TEST RESULTS

EUT :	Tablet PC	Model Name :	W7421
Temperature :	25 °C	Relative Humidity :	56%
Pressure :	1015 hPa	Test Voltage :	DC 3.7V
Test Mode :	TX b Mode /CH01, CH06, CH11		

Frequency	Power Density (dBm)	Limit (dBm)	Result
2412 MHz	-13.30	8	PASS
2437 MHz	-10.89	8	PASS
2462 MHz	-10.69	8	PASS

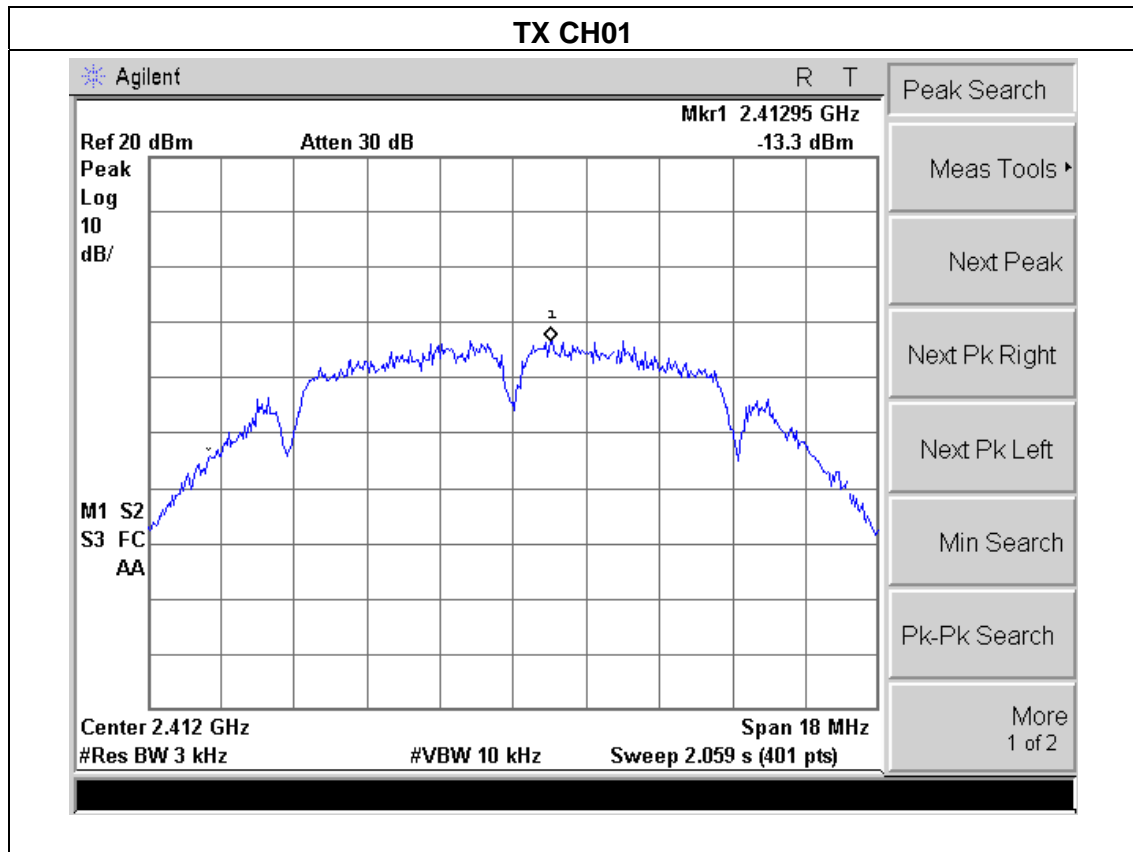

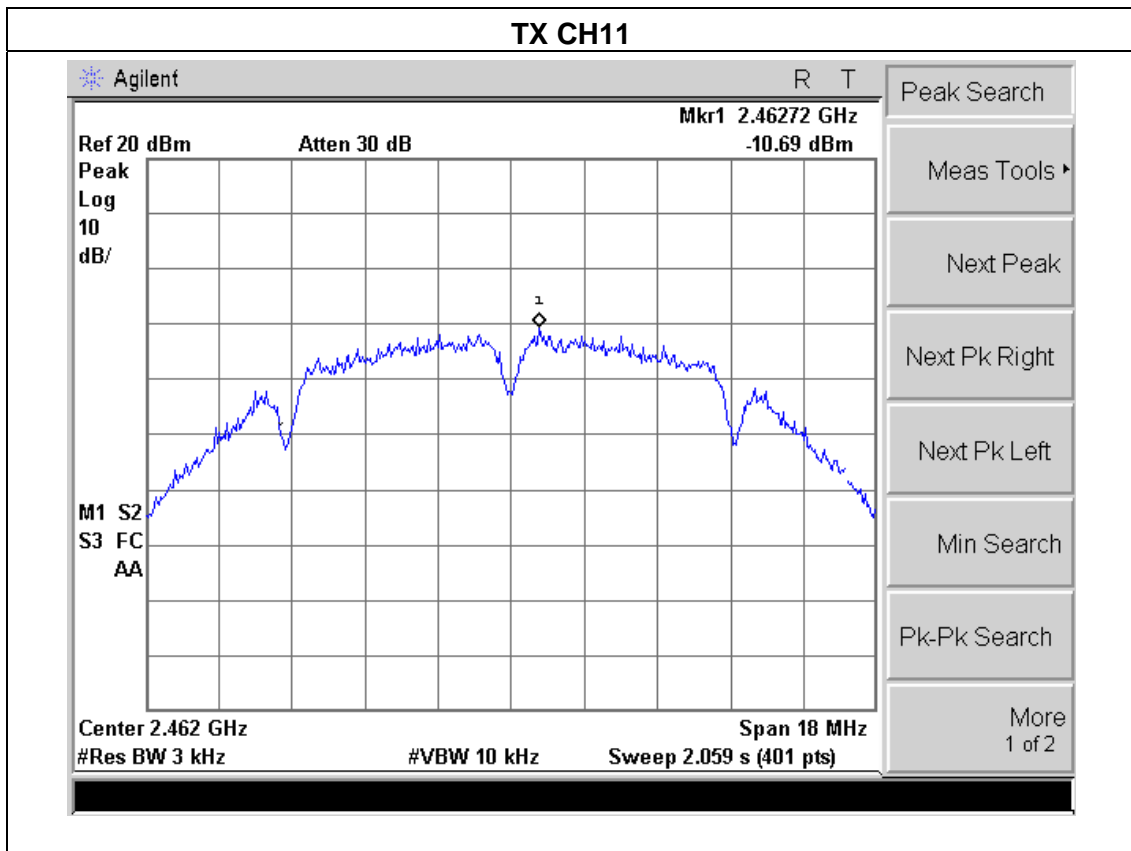
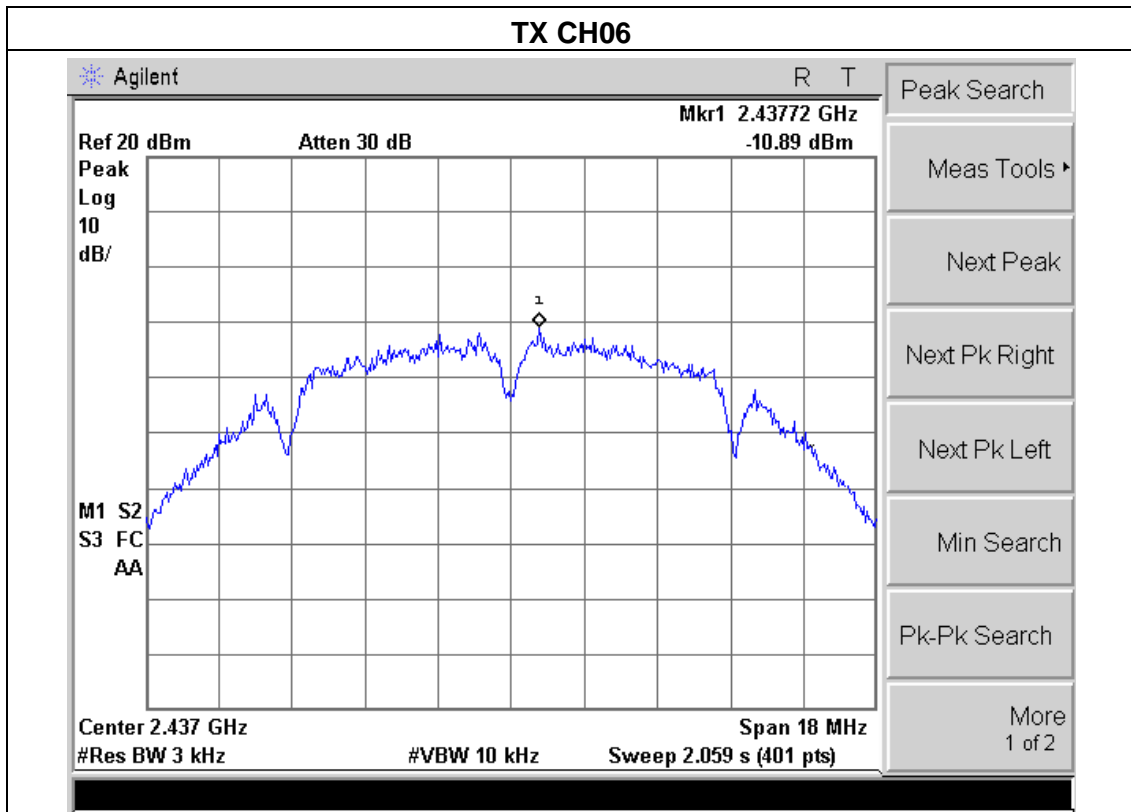

EUT :	Tablet PC	Model Name :	W7421
Temperature :	25 °C	Relative Humidity :	56%
Pressure :	1015 hPa	Test Voltage :	DC 3.7V
Test Mode :	TX g Mode /CH01, CH06, CH11		

Frequency	Power Density (dBm)	Limit (dBm)	Result
2412 MHz	-18.22	8	PASS
2437 MHz	-17.26	8	PASS
2462 MHz	-16.24	8	PASS

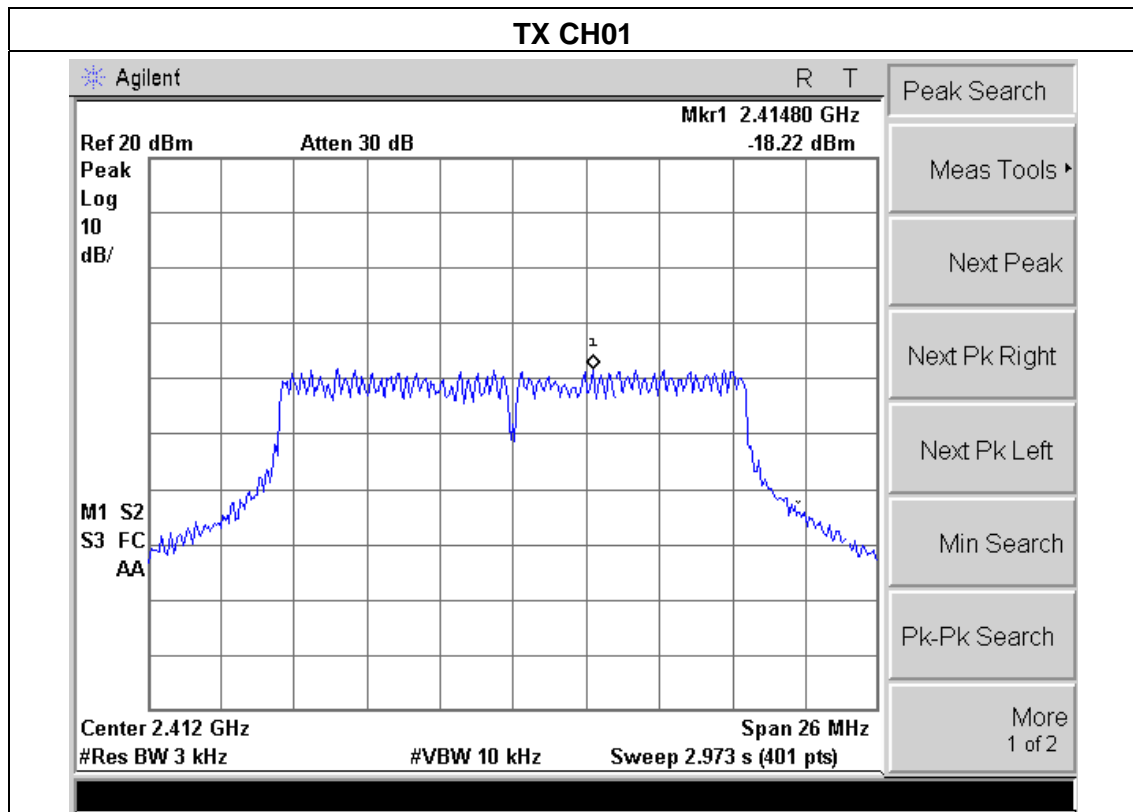

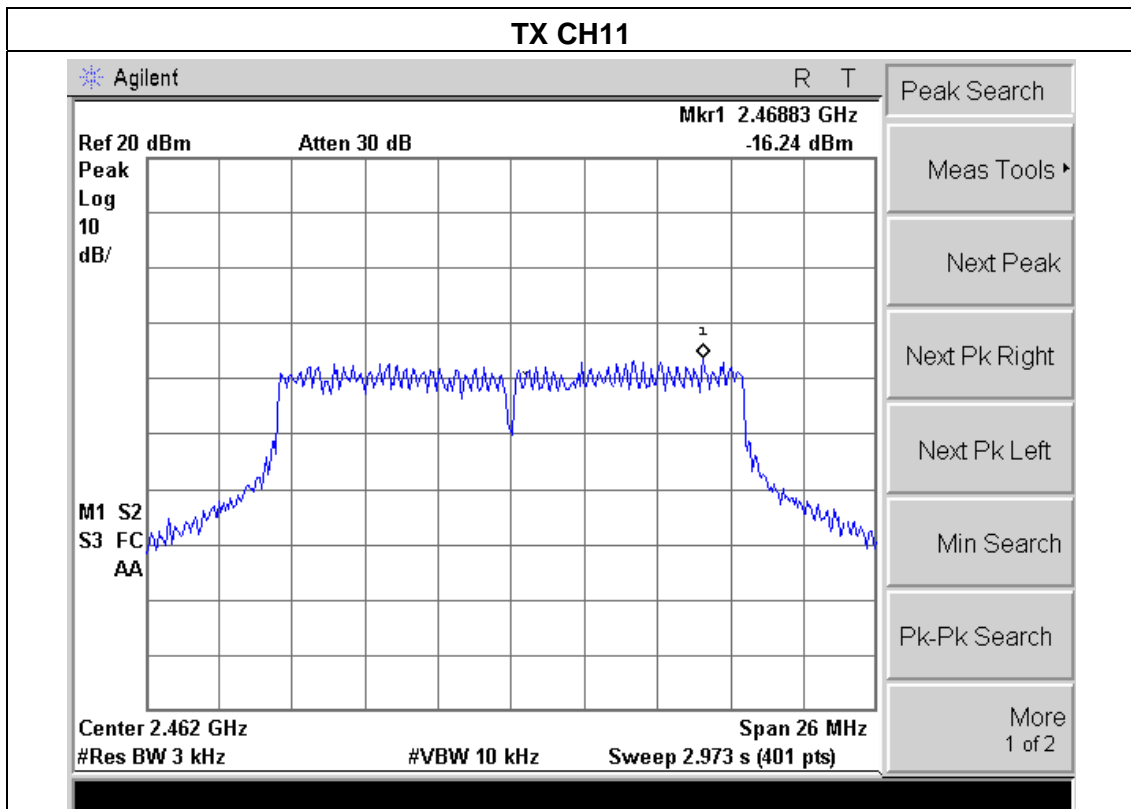
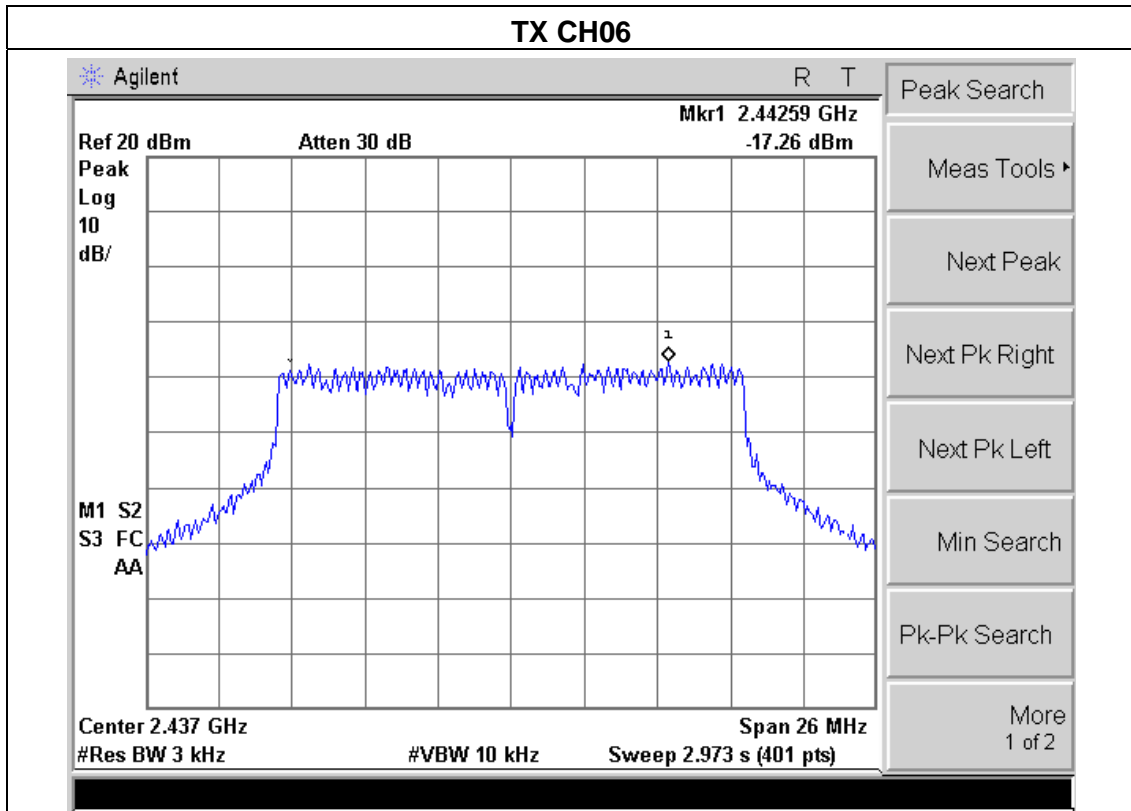

EUT :	Tablet PC	Model Name :	W7421
Temperature :	25 °C	Relative Humidity :	56%
Pressure :	1015 hPa	Test Voltage :	DC 3.7V
Test Mode :	TX n Mode(20M) /CH01, CH06, CH11		

Frequency	Power Density (dBm)	Limit (dBm)	Result
2412 MHz	-18.48	8	PASS
2437 MHz	-18.30	8	PASS
2462 MHz	-16.28	8	PASS

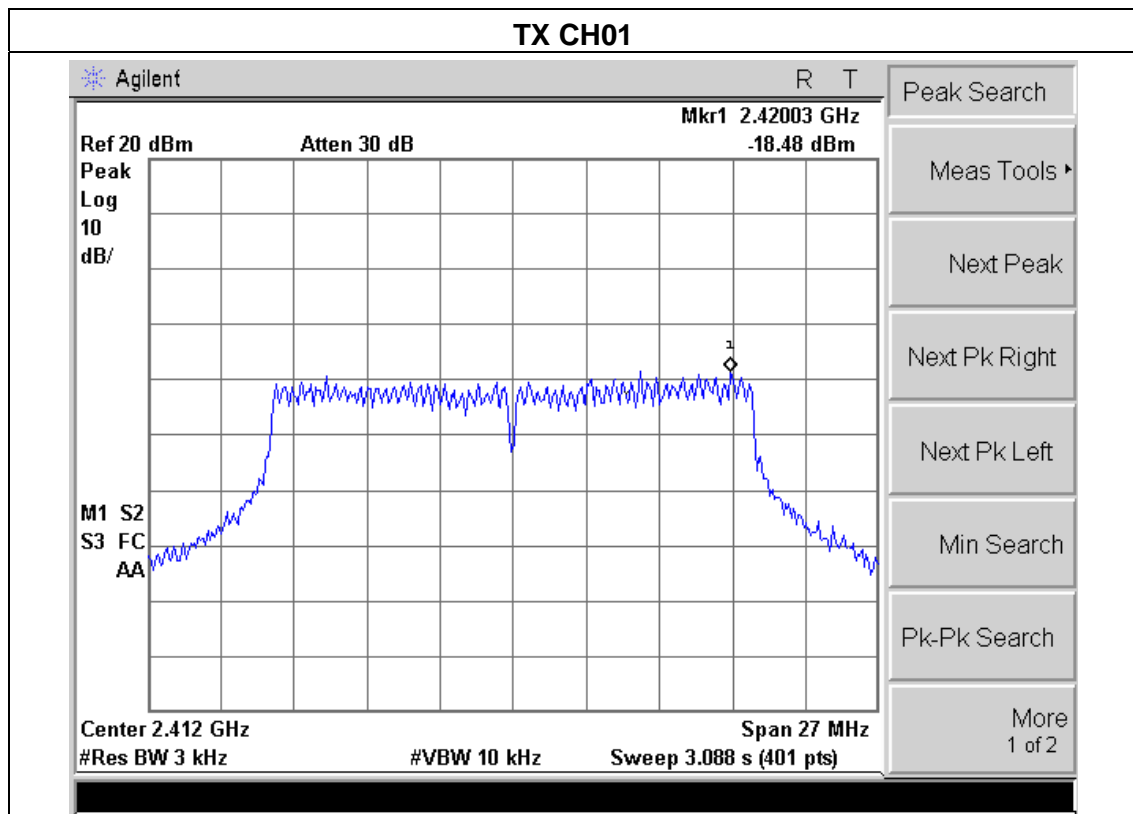

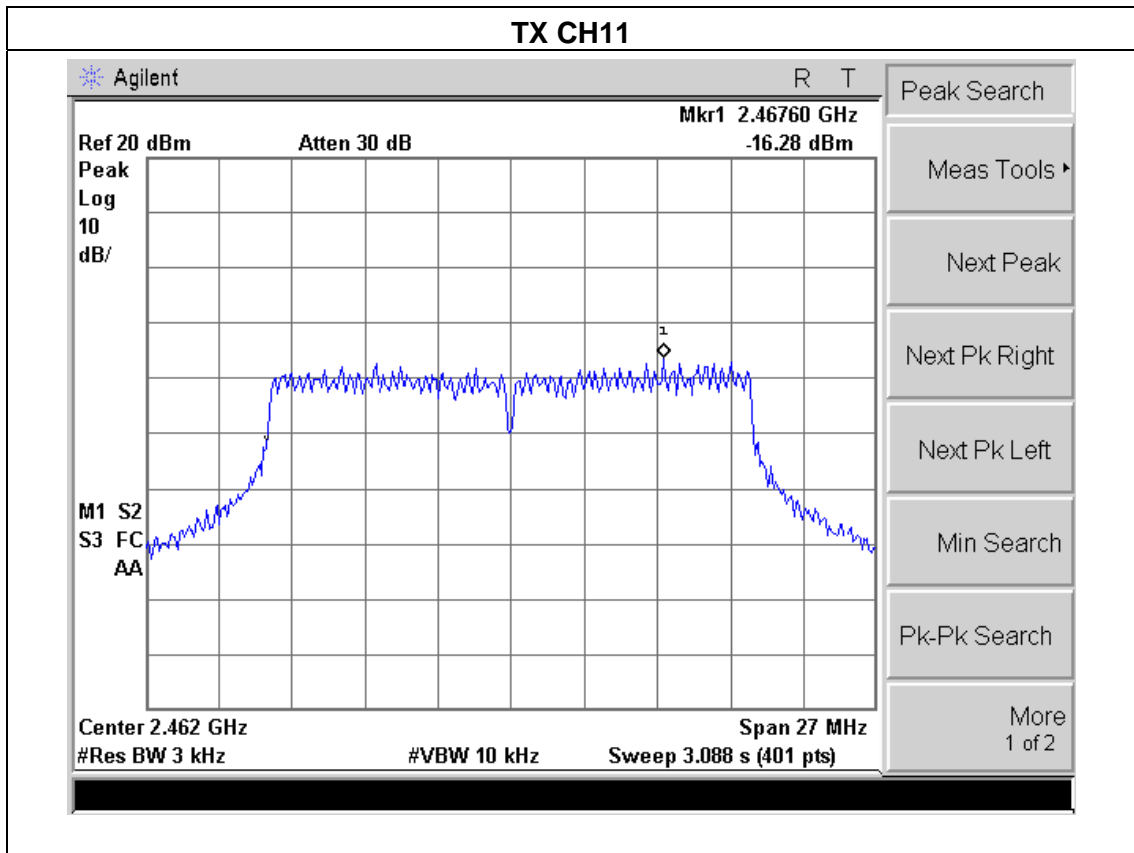
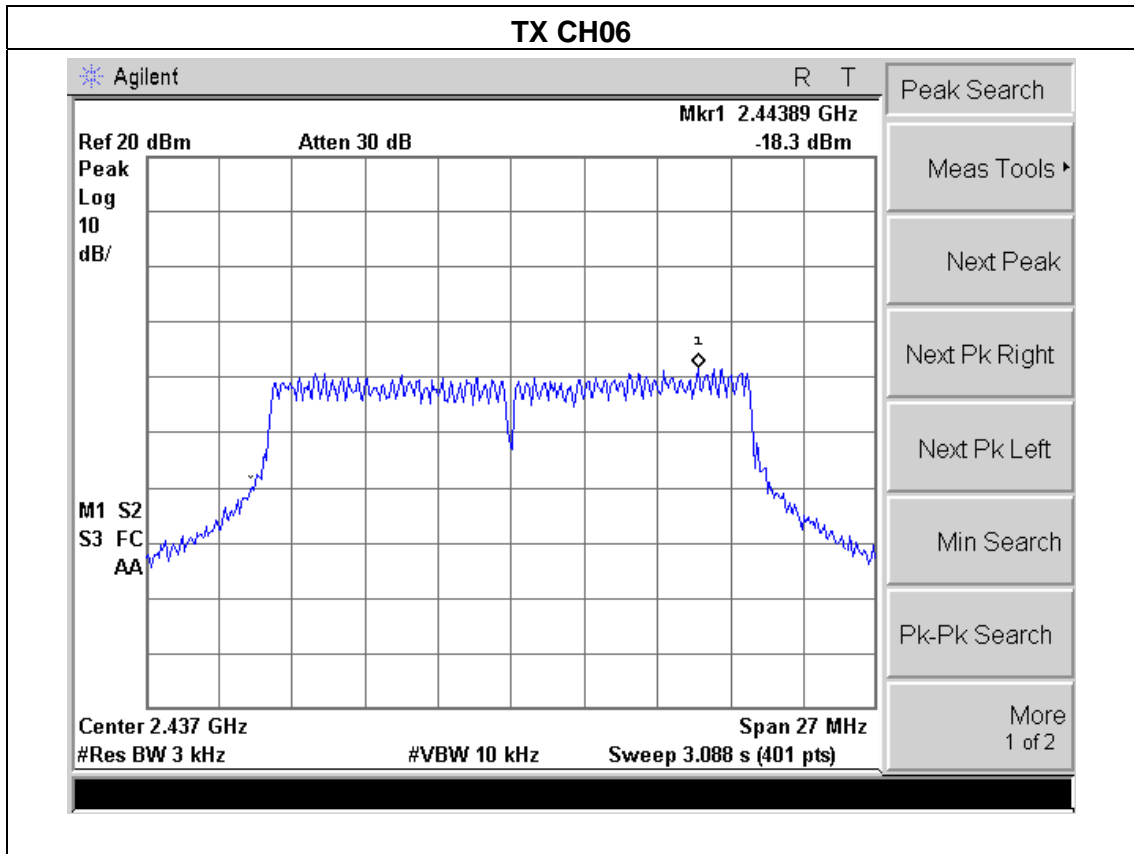

5. BANDWIDTH TEST

5.1 APPLIED PROCEDURES / LIMIT

FCC Part15 (15.247) , Subpart C				
Section	Test Item	Limit	Frequency Range (MHz)	Result
15.247(a)(2)	Bandwidth	$\geq 500\text{KHz}$ (6dB bandwidth)	2400-2483.5	PASS

5.1.1 TEST PROCEDURE

1. Set RBW = 100 kHz.
2. Set the video bandwidth (VBW) $\geq 3 \times$ RBW.
3. Detector = Peak.
4. Trace mode = max hold.
5. Sweep = auto couple.
6. Allow the trace to stabilize.
7. Measure the maximum width of the emission that is constrained by the frequencies associated with the two outermost amplitude points (upper and lower) that are attenuated by 6 dB relative to the maximum level measured in the fundamental emission.

TEST SETUP

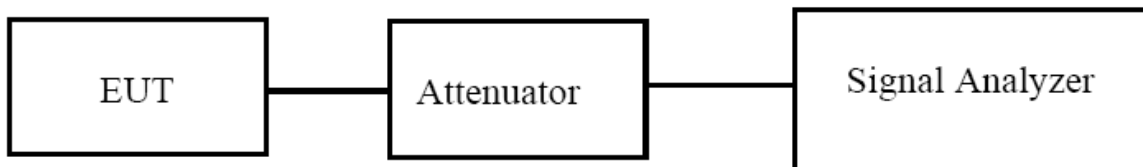

5.1.2 EUT OPERATION CONDITIONS

The EUT tested system was configured as the statements of 2.4 Unless otherwise a special operating condition is specified in the follows during the testing.

5.1.3 TEST RESULTS

EUT :	Tablet PC	Model Name :	W7421
Temperature :	25 °C	Relative Humidity :	56%
Pressure :	1012 hPa	Test Voltage :	DC 3.7V
Test Mode :	TX b Mode /CH01, CH06, CH11		

Channel	Frequency (MHz)	6dB bandwidth (MHz)	Limit (kHz)	Result
Low	2412	9.104	500	Pass
Middle	2437	9.636	500	Pass
High	2462	10.079	500	Pass

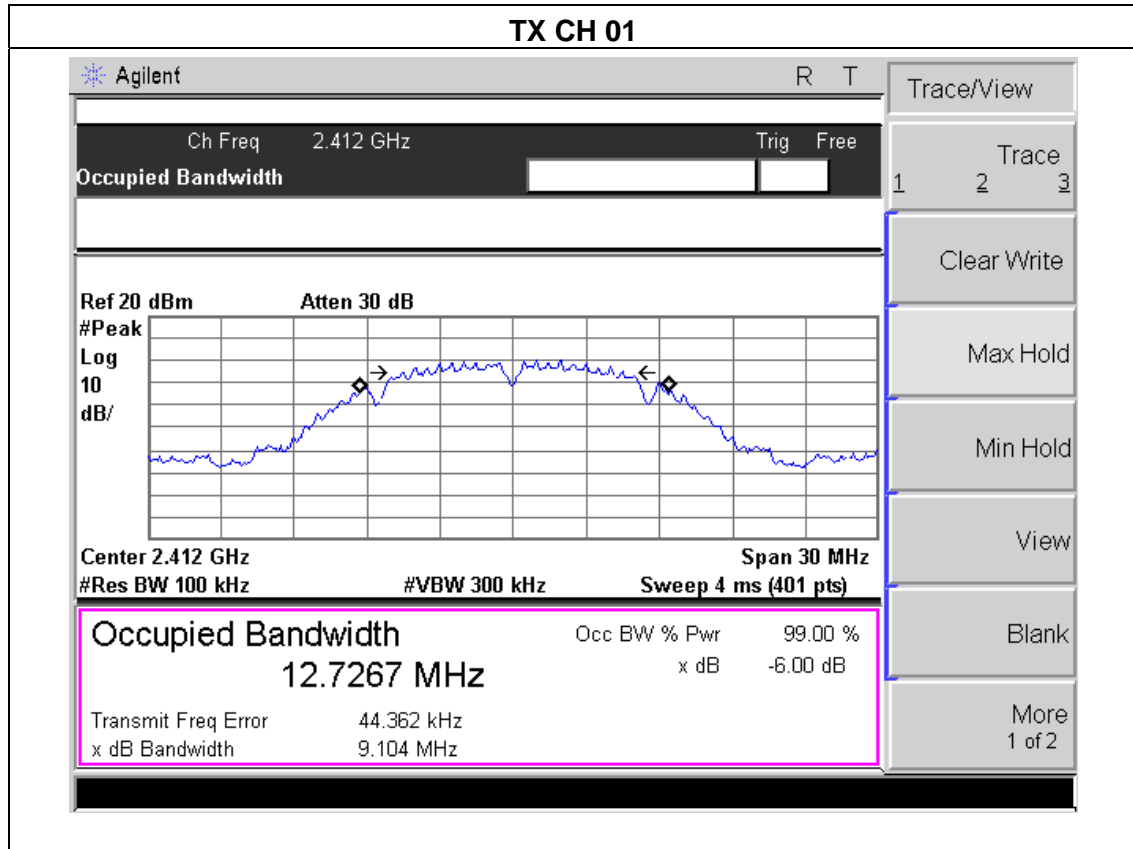

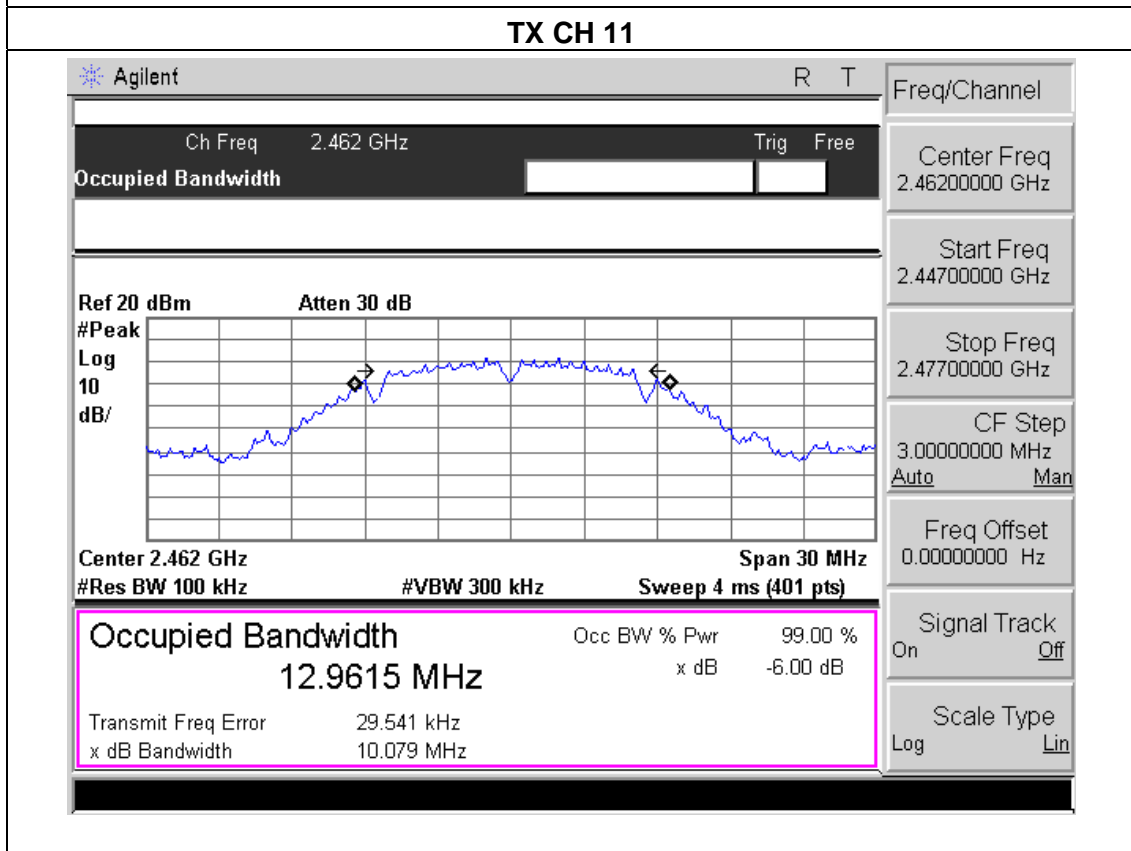
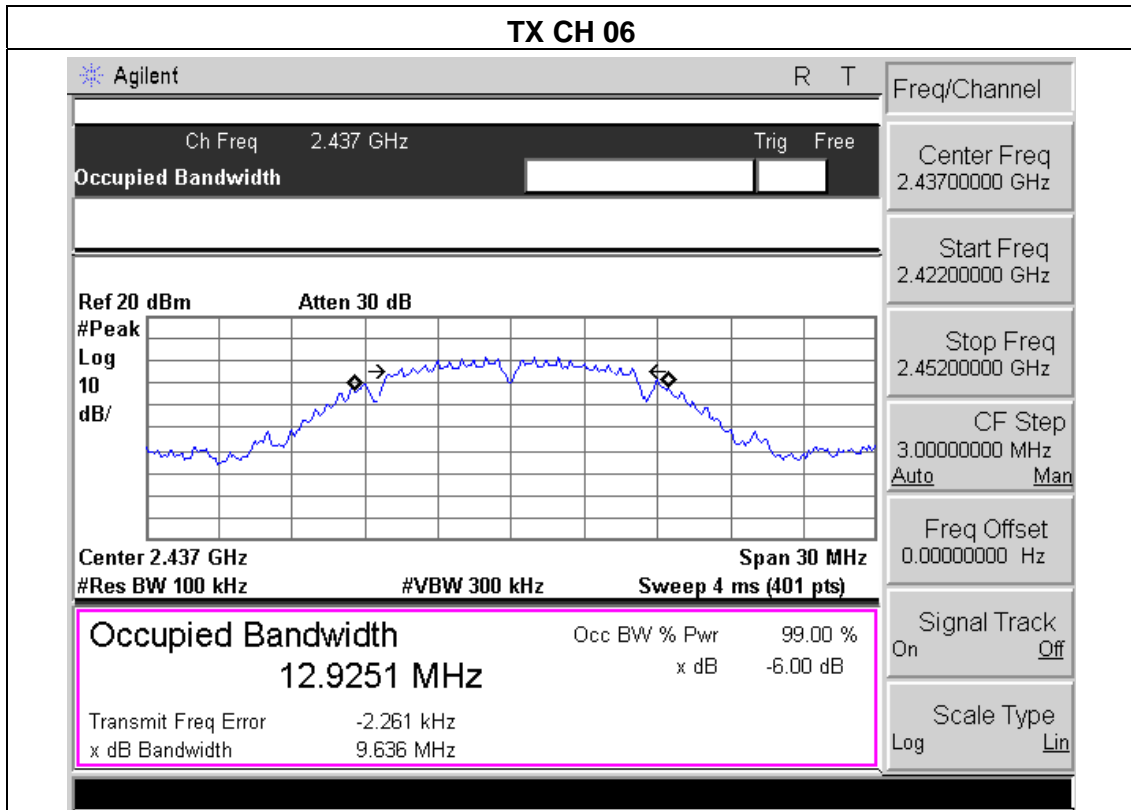

EUT :	Tablet PC	Model Name :	W7421
Temperature :	25 °C	Relative Humidity :	60%
Pressure :	1012 hPa	Test Voltage :	DC 3.7V
Test Mode :	TX g Mode /CH01, CH06, CH11		

Channel	Frequency (MHz)	6dB bandwidth (MHz)	Limit (kHz)	Result
Low	2412	16.372	500	Pass
Middle	2437	16.343	500	Pass
High	2462	16.368	500	Pass

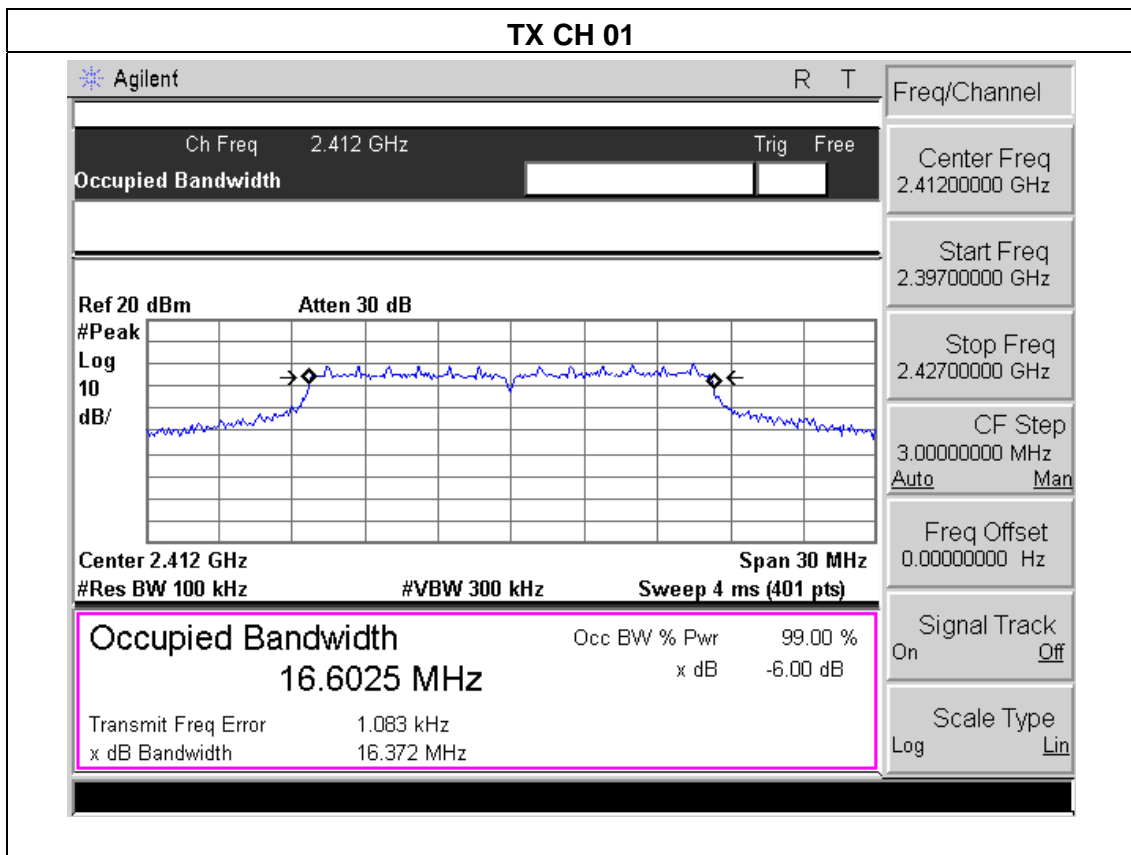

TX CH 06

Agilent
R T

Ch Freq 2.437 GHz
Trig Free

Occupied Bandwidth

Ref 20 dBm
Atten 30 dB

#Peak
Log
10
dB/

Freq/Channel

Center Freq
2.43700000 GHz

Start Freq
2.42200000 GHz

Stop Freq
2.45200000 GHz

CF Step
3.00000000 MHz
Auto Man

Freq Offset
0.00000000 Hz

Signal Track
On Off

Scale Type
Log Lin

Center 2.437 GHz
Span 30 MHz

#Res BW 100 kHz
#VBW 300 kHz
Sweep 4 ms (401 pts)

Occupied Bandwidth	Occ BW % Pwr	99.00 %
16.5460 MHz	x dB	-6.00 dB
Transmit Freq Error	10.097 kHz	
x dB Bandwidth	16.343 MHz	

TX CH 11

Agilent
R T

Ch Freq 2.462 GHz
Trig Free

Occupied Bandwidth

Ref 20 dBm
Atten 30 dB

#Peak
Log
10
dB/

Trace/View

Trace
1 2 3

Clear Write

Max Hold

Min Hold

View

Blank

More
1 of 2

Center 2.462 GHz
Span 30 MHz

#Res BW 100 kHz
#VBW 300 kHz
Sweep 4 ms (401 pts)

Occupied Bandwidth	Occ BW % Pwr	99.00 %
16.6279 MHz	x dB	-6.00 dB
Transmit Freq Error	-2.298 kHz	
x dB Bandwidth	16.368 MHz	

EUT :	Tablet PC	Model Name :	W7421
Temperature :	25 °C	Relative Humidity :	56%
Pressure :	1012 hPa	Test Voltage :	DC 3.7V
Test Mode :	TX n Mode(20M) /CH01, CH06, CH11		

Channel	Frequency (MHz)	6dB bandwidth (MHz)	Limit (kHz)	Result
Low	2412	17.601	500	Pass
Middle	2437	17.575	500	Pass
High	2462	17.610	500	Pass

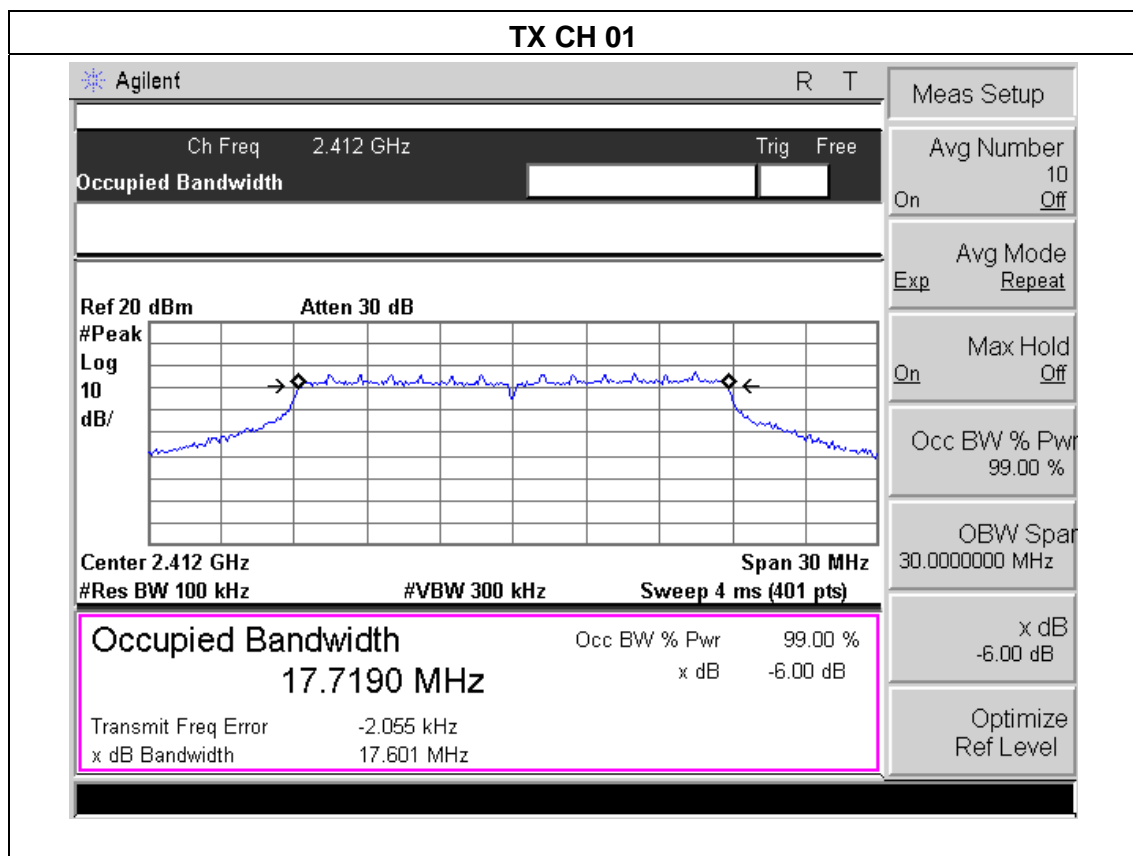

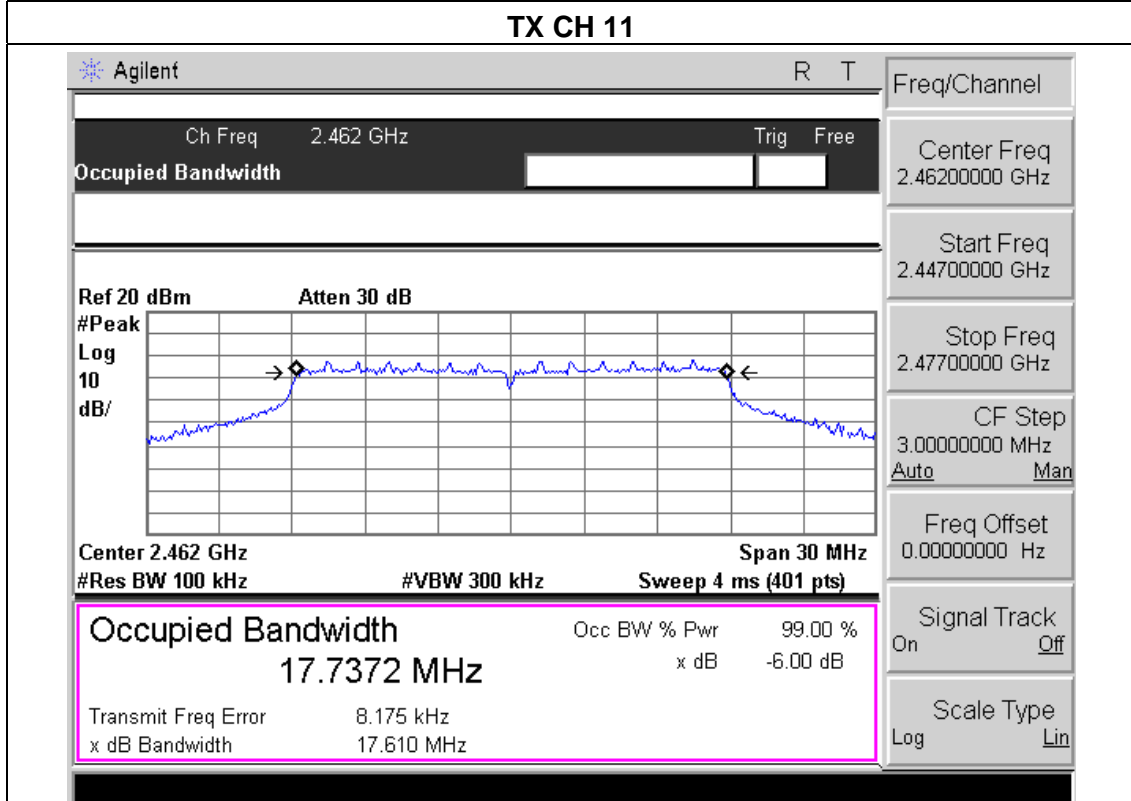
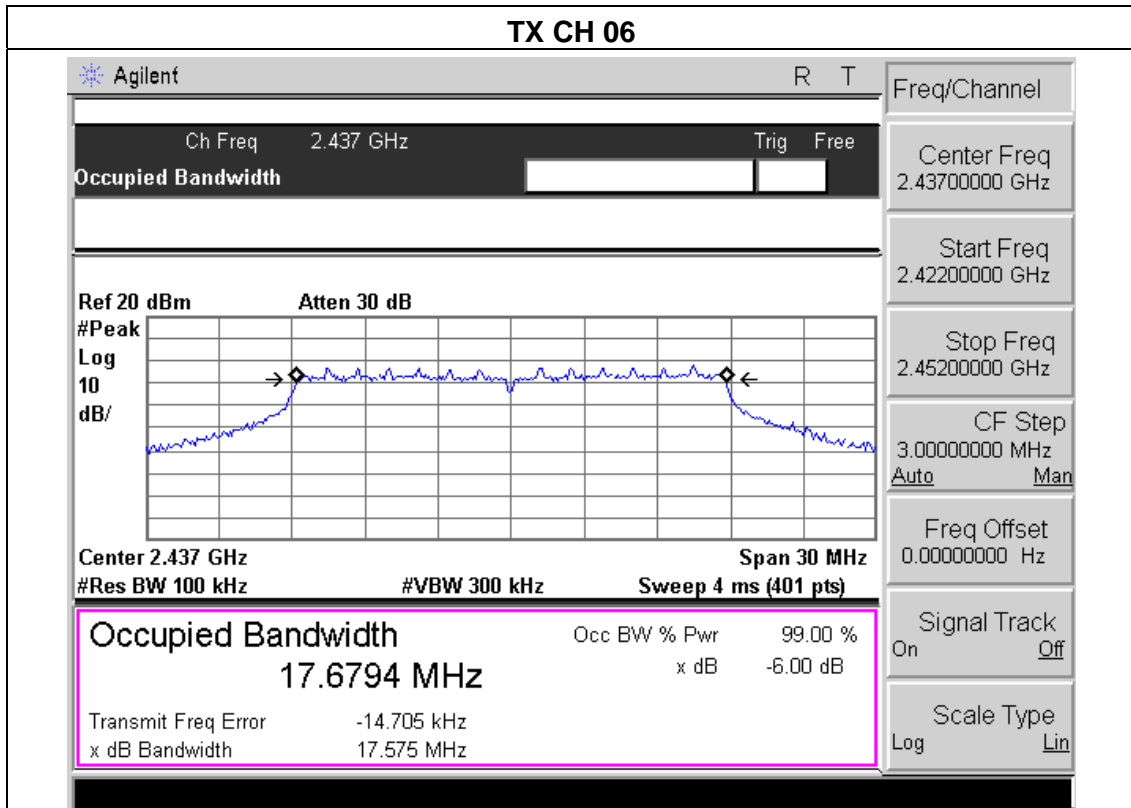

6. PEAK OUTPUT POWER TEST

6.1 APPLIED PROCEDURES / LIMIT

FCC Part15 (15.247) , Subpart C				
Section	Test Item	Limit	Frequency Range (MHz)	Result
15.247(b)(3)	Peak Output Power	1 watt or 30dBm	2400-2483.5	PASS

6.1.1 TEST PROCEDURE

- a. The EUT was directly connected to the Power meter

6.1.2 DEVIATION FROM STANDARD

No deviation.

6.1.3 TEST SETUP

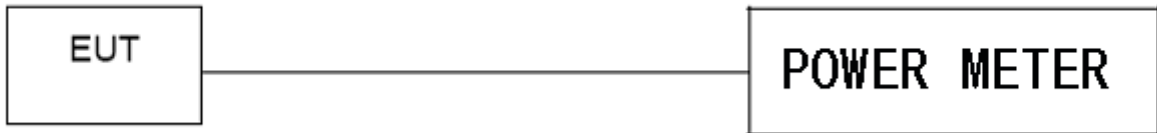

6.1.4 EUT OPERATION CONDITIONS

The EUT tested system was configured as the statements of 2.4 Unless otherwise a special operating condition is specified in the follows during the testing.

6.1.5 TEST RESULTS

EUT :	Tablet PC	Model Name :	W7421
Temperature :	25 °C	Relative Humidity :	60%
Pressure :	1012 hPa	Test Voltage :	DC 3.7V
Test Mode :	TX b/g/n20/n40 Mode		

TX 802.11b Mode				
Test Channel	Frequency	Maximum Conducted Output Power(PK)	Maximum Conducted Output Power(AV)	LIMIT
	(MHz)	(dBm)	(dBm)	(dBm)
CH01	2412	15.67	12.71	30
CH06	2437	15.69	12.03	30
CH11	2462	15.41	12.45	30
TX 802.11g Mode				
CH01	2412	11.82	9.86	30
CH06	2437	11.85	9.89	30
CH11	2462	11.94	9.98	30
TX 802.11n-HT20 Mode				
CH01	2412	9.69	7.73	30
CH06	2437	9.52	7.56	30
CH11	2462	9.62	7.64	30

7. 100 KHZ BANDWIDTH OF FREQUENCY BAND EDGE

APPLICABLE STANDARD

In any 100 kHz bandwidth outside the frequency band in which the spread spectrum or digitally modulated intentional radiator is operating, the radio frequency power that is produced by the intentional radiator shall be at least 20 dB below that in the 100 kHz bandwidth within the band that contains the highest level of the desired power, based on either an RF conducted or a radiated measurement, provided the transmitter demonstrates compliance with the peak conducted power limits. If the transmitter complies with the conducted power limits based on the use of RMS averaging over a time interval, as permitted under paragraph (b)(3) of this section, the attenuation required under this paragraph shall be 30 dB instead of 20 dB. Attenuation below the general limits specified in §15.209(a) is not required. In addition, radiated emissions which fall in the restricted bands, as defined in §15.205(a), must also comply with the radiated emission limits specified in §15.209(a) (see §15.205(c)).

TEST PROCEDURE

- a) Check the calibration of the measuring instrument using either an internal calibrator or a known signal from an external generator.
- b) Position the EUT without connection to measurement instrument. Turn on the EUT and connect its antenna terminal to measurement instrument via a low loss cable. Then set it to any one measured frequency within its operating range, and make sure the instrument is operated in its linear range.
- c) Set RBW to 100 kHz and VBW of spectrum analyzer to 300 kHz with a convenient frequency span including 100 kHz bandwidth from band edge.
- d) Measure the highest amplitude appearing on spectral display and set it as a reference level. Plot the graph with marking the highest point and edge frequency.
- e) Repeat above procedures until all measured frequencies were complete.

7.1 DEVIATION FROM STANDARD

No deviation.

7.2 TEST SETUP

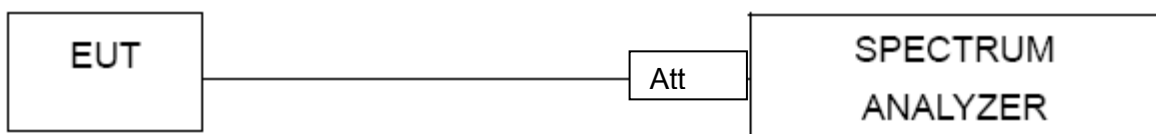

7.3 EUT OPERATION CONDITIONS

The EUT tested system was configured as the statements of 2.4 Unless otherwise a special operating condition is specified in the follows during the testing.

7.4 TEST RESULTS

EUT :	Tablet PC	Model Name :	W7421
Temperature :	25 °C	Relative Humidity :	56%
Pressure :	1012 hPa	Test Voltage :	DC 3.7V

Frequency Band	Delta Peak to band emission (dBc)	> Limit (dBc)	Result
802.11b			
2400	44.57	20	Pass
2483.5	49.17	20	Pass
802.11g			
2400	28.08	20	Pass
2483.5	40.60	20	Pass
802.11n20			
2400	27.59	20	Pass
2483.5	41.76	20	Pass

Radiated band edge:

Frequency (MHz)	Meter Reading (dBμV)	Factor (dB)	Emission Level (dBμV/m)	Limits (dBμV/m)	Margin (dB)	Detector Type	Comment
802.11b							
2390	60.23	-13.06	47.17	74	-26.83	peak	Vertical
2390	59.88	-13.06	46.82	74	-27.18	peak	Horizontal
2483.5	61.41	-12.78	48.63	74	-25.37	peak	Vertical
2483.5	60.62	-12.78	47.84	74	-26.16	peak	Horizontal
802.11g							
2390	60.59	-13.06	47.53	74	-26.47	peak	Vertical
2390	60.23	-13.06	47.17	74	-26.83	peak	Horizontal
2483.5	58.97	-12.78	46.19	74	-27.81	peak	Vertical
2483.5	59.37	-12.78	46.59	74	-27.41	peak	Horizontal
802.11n20							
2390	61.52	-13.06	48.46	74	-25.54	peak	Vertical
2390	60.34	-13.06	47.28	74	-26.72	peak	Horizontal
2483.5	61.47	-12.78	48.69	74	-25.31	peak	Vertical
2483.5	60.93	-12.78	48.15	74	-25.85	peak	Horizontal

Note: Test method to see chapter 3.2 . When PK value is lower than the Average value limit, average not record.

802.11b: Band Edge, Left Side

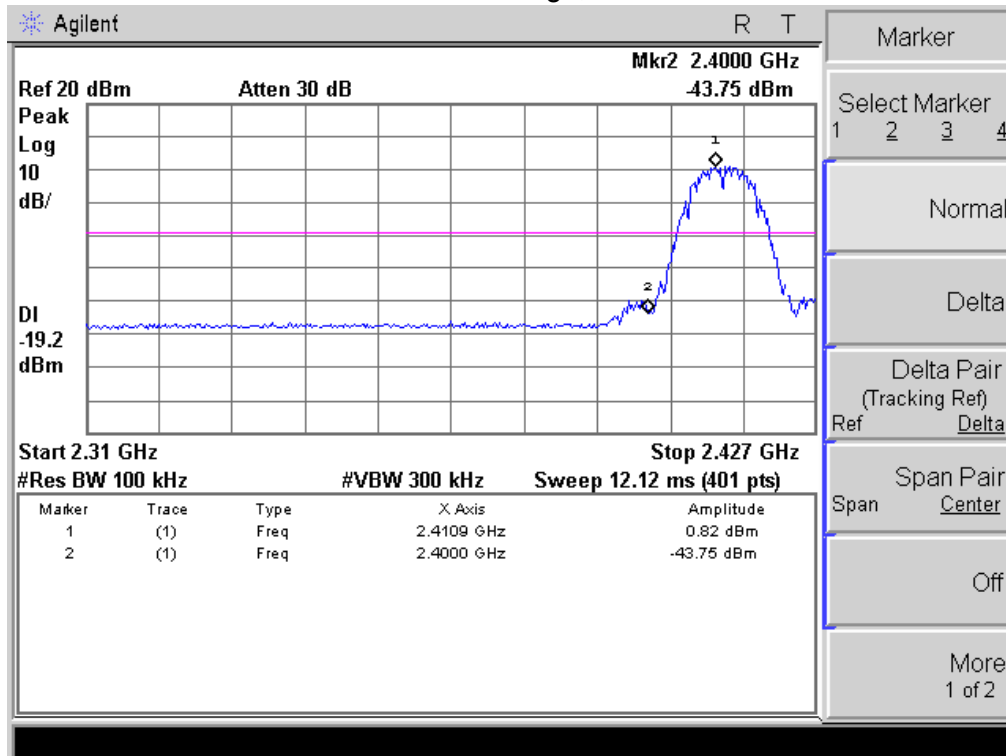

802.11b: Band Edge, Right Side

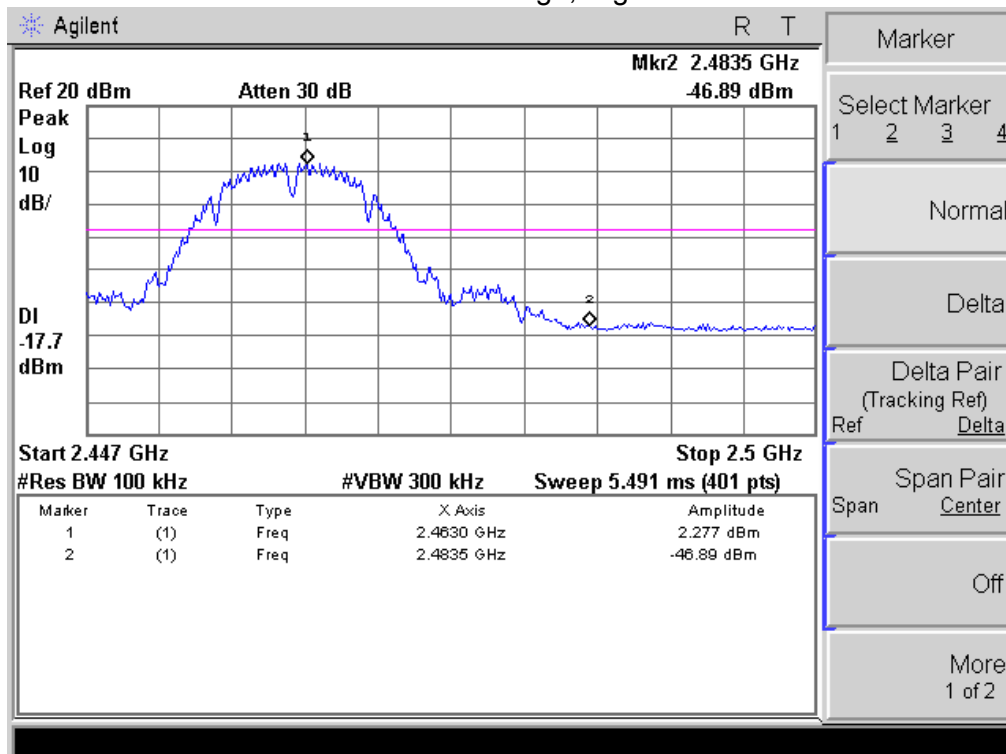

802.11g: Band Edge, Left Side

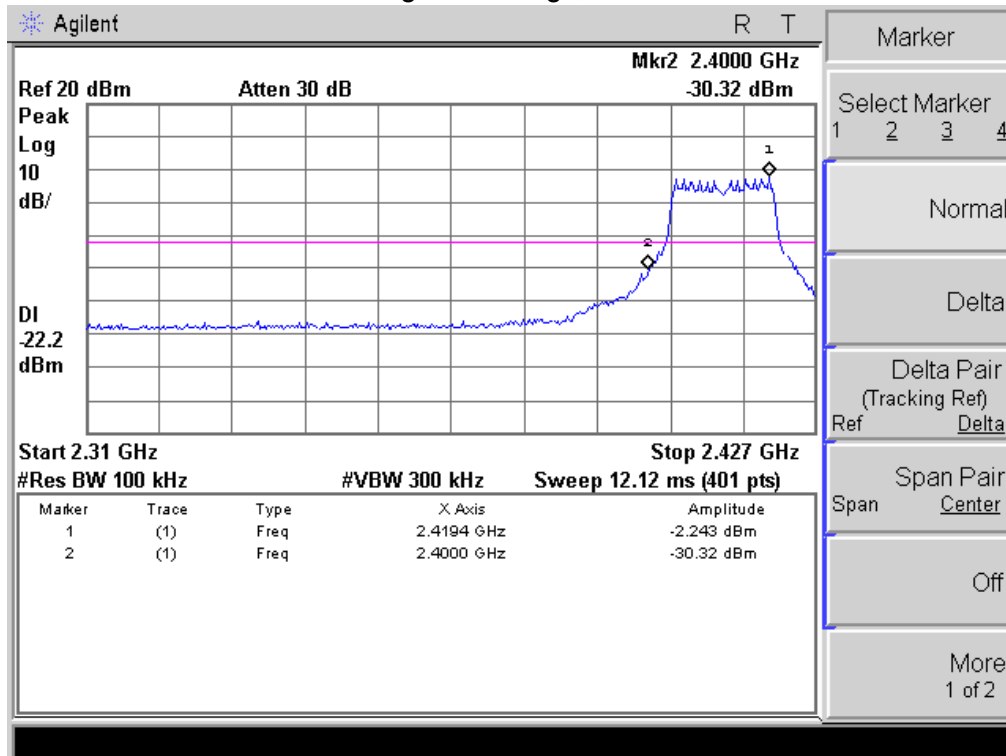

802.11g: Band Edge, Right Side

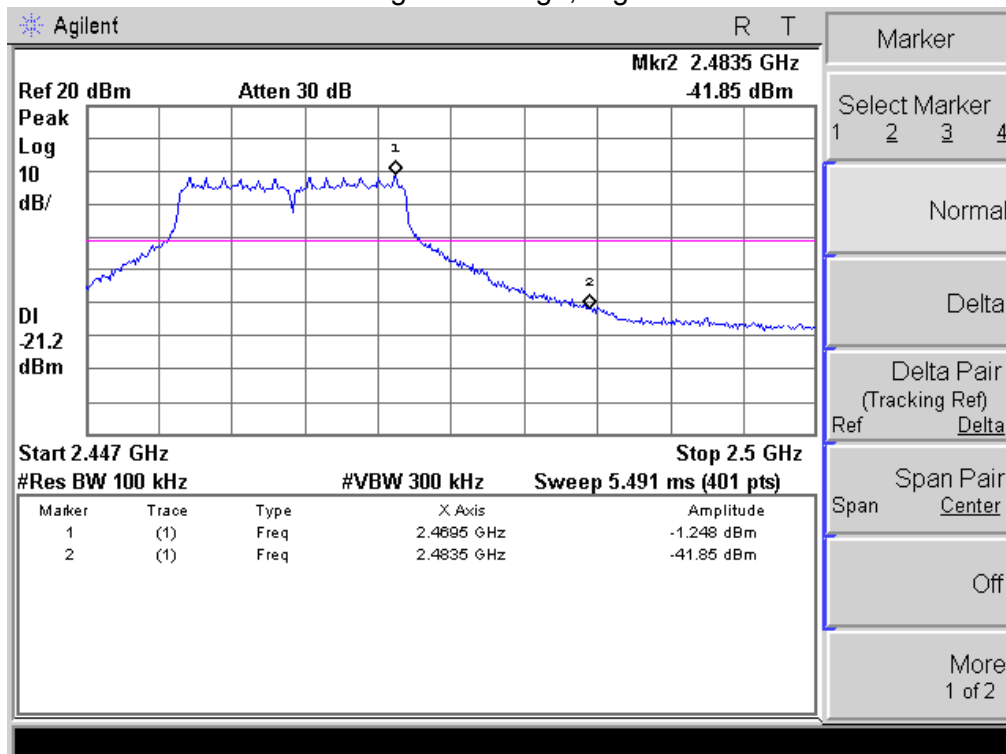

802.11n-HT20: Band Edge, Left Side

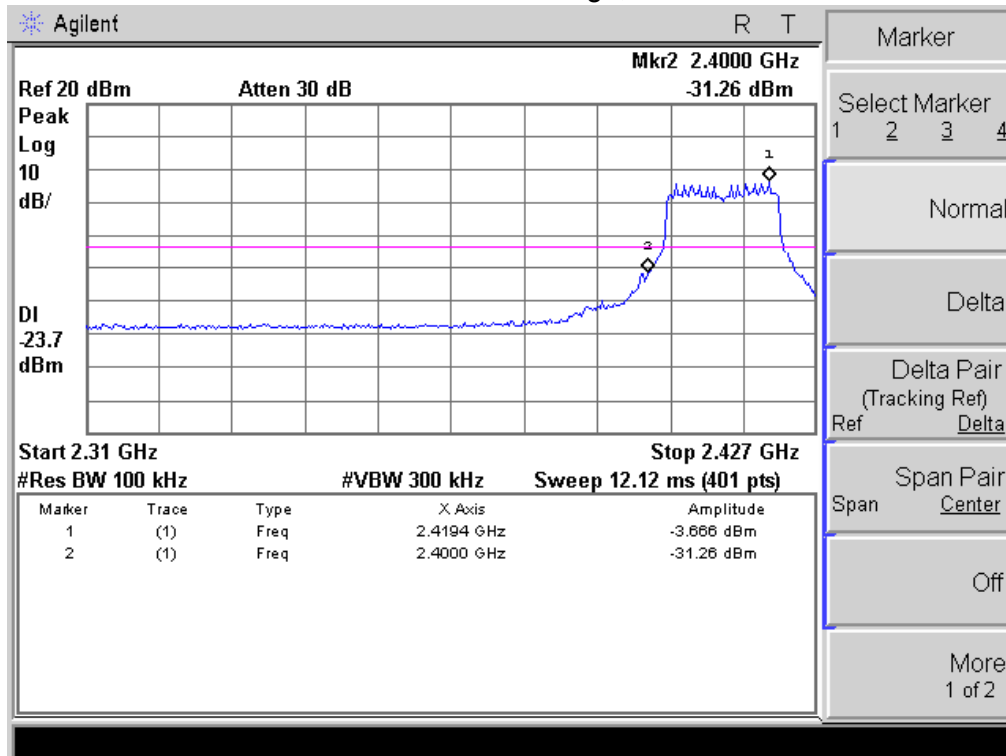

802.11n-HT20: Band Edge, Right Side

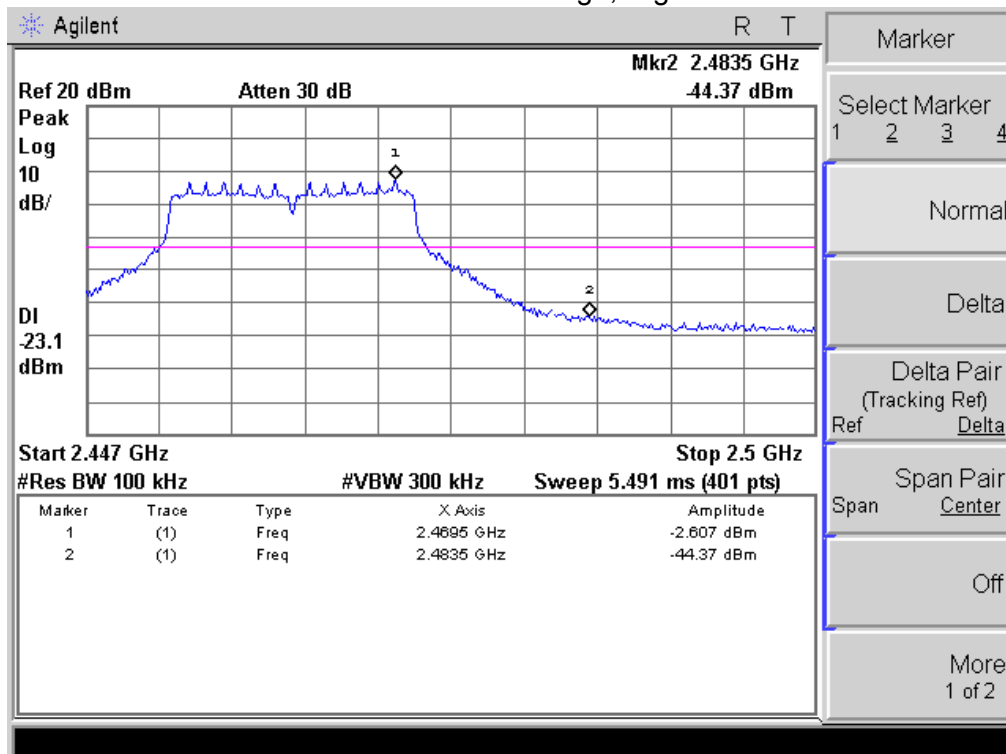

8. ANTENNA REQUIREMENT

8.1 STANDARD REQUIREMENT

15.203 requirement: For intentional device, according to 15.203: an intentional radiator shall be designed to ensure that no antenna other than that furnished by the responsible party shall be used with the device.

8.2 EUT ANTENNA

The EUT antenna is permanent attached antenna. It comply with the standard requirement.

9. EUT TEST PHOTO

Radiated Measurement Photos

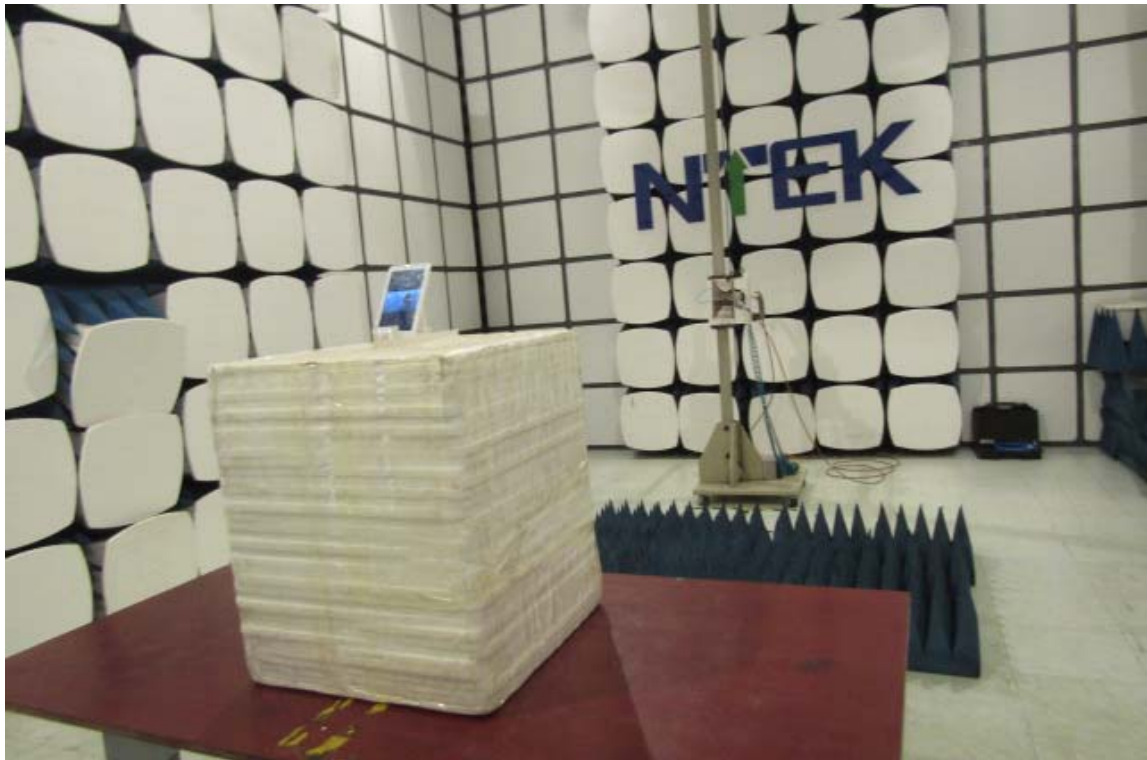
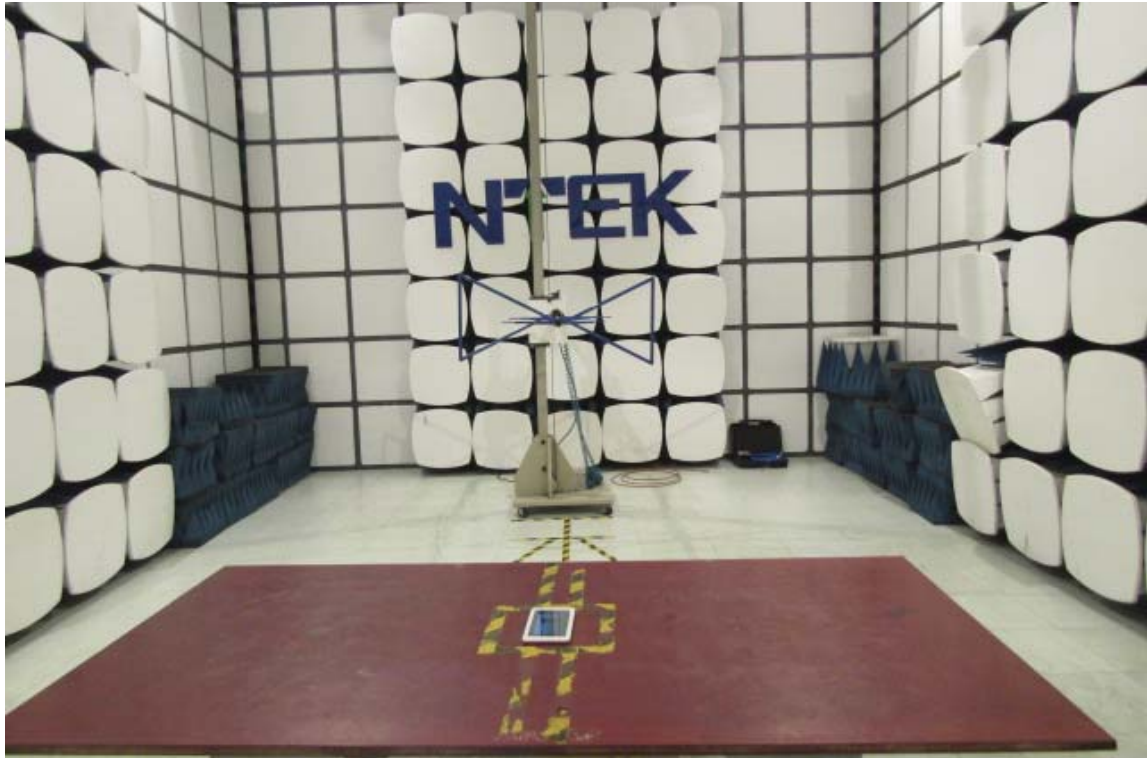

Conducted Measurement Photos

