

FCC 47 CFR PART 15 SUBPART C

CERTIFICATION TEST REPORT

For

Tablet PC

Model No.: W740,W741, W7402, W7405, W7409, W7416, W7415, W7417,
W7418, W7420,W7424,W7419,W1416,W1415,W7414,W7431,
W7432,W7433,W7434,W7435,W8420

FCC ID: 2ACPR-W740

Trademark: BMORN

REPORT NO.: ES150907026E

ISSUE DATE: September 20, 2015

Prepared for

Shenzhen Bmorn Technology Co.,Ltd.

5/F, Hengfang Verteran Industrial Park,Xingye Road, Xixiang,
Bao'an,Shenzhen, Guangdong,China

Prepared by

SHENZHEN EMTEK CO., LTD.

Bldg 69, Majialong Industry Zone, Nanshan District, Shenzhen,
Guangdong, China
TEL: 86-755-26954280
FAX: 86-755-26954282

TABLE OF CONTENTS

1	TEST RESULT CERTIFICATION	3
2	EUT TECHNICAL DESCRIPTION	4
3	SUMMARY OF TEST RESULT	6
4	TEST METHODOLOGY	7
4.1	GENERAL DESCRIPTION OF APPLIED STANDARDS	7
4.2	MEASUREMENT EQUIPMENT USED	7
4.3	DESCRIPTION OF TEST MODES	8
5	FACILITIES AND ACCREDITATIONS	9
5.1	FACILITIES	9
5.2	LABORATORY ACCREDITATIONS AND LISTINGS	9
6	TEST SYSTEM UNCERTAINTY	10
7	SETUP OF EQUIPMENT UNDER TEST	11
7.1	RADIO FREQUENCY TEST SETUP 1	11
7.2	RADIO FREQUENCY TEST SETUP 2	11
7.3	CONDUCTED EMISSION TEST SETUP	12
8	TEST REQUIREMENTS	13
8.1	DTS (6DB) BANDWIDTH	13
8.2	MAXIMUM PEAK CONDUCTED OUTPUT POWER	19
8.3	MAXIMUM POWER SPECTRAL DENSITY	20
8.4	UNWANTED EMISSIONS INTO NON-RESTRICTED FREQUENCY BANDS	26
8.5	RADIATED SPURIOUS EMISSION	31
8.6	CONDUCTED EMISSION TEST	44
8.7	ANTENNA APPLICATION	49

1 TEST RESULT CERTIFICATION

Applicant: Shenzhen Bmorn Technology Co.,Ltd.
5/F, Hengfang Verteran Industrial Park,Xingye Road, Xixiang, Bao'an,Shenzhen, Guangdong,China

Manufacturer: Shenzhen Bmorn Technology Co.,Ltd.
5/F, Hengfang Verteran Industrial Park,Xingye Road, Xixiang, Bao'an,Shenzhen, Guangdong,China

Product Description: Table PC

Model Number: W740,W741, W7402, W7405, W7409, W7416, W7415, W7417, W7418, W7420, W7424, W7419,W1416,W1415,W7414,W7431, W7432,W7433,W7434,W7435, W8420
(Note: all the model numbers are identical in circuitry and electrical, mechanical and physical construction, PCB layout, External dimension; the only differences are the model no., appearance and colour. for trading purpose. We take W740 to test.)

File Number: ES150907026E

Date of Test: September 7, 2015 to September 20, 2015

Measurement Procedure Used:

APPLICABLE STANDARDS	
STANDARD	TEST RESULT
FCC 47 CFR Part 2, Subpart J, June 11, 2014 FCC 47 CFR Part 15, Subpart C ,May 9, 2014	PASS

The above equipment was tested by SHENZHEN EMTEK CO., LTD. The test data, data evaluation, test procedures, and equipment configurations shown in this report were made in accordance with the procedures given in ANSI C63.10 (2013) and the energy emitted by the sample EUT tested as described in this report is in compliance with the requirements of FCC Rules Part 2 and Part 15.247

The test results of this report relate only to the tested sample identified in this report.

Date of Test : September 7, 2015 to September 20, 2015

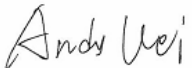
Prepared by : 
Andy Wei/Editor

Reviewer : 
Joe Xia/Supervisor

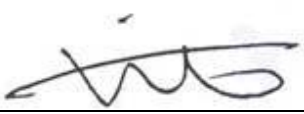
Approve & Authorized Signer : 
Lisa Wang/Manager

2 EUT TECHNICAL DESCRIPTION

Characteristics	Description
IEEE 802.11 WLAN Mode Supported:	<input checked="" type="checkbox"/> 802.11b(20MHz channel bandwidth) <input checked="" type="checkbox"/> 802.11g(20MHz channel bandwidth) <input checked="" type="checkbox"/> 802.11n(20MHz channel bandwidth)
Data Rate:	802.11 b:1,2,5.5,11Mbps; 802.11 g:6,9,12,18,24,36,48,54Mbps; 802.11n(HT20):MCS0-MCS7;
Modulation:	DSSS with DBPSK/DQPSK/CCK for 802.11b; OFDM with BPSK/QPSK/16QAM/64QAM for 802.11g/n;
Operating Frequency Range:	2412-2462MHz for 802.11b/g; 2412-2462MHz for 802.11n(HT20);
Number of Channels:	11 channels for 802.11b/g; 11 channels for 802.11n(HT20);
Transmit Power Max:	7.91dBm for 802.11b; 7.82dBm for 802.11g; 8.05dBm for 802.11n(HT20);
Antenna Type:	Fixed External
Antenna Port:	<input checked="" type="checkbox"/> Ant1 ; <input type="checkbox"/> Ant2 ;
Smart system:	<input checked="" type="checkbox"/> SISO for 802.11b/g/n <input type="checkbox"/> MIMO for 802.11n
Antenna Gain:	1dBi
Power supply:	<input checked="" type="checkbox"/> DC supply: DC 3.7V internal rechargeable lithium battery or DC 5V from AC Adapter
	<input checked="" type="checkbox"/> Adapter supply: Model: PS10C050K2000UU Input: 100-240~50/60Hz 0.35A Output: DC 5V 2000mA
Temperature Range:	0°C ~ +40°C

Note: for more details, please refer to the User's manual of the EUT.

3 SUMMARY OF TEST RESULT

FCC Part Clause	Test Parameter	Verdict	Remark
15.247(a)(2)	DTS (6dB) Bandwidth	PASS	
15.247(b)(3)	Maximum Peak Conducted Output Power	PASS	
15.247(e)	Maximum Power Spectral Density Level	PASS	
15.247(d)	Unwanted Emission Into Non-Restricted Frequency Bands	PASS	
15.247(d) 15.209	Unwanted Emission Into Restricted Frequency Bands	PASS	
15.247(d) 15.209	Radiated Spurious Emission	PASS	
15.207	Conducted Emission Test	PASS	
15.247(b)	Antenna Application	PASS	
NOTE1: N/A (Not Applicable)			
NOTE2: According to FCC OET KDB 558074, the report use radiated measurements in the restricted frequency bands. In addition, the radiated test is also performed to ensure the emissions emanating from the device cabinet also comply with the applicable limits.			

4 TEST METHODOLOGY

4.1 GENERAL DESCRIPTION OF APPLIED STANDARDS

According to its specifications, the EUT must comply with the requirements of the following standards:

FCC 47 CFR Part 2, Subpart J

FCC 47 CFR Part 15, Subpart C

FCC KDB 558074 D01 DTS Meas Guidance v03r03

FCC KDB 662911 D01 Multiple Transmitter Output v01

FCC KDB 662911 D02 MIMO With Cross Polarized Antenna V01

4.2 MEASUREMENT EQUIPMENT USED

4.2.1 Conducted Emission Test Equipment

EQUIPMENT TYPE	MFR	MODEL NUMBER	SERIAL NUMBER	Period of validity
Test Receiver	Rohde & Schwarz	ESCS30	828985/018	05/17/2016
L.I.S.N.	Schwarzbeck	NNLK8129	8129203	05/17/2016
50Ω Coaxial Switch	Anritsu	MP59B	M20531	N/A
Pulse Limiter	Rohde & Schwarz	ESH3-Z2	100006	05/17/2016
Voltage Probe	Rohde & Schwarz	TK9416	N/A	05/17/2016
I.S.N	Rohde & Schwarz	ENY22	1109.9508.02	05/17/2016

4.2.2 Radiated Emission Test Equipment

EQUIPMENT TYPE	MFR	MODEL NUMBER	SERIAL NUMBER	Period of validity
EMI Test Receiver	Rohde & Schwarz	ESU	1302.6005.26	05/17/2016
Pre-Amplifier	HP	8447D	2944A07999	05/17/2016
Bilog Antenna	Schwarzbeck	VULB9163	142	05/17/2016
Loop Antenna	ARA	PLA-1030/B	1029	05/17/2016
Horn Antenna	Schwarzbeck	BBHA 9170	BBHA9170399	05/17/2016
Horn Antenna	Schwarzbeck	BBHA 9120	D143	05/17/2016
Cable	Schwarzbeck	AK9513	ACRX1	05/17/2016
Cable	Rosenberger	N/A	FP2RX2	05/17/2016
Cable	Schwarzbeck	AK9513	CRPX1	05/17/2016
Cable	Schwarzbeck	AK9513	CRRX2	05/17/2016

4.2.3 Radio Frequency Test Equipment

EQUIPMENT TYPE	MFR	MODEL NUMBER	SERIAL NUMBER	Period of validity
Spectrum Analyzer	Agilent	E4407B	88156318	05/17/2016
Power meter	Anritsu	ML2495A	0824006	05/17/2016
Power sensor	Anritsu	MA2411B	0738172	05/17/2016

Remark: Each piece of equipment is scheduled for calibration once a year.

4.3 DESCRIPTION OF TEST MODES

The EUT has been tested under its typical operating condition.

The EUT configuration for testing is installed on RF field strength measurement to meet the Commissions requirement and operating in a manner which intends to maximize its emission characteristics in a continuous normal application.

The Transmitter was operated in the normal operating mode. The TX frequency was fixed which was for the purpose of the measurements.

Test of channel included the lowest and middle and highest frequency to perform the test, then record on this report.

Those data rates (802.11b: 1 Mbps; 802.11g: 6 Mbps; 802.11n (HT20): MCS0;) were used for all test.

Pre-defined engineering program for regulatory testing used to control the EUT for staying in continuous transmitting and receiving mode is programmed.

Frequency and Channel list for 802.11b/g/n (HT20):

Channel	Frequency (MHz)	Channel	Frequency (MHz)	Channel	Frequency (MHz)
1	2412	5	2432	9	2452
2	2417	6	2437	10	2457
3	2422	7	2442	11	2462
4	2427	8	2447		

Test Frequency and Channel for 802.11b/g/n (HT20):

Lowest Frequency		Middle Frequency		Highest Frequency	
Channel	Frequency (MHz)	Channel	Frequency (MHz)	Channel	Frequency (MHz)
1	2412	6	2437	11	2462

5 FACILITIES AND ACCREDITATIONS

5.1 FACILITIES

All measurement facilities used to collect the measurement data are located at

Bldg 69, Majialong Industry Zone District, Nanshan District, Shenzhen, China

The sites are constructed in conformance with the requirements of ANSI C63.7, ANSI C63.10 and CISPR Publication 22.

5.2 LABORATORY ACCREDITATIONS AND LISTINGS

Site Description

EMC Lab.

- : Accredited by CNAS, 2013.10.29
The certificate is valid until 2016.10.28
The Laboratory has been assessed and proved to be in compliance with CNAS-CL01: 2006(identical to ISO/IEC17025: 2005)
The Certificate Registration Number is L2291
- : Accredited by TUV Rheinland Shenzhen, 2010.5.25
The Laboratory has been assessed according to the requirements ISO/IEC 17025.
- : Accredited by FCC, October 28, 2010
The Certificate Registration Number is 406365.
- : Accredited by FCC, February 28, 2013
The Certificate Registration Number is 709623.
- : Accredited by Industry Canada, May 24, 2008
The Certificate Registration Number is 4480A-2

6 TEST SYSTEM UNCERTAINTY

The following measurement uncertainty levels have been estimated for tests performed on the apparatus:

Parameter	Uncertainty
Radio Frequency	$\pm 1 \times 10^{-5}$
Maximum Peak Output Power Test	$\pm 1.0\text{dB}$
Conducted Emissions Test	$\pm 2.0\text{dB}$
Radiated Emission Test	$\pm 2.0\text{dB}$
Power Density	$\pm 2.0\text{dB}$
Occupied Bandwidth Test	$\pm 1.0\text{dB}$
Band Edge Test	$\pm 3\text{dB}$
All emission, radiated	$\pm 3\text{dB}$
Antenna Port Emission	$\pm 3\text{dB}$
Temperature	$\pm 0.5^\circ\text{C}$
Humidity	$\pm 3\%$

Measurement Uncertainty for a level of Confidence of 95%

7 SETUP OF EQUIPMENT UNDER TEST

7.1 RADIO FREQUENCY TEST SETUP 1

The WLAN component's antenna ports(s) of the EUT are connected to the measurement instrument per an appropriate attenuator. The EUT is controlled by PC/software to emit the specified signals for the purpose of measurements.

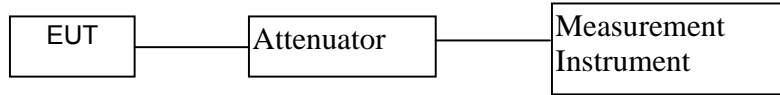

7.2 RADIO FREQUENCY TEST SETUP 2

The test site semi-anechoic chamber has met the requirement of NSA tolerance 4 dB according to the standards: ANSI C63.10. The test distance is 3m. The setup is according to the requirements in Section 13.1.4.1 of ANSI C63.10-2013 and CAN/CSA-CEI/IEC CISPR 22.

The maximal emission value is acquired by adjusting the antenna height, polarisation and turntable azimuth. Normally, the height range of antenna is 1 m to 4 m, the azimuth range of turntable is 0° to 360°, and the receive antenna has two polarizations Vertical (V) and Horizontal (H).

(a) Radiated Emission Test Set-Up, Frequency Below 30MHz

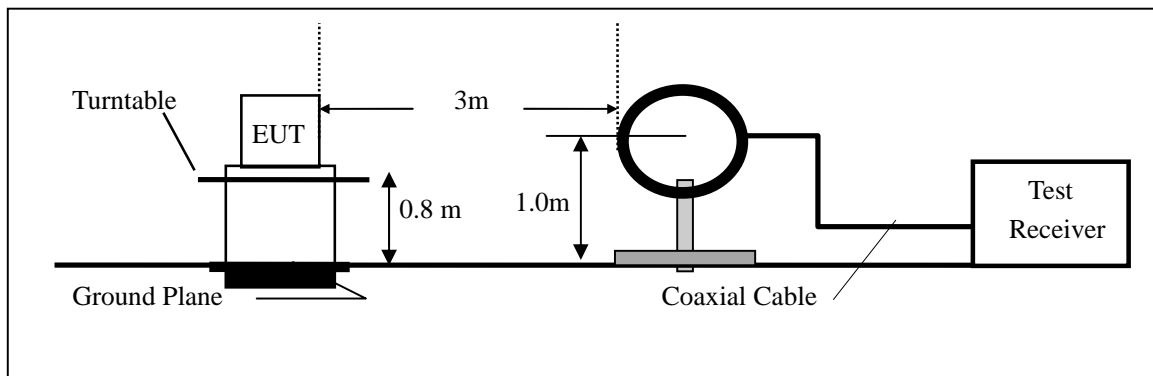

(b) Radiated Emission Test Set-Up, Frequency Below 1000MHz

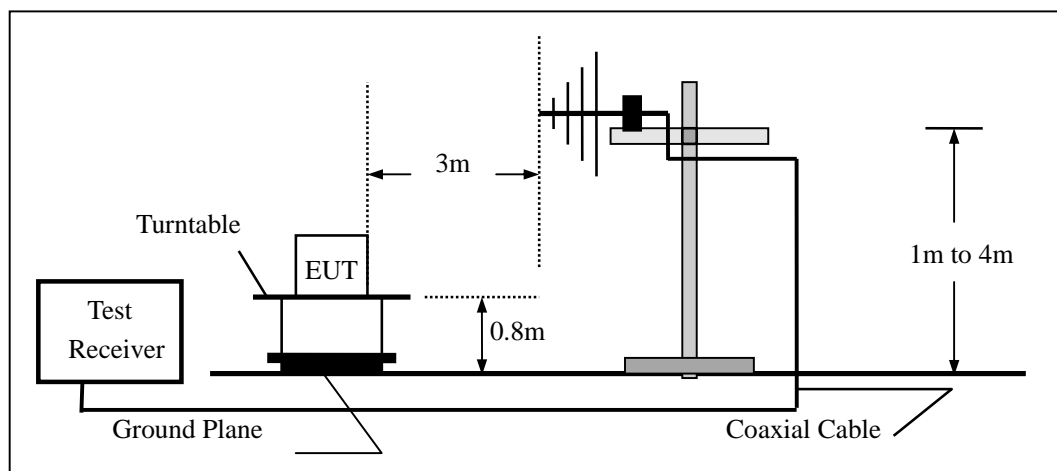

(c) Radiated Emission Test Set-Up, Frequency above 1000MHz

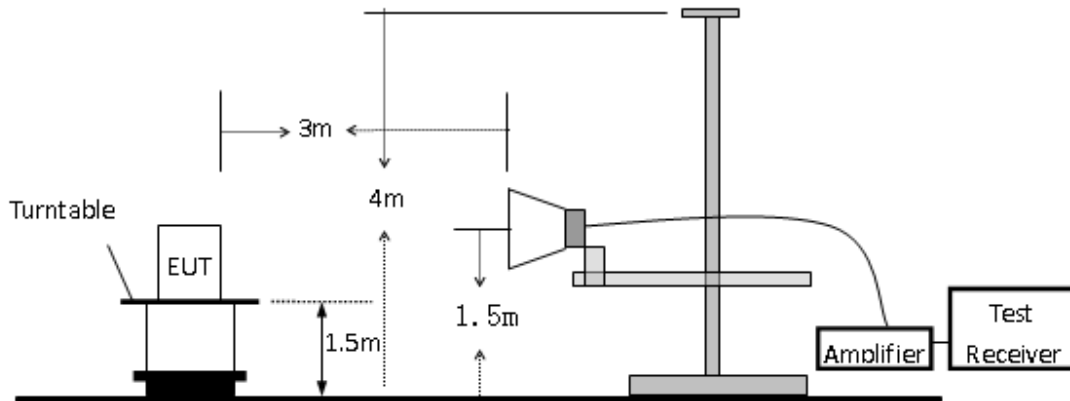

7.3 CONDUCTED EMISSION TEST SETUP

The mains cable of the EUT (Tablet PC) must be connected to LISN. The LISN shall be placed 0.8 m from the boundary of EUT and bonded to a ground reference plane for LISN mounted on top of the ground reference plane. This distance is between the closest points of the LISN and the EUT. All other units of the EUT and associated equipment shall be at least 0.8m from the LISN.

Ground connections, where required for safety purposes, shall be connected to the reference ground point of the LISN and, where not otherwise provided or specified by the manufacturer, shall be of same length as the mains cable and run parallel to the mains connection at a separation distance of not more than 0.1 m.

According to the requirements in Section 13.1.4.1 of ANSI C63.10-2013 Conducted emissions from the EUT measured in the frequency range between 0.15 MHz and 30 MHz using CISPR Quasi-Peak and average detector mode.

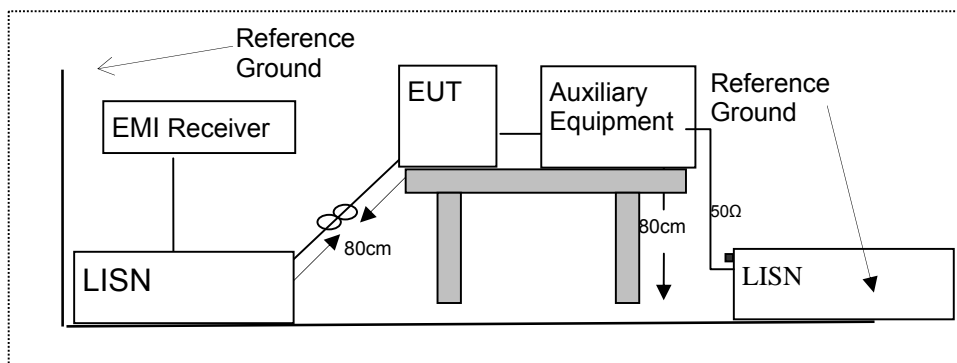

Notes:

1. All the equipment/cables were placed in the worst-case configuration to maximize the emission during the test.
2. Grounding was established in accordance with the manufacturer's requirements and conditions for the intended use.

8 TEST REQUIREMENTS

8.1 DTS (6DB) BANDWIDTH

8.1.1 Applicable Standard

According to FCC Part 15.247(a)(2) and KDB 558074 DTS 01 Meas. Guidance v03r03

8.1.2 Conformance Limit

The minimum -6 dB bandwidth shall be at least 500 kHz.

8.1.3 Test Configuration

Test according to clause 7.1 radio frequency test setup 1

8.1.4 Test Procedure

The EUT was operating in IEEE 802.11b/g/n mode and controlled its channel. Printed out the test result from the spectrum by hard copy function.

The RF output of EUT was connected to the spectrum analyzer by RF cable and attenuator. The path loss was compensated to the results for each measurement.

Set to the maximum power setting and enable the EUT transmit continuously

Set RBW = 100 kHz.

Set the video bandwidth (VBW) =300 kHz.

Set Span=2 times OBW

Set Detector = Peak.

Set Trace mode = max hold.

Set Sweep = auto couple.

Allow the trace to stabilize.

Measure the maximum width of the emission that is constrained by the frequencies associated with the two outermost amplitude points (upper and lower frequencies) that are attenuated by 6 dB relative to the maximum level measured in the fundamental emission.

Measure and record the results in the test report.

8.1.5 Test Results

Temperature: 24°C
Humidity: 53 %

Test Date: September 20, 2015
Test By: KING KONG

Operation Mode	Channel Number	Channel Frequency (MHz)	Measurement Bandwidth (MHz)	Limit (kHz)	Verdict
802.11b	1	2412	10.09	>500	PASS
	6	2437	10.09	>500	PASS
	11	2462	10.10	>500	PASS
802.11g	1	2412	16.38	>500	PASS
	6	2437	16.38	>500	PASS
	11	2462	16.39	>500	PASS
802.11n (HT20)	1	2412	17.62	>500	PASS
	6	2437	17.63	>500	PASS
	11	2462	17.64	>500	PASS

Test Model	DTS (6dB) Bandwidth
	802.11b
	Channel 1: 2412MHz

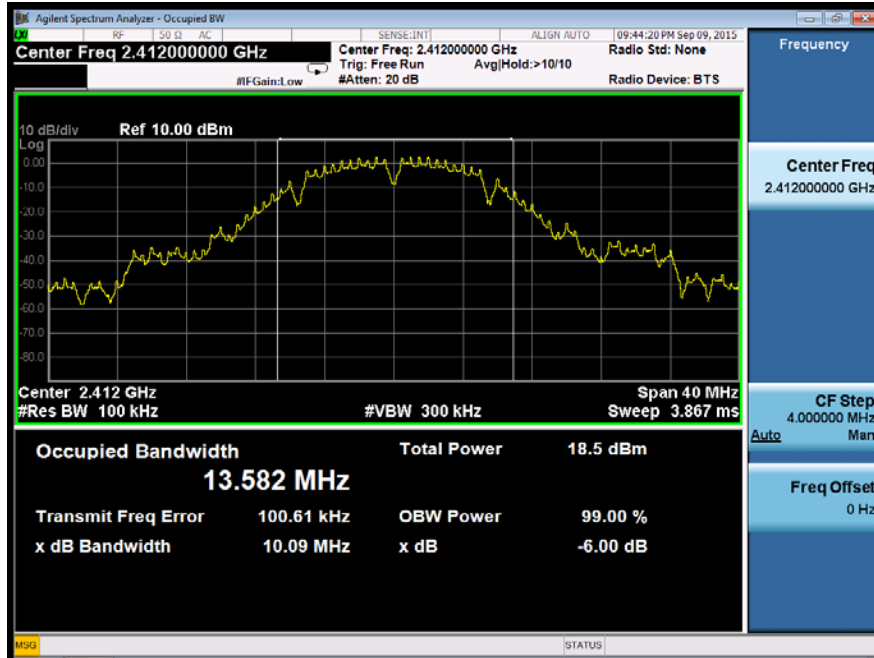

Test Model	DTS (6dB) Bandwidth
	802.11b
	Channel 6: 2437MHz

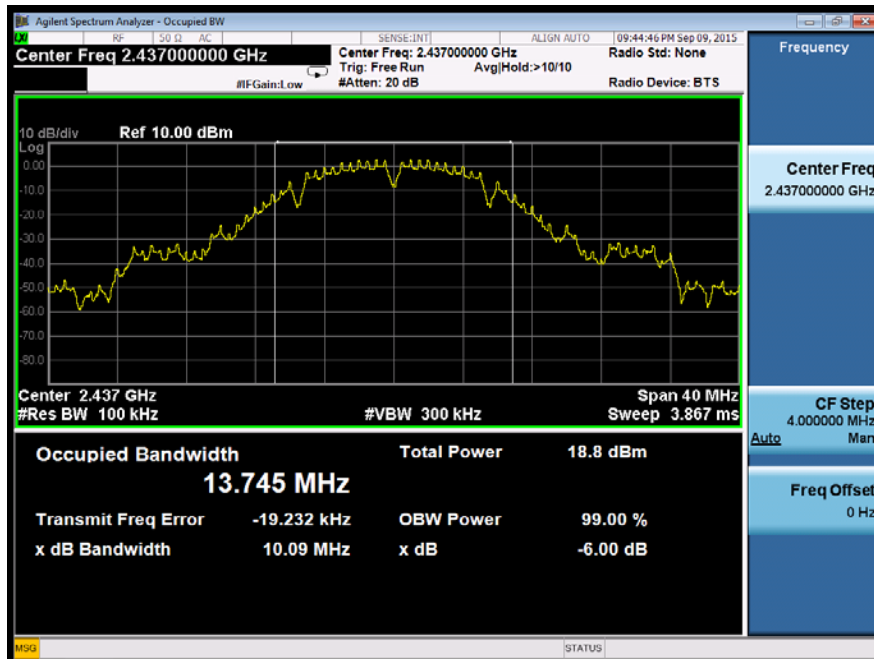

Test Model	DTS (6dB) Bandwidth
	802.11b
	Channel 11: 2462MHz

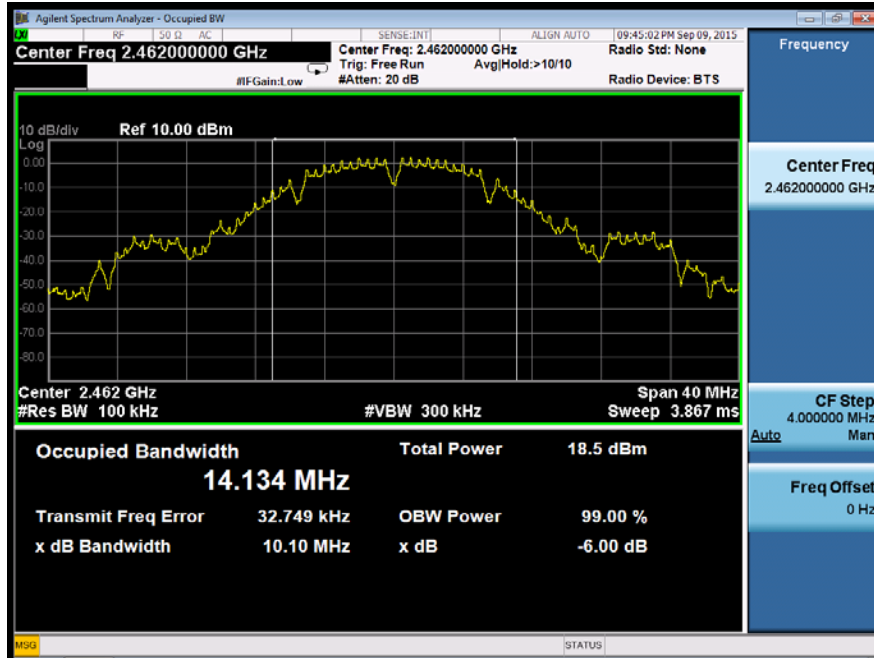

Test Model	DTS (6dB) Bandwidth
	802.11g
	Channel 1: 2412MHz

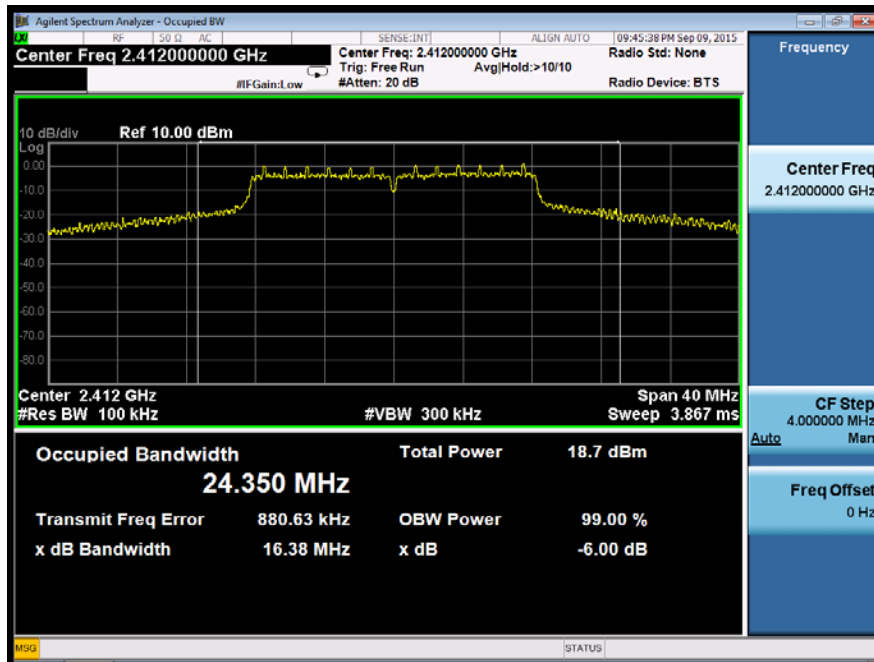

Test Model	DTS (6dB) Bandwidth
	802.11g
	Channel 6: 2437MHz

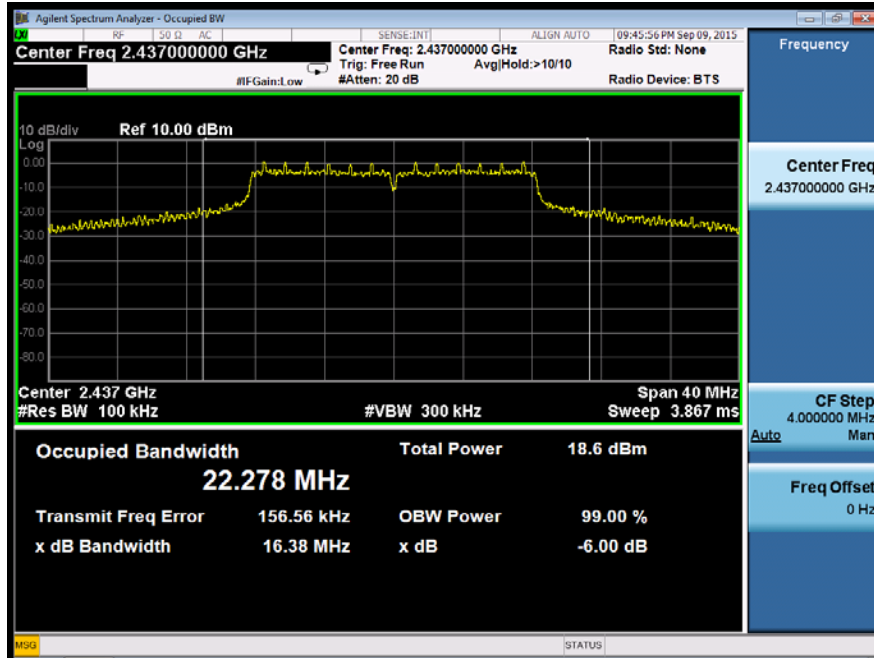

Test Model	DTS (6dB) Bandwidth
	802.11g
	Channel 11: 2462MHz

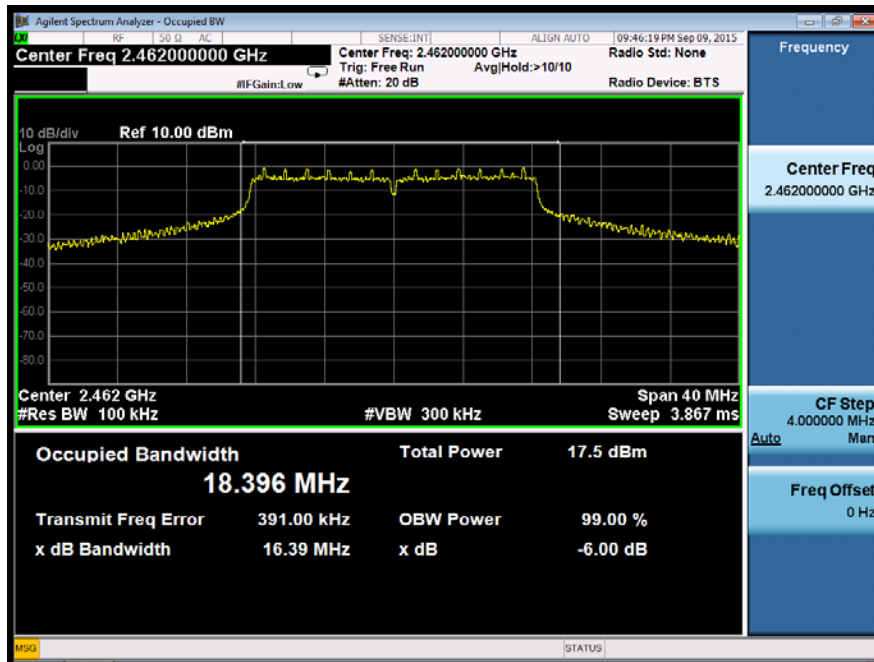

Test Model	DTS (6dB) Bandwidth
	802.11n (HT20)
	Channel 1: 2412MHz

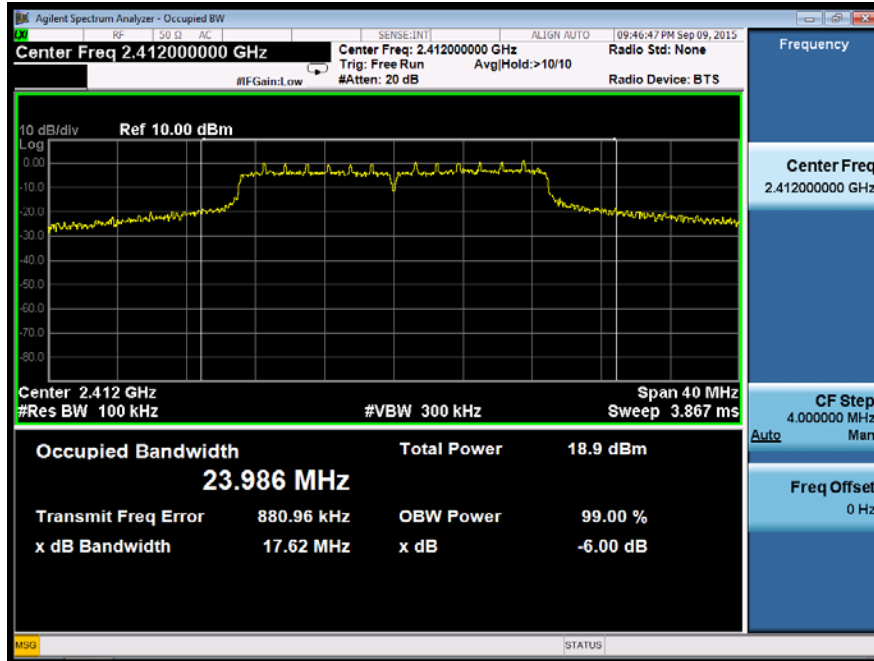

Test Model	DTS (6dB) Bandwidth
	802.11n (HT20)
	Channel 6: 2437MHz

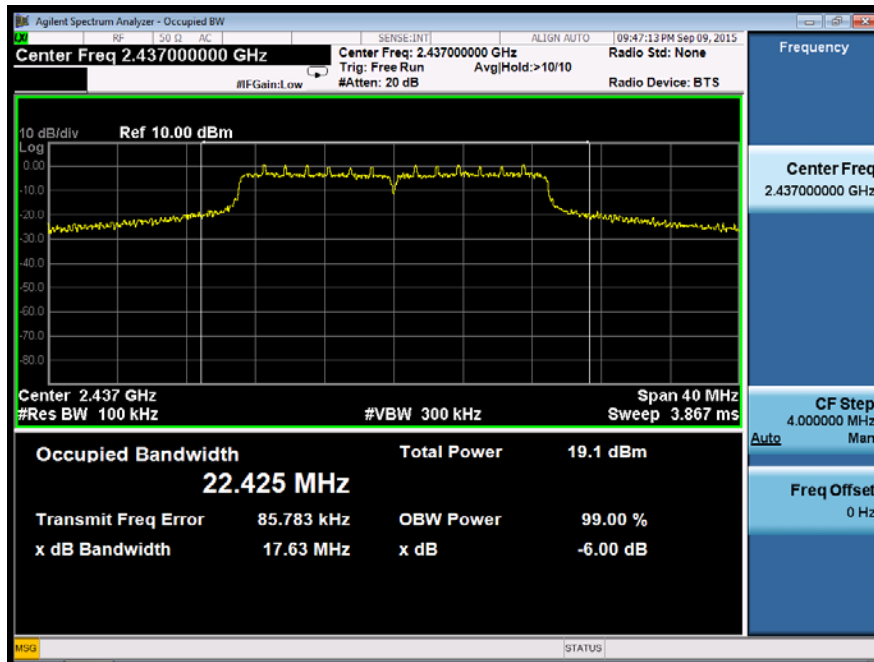

Test Model	DTS (6dB) Bandwidth
	802.11n (HT20)
	Channel 11: 2462MHz

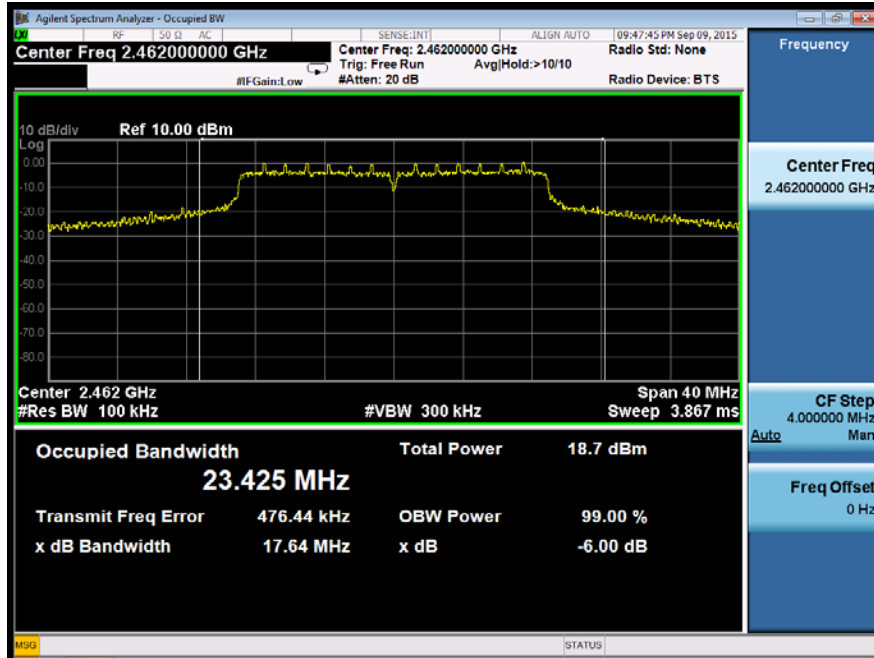

8.2 MAXIMUM PEAK CONDUCTED OUTPUT POWER

8.2.1 Applicable Standard

According to FCC Part 15.247(b)(3) and KDB 558074 DTS 01 Meas. Guidance v03r03

8.2.2 Conformance Limit

The maximum peak conducted output power of the intentional radiator for systems using digital modulation in the 2400 - 2483.5 MHz bands shall not exceed: 1 Watt (30dBm).

8.2.3 Test Configuration

Test according to clause 7.1 radio frequency test setup 1

8.2.4 Test Procedure

■ According to FCC Part 15.247(b)(3)

The maximum peak conducted output power may be measured using a broadband peak RF power meter. The power meter shall have a video bandwidth that is greater than or equal to the DTS bandwidth and shall utilize a fast-responding diode detector.

The RF output of EUT was connected to the power meter by RF cable and attenuator. The path loss was compensated to the results for each measurement.

Set to the maximum output power setting and enable the EUT transmit continuously.

Measure the conducted output power with cable loss and record the results in the test report.

Measure and record the results in the report.

■ According to FCC Part 15.247(b)(4):

Conducted output power limit specified in paragraph (b) of this section is based on the use of antennas with directional gains that do not exceed 6 dBi. If transmitting antennas of directional gain greater than 6 dBi are used, the conducted output power from the intentional radiator shall be reduced below the stated values in paragraphs (b)(3) of this section, as appropriate, by the amount in dB that the directional gain of the antenna exceeds 6 dBi.

8.2.5 Test Results

Temperature: 24°C
Humidity: 53 %

Test Date: September 20, 2015
Test By: KING KONG

Operation Mode	Channel Number	Channel Frequency (MHz)	Power Setting	Measurement Level (dBm)	Limit (dBm)	Verdict
802.11b	1	2412	32	7.39	30	PASS
	6	2437	33	7.91	30	PASS
	11	2462	35	7.59	30	PASS
802.11g	1	2412	38	7.82	30	PASS
	6	2437	39	7.78	30	PASS
	11	2462	41	7.74	30	PASS
802.11n (HT20)	1	2412	38	8.01	30	PASS
	6	2437	39	8.05	30	PASS
	11	2462	41	8.03	30	PASS
Note: N/A						

8.3 MAXIMUM POWER SPECTRAL DENSITY

8.3.1 Applicable Standard

According to FCC Part 15.247(e) and KDB 558074 DTS 01 Meas. Guidance v03r03

8.3.2 Conformance Limit

The transmitter power spectral density conducted from the transmitter to the antenna shall not be greater than 8 dBm in any 3 kHz band during any time interval of continuous transmission.

8.3.3 Test Configuration

Test according to clause 7.1 radio frequency test setup 1

8.3.4 Test Procedure

This procedure shall be used if maximum peak conducted output power was used to demonstrate compliance

The transmitter output (antenna port) was connected to the spectrum analyzer

Set analyzer center frequency to DTS channel center frequency.

Set the span to 1.5 times the DTS bandwidth.

Set the RBW to: 3 kHz

Set the VBW to: 10 kHz.

Set Detector = peak.

Set Sweep time = auto couple.

Set Trace mode = max hold.

Allow trace to fully stabilize.

Use the peak marker function to determine the maximum amplitude level within the RBW.

8.3.5 Test Results

Temperature: 24°C
Humidity: 53 %

Test Date: September 20, 2015
Test By: KING KONG

Operation Mode	Channel Number	Channel Frequency (MHz)	Measurement Level (dBm/3kHz)	Limit (dBm/3kHz)	Verdict
802.11b	1	2412	-12.531	8	PASS
	6	2437	-11.565	8	PASS
	11	2462	-11.846	8	PASS
802.11g	1	2412	-15.365	8	PASS
	6	2437	-15.234	8	PASS
	11	2462	-14.858	8	PASS
802.11n (HT20)	1	2412	-14.850	8	PASS
	6	2437	-13.937	8	PASS
	11	2462	-16.030	8	PASS

Note: N/A

Test Model	Power Spectral Density
	802.11b
	Channel 1: 2412MHz



Test Model	Power Spectral Density
	802.11b
	Channel 6: 2437MHz



Test Model	Power Spectral Density
	802.11b
	Channel 11: 2462MHz



Test Model	Power Spectral Density
	802.11g
	Channel 1: 2412MHz

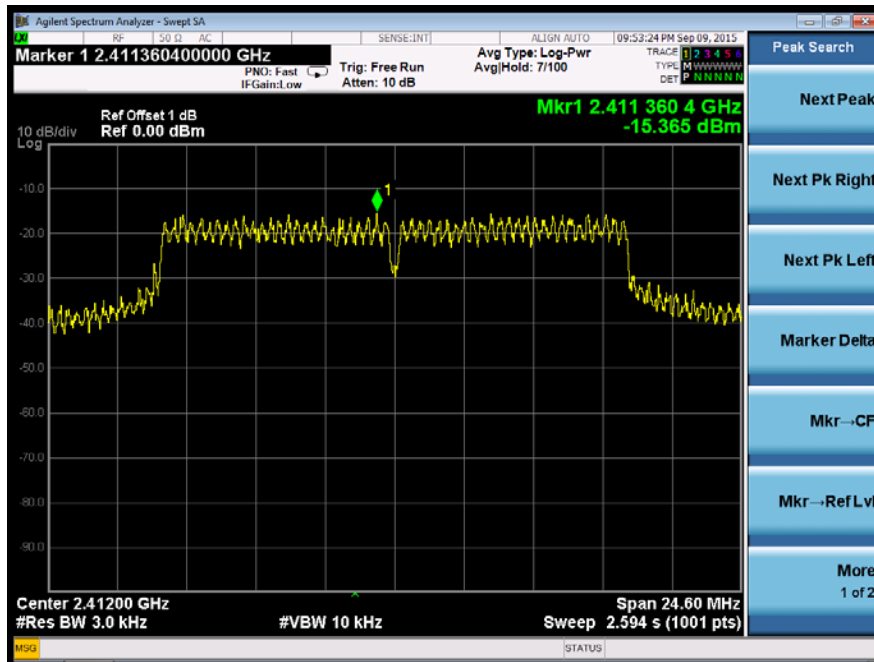

Test Model	Power Spectral Density
	802.11g
	Channel 6: 2437MHz

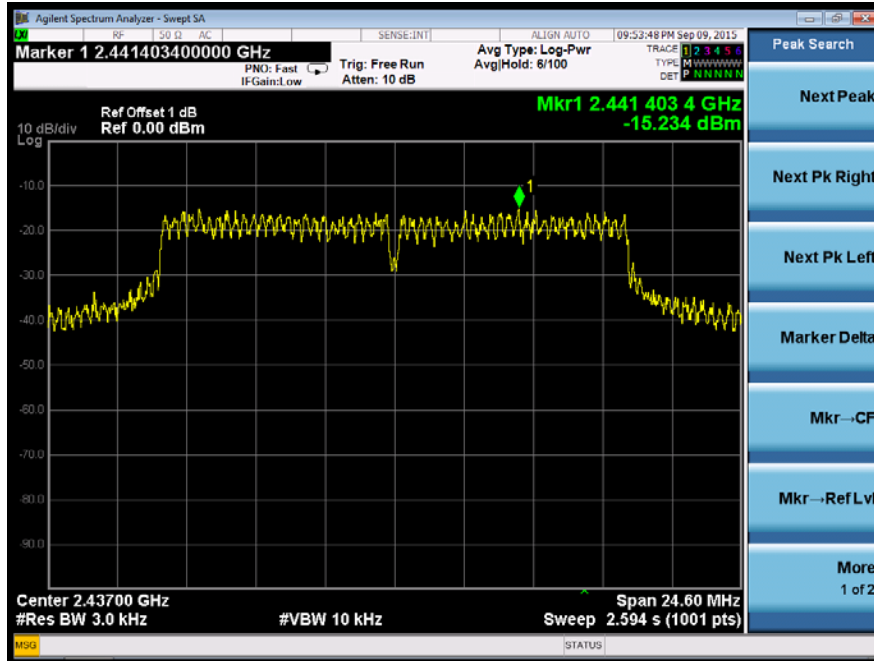

Test Model	Power Spectral Density
	802.11g
	Channel 11: 2462MHz

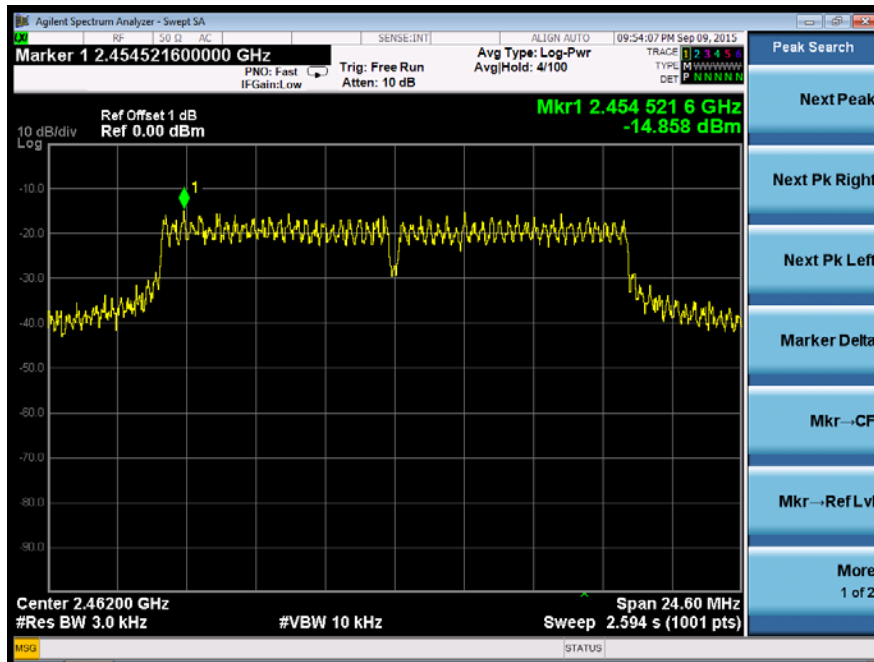

Test Model	Power Spectral Density
	802.11n (HT20)
	Channel 1: 2412MHz

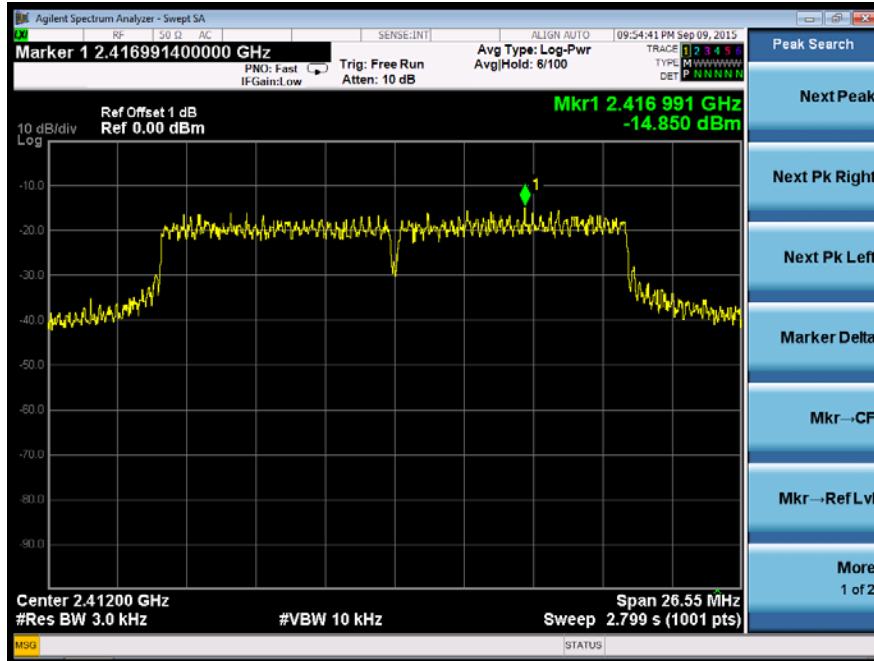

Test Model	Power Spectral Density
	802.11n (HT20)
	Channel 6: 2437MHz

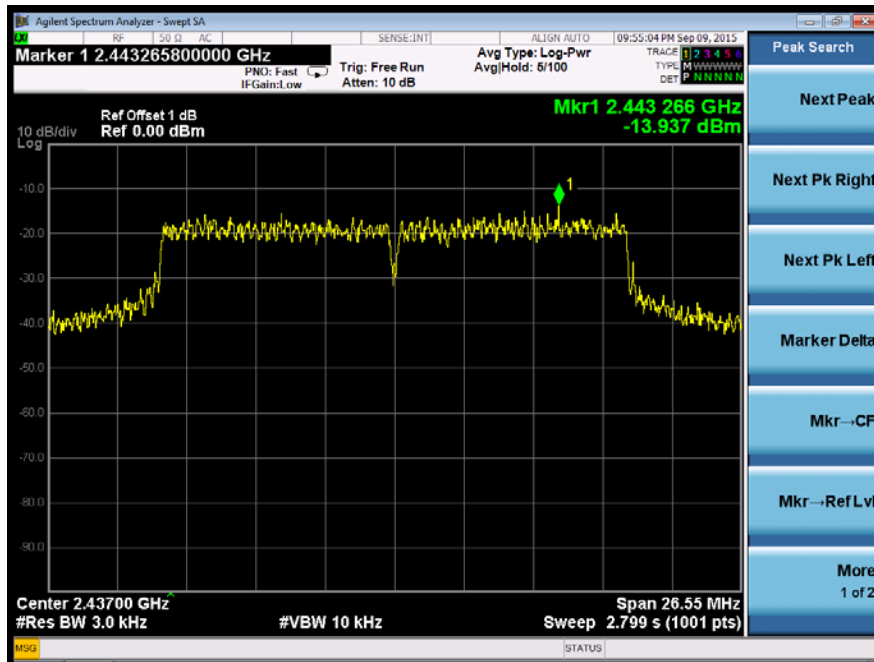

Test Model	Power Spectral Density
	802.11n (HT20)
	Channel 11: 2462MHz

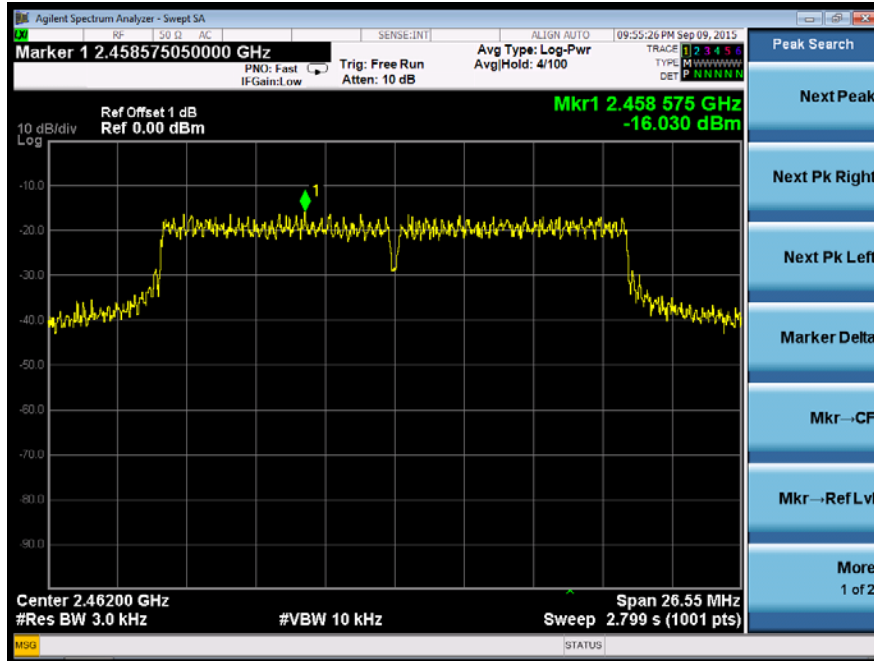

8.4 UNWANTED EMISSIONS INTO NON-RESTRICTED FREQUENCY BANDS

8.4.1 Applicable Standard

According to FCC Part 15.247(d) and KDB 558074 DTS 01 Meas. Guidance v03r03

8.4.2 Conformance Limit

According to FCC Part 15.247(d):

In any 100 kHz bandwidth outside the frequency band in which the spread spectrum or digitally modulated intentional radiator is operating, the radio frequency power that is produced by the intentional radiator shall be at least 20 dB below that in the 100 kHz bandwidth within the band that contains the highest level of the desired power, based on either an RF conducted or a radiated measurement, provided the transmitter demonstrates compliance with the peak conducted power limits. If the transmitter complies with the conducted power limits based on the use of RMS averaging over a time interval, as permitted under paragraph (b)(3) of this section, the attenuation required under this paragraph shall be 30 dB instead of 20 dB.

8.4.3 Test Configuration

Test according to clause 7.1 radio frequency test setup 1

8.4.4 Test Procedure

The transmitter output (antenna port) was connected to the spectrum analyzer

■ Reference level measurement

Establish a reference level by using the following procedure:

Set instrument center frequency to DTS channel center frequency.

Set the span to ≥ 1.5 times the DTS bandwidth.

Set the RBW = 100 kHz.

Set the VBW $\geq 3 \times$ RBW.

Set Detector = peak.

Set Sweep time = auto couple.

Set Trace mode = max hold.

Allow trace to fully stabilize.

Use the peak marker function to determine the maximum PSD level.

Note that the channel found to contain the maximum PSD level can be used to establish the reference level.

■ Emission level measurement

Set the center frequency and span to encompass frequency range to be measured.

Set the RBW = 100 kHz.

Set the VBW = 300 kHz.

Set Detector = peak

Sweep time = auto couple.

Trace mode = max hold.

Allow trace to fully stabilize.

Use the peak marker function to determine the maximum amplitude level.

Ensure that the amplitude of all unwanted emissions outside of the authorized frequency band (excluding restricted frequency bands) are attenuated by at least the minimum requirements. Report the three highest emissions relative to the limit.

8.4.5 Test Results

All the modulation modes were tested, the data of the worst mode(802.11b) are described in the following table

Test Model	Unwanted Emissions in non-restricted frequency bands
	802.11b
	Channel 1: 2412MHz

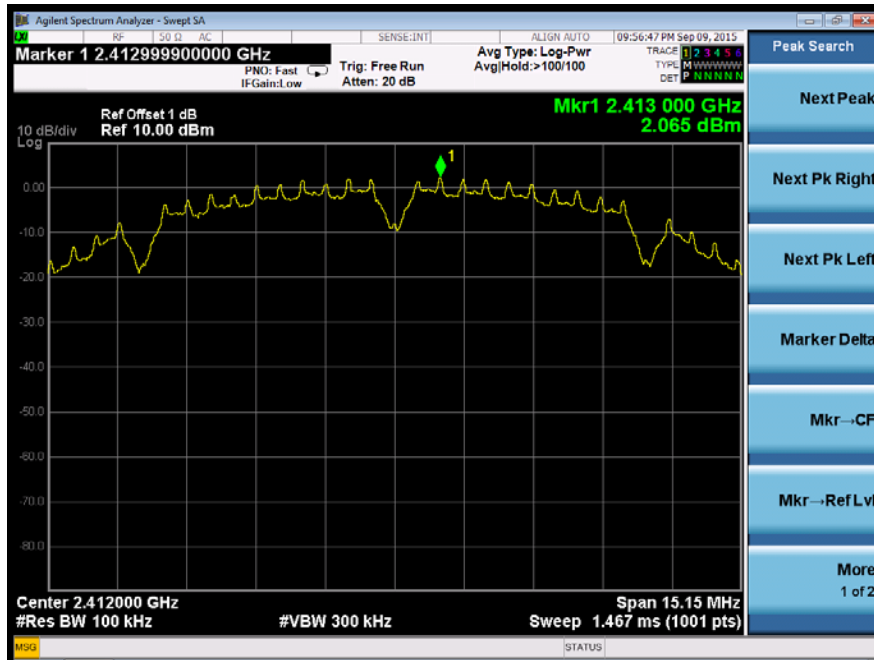

Test Model	Unwanted Emissions in non-restricted frequency bands
	802.11b
	Channel 6: 2437MHz

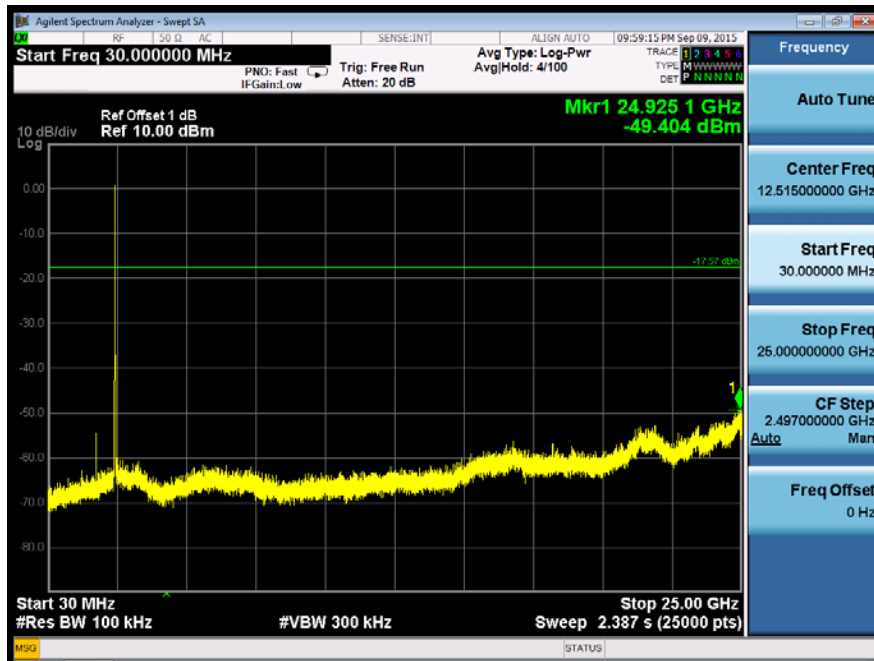
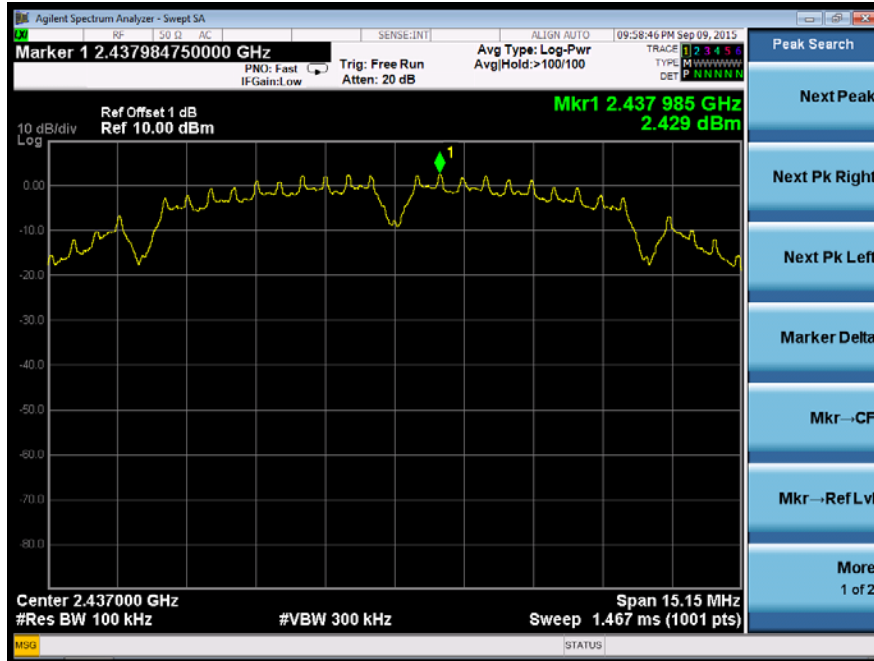

Test Model	Unwanted Emissions in non-restricted frequency bands
	802.11b
	Channel 11: 2462MHz

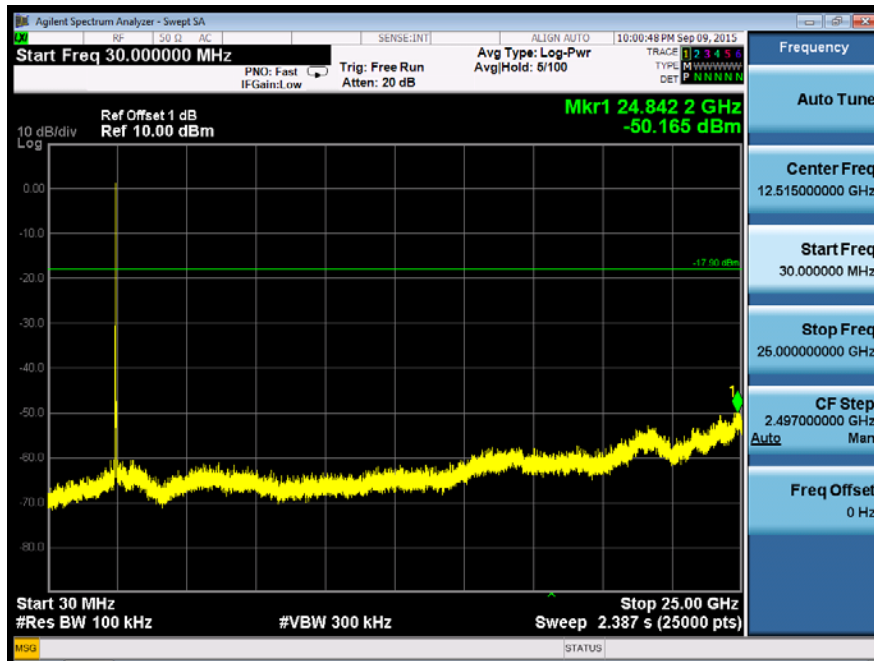
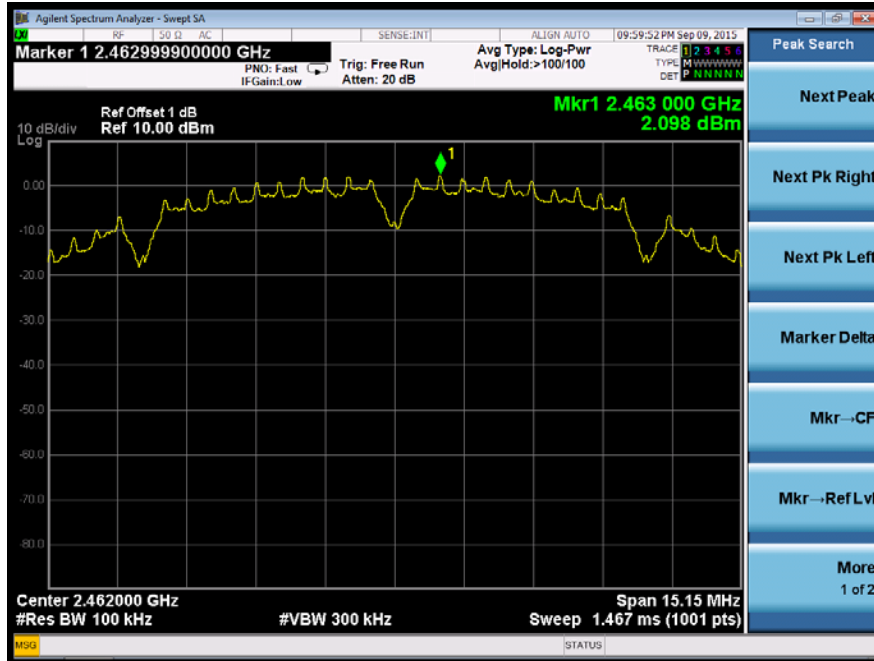

Test Model	Band edge
	802.11b
	Channel 1: 2412MHz



Test Model	Band edge
	802.11b
	Channel 11: 2462MHz



8.5 RADIATED SPURIOUS EMISSION

8.5.1 Applicable Standard

According to FCC Part 15.247(d) and 15.209 and KDB 558074 DTS 01 Meas. Guidance v03r03

8.5.2 Conformance Limit

According to FCC Part 15.247(d): radiated emissions which fall in the restricted bands, as defined in §15.205(a), must also comply with the radiated emission limits specified in §15.209(a) (see §15.205(c)).

According to FCC Part 15.205, Restricted bands

MHz	MHz	MHz	GHz
0.090-0.110	16.42-16.423	399.9-410	4.5-5.15
10.495-0.505	16.69475-16.69525	608-614	5.35-5.46
2.1735-2.1905	16.80425-16.80475	960-1240	7.25-7.75
4.125-4.128	25.5-25.67	1300-1427	8.025-8.5
4.17725-4.17775	37.5-38.25	1435-1626.5	9.0-9.2
4.20725-4.20775	73-74.6	1645.5-1646.5	9.3-9.5
6.215-6.218	74.8-75.2	1660-1710	10.6-12.7
6.26775-6.26825	123-138	2200-2300	14.47-14.5
8.291-8.294	149.9-150.05	2310-2390	15.35-16.2
8.362-8.366	156.52475-156.52525	2483.5-2500	17.7-21.4
8.37625-8.38675	156.7-156.9	2690-2900	22.01-23.12
8.41425-8.41475	162.0125-167.17	3260-3267	23.6-24.0
12.29-12.293	167.72-173.2	3332-3339	31.2-31.8
12.51975-12.52025	240-285	3345.8-3358	36.43-36.5
12.57675-12.57725	322-335.4	3600-4400	(2)
13.36-13.41			

According to FCC Part 15.205, the level of any transmitter spurious emission in Restricted bands shall not exceed the level of the emission specified in the following table

Restricted Frequency(MHz)	Field Strength ($\mu\text{V}/\text{m}$)	Field Strength ($\text{dB}\mu\text{V}/\text{m}$)	Measurement Distance
0.009~0.490	2400/F(KHz)	20 log ($\mu\text{V}/\text{m}$)	300
0.490~1.705	2400/F(KHz)	20 log ($\mu\text{V}/\text{m}$)	30
1.705~30.0	30	29.5	30
30-88	100	40	3
88-216	150	43.5	3
216-960	200	46	3
Above 960	500	54	3

Remark: 1. Emission level in $\text{dB}\mu\text{V}/\text{m} = 20 \log (\mu\text{V}/\text{m})$

2. Measurement was performed at an antenna to the closed point of EUT distance of meters.

3. Distance extrapolation factor = $40 \log (\text{Specific distance} / \text{test distance})$ (dB);

Limit line = Specific limits (dB μV) + distance extrapolation factor.

for the frequency ranges below 30 MHz, a narrower RBW is used for these ranges but the measured value should add a RBW correction factor (RBWCF) where $\text{RBWCF} [\text{dB}] = 10 \cdot \lg(100 [\text{kHz}] / \text{narrower RBW} [\text{kHz}])$. , the narrower RBW is 1 kHz and RBWCF is 20 dB for the frequency 9 kHz to 150 kHz, and the narrower RBW is 10 kHz and RBWCF is 10 dB for the frequency 150 kHz to 30 MHz.

8.5.3 Test Configuration

Test according to clause 7.2 radio frequency test setup 2

8.5.4 Test Procedure

This test is required for any spurious emission that falls in a Restricted Band, as defined in Section 15.205. It must be performed with the highest gain of each type of antenna proposed for use with the EUT. Use the following spectrum analyzer settings:

The EUT was placed on a turn table which is 0.8m above ground plane.

Maximum procedure was performed on the highest emissions to ensure EUT compliance.

Span = wide enough to fully capture the emission being measured

RBW = 1 MHz for $f \geq 1$ GHz(1GHz to 25GHz), 100 kHz for $f < 1$ GHz(30MHz to 1GHz)

VBW \geq RBW for peak measurement

VBW = 10Hz for average measurement

Sweep = auto

Detector function = peak

Trace = max hold

Follow the guidelines in ANSI C63.4-1992 with respect to maximizing the emission by rotating the EUT, measuring the emission while the EUT is situated in three orthogonal planes (if appropriate), adjusting the measurement antenna height and polarization, etc. A pre-amp and a high pass filter are required for this test, in order to provide the measuring system with sufficient sensitivity. Allow the trace to stabilize. The peak reading of the emission, after being corrected by the antenna factor, cable loss, pre-amp gain, etc., is the peak field strength, which must comply with the limit specified in Section 15.35(b). Submit this data.

Now set the VBW to 10 Hz, while maintaining all of the other instrument settings. This peak level, once corrected, must comply with the limit specified in Section 15.209. If the dwell time per channel of the hopping signal is less than 100 ms, then the reading obtained with the 10 Hz VBW may be further adjusted by a "duty cycle correction factor", derived from $20\log(\text{dwell time}/100 \text{ ms})$, in an effort to demonstrate compliance with the 15.209 limit. Submit this data.

Repeat above procedures until all frequency measured was complete.

8.5.5 Test Results

■ Spurious Emission below 30MHz (9KHz to 30MHz)

Test mode: TX Mode

Freq. (MHz)	Ant.Pol. H/V	Emission Level(dBuV/m)		Limit 3m(dBuV/m)		Over(dB)	
		PK	AV	PK	AV	PK	AV
--	--	--	--	--	--	--	--

■ Spurious Emission Below 1GHz (30MHz to GHz)

All modes 2.4G 802.11b/g/n have been tested, and the worst result 802.11b recorded was report as below:

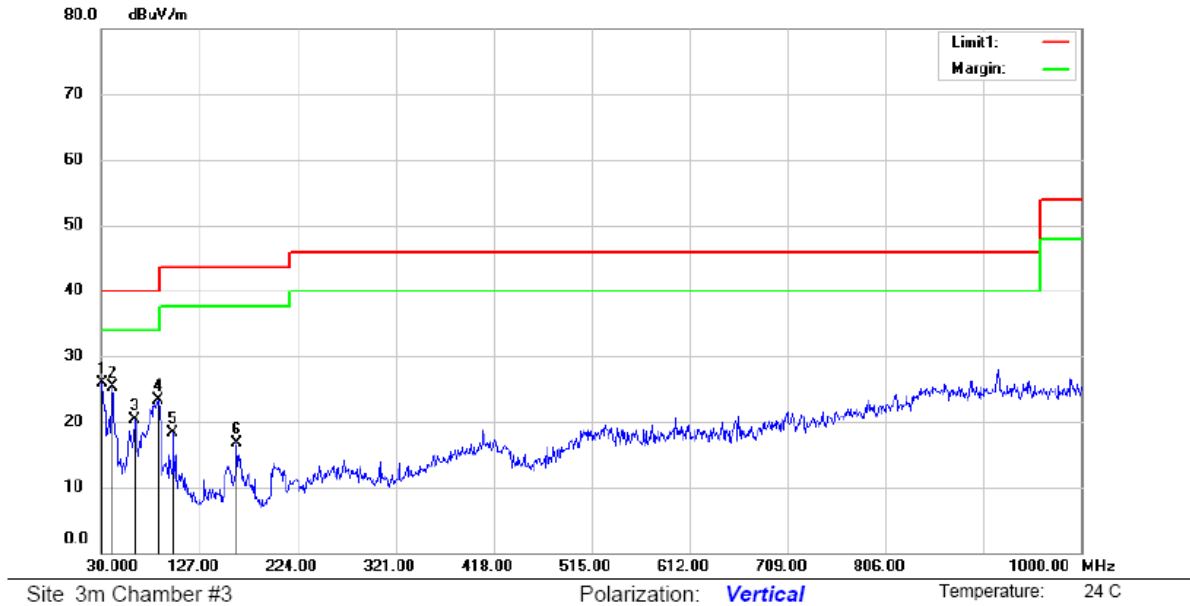

Mode: 11B 2412

Note:

No.	Mk.	Freq. MHz	Reading Level dBuV	Correct Factor dB	Measure- ment dBuV/m	Limit dBuV/m	Over dB	Antenna Height cm	Table Degree degree	Comment
1	*	30.9700	42.06	-16.13	25.93	40.00	-14.07	QP		
2		40.6700	38.16	-12.87	25.29	40.00	-14.71	QP		
3		62.9800	36.63	-16.40	20.23	40.00	-19.77	QP		
4		86.2600	41.39	-18.10	23.29	40.00	-16.71	QP		
5		100.8100	32.30	-14.02	18.28	43.50	-25.22	QP		
6		163.8600	35.74	-19.00	16.74	43.50	-26.76	QP		

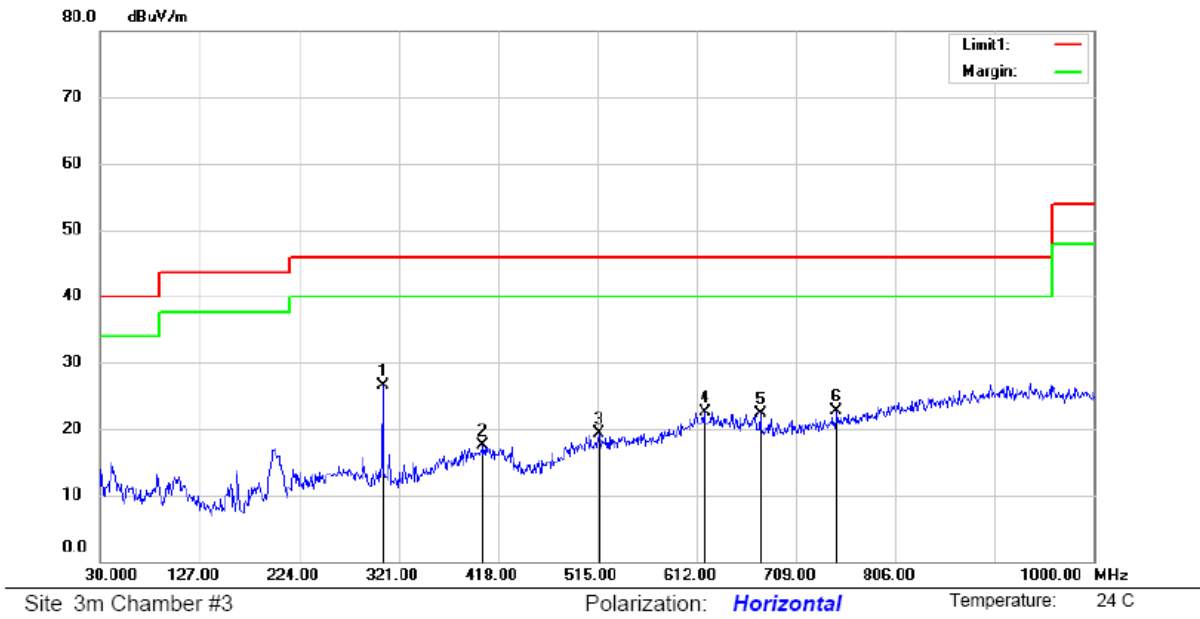

Mode: 11B 2412

Note:

No.	Mk.	Freq.	Reading Level	Correct Factor	Measurement	Limit	Over	Antenna Height	Table Degree	
		MHz	dBuV	dB	dBuV/m	dBuV/m	dB	cm	degree	Comment
1	*	305.4800	40.33	-13.75	26.58	46.00	-19.42	QP		
2		403.4500	26.37	-8.96	17.41	46.00	-28.59	QP		
3		516.9400	26.96	-7.66	19.30	46.00	-26.70	QP		
4		619.7600	29.22	-6.79	22.43	46.00	-23.57	QP		
5		674.0800	28.51	-6.24	22.27	46.00	-23.73	QP		
6		748.7700	27.21	-4.46	22.75	46.00	-23.25	QP		

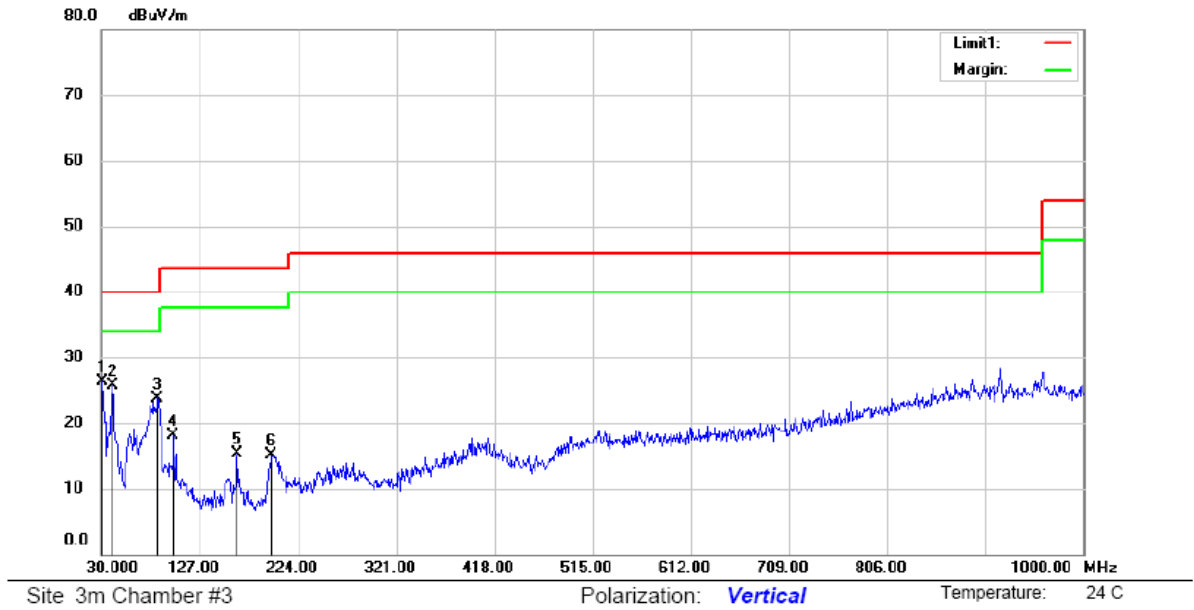

Mode: 11B 2437

Note:

No.	Mk.	Freq. MHz	Reading Level dBuV	Correct Factor dB	Measure- ment dBuV/m	Limit dBuV/m	Over dB	Detector	Antenna Height cm	Table Degree	Comment
1	*	30.9700	42.40	-16.13	26.27	40.00	-13.73	QP			
2		40.6700	38.50	-12.87	25.63	40.00	-14.37	QP			
3		85.2900	42.21	-18.41	23.80	40.00	-16.20	QP			
4		100.8100	32.22	-14.02	18.20	43.50	-25.30	QP			
5		163.8600	34.31	-19.00	15.31	43.50	-28.19	QP			
6		197.8100	31.66	-16.59	15.07	43.50	-28.43	QP			

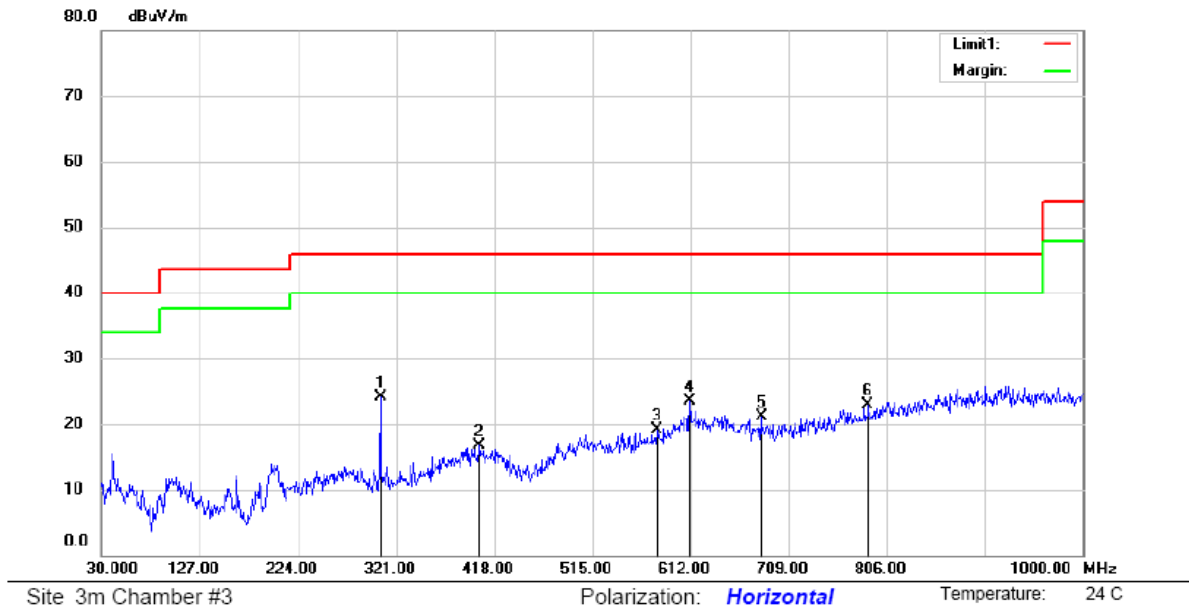

Mode: 11B 2437

Note:

No.	Mk.	Freq. MHz	Reading Level dBuV	Correct Factor dB	Measure- ment dBuV/m	Limit dBuV/m	Over dB	Detector	Antenna Height cm	Table Degree	Comment
1	*	305.4800	37.83	-13.75	24.08	46.00	-21.92	QP			
2		403.4500	25.60	-8.96	16.64	46.00	-29.36	QP			
3		579.0200	26.24	-7.16	19.08	46.00	-26.92	QP			
4		611.0300	30.30	-6.87	23.43	46.00	-22.57	QP			
5		681.8400	27.26	-6.16	21.10	46.00	-24.90	QP			
6		787.5700	26.24	-3.25	22.99	46.00	-23.01	QP			

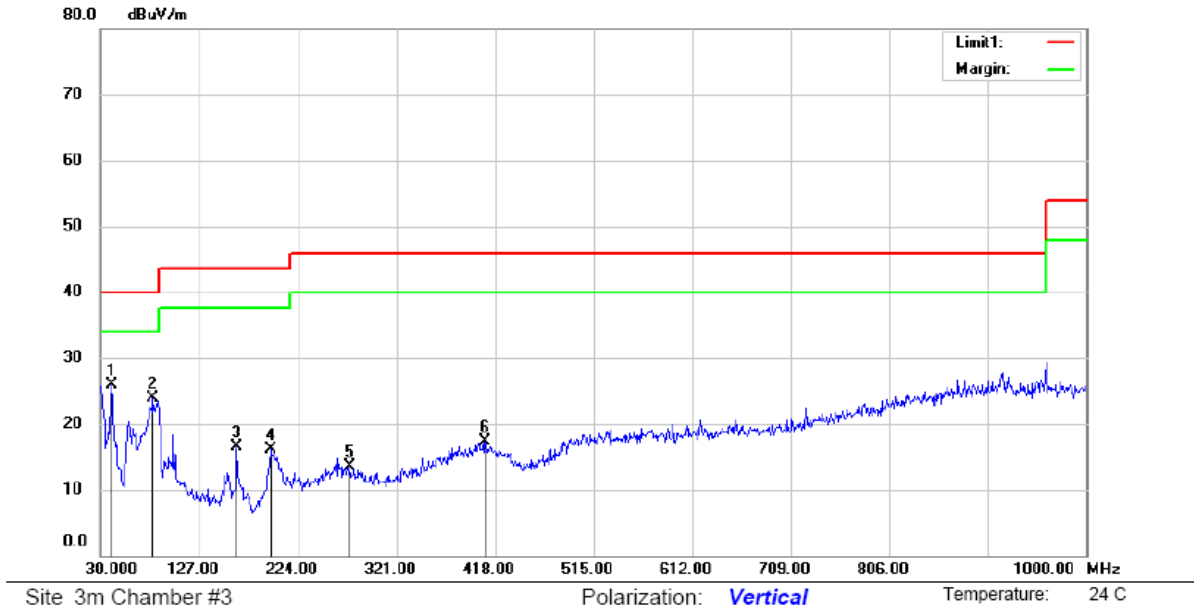

Mode: 11B 2462

Note:

No.	Mk.	Freq. MHz	Reading Level dBuV	Correct Factor dB	Measure- ment dBuV/m	Limit dBuV/m	Over dB	Antenna Height cm	Table Degree	Comment
1	*	40.6700	38.83	-12.87	25.96	40.00	-14.04	QP		
2		81.4100	43.03	-19.15	23.88	40.00	-16.12	QP		
3		163.8600	35.45	-19.00	16.45	43.50	-27.05	QP		
4		196.8400	32.76	-16.68	16.08	43.50	-27.42	QP		
5		275.4100	26.12	-12.62	13.50	46.00	-32.50	QP		
6		408.3000	26.45	-9.10	17.35	46.00	-28.65	QP		

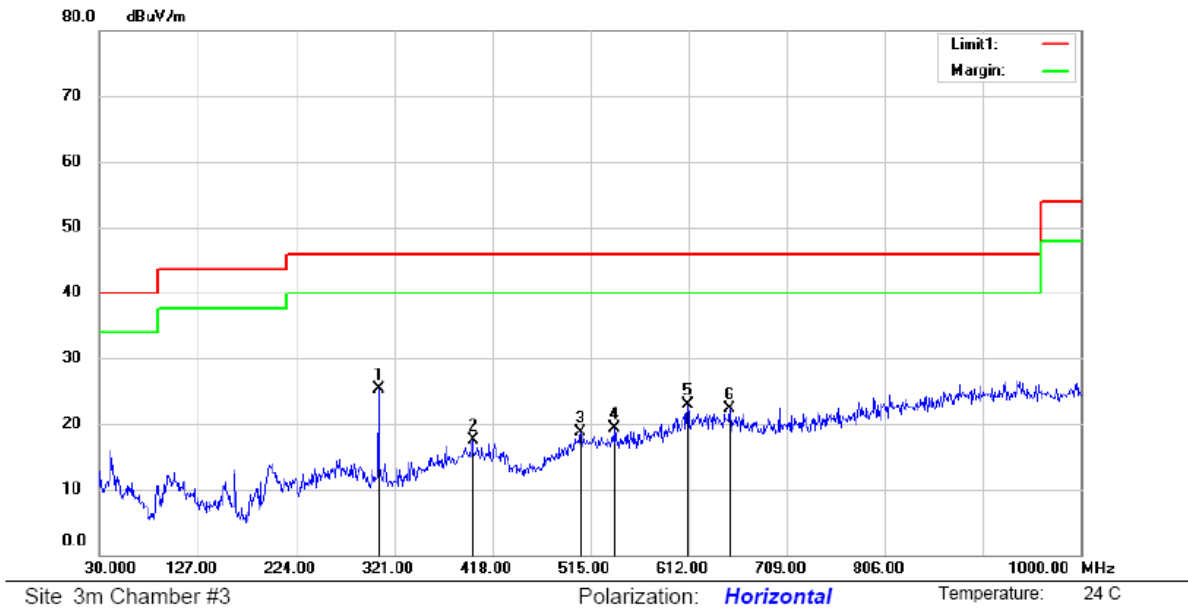

Mode: 11B 2462

Note:

No.	Mk.	Freq. MHz	Reading Level dBuV	Correct Factor dB	Measure- ment dBuV/m	Limit dBuV/m	Over dB	Antenna Height cm	Table Degree	Detector	Comment
1	*	305.4800	39.03	-13.75	25.28	46.00	-20.72			QP	
2		398.6000	26.50	-8.95	17.55	46.00	-28.45			QP	
3		505.3000	26.46	-7.75	18.71	46.00	-27.29			QP	
4		539.2500	26.80	-7.48	19.32	46.00	-26.68			QP	
5		611.0300	29.69	-6.87	22.82	46.00	-23.18			QP	
6		652.7400	28.81	-6.46	22.35	46.00	-23.65			QP	

■ Spurious Emission Above 1GHz (1GHz to 25GHz)

All modes 2.4G 802.11b/g/n have been tested, and the worst result 802.11b recorded was report as below:

Temperature: 24°C Test Date: September 18, 2015
 Humidity: 53 % Test By: KING KONG
 Test mode: 802.11b Frequency: Channel 1: 2412MHz

Freq. (MHz)	Ant.Pol. H/V	Emission Level(dBuV/m)		Limit 3m(dBuV/m)		Over(dB)	
		PK	AV	PK	AV	PK	AV
9415.00	V	45.24	42.20	74.00	54.00	-28.76	-11.80
11230.00	V	45.15	42.10	74.00	54.00	-28.85	-11.90
17204.00	V	48.90	40.33	74.00	54.00	-25.10	-13.67
--	--	--	--	--	--	--	--
--	--	--	--	--	--	--	--
9611.00	H	48.22	42.60	74.00	54.00	-25.78	-11.40
13420.00	H	46.90	42.30	74.00	54.00	-27.10	-11.70
15121.00	H	47.50	41.22	74.00	54.00	-26.50	-12.78

Test mode: 802.11b Frequency: Channel 6: 2437MHz

Freq. (MHz)	Ant.Pol. H/V	Emission Level(dBuV/m)		Limit 3m(dBuV/m)		Over(dB)	
		PK	AV	PK	AV	PK	AV
9610.00	V	48.70	42.13	74.00	54.00	-25.30	-11.87
12310.00	V	47.88	42.20	74.00	54.00	-26.12	-11.80
17202.00	V	49.60	41.33	74.00	54.00	-24.40	-12.67
--	--	--	--	--	--	--	--
--	--	--	--	--	--	--	--
9414.00	H	47.41	42.73	74.00	54.00	-26.59	-11.27
11850.00	H	47.28	42.35	74.00	54.00	-26.72	-11.65
17420.00	H	49.21	40.77	74.00	54.00	-24.79	-13.23

Test mode: 802.11b Frequency: Channel 11: 2462MHz

Freq. (MHz)	Ant.Pol. H/V	Emission Level(dBuV/m)		Limit 3m(dBuV/m)		Over(dB)	
		PK	AV	PK	AV	PK	AV
7521.00	V	48.20	42.50	74.00	54.00	-25.80	-11.50
14532.00	V	48.30	42.80	74.00	54.00	-25.70	-11.20
17317.00	V	48.24	41.10	74.00	54.00	-25.76	-12.90
--	--	--	--	--	--	--	--
--	--	--	--	--	--	--	--
8120.00	H	49.40	42.67	74.00	54.00	-24.60	-11.33
14001.00	H	50.25	42.59	74.00	54.00	-23.75	-11.41
16142.00	H	49.46	40.90	74.00	54.00	-24.54	-13.10

Note: (1) All Readings are Peak Value (VBW=3MHz) and Peak Value (VBW=10Hz).

(2) Emission Level= Reading Level+Probe Factor +Cable Loss.

(3) Data of measurement within this frequency range shown “ -- ” in the table above means the reading of emissions are attenuated more than 20dB below the permissible limits or the field strength is too small to be measured.

■ Spurious Emission in Restricted Band 2310-2390MHz and 2483.5-2500MHz

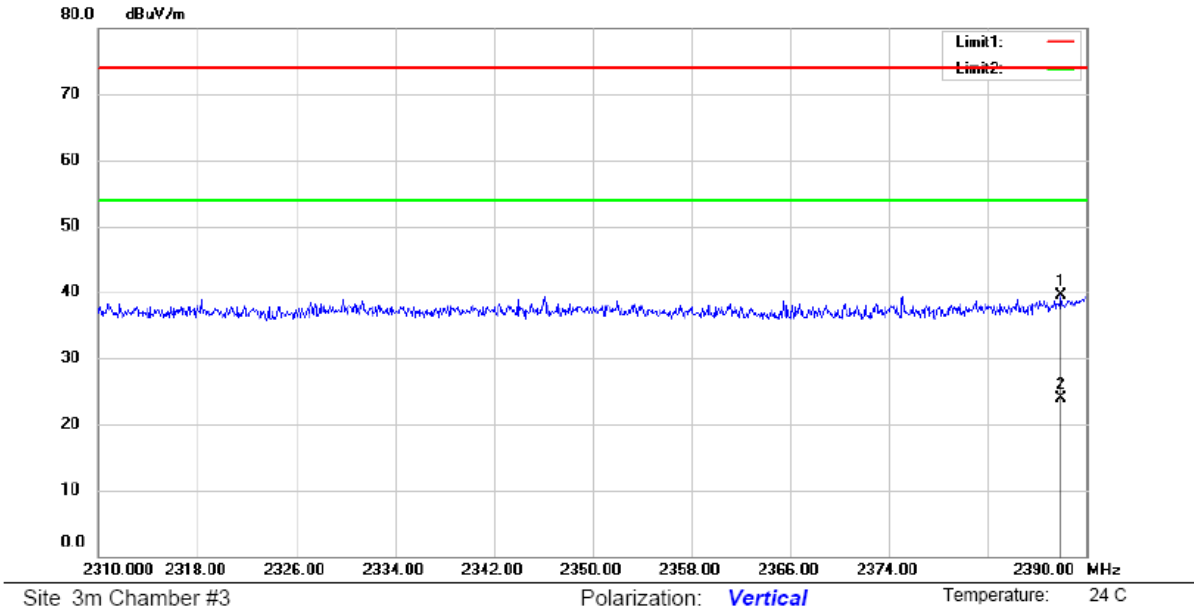

Mode: 11B 2412

Note:

No.	Mk.	Freq. MHz	Reading Level dBuV	Correct Factor dB	Measure- ment dBuV/m	Limit dBuV/m	Over dB	Antenna Height cm	Table Degree	Detector	Comment
1		2387.920	63.17	-23.73	39.44	74.00	-34.56			peak	
2	*	2387.920	47.57	-23.73	23.84	54.00	-30.16			AVG	

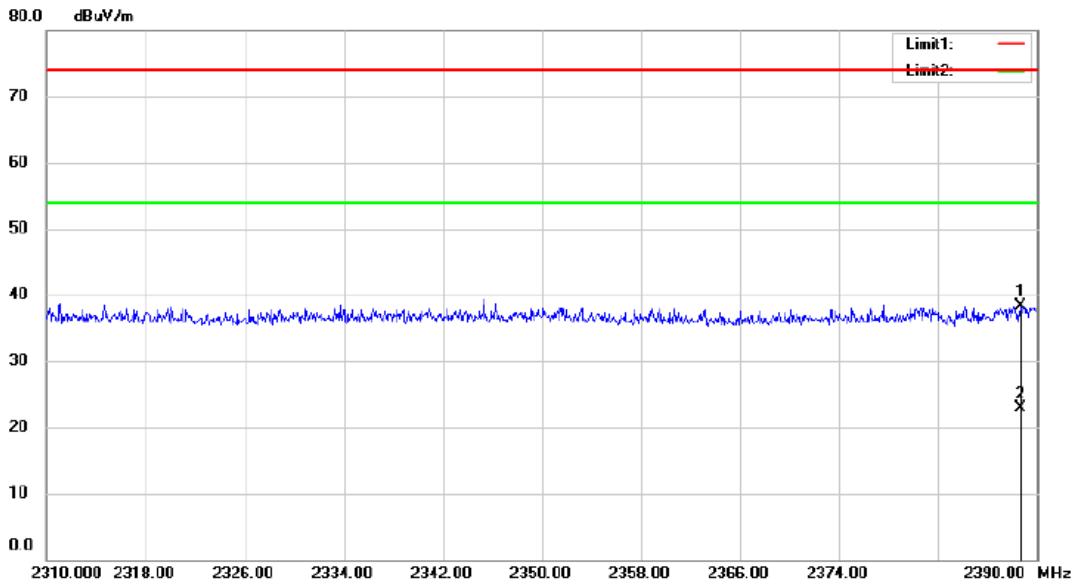

Site 3m Chamber #3 Polarization: *Horizontal* Temperature: 24 C

Mode: 11B 2412

Note:

No.	Mk.	Freq. MHz	Reading Level dBuV	Correct Factor dB	Measure- ment dBuV/m	Limit dBuV/m	Over dB	Detector	Antenna Height cm	Table Degree	Comment
1		2388.640	62.00	-23.73	38.27	74.00	-35.73	peak			
2	*	2388.640	46.59	-23.73	22.86	54.00	-31.14	AVG			

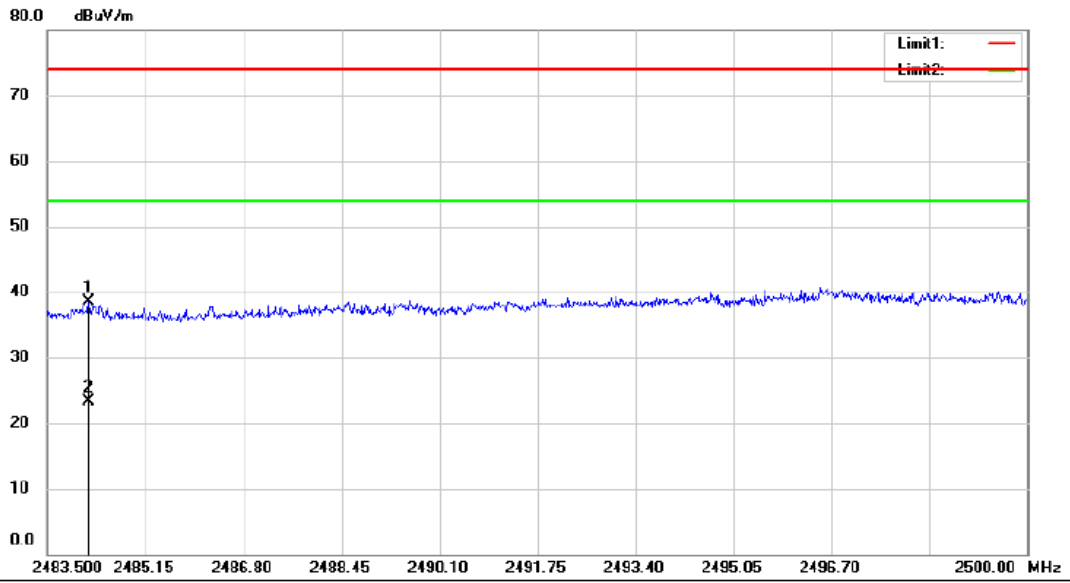

Mode: 11B 2462

Note:

No.	Mk.	Freq. MHz	Reading Level dBuV	Correct Factor dB	Measure- ment dBuV/m	Limit dBuV/m	Over dB	Detector	Antenna Height cm	Table Degree degree	Comment
1		2484.193	61.60	-23.18	38.42	74.00	-35.58	peak			
2	*	2484.193	46.39	-23.18	23.21	54.00	-30.79	AVG			

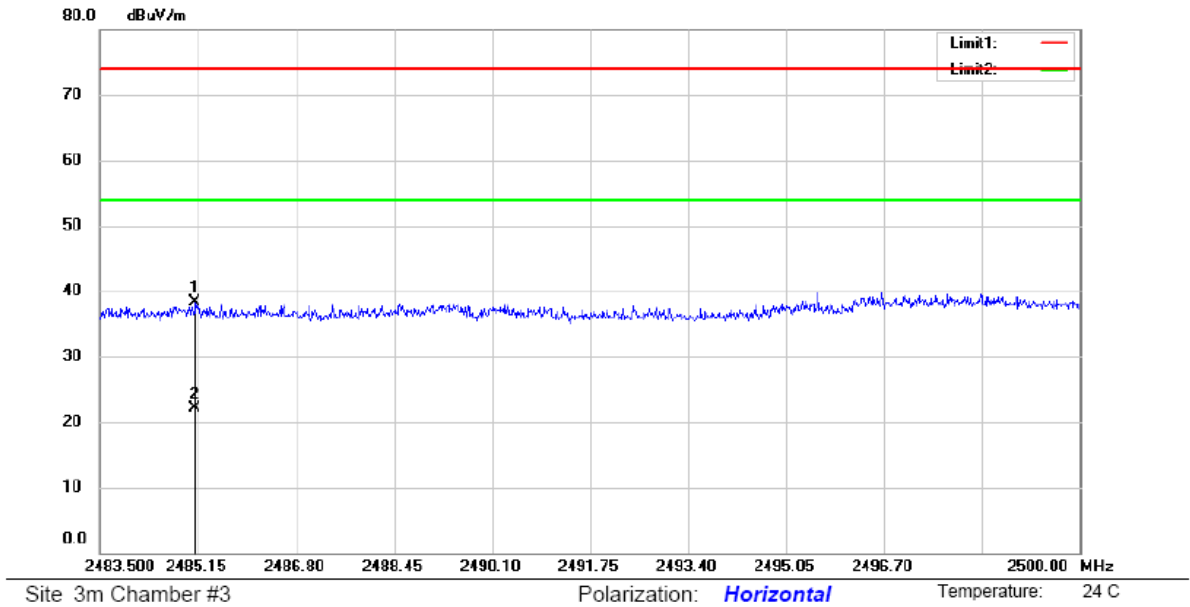

Mode: 11B 2462

Note:

No.	Mk.	Freq. MHz	Reading Level dBuV	Correct Factor dB	Measure- ment dBuV/m	Limit dBuV/m	Over dB	Detector	Antenna Height cm	Table Degree	Comment
1		2485.101	61.41	-23.18	38.23	74.00	-35.77	peak			
2	*	2485.101	45.34	-23.18	22.16	54.00	-31.84	AVG			

8.6 CONDUCTED EMISSION TEST

8.6.1 Applicable Standard

According to FCC Part 15.207(a)

8.6.2 Conformance Limit

Conducted Emission Limit		
Frequency(MHz)	Quasi-peak	Average
0.15-0.5	66-56	56-46
0.5-5.0	56	46
5.0-30.0	60	50

Note: 1. The lower limit shall apply at the transition frequencies
2. The limit decreases in line with the logarithm of the frequency in the range of 0.15 to 0.50MHz.

8.6.3 Test Configuration

Test according to clause 7.3 conducted emission test setup

8.6.4 Test Procedure

The EUT was placed on a table which is 0.8m above ground plane.
Maximum procedure was performed on the highest emissions to ensure EUT compliance.
Repeat above procedures until all frequency measured were complete.

8.6.5 Test Results

PASS.

Test Voltage	240V/50Hz
--------------	-----------

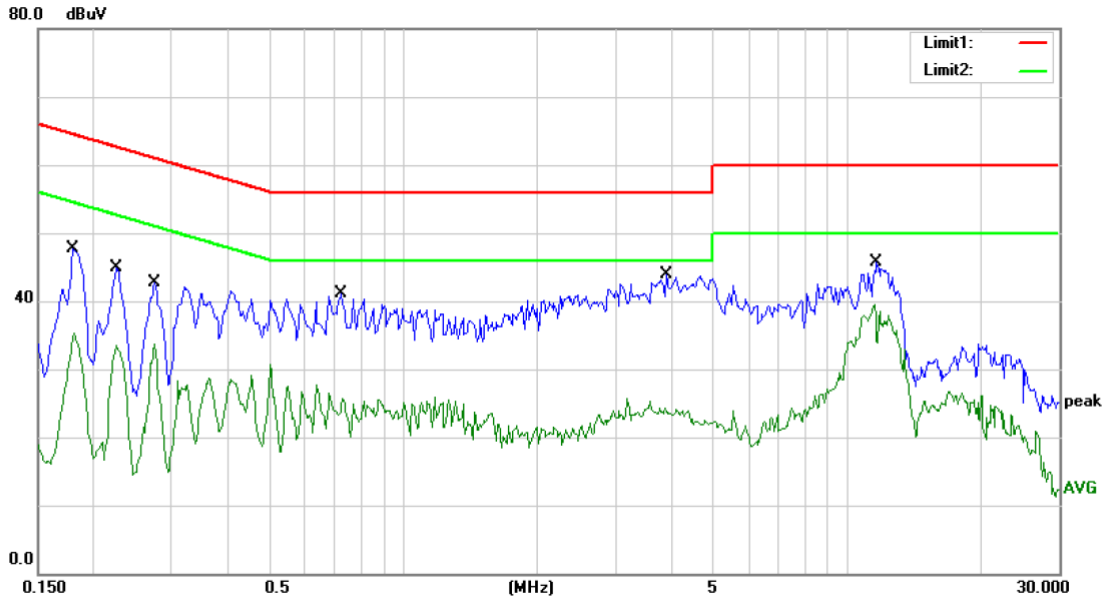

Site Conduction #1 Phase: **L1** Temperature: 24
 Limit: (CE)FCC PART 15 class B_QP Power: AC 240V/50Hz Humidity: 53 %
 Mode: ON
 Note:

No.	Mk.	Freq.	Reading Level	Correct Factor	Measurement	Limit	Over	Detector	Comment
		MHz	dBuV	dB	dBuV	dBuV	dB		
1		0.1800	47.63	0.00	47.63	64.49	-16.86	QP	
2		0.1800	35.26	0.00	35.26	54.49	-19.23	AVG	
3		0.2250	44.96	0.00	44.96	62.63	-17.67	QP	
4		0.2250	33.56	0.00	33.56	52.63	-19.07	AVG	
5		0.2750	42.78	0.00	42.78	60.97	-18.19	QP	
6		0.2750	33.67	0.00	33.67	50.97	-17.30	AVG	
7		0.7250	41.09	0.00	41.09	56.00	-14.91	QP	
8		0.7250	26.41	0.00	26.41	46.00	-19.59	AVG	
9		3.9100	43.89	0.00	43.89	56.00	-12.11	QP	
10		3.9100	25.65	0.00	25.65	46.00	-20.35	AVG	
11		11.6500	45.70	0.00	45.70	60.00	-14.30	QP	
12	*	11.6500	39.55	0.00	39.55	50.00	-10.45	AVG	

*:Maximum data x:Over limit !:over margin Comment: Factor build in receiver. Operator: XY

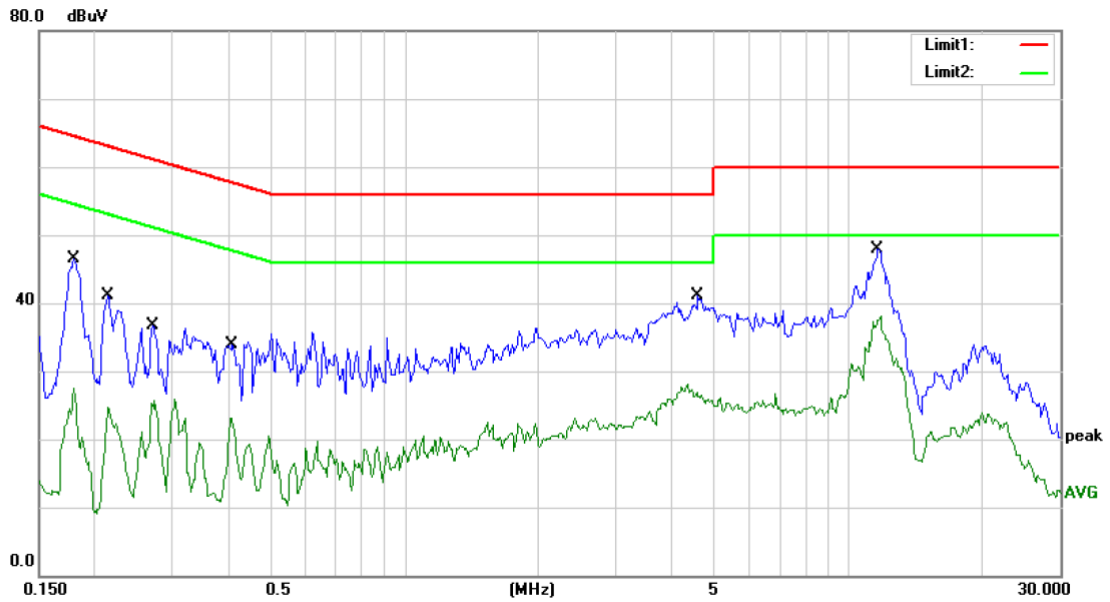

Site Conduction #1 Phase: **N** Temperature: 24
 Limit: (CE)FCC PART 15 class B_QP Power: AC 240V/50Hz Humidity: 53 %
 Mode: ON
 Note:

No. Mk.	Freq. MHz	Reading Level dBuV	Correct Factor dB	Measurement dBuV	Limit dBuV	Over dB	Detector	Comment
1	0.1800	46.43	0.00	46.43	64.49	-18.06	QP	
2	0.1800	27.45	0.00	27.45	54.49	-27.04	AVG	
3	0.2150	41.02	0.00	41.02	63.01	-21.99	QP	
4	0.2150	24.62	0.00	24.62	53.01	-28.39	AVG	
5	0.2701	36.65	0.00	36.65	61.11	-24.46	QP	
6	0.2701	25.70	0.00	25.70	51.11	-25.41	AVG	
7	0.4100	33.88	0.00	33.88	57.65	-23.77	QP	
8	0.4100	23.16	0.00	23.16	47.65	-24.49	AVG	
9	4.5950	41.07	0.00	41.07	56.00	-14.93	QP	
10	4.5950	28.20	0.00	28.20	46.00	-17.80	AVG	
11	11.6750	47.84	0.00	47.84	60.00	-12.16	QP	
12 *	11.6750	38.01	0.00	38.01	50.00	-11.99	AVG	

*:Maximum data x:Over limit !:over margin Comment: Factor build in receiver. Operator: XY

Test Voltage	120V/60Hz
--------------	-----------

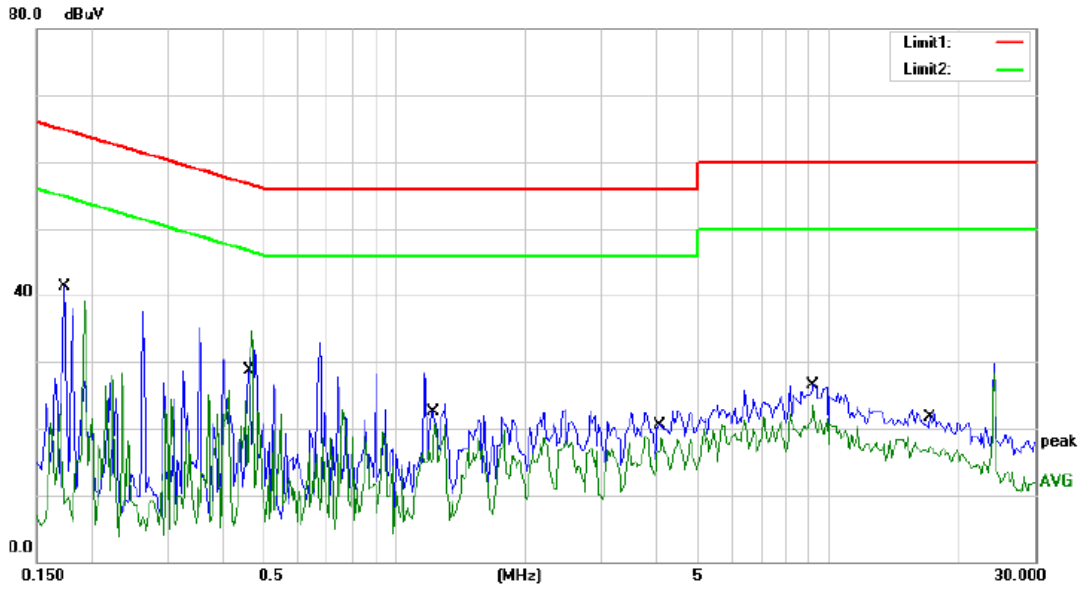

Site Conduction #1

Phase: **L1**

Temperature: 22

No.	Mk.	Freq.	Reading Level	Correct Factor	Measurement	Limit	Over	Detector	Comment
		MHz	dBuV	dB	dBuV	dBuV	dB		
1		0.1733	41.25	0.00	41.25	64.80	-23.55	QP	
2		0.1733	39.07	0.00	39.07	54.80	-15.73	AVG	
3		0.4702	31.66	0.00	31.66	56.51	-24.85	QP	
4	*	0.4702	34.64	0.00	34.64	46.51	-11.87	AVG	
5		1.2398	23.64	0.00	23.64	56.00	-32.36	QP	
6		1.2398	20.73	0.00	20.73	46.00	-25.27	AVG	
7		4.1344	22.69	0.00	22.69	56.00	-33.31	QP	
8		4.1344	18.45	0.00	18.45	46.00	-27.55	AVG	
9		9.2110	26.52	0.00	26.52	60.00	-33.48	QP	
10		9.2110	23.42	0.00	23.42	50.00	-26.58	AVG	
11		17.1523	22.29	0.00	22.29	60.00	-37.71	QP	
12		17.1523	17.31	0.00	17.31	50.00	-32.69	AVG	

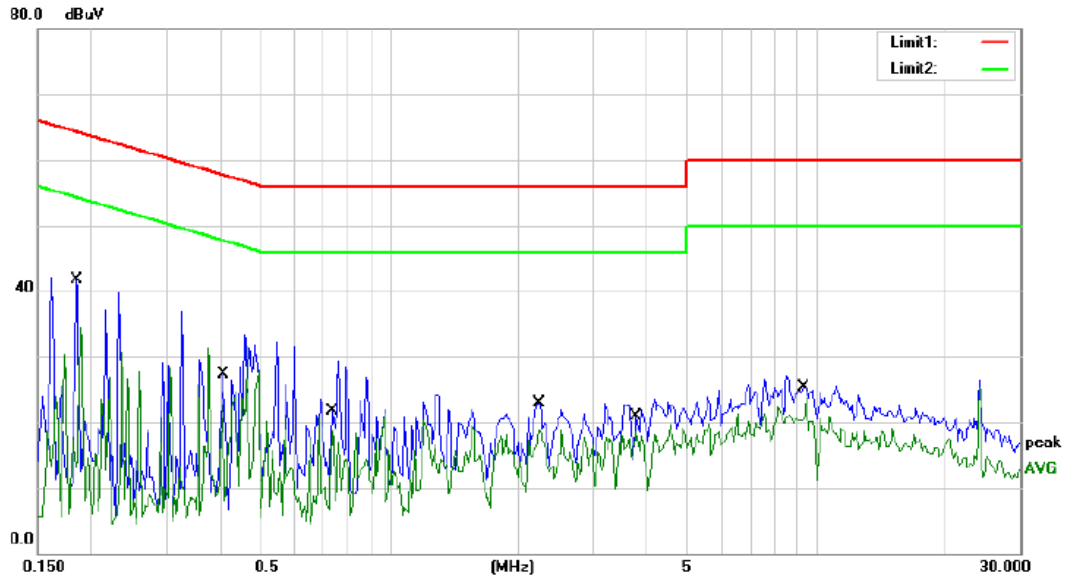

Site Conduction #1 Phase: **N** Temperature: 22

No. Mk.	Freq. MHz	Reading Level dBuV	Correct Factor dB	Measure- ment dBuV	Limit dBuV	Over dB	Detector	Comment
1	0.1852	41.79	0.00	41.79	64.25	-22.46	QP	
2 *	0.1852	34.51	0.00	34.51	54.25	-19.74	AVG	
3	0.4077	27.25	0.00	27.25	57.70	-30.45	QP	
4	0.4077	24.77	0.00	24.77	47.70	-22.93	AVG	
5	0.7320	26.82	0.00	26.82	56.00	-29.18	QP	
6	0.7320	18.72	0.00	18.72	46.00	-27.28	AVG	
7	2.2477	22.90	0.00	22.90	56.00	-33.10	QP	
8	2.2477	18.81	0.00	18.81	46.00	-27.19	AVG	
9	3.7827	23.58	0.00	23.58	56.00	-32.42	QP	
10	3.7827	18.59	0.00	18.59	46.00	-27.41	AVG	
11	9.3360	25.25	0.00	25.25	60.00	-34.75	QP	
12	9.3360	23.75	0.00	23.75	50.00	-26.25	AVG	

8.7 ANTENNA APPLICATION

8.7.1 Antenna Requirement

For intentional device, according to FCC 47 CFR Section 15.203, an intentional radiator shall be designed to ensure that no antenna other than that furnished by the responsible party shall be used with the device. And according to FCC 47 CFR Section 15.247 (b), if transmitting antennas of directional gain greater than 6dBi are used, the power shall be reduced by the amount in dB that the directional gain of the antenna exceeds 6dBi.

For intentional device, according to IC RSS-Gen 8.3, testing shall be performed using the highest gain antenna of each combination of licence-exempt transmitter and antenna type, with the transmitter output power set at the maximum level.9 When a measurement at the antenna connector is used to determine RF output power, the effective gain of the device's antenna shall be stated, based on a measurement or on data from the antenna manufacturer.

8.7.2 Result

The EUT'S antenna is Fixed External, and the antenna can't be replaced by the user, which in accordance to section 15.203, please refer to the internal photos. The antenna's gain is 1dBi and meets the requirement.

END OF REPORT