

FCC RADIO TEST REPORT

FCC ID:2ACPR-DTLAPY133-1

Product : notebook

Trade Mark : N/A

Model Name : DTLAPY133-1

Serial Model : W1637, W1731, W1737, W1735,
W1739, W1740, W1840, W1741,
W1745, W1850, W1749

Report No. : NTEK-2017NT08075530F4

Prepared for

SHENZHEN BMORN TECHNOLOGY CO.,LTD.
5/F, Hengfang Verteran Industrial Park, Xingye Road, Xixiang,
Bao'an, Shenzhen, Guangdong, China

Prepared by

Shenzhen NTEK Testing Technology Co., Ltd.
1/F, Building E, Fenda Science Park, Sanwei Community,
Xixiang Street Bao'an District, Shenzhen 518126 P.R. China
Tel.: +86-755-6115 9388
Fax.: +86-755-6115 6599
Website:<http://www.ntek.org.cn>

TEST RESULT CERTIFICATION

Applicant's name : SHENZHEN BMORN TECHNOLOGY CO.,LTD.
Address : 5/F, Hengfang Verteran Industrial Park, Xingye Road, Xixiang, Bao'an, Shenzhen, Guangdong, China
Manufacturer's Name : SHENZHEN BMORN TECHNOLOGY CO.,LTD.
Address : 5/F, Hengfang Verteran Industrial Park, Xingye Road, Xixiang, Bao'an, Shenzhen, Guangdong, China

Product description

Product name..... : notebook
Model and/or type reference : DTLAPY133-1
Serial Model : W1637, W1731, W1737, W1735, W1739, W1740, W1840, W1741, W1745, W1850, W1749

Standards : FCC Part15.407

Test procedure ANSI C63.10-2013 and KDB 789033 D02 General UNII Test Procedures New Rules v01r01
 FCC KDB 662911 D01 Multiple Transmitter Output v02r01
 FCC KDB 662911 D02 MIMO With Cross Polarized Antenna V01

This device described above has been tested by NTEK, and the test results show that the equipment under test (EUT) is in compliance with the FCC requirements/ the Industry Canada requirements.. And it is applicable only to the tested sample identified in the report.

This report shall not be reproduced except in full, without the written approval of NTEK, this document may be altered or revised by NTEK, personnel only, and shall be noted in the revision of the document.

Date of Test

Date (s) of performance of tests 07 Aug. 2017 ~ 23 Aug. 2017

Date of Issue..... 23 Aug. 2017

Test Result..... **Pass**

Testing Engineer : Eileen Liu.
 (Eileen Liu)

Technical Manager : Jason Chen
 (Jason Chen)

Authorized Signatory : Sam. Chen
 (Sam Chen)

Table of Contents

	Page
1 . SUMMARY OF TEST RESULTS	6
1.1 FACILITIES AND ACCREDITATIONS	7
1.2 MEASUREMENT UNCERTAINTY	7
2 . GENERAL INFORMATION	8
2.1 GENERAL DESCRIPTION OF EUT	8
2.2 DESCRIPTION OF TEST MODES	10
2.3 BLOCK DIGRAM SHOWING THE CONFIGURATION OF SYSTEM TESTED	11
2.4 DESCRIPTION OF SUPPORT UNITS(CONDUCTED MODE)	12
2.5 EQUIPMENTS LIST FOR ALL TEST ITEMS	13
3 . EMC EMISSION TEST	15
3.1 CONDUCTED EMISSION MEASUREMENT	15
3.1.1 POWER LINE CONDUCTED EMISSION LIMITS	15
3.1.2 TEST PROCEDURE	16
3.1.3 DEVIATION FROM TEST STANDARD	16
3.1.4 TEST SETUP	16
3.1.5 EUT OPERATING CONDITIONS	16
3.2 RADIATED EMISSION MEASUREMENT	21
3.2.1 APPLICABLE STANDARD	21
3.2.2 CONFORMANCE LIMIT	21
3.2.3 MEASURING INSTRUMENTS	21
3.2.4 TEST CONFIGURATION	22
3.2.5 TEST PROCEDURE	23
3.2.6 TEST RESULTS (9KHZ – 30 MHZ)	24
3.2.7 TEST RESULTS (30MHZ – 1GHZ)	25
3.2.8 TEST RESULTS (1GHZ-26GHZ)	29
3.2.9 TEST RESULTS (26GHZ-40GHZ)	31
4 . POWER SPECTRAL DENSITY TEST	35
4.1 APPLIED PROCEDURES / LIMIT	35
4.2 TEST PROCEDURE	36
4.3 DEVIATION FROM STANDARD	36
4.4 TEST SETUP	36
4.5 EUT OPERATION CONDITIONS	36
4.6 TEST RESULTS	37
5 . 26DB & 99% EMISSION BANDWIDTH	45
5.1 APPLIED PROCEDURES / LIMIT	45
5.2 TEST PROCEDURE	45
5.3 EUT OPERATION CONDITIONS	46
5.4 TEST RESULTS	47

Table of Contents

	Page
6 . MINIMUM 6 DB BANDWIDTH	55
6.1 APPLIED PROCEDURES / LIMIT	55
6.2 TEST PROCEDURE	55
6.3 DEVIATION FROM STANDARD	55
6.4 TEST SETUP	55
6.5 EUT OPERATION CONDITIONS	55
6.6 TEST RESULTS	56
7 . MAXIMUM CONDUCTED OUTPUT POWER	64
7.1 PPLIED PROCEDURES / LIMIT	64
7.2 TEST PROCEDURE	64
7.3 DEVIATION FROM STANDARD	66
7.4 TEST SETUP	66
7.5 EUT OPERATION CONDITIONS	66
7.6 TEST RESULTS	67
8 . OUT OF BAND EMISSIONS	69
8.1 APPLICABLE STANDARD	69
8.2 TEST PROCEDURE	69
8.3 DEVIATION FROM STANDARD	69
8.4 TEST SETUP	69
8.5 EUT OPERATION CONDITIONS	69
8.6 TEST RESULTS	70
9.SPURIOUS RF CONDUCTED EMISSIONS	77
9.1CONFORMANCE LIMIT	77
9.2MEASURING INSTRUMENTS	77
9.3TEST SETUP	77
9.4TEST PROCEDURE	77
9.5TEST RESULTS	77
10. FREQUENCY STABILITY MEASUREMENT	92
10.1 LIMIT	92
10.2 TEST PROCEDURES	92
10.3 TEST SETUP LAYOUT	92
10.4 EUT OPERATION DURING TEST	92
10.5 TEST RESULTS	93
11. ANTENNA REQUIREMENT	99
11.1 STANDARD REQUIREMENT	99
11.2 EUT ANTENNA	99



Revision History

Report No.	Version	Description	Issued Date
NTEK-2017NT08075530F4	Rev.01	Initial issue of report	Aug 22, 2017

1. SUMMARY OF TEST RESULTS

Test procedures according to the technical standards:

FCC Part15 (15.407) , Subpart E			
Standard Section	Test Item	Judgment	Remark
15.207	AC Power Line Conducted Emissions	PASS	
15.209(a), 15.407 (b)(1) 15.407 (b)(4) 15.407 (b)(6)	Spurious Radiated Emissions	PASS	(Outsourcing)
15.407 (a)(1) 15.407 (a)(3) 15.1049	26 dB and 99% Emission Bandwidth	PASS	
15.407(e)	Minimum 6 dB bandwidth	PASS	
15.407 (a)(1) 15.407 (a)(3)	Maximum Conducted Output Power	PASS	
2.1051, 15.407(b)(1) 15.407(b)(4)	Band Edge	PASS	
15.407 (a)(1) 15.407 (a)(3)	Power Spectral Density	PASS	
2.1051, 15.407(b)	Spurious Emissions at Antenna Terminals	PASS	
15.203	Antenna Requirement	PASS	

NOTE:

(1) "N/A" denotes test is not applicable in this Test Report

Outsourcing: The 26G-40G Spurious Radiated Emissions in this test were outsourced to the Shenzhen Academy of Metrology & Quality Inspection

1.1 FACILITIES AND ACCREDITATIONS

FACILITIES

All measurement facilities used to collect the measurement data are located at 1/F, Building E, Fenda Science Park, Sanwei Community, Xixiang Street, Bao'an District, Shenzhen 518126 P.R. China.

The sites are constructed in conformance with the requirements of ANSI C63.7, ANSI C63.10 and CISPR Publication 22.

LABORATORY ACCREDITATIONS AND LISTINGS

Site Description

CNAS-Lab. : The Laboratory has been assessed and proved to be in compliance with CNAS-CL01:2006 (identical to ISO/IEC 17025:2005)
 The Certificate Registration Number is L5516.

IC-Registration The Certificate Registration Number is 9270A-1.

FCC- Accredited Test Firm Registration Number: 463705.
 Designation Number: CN1184

A2LA-Lab. The Certificate Registration Number is 4298.01
 This laboratory is accredited in accordance with the recognized International Standard ISO/IEC 17025:2005 General requirements for the competence of testing and calibration laboratories.
 This accreditation demonstrates technical competence for a defined scope and the operation of a laboratory quality management system (refer to joint ISO-ILAC-IAF Communiqué dated 8 January 2009).

Name of Firm : Shenzhen NTEK Testing Technology Co., Ltd.

Site Location : 1/F, Building E, Fenda Science Park, Sanwei Community, Xixiang Street, Bao'an District, Shenzhen 518126 P.R. China.

1.2 MEASUREMENT UNCERTAINTY

The reported uncertainty of measurement $y \pm U$, where expanded uncertainty U is based on a standard uncertainty multiplied by a coverage factor of $k=2$, providing a level of confidence of approximately 95 %.

No.	Item	Uncertainty
1	Conducted Emission Test	$\pm 2.80\text{dB}$
2	RF power, conducted	$\pm 0.16\text{dB}$
3	Spurious emissions, conducted	$\pm 0.21\text{dB}$
4	All emissions, radiated(30MHz~1GHz)	$\pm 2.64\text{dB}$
5	All emissions, radiated(1GHz~6GHz)	$\pm 2.40\text{dB}$
6	All emissions, radiated(> 6GHz)	$\pm 2.52\text{dB}$
7	Temperature	$\pm 0.5\text{C}$
8	Humidity	$\pm 2\%$

2. GENERAL INFORMATION

2.1 GENERAL DESCRIPTION OF EUT

Equipment	notebook		
Trade Mark	N/A		
Model Name	DTLAPY133-1		
FCC ID	2ACPR-DTLAPY133-1		
Product Description	IEEE 802.11 WLAN Mode Supported	<input checked="" type="checkbox"/> 802.11a/n/ac(20MHz channel bandwidth) <input checked="" type="checkbox"/> 802.11n/ac(40MHz channel bandwidth) <input checked="" type="checkbox"/> 802.11ac(80MHz channel bandwidth)	
	Data Rate	802.11a: 6,9,12,18,24,36,48,54Mbps; 802.11n(HT20/HT40):MCS0-MCS15; 802.11ac(VHT20): NSS1, MCS0-MCS8 802.11ac(VHT40/VHT80):NSS1, MCS0-MCS9	
	Modulation	OFDM with BPSK/DQPSK/16QAM/64QAM/256QAM for 802.11a/n/ac;	
	Operating Frequency Range	<input checked="" type="checkbox"/> 5180-5240MHz for 802.11a/n(HT20)/ac20; 5190-5230MHz for 802.11n(HT40)/ac40; 5210MHz for 802.11 ac80; <input checked="" type="checkbox"/> 5745-5825 MHz for 802.11a/n(HT20)/ac20; 5755-5795 MHz for 802.11a/n(HT40)/ac40; 5775MHz for 802.11 ac80;	
	Number of Channels	<input checked="" type="checkbox"/> 4 channels for 802.11a/n20/ac20 in the 5180-5240MHz band ; 2 channels for 802.11 n40/ac40 in the 5190-5230MHz band ; 1 channels for 802.11 ac80 in the 5210MHz band ; <input checked="" type="checkbox"/> 5 channels for 802.11a/n20/ac20 in the 5745-5825MHz band ; 2 channels for 802.11 n40/ac40 in the 5755-5795MHz band ; 1 channels for 802.11 ac80 in the 5775MHz band ;	
	Antenna Type	Antenna A/B:FPCB Antenna	
	Antenna Gain	Antenna A/B:2dBi	
	Based on the application, features, or specification exhibited in User's Manual, More details of EUT technical specification, please refer to the User's Manual.		
	Ratings	DC 7.4V from battery or DC 12V from Adapter	
	Adapter	Model: SAW30-120-2000U Input: AC 100~240V 50~60Hz 0.8A Output:12V, 2000mA	
Battery	DC 7.4V, 5000MAh		
Connecting I/O Port(s)	Please refer to the User's Manual		

Note:

- For a more detailed features description, please refer to the manufacturer's specifications or the User's Manual.
- Frequency and Channel list for 802.11a/n(20MHz) band I (5180-5240MHz):

802.11a/n/ac(20MHz) Carrier Frequency Channel							
Channel	Frequency (MHz)	Channel	Frequency (MHz)	Channel	Frequency (MHz)	Channel	Frequency (MHz)
36	5180	44	5220	-	-	-	-
40	5200	48	5240	-	-	-	-

Frequency and Channel list for 802.11n(40MHz) band I (5190-5230MHz):

802.11n /ac(40MHz) Carrier Frequency Channel							
Channel	Frequency (MHz)	Channel	Frequency (MHz)	Channel	Frequency (MHz)	Channel	Frequency (MHz)
38	5190	-	-	-	-	-	-
46	5230	-	-	-	-	-	-

802.11ac (80MHz) Carrier Frequency Channel	
Channel	Frequency (MHz)
42	5210

Frequency and Channel list for 802.11a/n(20 MHz) band IV (5745-5825MHz):

802.11a/n/ac(20 MHz) Carrier Frequency Channel							
Channel	Frequency (MHz)	Channel	Frequency (MHz)	Channel	Frequency (MHz)	Channel	Frequency (MHz)
149	5745	153	5765	157	5785	161	5805
165	5825	-	-	-	-	-	-

Frequency and Channel list for 802.11n(40MHz) band IV (5755-5795MHz):

802.11n/ac 40MHz Carrier Frequency Channel					
Channel	Frequency (MHz)	Channel	Frequency (MHz)	Channel	Frequency (MHz)
151	5755	159	5795	-	-

802.11ac 80MHz Carrier Frequency Channel	
Channel	Frequency (MHz)
155	5775

The EUT has two types of antenna. The wireless module is 1x1 Wi-Fi support 802.11b / g / n / ac; does not support MIMO

Tx Antenna

Antenna	Antenna Type	Antenna Gain(dBi)
		5.0G
A(main)	FPCB	2
B(aux)	FPCB	2

2.2 DESCRIPTION OF TEST MODES

To investigate the maximum EMI emission characteristics generates from EUT, the test system was pre-scanning tested base on the consideration of following EUT operation mode or test configuration mode which possible have effect on EMI emission level. Each of these EUT operation mode(s) or test configuration mode(s) mentioned above was evaluated respectively.

Pretest Mode	Description
Mode 1	Normal Link Mode
Mode 2	802.11a / n/ ac 20 CH36/ CH40/ CH 48 802.11a /n/ ac 20 CH149/ CH157/ CH 165
Mode 3	802.11n/ ac40 CH38/ CH 46 802.11n/ ac40 CH 151 / CH 159
Mode 4	802.11 ac80 CH 155

For Radiated Emission	
Final Test Mode	Description
Mode 1	Normal Link Mode
Mode 2	802.11a / n/ ac 20 CH36/ CH40/ CH 48 802.11a /n/ ac 20 CH149/ CH157/ CH 165
Mode 3	802.11n/ ac40 CH38/ CH 46 802.11n/ ac40 CH 151 / CH 159
Mode 4	802.11 ac80 CH 155

Note:

- (1) The measurements are performed at the highest, middle, lowest available channels.
- (2) The measurements are performed at all Bit Rate of Transmitter, the worst data was reported

2.3 BLOCK DIGRAM SHOWING THE CONFIGURATION OF SYSTEM TESTED

For AC Conducted Emission Mode

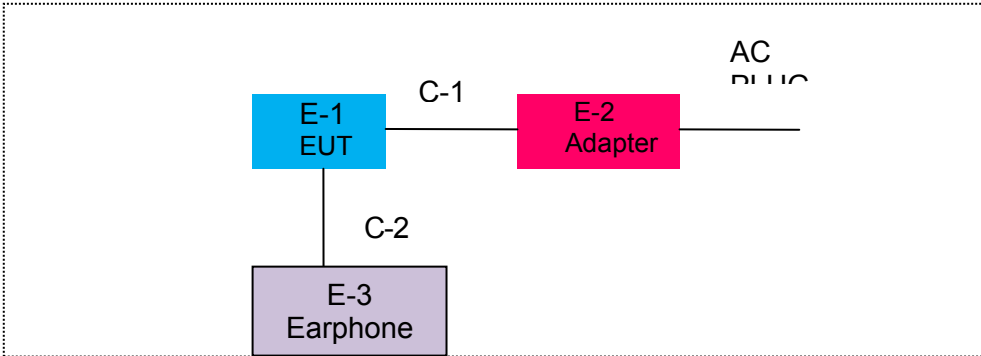

Radiated Spurious Emission Test

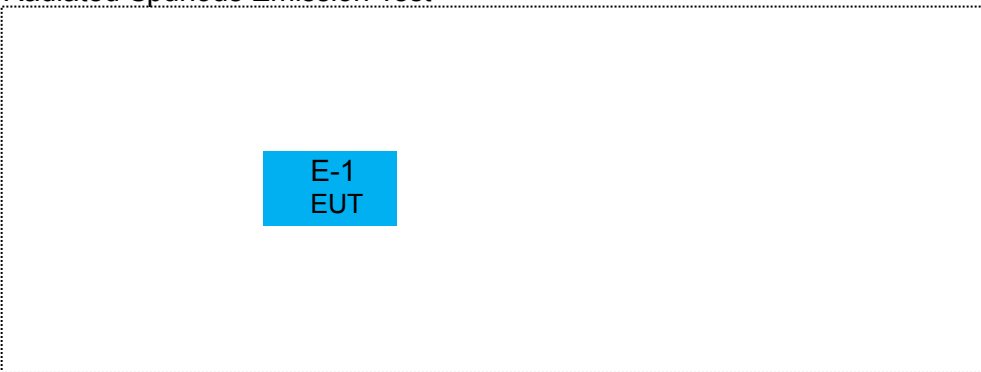

For Conducted Test Cases

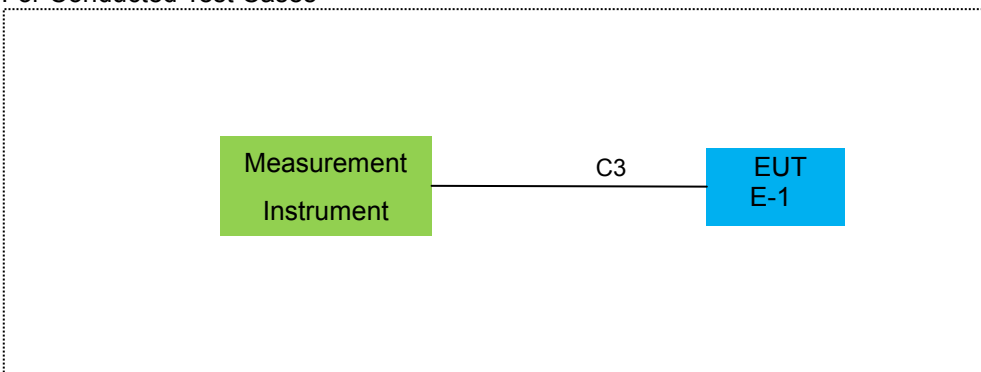

2.4 DESCRIPTION OF SUPPORT UNITS(CONDUCTED MODE)

The EUT has been tested as an independent unit together with other necessary accessories or support units. The following support units or accessories were used to form a representative test configuration during the tests.

Item	Equipment	Brand	Model/Type No.	Series No.	Note
E-1	notebook	N/A	DTLAPY133-1	2ACPR-DTLAPY133-1	EUT
E-2	Adapter	N/A	SAW30-120-2000U	N/A	
E-3	Earphone	N/A	2688	N/A	Peripherals

Item	Cable Type	Shielded Type	Ferrite Core	Length	Note
C-1	Power Cable	NO	NO	1.2m	
C-2	Earphone Cable	NO	NO	1.0m	
C-3	RF Cable	NO	NO	0.5m	

Note:

- (1) The support equipment was authorized by Declaration of Confirmation.
- (2) For detachable type I/O cable should be specified the length in cm in 『Length』 column.

2.5 EQUIPMENTS LIST FOR ALL TEST ITEMS

Radiation Test equipment

Item	Kind of Equipment	Manufacturer	Type No.	Serial No.	Last calibration	Calibrated until	Calibration period
1	Spectrum Analyzer	Agilent	E4407B	MY45108040	2017.06.06	2018.06.05	1 year
2	Spectrum Analyzer	Agilent	N9020A	MY49100060	2016.11.10	2017.11.09	1 year
3	EMI Test Receiver	Agilent	N9038A	MY53227146	2017.06.06	2018.06.05	1 year
4	Test Receiver	R&S	ESPI	101318	2017.06.06	2018.06.05	1 year
5	Bilog Antenna	TESEQ	CBL6111D	31216	2017.04.09	2018.04.08	1 year
6	50Ω Coaxial Switch	Anritsu	MP59B	6200983705	2017.06.06	2018.06.05	1 year
7	Horn Antenna	EM	EM-AH-10180	2011071402	2017.04.09	2018.04.08	1 year
8	Horn Ant	Schwarzbeck	BBHA 9170	9170-181	2017.07.06	2018.07.05	1 year
9	Amplifier	EMC	EMC051835SE	980246	2017.08.09	2018.08.08	1 year
10	Amplifier	MITEQ	TTA1840-35-HG	177156	2017.06.06	2018.06.05	1 year
11	Loop Antenna	ARA	PLA-1030/B	1029	2017.06.06	2018.06.05	1 year
12	Power Meter	DARE	RPR3006W	15100041SN084	2017.08.09	2018.08.08	1 year
13	Test Cable (9KHz-30MHz)	N/A	R-01	N/A	2017.04.21	2020.04.20	3 year
14	Test Cable (30MHz-1GHz)	N/A	R-02	N/A	2017.04.21	2020.04.20	3 year
15	High Test Cable(1G-40G Hz)	N/A	R-03	N/A	2017.04.21	2020.04.20	3 year
16	High Test Cable(1G-40G Hz)	N/A	R-04	N/A	2017.04.21	2020.04.20	3 year
17	temporary antenna connector (Note)	NTS	R001	N/A	N/A	N/A	N/A

Note:

We will use the temporary antenna connector (soldered on the PCB board) When conducted test And this temporary antenna connector is listed within the instrument list

Conduction Test equipment

Item	Kind of Equipment	Manufacturer	Type No.	Serial No.	Last calibration	Calibrated until	Calibration period
1	Test Receiver	R&S	ESCI	101160	2017.06.06	2018.06.05	1 year
2	LISN	R&S	ENV216	101313	2017.04.19	2018.04.18	1 year
3	LISN	SCHWARZBECK	NNLK 8129	8129245	2017.06.06	2018.06.05	1 year
4	50Ω Coaxial Switch	ANRITSU CORP	MP59B	6200983704	2017.06.06	2018.06.05	1 year
5	Test Cable (9KHz-30MHz)	N/A	C01	N/A	2017.04.21	2020.04.20	3 year
6	Test Cable (9KHz-30MHz)	N/A	C02	N/A	2017.04.21	2020.04.20	3 year
7	Test Cable (9KHz-30MHz)	N/A	C03	N/A	2017.04.21	2020.04.20	3 year

1	Filter	TRILTHIC	2400MHz	29	2017.04.19	2018.04.18	1 year
---	--------	----------	---------	----	------------	------------	--------

Note: Each piece of equipment is scheduled for calibration once a year.

3. EMC EMISSION TEST

3.1 CONDUCTED EMISSION MEASUREMENT

3.1.1 POWER LINE CONDUCTED EMISSION Limits (Frequency Range 150KHz-30MHz)

FREQUENCY (MHz)	Class B (dBuV)		Standard
	Quasi-peak	Average	
0.15 -0.5	66 - 56 *	56 - 46 *	CISPR
0.50 -5.0	56.00	46.00	CISPR
5.0 -30.0	60.00	50.00	CISPR

0.15 -0.5	66 - 56 *	56 - 46 *	FCC/ RSS-247
0.50 -5.0	56.00	46.00	FCC/ RSS-247
5.0 -30.0	60.00	50.00	FCC/ RSS-247

Note:

- (1) The tighter limit applies at the band edges.
- (2) The limit of " * " marked band means the limitation decreases linearly with the logarithm of the frequency in the range.

The following table is the setting of the receiver

Receiver Parameters	Setting
Attenuation	10 dB
Start Frequency	0.15 MHz
Stop Frequency	30 MHz
IF Bandwidth	9 kHz

3.1.2 TEST PROCEDURE

- a. The EUT was placed 0.8 meters from the horizontal ground plane with EUT being connected to the power mains through a line impedance stabilization network (LISN). All other support equipments powered from additional LISN(s). The LISN provide 50 Ohm/ 50uH of coupling impedance for the measuring instrument.
- b. Interconnecting cables that hang closer than 40 cm to the ground plane shall be folded back and forth in the center forming a bundle 30 to 40 cm long.
- c. I/O cables that are not connected to a peripheral shall be bundled in the center. The end of the cable may be terminated, if required, using the correct terminating impedance. The overall length shall not exceed 1 m.
- d. LISN at least 80 cm from nearest part of EUT chassis.
- e. For the actual test configuration, please refer to the related Item –EUT Test Photos.

3.1.3 DEVIATION FROM TEST STANDARD

No deviation

3.1.4 TEST SETUP

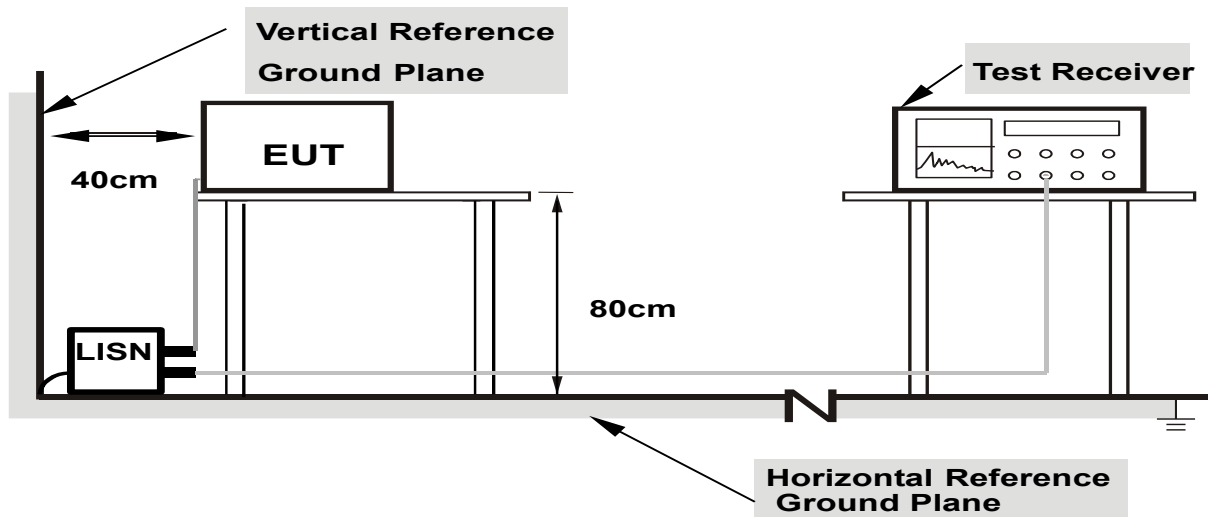

- Note: 1.Support units were connected to second LISN.**
2.Both of LISNs (AMN) are 80 cm from EUT and at least 80 from other units and other metal planes

3.1.5 EUT OPERATING CONDITIONS

The EUT was configured for testing in a typical fashion (as a customer would normally use it). The EUT has been programmed to continuously transmit during test. This operating condition was tested and used to collect the included data.

EUT :	notebook	Model Name. :	DTLAPY133-1
Temperature :	26 °C	Relative Humidity :	56%
Pressure :	1010hPa	Phase :	L
Test Voltage :	DC 12V from Adapter AC 120V/60Hz	Test Mode :	Mode 1

Frequency (MHz)	Reading Level (dBμV)	Correct Factor (dB)	Measurement (dBμV)	Limits (dBμV)	Margin (dB)	Remark
0.1700	47.54	9.82	57.36	64.96	-7.60	QP
0.1700	13.64	9.82	23.46	54.96	-31.50	AVG
0.1900	47.09	9.82	56.91	64.03	-7.12	QP
0.1900	25.95	9.82	35.77	54.03	-18.26	AVG
0.2779	46.11	9.82	55.93	60.88	-4.95	QP
0.2779	25.77	9.82	35.59	50.88	-15.29	AVG
0.3660	40.40	9.83	50.23	58.59	-8.36	QP
0.3660	21.17	9.83	31.00	48.59	-17.59	AVG
0.6300	36.42	9.83	46.25	56.00	-9.75	QP
0.6300	19.27	9.83	29.10	46.00	-16.90	AVG
1.8060	35.81	9.86	45.67	56.00	-10.33	QP
1.8060	22.24	9.86	32.10	46.00	-13.90	AVG

Remark:

- All readings are Quasi-Peak and Average values.
- Factor = Insertion Loss + Cable Loss.

100.0 dBμV

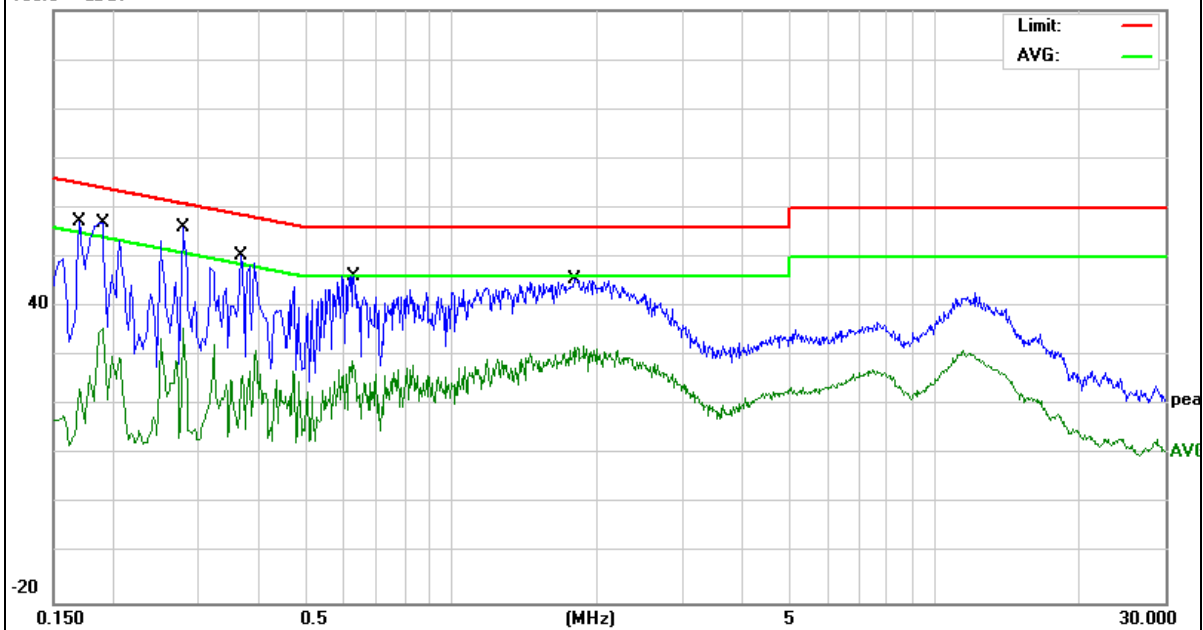

EUT :	notebook	Model Name. :	DTLAPY133-1
Temperature :	26 °C	Relative Humidity :	56%
Pressure :	1010hPa	Phase :	N
Test Voltage :	DC 12V from Adapter AC 120V/60Hz	Test Mode :	Mode 1

Frequency (MHz)	Reading Level (dB μ V)	Correct Factor (dB)	Measure-ment (dB μ V)	Limits (dB μ V)	Margin (dB)	Remark
0.1580	48.80	9.92	58.72	65.56	-6.84	QP
0.1580	14.68	9.92	24.60	55.56	-30.96	AVG
0.1940	48.33	9.92	58.25	63.86	-5.61	QP
0.1940	26.00	9.92	35.92	53.86	-17.94	AVG
0.2620	46.55	9.92	56.47	61.36	-4.89	QP
0.2620	28.41	9.92	38.33	51.36	-13.03	AVG
0.3140	41.56	9.92	51.48	59.86	-8.38	QP
0.3140	21.68	9.92	31.60	49.86	-18.26	AVG
0.4060	41.57	9.93	51.50	57.73	-6.23	QP
0.4060	20.06	9.93	29.99	47.73	-17.74	AVG
0.5899	39.39	9.93	49.32	56.00	-6.68	QP
0.5899	20.09	9.93	30.02	46.00	-15.98	AVG

Remark:

1. All readings are Quasi-Peak and Average values.
2. Factor = Insertion Loss + Cable Loss.

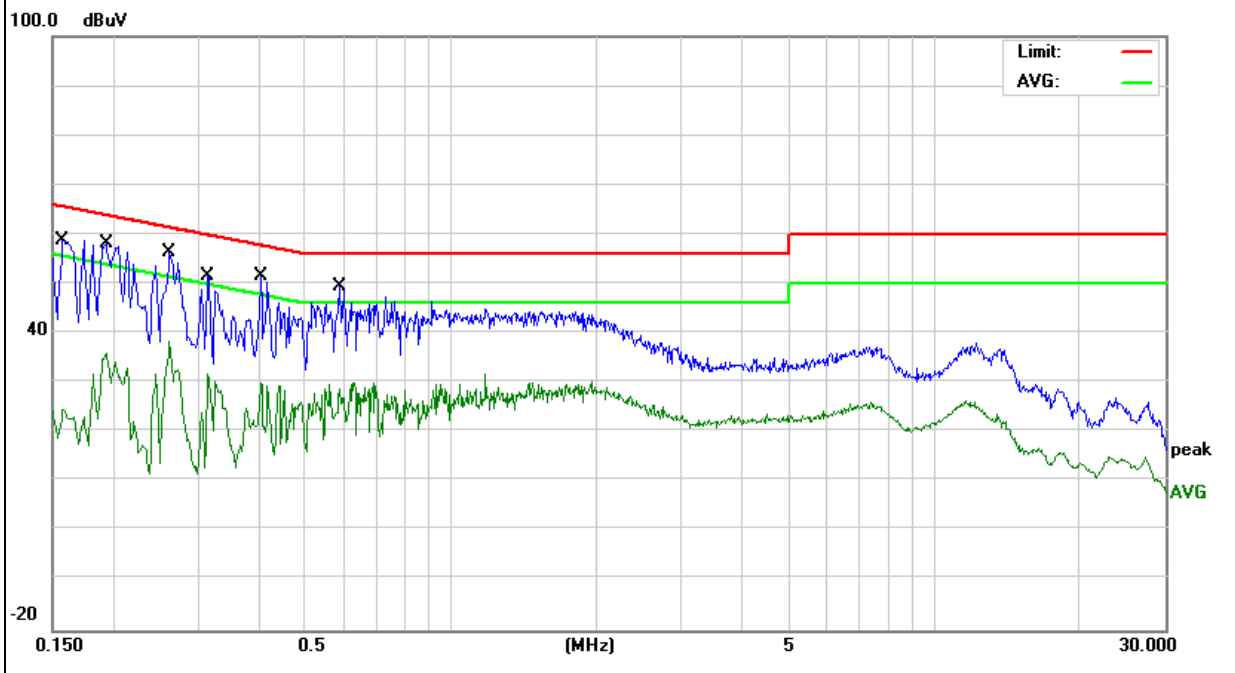

EUT :	notebook	Model Name. :	DTLAPY133-1
Temperature :	26 °C	Relative Humidity :	56%
Pressure :	1010hPa	Phase :	L
Test Voltage :	DC 12V from Adapter AC 240V/60Hz	Test Mode :	Mode 1

Frequency (MHz)	Reading Level (dBμV)	Correct Factor (dB)	Measure-ment (dBμV)	Limits (dBμV)	Margin (dB)	Remark
0.1860	47.76	9.82	57.58	64.21	-6.63	QP
0.1860	28.95	9.82	38.77	54.21	-15.44	AVG
0.3700	37.82	9.83	47.65	58.50	-10.85	QP
0.3700	23.55	9.83	33.38	48.50	-15.12	AVG
1.0900	38.27	9.92	48.19	56.00	-7.81	QP
1.0900	21.86	9.92	31.78	46.00	-14.22	AVG
1.9020	39.37	9.85	49.22	56.00	-6.78	QP
1.9020	22.78	9.85	32.63	46.00	-13.37	AVG

Remark:

1. All readings are Quasi-Peak and Average values.
2. Factor = Insertion Loss + Cable Loss.

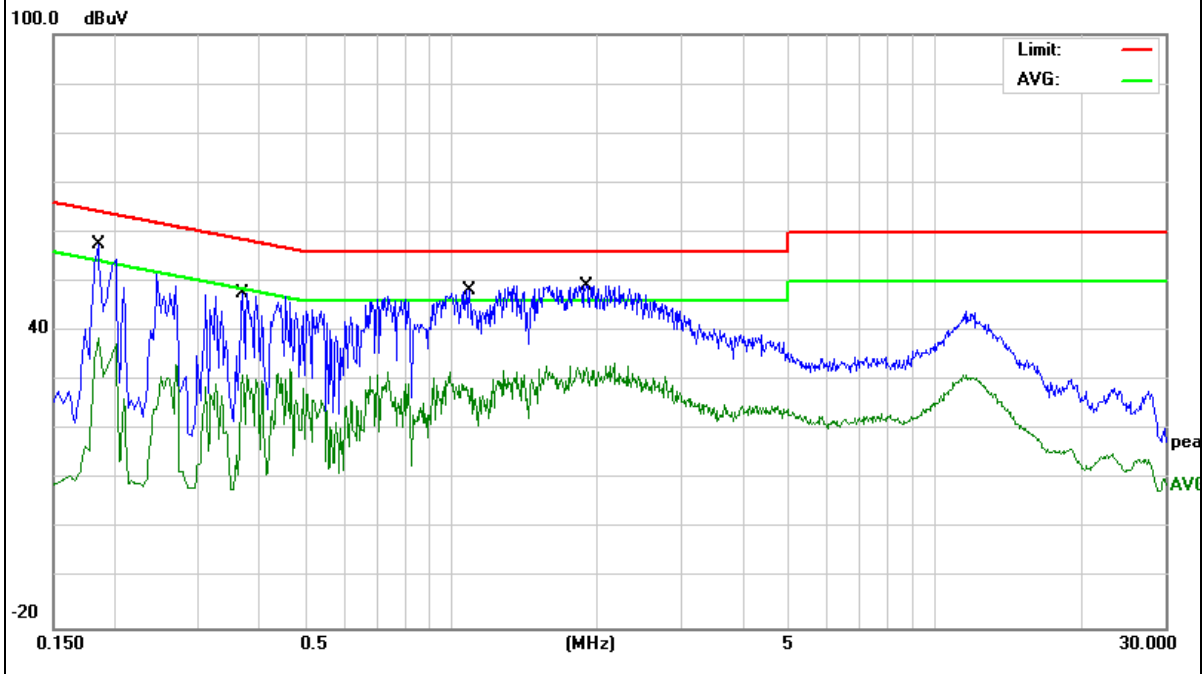

EUT :	notebook	Model Name. :	DTLAPY133-1
Temperature :	26 °C	Relative Humidity :	56%
Pressure :	1010hPa	Phase :	N
Test Voltage :	DC 12V from Adapter AC 240V/60Hz	Test Mode :	Mode 1

Frequency (MHz)	Reading Level (dBμV)	Correct Factor (dB)	Measure-ment (dBμV)	Limits (dBμV)	Margin (dB)	Remark
0.1980	47.70	9.92	57.62	63.69	-6.07	QP
0.1980	28.90	9.92	38.82	53.69	-14.87	AVG
0.4340	36.98	9.93	46.91	57.18	-10.27	QP
0.4340	21.47	9.93	31.40	47.18	-15.78	AVG
11.7900	29.93	10.14	40.07	60.00	-19.93	QP
11.7900	18.32	10.14	28.46	50.00	-21.54	AVG

Remark:

1. All readings are Quasi-Peak and Average values.
2. Factor = Insertion Loss + Cable Loss.

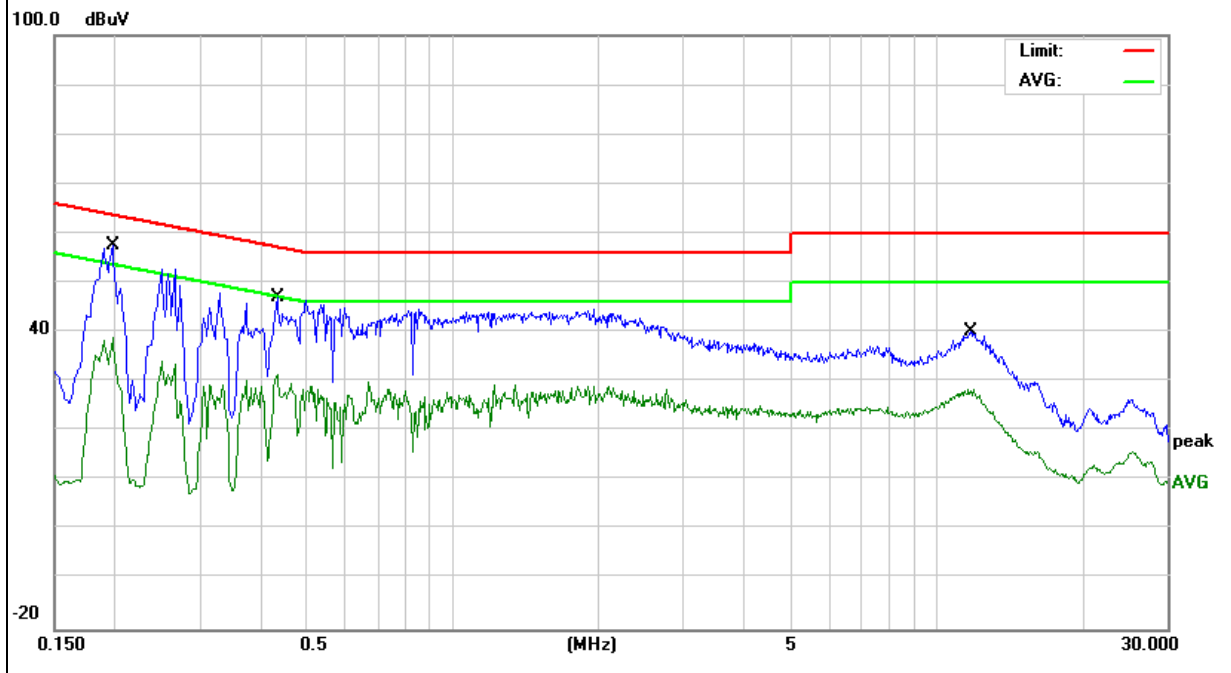

3.2 RADIATED EMISSION MEASUREMENT

3.2.1 APPLICABLE STANDARD

According to FCC Part 15.407(d) and 15.209

3.2.2 CONFORMANCE LIMIT

According to FCC Part 15.407(b)(7): radiated emissions which fall in the restricted bands, as defined in §15.205(a), must also comply with the radiated emission limits specified in §15.209(a) (see §15.205(c)).
According to FCC Part 15.205, Restricted bands

MHz	MHz	MHz	GHz
0.090-0.110	16.42-16.423	399.9-410	4.5-5.15
10.495-0.505	16.69475-16.69525	608-614	5.35-5.46
2.1735-2.1905	16.80425-16.80475	960-1240	7.25-7.75
4.125-4.128	25.5-25.67	1300-1427	8.025-8.5
4.17725-4.17775	37.5-38.25	1435-1626.5	9.0-9.2
4.20725-4.20775	73-74.6	1645.5-1646.5	9.3-9.5
6.215-6.218	74.8-75.2	1660-1710	10.6-12.7
6.26775-6.26825	123-138	2200-2300	14.47-14.5
8.291-8.294	149.9-150.05	2310-2390	15.35-16.2
8.362-8.366	156.52475-156.52525	2483.5-2500	17.7-21.4
8.37625-8.38675	156.7-156.9	2690-2900	22.01-23.12
8.41425-8.41475	162.0125-167.17	3260-3267	23.6-24.0
12.29-12.293	167.72-173.2	3332-3339	31.2-31.8
12.51975-12.52025	240-285	3345.8-3358	36.43-36.5
12.57675-12.57725	322-335.4	3600-4400	(2)
13.36-13.41			

20dBc in any 100 kHz bandwidth outside the operating frequency band. In case the emission fall within the restricted band specified on 15.205(a), then the 15.209(a) limit in the table below has to be followed.

Restricted Frequency(MHz)	Field Strength ($\mu\text{V/m}$)	Field Strength ($\text{dB}\mu\text{V/m}$)	Measurement Distance
0.009~0.490	2400/F(KHz)	20 log ($\mu\text{V/m}$)	300
0.490~1.705	2400/F(KHz)	20 log ($\mu\text{V/m}$)	30
1.705~30.0	30	29.5	30
30-88	100	40	3
88-216	150	43.5	3
216-960	200	46	3
Above 960	500	54	3

Limits of Radiated Emission Measurement(Above 1000MHz)

Frequency(MHz)	Class B ($\text{dB}\mu\text{V/m}$) (at 3M)	
	PEAK	AVERAGE
Above 1000	74	54

Remark : 1. Emission level in $\text{dB}\mu\text{V/m}=20 \log (\mu\text{V/m})$
 2. Measurement was performed at an antenna to the closed point of EUT distance of meters.
 3. Distance extrapolation factor = $40 \log (\text{Specific distance/ test distance})$ (dB);
 Limit line = Specific limits($\text{dB}\mu\text{V}$) + distance extrapolation factor.

3.2.3 MEASURING INSTRUMENTS

The Measuring equipment is listed in the section 6.3 of this test report.

3.2.4 TEST CONFIGURATION

(a) For radiated emissions below 30MHz

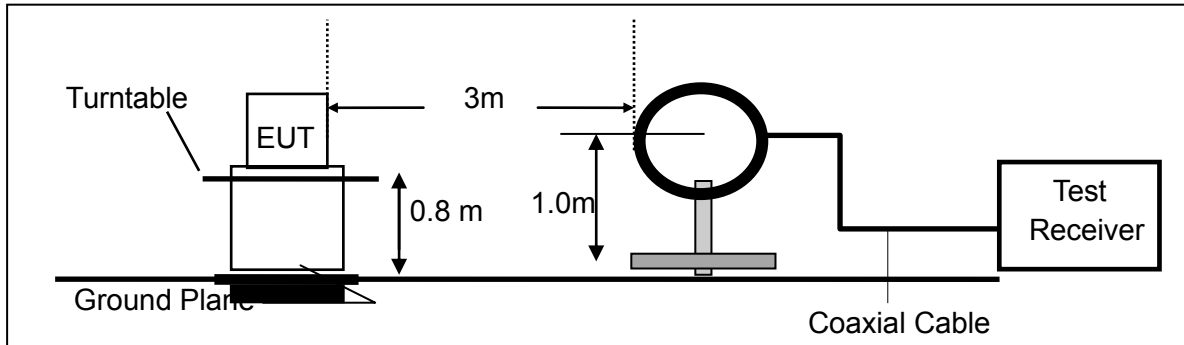

(b) For radiated emissions from 30MHz to 1000MHz

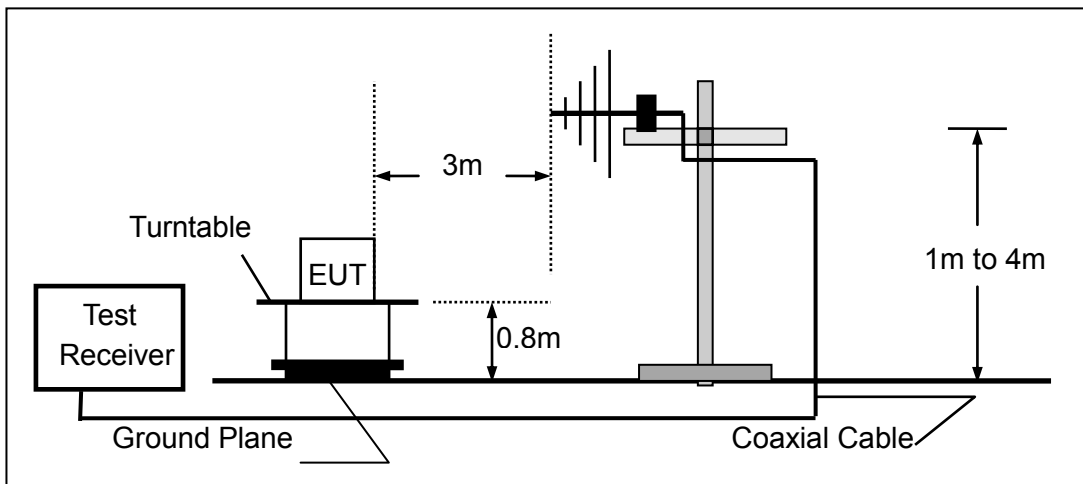

(c) For radiated emissions above 1000MHz

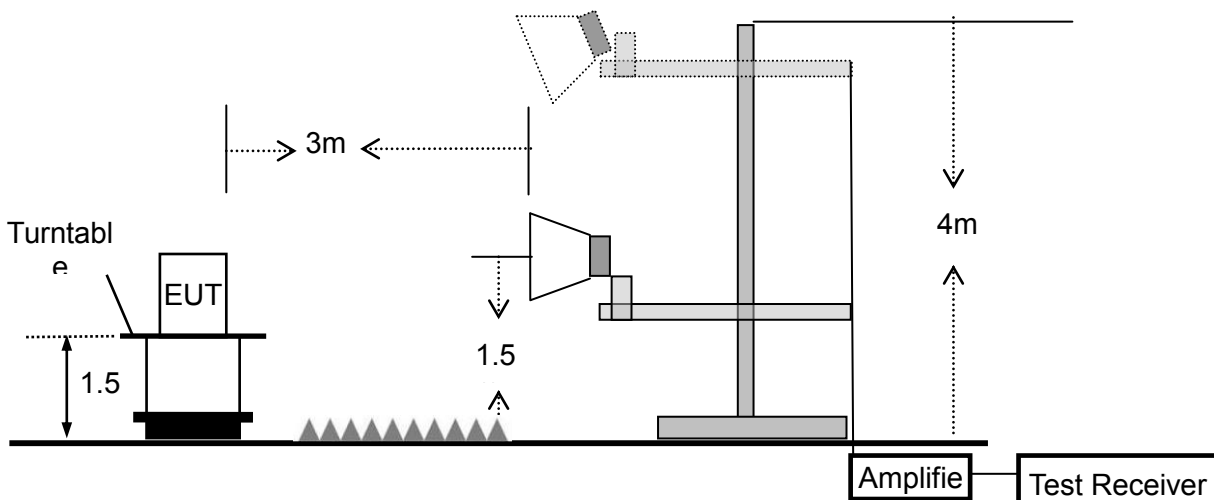

3.2.5 TEST PROCEDURE

The test site semi-anechoic chamber has met the requirement of NSA tolerance 4 dB according to the standards: ANSI C63.10-2013. The test distance is 3m. The setup is according to the requirements in Section 13.1.4.1 of ANSI C63.10-2013 and CAN/CSA-CEI/IEC CISPR 22.

This test is required for any spurious emission that falls in a Restricted Band, as defined in Section 15.205. It must be performed with the highest gain of each type of antenna proposed for use with the EUT.

Use the following spectrum analyzer settings:

Spectrum Parameter	Setting
Attenuation	Auto
Start Frequency	1000 MHz
Stop Frequency	10th carrier harmonic
RB / VB (emission in restricted band)	1 MHz / 1 MHz for Peak, 1 MHz / 10Hz for Average

Receiver Parameter	Setting
Attenuation	Auto
Start ~ Stop Frequency	9kHz~150kHz / RB 200Hz for QP
Start ~ Stop Frequency	150kHz~30MHz / RB 9kHz for QP
Start ~ Stop Frequency	30MHz~1000MHz / RB 120kHz for QP

- The measuring distance of at 3 m shall be used for measurements at frequency up to 1GHz. For frequencies above 1GHz, any suitable measuring distance may be used.
- The EUT was placed on the top of a rotating table 0.8 m for below 1GHz and 1.5m for above 1GHz the ground at a 3 meter. The table was rotated 360 degrees to determine the position of the highest radiation.
- The height of the equipment or of the substitution antenna shall be 0.8 m for below 1GHz and 1.5m for above 1GHz; the height of the test antenna shall vary between 1 m to 4 m. Both horizontal and vertical polarizations of the antenna are set to make the measurement.
- The initial step in collecting conducted emission data is a spectrum analyzer peak detector mode pre-scanning the measurement frequency range. Significant peaks are then marked and then Quasi Peak detector mode re-measured.
- If the Peak Mode measured value compliance with and lower than Quasi Peak Mode Limit, the EUT shall be deemed to meet QP Limits and then no additional QP Mode measurement performed.
- For the actual test configuration, please refer to the related Item –EUT Test Photos.

Note:

Both horizontal and vertical antenna polarities were tested and performed pretest to three orthogonal axis. The worst case emissions were reported

During the radiated emission test, the Spectrum Analyzer was set with the following configurations:

Frequency Band (MHz)	Function	Resolution bandwidth	Video Bandwidth
30 to 1000	QP	120 kHz	300 kHz
Above 1000	Peak	1 MHz	1 MHz
	Average	1 MHz	10 Hz

Note: for the frequency ranges below 30 MHz, a narrower RBW is used for these ranges but the measured value should add a RBW correction factor (RBWCF) where $RBWCF [dB] = 10 \cdot \lg(100 [kHz] / \text{narrower RBW [kHz]})$. , the narrower RBW is 1 kHz and RBWCF is 20 dB for the frequency 9 kHz to 150 kHz, and the narrower RBW is 10 kHz and RBWCF is 10 dB for the frequency 150 kHz to 30 MHz.

3.2.6 TEST RESULTS (9KHZ – 30 MHZ)

EUT:	notebook	Model Name. :	DTLAPY133-1
Temperature:	20 °C	Relative Humidity:	48%
Pressure:	1010 hPa	Test Voltage :	DC 7.4V
Test Mode :	TX	Polarization :	--

Freq. (MHz)	Reading (dBuV/m)	Limit (dBuV/m)	Margin (dB)	State P/F
--	--	--	--	N/A
--	--	--	--	N/A

NOTE:

The amplitude of spurious emissions which are attenuated by more than 20dB below the permissible value has no need to be reported.

Distance extrapolation factor = $40 \log (\text{specific distance}/\text{test distance})$ (dB);

Limit line = specific limits(dBuv) + distance extrapolation factor.

3.2.7 TEST RESULTS (30MHZ – 1GHZ)

EUT :	notebook	Model Name. :	DTLAPY133-1
Temperature :	20 °C	Relative Humidity :	48%
Pressure :	1010 hPa	Test Voltage :	DC 7.4V
Test Mode :	TX(5.2G)- 802.11a (High CH)		

Polar (H/V)	Frequency	Meter Reading	Factor	Emission Level	Limits	Margin	Remark
	(MHz)	(dBuV)	(dB)	(dBuV/m)	(dBuV/m)	(dB)	
V	47.3253	20.68	13.26	33.94	40.00	-6.06	QP
V	90.5374	19.08	11.80	30.88	43.50	-12.62	QP
V	109.4116	23.92	10.23	34.15	43.50	-9.35	QP
V	264.7456	24.81	13.50	38.31	46.00	-7.69	QP
V	480.5276	18.49	16.92	35.41	46.00	-10.59	QP
V	742.2586	12.40	22.37	34.77	46.00	-11.23	QP

Remark:

Absolute Level= ReadingLevel+ Factor, Margin= Absolute Level - Limit

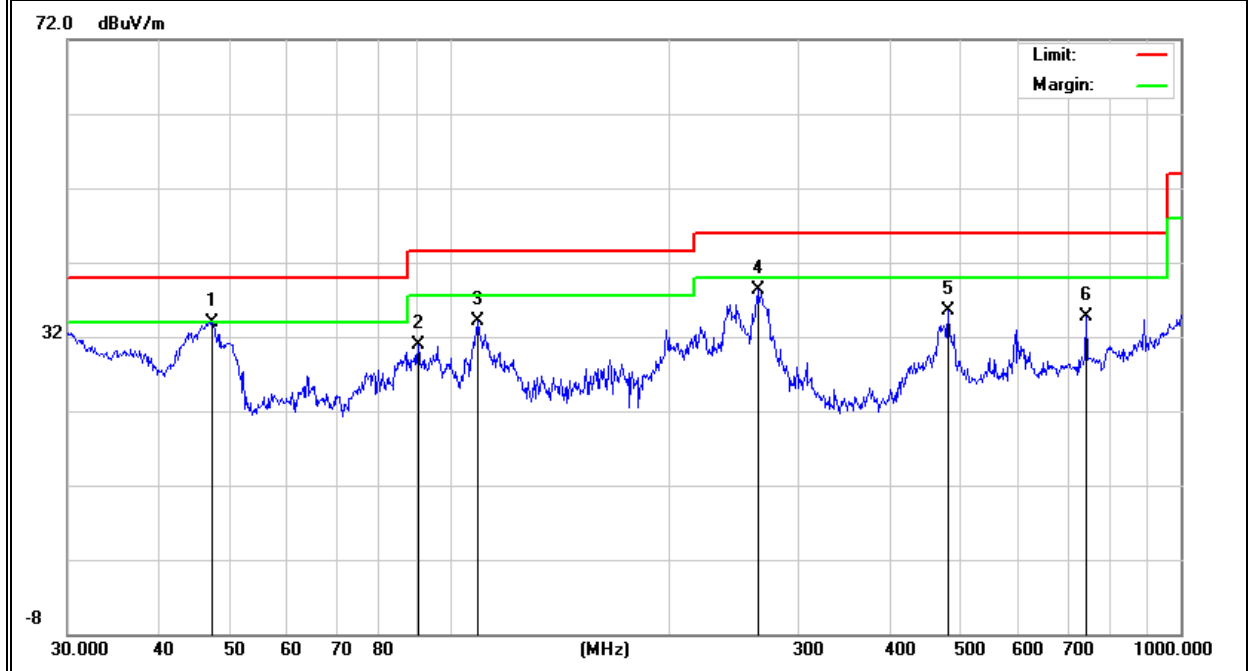

Polar (H/V)	Frequency	Meter Reading	Factor	Emission Level	Limits	Margin	Remark
	(MHz)	(dBuV)	(dB)	(dBuV/m)	(dBuV/m)	(dB)	
H	63.9827	16.04	8.87	24.91	40.00	-15.09	QP
H	96.4360	23.51	11.67	35.18	43.50	-8.32	QP
H	249.4250	28.12	12.10	40.22	46.00	-5.78	QP
H	296.1836	24.08	14.63	38.71	46.00	-7.29	QP
H	595.1326	18.55	18.84	37.39	46.00	-8.61	QP
H	742.2586	13.79	22.37	36.16	46.00	-9.84	QP

Remark:

Absolute Level= ReadingLevel+ Factor, Margin= Absolute Level - Limit

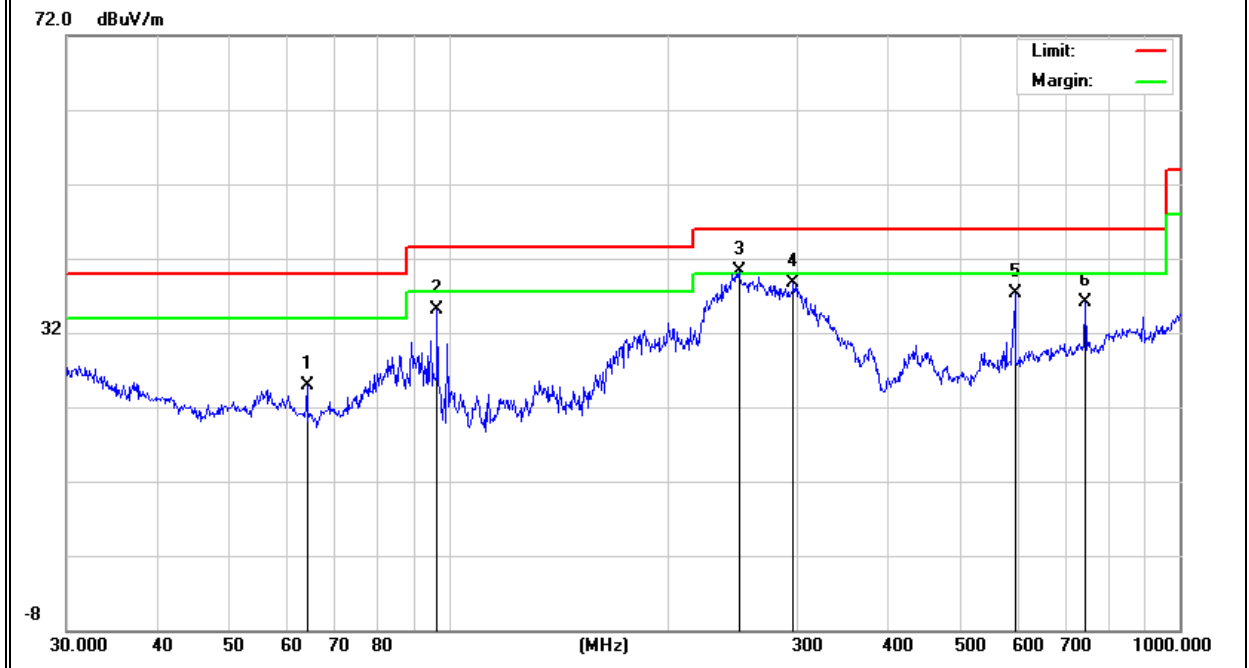

EUT :	notebook	Model Name. :	DTLAPY133-1
Temperature :	20 °C	Relative Humidity :	48%
Pressure :	1010 hPa	Test Voltage :	DC 7.4V
Test Mode :	TX(5.8G) - 802.11a (High CH)		

Polar (H/V)	Frequency	Meter Reading	Factor	Emission Level	Limits	Margin	Remark
	(MHz)	(dBuV)	(dB)	(dBuV/m)	(dBuV/m)	(dB)	
V	48.1625	21.57	13.38	34.95	40.00	-5.05	QP
V	97.1148	22.03	11.04	33.07	43.50	-10.43	QP
V	213.7632	19.48	13.30	32.78	43.50	-10.72	QP
V	278.0668	19.91	14.05	33.96	46.00	-12.04	QP
V	595.1326	13.53	18.84	32.37	46.00	-13.63	QP
V	742.2586	12.91	22.37	35.28	46.00	-10.72	QP

Remark:

Absolute Level= ReadingLevel+ Factor, Margin= Absolute Level - Limit

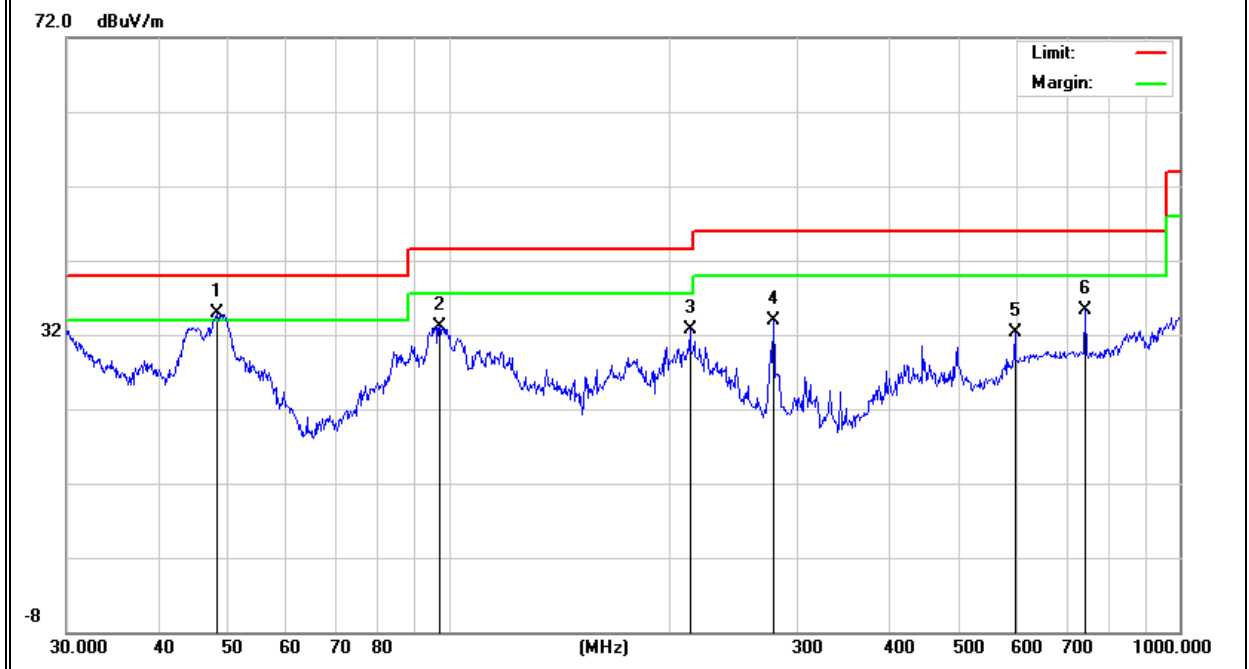

Polar (H/V)	Frequency	Meter Reading	Factor	Emission Level	Limits	Margin	Remark
	(MHz)	(dBuV)	(dB)	(dBuV/m)	(dBuV/m)	(dB)	
H	93.1132	22.43	11.98	34.41	43.50	-9.09	QP
H	192.4182	20.31	13.21	33.52	43.50	-9.98	QP
H	237.4755	25.19	12.01	37.20	46.00	-8.80	QP
H	327.8872	23.01	13.78	36.79	46.00	-9.21	QP
H	595.1326	13.67	18.84	32.51	46.00	-13.49	QP
H	742.2586	13.32	22.37	35.69	46.00	-10.31	QP

Remark:

Absolute Level= ReadingLevel+ Factor, Margin= Absolute Level - Limit

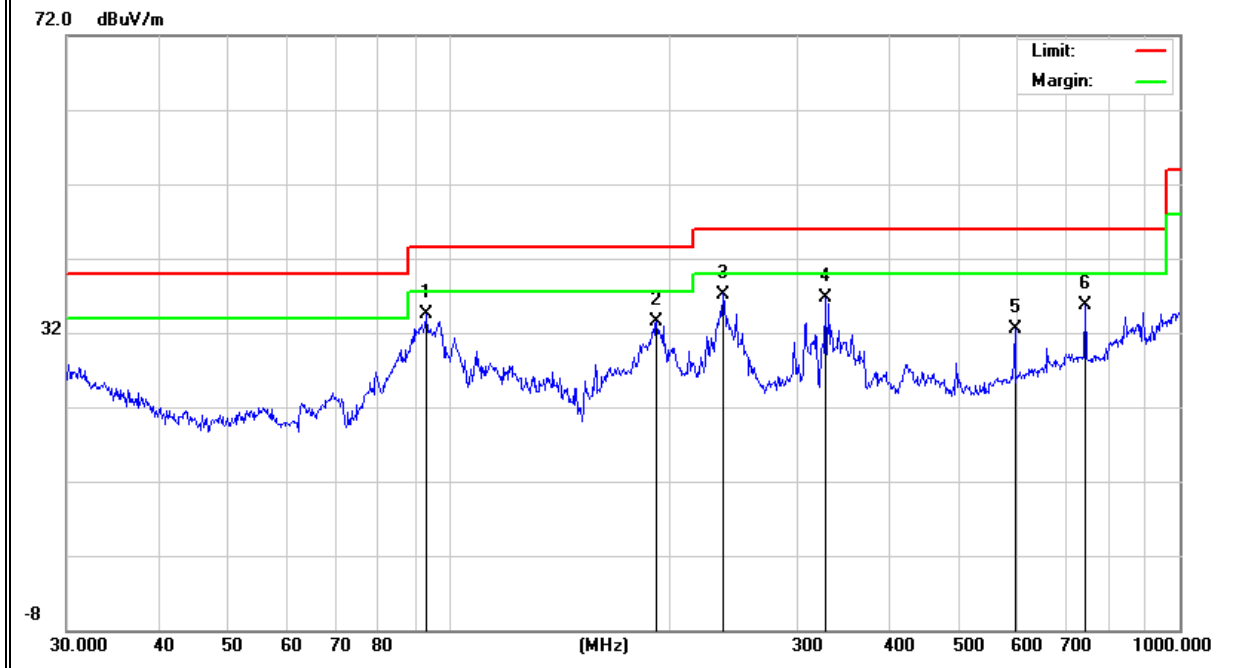

3.2.8 TEST RESULTS (1GHz-26GHz)

EUT :	notebook	Model Name. :	DTLAPY133-1
Temperature :	20 °C	Relative Humidity :	48%
Pressure :	1010 hPa	Test Voltage :	DC 7.4V
Test Mode :	TX(5.2G) - 802.11a _5180~5240MHz		

Polar	Frequency	Meter Reading	Cable loss	Antenna Factor	Preamp Factor	Emission Level	Limits	Margin	Detector Type
(H/V)	(MHz)	(dBuV)	(dB)	dB/m	(dB)	(dBuV/m)	(dBuV/m)	(dB)	
Low Channel (5180 MHz)-Above 1G									
Vertical	4434.157	62.22	5.94	35.40	44.00	59.56	74.00	-14.44	Pk
Vertical	4434.157	46.57	5.94	35.40	44.00	43.91	54.00	-10.09	AV
Vertical	10370.362	60.41	8.46	39.75	44.50	64.12	74.00	-9.88	Pk
Vertical	10370.362	42.94	8.46	39.75	44.50	46.65	54.00	-7.35	AV
Vertical	15540.196	61.48	10.12	38.80	44.10	66.3	74.00	-7.7	Pk
Vertical	15540.196	37.56	10.12	38.80	42.70	43.78	54.00	-10.22	AV
Horizontal	4434.521	66.59	5.94	35.18	44.00	63.71	74.00	-10.29	Pk
Horizontal	4434.521	44.11	5.94	35.18	44.00	41.23	54.00	-12.77	AV
Horizontal	10370.623	58.97	8.46	38.71	44.50	61.64	74.00	-12.36	Pk
Horizontal	10370.623	41.03	8.46	38.71	44.50	43.7	54.00	-10.3	AV
Horizontal	10540.865	56.96	10.12	38.38	44.10	61.36	74.00	-12.64	Pk
Horizontal	10540.865	38.88	10.12	38.38	44.10	43.28	54.00	-10.72	AV
middle Channel (5200 MHz)-Above 1G									
Vertical	4592.093	60.25	6.48	36.35	44.05	59.03	74.00	-14.97	Pk
Vertical	4592.093	41.91	6.48	36.35	44.05	40.69	54.00	-13.31	AV
Vertical	10401.424	59.68	8.47	37.88	44.51	61.52	74.00	-12.48	Pk
Vertical	10401.424	42.74	8.47	37.88	44.51	44.58	54.00	-9.42	AV
Vertical	15600.218	56.52	10.12	38.8	44.10	61.34	74.00	-12.66	Pk
Vertical	15600.218	36.64	10.12	38.8	42.70	42.86	54.00	-11.14	AV
Horizontal	4592.691	59.86	6.48	36.37	44.05	58.66	74.00	-15.34	Pk
Horizontal	4592.691	43.11	6.48	36.37	44.05	41.91	54.00	-12.09	AV
Horizontal	10400.114	58.87	8.47	38.64	44.50	61.48	74.00	-12.52	Pk
Horizontal	10400.114	42.24	8.47	38.64	44.50	44.85	54.00	-9.15	AV
Horizontal	15600.187	59.86	10.12	38.38	44.10	64.26	74.00	-9.74	Pk
Horizontal	15600.187	38.78	10.12	38.38	44.10	43.18	54.00	-10.82	AV
High Channel (5240 MHz)-Above 1G									
Vertical	4739.246	61.23	7.10	37.24	43.50	62.07	74.00	-11.93	Pk
Vertical	4739.246	44.41	7.10	37.24	43.50	45.25	54.00	-8.75	AV
Vertical	10480.371	60.52	8.46	37.68	44.50	62.16	74.00	-11.84	Pk
Vertical	10480.371	40.32	8.46	37.68	44.50	41.96	54.00	-12.04	AV
Vertical	15720.359	61.74	10.12	38.8	44.10	66.56	74.00	-7.44	Pk
Vertical	15720.359	39.68	10.12	38.8	42.70	45.9	54.00	-8.1	AV
Horizontal	4739.352	62.24	7.10	37.24	43.50	63.08	74.00	-10.92	Pk
Horizontal	4739.352	43.27	7.10	37.24	43.50	44.11	54.00	-9.89	AV
Horizontal	10481.111	62.57	8.46	38.57	44.50	65.1	74.00	-8.9	Pk
Horizontal	10481.111	43.32	8.46	38.57	44.50	45.85	54.00	-8.15	AV
Horizontal	15720.357	60.74	10.12	38.38	44.10	65.14	74.00	-8.86	Pk
Horizontal	15720.357	42.26	10.12	38.38	44.10	46.66	54.00	-7.34	AV

Note:"802.11n20(5G)" mode is the worst mode. PK value is lower than the Average value limit, So average didn't record.

The amplitude of spurious emissions that are attenuated by more than 20dB below the permissible value has no need to be reported.

Emission level (dBuV/m) = 20 log Emission level (uV/m).

Corrected Reading: Antenna Factor + Cable Loss + Read Level - Preamp Factor = Level.

EUT :	notebook	Model Name. :	DTLAPY133-1
Temperature :	20 °C	Relative Humidity :	48%
Pressure :	1010 hPa	Test Voltage :	DC 7.4V
Test Mode :	TX (5.8G) -- 802.11a _5745~5825MHz		

Polar	Frequency	Meter Reading	Cable loss	Antenna Factor	Preamp Factor	Emission Level	Limits	Margin	Detector Type
(H/V)	(MHz)	(dBuV)	(dB)	dB/m	(dB)	(dBuV/m)	(dBuV/m)	(dB)	
Low Channel (5745 MHz)-Above 1G									
Vertical	4679.195	59.98	5.94	35.40	44.00	57.32	74.00	-16.68	Pk
Vertical	4679.195	39.64	5.94	35.40	44.00	36.98	54.00	-17.02	AV
Vertical	11490.364	59.58	8.46	39.75	44.50	63.29	74.00	-10.71	Pk
Vertical	11490.364	42.11	8.46	39.75	44.50	45.82	54.00	-8.18	AV
Vertical	17235.101	55.59	10.12	38.80	44.10	60.41	74.00	-13.59	Pk
Vertical	17235.101	38.67	10.12	38.80	42.70	44.89	54.00	-9.11	AV
Horizontal	4679.332	57.94	5.94	35.18	44.00	55.06	74.00	-18.94	Pk
Horizontal	4679.332	44.51	5.94	35.18	44.00	41.63	54.00	-12.37	AV
Horizontal	11490.164	56.68	8.46	38.71	44.50	59.35	74.00	-14.65	Pk
Horizontal	11490.164	40.12	8.46	38.71	44.50	42.79	54.00	-11.21	AV
Horizontal	17235.196	58.65	10.12	38.38	44.10	63.05	74.00	-10.95	Pk
Horizontal	17235.196	42.28	10.12	38.38	44.10	46.68	54.00	-7.32	AV
middle Channel (5785 MHz)-Above 1G									
Vertical	4592.228	59.85	6.48	36.35	44.05	58.63	74.00	-15.37	Pk
Vertical	4592.228	43.32	6.48	36.35	44.05	42.1	54.00	-11.9	AV
Vertical	11570.203	61.15	8.47	37.88	44.51	62.99	74.00	-11.01	Pk
Vertical	11570.203	43.26	8.47	37.88	44.51	45.1	54.00	-8.9	AV
Vertical	17355.147	59.58	10.12	38.8	44.10	64.4	74.00	-9.6	Pk
Vertical	17355.147	42.21	10.12	38.8	42.70	48.43	54.00	-5.57	AV
Horizontal	4592.526	58.65	6.48	36.37	44.05	57.45	74.00	-16.55	Pk
Horizontal	4592.526	43.32	6.48	36.37	44.05	42.12	54.00	-11.88	AV
Horizontal	11570.123	60.02	8.47	38.64	44.50	62.63	74.00	-11.37	Pk
Horizontal	11570.123	42.22	8.47	38.64	44.50	44.83	54.00	-9.17	AV
Horizontal	17355.269	57.59	10.12	38.38	44.10	61.99	74.00	-12.01	Pk
Horizontal	17355.269	42.23	10.12	38.38	44.10	46.63	54.00	-7.37	AV
High Channel (5825 MHz)-Above 1G									
Vertical	6039.199	57.64	7.10	37.24	43.50	58.48	74.00	-15.52	Pk
Vertical	6039.199	42.25	7.10	37.24	43.50	43.09	54.00	-10.91	AV
Vertical	11652.562	58.95	8.46	37.68	44.50	60.59	74.00	-13.41	Pk
Vertical	11652.562	41.12	8.46	37.68	44.50	42.76	54.00	-11.24	AV
Vertical	17473.128	58.55	10.12	38.8	44.10	63.37	74.00	-10.63	Pk
Vertical	17473.128	40.32	10.12	38.8	42.70	46.54	54.00	-7.46	AV
Horizontal	6039.232	59.96	7.10	37.24	43.50	60.8	74.00	-13.2	Pk
Horizontal	6039.232	43.35	7.10	37.24	43.50	44.19	54.00	-9.81	AV
Horizontal	11652.319	52.26	8.46	38.57	44.50	54.79	74.00	-19.21	Pk
Horizontal	11652.319	40.14	8.46	38.57	44.50	42.67	54.00	-11.33	AV
Horizontal	17474.062	57.74	10.12	38.38	44.10	62.14	74.00	-11.86	Pk
Horizontal	17474.062	40.32	10.12	38.38	44.10	44.72	54.00	-9.28	AV

Note:"802.11a(5G)" mode is the worst mode. PK value is lower than the Average value limit, So average didn't record.

The amplitude of spurious emissions that are attenuated by more than 20dB below the permissible value

has no need to be reported.

Emission level (dBuV/m) = 20 log Emission level (uV/m).

Corrected Reading: Antenna Factor + Cable Loss + Read Level - Preamp Factor = Level.

3.2.9 TEST RESULTS (26GHZ-40GHZ)

EUT :	notebook	Model Name. :	DTLAPY133-1
Temperature :	20 °C	Relative Humidity :	48%
Pressure :	1010 hPa	Test Voltage :	DC 7.4V
Test Mode :	TX (5.2G)-802.11a 5180MHz~5240MHz , TX (5.8G)-802.11a 5745MHz~5825MHz		

All the modulation modes have been tested, and the worst result was report as below:

Low Channel (5180 MHz)-Above 1G

Horizontal

FCC Electric Field Strength 26.5-40GHz

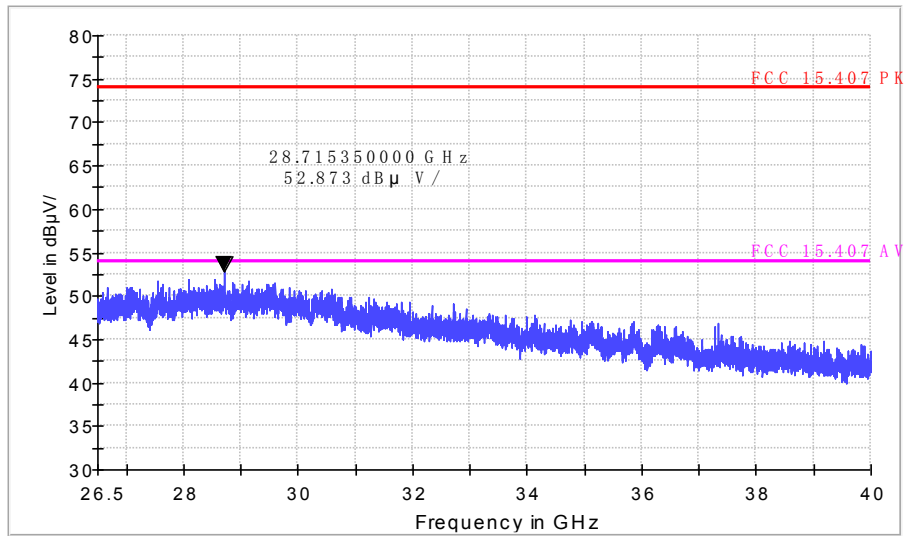

Vertical

FCC Electric Field Strength 26.5-40GHz

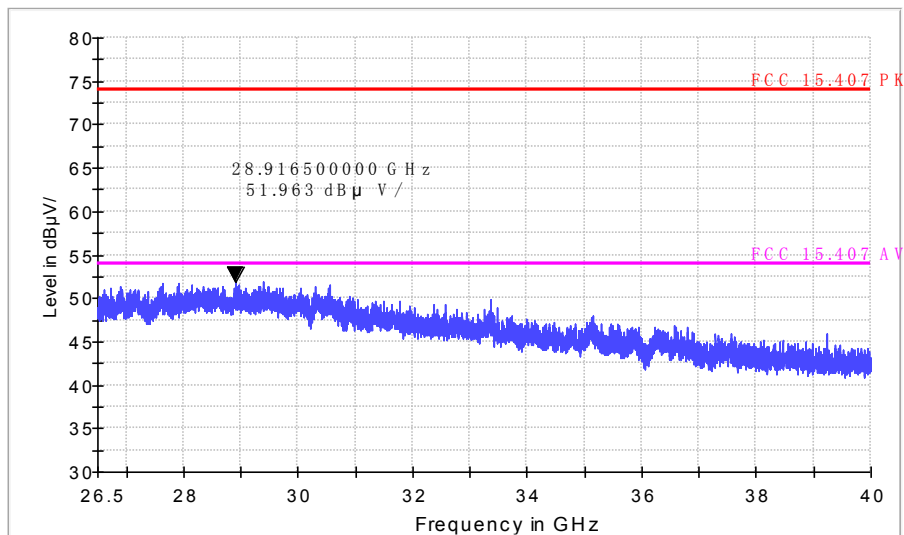

Low Channel (5240 MHz)-Above 1G

Horizontal

FCC Electric Field Strength 26.5-40GHz

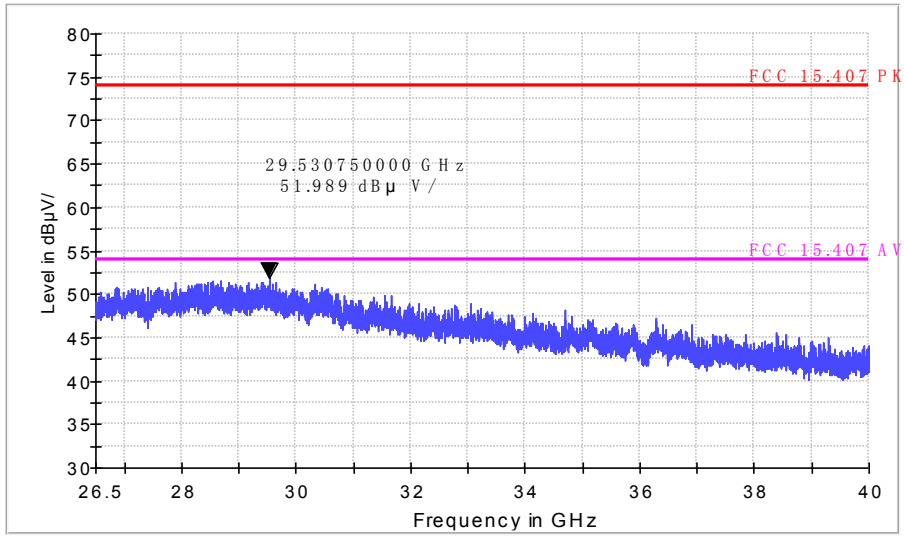

Vertical

FCC Electric Field Strength 26.5-40GHz

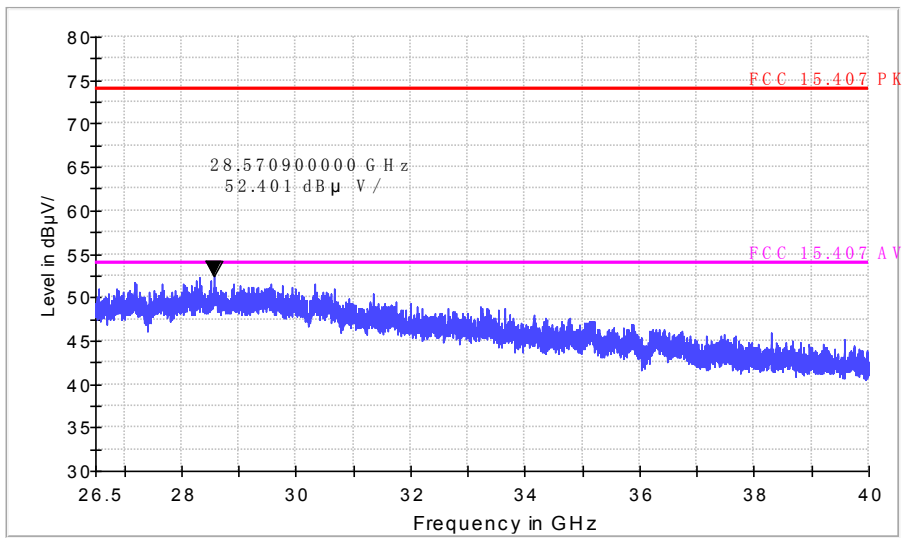

Low Channel (5745 MHz)-Above 1G

Horizontal

FCC Electric Field Strength 26.5-40GHz

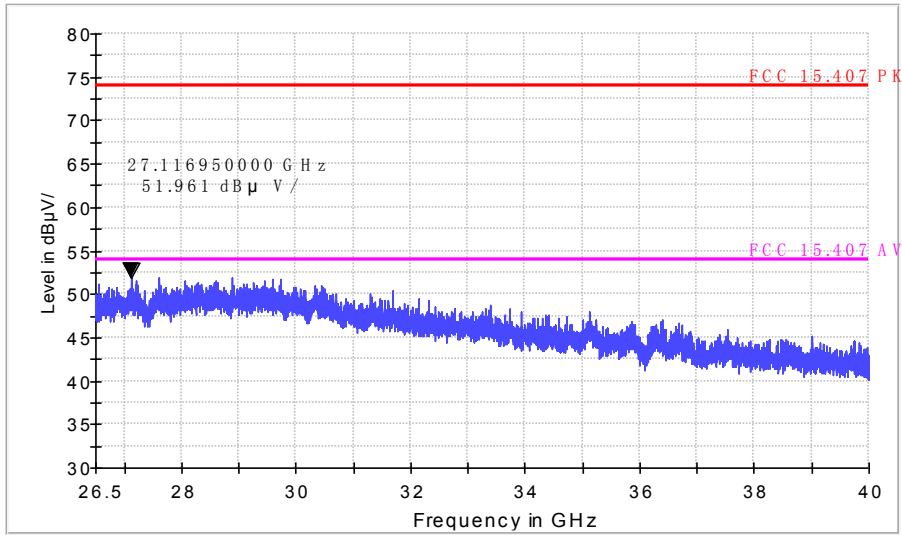

Vertical

FCC Electric Field Strength 26.5-40GHz

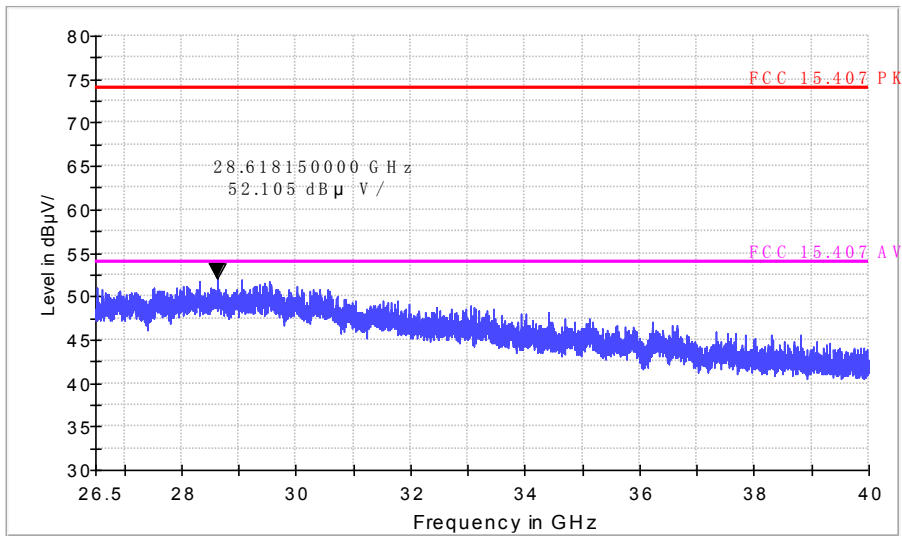

Low Channel (5825 MHz)-Above 1G

Horizontal

FCC Electric Field Strength 26.5-40GHz

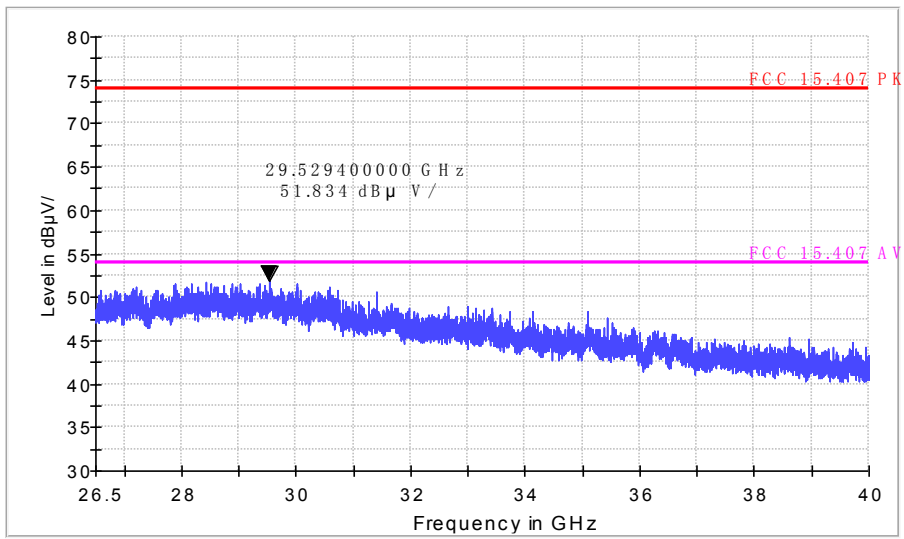

Vertical

FCC Electric Field Strength 26.5-40GHz

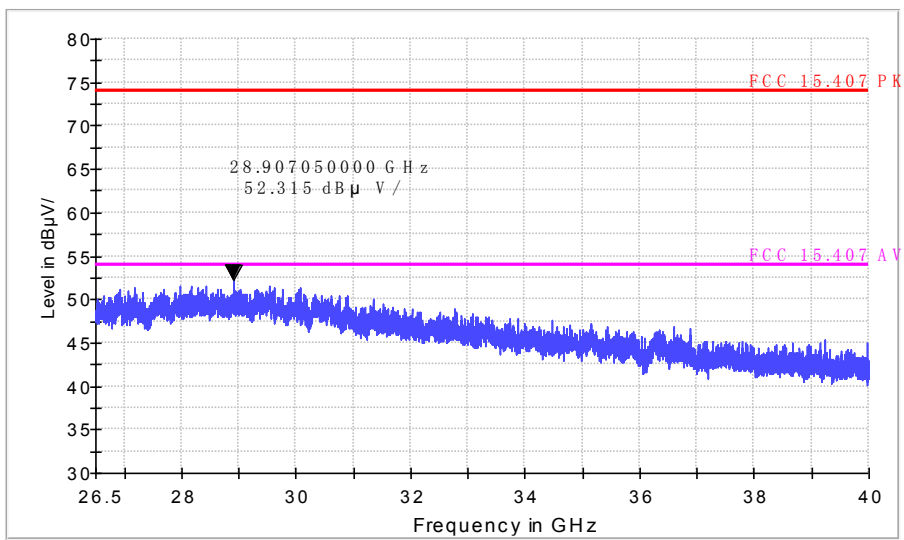

4. POWER SPECTRAL DENSITY TEST

4.1 APPLIED PROCEDURES / LIMIT

According to FCC §15.407(a)(3)

For the band 5.15-5.25 GHz,

(i) For an outdoor access point operating in the band 5.15-5.25 GHz, the maximum power spectral density shall not exceed 17 dBm in any 1 megahertz band. If transmitting antennas of directional gain greater than 6 dBi are used, both the maximum conducted output power and the maximum power spectral density shall be reduced by the amount in dB that the directional gain of the antenna exceeds 6 dBi. The maximum e.i.r.p. at any elevation angle above 30 degrees as measured from the horizon must not exceed 125 mW (21 dBm).

(ii) For an indoor access point operating in the band 5.15-5.25 GHz, the maximum power spectral density shall not exceed 17 dBm in any 1 megahertz band. If transmitting antennas of directional gain greater than 6 dBi are used, both the maximum conducted output power and the maximum power spectral density shall be reduced by the amount in dB that the directional gain of the antenna exceeds 6 dBi.

(iii) For fixed point-to-point access points operating in the band 5.15-5.25 GHz, the maximum power spectral density shall not exceed 17 dBm in any 1 megahertz band. Fixed point-to-point U-NII devices may employ antennas with directional gain up to 23 dBi without any corresponding reduction in the maximum conducted output power or maximum power spectral density. For fixed point-to-point transmitters that employ a directional antenna gain greater than 23 dBi, a 1 dB reduction in maximum conducted output power and maximum power spectral density is required for each 1 dB of antenna gain in excess of 23 dBi. Fixed, point-to-point operations exclude the use of point-to-multipoint systems, omnidirectional applications, and multiple collocated transmitters transmitting the same information. The operator of the U-NII device, or if the equipment is professionally installed, the installer, is responsible for ensuring that systems employing high gain directional antennas are used exclusively for fixed, point-to-point operations.

(iv) For client devices in the 5.15-5.25 GHz band, the maximum power spectral density shall not exceed 11 dBm in any 1 megahertz band. If transmitting antennas of directional gain greater than 6 dBi are used, both the maximum conducted output power and the maximum power spectral density shall be reduced by the amount in dB that the directional gain of the antenna exceeds 6 dBi.

For the band 5.725-5.85 GHz

(3) For the band 5.725-5.85 GHz, the maximum power spectral density shall not exceed 30 dBm in any 500-kHz band. If transmitting antennas of directional gain greater than 6 dBi are used, both the maximum conducted output power and the maximum power spectral density shall be reduced by the amount in dB that the directional gain of the antenna exceeds 6 dBi.

,

4.2 TEST PROCEDURE

For devices operating in the bands 5.15-5.25 GHz, 5.25-5.35 GHz, and 5.47-5.725 GHz, the above procedures make use of 1 MHz RBW to satisfy directly the 1 MHz reference bandwidth specified in § 15.407(a)(5). For devices operating in the band 5.725-5.85 GHz, the rules specify a measurement bandwidth of 500 kHz. Many spectrum analyzers do not have 500 kHz RBW, thus a narrower RBW may need to be used. The rules permit the use of a RBWs less than 1 MHz, or 500 kHz, “provided that the measured power is integrated over the full reference bandwidth” to show the total power over the specified measurement bandwidth (i.e., 1 MHz, or 500 kHz). If measurements are performed using a reduced resolution bandwidth (< 1 MHz, or < 500 kHz) and integrated over 1 MHz, or 500 KHz bandwidth, the following adjustments to the procedures apply:

- a) Set $RBW \geq 1/T$, where T is defined in section II.B.I.a).
- b) Set $VBW \geq 3 RBW$.
- c) If measurement bandwidth of Maximum PSD is specified in 500 kHz, add $10\log(500\text{kHz}/RBW)$ to the measured result, whereas $RBW (< 500 \text{ KHz})$ is the reduced resolution bandwidth of the spectrum analyzer set during measurement.
- d) If measurement bandwidth of Maximum PSD is specified in 1 MHz, add $10\log(1\text{MHz}/RBW)$ to the measured result, whereas $RBW (< 1 \text{ MHz})$ is the reduced resolution bandwidth of spectrum analyzer set during measurement.
- e) Care must be taken to ensure that the measurements are performed during a period of continuous transmission or are corrected upward for duty cycle.

Note: As a practical matter, it is recommended to use reduced RBW of 100 KHz for the sections 5.c) and 5.d) above, since $RBW=100 \text{ KHz}$ is available on nearly all spectrum analyzers.

4.3 DEVIATION FROM STANDARD

No deviation.

4.4 TEST SETUP

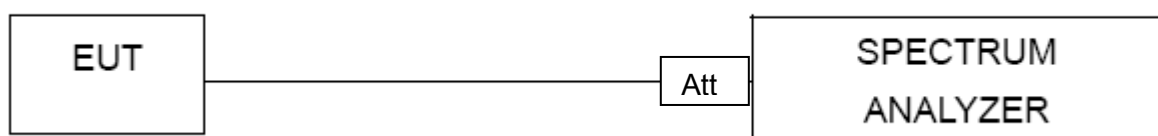

4.5 EUT OPERATION CONDITIONS

The EUT tested system was configured as the statements of 2.1 Unless otherwise a special operating condition is specified in the follows during the testing.

4.6 TEST RESULTS

EUT :	notebook	Model Name. :	DTLAPY133-1
Temperature :	25 °C	Relative Humidity :	56%
Pressure :	1015 hPa	Test Voltage :	DC 7.4V
Test Mode :	TX Frequency Band I (5150-5250MHz)		

Note: A(B) Represent the value of antenna A and B, The worst data is Antenna A ,only shown Antenna A Plot.

Mode	Frequency	Measured Power Density (dBm)	Measured Power Density (dBm)	Limit (dBm)	Result
		Antenna A	Antenna B		
802.11 a	5180 MHz	4.085	3.857	11	PASS
	5200 MHz	3.069	2.789	11	PASS
	5240 MHz	3.102	2.867	11	PASS
802.11 n20	5180 MHz	2.278	1.975	11	PASS
	5200 MHz	3.848	3.532	11	PASS
	5240 MHz	2.656	2.254	11	PASS
802.11 n40	5190 MHz	-0.333	-1.345	11	PASS
	5230 MHz	-1.488	-2.018	11	PASS
802.11 AC20	5180 MHz	2.763	2.336	11	PASS
	5200 MHz	3.340	2.567	11	PASS
	5240 MHz	3.034	2.844	11	PASS
802.11 AC40	5190 MHz	1.115	1.016	11	PASS
	5230 MHz	-0.781	-1.245	11	PASS
802.11 AC80	5210 MHz	-2.902	-3.687	11	PASS

Note: The wireless module is 1x1 Wi-Fi support 802.11b / g / n / ac; does not support MIMO

(802.11a) PSD plot on channel 36



(802.11n20) PSD plot on channel 36



(802.11a) PSD plot on channel 40



(802.11n20) PSD plot on channel 40

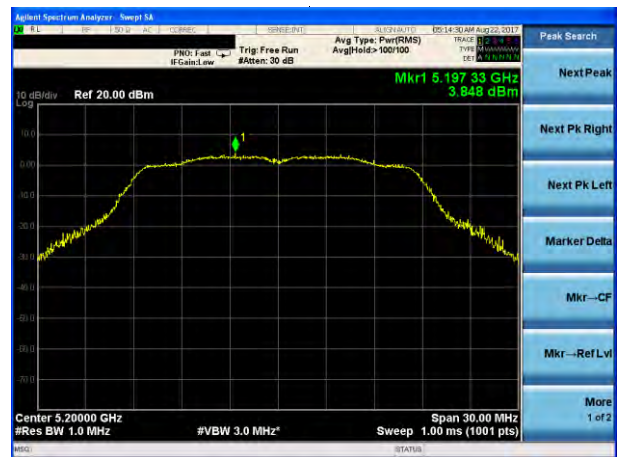

(802.11a) PSD plot on channel 48

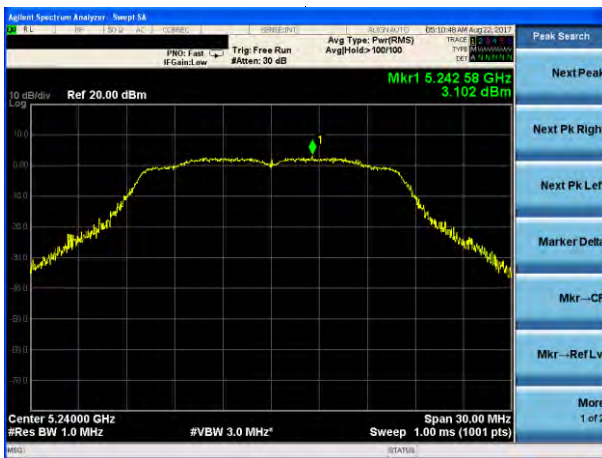

(802.11n20) PSD plot on channel 48



(802.11n40) PSD plot on channel 38



(802.11ac20) PSD plot on channel 36

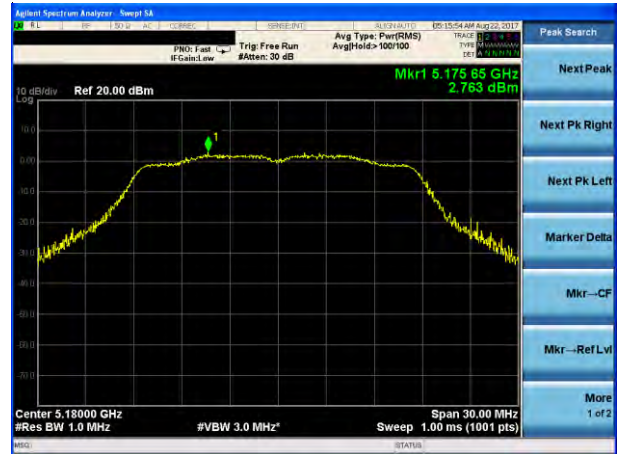

(802.11n40) PSD plot on channel 46



(802.11ac20) PSD plot on channel 40

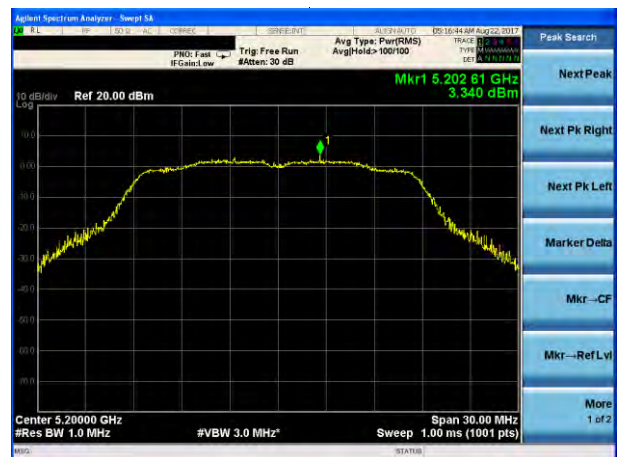

(802.11ac20) PSD plot on channel 48



(802.11ac40) PSD plot on channel 38

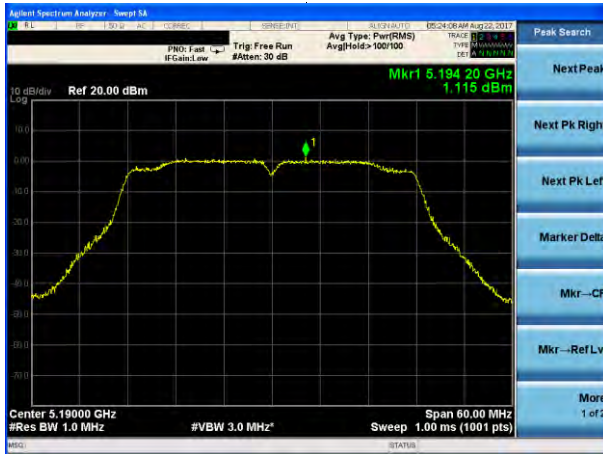

(802.11ac80) PSD plot on channel 42



(802.11ac40) PSD plot on channel 46



EUT :	notebook	Model Name. :	DTLAPY133-1
Temperature :	25 °C	Relative Humidity :	56%
Pressure :	1015 hPa	Test Voltage :	DC 7.4V
Test Mode :	TX Frequency Band IV (5745-5825MHz)		

Note: A(B) Represent the value of antenna A and B, The worst data is Antenna A ,only shown Antenna A Plot.

Mode	Frequency	Measured Power Density (dBm)	Measured Power Density (dBm)	Limit (dBm)	Result
		Antenna A	Antenna B		
802.11 a	5745 MHz	4.935	5.138	30	PASS
	5785 MHz	5.677	5.577	30	PASS
	5825 MHz	5.733	6.680	30	PASS
802.11 n20	5745 MHz	3.207	1.340	30	PASS
	5785 MHz	4.576	2.864	30	PASS
	5825 MHz	5.361	3.429	30	PASS
802.11 n40	5755 MHz	-0.019	-0.473	30	PASS
	5795 MHz	1.517	1.257	30	PASS
802.11 AC20	5745 MHz	3.796	1.207	30	PASS
	5785 MHz	5.631	3.218	30	PASS
	5825 MHz	5.572	4.032	30	PASS
802.11 AC40	5755 MHz	0.185	-0.427	30	PASS
	5795 MHz	1.847	1.151	30	PASS
802.11 AC80	5775 MHz	-0.414	-3.210	30	PASS

Note: The wireless module is 1x1 Wi-Fi support 802.11b / g / n / ac; does not support MIMO

(802.11a) PSD plot on channel 149



(802.11n20) PSD plot on channel 149

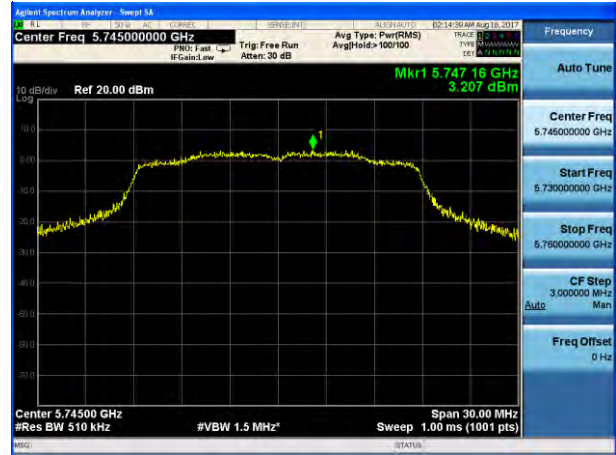

(802.11a) PSD plot on channel 157

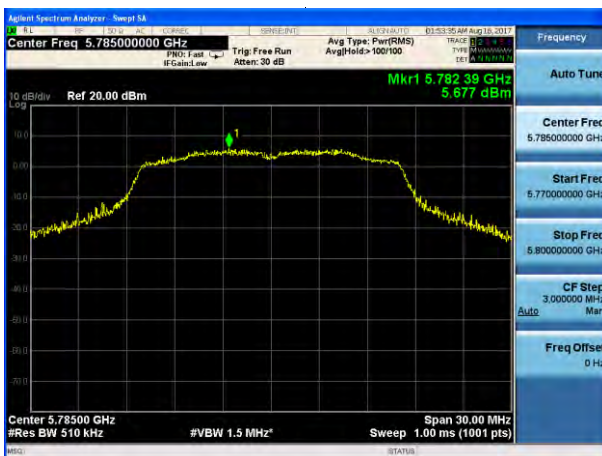

(802.11n20) PSD plot on channel 157



(802.11a) PSD plot on channel 165



(802.11n20) PSD plot on channel 165



(802.11n40) PSD plot on channel 151



(802.11ac20) PSD plot on channel 149



(802.11n40) PSD plot on channel 159

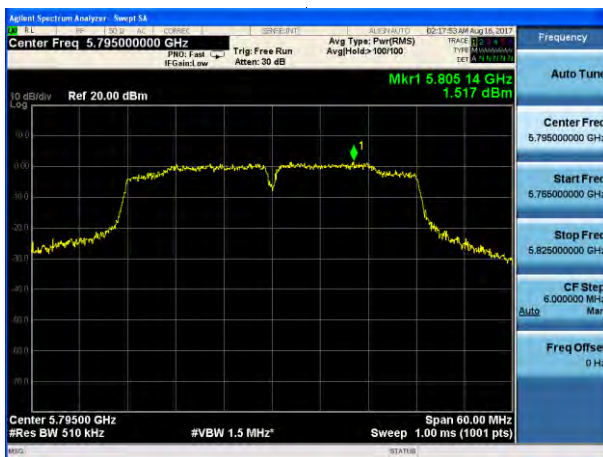

(802.11ac20) PSD plot on channel 157

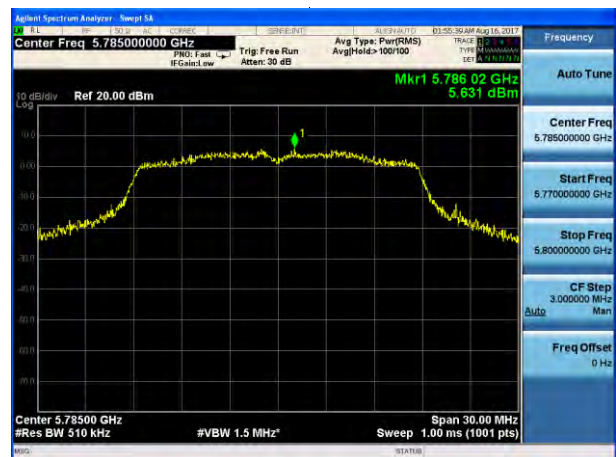

(802.11ac20) PSD plot on channel 165



(802.11ac40) PSD plot on channel 151



(802.11ac80) PSD plot on channel 155



(802.11ac40) PSD plot on channel 159



5. 26DB & 99% EMISSION BANDWIDTH

5.1 APPLIED PROCEDURES / LIMIT

The maximum power spectral density is measured as a conducted emission by direct connection of a calibrated test instrument to the equipment under test. If the device cannot be connected directly, alternative techniques acceptable to the Commission may be used. Measurements in the 5.725-5.85 GHz band are made over a reference bandwidth of 500 kHz or the 26 dB emission bandwidth of the device, whichever is less. Measurements in the 5.15-5.25 GHz, 5.25-5.35 GHz, and the 5.47-5.725 GHz bands are made over a bandwidth of 1 MHz or the 26 dB emission bandwidth of the device, whichever is less. A narrower resolution bandwidth can be used, provided that the measured power is integrated over the full reference bandwidth.

5.2 TEST PROCEDURE

- a) Set RBW = approximately 1% of the emission bandwidth.
- b) Set the VBW > RBW.
- c) Detector = Peak.
- d) Trace mode = max hold.
- e) Measure the maximum width of the emission that is 26 dB down from the maximum of the emission. Compare this with the RBW setting of the analyzer. Readjust RBW and repeat measurement as needed until the RBW/EBW ratio is approximately 1%.

The following procedure shall be used for measuring (99 %) power bandwidth:

1. Set center frequency to the nominal EUT channel center frequency.
2. Set span = 1.5 times to 5.0 times the OBW.
3. Set RBW = 1 % to 5 % of the OBW
4. Set VBW $\geq 3 \cdot$ RBW
5. Video averaging is not permitted. Where practical, a sample detection and single sweep mode shall be used. Otherwise, peak detection and max hold mode (until the trace stabilizes) shall be used.
6. Use the 99 % power bandwidth function of the instrument (if available).
7. If the instrument does not have a 99 % power bandwidth function, the trace data points are recovered and directly summed in power units. The recovered amplitude data points, beginning at the lowest frequency, are placed in a running sum until 0.5 % of the total is reached; that frequency is recorded as the lower frequency. The process is repeated until 99.5 % of the total is reached; that frequency is recorded as the upper frequency. The 99% occupied bandwidth is the difference between these two frequencies.

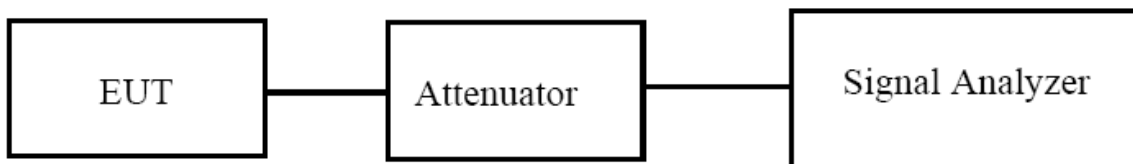

5.3 EUT OPERATION CONDITIONS

The EUT tested system was configured as the statements of 2.4 Unless otherwise a special operating condition is specified in the follows during the testing.

5.4 TEST RESULTS

EUT :	notebook	Model Name. :	DTLAPY133-1
Temperature :	25 °C	Relative Humidity :	56%
Pressure :	1012 hPa	Test Voltage :	DC 7.4V
Test Mode :	TX Frequency Band I (5150-5250MHz)		

Note: A(B) Represent the value of antenna A and B, The worst data is Antenna A, only shown Antenna A Plot.

Mode	Channel	Frequency (MHz)	99% bandwidth(MHz)	99% bandwidth(MHz)	26dB bandwidth (MHz)	26dB bandwidth (MHz)	Result
			Antenna A	Antenna B	Antenna A	Antenna B	
802.11a	CH36	5180	17.213	16.855	28.78	26.51	Pass
	CH40	5200	16.985	16.896	27.48	27.02	Pass
	CH48	5240	16.901	16.726	26.91	24.82	Pass
802.11 n20	CH36	5180	18.145	17.741	29.46	22.95	Pass
	CH40	5200	18.013	17.703	28.19	22.91	Pass
	CH48	5240	17.978	17.748	28.57	23.35	Pass
802.11 n40	CH 38	5190	36.200	36.017	50.39	40.80	Pass
	CH 46	5230	36.133	36.026	46.83	41.41	Pass
802.11 AC20	CH36	5180	18.121	17.725	29.22	22.50	Pass
	CH40	5200	18.030	17.726	27.56	22.67	Pass
	CH48	5240	17.938	17.704	26.44	23.30	Pass
802.11 AC40	CH 38	5190	36.195	35.968	51.77	40.93	Pass
	CH 46	5230	36.143	35.965	45.99	41.21	Pass
802.11 AC80	CH 42	5210	76.844	75.229	120.0	80.02	Pass

Test plot

(802.11a) -26dB&99%Bandwidth plot on channel 36



(802.11 n20) -26dB&99%Bandwidth plot on channel 36



(802.11a) -26dB&99%Bandwidth plot on channel 40



(802.11 n20) -26dB&99%Bandwidth plot on channel 40

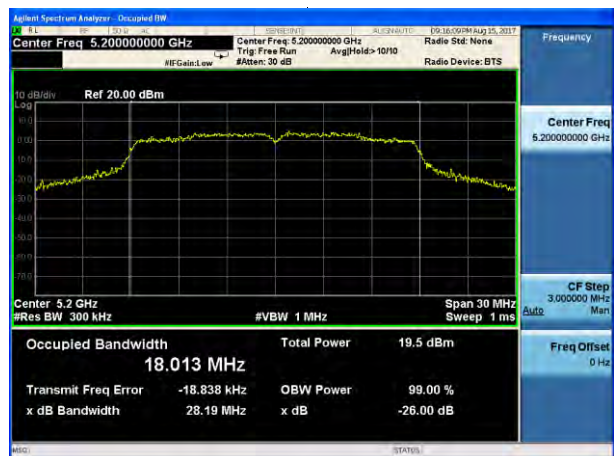

(802.11a) -26dB&99%Bandwidth plot on channel 48

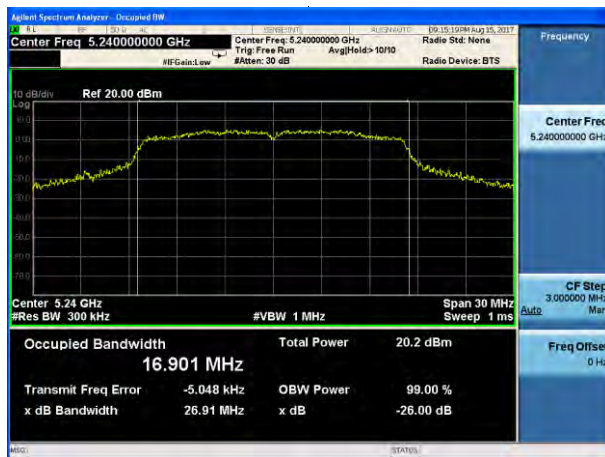

(802.11 n20) -26dB&99%Bandwidth plot on channel 48

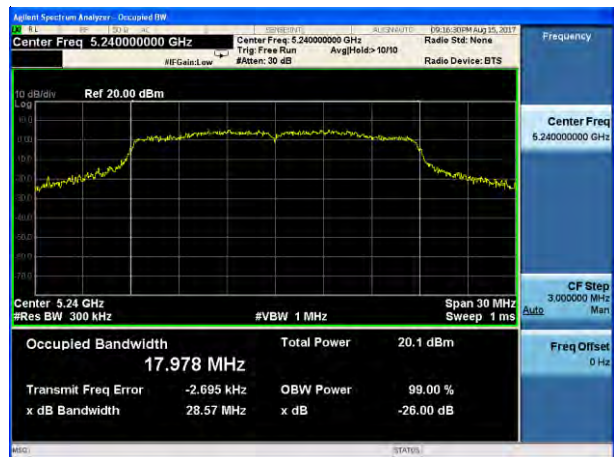

Test plot

(802.11 n40) -26dB&99%Bandwidth plot on channel 38



(802.11 AC20) -26dB&99%Bandwidth plot on channel 36



(802.11 n40) -26dB&99%Bandwidth plot on channel 46



(802.11 AC20) -26dB&99%Bandwidth plot on channel 40

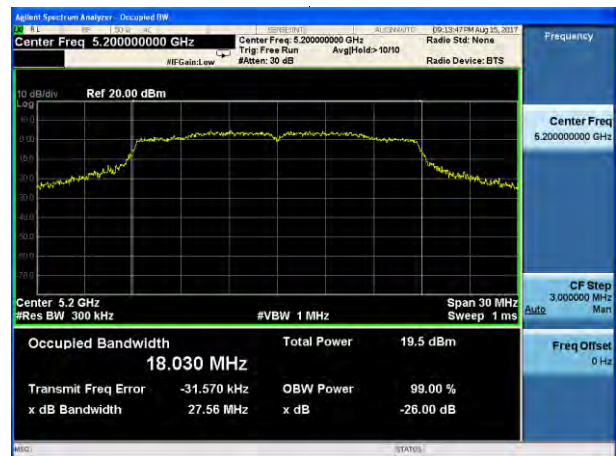

(802.11 AC20) -26dB&99%Bandwidth plot on channel 48



Test plot

(802.11 AC40) -26dB&99%Bandwidth plot on channel 38

(802.11 AC80) -26dB&99%Bandwidth plot on channel 42



(802.11 AC40) -26dB&99%Bandwidth plot on channel 46



EUT :	notebook	Model Name. :	DTLAPY133-1
Temperature :	25 °C	Relative Humidity :	56%
Pressure :	1012 hPa	Test Voltage :	DC 7.4V
Test Mode :	TX Frequency Band IV(5745-5850MHz)		

Note: A(B) Represent the value of antenna A and B, The worst data is Antenna A, only shown Antenna A Plot.

Mode	Channel	Frequency (MHz)	99% bandwidth(MHz)	99% bandwidth(MHz)	26dB bandwidth (MHz)	26dB bandwidth (MHz)	Result
			Antenna A	Antenna B	Antenna A	Antenna B	
802.11a	CH149	5745	16.969	18.634	28.63	30.00	Pass
	CH157	5785	16.928	17.277	27.11	29.19	Pass
	CH165	5825	16.952	17.513	27.71	29.09	Pass
802.11 n20	CH149	5745	18.076	17.746	29.00	22.76	Pass
	CH157	5785	17.997	17.753	28.46	22.15	Pass
	CH165	5825	18.033	17.741	27.91	22.20	Pass
802.11 n40	CH151	5755	36.245	36.047	52.91	40.90	Pass
	CH159	5795	36.190	36.022	51.14	41.21	Pass
802.11 AC20	CH149	5745	18.071	17.761	26.96	22.07	Pass
	CH157	5785	18.012	17.734	27.18	22.47	Pass
	CH165	5825	18.047	17.765	29.24	22.29	Pass
802.11 AC40	CH151	5755	36.192	36.037	50.28	43.57	Pass
	CH159	5795	36.164	35.995	53.67	41.26	Pass
802.11 AC80	CH155	5775	78.105	75.632	120.0	120.0	Pass

Test plot

(802.11a) -26dB&99%Bandwidth plot on channel 149

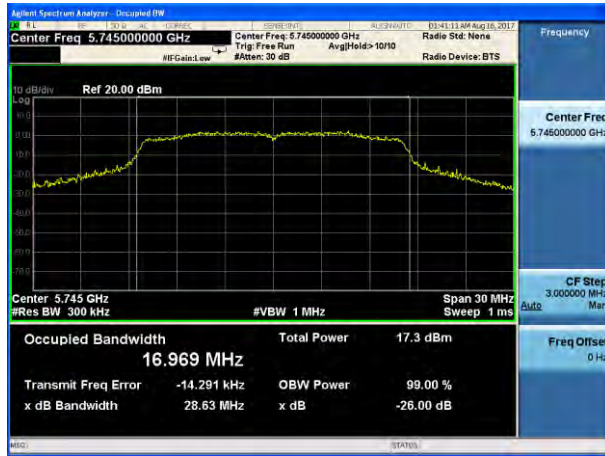

(802.11 n20) -26dB&99%Bandwidth plot on channel 149



(802.11a) -26dB&99%Bandwidth plot on channel 157



(802.11 n20) -26dB&99%Bandwidth plot on channel 157



(802.11a) -26dB&99%Bandwidth plot on channel 165

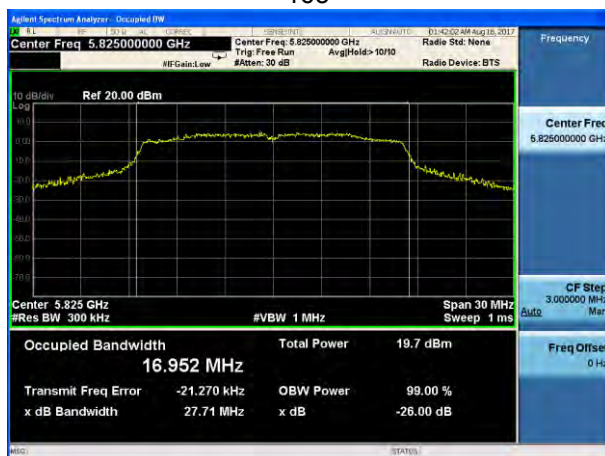

(802.11 n20) -26dB&99%Bandwidth plot on channel 165

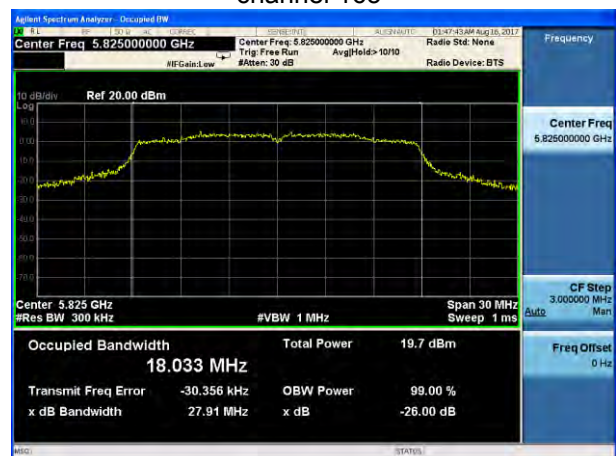

Test plot

(802.11 n40) -26dB&99%Bandwidth plot on channel 151

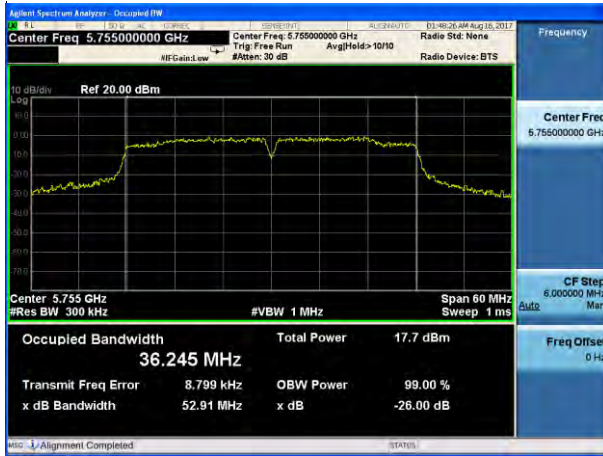

(802.11 AC20) -26dB&99%Bandwidth plot on channel 149



(802.11 n40) -26dB&99%Bandwidth plot on channel 159

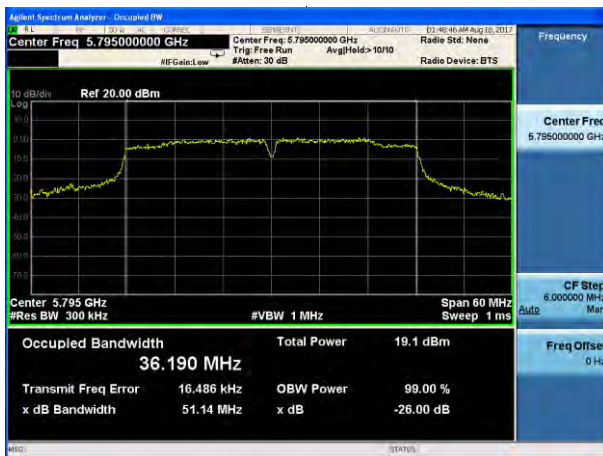

(802.11 AC20) -26dB&99%Bandwidth plot on channel 157

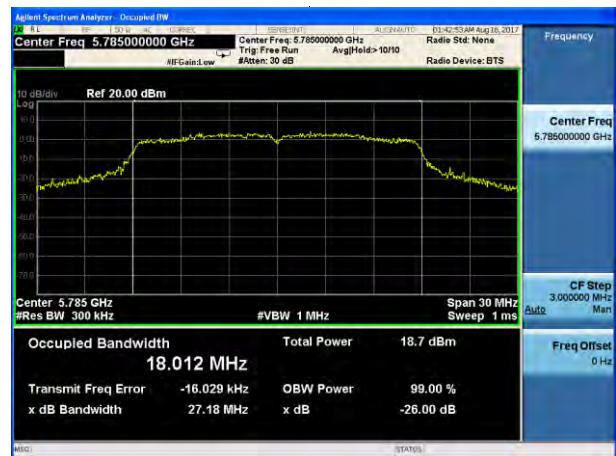

(802.11 AC20) -26dB&99%Bandwidth plot on channel 165



Test plot

(802.11 AC40) -26dB&99%Bandwidth plot on channel 151

(802.11 AC80) -26dB&99%Bandwidth plot on channel 155

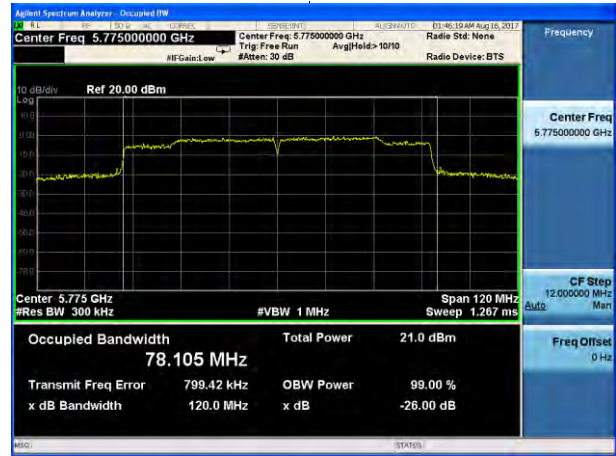

(802.11 AC40) -26dB&99%Bandwidth plot on channel 159



6. MINIMUM 6 DB BANDWIDTH

6.1 APPLIED PROCEDURES / LIMIT

According to FCC §15.407(e)

(e) Within the 5.725-5.85 GHz band, the minimum 6 dB bandwidth of U-NII devices shall be at least 500 kHz.

6.2 TEST PROCEDURE

Section 15.407(e) specifies the minimum 6 dB emission bandwidth of at least 500 KHz for the band 5.715-5.85 GHz. The following procedure shall be used for measuring this bandwidth:

- a) Set RBW = 100 kHz.
- b) Set the video bandwidth (VBW) $\geq 3 \times$ RBW.
- c) Detector = Peak.
- d) Trace mode = max hold.
- e) Sweep = auto couple.
- f) Allow the trace to stabilize.
- g) Measure the maximum width of the emission that is constrained by the frequencies associated with the two outermost amplitude points (upper and lower frequencies) that are attenuated by 6 dB relative to the maximum level measured in the fundamental emission.

6.3 DEVIATION FROM STANDARD

No deviation.

6.4 TEST SETUP

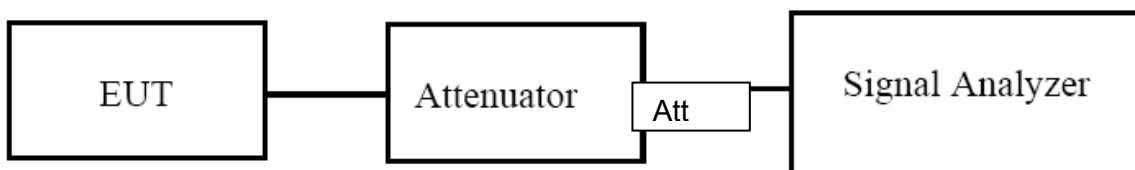

6.5 EUT OPERATION CONDITIONS

The EUT tested system was configured as the statements of 2.4 Unless otherwise a special operating condition is specified in the follows during the testing.

6.6 TEST RESULTS

EUT :	notebook	Model Name. :	DTLAPY133-1
Temperature :	25 °C	Relative Humidity :	56%
Pressure :	1012 hPa	Test Voltage :	DC 7.4V
Test Mode :	TX Frequency Band I (5150-5250MHz)		

Note: A(B) Represent the value of antenna A and B, The worst data is Antenna A, only shown Antenna A Plot.

Mode	Channel	Frequency (MHz)	6dB bandwidth (MHz)	6dB bandwidth (MHz)	Limit (KHz)	Result
			Antenna A	Antenna B		
802.11a	CH36	5180	15.06	15.15	$\cong 500$	Pass
	CH40	5200	13.91	15.09	$\cong 500$	Pass
	CH48	5240	15.12	13.90	$\cong 500$	Pass
802.11 n20	CH36	5180	15.97	15.14	$\cong 500$	Pass
	CH40	5200	15.18	15.05	$\cong 500$	Pass
	CH48	5240	15.15	13.19	$\cong 500$	Pass
802.11 n40	CH 38	5190	35.13	35.17	$\cong 500$	Pass
	CH 46	5230	35.16	35.15	$\cong 500$	Pass
802.11 AC20	CH36	5180	14.98	15.04	$\cong 500$	Pass
	CH40	5200	15.14	15.59	$\cong 500$	Pass
	CH48	5240	15.07	15.13	$\cong 500$	Pass
802.11 AC40	CH 38	5190	35.18	35.18	$\cong 500$	Pass
	CH 46	5230	35.16	35.09	$\cong 500$	Pass
802.11 AC80	CH 42	5210	75.25	75.29	$\cong 500$	Pass

Test plot

(802.11a) 6dB Bandwidth plot on channel 36



(802.11 n20) 6dB Bandwidth plot on channel 36



(802.11a) 6dB Bandwidth plot on channel 40



(802.11 n20) 6dB Bandwidth plot on channel 40

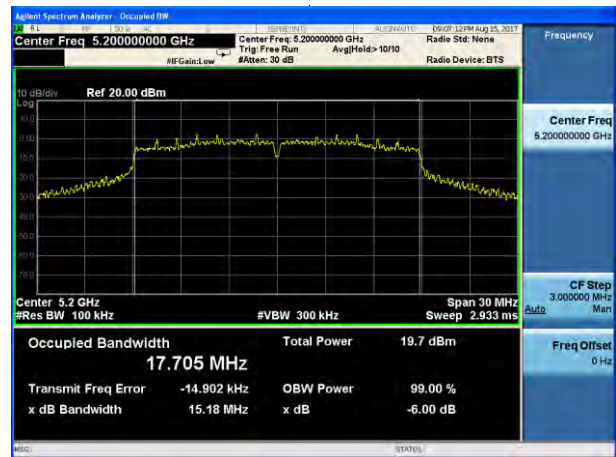

(802.11a) 6dB Bandwidth plot on channel 48

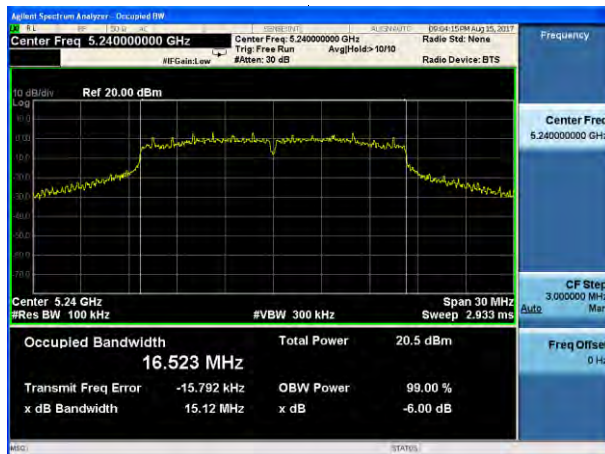

(802.11 n20) 6dB Bandwidth plot on channel 48

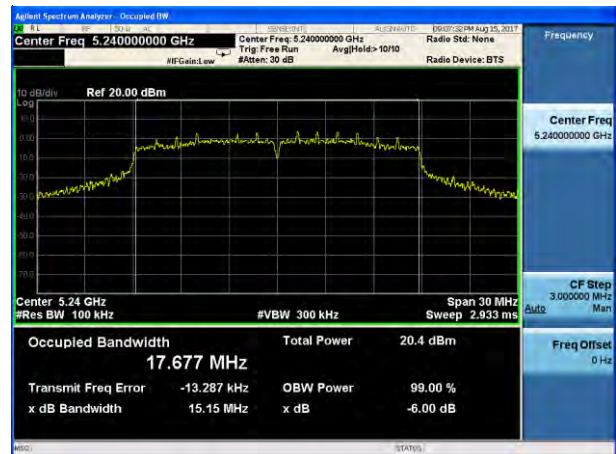

Test plot

(802.11 n40) 6dB Bandwidth plot on channel 38



(802.11 AC20) 6dB Bandwidth plot on channel 36

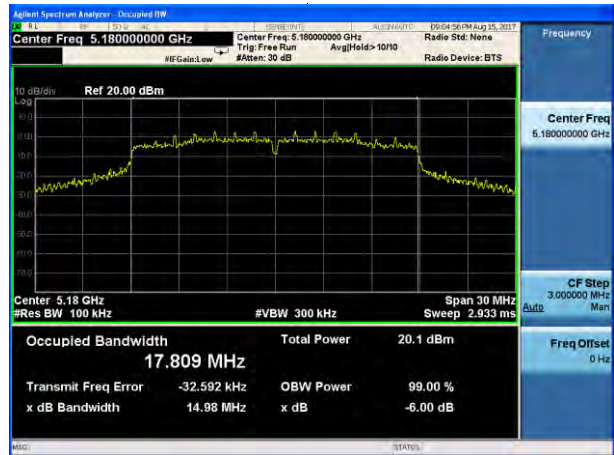

(802.11 n40) 6dB Bandwidth plot on channel 46

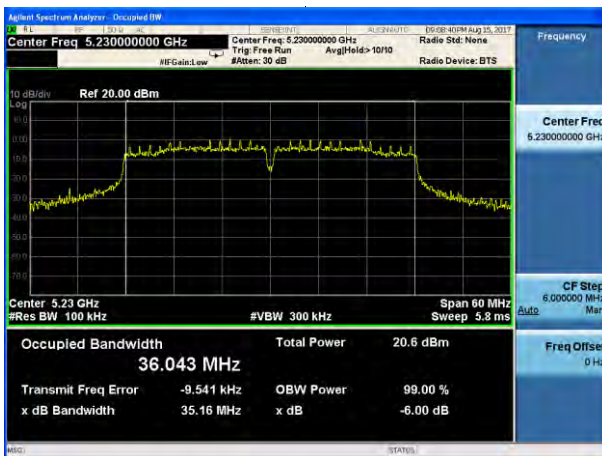

(802.11 AC20) 6dB Bandwidth plot on channel 40

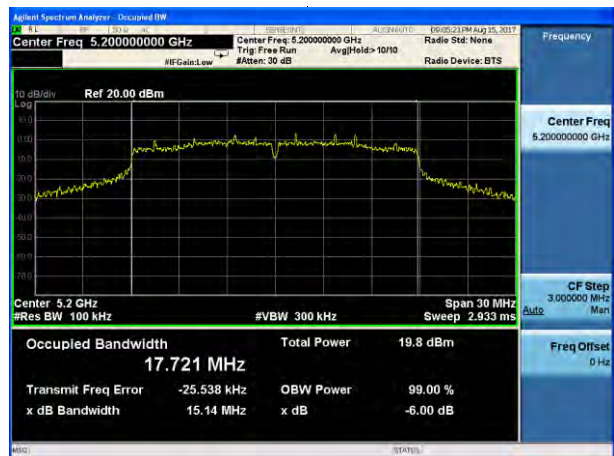

(802.11 AC20) 6dB Bandwidth plot on channel 48

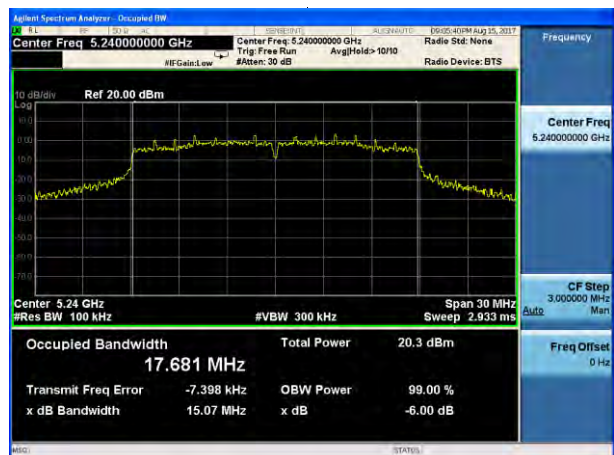

Test plot

(802.11 AC40) 6dB Bandwidth plot on channel 38

(802.11 AC80) 6dB Bandwidth plot on channel 42

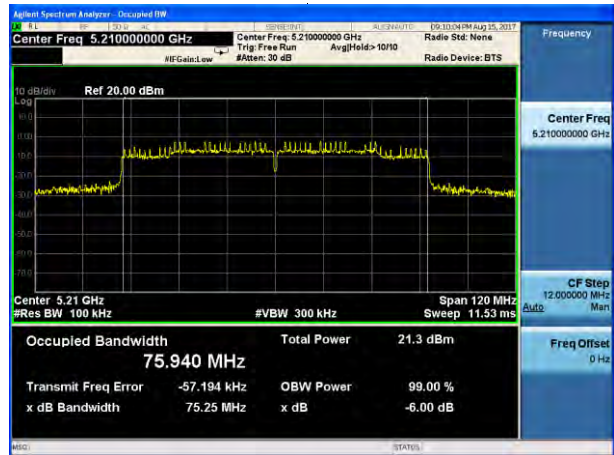

(802.11 AC40) 6dB Bandwidth plot on channel 46

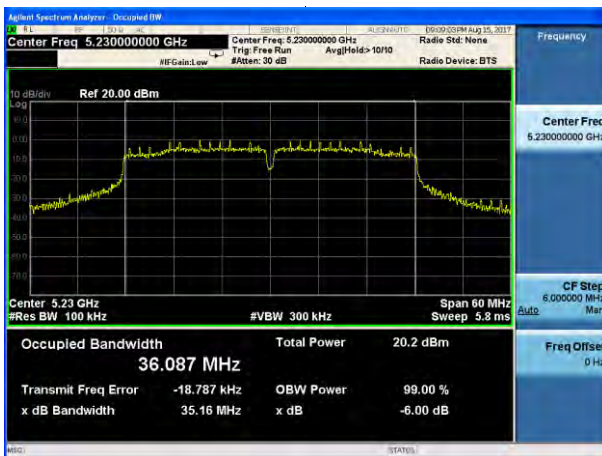

EUT :	notebook	Model Name. :	DTLAPY133-1
Temperature :	25 °C	Relative Humidity :	60%
Pressure :	1012 hPa	Test Voltage :	DC 7.4V
Test Mode :	TX (5G) Mode Frequency Band IV (5725-5825MHz)		

Note: A(B) Represent the value of antenna A and B, The worst data is Antenna B ,only shown Antenna B Plot.

Mode	Channel	Frequency (MHz)	-6dB bandwidth (MHz)		Limit (KHz)	Result
			Antenna A	Antenna B		
802.11a	149	5745	15.14	15.15	$\cong 500$	Pass
	157	5785	15.14	15.12	$\cong 500$	Pass
	165	5825	15.14	15.30	$\cong 500$	Pass
802.11 n20	149	5745	15.03	15.15	$\cong 500$	Pass
	157	5785	13.92	15.01	$\cong 500$	Pass
	165	5825	14.99	15.16	$\cong 500$	Pass
802.11 n40	151	5755	33.86	35.14	$\cong 500$	Pass
	159	5795	35.12	35.17	$\cong 500$	Pass
802.11 AC20	149	5745	15.15	15.12	$\cong 500$	Pass
	157	5785	15.07	15.11	$\cong 500$	Pass
	165	5825	15.16	15.16	$\cong 500$	Pass
802.11 AC40	149	5745	35.12	35.04	$\cong 500$	Pass
	157	5785	35.14	35.20	$\cong 500$	Pass
802.11 AC80	155	5775	75.24	75.27	$\cong 500$	Pass

Test plot

(802.11a) 6dB Bandwidth plot on channel 149

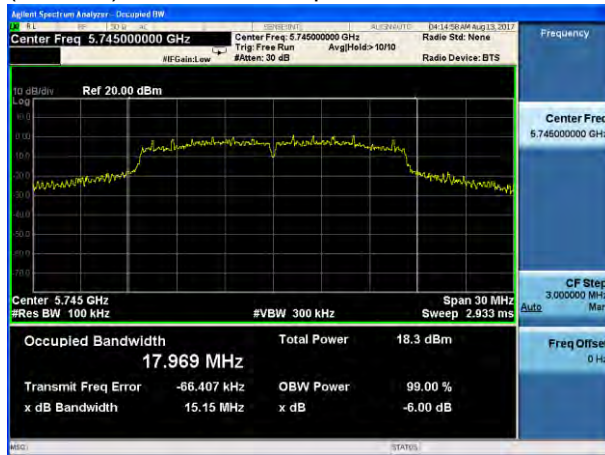

(802.11 n20) 6dB Bandwidth plot on channel 149



(802.11a) 6dB Bandwidth plot on channel 157

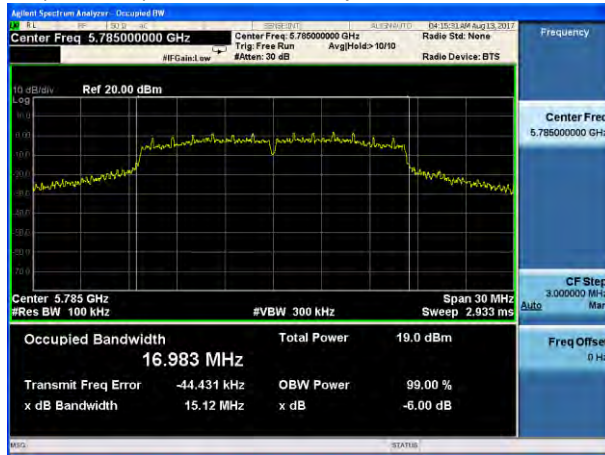

(802.11 n20) 6dB Bandwidth plot on channel 157

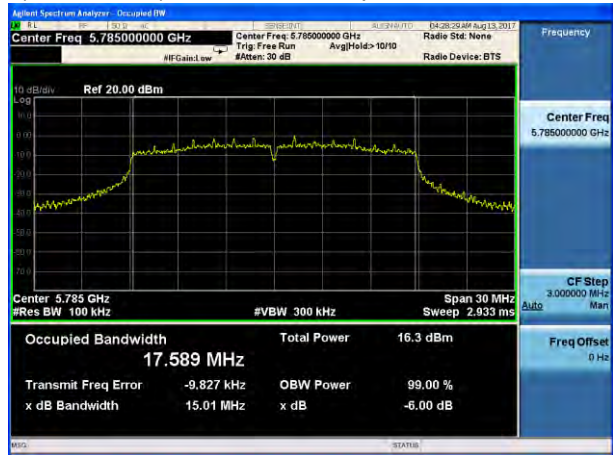

(802.11a) 6dB Bandwidth plot on channel 165

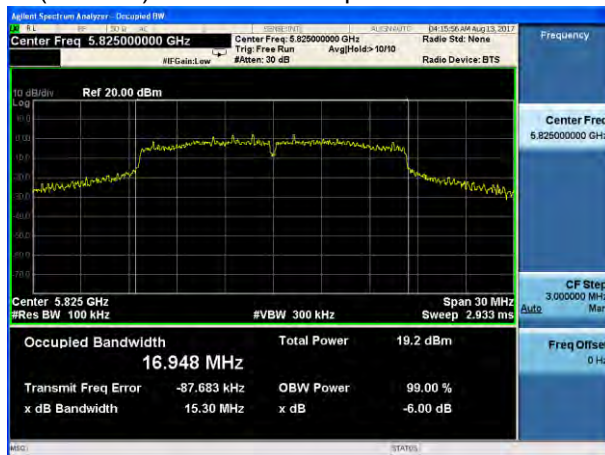

(802.11 n20) 6dB Bandwidth plot on channel 165

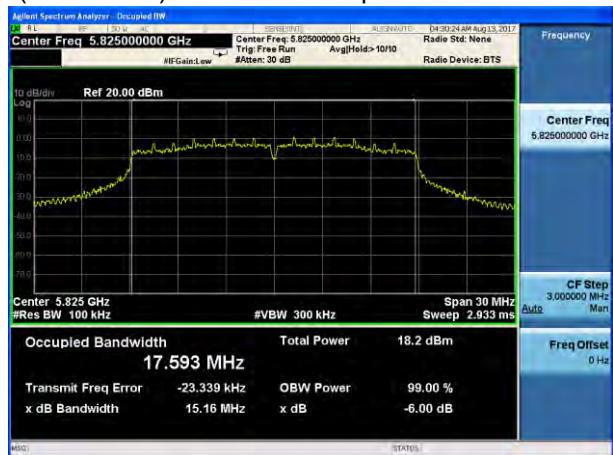

Test plot

(802.11 n40) 6dB Bandwidth plot on channel 151

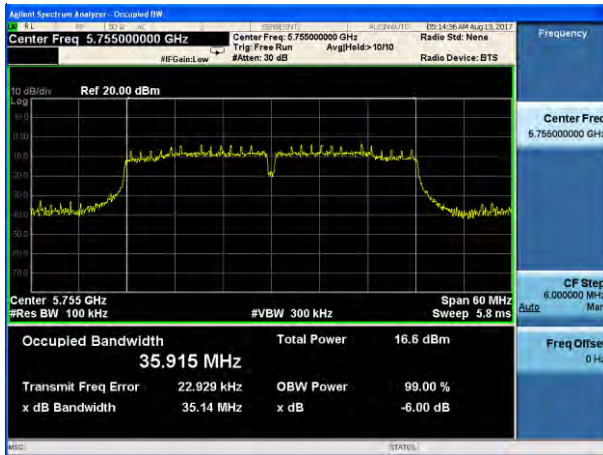

(802.11 AC20) 6dB Bandwidth plot on channel 149



(802.11 n40) 6dB Bandwidth plot on channel 159

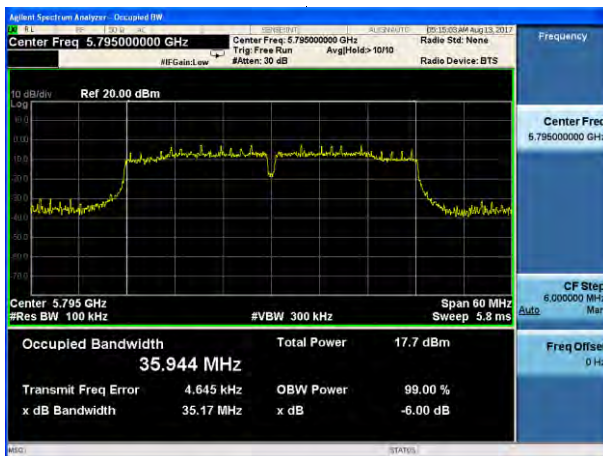

(802.11 AC20) 6dB Bandwidth plot on channel 157



(802.11 AC20) 6dB Bandwidth plot on channel 165

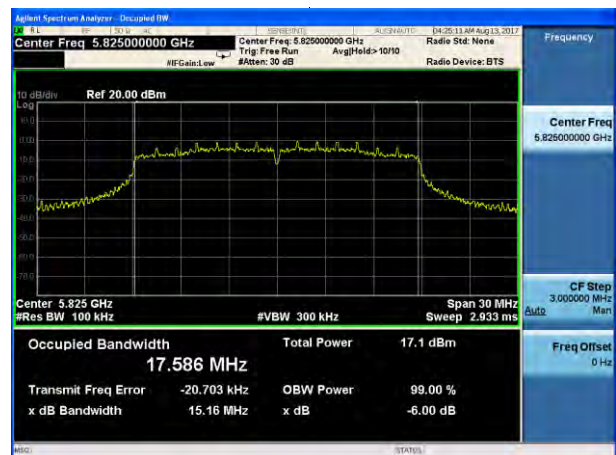

Test plot

(802.11 AC40) 6dB Bandwidth plot on channel 151

(802.11 AC80) 6dB Bandwidth plot on channel 155

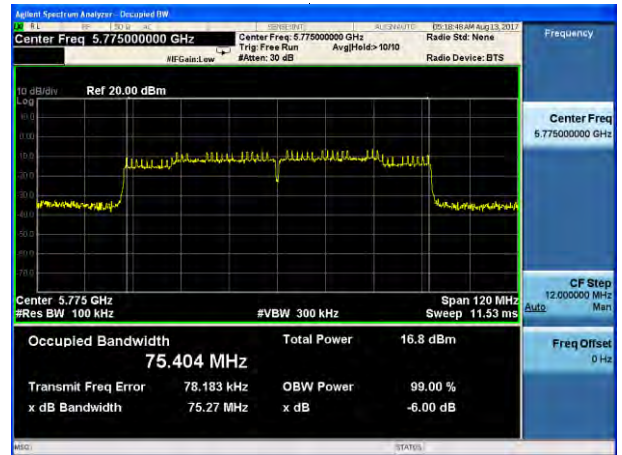
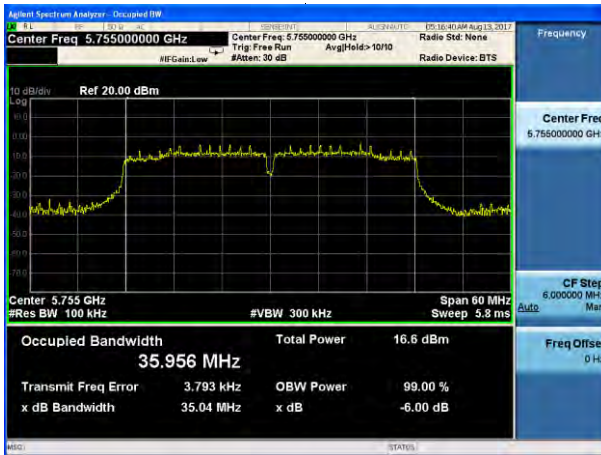

(802.11 AC40) 6dB Bandwidth plot on channel 159

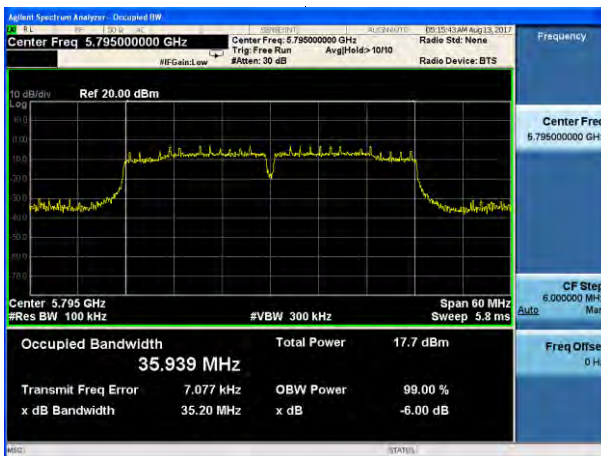

7. MAXIMUM CONDUCTED OUTPUT POWER

7.1 PPLIED PROCEDURES / LIMIT

According to FCC §15.407

The maximum conducted output power should not exceed:

Frequency Band(MHz)	Limit
5150~5250	250mW
5725~5850	1W

The maximum e.i.r.p should not exceed:

Frequency Band(MHz)	Limit
5150~5250	200mW or 10dBm +10logB whichever is less
5725~5850	N/A

Note: Where "B" is the 99% emission bandwidth in MHz

7.2 TEST PROCEDURE

· Maximum conducted output power may be measured using a spectrum analyzer/EMI receiver or an RF power meter.

1. Device Configuration

If possible, configure or modify the operation of the EUT so that it transmits continuously at its maximum power control level (see section II.B.).

a) The intent is to test at 100 percent duty cycle; however a small reduction in duty cycle (to no lower than 98 percent) is permitted if required by the EUT for amplitude control purposes. Manufacturers are expected to provide software to the test lab to permit such continuous operation.

b) If continuous transmission (or at least 98 percent duty cycle) cannot be achieved due to hardware limitations (e.g., overheating), the EUT shall be operated at its maximum power control level with the transmit duration as long as possible and the duty cycle as high as possible.

2. Measurement using a Spectrum Analyzer or EMI Receiver (SA)

Measurement of maximum conducted output power using a spectrum analyzer requires integrating the spectrum across a frequency span that encompasses, at a minimum, either the EBW or the 99-percent occupied bandwidth of the signal.¹ However, the EBW must be used to determine bandwidth dependent limits on maximum conducted output power in accordance with § 15.407(a).

a) The test method shall be selected as follows: (i) Method SA-1 or SA-1 Alternative (averaging with the EUT transmitting at full power throughout each sweep) shall be applied if either of the following conditions can be satisfied:

- The EUT transmits continuously (or with a duty cycle ≥ 98 percent).
- Sweep triggering or gating can be implemented in a way that the device transmits at the maximum power control level throughout the duration of each of the instrument sweeps to be averaged. This condition can generally be achieved by triggering the instrument's sweep if the duration of the sweep (with the analyzer configured as in Method SA-1, below) is equal to or shorter than the duration T of each transmission from the EUT and if those transmissions exhibit full power throughout their durations.

(ii) Method SA-2 or SA-2 Alternative (averaging across on and off times of the EUT transmissions, followed by duty cycle correction) shall be applied if the conditions of (i) cannot be achieved and the transmissions exhibit a constant duty cycle during the measurement duration. Duty cycle will be considered to be constant if variations are less than ± 2 percent.

(iii) Method SA-3 (RMS detection with max hold) or SA-3 Alternative (reduced VBW with max hold) shall be applied if the conditions of (i) and (ii) cannot be achieved.

b) Method SA-1 (trace averaging with the EUT transmitting at full power throughout each sweep): (i) Set span to encompass the entire emission bandwidth (EBW) (or, alternatively, the entire 99% occupied bandwidth) of the signal.

(ii) Set RBW = 1 MHz.

(iii) Set VBW ≥ 3 MHz.

(iv) Number of points in sweep ≥ 2 Span / RBW. (This ensures that bin-to-bin spacing is \leq RBW/2, so that narrowband signals are not lost between frequency bins.)

(v) Sweep time = auto.

(vi) Detector = RMS (i.e., power averaging), if available. Otherwise, use sample detector mode.

(vii) If transmit duty cycle < 98 percent, use a video trigger with the trigger level set to enable triggering only on full power pulses. Transmitter must operate at maximum power control level for the entire duration of every sweep. If the EUT transmits continuously (i.e., with no off intervals) or at duty cycle ≥ 98 percent, and if each transmission is entirely at the maximum power control level, then the trigger shall be set to "free run".

(viii) Trace average at least 100 traces in power averaging (i.e., RMS) mode.

(ix) Compute power by integrating the spectrum across the EBW (or, alternatively, the entire 99% occupied bandwidth) of the signal using the instrument's band power measurement function with band limits set equal to the EBW (or occupied bandwidth) band edges. If the instrument does not have a band power function, sum the spectrum

7.3 DEVIATION FROM STANDARD

No deviation.

7.4 TEST SETUP

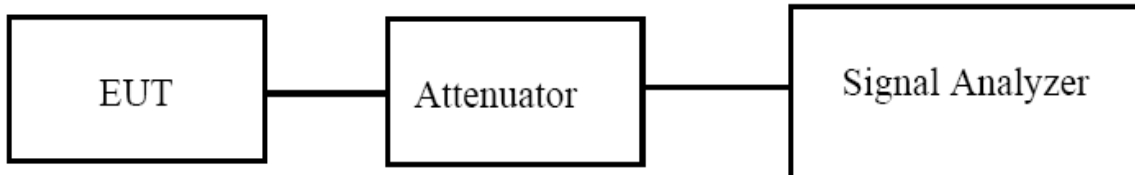

7.5 EUT OPERATION CONDITIONS

The EUT tested system was configured as the statements of 2.4 Unless otherwise a special operating condition is specified in the follows during the testing.

7.6 TEST RESULTS

EUT :	notebook	Model Name. :	DTLAPY133-1
Temperature :	25 °C	Relative Humidity :	60%
Pressure :	1012 hPa	Test Voltage :	DC 7.4V
Test Mode :	TX (5G) Mode Frequency Band I (5150-5250MHz)		

Test Channel	Frequency (MHz)	Maximum output power. Antenna port (AV)	Maximum output power. Antenna port (AV)	LIMIT dBm	Result
		(dBm) Antenna A	(dBm) Antenna B		
TX 802.11a Mode					
CH36	5180	10.1	10.0	23.98	Pass
CH40	5200	10.5	10.2	23.98	Pass
CH48	5240	9.6	9.7	23.98	Pass
TX 802.11 n20M Mode					
CH36	5180	9.6	9.5	23.98	Pass
CH40	5200	10.0	9.7	23.98	Pass
CH48	5240	9.8	9.4	23.98	Pass
TX 802.11 n40M Mode					
CH38	5190	9.9	10.3	23.98	Pass
CH46	5230	9.7	9.8	23.98	Pass
TX 802.11 AC20M Mode					
CH36	5180	9.8	10.2	23.98	Pass
CH40	5200	10.2	10.5	23.98	Pass
CH48	5240	9.4	9.5	23.98	Pass
TX 802.11 AC40M Mode					
CH38	5190	10.1	9.6	23.98	Pass
CH46	5230	9.6	9.3	23.98	Pass
TX 802.11 AC80M Mode					
CH42	5210	9.4	9.7	23.98	Pass

Note: The wireless module is 1x1 Wi-Fi support 802.11a / g / n / ac; does not support MIMO

EUT :	notebook	Model Name. :	DTLAPY133-1
Temperature :	25 °C	Relative Humidity :	60%
Pressure :	1012 hPa	Test Voltage :	DC 7.4V
Test Mode :	TX (5G) Mode Frequency Band IV (5725-5825MHz)		

Test Channel	Frequency (MHz)	Maximum output power. Antenna port (AV)	Maximum output power. Antenna port (AV)	LIMIT dBm	Result
		(dBm) Antenna A	(dBm) Antenna B		
TX 802.11a Mode					
CH 149	5745	10.9	10.4	30	Pass
CH 157	5785	10.1	10.9	30	Pass
CH 165	5825	10.4	10.0	30	Pass
TX 802.11 n20M Mode					
CH 149	5745	10.8	10.5	30	Pass
CH 157	5785	10.1	10.7	30	Pass
CH 165	5825	10.4	10.6	30	Pass
TX 802.11 n40M Mode					
CH 151	5755	10.8	10.3	30	Pass
CH 159	5795	10.2	10.0	30	Pass
TX 802.11 AC20M Mode					
CH 149	5745	10.8	10.4	30	Pass
CH 157	5785	10.1	10.7	30	Pass
CH 165	5825	10.4	10.5	30	Pass
TX 802.11 AC40M Mode					
CH 151	5755	10.7	10.5	30	Pass
CH 159	5795	10.1	10.1	30	Pass
TX 802.11 AC80M Mode					
CH 155	5775	9.7	10.0	30	Pass

Note: The wireless module is 1x1 Wi-Fi support 802.11 a / g / n / ac; does not support MIMO

8. OUT OF BAND EMISSIONS

8.1 APPLICABLE STANDARD

According to FCC §15.407(b)

Undesirable emission limits. Except as shown in paragraph (b)(7) of this section, the maximum emissions outside of the frequency bands of operation shall be attenuated in accordance with the following limits:

(1) For transmitters operating in the 5.15-5.25 GHz band: All emissions outside of the 5.15-5.35 GHz band shall not exceed an e.i.r.p. of -27 dBm/MHz.

(2) For transmitters operating in the 5.725-5.85 GHz band: All emissions within the frequency range from the band edge to 10 MHz above or below the band edge shall not exceed an e.i.r.p. of -17 dBm/MHz; for frequencies 10 MHz or greater above or below the band edge, emissions shall not exceed an e.i.r.p. of -27 dBm/MHz.

8.2 TEST PROCEDURE

1. Check the calibration of the measuring instrument using either an internal calibrator or a known signal from an external generator.
2. Position the EUT without connection to measurement instrument. Turn on the EUT and connect its antenna terminal to measurement instrument via a low loss cable. Then set it to any one measured frequency within its operating range, and make sure the instrument is operated in its linear range.
3. Set RBW of spectrum analyzer to 1 MHz with a convenient frequency span.
4. Measure the highest amplitude appearing on spectral display and set it as a reference level. Plot the graph with marking the highest point and edge frequency.
5. Repeat above procedures until all measured frequencies were complete.

8.3 DEVIATION FROM STANDARD

No deviation.

8.4 TEST SETUP

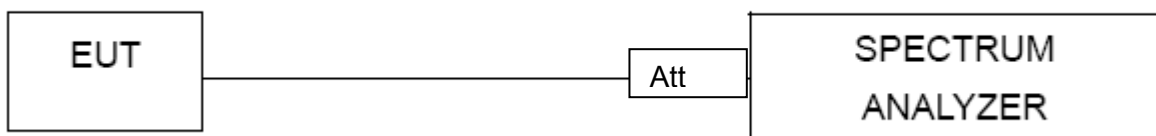

8.5 EUT OPERATION CONDITIONS

The EUT tested system was configured as the statements of 2.4 Unless otherwise a special operating condition is specified in the follows during the testing.

8.6 TEST RESULTS

EUT :	notebook	Model Name. :	DTLAPY133-1
Temperature :	25 °C	Relative Humidity :	56%
Pressure :	1012 hPa	Test Voltage :	DC 7.4V

Note: A(B) Represent the value of antenna A and B, The worst data is Antenna A ,only shown Antenna A Plot.

5.2G

5.15~5.25 GHz

(802.11a) Band Edge, Left Side

(802.11n20) Band Edge, Left Side

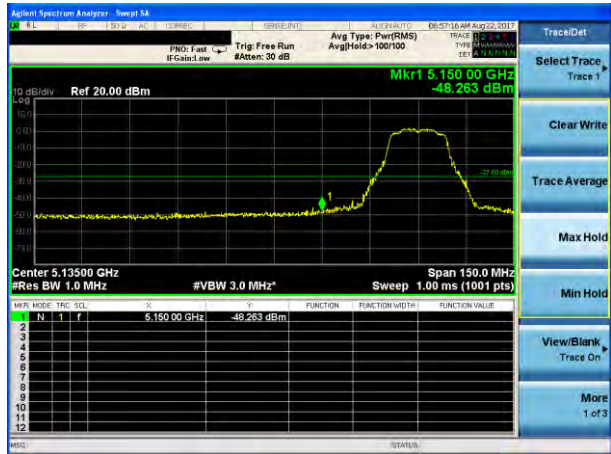
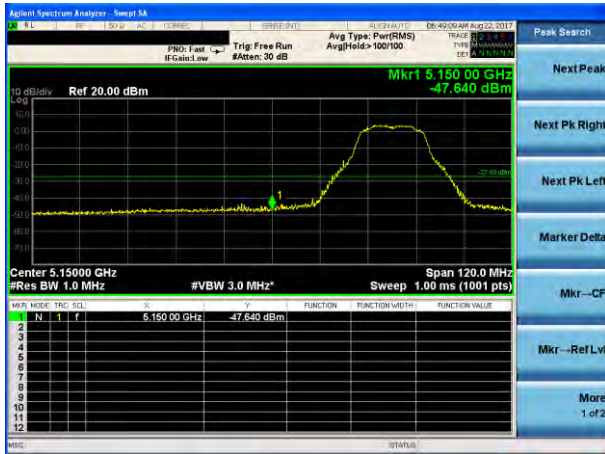

(802.11a) Band Edge, Right Side

(802.11n20) Band Edge, Right Side

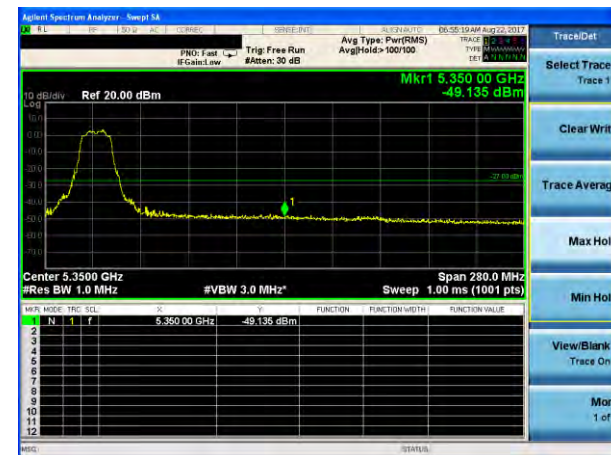
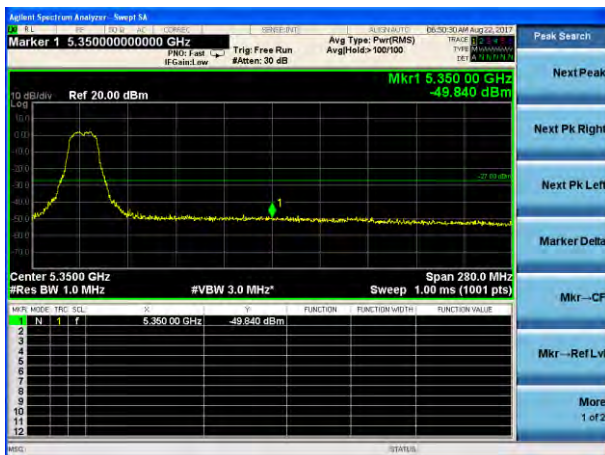

5.15~5.25 GHz

(802.11n40) Band Edge, Left Side

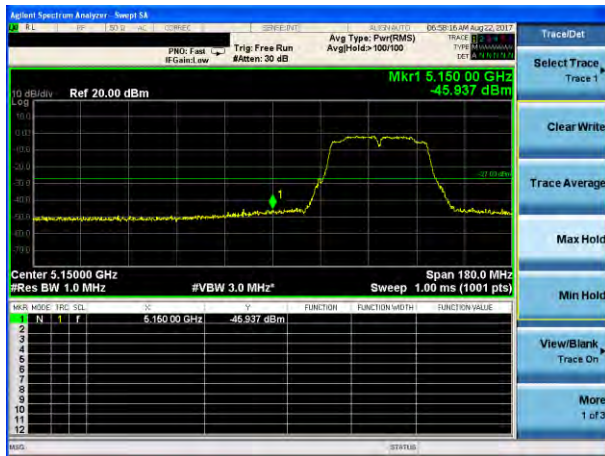

(802.11ac20) Band Edge, Left Side

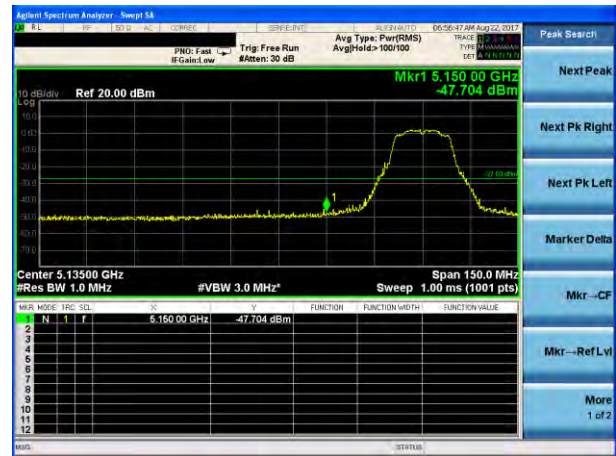

(802.11n40) Band Edge, Right Side

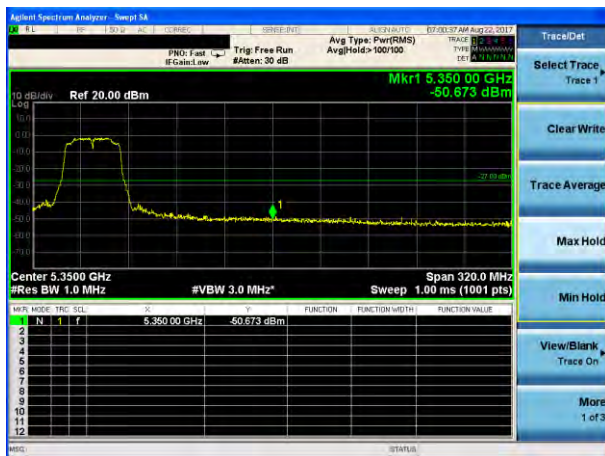

(802.11ac20) Band Edge, Right Side

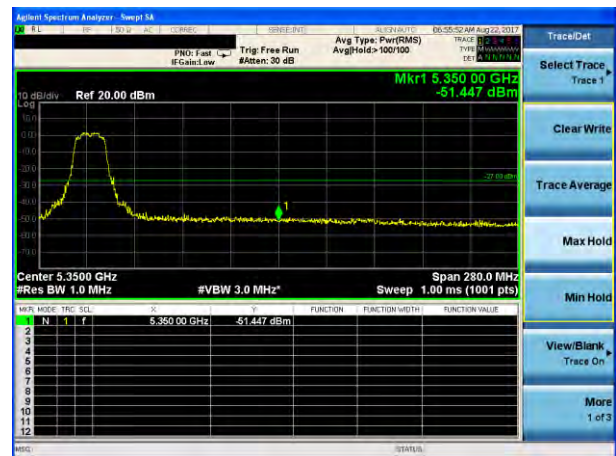

5.15~5.25 GHz

(802.11ac40) Band Edge, Left Side

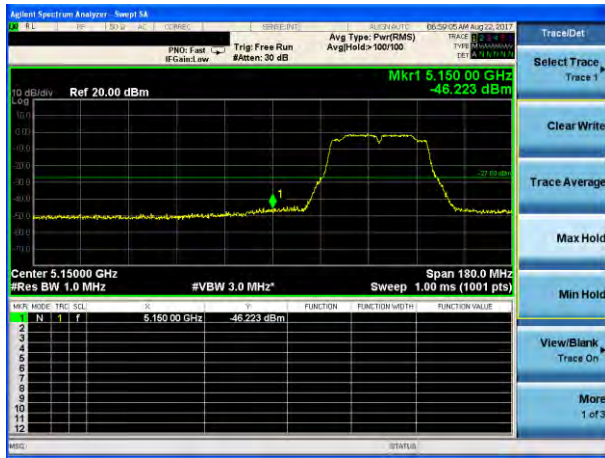

(802.11ac80) Band Edge, Left Side

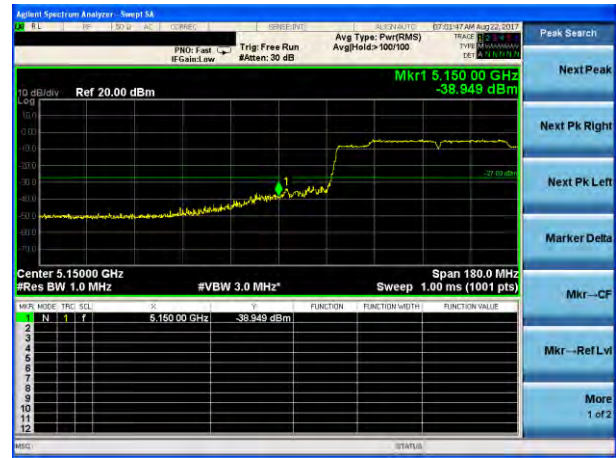

(802.11ac40) Band Edge, Right Side

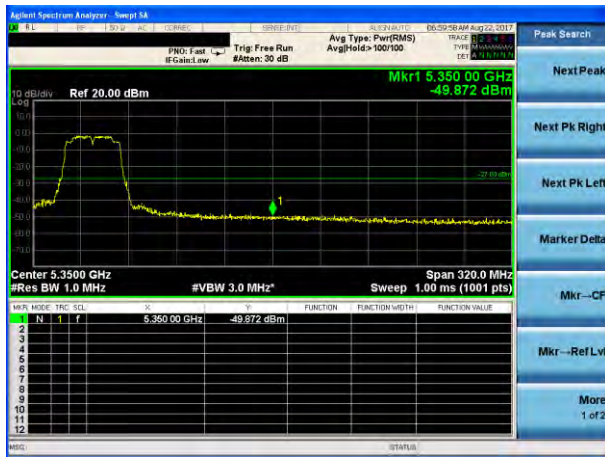

(802.11ac80) Band Edge, Right Side

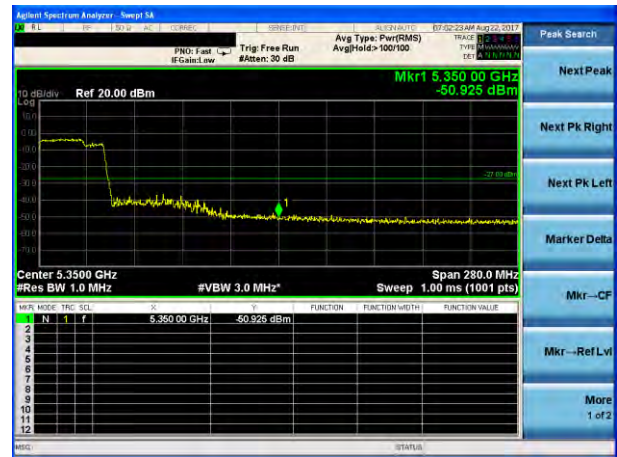

5.8G

5.75~5.85 GHz

(802.11a) Band Edge, Left Side

(802.11n20) Band Edge, Left Side

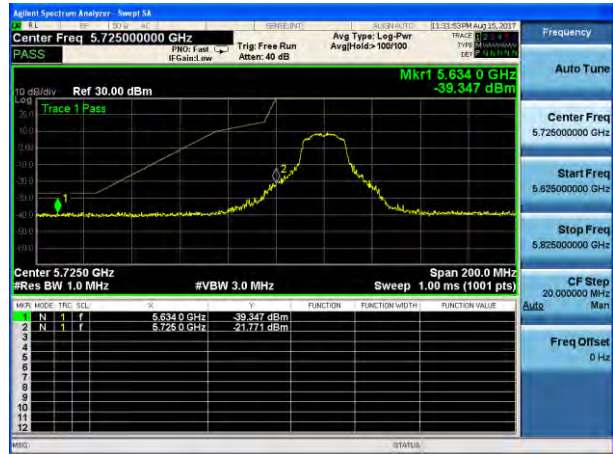
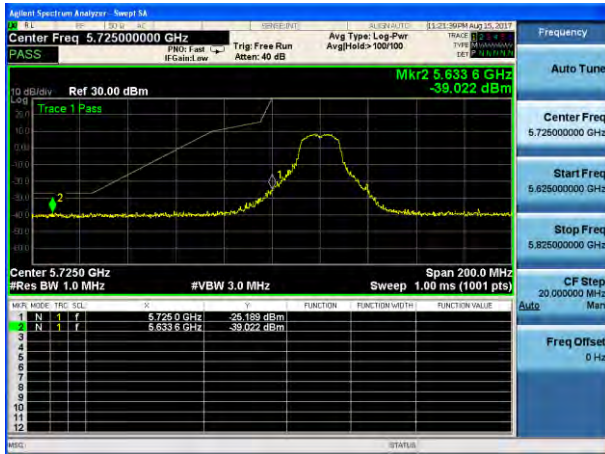

(802.11a) Band Edge, Right Side

(802.11n20) Band Edge, Right Side

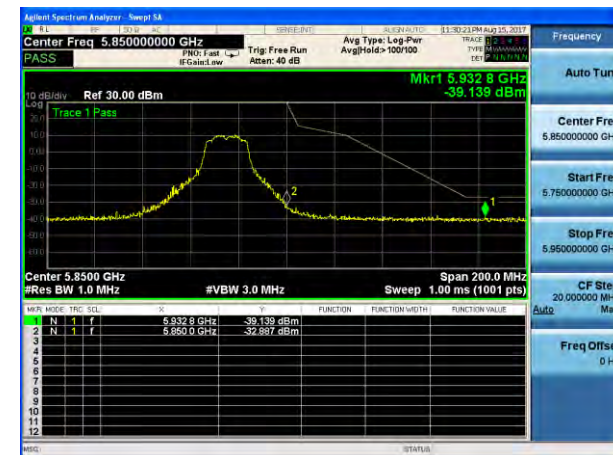
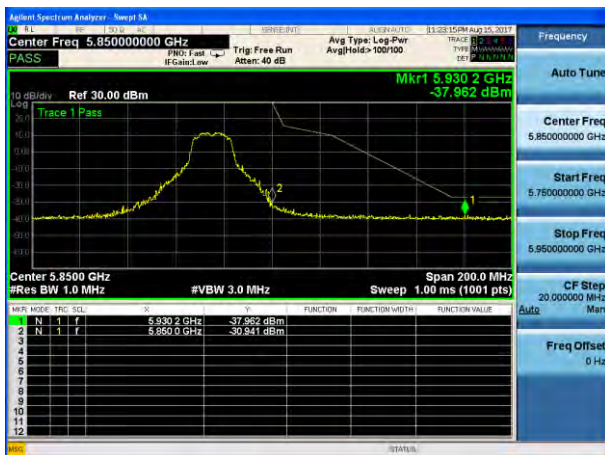

5.75~5.85 GHz

(802.11n40) Band Edge, Left Side



(802.11ac20) Band Edge, Left Side

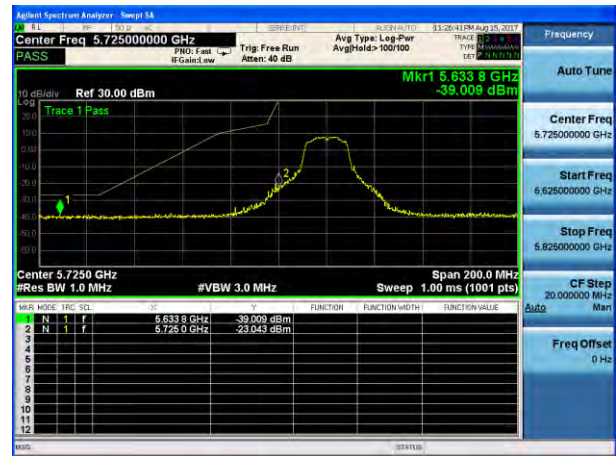

(802.11n40) Band Edge, Right Side



(802.11ac20) Band Edge, Right Side

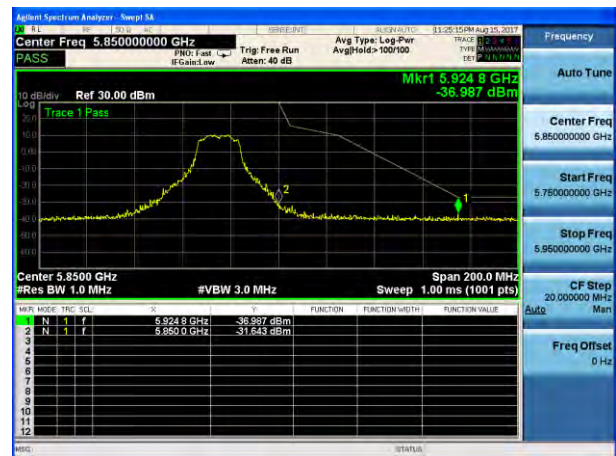

5.75~5.83 GHz

(802.11ac40) Band Edge, Left Side



(802.11ac80) Band Edge, Left Side



(802.11ac40) Band Edge, Right Side

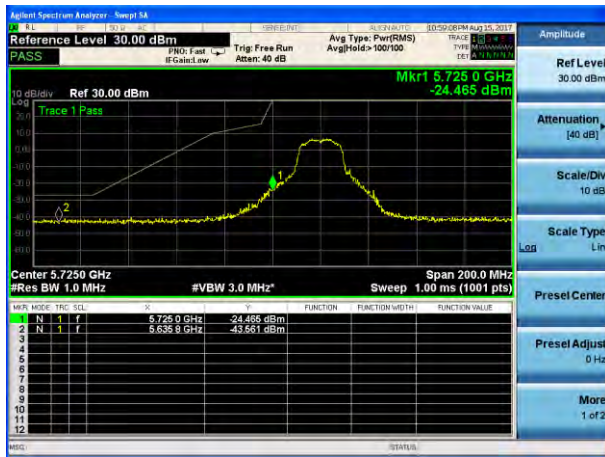

(802.11ac80) Band Edge, Right Side



9.SPURIOUS RF CONDUCTED EMISSIONS

9.1CONFORMANCE LIMIT

1. Below -20dB of the highest emission level in operating band.
2. Fall in the restricted bands listed in section 15.205. The maximum permitted average field strength is listed in section 15.209.

9.2MEASURING INSTRUMENTS

The Measuring equipment is listed in the section 6.3 of this test report.

9.3TEST SETUP

Please refer to Section 6.1 of this test report.

9.4TEST PROCEDURE

The Spurious RF conducted emissions compliance of RF radiated emission should be measured by following the guidance in ANSI C63.10-2013 with respect to maximizing the emission by rotating the EUT, measuring the emission while the EUT is situated in three orthogonal planes (if appropriate), adjusting the measurement antenna height and polarization etc. Set RBW=100kHz and VBW= 300KHz to measure the peak field strength , and mwasure frequeny range from 9KHz to 26.5GHz.

9.5TEST RESULTS

Remark: The measurement frequency range is from 9KHz to the 10th harmonic of the fundamental frequency. The lowest, middle and highest channels are tested to verify the spurious emissions and bandege measurement data.

Note: A(B) Represent the value of antenna A and B, The worst data is Antenna A ,only shown Antenna A Plot.

5.2G

Test Plot

802.11a on channel 36



802.11a on channel 40



802.11a on channel 36



802.11a on channel 40



Test Plot

802.11a on channel 48



802.11n20 on channel 36

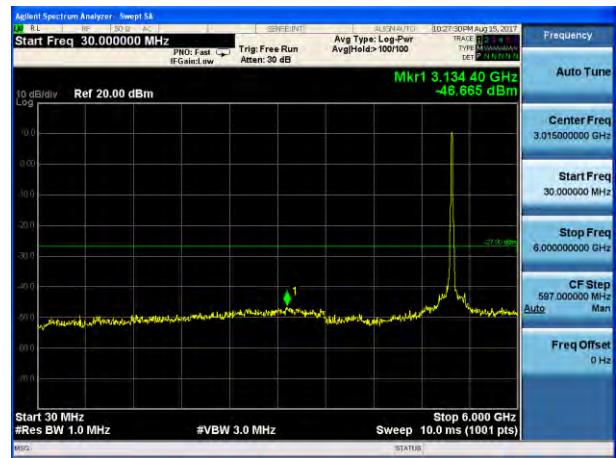

802.11a on channel 48



802.11n20 on channel 36



Test Plot

802.11n20 on channel 40

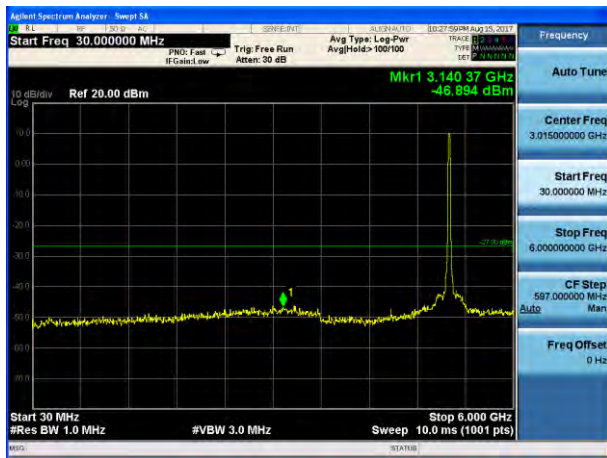

802.11n20 on channel 48



802.11n20 on channel 40



802.11n20 on channel 48



Test Plot

802.11n40 on channel 38

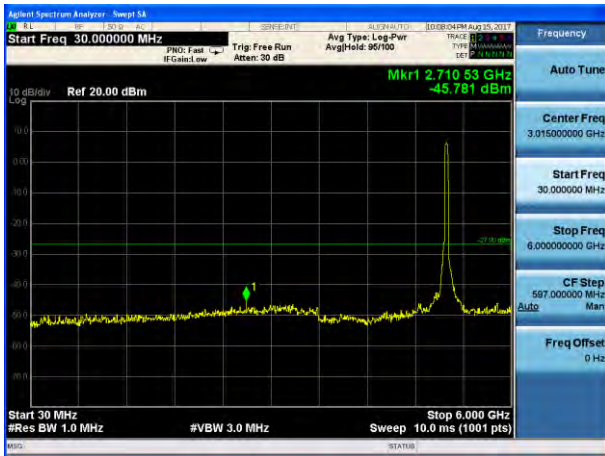

802.11n40 on channel 46



802.11n40 on channel 38



802.11n40 on channel 46



Test Plot

802.11ac20 on channel 36



802.11ac20 on channel 40



802.11ac20 on channel 36



802.11ac20 on channel 40



Test Plot

802.11ac20 on channel 48

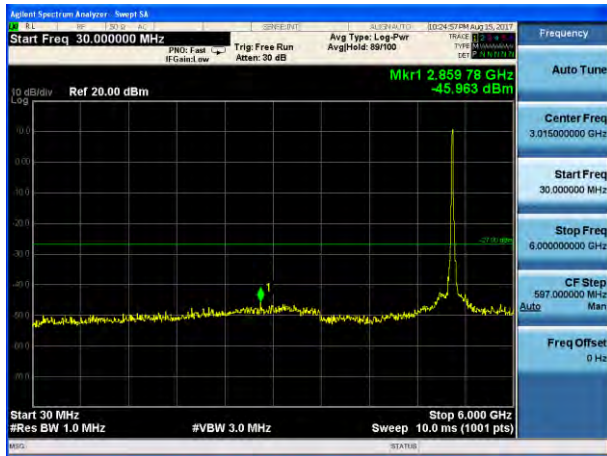

802.11ac40 on channel 38

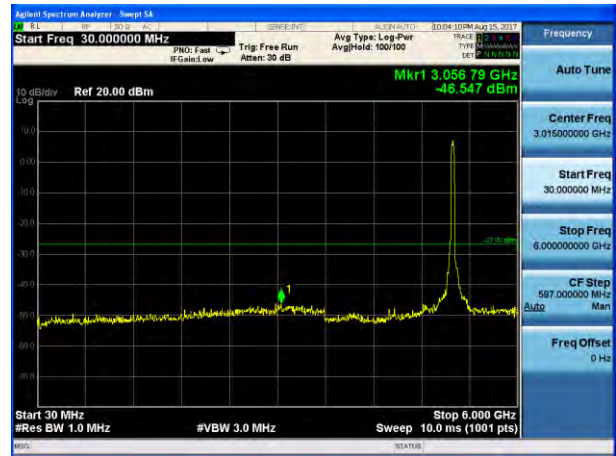

802.11ac20 on channel 48



802.11ac40 on channel 38



Test Plot

802.11ac40 on channel 46

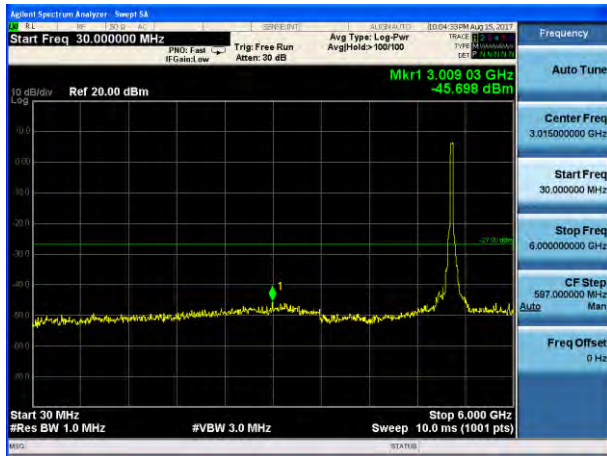

802.11ac80 on channel 42

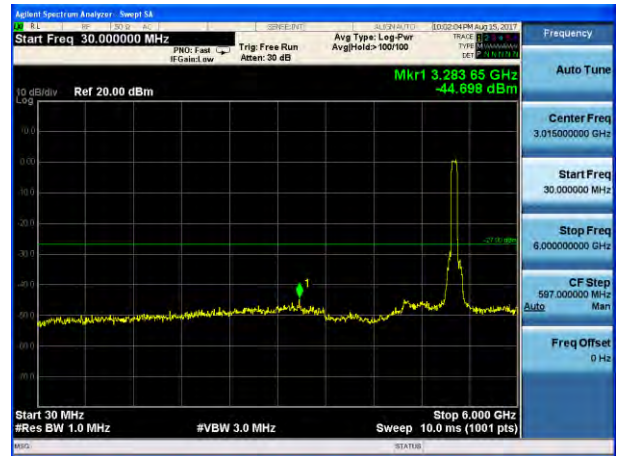

802.11 ac40 on channel 46



802.11 ac80 on channel 42



5.8G Test Plot

802.11a on channel 149



802.11a on channel 157



802.11a on channel 149



802.11a on channel 157



Test Plot

802.11a on channel 165



802.11n20 on channel 149



802.11a on channel 165



802.11n20 on channel 149



Test Plot

802.11n20 on channel 157



802.11n20 on channel 165

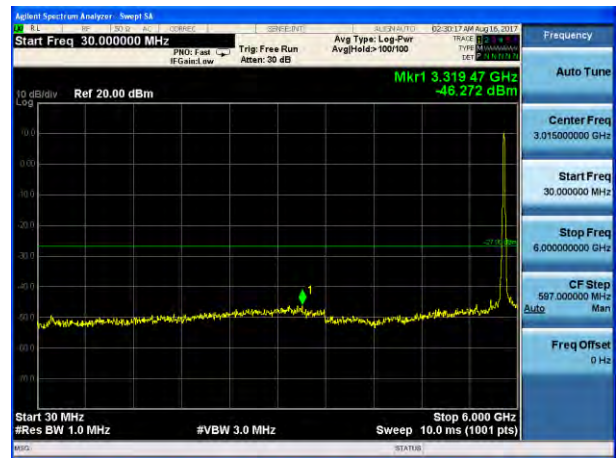

802.11n20 on channel 157



802.11n20 on channel 165



Test Plot

802.11n40 on channel 151



802.11n40 on channel 159

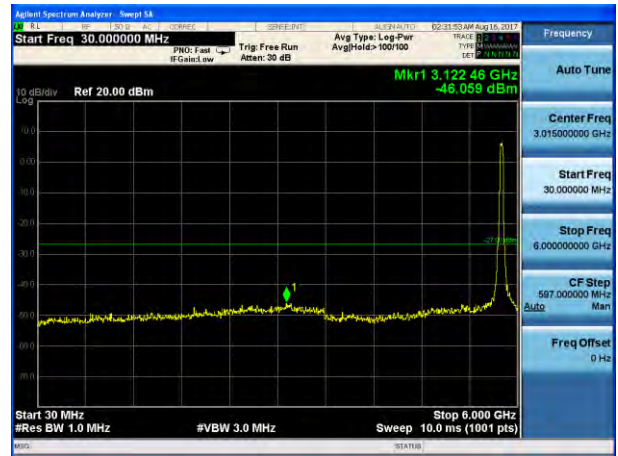

802.11n40 on channel 151



802.11n40 on channel 159



Test Plot

802.11ac20 on channel 149



802.11ac20 on channel 157



802.11ac20 on channel 149



802.11ac20 on channel 157



Test Plot

802.11ac20 on channel 165



802.11ac40 on channel 151



802.11ac20 on channel 165



802.11ac40 on channel 151



Test Plot

802.11ac40 on channel 159

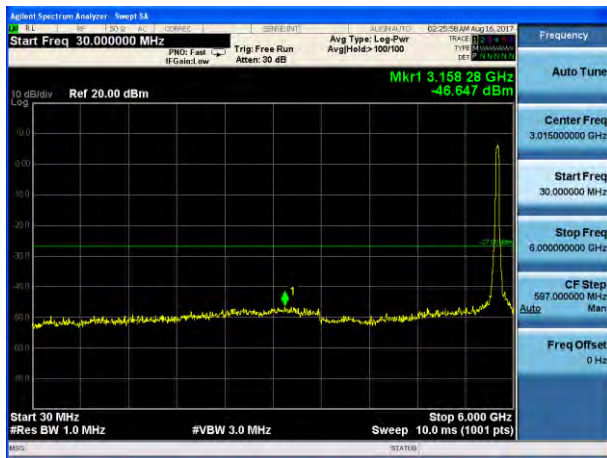

802.11ac80 on channel 155



802.11 ac40 on channel 159



802.11 ac80 on channel 155



10. Frequency Stability Measurement

10.1 LIMIT

Manufacturers of U-NII devices are responsible for ensuring frequency stability such that an emission is maintained within the band of operation under all conditions of normal operation as specified in the user's manual.

The transmitter center frequency tolerance shall be ± 20 ppm maximum for the 5 GHz band (IEEE 802.11n specification).

10.2 TEST PROCEDURES

1. The transmitter output (antenna port) was connected to the spectrum analyzer.
2. EUT have transmitted absence of modulation signal and fixed channelize.
3. Set the spectrum analyzer span to view the entire absence of modulation emissions bandwidth.
4. Set RBW = 10 kHz, VBW = 10 kHz with peak detector and maxhold settings.
5. f_c is declaring of channel frequency. Then the frequency error formula is $(f_c - f) / f_c \times 10^6$ ppm and the limit is less than ± 20 ppm (IEEE 802.11n specification).
6. The test extreme voltage is to change the primary supply voltage from 85 to 115 percent of the nominal value
7. Extreme temperature is $-20^\circ\text{C} \sim 70^\circ\text{C}$.

10.3 TEST SETUP LAYOUT

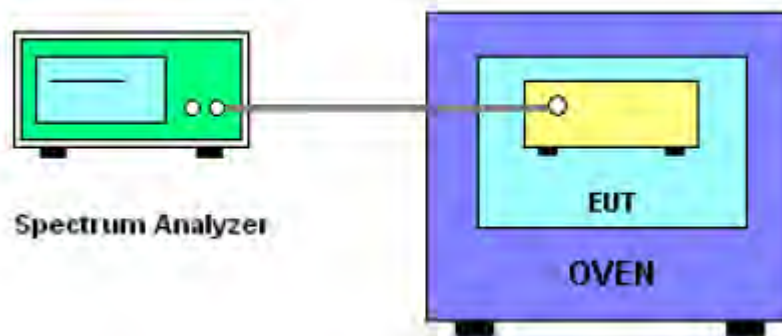

10.4 EUT OPERATION DURING TEST

The EUT was programmed to be in continuously un-modulation transmitting mode.

10.5 TEST RESULTS

EUT :	notebook	Model Name. :	DTLAPY133-1
Temperature :	25 °C	Relative Humidity :	56%
Pressure :	1012 hPa	Test Voltage :	DC 7.4V
Test Mode :	TX Frequency Band I (5150-5250MHz)		

Voltage vs. Frequency Stability

TEST CONDITIONS				Reference Frequency: 5180MHz			
				f	fc	Max. Deviation (MHz)	Max. Deviation (ppm)
T nom (°C)	20	V nom (V)	7.40	5180.0521	5180	0.0521	-10.0579
		V max (V)	8.51	5180.0326	5180	0.0326	-6.2934
		V min (V)	6.29	5180.0241	5180	0.0241	-4.6525
Limits				± 20 ppm			
Result				Complies			

Temperature vs. Frequency Stability

TEST CONDITIONS				Reference Frequency: 5180MHz			
				f	fc	Max. Deviation (MHz)	Max. Deviation (ppm)
V nom (V)	7.4	T (°C)	-20	5180.0059	5180	0.0059	-1.1390
		T (°C)	-10	5180.0107	5180	0.0107	-2.0656
		T (°C)	0	5180.0325	5180	0.0325	-6.2741
		T (°C)	10	5180.0385	5180	0.0385	-7.4324
		T (°C)	20	5180.0298	5180	0.0298	-5.7529
		T (°C)	30	5180.0213	5180	0.0213	-4.1120
		T (°C)	40	5180.0123	5180	0.0123	-2.3745
		T (°C)	50	5180.0097	5180	0.0097	-1.8726
		T (°C)	60	5180.0417	5180	0.0417	-8.0502
		T (°C)	70	5180.0695	5180	0.0695	-13.4170
Limits				± 20 ppm			
Result				Complies			

Voltage vs. Frequency Stability

TEST CONDITIONS				Reference Frequency: 5200MHz			
				f	fc	Max. Deviation (MHz)	Max. Deviation (ppm)
T nom (°C)	20	V nom (V)	7.40	5200.0251	5200	0.0251	-4.8269
		V max (V)	8.51	5200.0425	5200	0.0425	-8.1731
		V min (V)	6.29	5200.0694	5200	0.0694	-13.3462
Limits				± 20 ppm			
Result				Complies			

Temperature vs. Frequency Stability

TEST CONDITIONS				Reference Frequency: 5200MHz			
				f	fc	Max. Deviation (MHz)	Max. Deviation (ppm)
V nom (V)	7.4	T (°C)	-20	5200.0632	5200	0.0632	-12.1538
		T (°C)	-10	5200.0529	5200	0.0529	-10.1731
		T (°C)	0	5200.0437	5200	0.0437	-8.4038
		T (°C)	10	5200.0923	5200	0.0923	-17.7500
		T (°C)	20	5200.0633	5200	0.0633	-12.1731
		T (°C)	30	5200.0124	5200	0.0124	-2.3846
		T (°C)	40	5200.0739	5200	0.0739	-14.2115
		T (°C)	50	5200.0418	5200	0.0418	-8.0385
		T (°C)	60	5200.0326	5200	0.0326	-6.2692
		T (°C)	70	5200.0421	5200	0.0421	-8.0962
Limits				± 20 ppm			
Result				Complies			

Voltage vs. Frequency Stability

TEST CONDITIONS				Reference Frequency: 5240MHz			
				f	fc	Max. Deviation (MHz)	Max. Deviation (ppm)
T nom (°C)	20	V nom (V)	7.40	5240.0132	5240	0.0132	-2.5191
		V max (V)	8.51	5240.0417	5240	0.0417	-7.9580
		V min (V)	6.29	5240.0095	5240	0.0095	-1.8130
Limits				± 20 ppm			
Result				Complies			

Temperature vs. Frequency Stability

TEST CONDITIONS				Reference Frequency: 5240MHz			
				f	fc	Max. Deviation (MHz)	Max. Deviation (ppm)
V nom (V)	7.4	T (°C)	-20	5240.0092	5240	0.0092	-1.7557
		T (°C)	-10	5240.0034	5240	0.0034	-0.6489
		T (°C)	0	5240.0147	5240	0.0147	-2.8053
		T (°C)	10	5240.0852	5240	0.0852	-16.2595
		T (°C)	20	5240.0111	5240	0.0111	-2.1183
		T (°C)	30	5240.0126	5240	0.0126	-2.4046
		T (°C)	40	5240.0069	5240	0.0069	-1.3168
		T (°C)	50	5240.0074	5240	0.0074	-1.4122
		T (°C)	60	5240.0058	5240	0.0058	-1.1069
		T (°C)	70	5240.0100	5240	0.0100	-1.9084
Limits				± 20 ppm			
Result				Complies			

EUT :	notebook	Model Name. :	DTLAPY133-1
Temperature :	25 °C	Relative Humidity :	56%
Pressure :	1012 hPa	Test Voltage :	DC 7.4V
Test Mode :	TX Frequency(5745-5850MHz)		

TEST CONDITIONS				Reference Frequency: 5745MHz			
				f	fc	Max. Deviation (MHz)	Max. Deviation (ppm)
T nom (°C)	20	V nom (V)	7.40	5745.00572	5745	0.00572	-0.9959
		V max (V)	8.51	5745.00044	5745	0.00044	-0.0769
		V min (V)	6.29	5745.00746	5745	0.00746	-1.2981
Limits				± 20 ppm			
Result				Complies			

Voltage vs. Frequency Stability

Temperature vs. Frequency Stability

TEST CONDITIONS				Reference Frequency: 5745MHz			
				f	fc	Max. Deviation (MHz)	Max. Deviation (ppm)
V nom (V)	7.4	T (°C)	-20	5745.00505	5745	0.00505	-0.8791
		T (°C)	-10	5745.01224	5745	0.01224	-2.1311
		T (°C)	0	5745.00277	5745	0.00277	-0.4827
		T (°C)	10	5745.00735	5745	0.00735	-1.2792
		T (°C)	20	5745.01025	5745	0.01025	-1.7848
		T (°C)	30	5745.01351	5745	0.01351	-2.3508
		T (°C)	40	5745.00460	5745	0.00460	-0.8008
		T (°C)	50	5745.01322	5745	0.01322	-2.3007
		T (°C)	60	5745.00398	5745	0.00398	-0.6927
		T (°C)	70	5745.01239	5745	0.01239	-2.1572
Limits				± 20 ppm			
Result				Complies			

Voltage vs. Frequency Stability

TEST CONDITIONS				Reference Frequency: 5785MHz			
				f	fc	Max. Deviation (MHz)	Max. Deviation (ppm)
T nom (°C)	20	V nom (V)	7.40	5785.00720	5785	0.00720	-1.2446
		V max (V)	8.51	5785.00839	5785	0.00839	-1.4509
		V min (V)	6.29	5785.00413	5785	0.00413	-0.7139
Limits				± 20 ppm			
Result				Complies			

Temperature vs. Frequency Stability

TEST CONDITIONS				Reference Frequency: 5785MHz			
				f	fc	Max. Deviation (MHz)	Max. Deviation (ppm)
V nom (V)	7.4	T (°C)	-20	5785.00568	5785	0.00568	-0.9819
		T (°C)	-10	5785.00481	5785	0.00481	-0.8317
		T (°C)	0	5785.00544	5785	0.00544	-0.9400
		T (°C)	10	5785.00476	5785	0.00476	-0.8227
		T (°C)	20	5785.00591	5785	0.00591	-1.0218
		T (°C)	30	5785.00364	5785	0.00364	-0.6300
		T (°C)	40	5785.00426	5785	0.00426	-0.7365
		T (°C)	50	5785.00501	5785	0.00501	-0.8661
		T (°C)	60	5785.00314	5785	0.00314	-0.5423
		T (°C)	70	5785.00856	5785	0.00856	-1.4803
Limits				± 20 ppm			
Result				Complies			

Voltage vs. Frequency Stability

TEST CONDITIONS				Reference Frequency: 5825MHz			
				f	fc	Max. Deviation (MHz)	Max. Deviation (ppm)
T nom (°C)	20	V nom (V)	7.40	5825.00989	5825	0.00989	-1.6974
		V max (V)	8.51	5825.01334	5825	0.01334	-2.2910
		V min (V)	6.29	5825.01116	5825	0.01116	-1.9158
Limits				± 20 ppm			
Result				Complies			

Temperature vs. Frequency Stability

TEST CONDITIONS				Reference Frequency: 5825MHz			
				f	fc	Max. Deviation (MHz)	Max. Deviation (ppm)
V nom (V)	7.4	T (°C)	-20	5825.00771	5825	0.00771	-1.3235
		T (°C)	-10	5825.00810	5825	0.00810	-1.3901
		T (°C)	0	5825.00924	5825	0.00924	-1.5871
		T (°C)	10	5825.01347	5825	0.01347	-2.3121
		T (°C)	20	5825.00838	5825	0.00838	-1.4392
		T (°C)	30	5825.01354	5825	0.01354	-2.3253
		T (°C)	40	5825.00298	5825	0.00298	-0.5115
		T (°C)	50	5825.00512	5825	0.00512	-0.8790
		T (°C)	60	5825.01051	5825	0.01051	-1.8049
		T (°C)	70	5825.00755	5825	0.00755	-1.2968
Limits				± 20 ppm			
Result				Complies			

11. ANTENNA REQUIREMENT

11.1 STANDARD REQUIREMENT

15.203 requirement: For intentional device, according to 15.203: an intentional radiator shall be designed to ensure that no antenna other than that furnished by the responsible party shall be used with the device.

11.2 EUT ANTENNA

The EUT antenna is permanent attached FPCB antenna(antenna gain:2dBi). It comply with the standard requirement.

END OF REPORT