

# FCC RADIO TEST REPORT

## FCC ID:2ACPR-DTLAPY116-2

**Product :** notebook

**Trade Mark :** N/A

**Model Name :** TEV-EL2in1-116-2

W1641, W1631, W1637, W1635, W1639,

**Serial Model :** W1640, W1645, W1650, W1651, W1656,  
W1649, EV-EL2in1-116-2, W1643A

**Report No. :** S19061201019004

### Prepared for

SHENZHEN BMORN TECHNOLOGY CO.,LTD.

6/F, Hengfang Verteran Industrial Park, Xingye Road, Xixiang,  
Bao'an, Shenzhen, Guangdong, China

### Prepared by

Shenzhen NTEK Testing Technology Co., Ltd.

1/F, Building E, Fenda Science Park, Sanwei Community,  
Xixiang Street Bao'an District, Shenzhen 518126 P.R. China

Tel.: +86-755-6115 9388

Fax.: +86-755-6115 6599

Website:<http://www.ntek.org.cn>



## Table of Contents

	Page
<b>1 . SUMMARY OF TEST RESULTS</b>	<b>6</b>
1.1 FACILITIES AND ACCREDITATIONS	7
1.2 MEASUREMENT UNCERTAINTY	7
<b>2 . GENERAL INFORMATION</b>	<b>8</b>
2.1 GENERAL DESCRIPTION OF EUT	8
2.2 DESCRIPTION OF TEST MODES	10
2.3 BLOCK DIGRAM SHOWING THE CONFIGURATION OF SYSTEM TESTED	11
2.4 DESCRIPTION OF SUPPORT UNITS(CONDUCTED MODE)	12
2.5 EQUIPMENTS LIST FOR ALL TEST ITEMS	13
<b>3 . EMC EMISSION TEST</b>	<b>15</b>
3.1 CONDUCTED EMISSION MEASUREMENT	15
3.1.1 POWER LINE CONDUCTED EMISSION LIMITS	15
3.1.2 TEST PROCEDURE	16
3.1.3 DEVIATION FROM TEST STANDARD	16
3.1.4 TEST SETUP	16
3.1.5 EUT OPERATING CONDITIONS	16
3.2 RADIATED EMISSION MEASUREMENT	21
3.2.1 APPLICABLE STANDARD	21
3.2.2 CONFORMANCE LIMIT	21
3.2.3 MEASURING INSTRUMENTS	22
3.2.4 TEST CONFIGURATION	22
3.2.5 TEST PROCEDURE	23
3.2.6 TEST RESULTS (9KHZ – 30 MHZ)	24
3.2.7 TEST RESULTS (30MHZ – 1GHZ)	25
3.2.8 TEST RESULTS (1GHZ-26GHZ)	29
3.2.9 TEST RESULTS (26GHZ-40GHZ)	31
<b>4 . POWER SPECTRAL DENSITY TEST</b>	<b>35</b>
4.1 APPLIED PROCEDURES / LIMIT	35
4.2 TEST PROCEDURE	36
4.3 DEVIATION FROM STANDARD	36
4.4 TEST SETUP	36
4.5 EUT OPERATION CONDITIONS	36
4.6 TEST RESULTS	37
<b>5 . 26DB &amp; 99% EMISSION BANDWIDTH</b>	<b>45</b>
5.1 APPLIED PROCEDURES / LIMIT	45
5.2 TEST PROCEDURE	45
5.3 EUT OPERATION CONDITIONS	46
5.4 TEST RESULTS	47

## Table of Contents

	Page
<b>6 . MINIMUM 6 DB BANDWIDTH</b>	<b>55</b>
6.1 APPLIED PROCEDURES / LIMIT	55
6.2 TEST PROCEDURE	55
6.3 DEVIATION FROM STANDARD	55
6.4 TEST SETUP	55
6.5 EUT OPERATION CONDITIONS	55
6.6 TEST RESULTS	56
<b>7 . MAXIMUM CONDUCTED OUTPUT POWER</b>	<b>64</b>
7.1 PPLIED PROCEDURES / LIMIT	64
7.2 TEST PROCEDURE	64
7.3 DEVIATION FROM STANDARD	66
7.4 TEST SETUP	66
7.5 EUT OPERATION CONDITIONS	66
7.6 TEST RESULTS	67
<b>8 . OUT OF BAND EMISSIONS</b>	<b>69</b>
8.1 APPLICABLE STANDARD	69
8.2 TEST PROCEDURE	69
8.3 DEVIATION FROM STANDARD	69
8.4 TEST SETUP	69
8.5 EUT OPERATION CONDITIONS	69
8.6 TEST RESULTS	70
<b>9.SPURIOUS RF CONDUCTED EMISSIONS</b>	<b>77</b>
9.1CONFORMANCE LIMIT	77
9.2MEASURING INSTRUMENTS	77
9.3TEST SETUP	77
9.4TEST PROCEDURE	77
9.5TEST RESULTS	77
<b>10. FREQUENCY STABILITY MEASUREMENT</b>	<b>92</b>
10.1 LIMIT	92
10.2 TEST PROCEDURES	92
10.3 TEST SETUP LAYOUT	92
10.4 EUT OPERATION DURING TEST	92
10.5 TEST RESULTS	93
<b>11. ANTENNA REQUIREMENT</b>	<b>99</b>
11.1 STANDARD REQUIREMENT	99
11.2 EUT ANTENNA	99



## 1. SUMMARY OF TEST RESULTS

Test procedures according to the technical standards:

FCC Part15 (15.407) , Subpart E			
Standard Section	Test Item	Judgment	Remark
15.207	AC Power Line Conducted Emissions	PASS	
15.209(a), 15.407 (b)(1) 15.407 (b)(4) 15.407 (b)(6)	Spurious Radiated Emissions	PASS	(Out sourcing)
15.407 (a)(1) 15.407 (a)(3) 15.1049	26 dB and 99% Emission Bandwidth	PASS	
15.407(e)	Minimum 6 dB bandwidth	PASS	
15.407 (a)(1) 15.407 (a)(3)	Maximum Conducted Output Power	PASS	
2.1051, 15.407(b)(1) 15.407(b)(4)	Band Edge	PASS	
15.407 (a)(1) 15.407 (a)(3)	Power Spectral Density	PASS	
2.1051, 15.407(b)	Spurious Emissions at Antenna Terminals	PASS	
15.407(g)	Frequency Stability	PASS	
15.203	Antenna Requirement	PASS	

**NOTE:**

(1) "N/A" denotes test is not applicable in this Test Report

Outsourcing: The 26.5G-40G Spurious Radiated Emissions in this test were outsourced to the Shenzhen Academy of Metrology & Quality Inspection

**1.1 FACILITIES AND ACCREDITATIONS**

**FACILITIES**

All measurement facilities used to collect the measurement data are located at 1/F, Building E, Fenda Science Park, Sanwei Community, Xixiang Street, Bao'an District, Shenzhen 518126 P.R. China.

The sites are constructed in conformance with the requirements of ANSI C63.7, ANSI C63.10 and CISPR Publication 22.

**LABORATORY ACCREDITATIONS AND LISTINGS**

Site Description

CNAS-Lab. : The Laboratory has been assessed and proved to be in compliance with CNAS-CL01:2006 (identical to ISO/IEC 17025:2005)  
The Certificate Registration Number is L5516.

IC-Registration The Certificate Registration Number is 9270A-1.

FCC- Accredited Test Firm Registration Number: 463705.  
Designation Number: CN1184

A2LA-Lab. The Certificate Registration Number is 4298.01  
This laboratory is accredited in accordance with the recognized International Standard ISO/IEC 17025:2005 General requirements for the competence of testing and calibration laboratories.  
This accreditation demonstrates technical competence for a defined scope and the operation of a laboratory quality management system (refer to joint ISO-ILAC-IAF Communiqué dated 8 January 2009).

Name of Firm : Shenzhen NTEK Testing Technology Co., Ltd.

Site Location : 1/F, Building E, Fenda Science Park, Sanwei Community, Xixiang Street, Bao'an District, Shenzhen 518126 P.R. China.

**1.2 MEASUREMENT UNCERTAINTY**

The reported uncertainty of measurement  $y \pm U$ , where expanded uncertainty  $U$  is based on a standard uncertainty multiplied by a coverage factor of  $k=2$ , providing a level of confidence of approximately 95 %.

No.	Item	Uncertainty
1	Conducted Emission Test	$\pm 2.80\text{dB}$
2	RF power, conducted	$\pm 0.16\text{dB}$
3	Spurious emissions, conducted	$\pm 0.21\text{dB}$
4	All emissions, radiated(30MHz~1GHz)	$\pm 2.64\text{dB}$
5	All emissions, radiated(1GHz~6GHz)	$\pm 2.40\text{dB}$
6	All emissions, radiated(> 6GHz)	$\pm 2.52\text{dB}$
7	Temperature	$\pm 0.5^\circ\text{C}$
8	Humidity	$\pm 2\%$

## 2. GENERAL INFORMATION

### 2.1 GENERAL DESCRIPTION OF EUT

Equipment	notebook		
Trade Mark	N/A		
Model Name	TEV-EL2in1-116-2		
FCC ID	2ACPR-DTLAPY116-2		
Product Description	IEEE 802.11 WLAN Mode Supported	<input checked="" type="checkbox"/> 802.11a/n/ac(20MHz channel bandwidth) <input checked="" type="checkbox"/> 802.11n/ac(40MHz channel bandwidth) <input checked="" type="checkbox"/> 802.11ac(80MHz channel bandwidth)	
	Data Rate	802.11a: 6,9,12,18,24,36,48,54Mbps; 802.11n(HT20/HT40):MCS0-MCS15; 802.11ac(VHT20): NSS1, MCS0-MCS8 802.11ac(VHT40/VHT80):NSS1, MCS0-MCS9	
	Modulation	OFDM with BPSK/DQPSK/16QAM/64QAM/256QAM for 802.11a/n/ac;	
	Operating Frequency Range	<input checked="" type="checkbox"/> 5180-5240MHz for 802.11a/n(HT20)/ac20; 5190-5230MHz for 802.11n(HT40)/ac40; 5210MHz for 802.11 ac80; <input checked="" type="checkbox"/> 5745-5825 MHz for 802.11a/n(HT20)/ac20; 5755-5795 MHz for 802.11a/n(HT40)/ac40; 5775MHz for 802.11 ac80;	
	Number of Channels	<input checked="" type="checkbox"/> 4 channels for 802.11a/n20/ac20 in the 5180-5240MHz band ; 2 channels for 802.11 n40/ac40 in the 5190-5230MHz band ; 1 channels for 802.11 ac80 in the 5210MHz band ; <input checked="" type="checkbox"/> 5 channels for 802.11a/n20/ac20 in the 5745-5825MHz band ; 2 channels for 802.11 n40/ac40 in the 5755-5795MHz band ; 1 channels for 802.11 ac80 in the 5775MHz band ;	
	Antenna Type	Antenna A/B:FPCB Antenna	
	Antenna Gain	Antenna A/B:-3.74 dBi	
	Based on the application, features, or specification exhibited in User's Manual, More details of EUT technical specification, please refer to the User's Manual.		
	Ratings	DC 7.6V from battery or DC 12V from Adapter	
	Adapter	Model: SAW30-120-2000U Input:AC 100~240V 50~60Hz 0.8A Output:12V, 2000mA	
Battery	DC 7.6V, 4000MAh		
Connecting I/O Port(s)	Please refer to the User's Manual		



Note:

- For a more detailed features description, please refer to the manufacturer's specifications or the User's Manual.
- Frequency and Channel list for 802.11a/n(20MHz) band I (5180-5240MHz):

802.11a/n/ac( 20MHz) Carrier Frequency Channel							
Channel	Frequency (MHz)	Channel	Frequency (MHz)	Channel	Frequency (MHz)	Channel	Frequency (MHz)
36	5180	44	5220	-	-	-	-
40	5200	48	5240	-	-	-	-

Frequency and Channel list for 802.11n(40MHz) band I (5190-5230MHz):

802.11n /ac(40MHz) Carrier Frequency Channel							
Channel	Frequency (MHz)	Channel	Frequency (MHz)	Channel	Frequency (MHz)	Channel	Frequency (MHz)
38	5190	-	-	-	-	-	-
46	5230	-	-	-	-	-	-

802.11ac (80MHz) Carrier Frequency Channel	
Channel	Frequency (MHz)
42	5210

Frequency and Channel list for 802.11a/n(20 MHz) band IV (5745-5825MHz):

802.11a/n/ac( 20 MHz) Carrier Frequency Channel							
Channel	Frequency (MHz)	Channel	Frequency (MHz)	Channel	Frequency (MHz)	Channel	Frequency (MHz)
149	5745	153	5765	157	5785	161	5805
165	5825	-	-	-	-	-	-

Frequency and Channel list for 802.11n(40MHz) band IV (5755-5795MHz):

802.11n/ac 40MHz Carrier Frequency Channel					
Channel	Frequency (MHz)	Channel	Frequency (MHz)	Channel	Frequency (MHz)
151	5755	159	5795	-	-

802.11ac 80MHz Carrier Frequency Channel	
Channel	Frequency (MHz)
155	5775

The EUT has two types of antenna. The wireless module is 1x1 Wi-Fi support 802.11b / g / n / ac; does not support MIMO

Tx Antenna

Antenna	Antenna Type	Antenna Gain(dBi)
		5.0G
A(main)	FPCB	-3.74
B(aux)	FPCB	-3.74

**2.2 DESCRIPTION OF TEST MODES**

To investigate the maximum EMI emission characteristics generates from EUT, the test system was pre-scanning tested base on the consideration of following EUT operation mode or test configuration mode which possible have effect on EMI emission level. Each of these EUT operation mode(s) or test configuration mode(s) mentioned above was evaluated respectively.

Pretest Mode	Description
Mode 1	Normal Link Mode
Mode 2	802.11a / n/ ac 20 CH36/ CH40/ CH 48 802.11a /n/ ac 20 CH149/ CH157/ CH 165
Mode 3	802.11n/ ac40 CH38/ CH 46 802.11n/ ac40 CH 151 / CH 159
Mode 4	802.11 ac80 CH 155

For Radiated Emission	
Final Test Mode	Description
Mode 1	Normal Link Mode
Mode 2	802.11a / n/ ac 20 CH36/ CH40/ CH 48 802.11a /n/ ac 20 CH149/ CH157/ CH 165
Mode 3	802.11n/ ac40 CH38/ CH 46 802.11n/ ac40 CH 151 / CH 159
Mode 4	802.11 ac80 CH 155

Note:

- (1) The measurements are performed at the highest, middle, lowest available channels.
- (2) The measurements are performed at all Bit Rate of Transmitter, the worst data was reported

### 2.3 BLOCK DIGRAM SHOWING THE CONFIGURATION OF SYSTEM TESTED

For AC Conducted Emission Mode

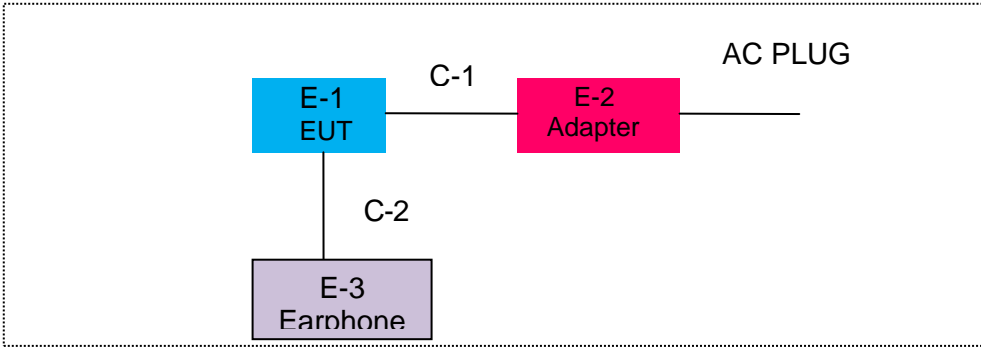

Radiated Spurious Emission Test

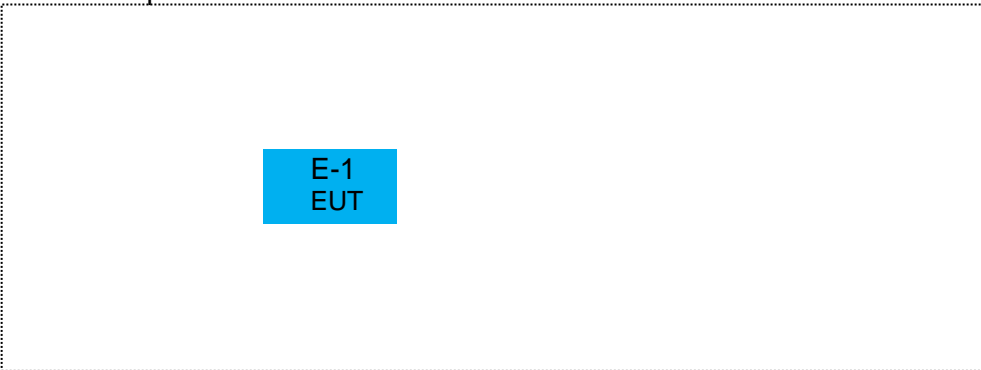

For Conducted Test Cases

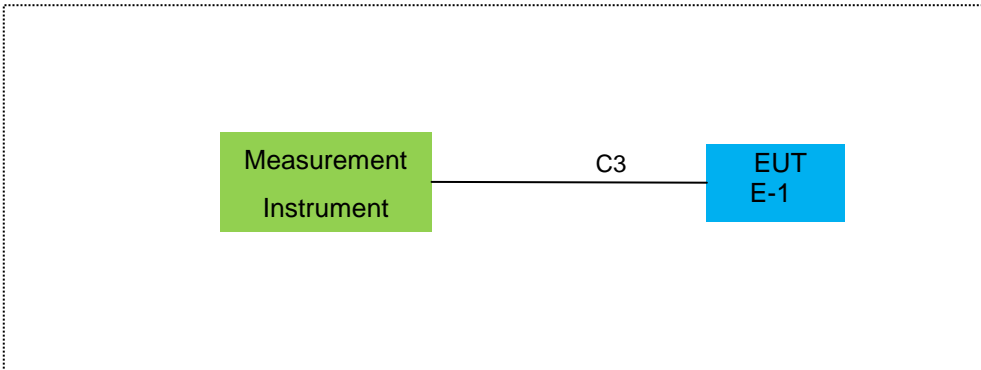

**2.4 DESCRIPTION OF SUPPORT UNITS(CONDUCTED MODE)**

The EUT has been tested as an independent unit together with other necessary accessories or support units. The following support units or accessories were used to form a representative test configuration during the tests.

Item	Equipment	Brand	Model/Type No.	Series No.	Note
E-1	notebook	N/A	TEV-EL2in1-116-2	2ACPR-DTLAPY116-2	EUT
E-2	Adapter	N/A	SAW30-120-2000U	N/A	
E-3	Earphone	N/A	2688	N/A	Peripherals

Item	Cable Type	Shielded Type	Ferrite Core	Length	Note
C-1	Power Cable	NO	NO	1.2m	
C-2	Earphone Cable	NO	NO	1.0m	
C-3	RF Cable	NO	NO	0.5m	

Note:

- (1) The support equipment was authorized by Declaration of Confirmation.
- (2) For detachable type I/O cable should be specified the length in cm in 『Length』 column.

**2.5 EQUIPMENTS LIST FOR ALL TEST ITEMS**

Radiation Test equipment

Item	Kind of Equipment	Manufacturer	Type No.	Serial No.	Last calibration	Calibrated until	Calibration period
1	Spectrum Analyzer	Agilent	E4407B	MY45108040	2017.06.06	2018.06.05	1 year
2	Spectrum Analyzer	Agilent	N9020A	MY49100060	2016.11.10	2017.11.09	1 year
3	EMI Test Receiver	Agilent	N9038A	MY53227146	2017.06.06	2018.06.05	1 year
4	Test Receiver	R&S	ESPI	101318	2017.06.06	2018.06.05	1 year
5	Bilog Antenna	TESEQ	CBL6111D	31216	2017.04.09	2018.04.08	1 year
6	50Ω Coaxial Switch	Anritsu	MP59B	6200983705	2017.06.06	2018.06.05	1 year
7	Horn Antenna	EM	EM-AH-10180	2011071402	2017.04.09	2018.04.08	1 year
8	Horn Ant	Schwarzbeck	BBHA 9170	9170-181	2017.07.06	2018.07.05	1 year
9	Amplifier	EMC	EMC051835SE	980246	2017.08.09	2018.08.08	1 year
10	Amplifier	MITEQ	TTA1840-35-HG	177156	2017.06.06	2018.06.05	1 year
11	Loop Antenna	ARA	PLA-1030/B	1029	2017.06.06	2018.06.05	1 year
12	Power Meter	DARE	RPR3006W	15100041SN084	2017.08.09	2018.08.08	1 year
13	Test Cable (9KHz-30MHz)	N/A	R-01	N/A	2017.04.21	2020.04.20	3 year
14	Test Cable (30MHz-1GHz)	N/A	R-02	N/A	2017.04.21	2020.04.20	3 year
15	High Test Cable(1G-40G Hz)	N/A	R-03	N/A	2017.04.21	2020.04.20	3 year
16	High Test Cable(1G-40G Hz)	N/A	R-04	N/A	2017.04.21	2020.04.20	3 year
17	temporary antenna connector (Note)	NTS	R001	N/A	N/A	N/A	N/A

Note:

We will use the temporary antenna connector (soldered on the PCB board) When conducted test And this temporary antenna connector is listed within the instrument list

Conduction Test equipment

Item	Kind of Equipment	Manufacturer	Type No.	Serial No.	Last calibration	Calibrated until	Calibration period
1	Test Receiver	R&S	ESCI	101160	2017.06.06	2018.06.05	1 year
2	LISN	R&S	ENV216	101313	2017.04.19	2018.04.18	1 year
3	LISN	SCHWARZBECK	NNLK 8129	8129245	2017.06.06	2018.06.05	1 year
4	50Ω Coaxial Switch	ANRITSU CORP	MP59B	6200983704	2017.06.06	2018.06.05	1 year
5	Test Cable (9KHz-30MHz)	N/A	C01	N/A	2017.04.21	2020.04.20	3 year
6	Test Cable (9KHz-30MHz)	N/A	C02	N/A	2017.04.21	2020.04.20	3 year
7	Test Cable (9KHz-30MHz)	N/A	C03	N/A	2017.04.21	2020.04.20	3 year

1	Filter	TRILTHIC	2400MHz	29	2017.04.19	2018.04.18	1 year
---	--------	----------	---------	----	------------	------------	--------

Note: Each piece of equipment is scheduled for calibration once a year.

### 3. EMC EMISSION TEST

#### 3.1 CONDUCTED EMISSION MEASUREMENT

##### 3.1.1 POWER LINE CONDUCTED EMISSION Limits (Frequency Range 150KHz-30MHz)

FREQUENCY (MHz)	Class B (dBuV)		Standard
	Quasi-peak	Average	
0.15 -0.5	66 - 56 *	56 - 46 *	CISPR
0.50 -5.0	56.00	46.00	CISPR
5.0 -30.0	60.00	50.00	CISPR

0.15 -0.5	66 - 56 *	56 - 46 *	FCC/ RSS-247
0.50 -5.0	56.00	46.00	FCC/ RSS-247
5.0 -30.0	60.00	50.00	FCC/ RSS-247

Note:

- (1) The tighter limit applies at the band edges.
- (2) The limit of " \* " marked band means the limitation decreases linearly with the logarithm of the frequency in the range.

The following table is the setting of the receiver

Receiver Parameters	Setting
Attenuation	10 dB
Start Frequency	0.15 MHz
Stop Frequency	30 MHz
IF Bandwidth	9 kHz

**3.1.2 TEST PROCEDURE**

- a. The EUT was placed 0.8 meters from the horizontal ground plane with EUT being connected to the power mains through a line impedance stabilization network (LISN). All other support equipments powered from additional LISN(s). The LISN provide 50 Ohm/ 50uH of coupling impedance for the measuring instrument.
- b. Interconnecting cables that hang closer than 40 cm to the ground plane shall be folded back and forth in the center forming a bundle 30 to 40 cm long.
- c. I/O cables that are not connected to a peripheral shall be bundled in the center. The end of the cable may be terminated, if required, using the correct terminating impedance. The overall length shall not exceed 1 m.
- d. LISN at least 80 cm from nearest part of EUT chassis.
- e. For the actual test configuration, please refer to the related Item –EUT Test Photos.

**3.1.3 DEVIATION FROM TEST STANDARD**

No deviation

**3.1.4 TEST SETUP**

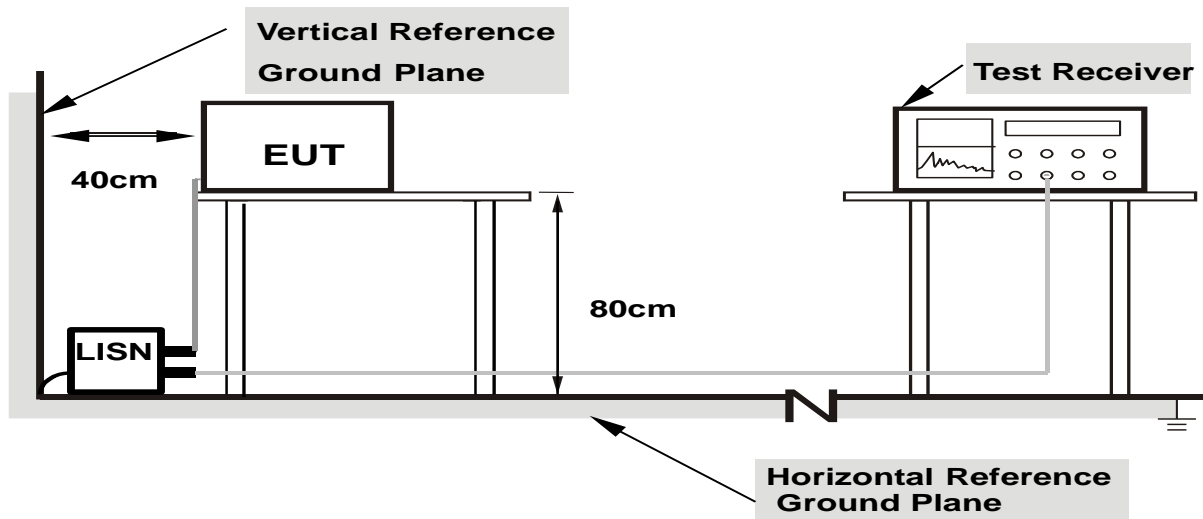

- Note:**
- 1.Support units were connected to second LISN.
  - 2.Both of LISNs (AMN) are 80 cm from EUT and at least 80 from other units and other metal planes

**3.1.5 EUT OPERATING CONDITIONS**

The EUT was configured for testing in a typical fashion (as a customer would normally use it). The EUT has been programmed to continuously transmit during test. This operating condition was tested and used to collect the included data.



EUT :	notebook	Model Name. :	TEV-EL2in1-116-2
Temperature :	26 °C	Relative Humidity :	56%
Pressure :	1010hPa	Phase :	L
Test Voltage :	DC 12V from Adapter AC 120V/60Hz	Test Mode :	Mode 1

Frequency (MHz)	Reading Level (dBμV)	Correct Factor (dB)	Measurement (dBμV)	Limits (dBμV)	Margin (dB)	Remark
0.1685	49.89	9.82	59.71	65.03	-5.32	QP
0.1685	19.75	9.82	29.57	55.03	-25.46	AVG
0.1943	49.36	9.82	59.18	63.85	-4.67	QP
0.1943	35.59	9.82	45.41	53.85	-8.44	AVG
0.2139	46.85	9.82	56.67	63.05	-6.38	QP
0.2139	18.34	9.82	28.16	53.05	-24.89	AVG
1.0220	41.07	9.93	51.00	56.00	-5.00	QP
1.0220	21.20	9.93	31.13	46.00	-14.87	AVG
1.4377	42.51	9.89	52.40	56.00	-3.60	QP
1.4377	24.66	9.89	34.55	46.00	-11.45	AVG
1.6377	42.25	9.88	52.13	56.00	-3.87	QP
1.6377	26.60	9.88	36.48	46.00	-9.52	AVG

Remark:

1. All readings are Quasi-Peak and Average values.
2. Factor = Insertion Loss + Cable Loss.

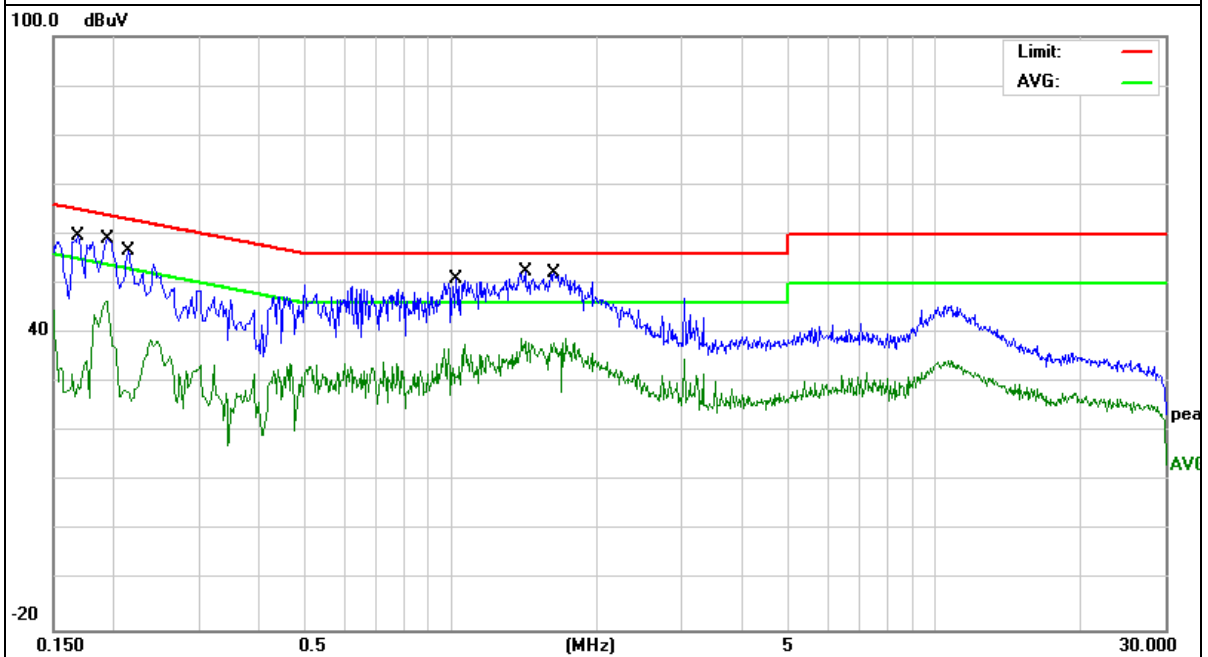

EUT :	notebook	Model Name. :	TEV-EL2in1-116-2
Temperature :	26 °C	Relative Humidity :	56%
Pressure :	1010hPa	Phase :	N
Test Voltage :	DC 12V from Adapter AC 120V/60Hz	Test Mode :	Mode 1

Frequency (MHz)	Reading Level (dBμV)	Correct Factor (dB)	Measure-ment (dBμV)	Limits (dBμV)	Margin (dB)	Remark
0.1620	51.28	9.92	61.20	65.36	-4.16	QP
0.1620	19.79	9.92	29.71	55.36	-25.65	AVG
0.1844	48.78	9.92	58.70	64.28	-5.58	QP
0.1844	30.13	9.92	40.05	54.28	-14.23	AVG
0.2353	47.93	9.92	57.85	62.26	-4.41	QP
0.2353	26.67	9.92	36.59	52.26	-15.67	AVG
0.7338	40.99	9.93	50.92	56.00	-5.08	QP
0.7338	25.15	9.93	35.08	46.00	-10.92	AVG
0.9818	42.37	9.93	52.30	56.00	-3.70	QP
0.9818	24.74	9.93	34.67	46.00	-11.33	AVG
1.1140	42.22	9.93	52.15	56.00	-3.85	QP
1.1140	25.38	9.93	35.31	46.00	-10.69	AVG

Remark:

1. All readings are Quasi-Peak and Average values.
2. Factor = Insertion Loss + Cable Loss.

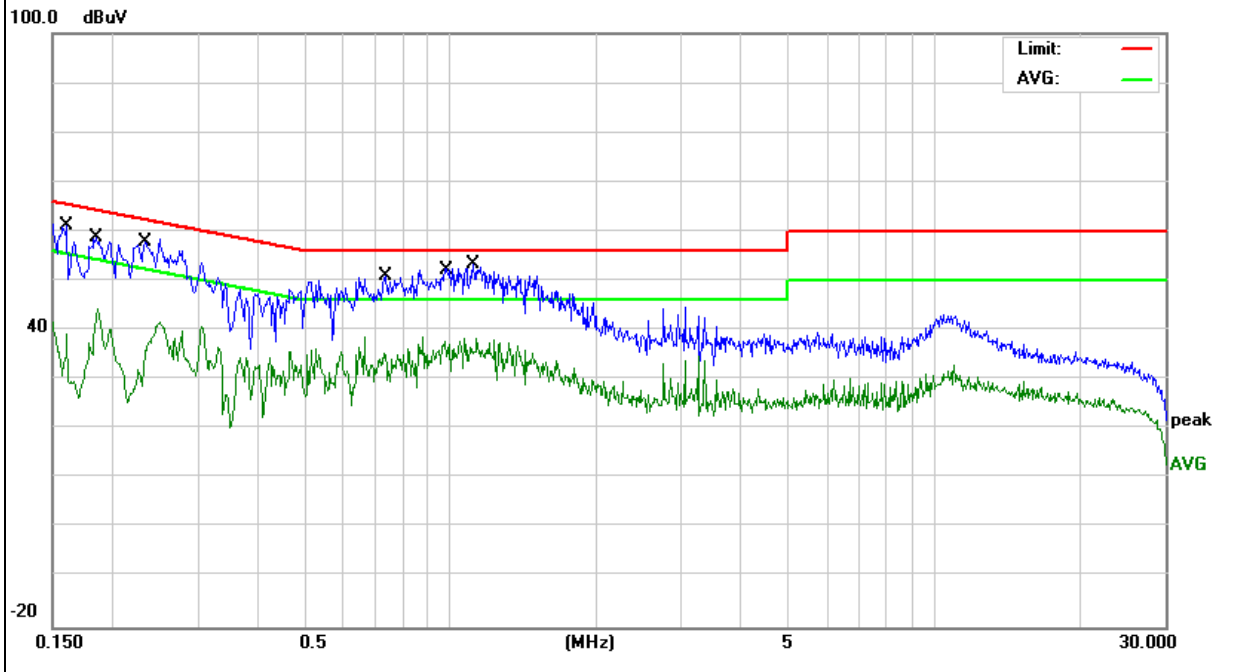

EUT :	notebook	Model Name. :	TEV-EL2in1-116-2
Temperature :	26 °C	Relative Humidity :	56%
Pressure :	1010hPa	Phase :	L
Test Voltage :	DC 12V from Adapter AC 240V/60Hz	Test Mode :	Mode 1

Frequency (MHz)	Reading Level (dBμV)	Correct Factor (dB)	Measurement (dBμV)	Limits (dBμV)	Margin (dB)	Remark
0.1900	45.17	9.82	54.99	64.03	-9.04	QP
0.1900	17.82	9.82	27.64	54.03	-26.39	AVG
0.3140	40.10	9.82	49.92	59.86	-9.94	QP
0.3140	17.48	9.82	27.30	49.86	-22.56	AVG
0.3900	32.73	9.83	42.56	58.06	-15.50	QP
0.3900	16.46	9.83	26.29	48.06	-21.77	AVG
0.5900	31.75	9.83	41.58	56.00	-14.42	QP
0.5900	22.38	9.83	32.21	46.00	-13.79	AVG
1.7420	35.70	9.87	45.57	56.00	-10.43	QP
1.7420	21.10	9.87	30.97	46.00	-15.03	AVG
10.9379	34.91	10.02	44.93	60.00	-15.07	QP
10.9379	24.39	10.02	34.41	50.00	-15.59	AVG

Remark:

1. All readings are Quasi-Peak and Average values.
2. Factor = Insertion Loss + Cable Loss.

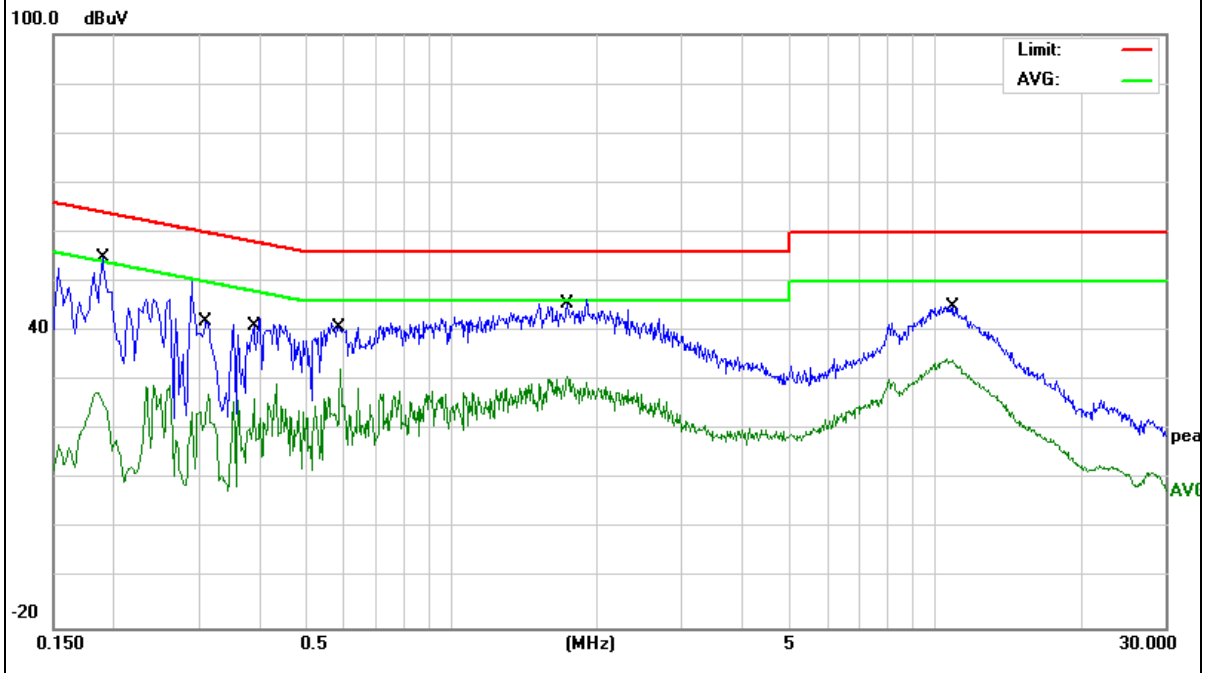

EUT :	notebook	Model Name. :	TEV-EL2in1-116-2
Temperature :	26 °C	Relative Humidity :	56%
Pressure :	1010hPa	Phase :	N
Test Voltage :	DC 12V from Adapter AC 240V/60Hz	Test Mode :	Mode 1

Frequency (MHz)	Reading Level (dBμV)	Correct Factor (dB)	Measure-ment (dBμV)	Limits (dBμV)	Margin (dB)	Remark
0.1780	42.32	9.92	52.24	64.57	-12.33	QP
0.1780	17.86	9.92	27.78	54.57	-26.79	AVG
0.1980	38.77	9.92	48.69	63.69	-15.00	QP
0.1980	14.09	9.92	24.01	53.69	-29.68	AVG
0.2365	38.39	9.92	48.31	62.21	-13.90	QP
0.2365	12.66	9.92	22.58	52.21	-29.63	AVG
0.2580	36.87	9.92	46.79	61.49	-14.70	QP
0.2580	21.21	9.92	31.13	51.49	-20.36	AVG
1.8860	34.74	9.94	44.68	56.00	-11.32	QP
1.8860	16.98	9.94	26.92	46.00	-19.08	AVG
10.3739	32.94	10.09	43.03	60.00	-16.97	QP
10.3739	19.52	10.09	29.61	50.00	-20.39	AVG

Remark:

1. All readings are Quasi-Peak and Average values.
2. Factor = Insertion Loss + Cable Loss.

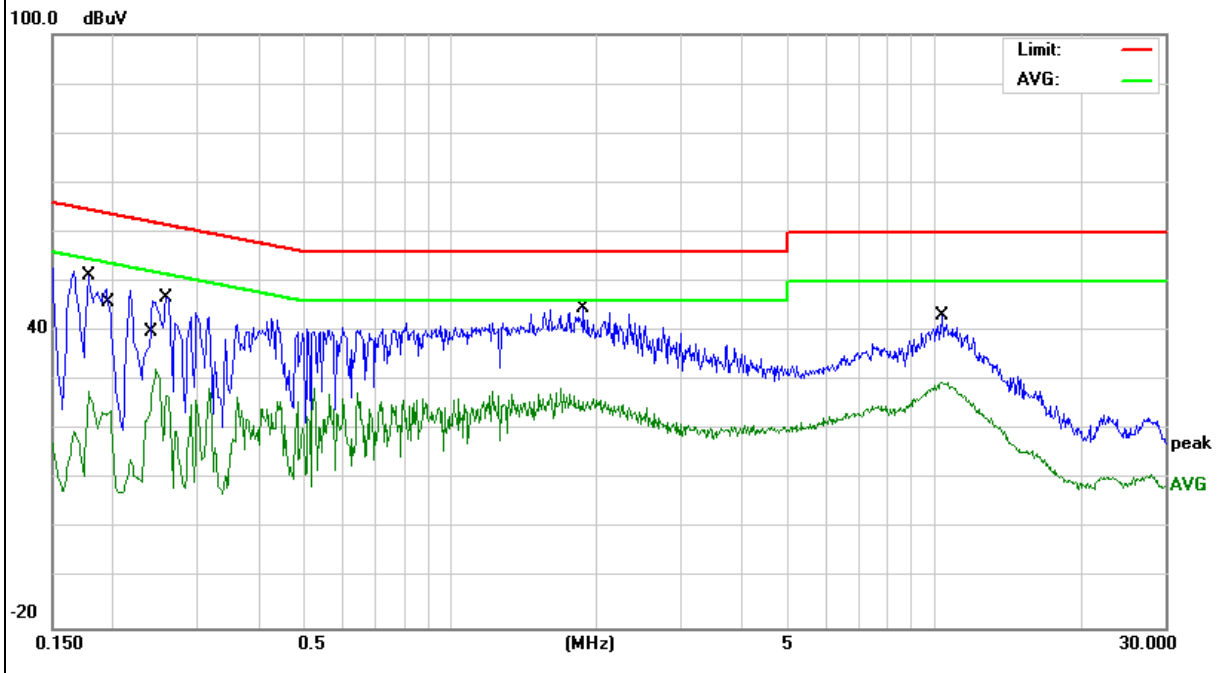

### 3.2 RADIATED EMISSION MEASUREMENT

#### 3.2.1 APPLICABLE STANDARD

According to FCC Part 15.407(d) and 15.209

#### 3.2.2 CONFORMANCE LIMIT

According to FCC Part 15.407(b)(7): radiated emissions which fall in the restricted bands, as defined in §15.205(a), must also comply with the radiated emission limits specified in §15.209(a) (see §15.205(c)).  
According to FCC Part 15.205, Restricted bands

MHz	MHz	MHz	GHz
0.090-0.110	16.42-16.423	399.9-410	4.5-5.15
10.495-0.505	16.69475-16.69525	608-614	5.35-5.46
2.1735-2.1905	16.80425-16.80475	960-1240	7.25-7.75
4.125-4.128	25.5-25.67	1300-1427	8.025-8.5
4.17725-4.17775	37.5-38.25	1435-1626.5	9.0-9.2
4.20725-4.20775	73-74.6	1645.5-1646.5	9.3-9.5
6.215-6.218	74.8-75.2	1660-1710	10.6-12.7
6.26775-6.26825	123-138	2200-2300	14.47-14.5
8.291-8.294	149.9-150.05	2310-2390	15.35-16.2
8.362-8.366	156.52475-156.52525	2483.5-2500	17.7-21.4
8.37625-8.38675	156.7-156.9	2690-2900	22.01-23.12
8.41425-8.41475	162.0125-167.17	3260-3267	23.6-24.0
12.29-12.293	167.72-173.2	3332-3339	31.2-31.8
12.51975-12.52025	240-285	3345.8-3358	36.43-36.5
12.57675-12.57725	322-335.4	3600-4400	(2)
13.36-13.41			

20dBc in any 100 kHz bandwidth outside the operating frequency band. In case the emission fall within the restricted band specified on 15.205(a), then the 15.209(a) limit in the table below has to be followed.

Restricted Frequency(MHz)	Field Strength (µV/m)	Field Strength (dBµV/m)	Measurement Distance
0.009~0.490	2400/F(KHz)	20 log (uV/m)	300
0.490~1.705	2400/F(KHz)	20 log (uV/m)	30
1.705~30.0	30	29.5	30
30-88	100	40	3
88-216	150	43.5	3
216-960	200	46	3
Above 960	500	54	3

#### Limits of Radiated Emission Measurement(Above 1000MHz)

Frequency(MHz)	Class B (dBuV/m) (at 3M)	
	PEAK	AVERAGE
Above 1000	74	54

- Remark :1. Emission level in dBuV/m=20 log (uV/m)  
 2. Measurement was performed at an antenna to the closed point of EUT distance of meters.  
 3. For Frequency 9kHz~30MHz:  
 Distance extrapolation factor =40log(Specific distance/ test distance)(dB);  
 Limit line=Specific limits(dBuV) + distance extrapolation factor.  
 For Frequency above 30MHz:  
 Distance extrapolation factor =20log(Specific distance/ test distance)(dB);  
 Limit line=Specific limits(dBuV) + distance extrapolation factor.

### 3.2.3 MEASURING INSTRUMENTS

The Measuring equipment is listed in the section 6.3 of this test report.

### 3.2.4 TEST CONFIGURATION

(a) For radiated emissions below 30MHz

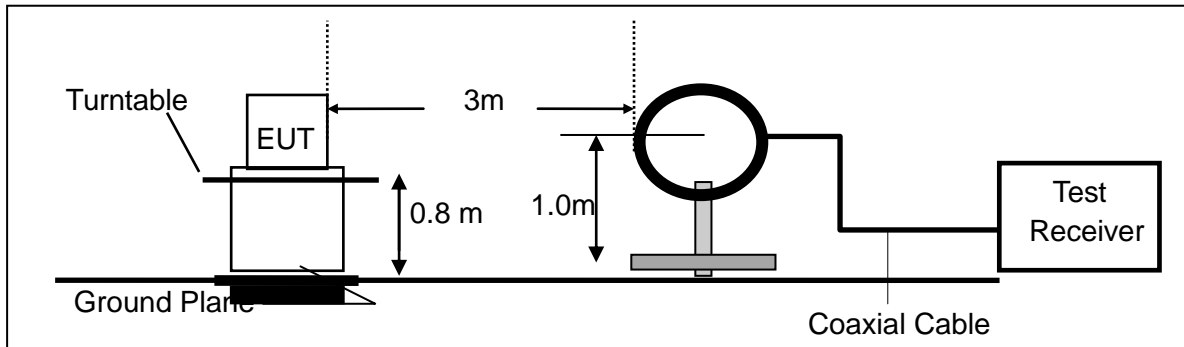

(b) For radiated emissions from 30MHz to 1000MHz

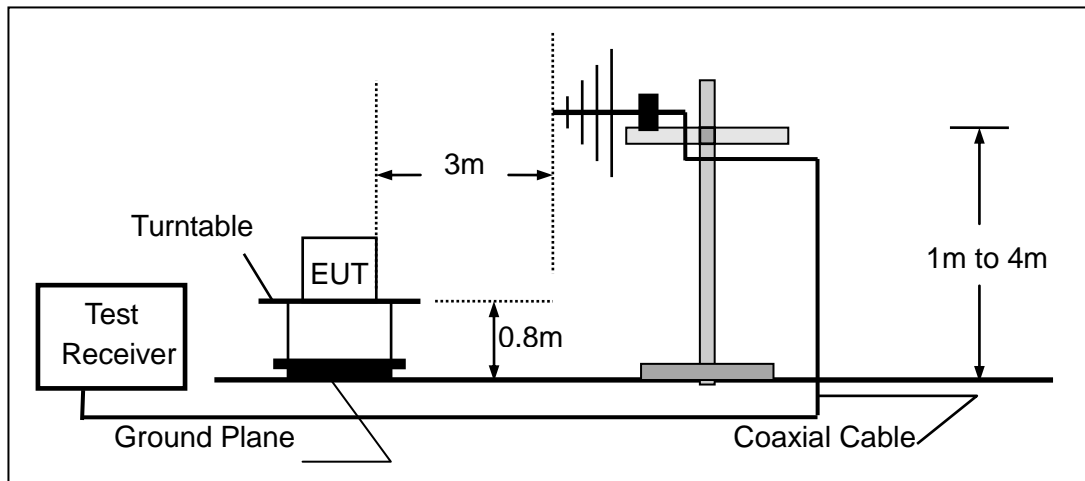

(c) For radiated emissions above 1000MHz

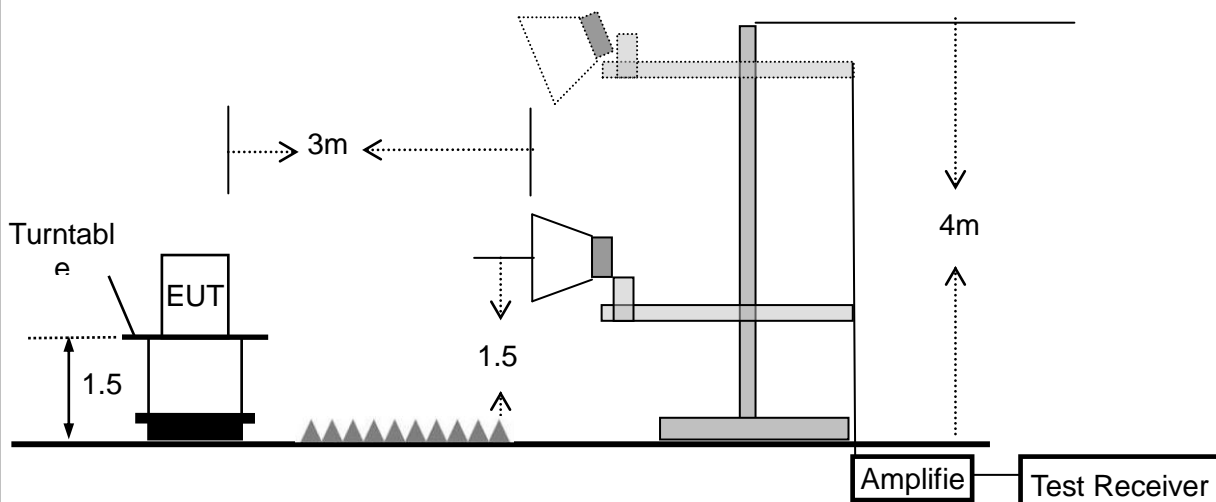

### 3.2.5 TEST PROCEDURE

The test site semi-anechoic chamber has met the requirement of NSA tolerance 4 dB according to the standards: ANSI C63.10-2013. The test distance is 3m. The setup is according to the requirements in Section 13.1.4.1 of ANSI C63.10-2013 and CAN/CSA-CEI/IEC CISPR 22.

This test is required for any spurious emission that falls in a Restricted Band, as defined in Section 15.205. It must be performed with the highest gain of each type of antenna proposed for use with the EUT.

Use the following spectrum analyzer settings:

Spectrum Parameter	Setting
Attenuation	Auto
Start Frequency	1000 MHz
Stop Frequency	10th carrier harmonic
RB / VB (emission in restricted band)	1 MHz / 1 MHz for Peak, 1 MHz / 10Hz for Average

Receiver Parameter	Setting
Attenuation	Auto
Start ~ Stop Frequency	9kHz~150kHz / RB 200Hz for QP
Start ~ Stop Frequency	150kHz~30MHz / RB 9kHz for QP
Start ~ Stop Frequency	30MHz~1000MHz / RB 120kHz for QP

- The measuring distance of at 3 m shall be used for measurements at frequency up to 1GHz. For frequencies above 1GHz, any suitable measuring distance may be used.
- The EUT was placed on the top of a rotating table 0.8 m for below 1GHz and 1.5m for above 1GHz the ground at a 3 meter. The table was rotated 360 degrees to determine the position of the highest radiation.
- The height of the equipment or of the substitution antenna shall be 0.8 m for below 1GHz and 1.5m for above 1GHz; the height of the test antenna shall vary between 1 m to 4 m. Both horizontal and vertical polarizations of the antenna are set to make the measurement.
- The initial step in collecting conducted emission data is a spectrum analyzer peak detector mode pre-scanning the measurement frequency range. Significant peaks are then marked and then Quasi Peak detector mode re-measured.
- If the Peak Mode measured value compliance with and lower than Quasi Peak Mode Limit, the EUT shall be deemed to meet QP Limits and then no additional QP Mode measurement performed.
- For the actual test configuration, please refer to the related Item –EUT Test Photos.

Note:

Both horizontal and vertical antenna polarities were tested and performed pretest to three orthogonal axis. The worst case emissions were reported

During the radiated emission test, the Spectrum Analyzer was set with the following configurations:

Frequency Band (MHz)	Function	Resolution bandwidth	Video Bandwidth
30 to 1000	QP	120 kHz	300 kHz
Above 1000	Peak	1 MHz	1 MHz
	Average	1 MHz	10 Hz

Note: for the frequency ranges below 30 MHz, a narrower RBW is used for these ranges but the measured value should add a RBW correction factor (RBWCF) where  $RBWCF [dB] = 10 \cdot \lg(100 [kHz] / \text{narrower RBW [kHz]})$ . , the narrower RBW is 1 kHz and RBWCF is 20 dB for the frequency 9 kHz to 150 kHz, and the narrower RBW is 10 kHz and RBWCF is 10 dB for the frequency 150 kHz to 30 MHz.

**3.2.6 TEST RESULTS (9KHZ – 30 MHZ)**

EUT:	notebook	Model Name. :	TEV-EL2in1-116-2
Temperature:	20 °C	Relative Humidity:	48%
Pressure:	1010 hPa	Test Voltage :	DC 7.6V
Test Mode :	TX	Polarization :	--

Freq. (MHz)	Reading (dBuV/m)	Limit (dBuV/m)	Margin (dB)	State P/F
--	--	--	--	N/A
--	--	--	--	N/A

**NOTE:**

The amplitude of spurious emissions which are attenuated by more than 20dB below the permissible value has no need to be reported.



### 3.2.7 TEST RESULTS (30MHZ – 1GHZ)

EUT :	notebook	Model Name. :	TEV-EL2in1-116-2
Temperature :	20 °C	Relative Humidity :	48%
Pressure :	1010 hPa	Test Voltage :	DC 7.6V
Test Mode :	TX(5.2G)- 802.11a (High CH)		

Polar (H/V)	Frequency	Meter Reading	Factor	Emission Level	Limits	Margin	Remark
	(MHz)	(dBuV)	(dB)	(dBuV/m)	(dBuV/m)	(dB)	
V	34.0949	9.36	18.13	27.49	40.00	-12.51	QP
V	40.8541	11.14	14.64	25.78	40.00	-14.22	QP
V	168.2365	15.80	12.11	27.91	43.50	-15.59	QP
V	448.7428	18.86	15.78	34.64	46.00	-11.36	QP
V	654.5295	21.67	20.52	42.19	46.00	-3.81	QP
V	680.5725	19.49	20.80	40.29	46.00	-5.71	QP

**Remark:**

Absolute Level= ReadingLevel+ Factor, Margin= Absolute Level - Limit

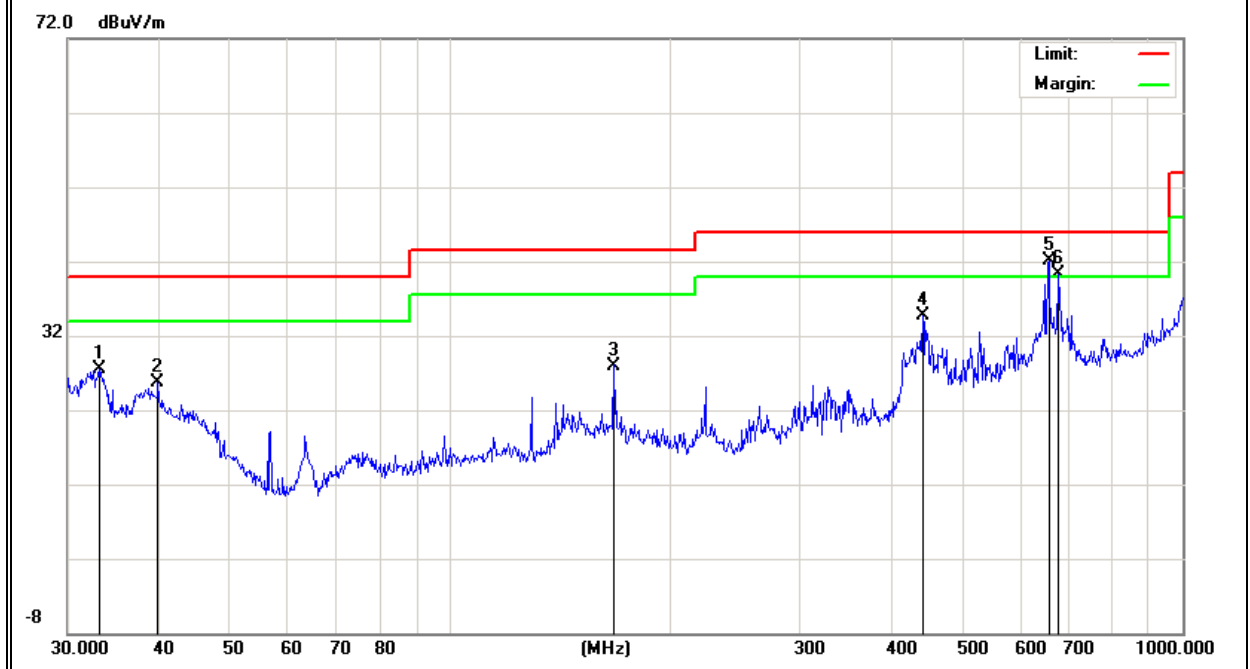

Polar (H/V)	Frequency	Meter Reading	Factor	Emission Level	Limits	Margin	Remark
	(MHz)	(dBuV)	(dB)	(dBuV/m)	(dBuV/m)	(dB)	
H	32.9616	6.65	19.22	25.87	40.00	-14.13	QP
H	225.9501	23.42	10.89	34.31	46.00	-11.69	QP
H	296.1475	17.45	12.45	29.9	46.00	-16.1	QP
H	448.4158	18.01	15.91	33.92	46.00	-12.08	QP
H	655.8264	22.52	20.59	43.11	46.00	-2.89	QP
H	894.8468	18.95	24.05	43.00	46.00	-3.00	QP

**Remark:**

Absolute Level= ReadingLevel+ Factor, Margin= Absolute Level - Limit

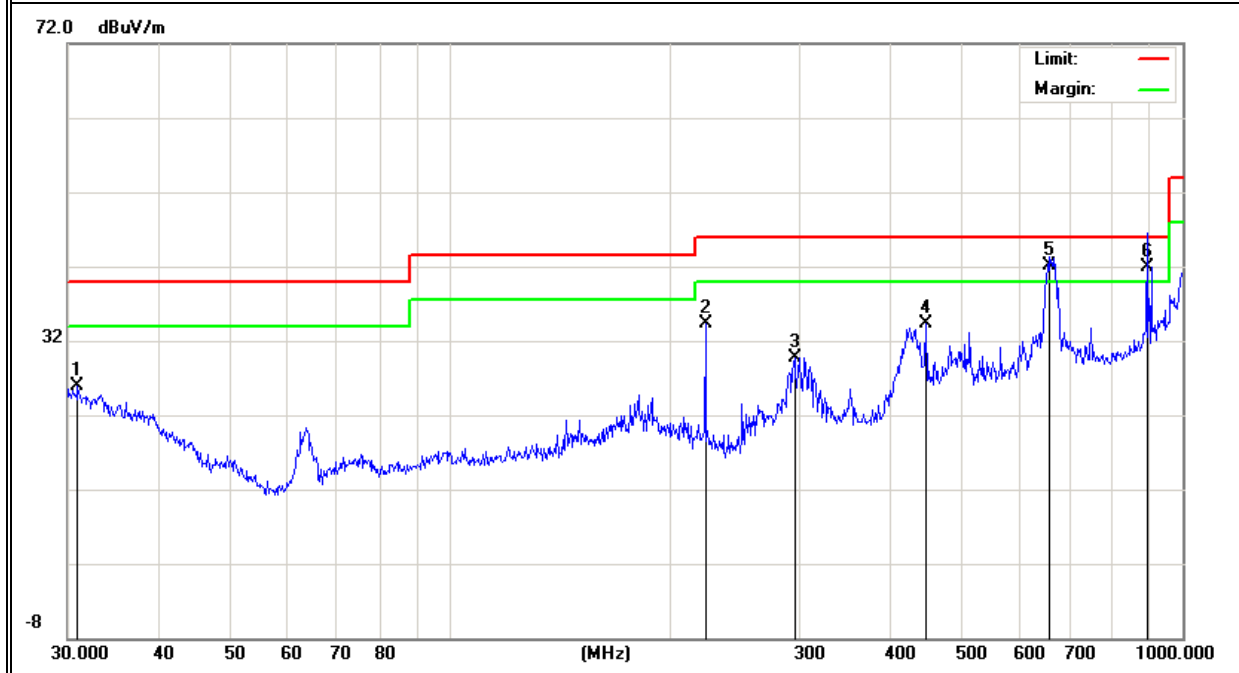

EUT :	notebook	Model Name. :	TEV-EL2in1-116-2
Temperature :	20 °C	Relative Humidity :	48%
Pressure :	1010 hPa	Test Voltage :	DC 7.6V
Test Mode :	TX(5.8G) - 802.11a (High CH)		

Polar (H/V)	Frequency	Meter Reading	Factor	Emission Level	Limits	Margin	Remark
	(MHz)	(dBuV)	(dB)	(dBuV/m)	(dBuV/m)	(dB)	
V	35.8550	17.56	17.06	34.62	40.00	-5.38	QP
V	63.7827	18.98	5.64	24.62	40.00	-15.38	QP
V	144.5718	18.65	11.27	29.92	43.50	-13.58	QP
V	160.6454	21.04	11.45	32.49	43.50	-11.01	QP
V	446.5641	19.03	15.91	34.94	46.00	-11.06	QP
V	661.1803	19.55	20.65	40.20	46.00	-5.80	QP

**Remark:**

Absolute Level= ReadingLevel+ Factor, Margin= Absolute Level - Limit

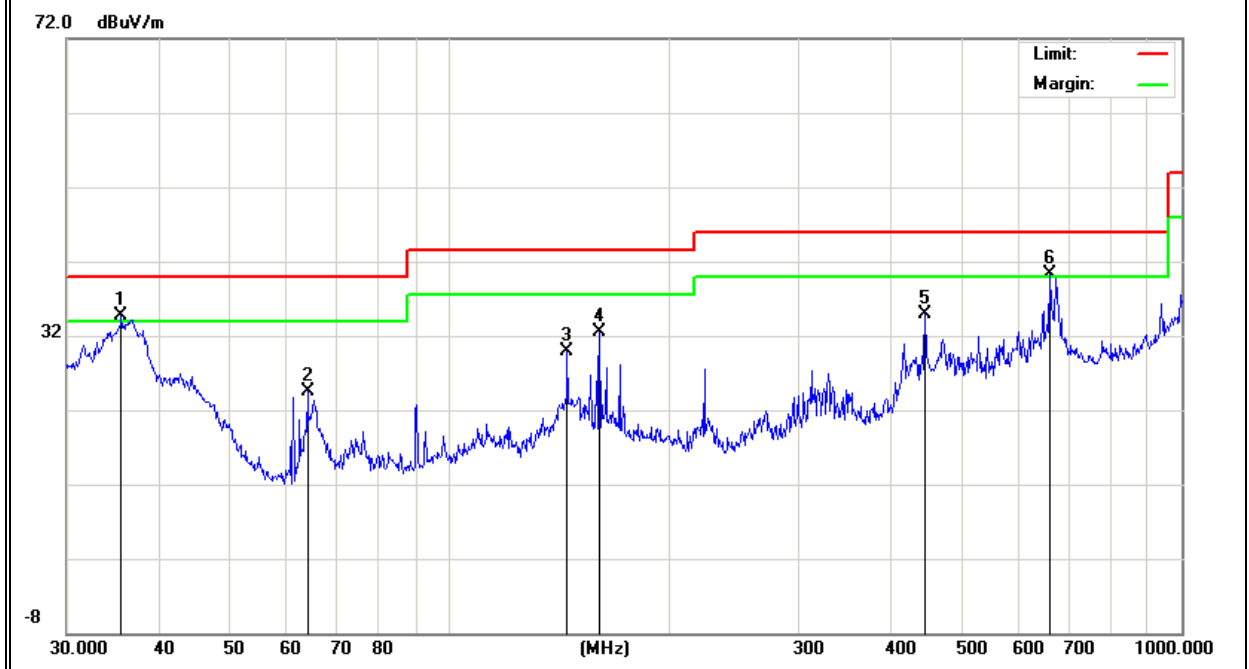

Polar (H/V)	Frequency	Meter Reading	Factor	Emission Level	Limits	Margin	Remark
	(MHz)	(dBuV)	(dB)	(dBuV/m)	(dBuV/m)	(dB)	
H	37.0248	8.11	16.33	24.44	40.00	-15.56	QP
H	65.3431	14.30	6.12	20.42	40.00	-19.58	QP
H	168.4138	19.24	12.30	31.54	43.50	-11.96	QP
H	222.9500	26.99	10.89	37.88	46.00	-8.12	QP
H	419.1080	23.70	14.67	38.37	46.00	-7.63	QP
H	651.9415	21.88	20.39	42.27	46.00	-3.73	QP

**Remark:**

Absolute Level= ReadingLevel+ Factor, Margin= Absolute Level - Limit

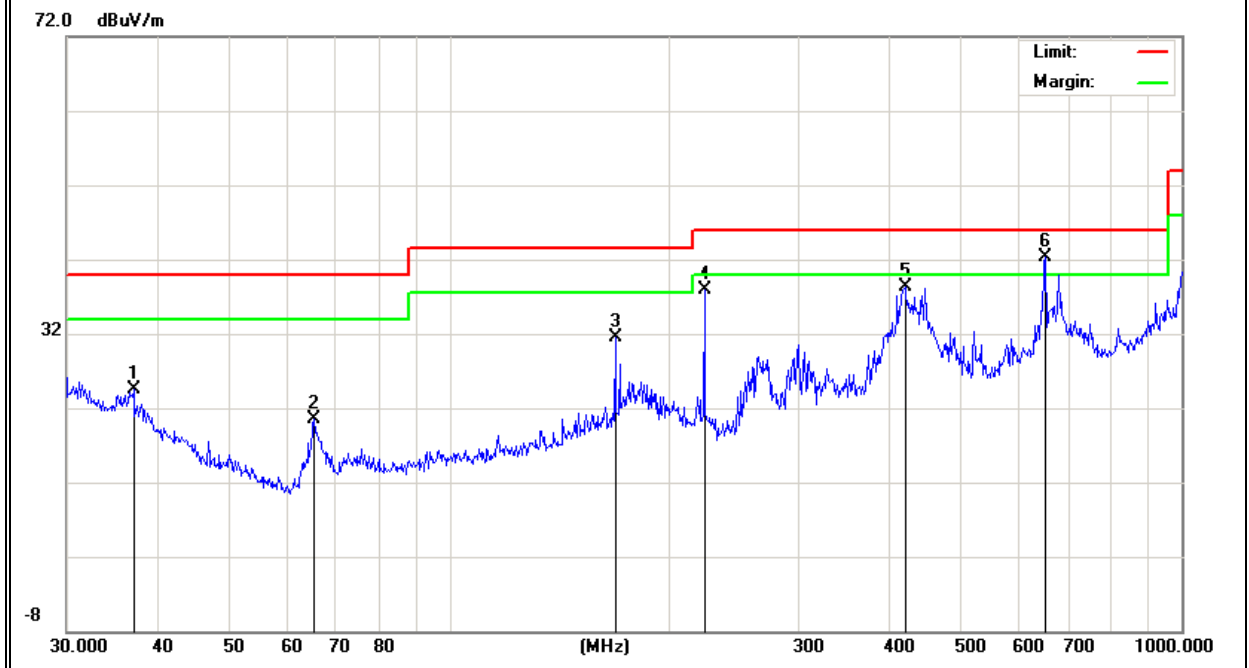

**3.2.8 TEST RESULTS (1GHz-26GHz)**

EUT :	notebook	Model Name. :	TEV-EL2in1-116-2
Temperature :	20 °C	Relative Humidity :	48%
Pressure :	1010 hPa	Test Voltage :	DC 7.6V
Test Mode :	TX(5.2G) - 802.11a_5180~5240MHz		

Polar	Frequency	Meter Reading	Cable loss	Antenna Factor	Preamp Factor	Emission Level	Limits	Margin	Detector Type
(H/V)	(MHz)	(dBuV)	(dB)	dB/m	(dB)	(dBuV/m)	(dBuV/m)	(dB)	
Low Channel (5180 MHz)-Above 1G									
Vertical	2462.126	55.16	5.94	35.40	44.00	52.5	74.00	-21.5	Pk
Vertical	2462.126	47.28	5.94	35.40	44.00	44.62	54.00	-9.38	AV
Vertical	10331.257	60.31	8.46	39.75	44.50	64.02	74.00	-9.98	Pk
Vertical	10331.257	46.28	8.46	39.75	44.50	49.99	54.00	-4.01	AV
Vertical	15527.221	58.38	10.12	38.80	44.10	63.2	74.00	-10.8	Pk
Vertical	15527.221	43.82	10.12	38.80	42.70	50.04	54.00	-3.96	AV
Horizontal	2434.261	59.32	5.94	35.18	44.00	56.44	74.00	-17.56	Pk
Horizontal	2434.261	43.28	5.94	35.18	44.00	40.4	54.00	-13.6	AV
Horizontal	10362.418	60.25	8.46	38.71	44.50	62.92	74.00	-11.08	Pk
Horizontal	10362.418	44.73	8.46	38.71	44.50	47.4	54.00	-6.6	AV
Horizontal	15542.257	58.26	10.12	38.38	44.10	62.66	74.00	-11.34	Pk
Horizontal	15542.257	44.17	10.12	38.38	44.10	48.57	54.00	-5.43	AV
middle Channel (5200 MHz)-Above 1G									
Vertical	2315.655	58.25	6.48	36.35	44.05	57.03	74.00	-16.97	Pk
Vertical	2315.124	43.05	6.48	36.35	44.05	41.83	54.00	-12.17	AV
Vertical	10400.229	62.15	8.47	37.88	44.51	63.99	74.00	-10.01	Pk
Vertical	10400.215	45.21	8.47	37.88	44.51	47.05	54.00	-6.95	AV
Vertical	15560.151	57.25	10.12	38.8	44.10	62.07	74.00	-11.93	Pk
Vertical	15560.322	42.12	10.12	38.8	42.70	48.34	54.00	-5.66	AV
Horizontal	2441.128	58.36	6.48	36.37	44.05	57.16	74.00	-16.84	Pk
Horizontal	2441.11	43.12	6.48	36.37	44.05	41.92	54.00	-12.08	AV
Horizontal	10401.283	60.27	8.47	38.64	44.50	62.88	74.00	-11.12	Pk
Horizontal	10401.263	46.25	8.47	38.64	44.50	48.86	54.00	-5.14	AV
Horizontal	15561.258	57.38	10.12	38.38	44.10	61.78	74.00	-12.22	Pk
Horizontal	15561.035	43.15	10.12	38.38	44.10	47.55	54.00	-6.45	AV
High Channel (5240 MHz)-Above 1G									
Vertical	2418.262	56.22	7.10	37.24	43.50	57.06	74.00	-16.94	Pk
Vertical	2418.232	42.85	7.10	37.24	43.50	43.69	54.00	-10.31	AV
Vertical	10480.109	61.24	8.46	37.68	44.50	62.88	74.00	-11.12	Pk
Vertical	10480.117	45.27	8.46	37.68	44.50	46.91	54.00	-7.09	AV
Vertical	15720.061	57.18	10.12	38.8	44.10	62	74.00	-12	Pk
Vertical	15720.145	41.25	10.12	38.8	42.70	47.47	54.00	-6.53	AV
Horizontal	2413.165	59.25	7.10	37.24	43.50	60.09	74.00	-13.91	Pk
Horizontal	2413.266	42.13	7.10	37.24	43.50	42.97	54.00	-11.03	AV
Horizontal	10480.812	57.62	8.46	38.57	44.50	60.15	74.00	-13.85	Pk
Horizontal	10480.157	45.12	8.46	38.57	44.50	47.65	54.00	-6.35	AV
Horizontal	15720.134	58.16	10.12	38.38	44.10	62.56	74.00	-11.44	Pk
Horizontal	15720.115	42.33	10.12	38.38	44.10	46.73	54.00	-7.27	AV

Note:"802.11a(5G)" mode is the worst mode. PK value is lower than the Average value limit, So average didn't record.

The amplitude of spurious emissions that are attenuated by more than 20dB below the permissible value has no need to be reported.

Emission level (dBuV/m) = 20 log Emission level (uV/m).

Corrected Reading: Antenna Factor + Cable Loss + Read Level - Preamp Factor = Level.

EUT :	notebook	Model Name. :	TEV-EL2in1-116-2
Temperature :	20 °C	Relative Humidity :	48%
Pressure :	1010 hPa	Test Voltage :	DC 7.6V
Test Mode :	TX (5.8G) -- 802.11a_5745~5825MHz		

Polar	Frequency	Meter Reading	Cable loss	Antenna Factor	Preamp Factor	Emission Level	Limits	Margin	Detector Type
(H/V)	(MHz)	(dBuV)	(dB)	dB/m	(dB)	(dBuV/m)	(dBuV/m)	(dB)	
Low Channel (5745 MHz)-Above 1G									
Vertical	4679.234	53.21	5.94	35.40	44.00	50.55	74.00	-23.45	Pk
Vertical	4679.234	42.71	5.94	35.40	44.00	40.05	54.00	-13.95	AV
Vertical	11490.227	61.02	8.46	39.75	44.50	64.73	74.00	-9.27	Pk
Vertical	11490.227	43.72	8.46	39.75	44.50	47.43	54.00	-6.57	AV
Vertical	17235.265	57.41	10.12	38.80	44.10	62.23	74.00	-11.77	Pk
Vertical	17235.154	41.51	10.12	38.80	42.70	47.73	54.00	-6.27	AV
Horizontal	4679.639	58.34	5.94	35.18	44.00	55.46	74.00	-18.54	Pk
Horizontal	4679.639	45.27	5.94	35.18	44.00	42.39	54.00	-11.61	AV
Horizontal	11490.128	58.54	8.46	38.71	44.50	61.21	74.00	-12.79	Pk
Horizontal	10360.605	42.71	8.46	38.71	44.50	45.38	54.00	-8.62	AV
Horizontal	17235.111	57.32	10.12	38.38	44.10	61.72	74.00	-12.28	Pk
Horizontal	17235.109	43.12	10.12	38.38	44.10	47.52	54.00	-6.48	AV
middle Channel (5785 MHz)-Above 1G									
Vertical	4592.256	58.47	6.48	36.35	44.05	57.25	74.00	-16.75	Pk
Vertical	4592.256	44.12	6.48	36.35	44.05	42.9	54.00	-11.1	AV
Vertical	11570.199	61.25	8.47	37.88	44.51	63.09	74.00	-10.91	Pk
Vertical	11570.199	42.58	8.47	37.88	44.51	44.42	54.00	-9.58	AV
Vertical	17355.128	58.41	10.12	38.8	44.10	63.23	74.00	-10.77	Pk
Vertical	17355.128	41.25	10.12	38.8	42.70	47.47	54.00	-6.53	AV
Horizontal	4592.535	57.62	6.48	36.37	44.05	56.42	74.00	-17.58	Pk
Horizontal	4592.535	42.13	6.48	36.37	44.05	40.93	54.00	-13.07	AV
Horizontal	11570.271	62.51	8.47	38.64	44.50	65.12	74.00	-8.88	Pk
Horizontal	11570.271	43.82	8.47	38.64	44.50	46.43	54.00	-7.57	AV
Horizontal	17355.247	56.45	10.12	38.38	44.10	60.85	74.00	-13.15	Pk
Horizontal	17356.721	43.27	10.12	38.38	44.10	47.67	54.00	-6.33	AV
High Channel (5825 MHz)-Above 1G									
Vertical	6039.235	56.24	7.10	37.24	43.50	57.08	74.00	-16.92	Pk
Vertical	6039.235	41.25	7.10	37.24	43.50	42.09	54.00	-11.91	AV
Vertical	11652.838	57.82	8.46	37.68	44.50	59.46	74.00	-14.54	Pk
Vertical	11652.838	43.17	8.46	37.68	44.50	44.81	54.00	-9.19	AV
Vertical	17473.128	57.74	10.12	38.8	44.10	62.56	74.00	-11.44	Pk
Vertical	17473.107	41.02	10.12	38.8	42.70	47.24	54.00	-6.76	AV
Horizontal	6039.101	58.22	7.10	37.24	43.50	59.06	74.00	-14.94	Pk
Horizontal	6039.101	42.35	7.10	37.24	43.50	43.19	54.00	-10.81	AV
Horizontal	11652.283	55.18	8.46	38.57	44.50	57.71	74.00	-16.29	Pk
Horizontal	11652.283	41.05	8.46	38.57	44.50	43.58	54.00	-10.42	AV
Horizontal	17474.247	57.31	10.12	38.38	44.10	61.71	74.00	-12.29	Pk
Horizontal	17474.721	42.12	10.12	38.38	44.10	46.52	54.00	-7.48	AV

Note:"802.11a(5G)" mode is the worst mode. PK value is lower than the Average value limit, So average didn't record.

The amplitude of spurious emissions that are attenuated by more than 20dB below the permissible value

has no need to be reported.

Emission level (dBuV/m) = 20 log Emission level (uV/m).

Corrected Reading: Antenna Factor + Cable Loss + Read Level - Preamp Factor = Level.

**3.2.9 TEST RESULTS (26GHZ-40GHZ)**

EUT :	notebook	Model Name. :	TEV-EL2in1-116-2
Temperature :	20 °C	Relative Humidity :	48%
Pressure :	1010 hPa	Test Voltage :	DC 7.6V
Test Mode :	TX (5.2G)-802.11a 5180MHz~5240MHz , TX (5.8G)-802.11a 5745MHz~5825MHz		

All the modulation modes have been tested, and the worst result was report as below:

Low Channel (5180 MHz)-Above 1G

Horizontal

FCC Electric Field Strength 26.5-40GHz

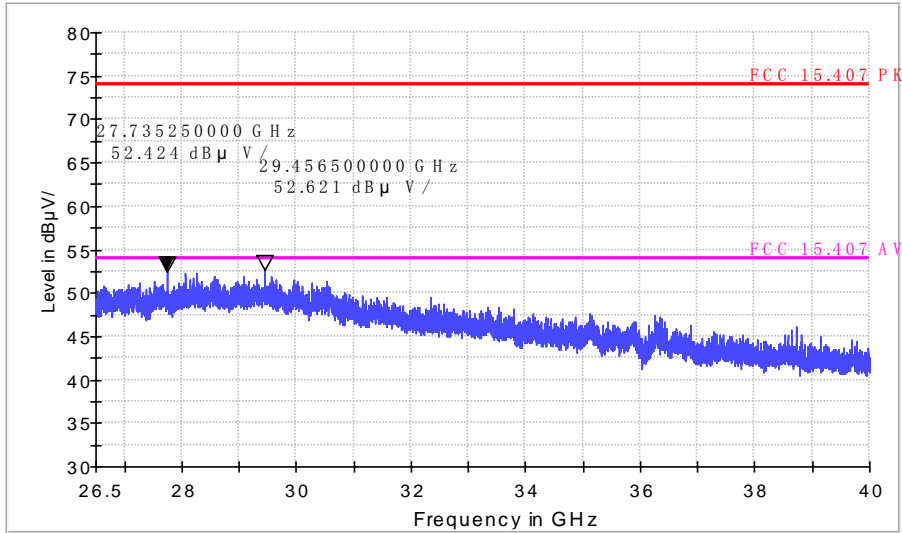

Vertical

FCC Electric Field Strength 26.5-40GHz

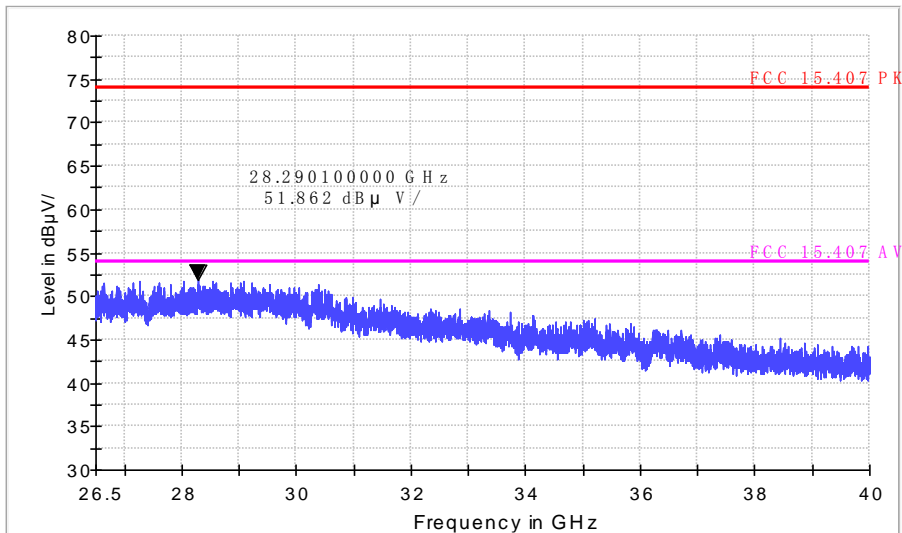

### High Channel (5240 MHz)-Above 1G

Horizontal

FCC Electric Field Strength 26.5-40GHz

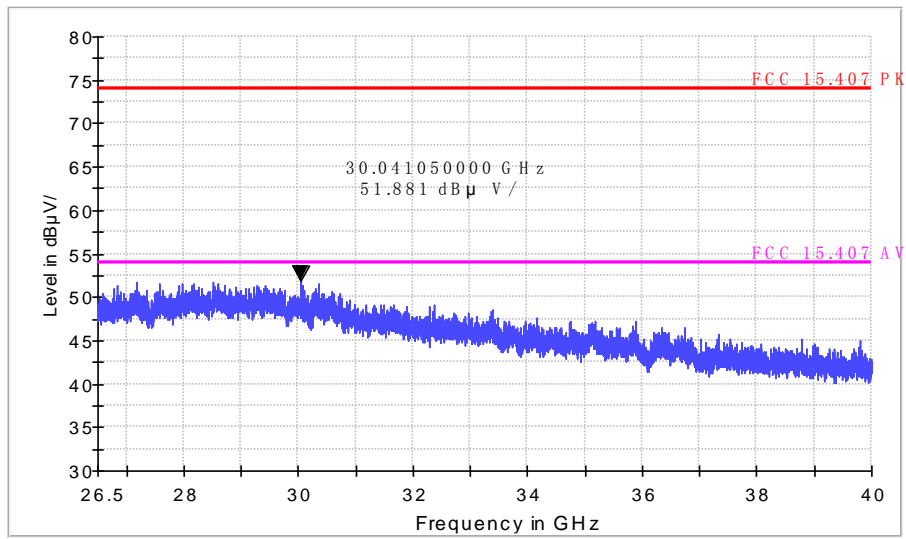

Vertical

FCC Electric Field Strength 26.5-40GHz

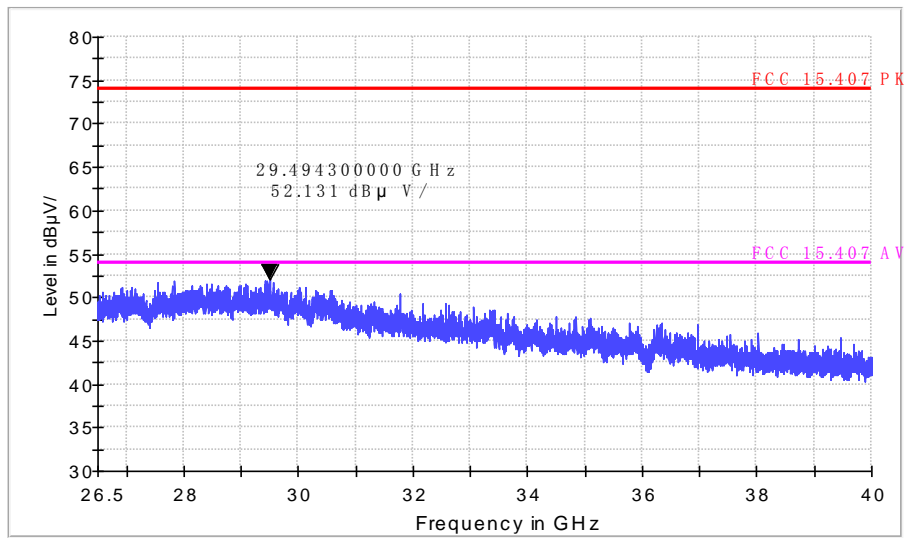



### Low Channel (5745 MHz)-Above 1G

Horizontal

FCC Electric Field Strength 26.5-40GHz

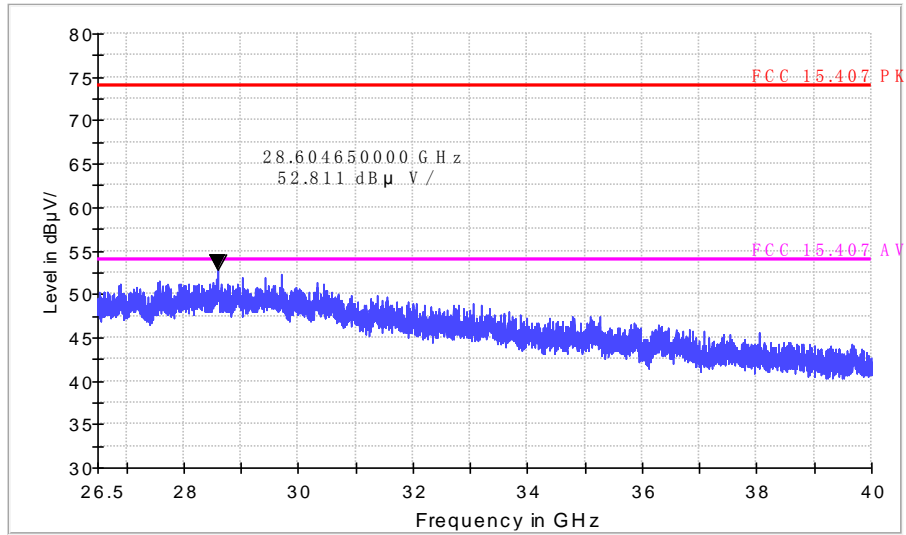

Vertical

FCC Electric Field Strength 26.5-40GHz

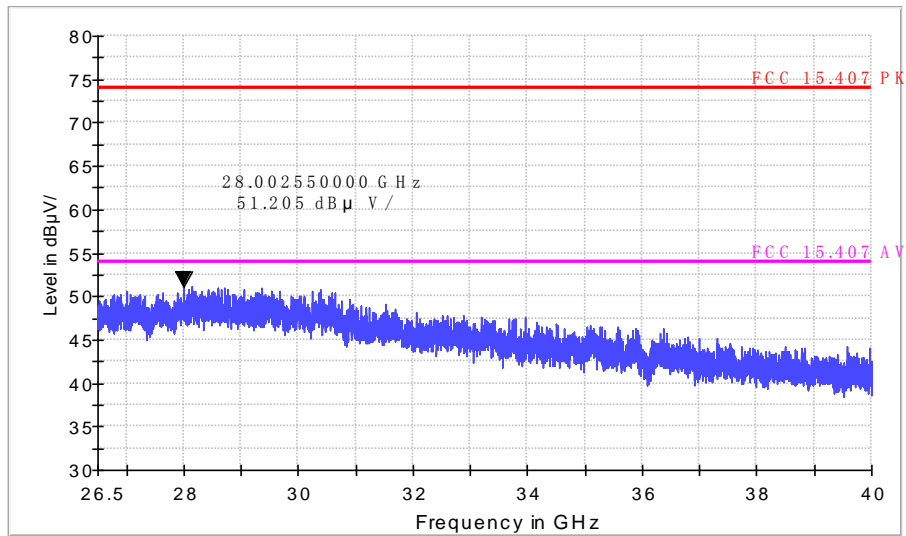

### High Channel (5825 MHz)-Above 1G

Horizontal

FCC Electric Field Strength 26.5-40GHz

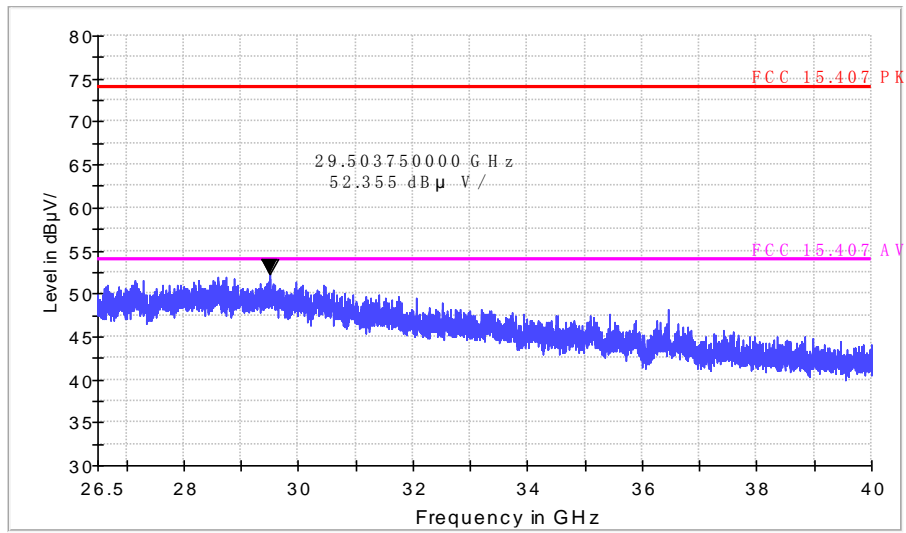

Vertical

FCC Electric Field Strength 26.5-40GHz

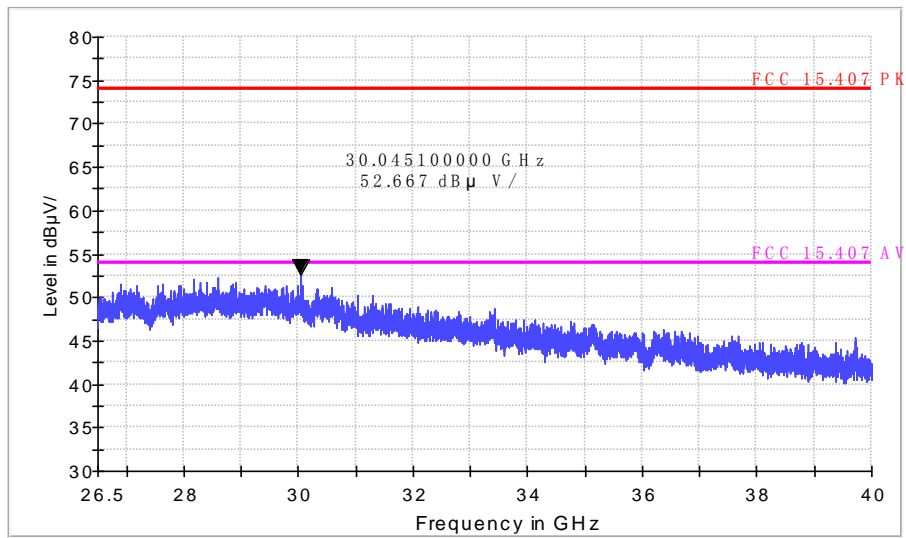

## 4. POWER SPECTRAL DENSITY TEST

### 4.1 APPLIED PROCEDURES / LIMIT

#### According to FCC §15.407(a)(3)

For the band 5.15-5.25 GHz,

(i) For an outdoor access point operating in the band 5.15-5.25 GHz, the maximum power spectral density shall not exceed 17 dBm in any 1 megahertz band. If transmitting antennas of directional gain greater than 6 dBi are used, both the maximum conducted output power and the maximum power spectral density shall be reduced by the amount in dB that the directional gain of the antenna exceeds 6 dBi. The maximum e.i.r.p. at any elevation angle above 30 degrees as measured from the horizon must not exceed 125 mW (21 dBm).

(ii) For an indoor access point operating in the band 5.15-5.25 GHz, the maximum power spectral density shall not exceed 17 dBm in any 1 megahertz band. If transmitting antennas of directional gain greater than 6 dBi are used, both the maximum conducted output power and the maximum power spectral density shall be reduced by the amount in dB that the directional gain of the antenna exceeds 6 dBi.

(iii) For fixed point-to-point access points operating in the band 5.15-5.25 GHz, the maximum power spectral density shall not exceed 17 dBm in any 1 megahertz band. Fixed point-to-point U-NII devices may employ antennas with directional gain up to 23 dBi without any corresponding reduction in the maximum conducted output power or maximum power spectral density. For fixed point-to-point transmitters that employ a directional antenna gain greater than 23 dBi, a 1 dB reduction in maximum conducted output power and maximum power spectral density is required for each 1 dB of antenna gain in excess of 23 dBi. Fixed, point-to-point operations exclude the use of point-to-multipoint systems, omnidirectional applications, and multiple collocated transmitters transmitting the same information. The operator of the U-NII device, or if the equipment is professionally installed, the installer, is responsible for ensuring that systems employing high gain directional antennas are used exclusively for fixed, point-to-point operations.

(iv) For client devices in the 5.15-5.25 GHz band, the maximum power spectral density shall not exceed 11 dBm in any 1 megahertz band. If transmitting antennas of directional gain greater than 6 dBi are used, both the maximum conducted output power and the maximum power spectral density shall be reduced by the amount in dB that the directional gain of the antenna exceeds 6 dBi.

For the band 5.725-5.85 GHz

(3) For the band 5.725-5.85 GHz, the maximum power spectral density shall not exceed 30 dBm in any 500-kHz band. If transmitting antennas of directional gain greater than 6 dBi are used, both the maximum conducted output power and the maximum power spectral density shall be reduced by the amount in dB that the directional gain of the antenna exceeds 6 dBi.

## 4.2 TEST PROCEDURE

For devices operating in the bands 5.15-5.25 GHz, 5.25-5.35 GHz, and 5.47-5.725 GHz, the above procedures make use of 1 MHz RBW to satisfy directly the 1 MHz reference bandwidth specified in § 15.407(a)(5). For devices operating in the band 5.725-5.85 GHz, the rules specify a measurement bandwidth of 500 kHz. Many spectrum analyzers do not have 500 kHz RBW, thus a narrower RBW may need to be used. The rules permit the use of a RBWs less than 1 MHz, or 500 kHz, “provided that the measured power is integrated over the full reference bandwidth” to show the total power over the specified measurement bandwidth (i.e., 1 MHz, or 500 kHz). If measurements are performed using a reduced resolution bandwidth (< 1 MHz, or < 500 kHz) and integrated over 1 MHz, or 500 kHz bandwidth, the following adjustments to the procedures apply:

- a) Set  $RBW \geq 1/T$ , where T is defined in section II.B.I.a).
- b) Set  $VBW \geq 3 RBW$ .
- c) If measurement bandwidth of Maximum PSD is specified in 500 kHz, add  $10\log(500\text{kHz}/RBW)$  to the measured result, whereas  $RBW (< 500 \text{ KHz})$  is the reduced resolution bandwidth of the spectrum analyzer set during measurement.
- d) If measurement bandwidth of Maximum PSD is specified in 1 MHz, add  $10\log(1\text{MHz}/RBW)$  to the measured result, whereas  $RBW (< 1 \text{ MHz})$  is the reduced resolution bandwidth of spectrum analyzer set during measurement.
- e) Care must be taken to ensure that the measurements are performed during a period of continuous transmission or are corrected upward for duty cycle.

Note: As a practical matter, it is recommended to use reduced RBW of 100 KHz for the sections 5.c) and 5.d) above, since  $RBW=100 \text{ KHz}$  is available on nearly all spectrum analyzers.

## 4.3 DEVIATION FROM STANDARD

No deviation.

## 4.4 TEST SETUP

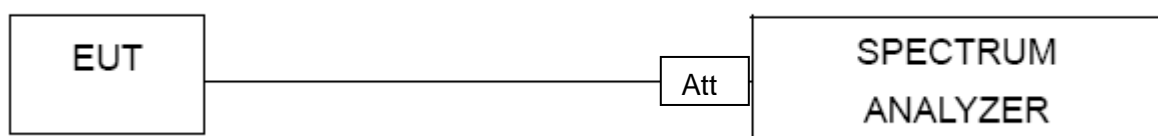

## 4.5 EUT OPERATION CONDITIONS

The EUT tested system was configured as the statements of 2.1 Unless otherwise a special operating condition is specified in the follows during the testing.

#### 4.6 TEST RESULTS

EUT :	notebook	Model Name. :	TEV-EL2in1-116-2
Temperature :	25 °C	Relative Humidity :	56%
Pressure :	1015 hPa	Test Voltage :	DC 7.6V
Test Mode :	TX Frequency Band I (5150-5250MHz)		

Note: A(B) Represent the value of antenna A and B, The worst data is Antenna B ,only shown Antenna B Plot.

Mode	Frequency	Measured Power Density (dBm)	Measured Power Density (dBm)	Limit (dBm)	Result
		Antenna A	Antenna B		
802.11 a	5180 MHz	2.96	4.80	11	PASS
	5200 MHz	3.83	4.60	11	PASS
	5240 MHz	4.98	5.45	11	PASS
802.11 n20	5180 MHz	1.77	4.26	11	PASS
	5200 MHz	0.01	4.09	11	PASS
	5240 MHz	1.73	4.97	11	PASS
802.11 n40	5190 MHz	-2.04	0.55	11	PASS
	5230 MHz	-1.66	1.06	11	PASS
802.11 AC20	5180 MHz	1.54	3.48	11	PASS
	5200 MHz	-4.36	2.89	11	PASS
	5240 MHz	1.49	3.02	11	PASS
802.11 AC40	5190 MHz	-1.51	0.06	11	PASS
	5230 MHz	-0.73	0.08	11	PASS
802.11 AC80	5210 MHz	-4.17	-3.51	11	PASS

Note: The wireless module is 1x1 Wi-Fi support 802.11b / g / n / ac; does not support MIMO  
 Note: For 802.11a/n (20/40)/ac(20/40/80) Directional gain=GANT +10log(N)dBi =1.26dBi  
 1.26dBi<6.0 dBi so Power Density limit= 11

(802.11a) PSD plot on channel 36

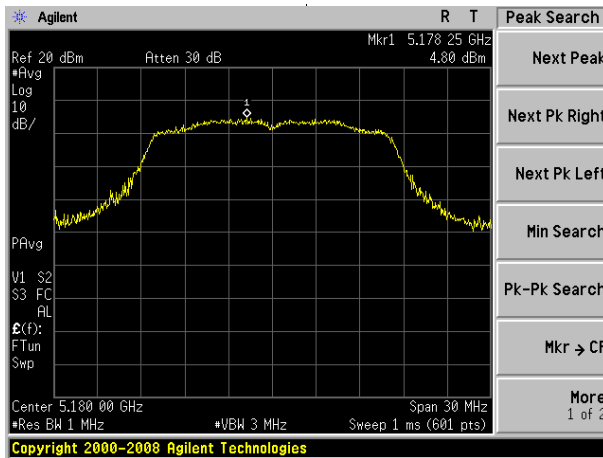

(802.11n20) PSD plot on channel 36

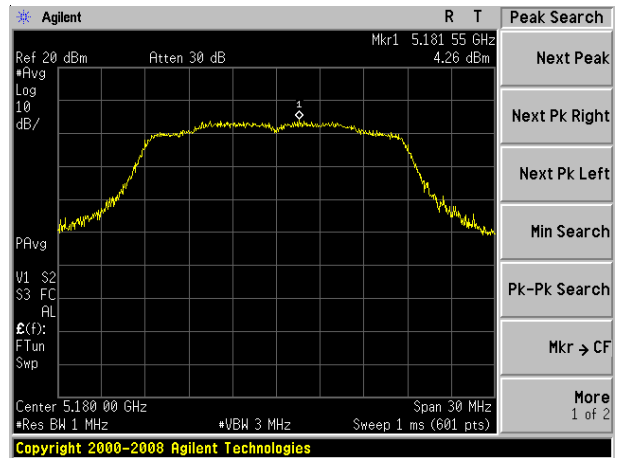

(802.11a) PSD plot on channel 40

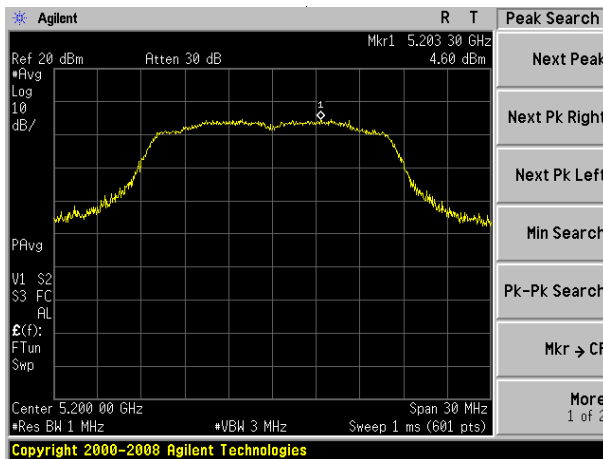

(802.11n20) PSD plot on channel 40

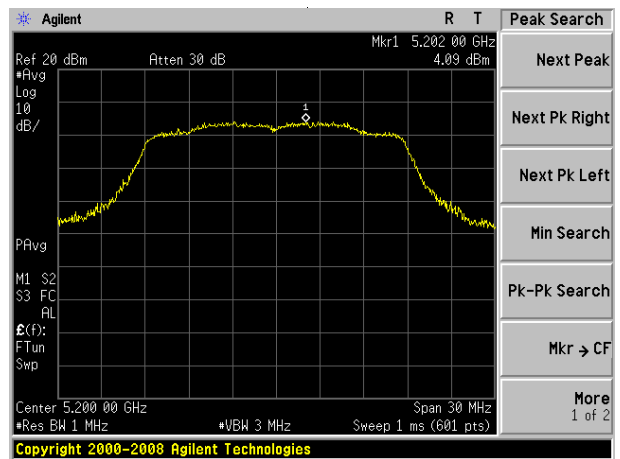

(802.11a) PSD plot on channel 48

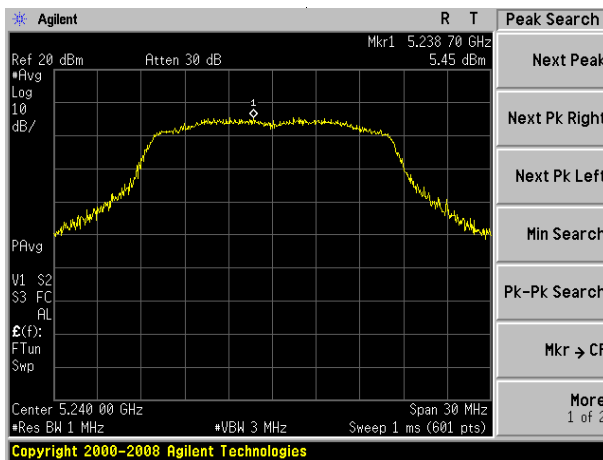

(802.11n20) PSD plot on channel 48

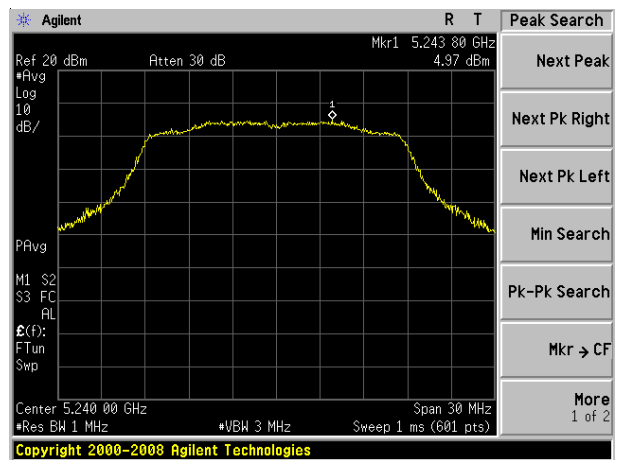

(802.11n40) PSD plot on channel 38

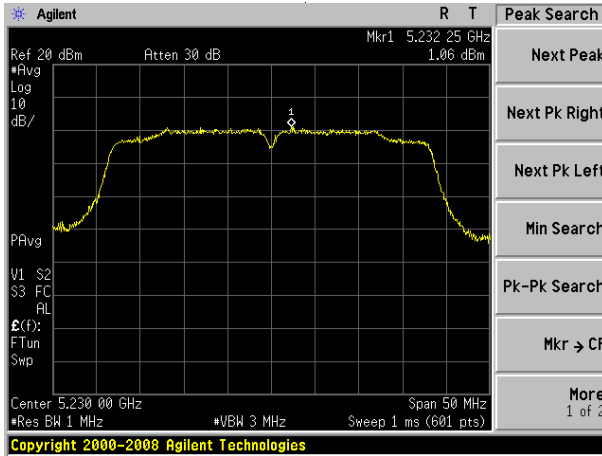

(802.11ac20) PSD plot on channel 36

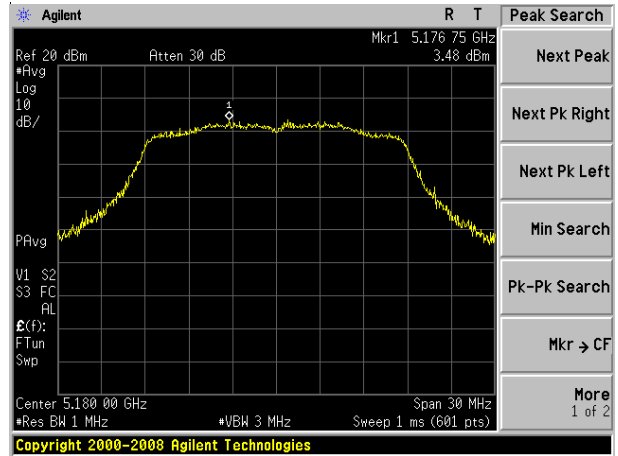

(802.11n40) PSD plot on channel 46

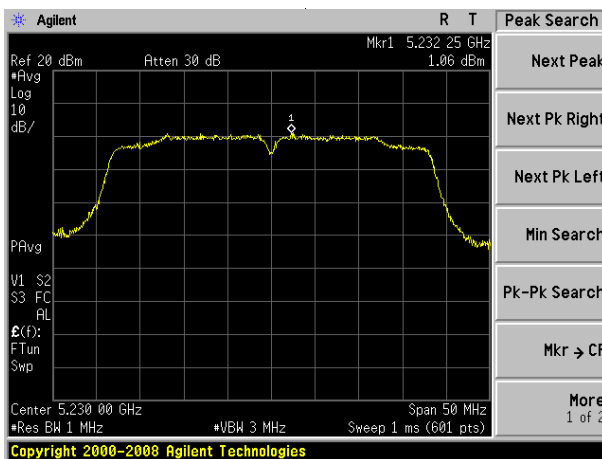

(802.11ac20) PSD plot on channel 40

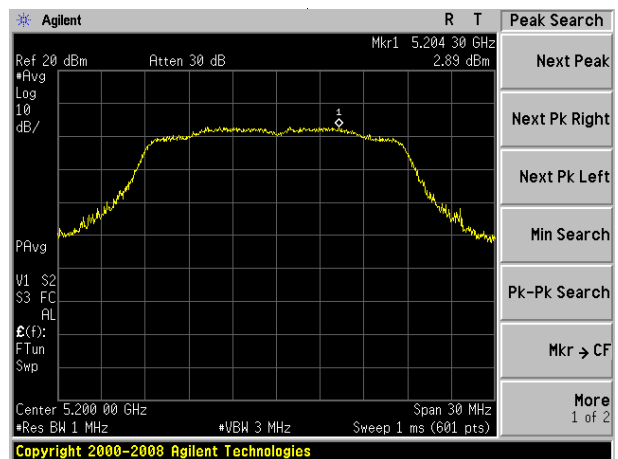

(802.11ac20) PSD plot on channel 48

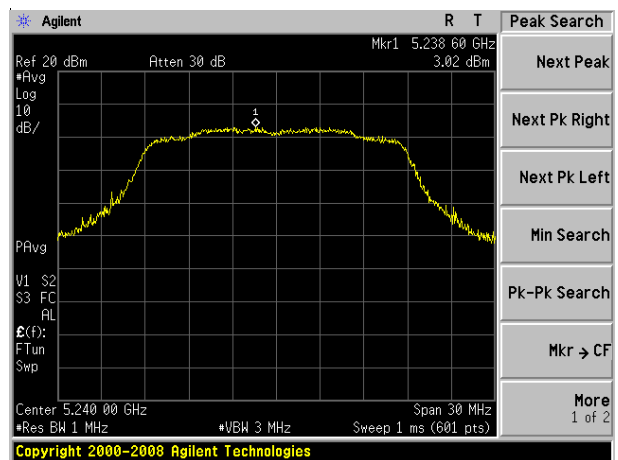

(802.11ac40) PSD plot on channel 38

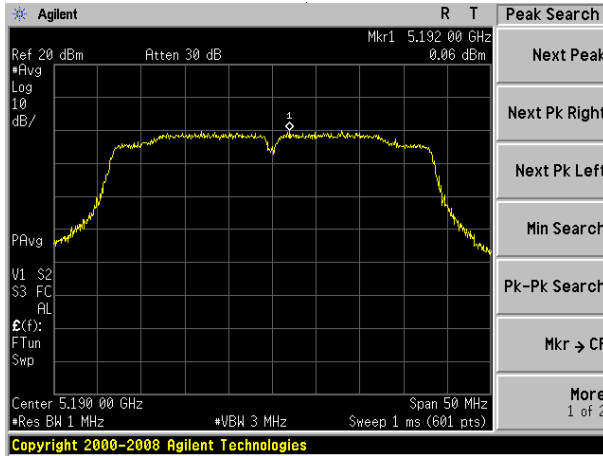

(802.11ac80) PSD plot on channel 42

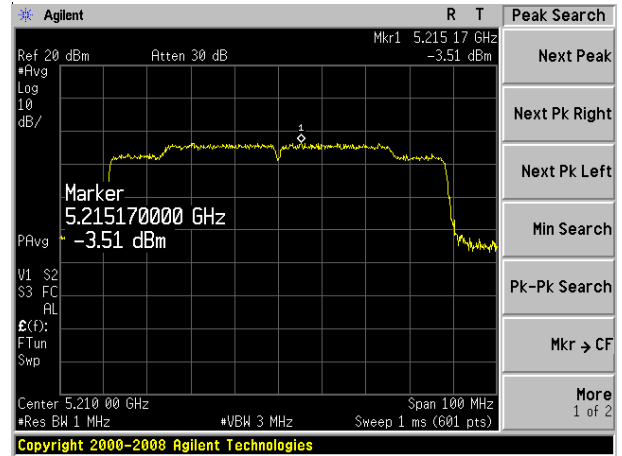

(802.11ac40) PSD plot on channel 46

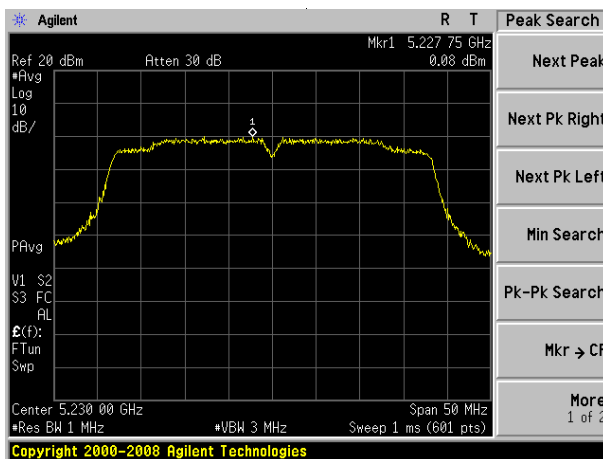



EUT :	notebook	Model Name. :	TEV-EL2in1-116-2
Temperature :	25 °C	Relative Humidity :	56%
Pressure :	1015 hPa	Test Voltage :	DC 7.6V
Test Mode :	TX Frequency Band IV (5745-5825MHz)		

Note: A(B) Represent the value of antenna A and B, The worst data is Antenna A ,only shown Antenna A Plot.

Mode	Frequency	Measured Power Density (dBm)	Measured Power Density (dBm)	Total Power Density (dBm)	Result
		Antenna A	Antenna B		
802.11 a	5745 MHz	4.087	4.382	30	PASS
	5785 MHz	5.206	5.512	30	PASS
	5825 MHz	5.792	6.121	30	PASS
802.11 n20	5745 MHz	3.116	0.074	30	PASS
	5785 MHz	2.669	2.323	30	PASS
	5825 MHz	3.142	2.148	30	PASS
802.11 n40	5755 MHz	-1.485	-1.250	30	PASS
	5795 MHz	-1.092	-0.252	30	PASS
802.11 AC20	5745 MHz	1.880	0.067	30	PASS
	5785 MHz	3.271	1.631	30	PASS
	5825 MHz	2.427	2.656	30	PASS
802.11 AC40	5755 MHz	-0.606	-1.764	30	PASS
	5795 MHz	1.083	-0.632	30	PASS
802.11 AC80	5775 MHz	-3.379	-3.981	30	PASS

Note: The wireless module is 1x1 Wi-Fi support 802.11b / g / n / ac; does not support MIMO  
 Note: For 802.11a/n (20/40)/ac(20/40/80) Directional gain=GANT +10log(N)dBi =1.26dBi  
 1.26dBi<6.0 dBi so Power Density limit= 30

(802.11a) PSD plot on channel 149

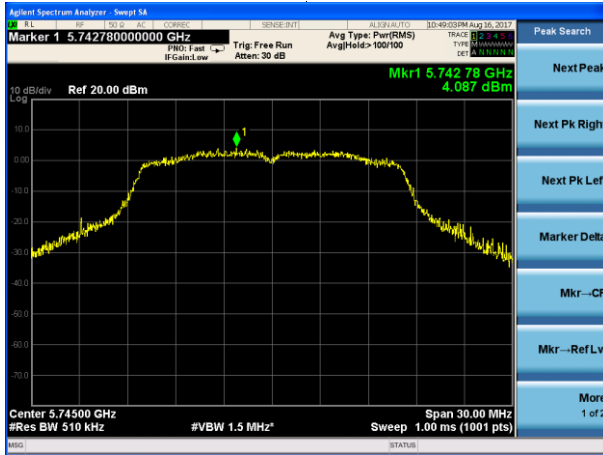

(802.11n20) PSD plot on channel 149

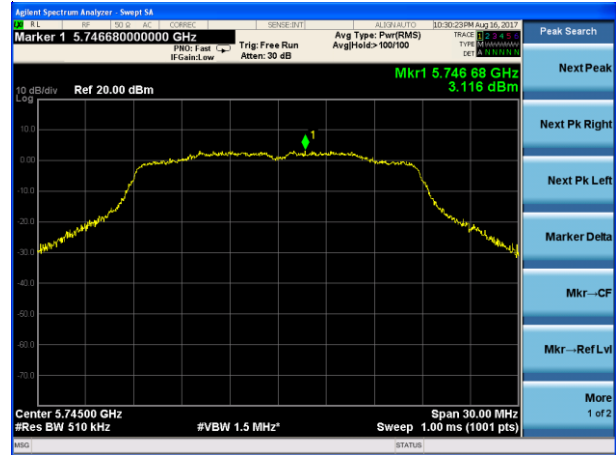

(802.11a) PSD plot on channel 157

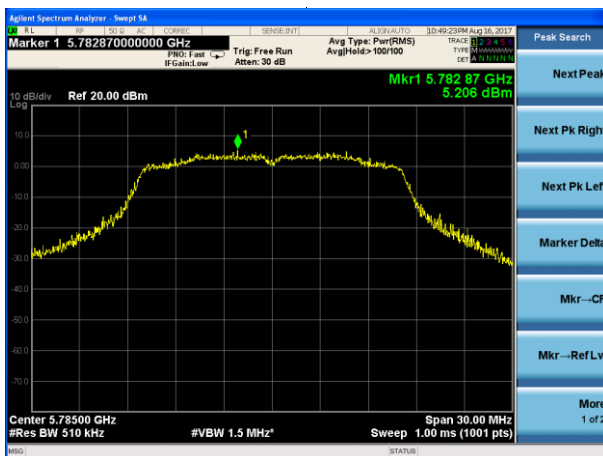

(802.11n20) PSD plot on channel 157

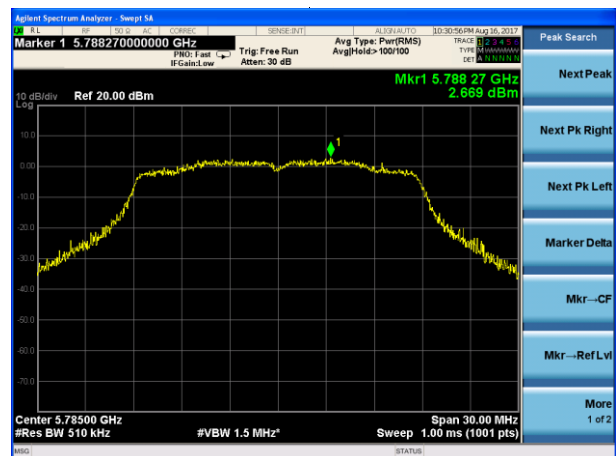

(802.11a) PSD plot on channel 165

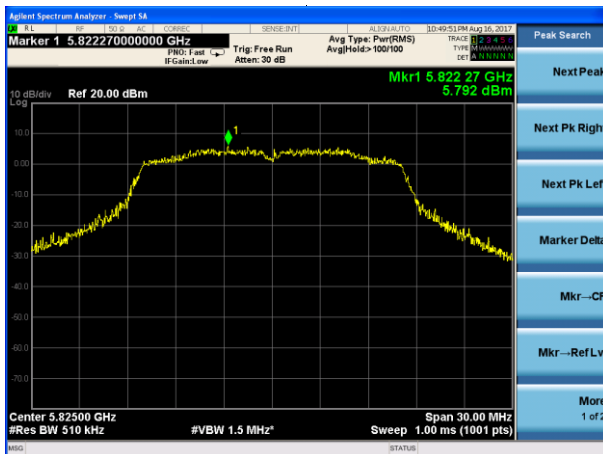

(802.11n20) PSD plot on channel 165

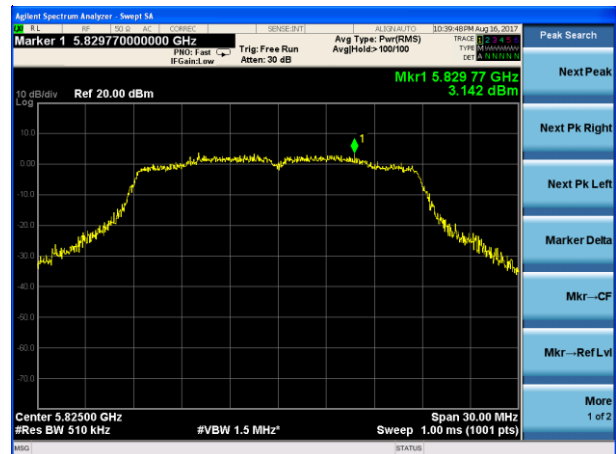

(802.11n40) PSD plot on channel 151

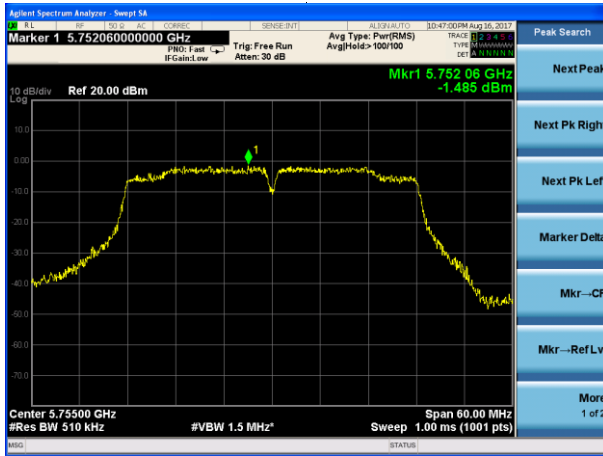

(802.11ac20) PSD plot on channel 149

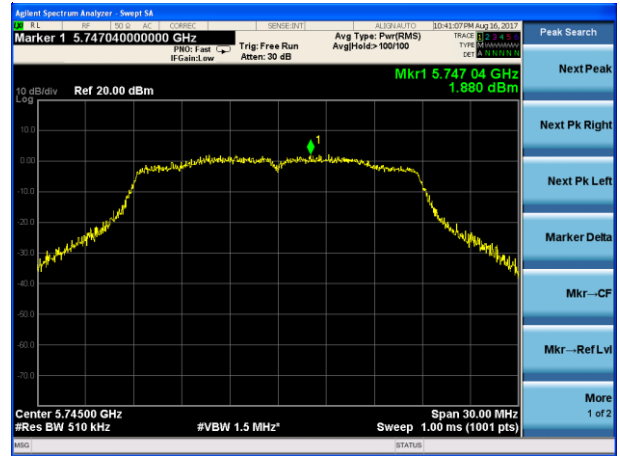

(802.11n40) PSD plot on channel 159

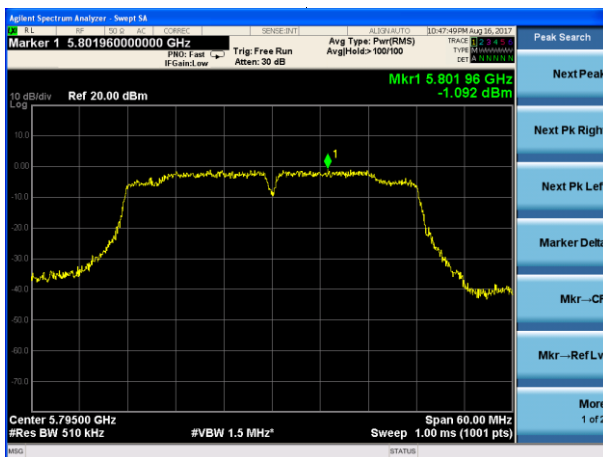

(802.11ac20) PSD plot on channel 157

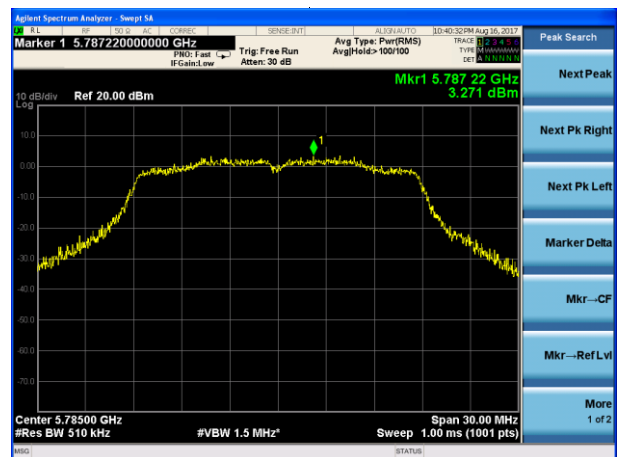

(802.11ac20) PSD plot on channel 165

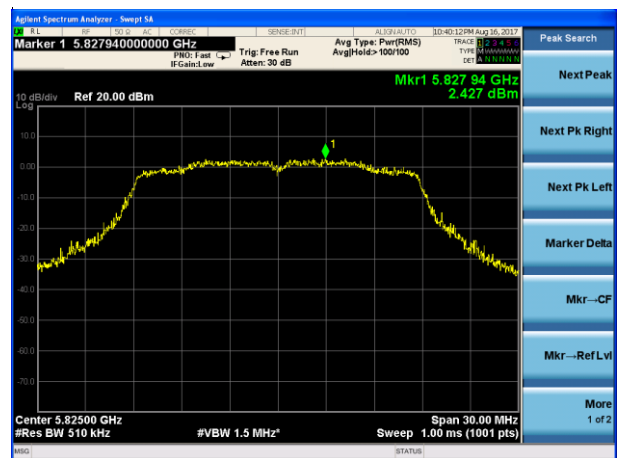

(802.11ac40) PSD plot on channel 151

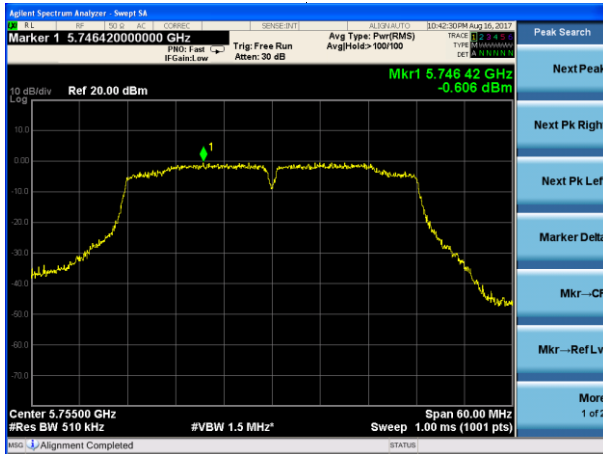

(802.11ac80) PSD plot on channel 155

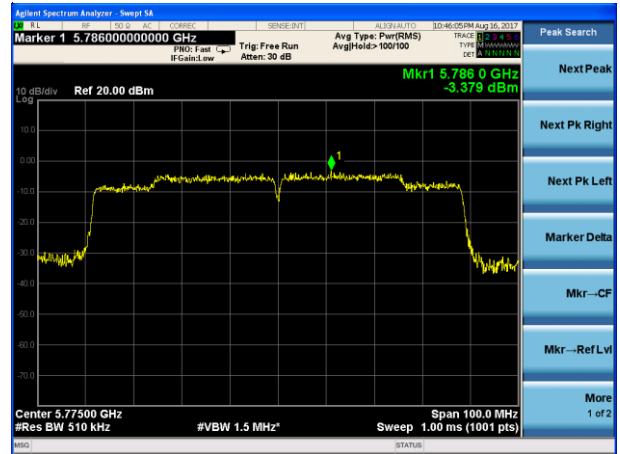

(802.11ac40) PSD plot on channel 159

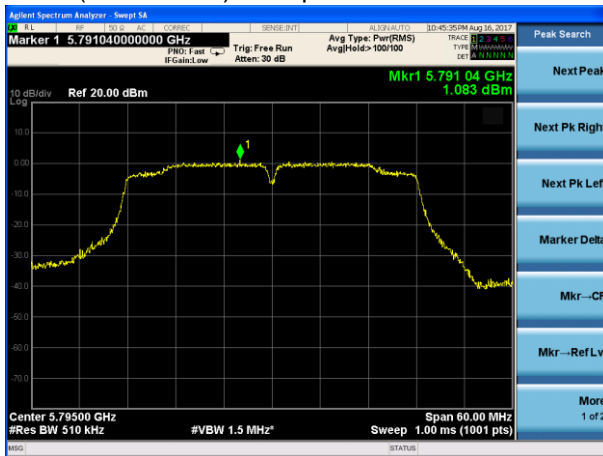

## 5. 26DB & 99% EMISSION BANDWIDTH

### 5.1 APPLIED PROCEDURES / LIMIT

The maximum power spectral density is measured as a conducted emission by direct connection of a calibrated test instrument to the equipment under test. If the device cannot be connected directly, alternative techniques acceptable to the Commission may be used. Measurements in the 5.725-5.85 GHz band are made over a reference bandwidth of 500 kHz or the 26 dB emission bandwidth of the device, whichever is less. Measurements in the 5.15-5.25 GHz, 5.25-5.35 GHz, and the 5.47-5.725 GHz bands are made over a bandwidth of 1 MHz or the 26 dB emission bandwidth of the device, whichever is less. A narrower resolution bandwidth can be used, provided that the measured power is integrated over the full reference bandwidth.

### 5.2 TEST PROCEDURE

- a) Set RBW = approximately 1% of the emission bandwidth.
- b) Set the VBW > RBW.
- c) Detector = Peak.
- d) Trace mode = max hold.
- e) Measure the maximum width of the emission that is 26 dB down from the maximum of the emission. Compare this with the RBW setting of the analyzer. Readjust RBW and repeat measurement as needed until the RBW/EBW ratio is approximately 1%.

The following procedure shall be used for measuring (99 %) power bandwidth:

1. Set center frequency to the nominal EUT channel center frequency.
2. Set span = 1.5 times to 5.0 times the OBW.
3. Set RBW = 1 % to 5 % of the OBW
4. Set VBW  $\geq 3 \cdot$  RBW
5. Video averaging is not permitted. Where practical, a sample detection and single sweep mode shall be used. Otherwise, peak detection and max hold mode (until the trace stabilizes) shall be used.
6. Use the 99 % power bandwidth function of the instrument (if available).
7. If the instrument does not have a 99 % power bandwidth function, the trace data points are recovered and directly summed in power units. The recovered amplitude data points, beginning at the lowest frequency, are placed in a running sum until 0.5 % of the total is reached; that frequency is recorded as the lower frequency. The process is repeated until 99.5 % of the total is reached; that frequency is recorded as the upper frequency. The 99% occupied bandwidth is the difference between these two frequencies.

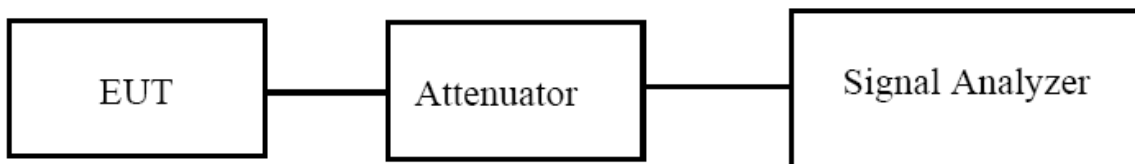

### 5.3 EUT OPERATION CONDITIONS

The EUT tested system was configured as the statements of 2.4 Unless otherwise a special operating condition is specified in the follows during the testing.

### 5.4 TEST RESULTS

EUT :	notebook	Model Name. :	TEV-EL2in1-116-2
Temperature :	25 °C	Relative Humidity :	56%
Pressure :	1012 hPa	Test Voltage :	DC 7.6V
Test Mode :	TX Frequency Band I (5150-5250MHz)		

Note: A(B) Represent the value of antenna A and B, The worst data is Antenna B, only shown Antenna B Plot.

Mode	Channel	Frequency (MHz)	99% bandwidth(MHz)	99% bandwidth(MHz)	26dB bandwidth (MHz)	26dB bandwidth (MHz)	Result
			Antenna A	Antenna B	Antenna A	Antenna B	
802.11a	CH36	5180	16.5604	16.6631	22.622	21.863	Pass
	CH40	5200	16.4913	16.6416	21.851	23.852	Pass
	CH48	5240	16.5244	16.6389	21.671	23.750	Pass
802.11 n20	CH36	5180	17.7142	17.7577	23.497	23.524	Pass
	CH40	5200	17.7344	17.7605	22.251	22.685	Pass
	CH48	5240	17.7248	17.7071	22.846	23.782	Pass
802.11 n40	CH 38	5190	35.9728	35.9565	41.912	41.203	Pass
	CH 46	5230	35.9565	35.9345	40.960	41.008	Pass
802.11 AC20	CH36	5180	17.7420	17.7354	23.431	22.730	Pass
	CH40	5200	17.7004	17.7439	23.568	23.187	Pass
	CH48	5240	17.6898	17.7213	22.373	22.539	Pass
802.11 AC40	CH 38	5190	35.9271	35.9283	41.336	40.882	Pass
	CH 46	5230	35.9446	35.9229	40.038	41.057	Pass
802.11 AC80	CH 42	5210	75.1351	75.1022	79.847	79.567	Pass

Test plot

(802.11a) -26dB&99%Bandwidth plot on channel 36

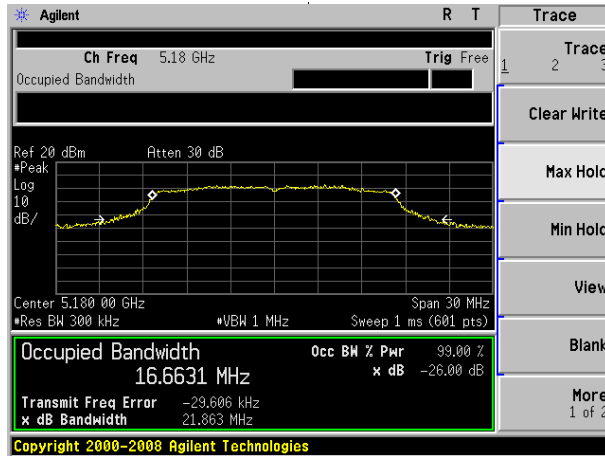

(802.11 n20) -26dB&99%Bandwidth plot on channel 36

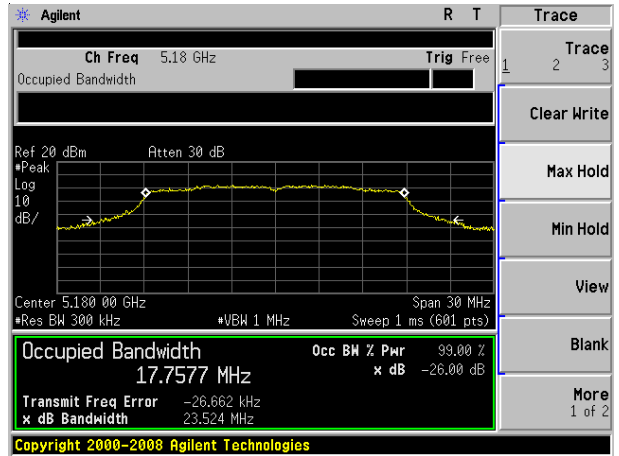

(802.11a) -26dB&99%Bandwidth plot on channel 40

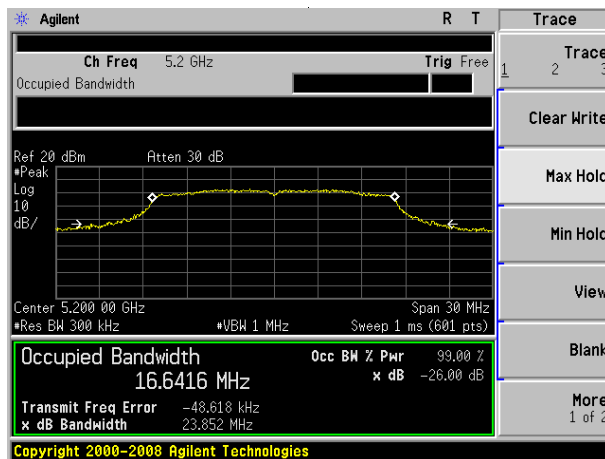

(802.11 n20) -26dB&99%Bandwidth plot on channel 40

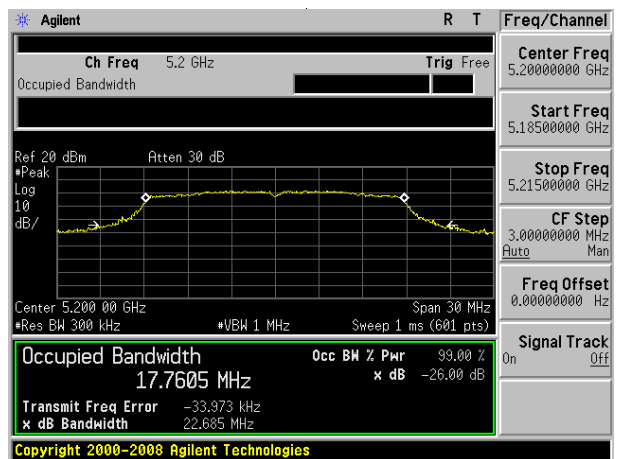

(802.11a) -26dB&99%Bandwidth plot on channel 48

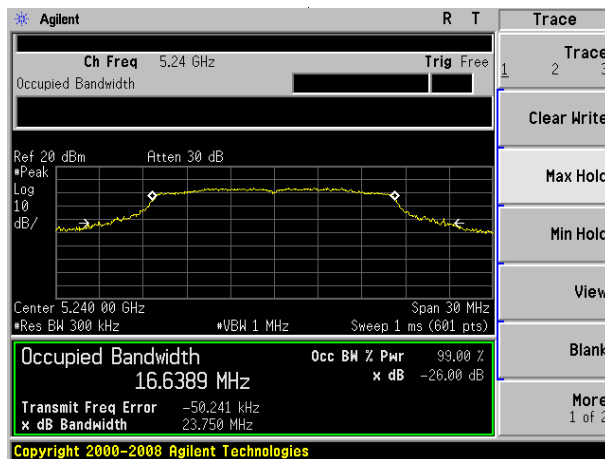

(802.11 n20) -26dB&99%Bandwidth plot on channel 48

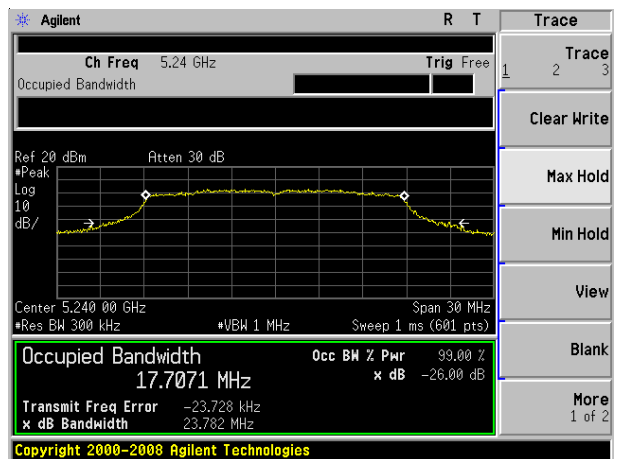



Test plot

(802.11 n40) -26dB&99%Bandwidth plot on channel 38

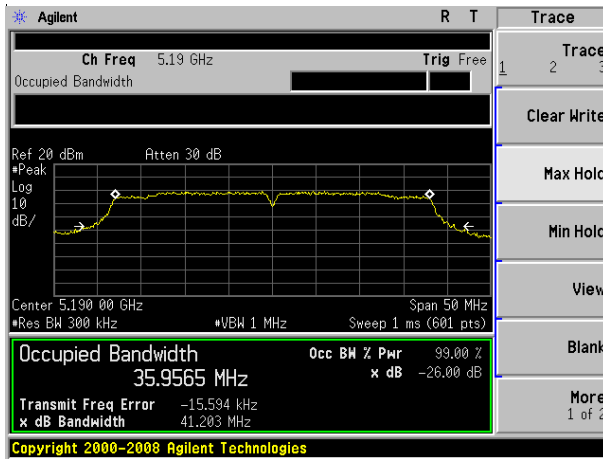

(802.11 AC20) -26dB&99%Bandwidth plot on channel 36

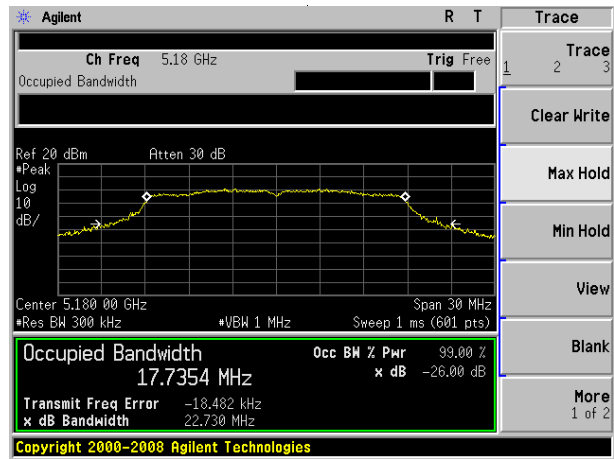

(802.11 n40) -26dB&99%Bandwidth plot on channel 46

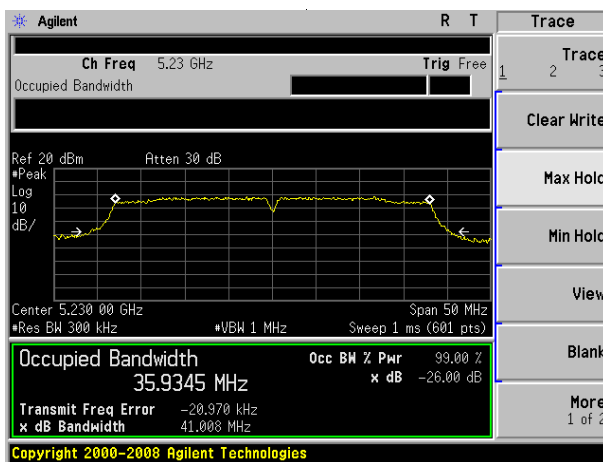

(802.11 AC20) -26dB&99%Bandwidth plot on channel 40

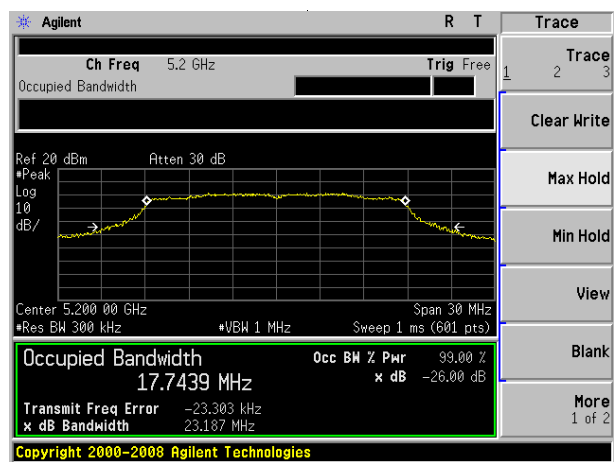

(802.11 AC20) -26dB&99%Bandwidth plot on channel 48

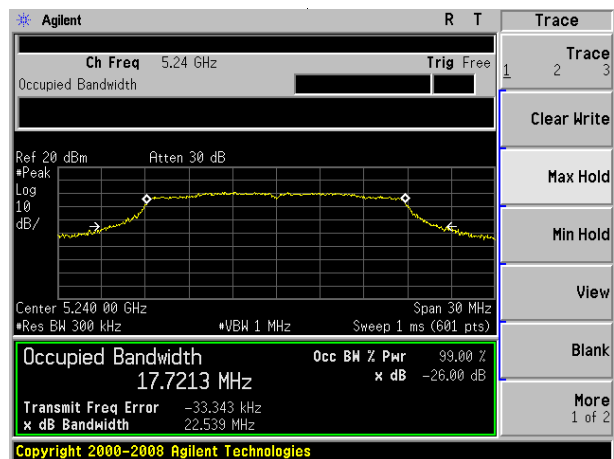

Test plot

(802.11 AC40) -26dB&99%Bandwidth plot on channel 38

(802.11 AC80) -26dB&99%Bandwidth plot on channel 42

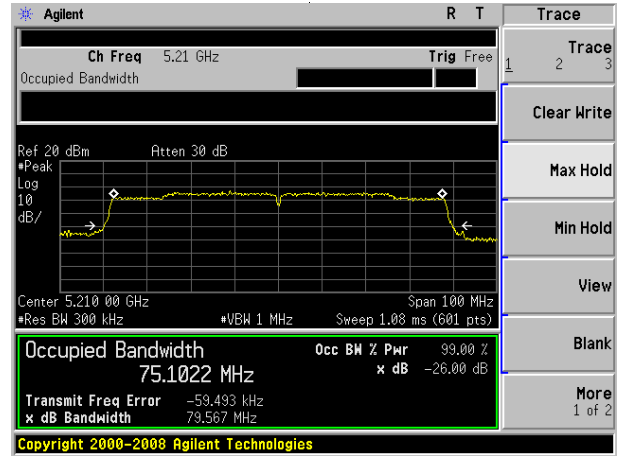
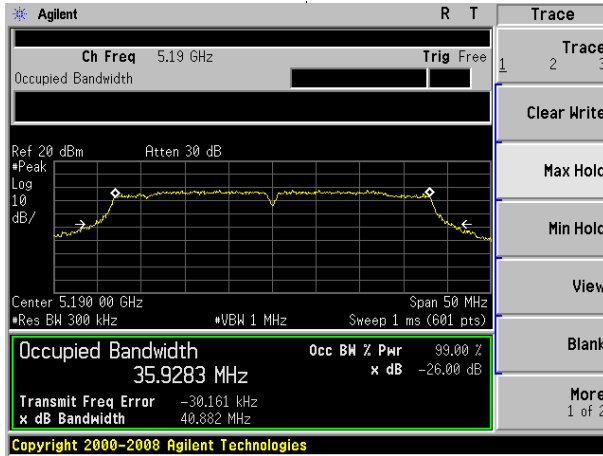

(802.11 AC40) -26dB&99%Bandwidth plot on channel 46

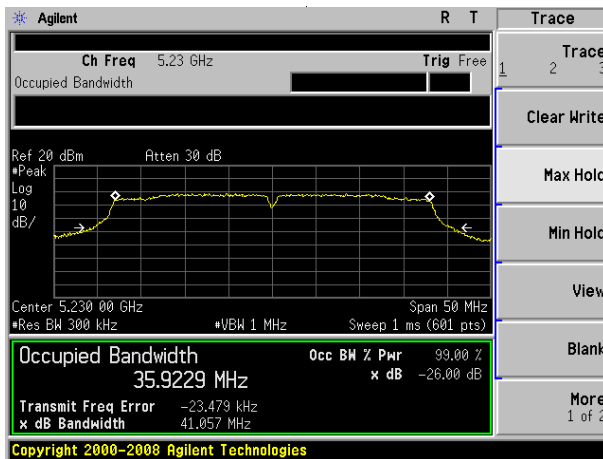

EUT :	notebook	Model Name. :	TEV-EL2in1-116-2
Temperature :	25 °C	Relative Humidity :	56%
Pressure :	1012 hPa	Test Voltage :	DC 7.6V
Test Mode :	TX Frequency Band IV(5745-5850MHz)		

Note: A(B) Represent the value of antenna A and B, The worst data is Antenna B, only shown Antenna B Plot.

Mode	Channel	Frequency (MHz)	99% bandwidth(MHz)	99% bandwidth(MHz)	26dB bandwidth (MHz)	26dB bandwidth (MHz)	Result
			Antenna A	Antenna B	Antenna A	Antenna B	
802.11a	CH149	5745	16.644	16.5483	24.94	22.672	Pass
	CH157	5785	16.630	16.5255	22.75	22.075	Pass
	CH165	5825	16.645	16.4486	23.40	20.710	Pass
802.11 n20	CH149	5745	17.757	17.6926	22.84	22.324	Pass
	CH157	5785	17.712	17.7590	22.29	23.438	Pass
	CH165	5825	17.718	17.7003	22.69	23.632	Pass
802.11 n40	CH151	5755	36.029	35.9478	42.01	40.973	Pass
	CH159	5795	36.024	35.9231	40.75	40.127	Pass
802.11 AC20	CH149	5745	17.748	17.6919	23.19	21.504	Pass
	CH157	5785	17.756	17.6213	22.98	21.813	Pass
	CH165	5825	17.731	17.7200	23.15	22.478	Pass
802.11 AC40	CH151	5755	36.001	35.9556	41.34	42.048	Pass
	CH159	5795	35.954	35.9243	40.89	41.152	Pass
802.11 AC80	CH155	5775	75.326	75.2864	80.55	116.584	Pass

Test plot

(802.11a) -26dB&99%Bandwidth plot on channel 36

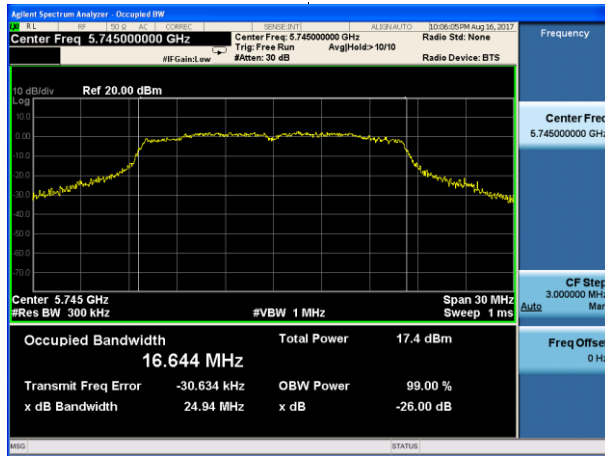

(802.11 n20) -26dB&99%Bandwidth plot on channel 36

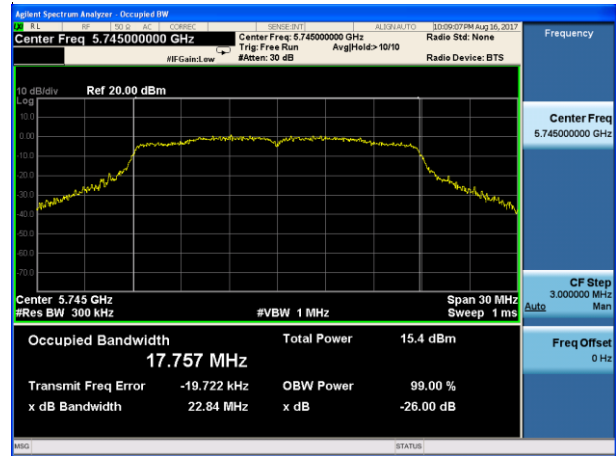

(802.11a) -26dB&99%Bandwidth plot on channel 40

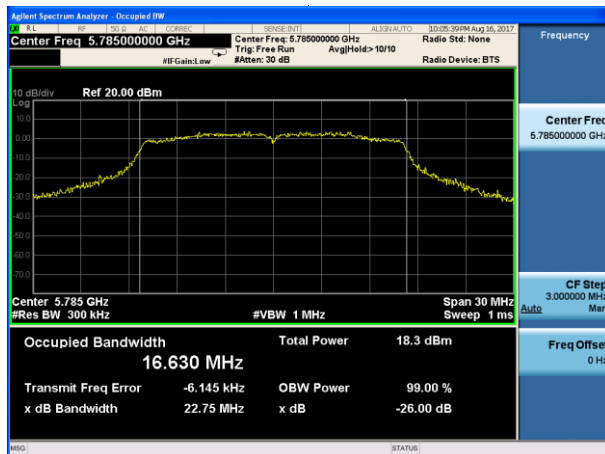

(802.11 n20) -26dB&99%Bandwidth plot on channel 40

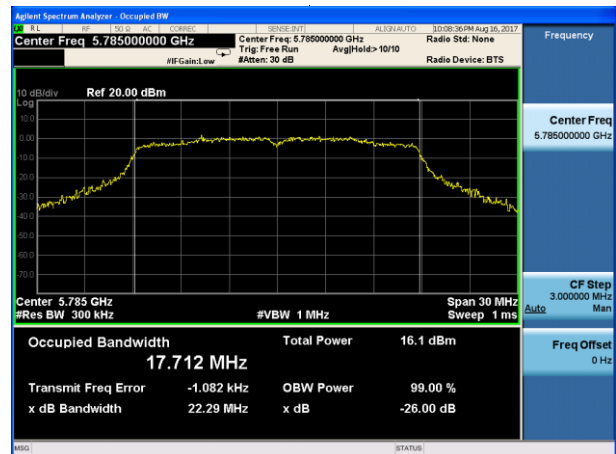

(802.11a) -26dB&99%Bandwidth plot on channel 48

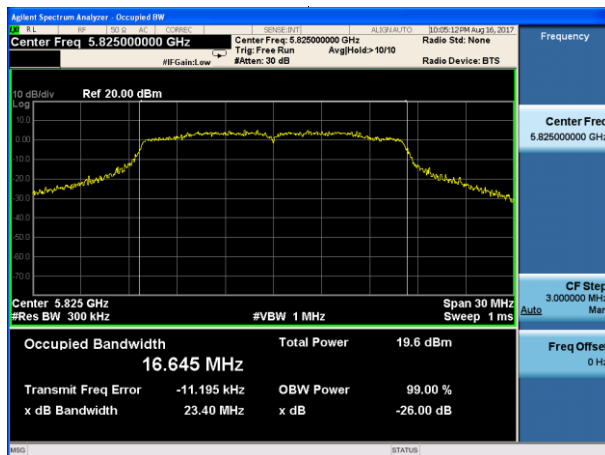

(802.11 n20) -26dB&99%Bandwidth plot on channel 48

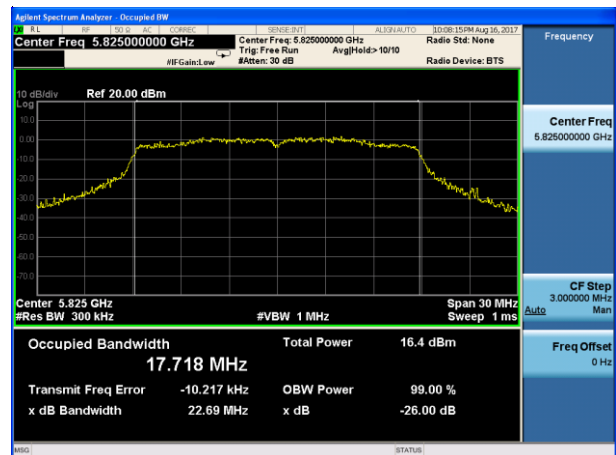

Test plot

(802.11 n40) -26dB&99%Bandwidth plot on channel 38

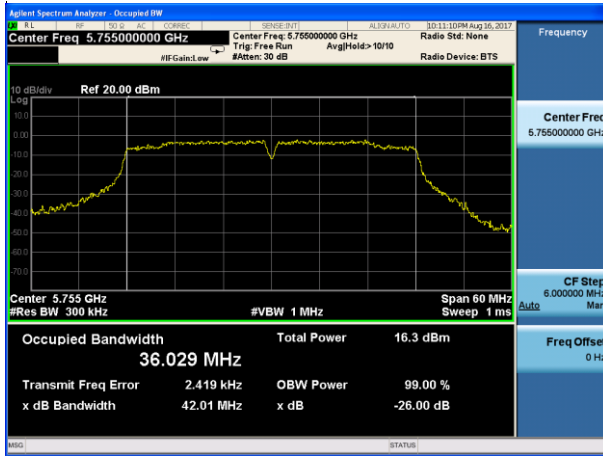

(802.11 AC20) -26dB&99%Bandwidth plot on channel 36

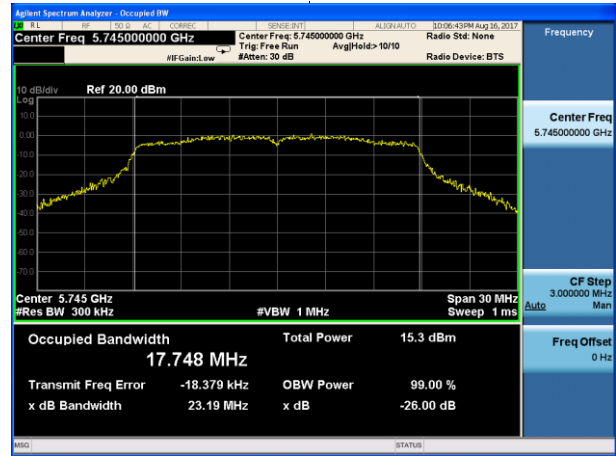

(802.11 n40) -26dB&99%Bandwidth plot on channel 46

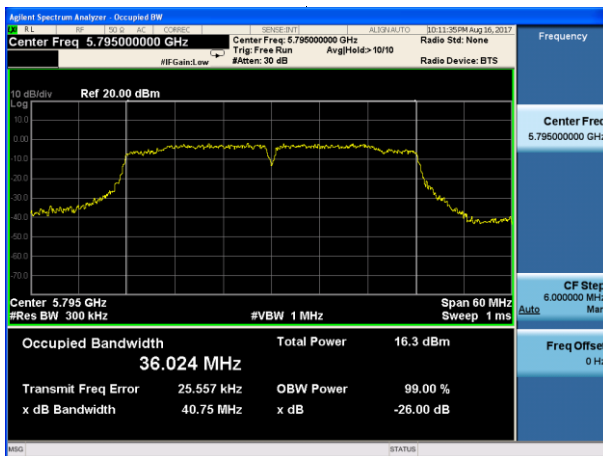

(802.11 AC20) -26dB&99%Bandwidth plot on channel 40

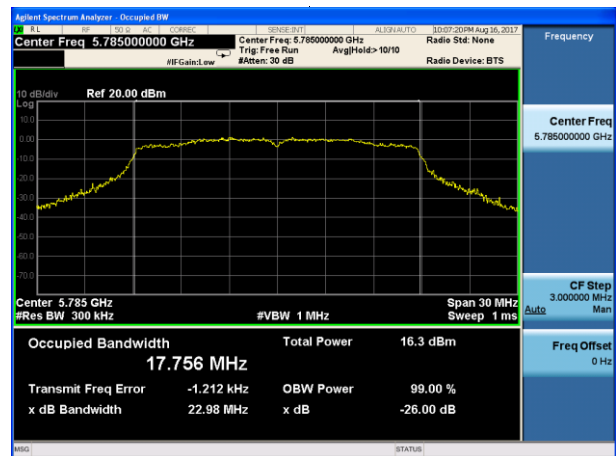

(802.11 AC20) -26dB&99%Bandwidth plot on channel 48

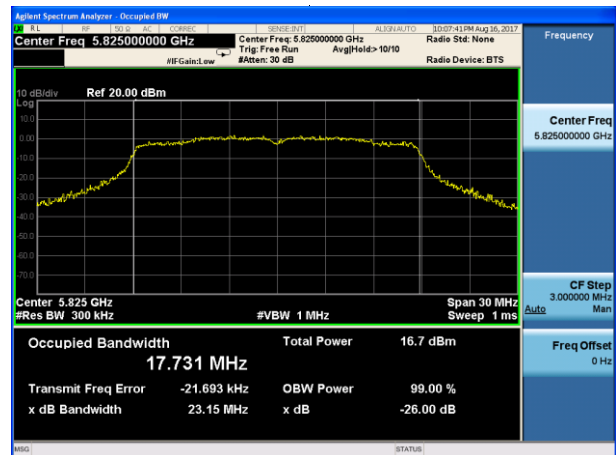

Test plot

(802.11 AC40) -26dB&99%Bandwidth plot on channel 38

(802.11 AC80) -26dB&99%Bandwidth plot on channel 42

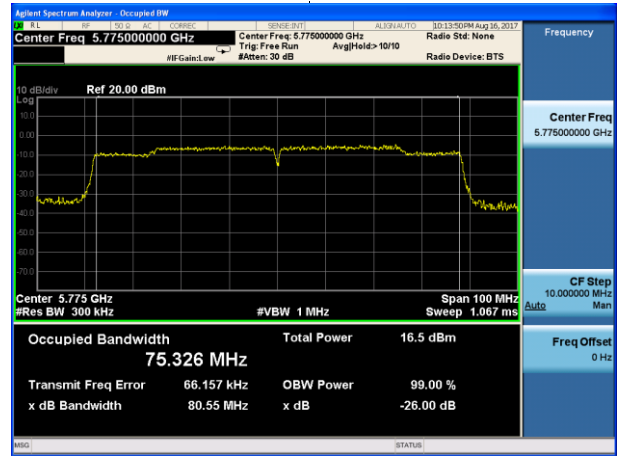
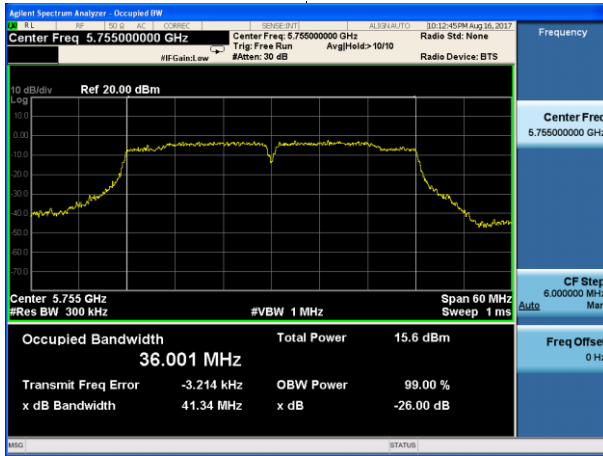

(802.11 AC40) -26dB&99%Bandwidth plot on channel 46

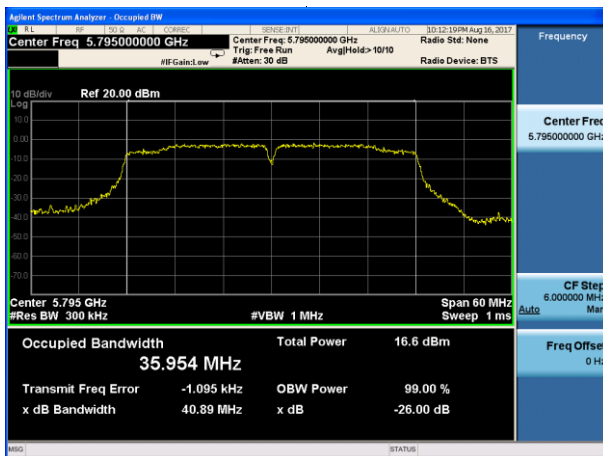

## 6. MINIMUM 6 DB BANDWIDTH

### 6.1 APPLIED PROCEDURES / LIMIT

#### According to FCC §15.407(e)

(e) Within the 5.725-5.85 GHz band, the minimum 6 dB bandwidth of U-NII devices shall be at least 500 kHz.

### 6.2 TEST PROCEDURE

Section 15.407(e) specifies the minimum 6 dB emission bandwidth of at least 500 KHz for the band 5.715-5.85 GHz. The following procedure shall be used for measuring this bandwidth:

- a) Set RBW = 100 kHz.
- b) Set the video bandwidth (VBW)  $\geq 3 \times$  RBW.
- c) Detector = Peak.
- d) Trace mode = max hold.
- e) Sweep = auto couple.
- f) Allow the trace to stabilize.
- g) Measure the maximum width of the emission that is constrained by the frequencies associated with the two outermost amplitude points (upper and lower frequencies) that are attenuated by 6 dB relative to the maximum level measured in the fundamental emission.

### 6.3 DEVIATION FROM STANDARD

No deviation.

### 6.4 TEST SETUP

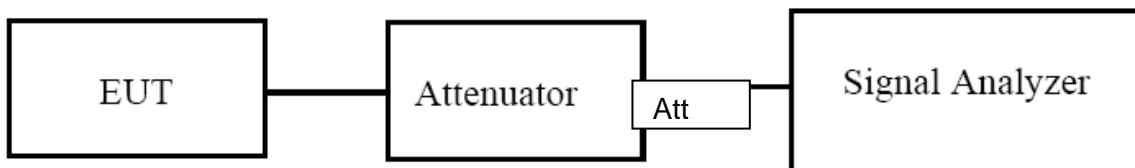

### 6.5 EUT OPERATION CONDITIONS

The EUT tested system was configured as the statements of 2.4 Unless otherwise a special operating condition is specified in the follows during the testing.

### 6.6 TEST RESULTS

EUT :	notebook	Model Name. :	TEV-EL2in1-116-2
Temperature :	25 °C	Relative Humidity :	56%
Pressure :	1012 hPa	Test Voltage :	DC 7.6V
Test Mode :	TX Frequency Band I (5150-5250MHz)		

Note: A(B) Represent the value of antenna A and B, The worst data is Antenna B, only shown Antenna B Plot.

Mode	Channel	Frequency (MHz)	6dB bandwidth (MHz)		Limit (KHz)	Result
			Antenna A	Antenna B		
802.11a	CH36	5180	16.290	15.172	$\cong 500$	Pass
	CH40	5200	14.442	15.142	$\cong 500$	Pass
	CH48	5240	15.553	15.169	$\cong 500$	Pass
802.11 n20	CH36	5180	14.067	15.157	$\cong 500$	Pass
	CH40	5200	11.443	15.117	$\cong 500$	Pass
	CH48	5240	15.052	15.966	$\cong 500$	Pass
802.11 n40	CH 38	5190	35.208	35.221	$\cong 500$	Pass
	CH 46	5230	33.813	35.228	$\cong 500$	Pass
802.11 AC20	CH36	5180	12.011	15.150	$\cong 500$	Pass
	CH40	5200	15.105	16.068	$\cong 500$	Pass
	CH48	5240	15.670	15.401	$\cong 500$	Pass
802.11 AC40	CH 38	5190	35.275	35.210	$\cong 500$	Pass
	CH 46	5230	32.616	35.188	$\cong 500$	Pass
802.11 AC80	CH 42	5210	75.241	75.270	$\cong 500$	Pass



Test plot

(802.11a) 6dB Bandwidth plot on channel 36

(802.11 n20) 6dB Bandwidth plot on channel 36

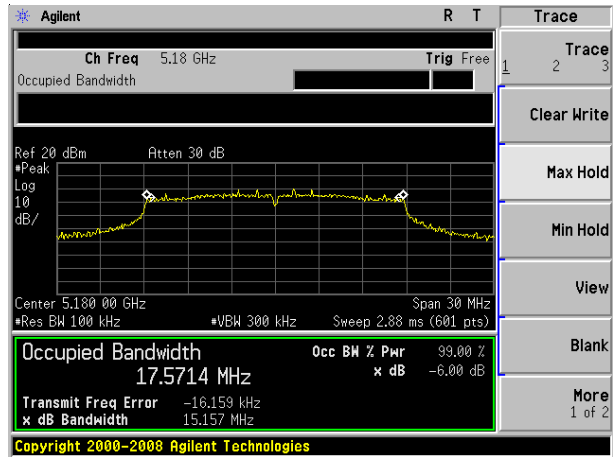
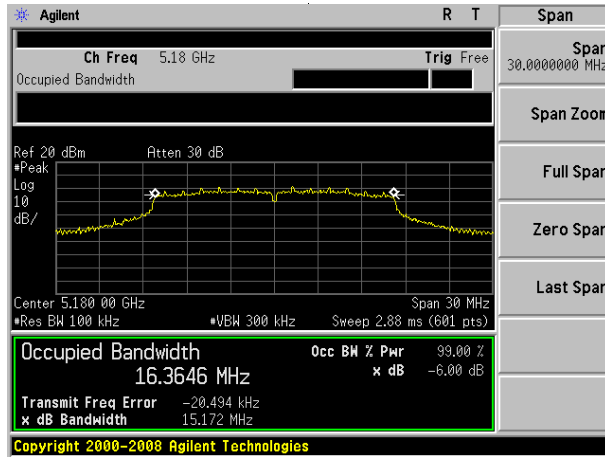

(802.11a) 6dB Bandwidth plot on channel 40

(802.11 n20) 6dB Bandwidth plot on channel 40

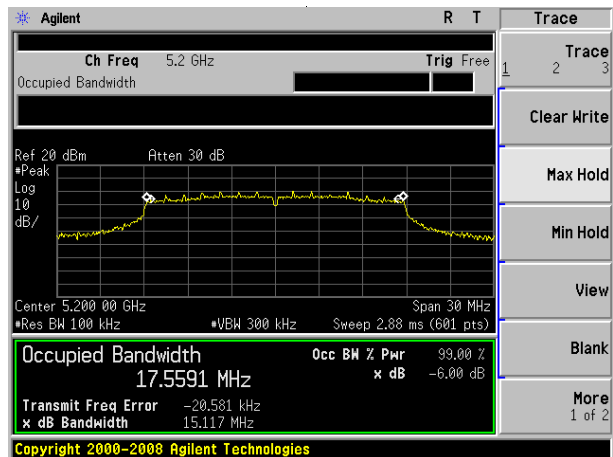
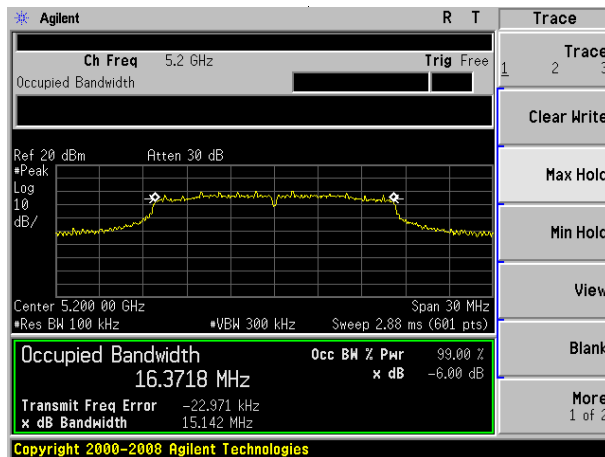

(802.11a) 6dB Bandwidth plot on channel 48

(802.11 n20) 6dB Bandwidth plot on channel 48

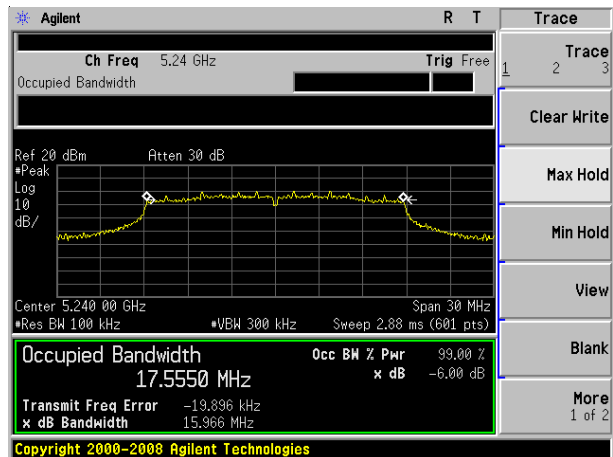
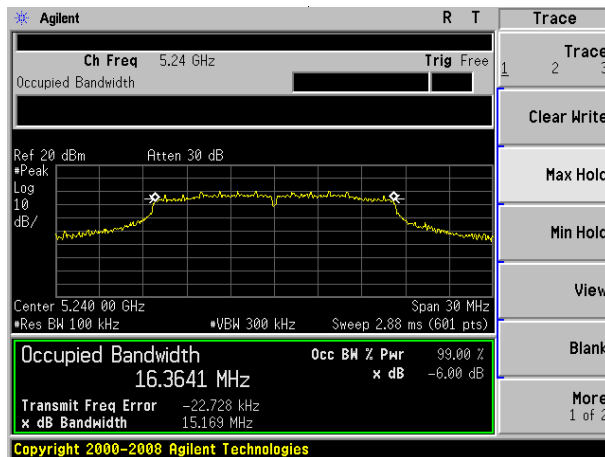

Test plot

(802.11 n40) 6dB Bandwidth plot on channel 38

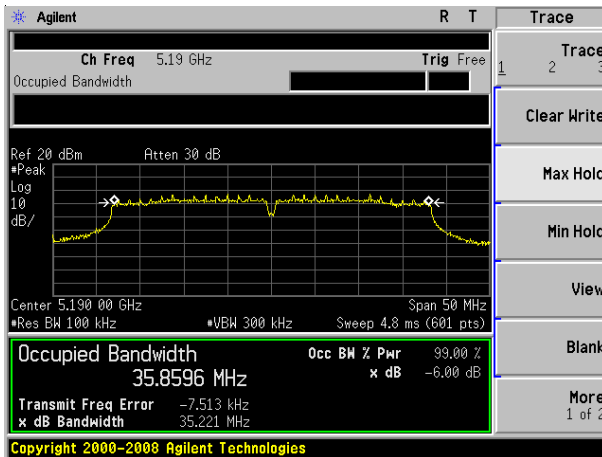

(802.11 AC20) 6dB Bandwidth plot on channel 36

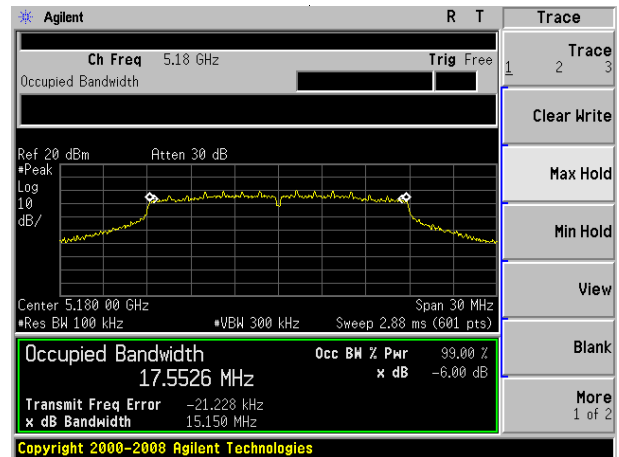

(802.11 n40) 6dB Bandwidth plot on channel 46

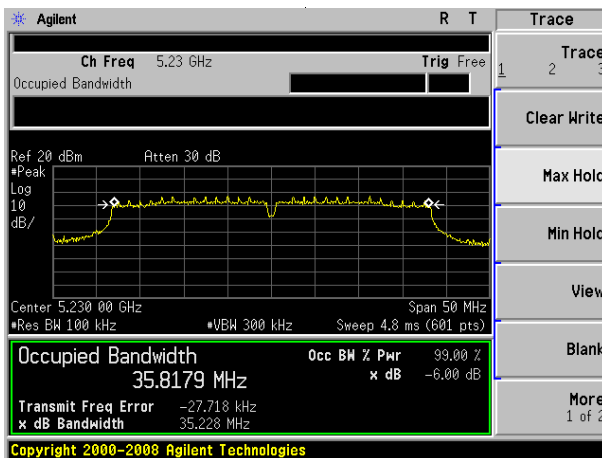

(802.11 AC20) 6dB Bandwidth plot on channel 40

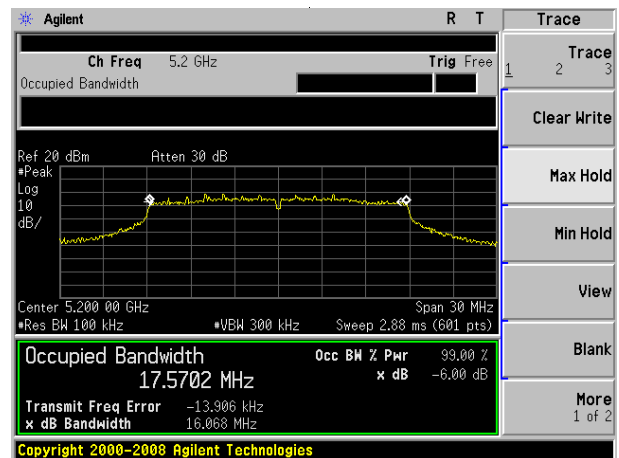

(802.11 AC20) 6dB Bandwidth plot on channel 48

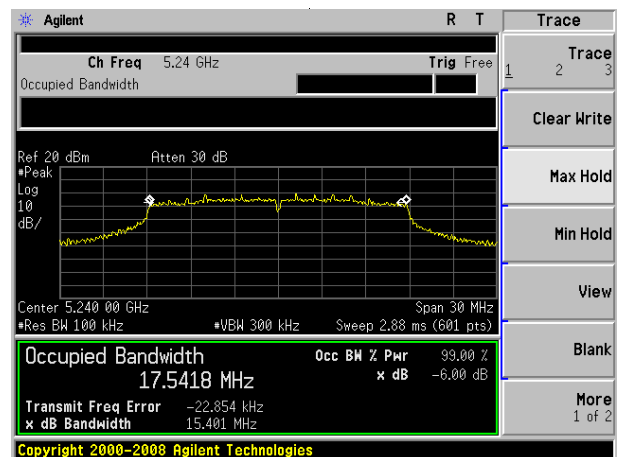

Test plot

(802.11 AC40) 6dB Bandwidth plot on channel 38

(802.11 AC80) 6dB Bandwidth plot on channel 42

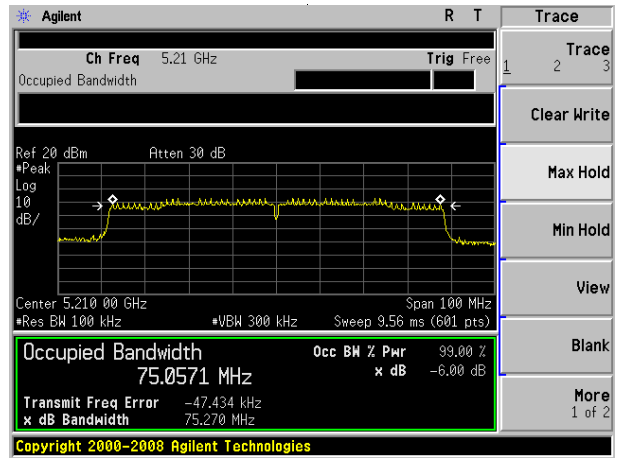
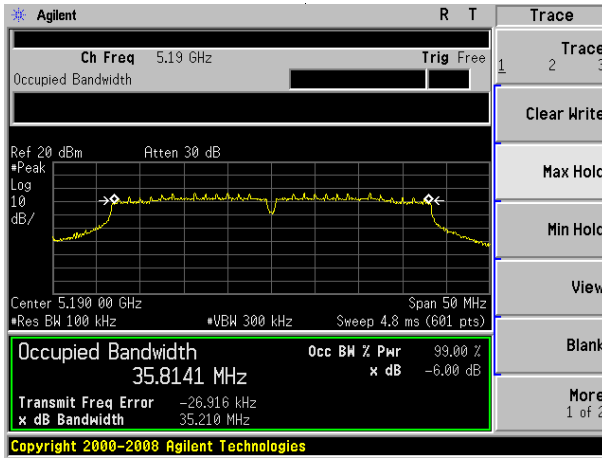

(802.11 AC40) 6dB Bandwidth plot on channel 46

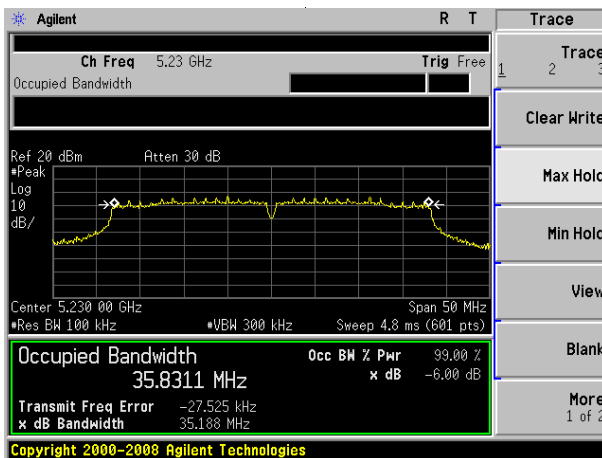

EUT :	notebook	Model Name. :	TEV-EL2in1-116-2
Temperature :	25 °C	Relative Humidity :	60%
Pressure :	1012 hPa	Test Voltage :	DC 7.6V
Test Mode :	TX (5G) Mode Frequency Band IV (5725-5825MHz)		

Note: A(B) Represent the value of antenna A and B, The worst data is Antenna B ,only shown Antenna B Plot.

Mode	Channel	Frequency (MHz)	-6dB bandwidth (MHz)		Limit (KHz)	Result
			Antenna A	Antenna B		
802.11a	149	5745	15.08	12.596	≧ 500	Pass
	157	5785	15.09	15.697	≧ 500	Pass
	165	5825	15.33	13.900	≧ 500	Pass
802.11 n20	149	5745	15.09	15.972	≧ 500	Pass
	157	5785	15.15	15.292	≧ 500	Pass
	165	5825	15.49	15.150	≧ 500	Pass
802.11 n40	151	5755	35.18	35.232	≧ 500	Pass
	159	5795	35.10	33.903	≧ 500	Pass
802.11 AC20	149	5745	15.04	15.117	≧ 500	Pass
	157	5785	15.12	15.144	≧ 500	Pass
	165	5825	15.03	15.151	≧ 500	Pass
802.11 AC40	149	5745	35.04	35.263	≧ 500	Pass
	157	5785	35.16	33.934	≧ 500	Pass
802.11 AC80	155	5775	75.23	75.456	≧ 500	Pass

Test plot

(802.11a) 6dB Bandwidth plot on channel 149

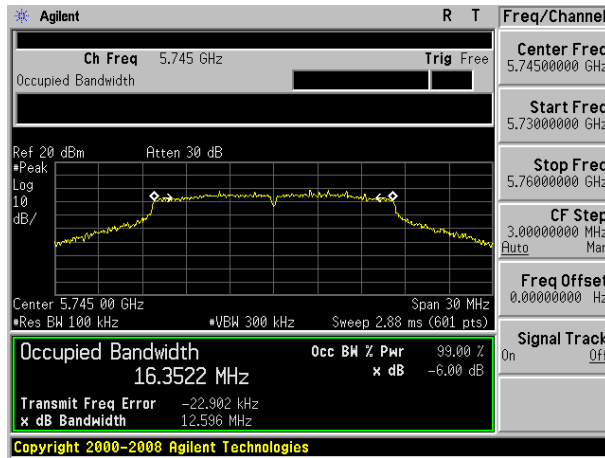

(802.11 n20) 6dB Bandwidth plot on channel 149

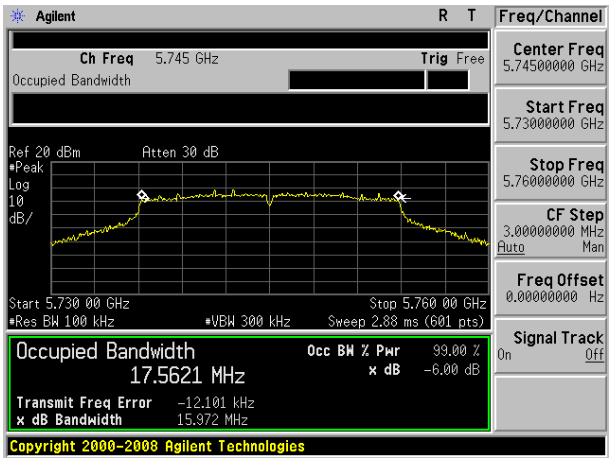

(802.11a) 6dB Bandwidth plot on channel 157

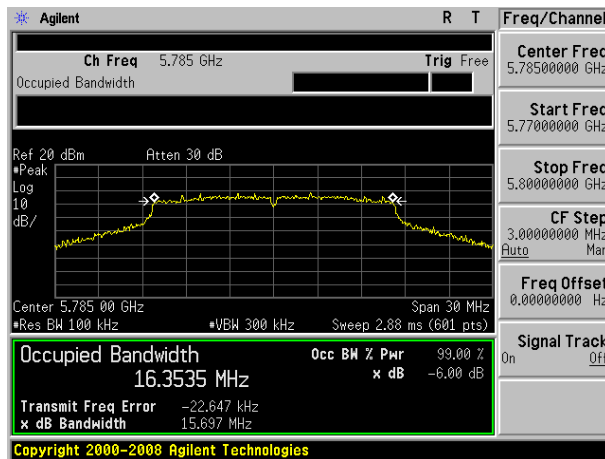

(802.11 n20) 6dB Bandwidth plot on channel 157

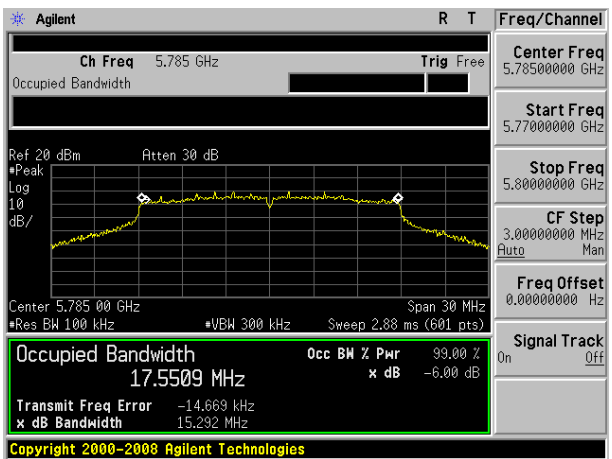

(802.11a) 6dB Bandwidth plot on channel 165

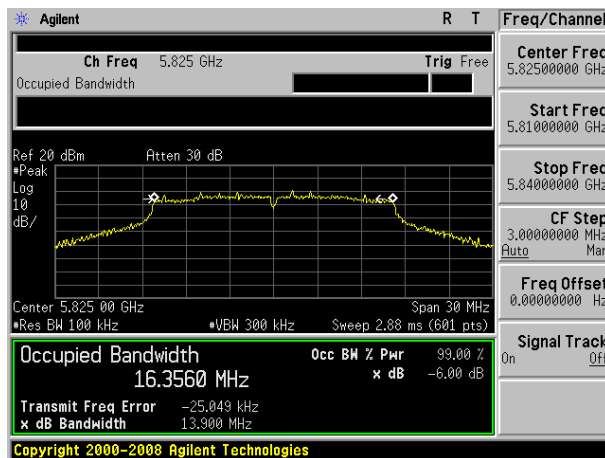

(802.11 n20) 6dB Bandwidth plot on channel 165

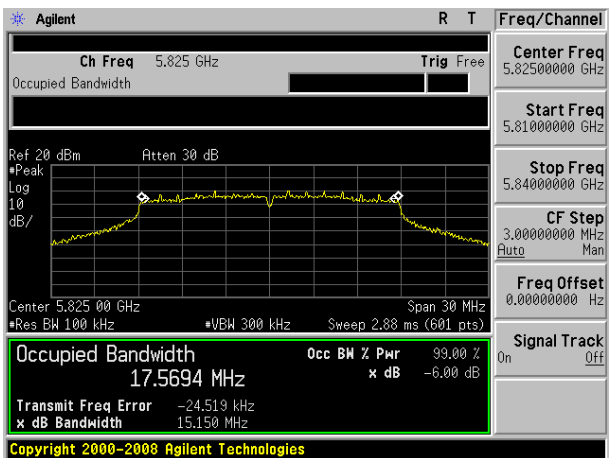

Test plot

(802.11 n40) 6dB Bandwidth plot on channel 151

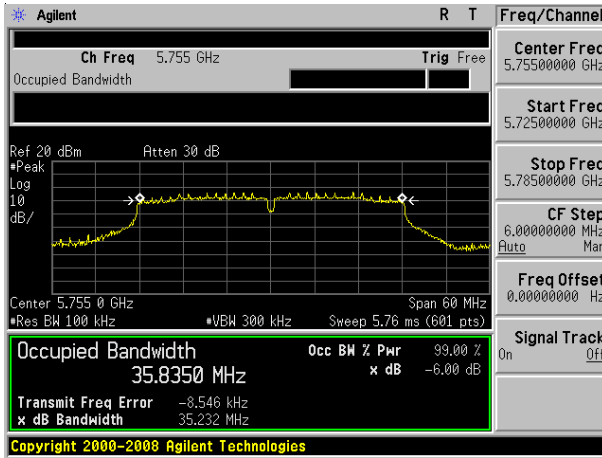

(802.11 AC20) 6dB Bandwidth plot on channel 149

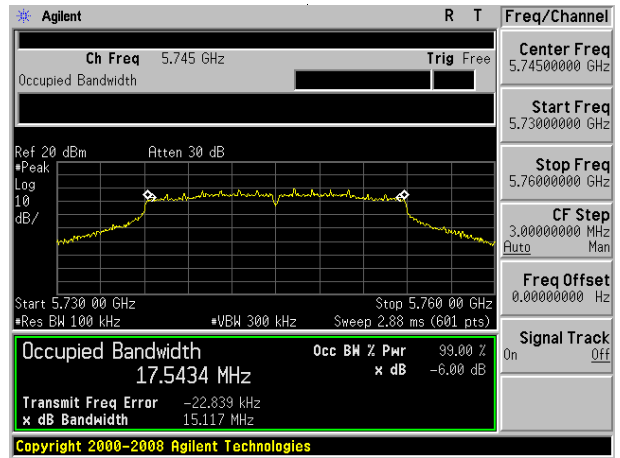

(802.11 n40) 6dB Bandwidth plot on channel 159

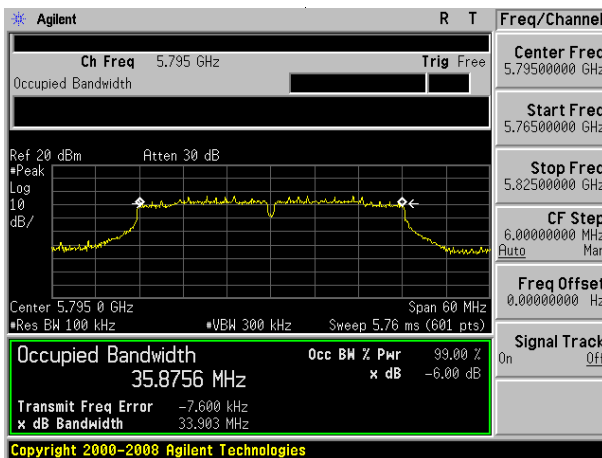

(802.11 AC20) 6dB Bandwidth plot on channel 157

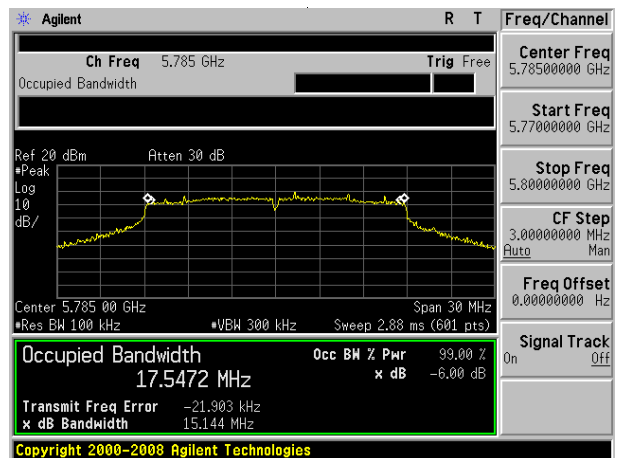

(802.11 AC20) 6dB Bandwidth plot on channel 165

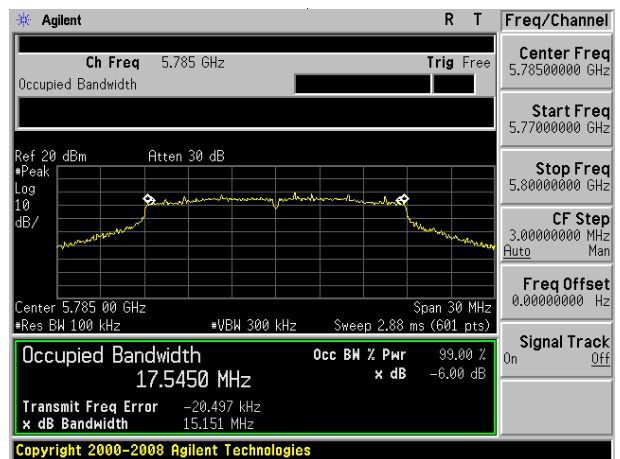

Test plot

(802.11 AC40) 6dB Bandwidth plot on channel 151

(802.11 AC80) 6dB Bandwidth plot on channel 155

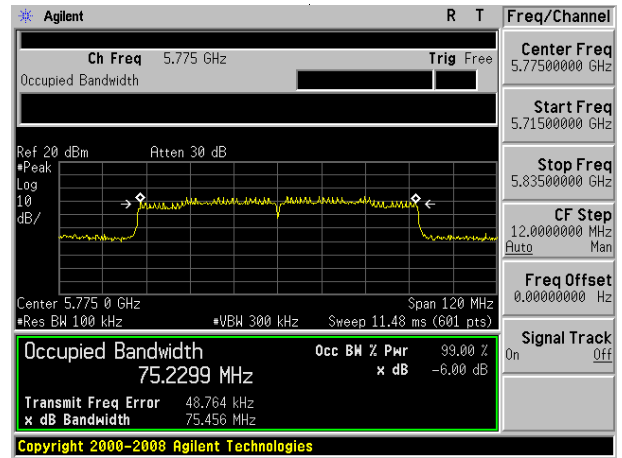
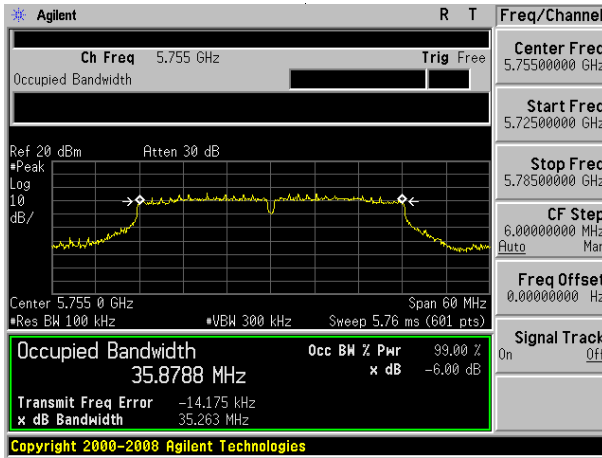

(802.11 AC40) 6dB Bandwidth plot on channel 159

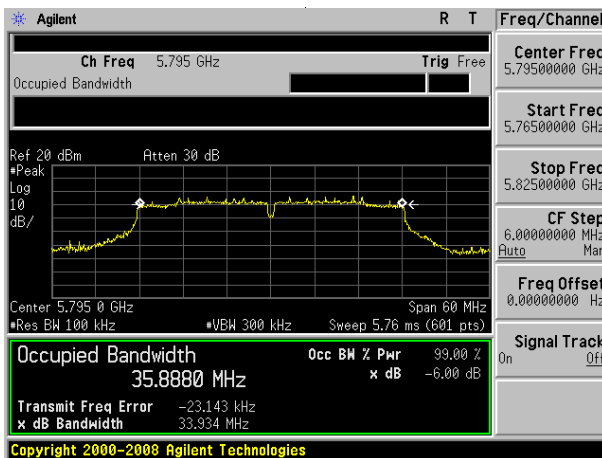

**7. MAXIMUM CONDUCTED OUTPUT POWER**

**7.1 APPLIED PROCEDURES / LIMIT**

**According to FCC §15.407**

The maximum conducted output power should not exceed:

Frequency Band(MHz)	Limit
5150~5250	250mW
5725~5850	1W

The maximum e.i.r.p should not exceed:

Frequency Band(MHz)	Limit
5150~5250	200mW or 10dBm +10logB whichever is less
5725~5850	N/A

Note: Where “B” is the 99% emission bandwidth in MHz

**7.2 TEST PROCEDURE**

· Maximum conducted output power may be measured using a spectrum analyzer/EMI receiver or an RF power meter.

**1. Device Configuration**

If possible, configure or modify the operation of the EUT so that it transmits continuously at its maximum power control level (see section II.B.).

a) The intent is to test at 100 percent duty cycle; however a small reduction in duty cycle (to no lower than 98 percent) is permitted if required by the EUT for amplitude control purposes. Manufacturers are expected to provide software to the test lab to permit such continuous operation.

b) If continuous transmission (or at least 98 percent duty cycle) cannot be achieved due to hardware limitations (e.g., overheating), the EUT shall be operated at its maximum power control level with the transmit duration as long as possible and the duty cycle as high as possible.

**2. Measurement using a Spectrum Analyzer or EMI Receiver (SA)**

Measurement of maximum conducted output power using a spectrum analyzer requires integrating the spectrum across a frequency span that encompasses, at a minimum, either the EBW or the 99-percent occupied bandwidth of the signal.<sup>1</sup> However, the EBW must be used to determine bandwidth dependent limits on maximum conducted output power in accordance with § 15.407(a).



a) The test method shall be selected as follows: (i) Method SA-1 or SA-1 Alternative (averaging with the EUT transmitting at full power throughout each sweep) shall be applied if either of the following conditions can be satisfied:

- The EUT transmits continuously (or with a duty cycle  $\geq 98$  percent).
- Sweep triggering or gating can be implemented in a way that the device transmits at the maximum power control level throughout the duration of each of the instrument sweeps to be averaged. This condition can generally be achieved by triggering the instrument's sweep if the duration of the sweep (with the analyzer configured as in Method SA-1, below) is equal to or shorter than the duration T of each transmission from the EUT and if those transmissions exhibit full power throughout their durations.

(ii) Method SA-2 or SA-2 Alternative (averaging across on and off times of the EUT transmissions, followed by duty cycle correction) shall be applied if the conditions of (i) cannot be achieved and the transmissions exhibit a constant duty cycle during the measurement duration. Duty cycle will be considered to be constant if variations are less than  $\pm 2$  percent.

(iii) Method SA-3 (RMS detection with max hold) or SA-3 Alternative (reduced VBW with max hold) shall be applied if the conditions of (i) and (ii) cannot be achieved.

b) Method SA-1 (trace averaging with the EUT transmitting at full power throughout each sweep): (i) Set span to encompass the entire emission bandwidth (EBW) (or, alternatively, the entire 99% occupied bandwidth) of the signal.

(ii) Set RBW = 1 MHz.

(iii) Set VBW  $\geq 3$  MHz.

(iv) Number of points in sweep  $\geq 2$  Span / RBW. (This ensures that bin-to-bin spacing is  $\leq$  RBW/2, so that narrowband signals are not lost between frequency bins.)

(v) Sweep time = auto.

(vi) Detector = RMS (i.e., power averaging), if available. Otherwise, use sample detector mode.

(vii) If transmit duty cycle  $< 98$  percent, use a video trigger with the trigger level set to enable triggering only on full power pulses. Transmitter must operate at maximum power control level for the entire duration of every sweep. If the EUT transmits continuously (i.e., with no off intervals) or at duty cycle  $\geq 98$  percent, and if each transmission is entirely at the maximum power control level, then the trigger shall be set to "free run".

(viii) Trace average at least 100 traces in power averaging (i.e., RMS) mode.

(ix) Compute power by integrating the spectrum across the EBW (or, alternatively, the entire 99% occupied bandwidth) of the signal using the instrument's band power measurement function with band limits set equal to the EBW (or occupied bandwidth) band edges. If the instrument does not have a band power function, sum the spectrum

### 7.3 DEVIATION FROM STANDARD

No deviation.

### 7.4 TEST SETUP

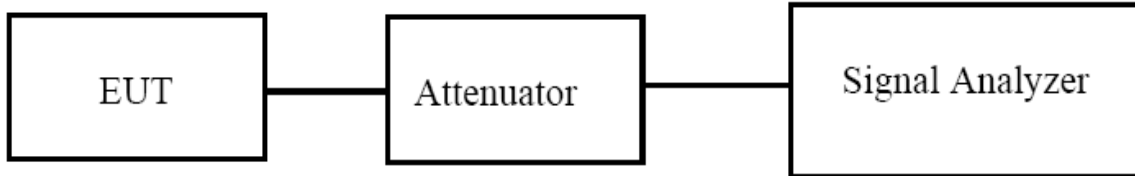

### 7.5 EUT OPERATION CONDITIONS

The EUT tested system was configured as the statements of 2.4 Unless otherwise a special operating condition is specified in the follows during the testing.

## 7.6 TEST RESULTS

EUT :	notebook	Model Name. :	TEV-EL2in1-116-2
Temperature :	25 °C	Relative Humidity :	60%
Pressure :	1012 hPa	Test Voltage :	DC 7.6V
Test Mode :	TX (5G) Mode Frequency Band I (5150-5250MHz)		

Test Channel	Frequency (MHz)	Maximum output power. Antenna port (AV)	Maximum output power. Antenna port (AV)	LIMIT	Result
		(dBm)	(dBm)		
		Antenna A	Antenna B	dBm	
<b>TX 802.11a Mode</b>					
CH36	5180	9.8	9.9	23.98	Pass
CH40	5200	9.7	9.8	23.98	Pass
CH48	5240	9.6	9.8	23.98	Pass
<b>TX 802.11 n20M Mode</b>					
CH36	5180	8.5	8.4	23.98	Pass
CH40	5200	8.4	8.2	23.98	Pass
CH48	5240	8.3	8.4	23.98	Pass
<b>TX 802.11 n40M Mode</b>					
CH38	5190	8.5	8.6	23.98	Pass
CH46	5230	8.3	8.4	23.98	Pass
<b>TX 802.11 AC20M Mode</b>					
CH36	5180	8.2	8.0	23.98	Pass
CH40	5200	8.4	8.2	23.98	Pass
CH48	5240	8.2	8.1	23.98	Pass
<b>TX 802.11 AC40M Mode</b>					
CH38	5190	8.2	8.3	23.98	Pass
CH46	5230	8.1	8.2	23.98	Pass
<b>TX 802.11 AC80M Mode</b>					
CH42	5210	7.9	8.1	23.98	Pass

Note: For 802.11a/n (20M/40M)/ac(20/40/80) Directional gain=GANT +10log(N)dBi =-0.73dBi  
 -0.73dBi<6.0 dBi so power limit= 21.42

Note: The wireless module is 1x1 Wi-Fi support 802.11a / g / n / ac; does not support MIMO

EUT :	notebook	Model Name. :	TEV-EL2in1-116-2
Temperature :	25 °C	Relative Humidity :	60%
Pressure :	1012 hPa	Test Voltage :	DC 7.6V
Test Mode :	TX (5G) Mode Frequency Band IV (5725-5825MHz)		

Test Channel	Frequency (MHz)	Maximum output power. Antenna port (AV)	Maximum output power. Antenna port (AV)	LIMIT	Result
		(dBm)		dBm	
		Antenna A	Antenna B		
<b>TX 802.11a Mode</b>					
CH 149	5745	9.6	9.8	30	Pass
CH 157	5785	9.8	9.9	30	Pass
CH 165	5825	9.9	9.8	30	Pass
<b>TX 802.11 n20M Mode</b>					
CH 149	5745	8.2	8.2	30	Pass
CH 157	5785	8.2	8.3	30	Pass
CH 165	5825	8.3	8.2	30	Pass
<b>TX 802.11 n40M Mode</b>					
CH 151	5755	8.3	8.5	30	Pass
CH 159	5795	8.2	8.4	30	Pass
<b>TX 802.11 AC20M Mode</b>					
CH 149	5745	8.2	8.2	30	Pass
CH 157	5785	8.3	8.1	30	Pass
CH 165	5825	8.3	8.2	30	Pass
<b>TX 802.11 AC40M Mode</b>					
CH 151	5755	8.2	8.2	30	Pass
CH 159	5795	8.1	8.5	30	Pass
<b>TX 802.11 AC80M Mode</b>					
CH 155	5775	7.8	8.2	30	Pass

Note: The wireless module is 1x1 Wi-Fi support 802.11 a / g / n / ac; does not support MIMO  
 Note: For 802.11a/n (20M/40M)/ac(20/40/80) Directional gain=GANT +10log(N)dBi =-0.73dBi

-0.73dBi<6.0 dBi so power limit= 27.44

## 8. OUT OF BAND EMISSIONS

### 8.1 APPLICABLE STANDARD

#### According to FCC §15.407(b)

Undesirable emission limits. Except as shown in paragraph (b)(7) of this section, the maximum emissions outside of the frequency bands of operation shall be attenuated in accordance with the following limits:

(1) For transmitters operating in the 5.15-5.25 GHz band: All emissions outside of the 5.15-5.35 GHz band shall not exceed an e.i.r.p. of  $-27$  dBm/MHz.

(2) For transmitters operating in the 5.725-5.85 GHz band: All emissions within the frequency range from the band edge to 10 MHz above or below the band edge shall not exceed an e.i.r.p. of  $-17$  dBm/MHz; for frequencies 10 MHz or greater above or below the band edge, emissions shall not exceed an e.i.r.p. of  $-27$  dBm/MHz.

### 8.2 TEST PROCEDURE

1. Check the calibration of the measuring instrument using either an internal calibrator or a known signal from an external generator.
2. Position the EUT without connection to measurement instrument. Turn on the EUT and connect its antenna terminal to measurement instrument via a low loss cable. Then set it to any one measured frequency within its operating range, and make sure the instrument is operated in its linear range.
3. Set RBW of spectrum analyzer to 1 MHz with a convenient frequency span.
4. Measure the highest amplitude appearing on spectral display and set it as a reference level. Plot the graph with marking the highest point and edge frequency.
5. Repeat above procedures until all measured frequencies were complete.

### 8.3 DEVIATION FROM STANDARD

No deviation.

### 8.4 TEST SETUP

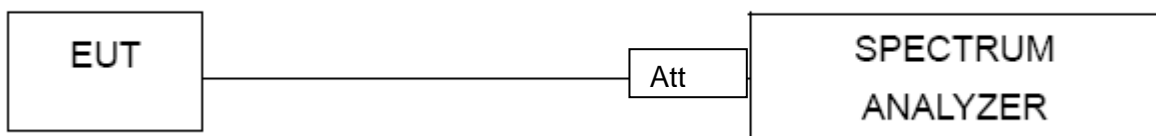

### 8.5 EUT OPERATION CONDITIONS

The EUT tested system was configured as the statements of 2.4 Unless otherwise a special operating condition is specified in the follows during the testing.

### 8.6 TEST RESULTS

EUT :	notebook	Model Name. :	TEV-EL2in1-116-2
Temperature :	25 °C	Relative Humidity :	56%
Pressure :	1012 hPa	Test Voltage :	DC 7.6V

Note: A(B) Represent the value of antenna A and B, The worst data is Antenna B ,only shown Antenna B Plot.

5.2G

5.15~5.25 GHz

(802.11a) Band Edge, Left Side

(802.11n20) Band Edge, Left Side

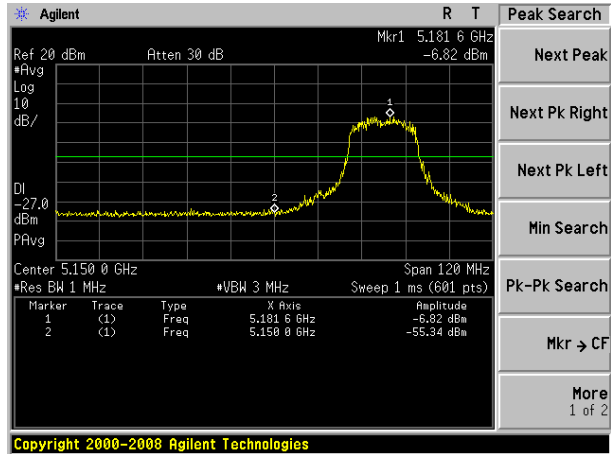
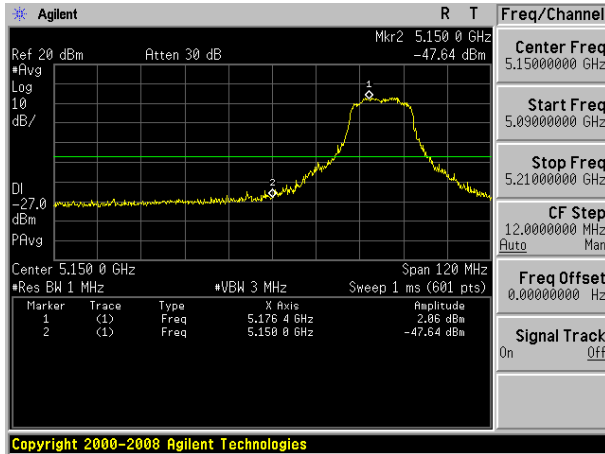

Copyright 2000-2008 Agilent Technologies

Copyright 2000-2008 Agilent Technologies

(802.11a) Band Edge, Right Side

(802.11n20) Band Edge, Right Side

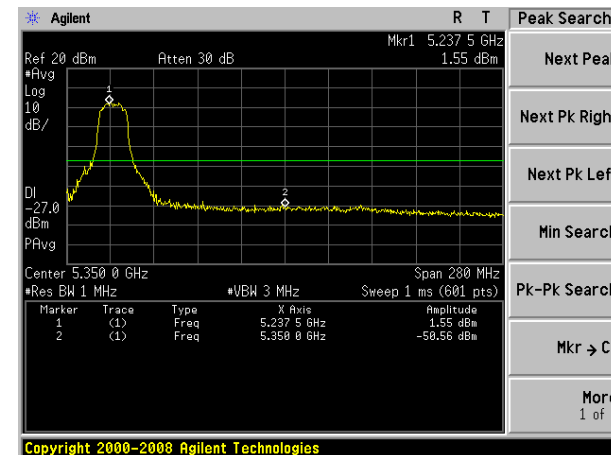
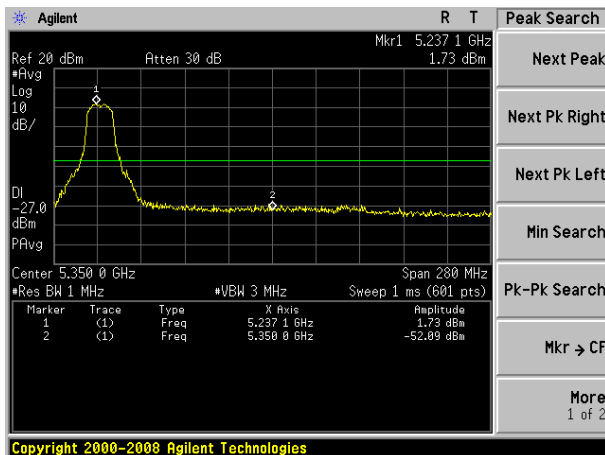

Copyright 2000-2008 Agilent Technologies

Copyright 2000-2008 Agilent Technologies

5.15~5.25 GHz

(802.11n40) Band Edge, Left Side

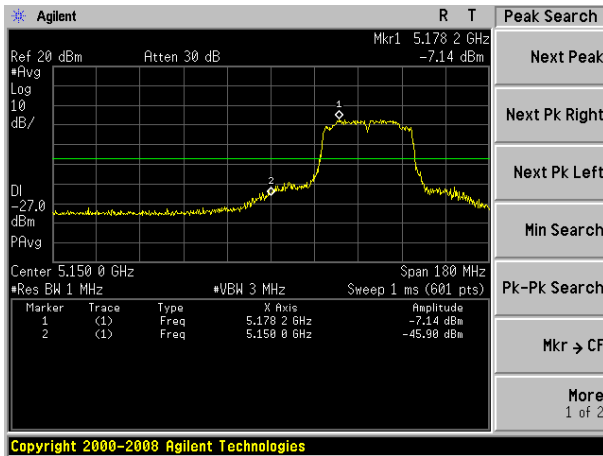

Copyright 2000-2008 Agilent Technologies

(802.11ac20) Band Edge, Left Side

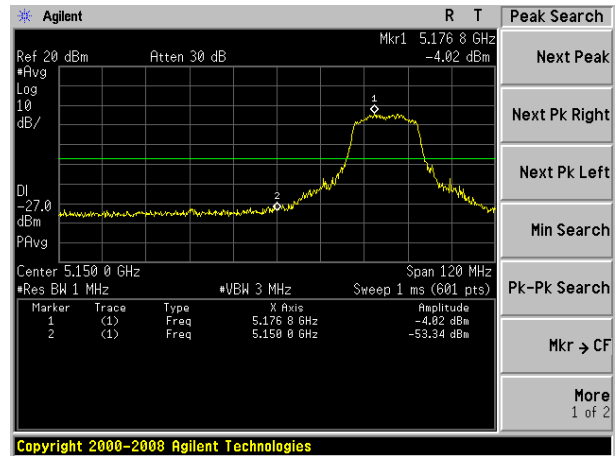

Copyright 2000-2008 Agilent Technologies

(802.11n40) Band Edge, Right Side

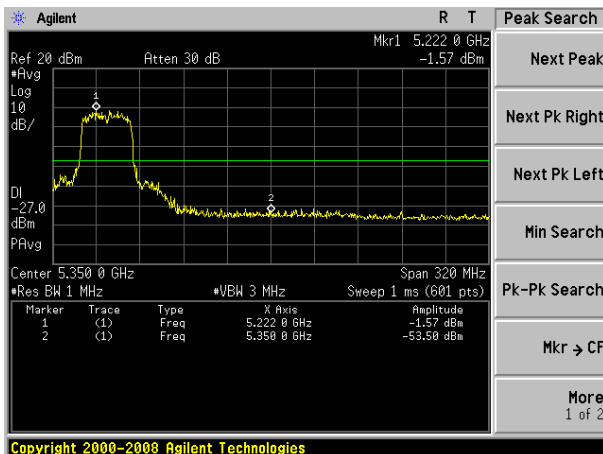

Copyright 2000-2008 Agilent Technologies

(802.11ac20) Band Edge, Right Side

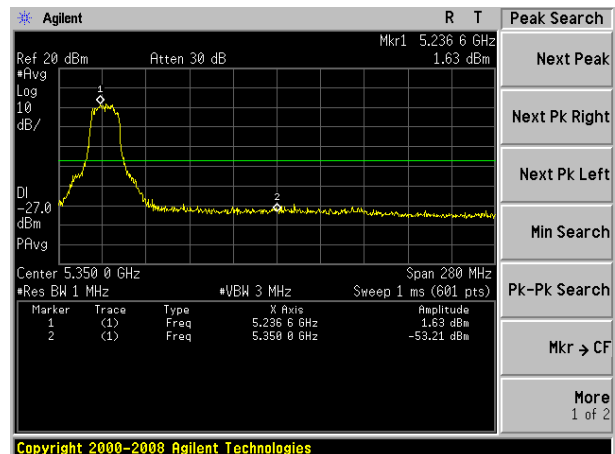

Copyright 2000-2008 Agilent Technologies



5.15~5.25 GHz

(802.11ac40) Band Edge, Left Side

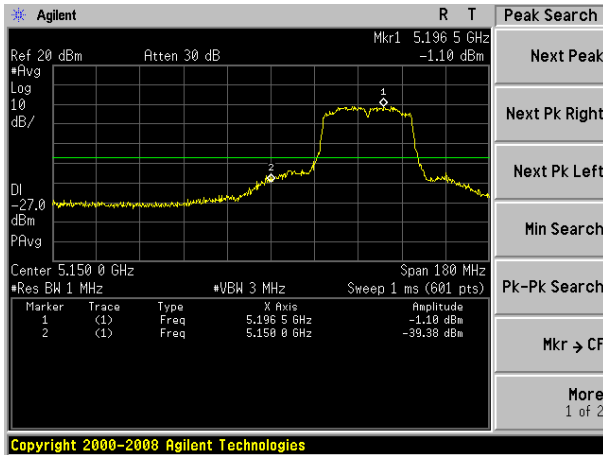

(802.11ac80) Band Edge, Left Side

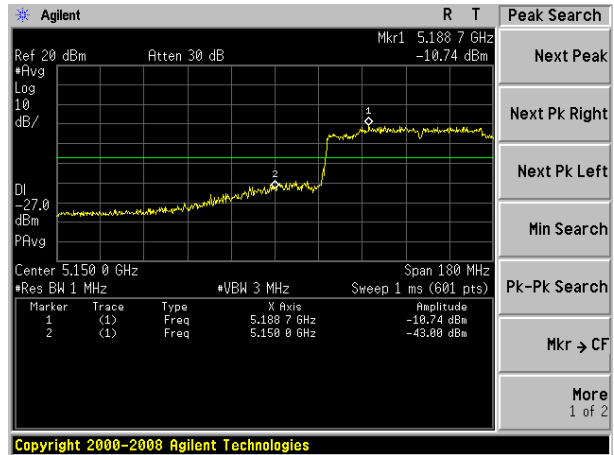

(802.11ac40) Band Edge, Right Side

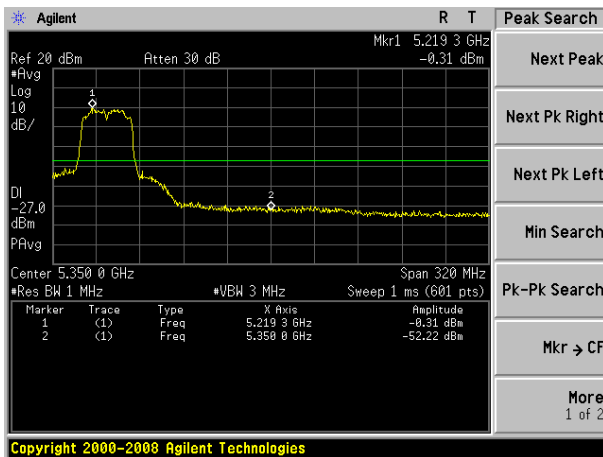

(802.11ac80) Band Edge, Right Side

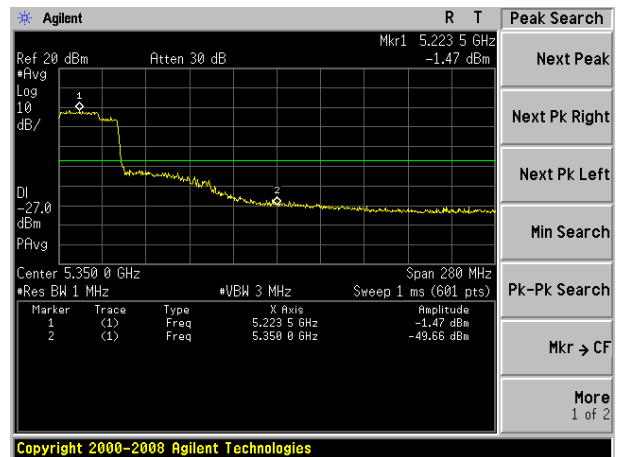

5.8G

5.75~5.85 GHz

(802.11a) Band Edge, Left Side

(802.11n20) Band Edge, Left Side

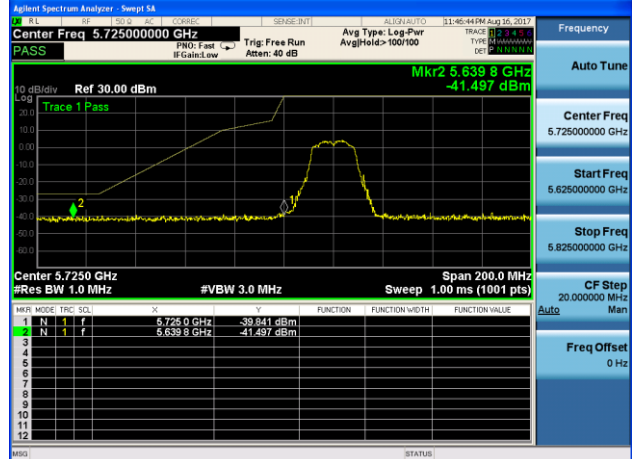
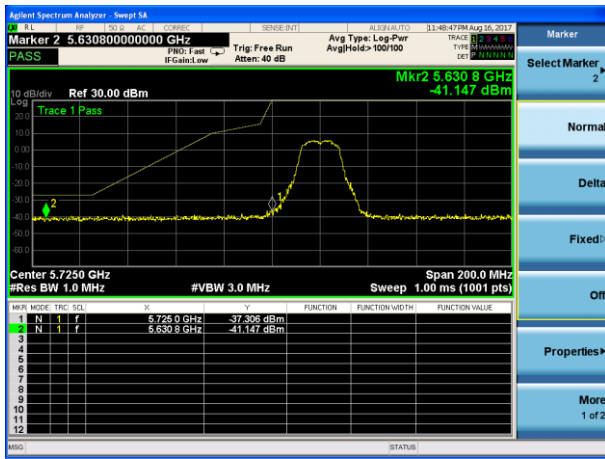

(802.11a) Band Edge, Right Side

(802.11n20) Band Edge, Right Side

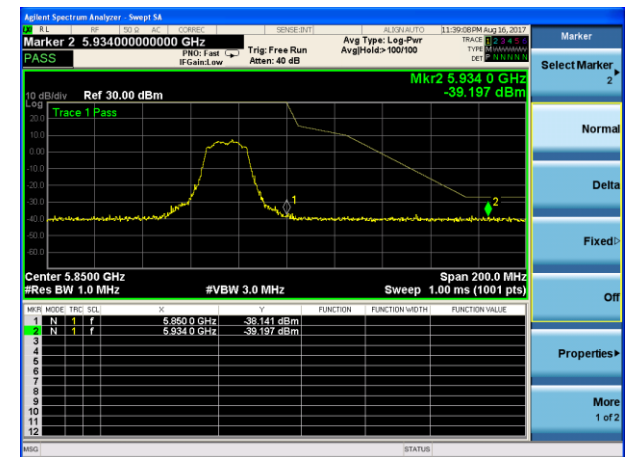
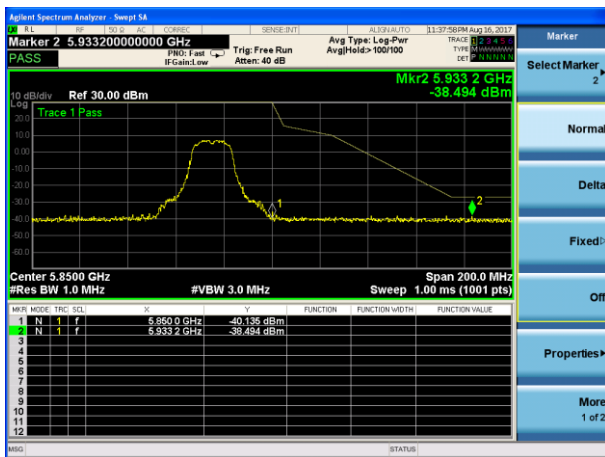

5.75~5.85 GHz

(802.11n40) Band Edge, Left Side

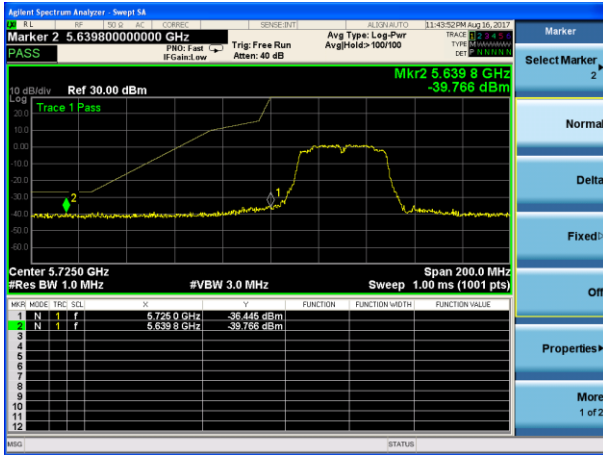

(802.11ac20) Band Edge, Left Side

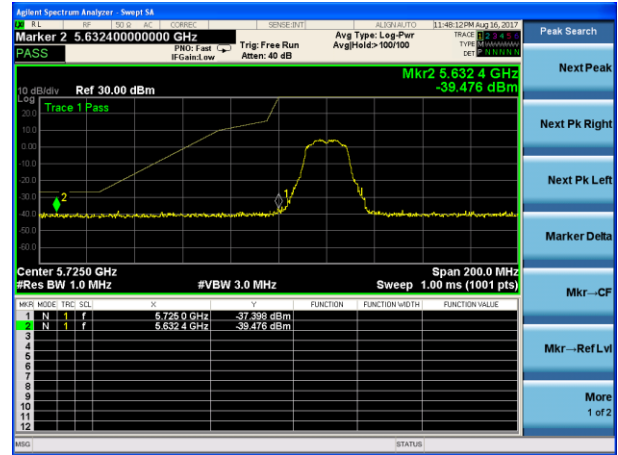

(802.11n40) Band Edge, Right Side

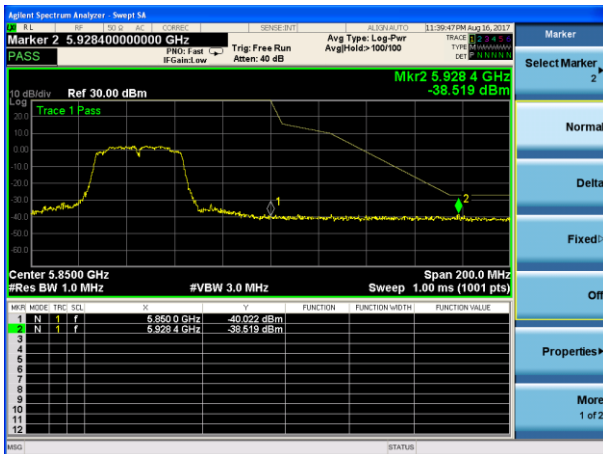

(802.11ac20) Band Edge, Right Side

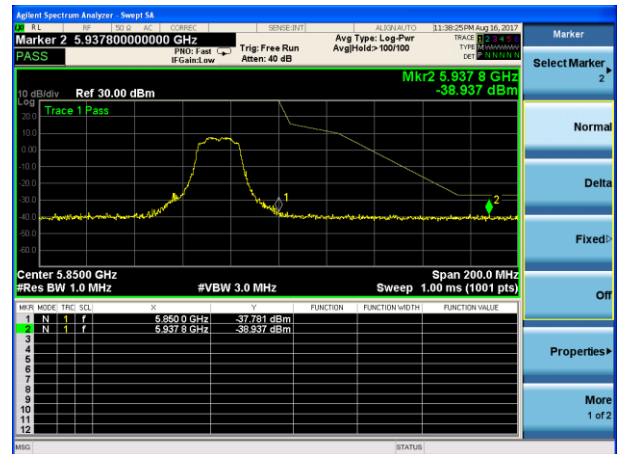

5.75~5.83 GHz

(802.11ac40) Band Edge, Left Side

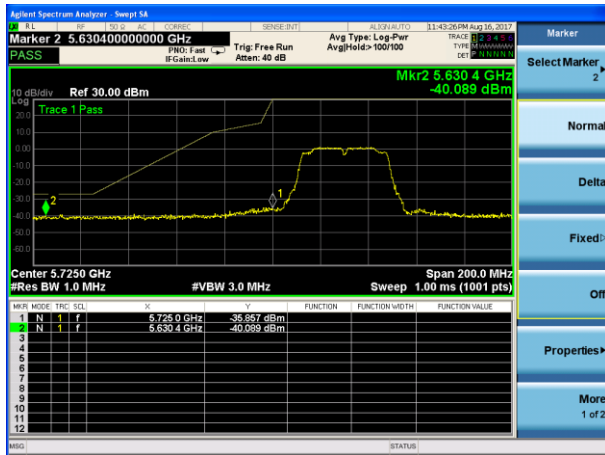

(802.11ac80) Band Edge, Left Side

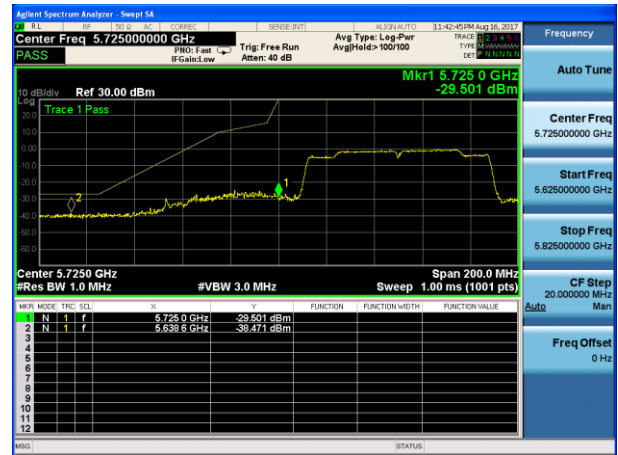

(802.11ac40) Band Edge, Right Side

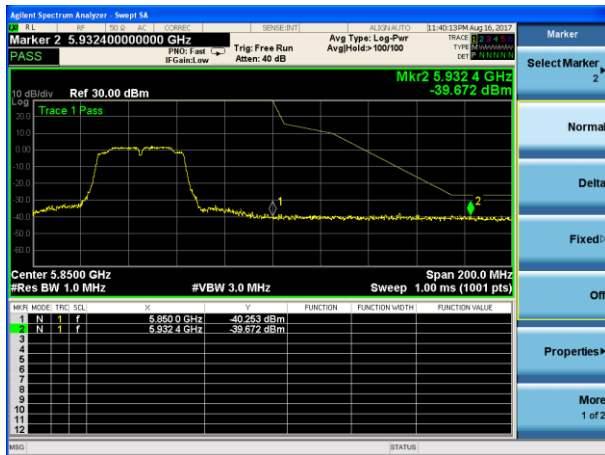

(802.11ac80) Band Edge, Right Side



## 9.SPURIOUS RF CONDUCTED EMISSIONS

### 9.1 CONFORMANCE LIMIT

1. Below -20dB of the highest emission level in operating band.
2. Fall in the restricted bands listed in section 15.205. The maximum permitted average field strength is listed in section 15.209.

### 9.2 MEASURING INSTRUMENTS

The Measuring equipment is listed in the section 6.3 of this test report.

### 9.3 TEST SETUP

Please refer to Section 6.1 of this test report.

### 9.4 TEST PROCEDURE

The Spurious RF conducted emissions compliance of RF radiated emission should be measured by following the guidance in ANSI C63.10-2013 with respect to maximizing the emission by rotating the EUT, measuring the emission while the EUT is situated in three orthogonal planes (if appropriate), adjusting the measurement antenna height and polarization etc. Set RBW=100kHz and VBW= 300KHz to measure the peak field strength , and measure frequency range from 9KHz to 26.5GHz.

### 9.5 TEST RESULTS

Remark: The measurement frequency range is from 9KHz to the 10th harmonic of the fundamental frequency. The lowest, middle and highest channels are tested to verify the spurious emissions and band edge measurement data.

Note: A(B) Represent the value of antenna A and B, The worst data is Antenna B , only shown Antenna B Plot.

5.2G

Test Plot

802.11a on channel 36

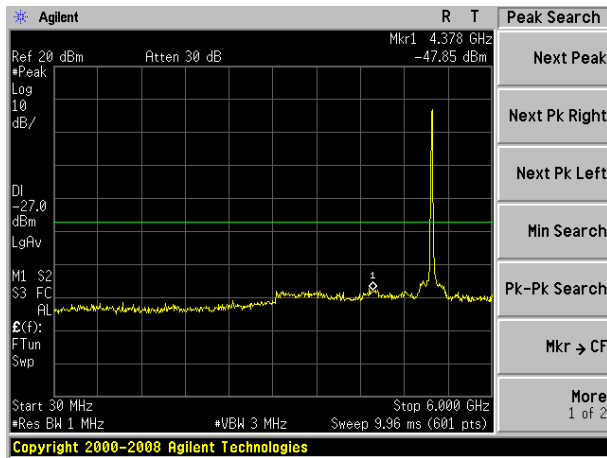

802.11a on channel 40

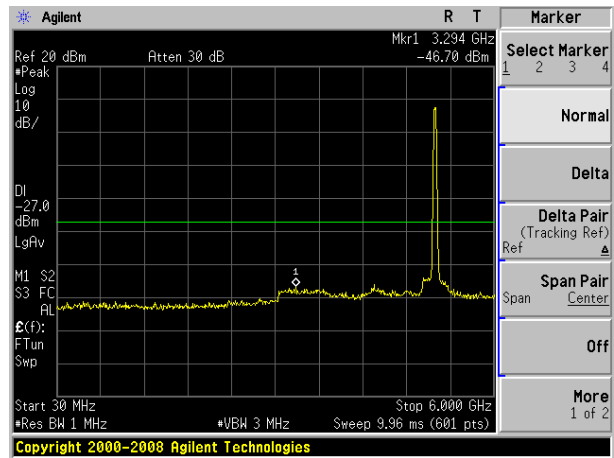

802.11a on channel 36

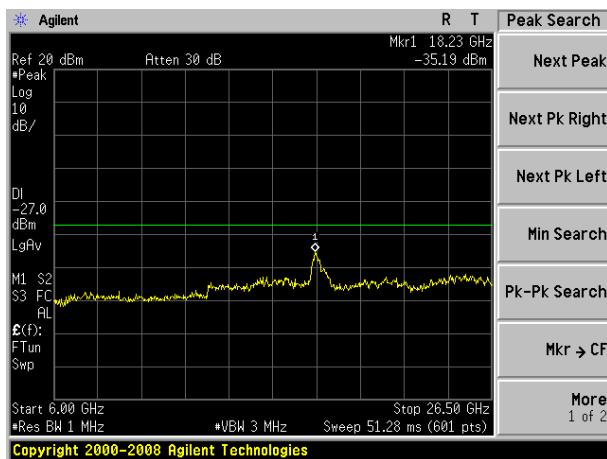

802.11a on channel 40

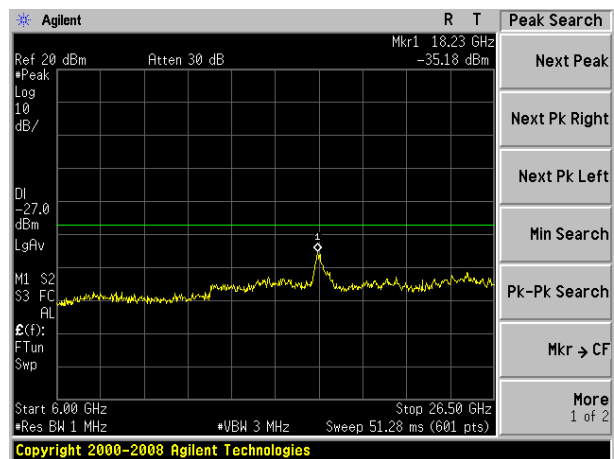

Test Plot

802.11a on channel 48

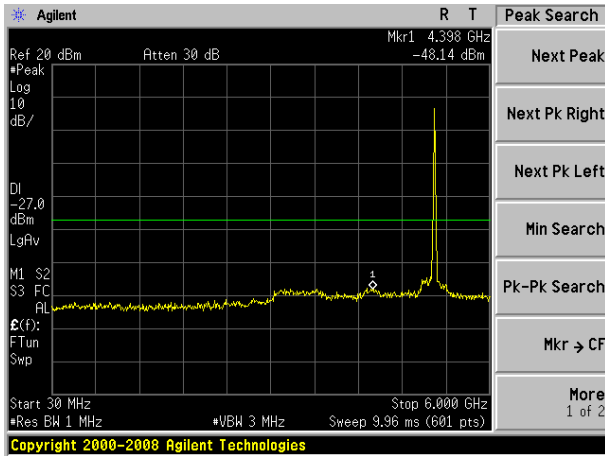

802.11n20 on channel 36

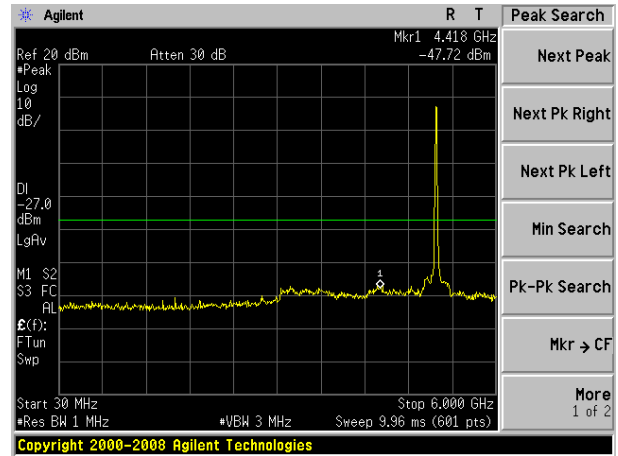

802.11a on channel 48

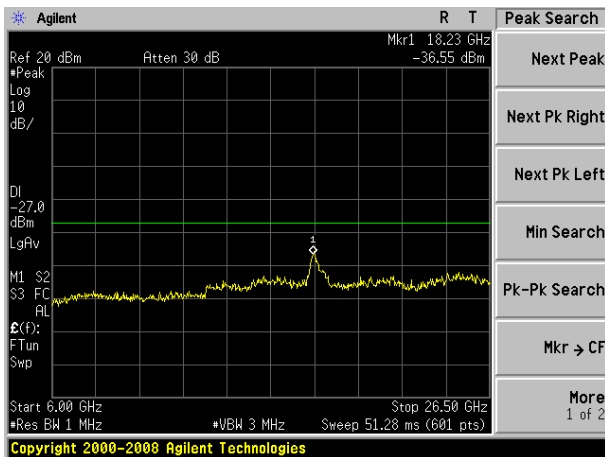

802.11n20 on channel 36

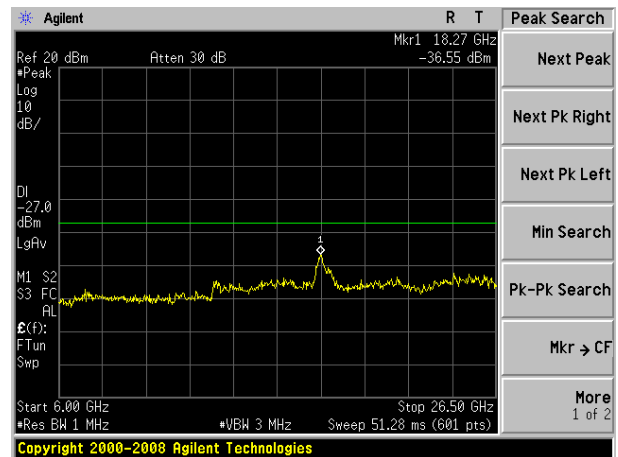

Test Plot

802.11n20 on channel 40

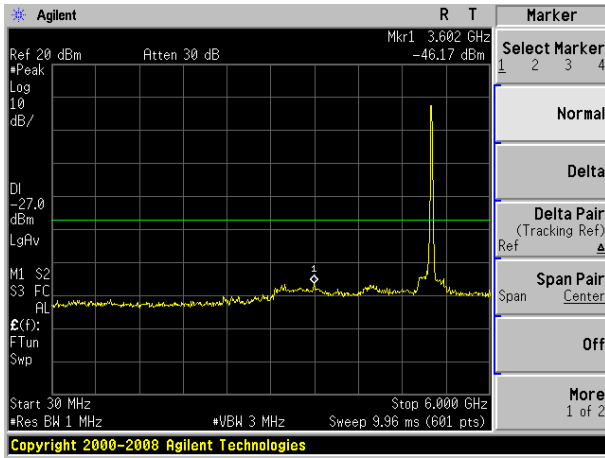

802.11n20 on channel 48

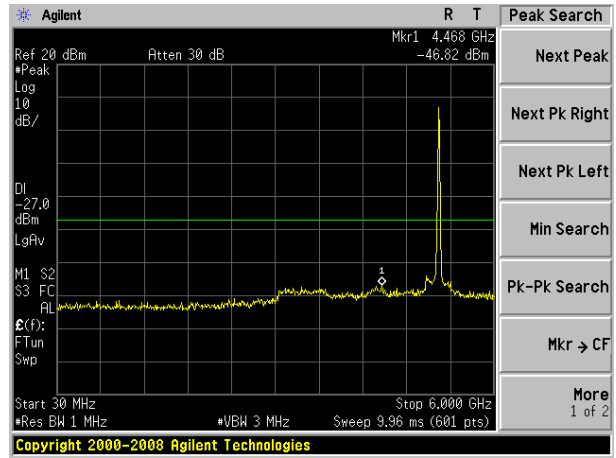

802.11n20 on channel 40

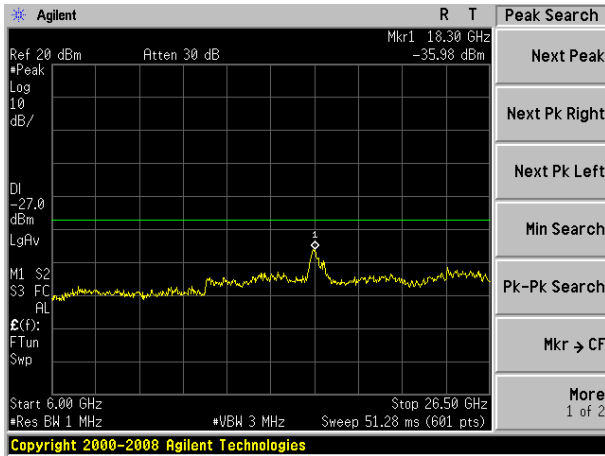

802.11n20 on channel 48

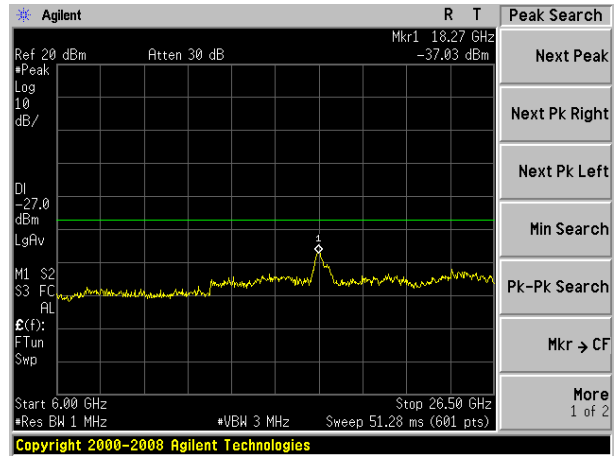



Test Plot

802.11n40 on channel 38

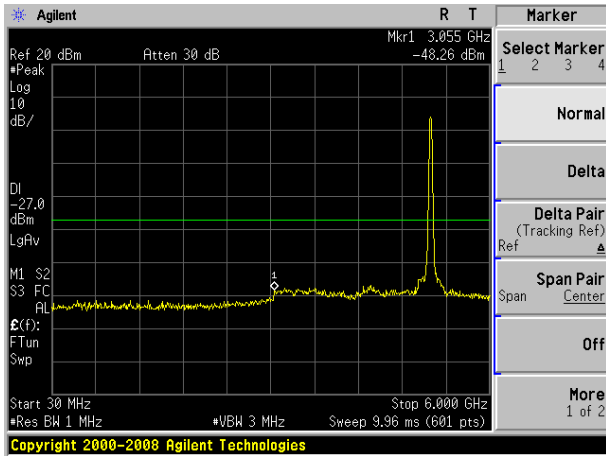

802.11n40 on channel 46

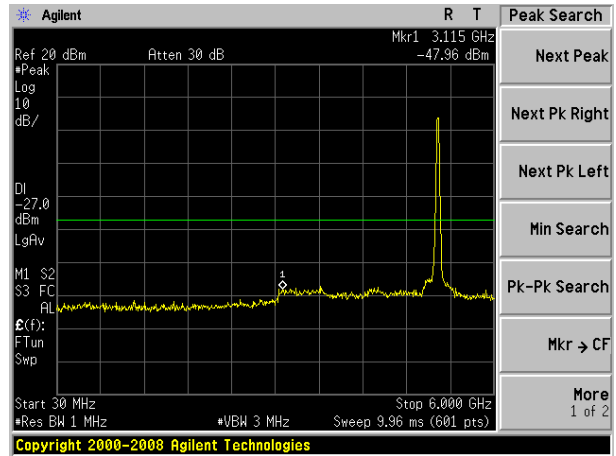

802.11n40 on channel 38

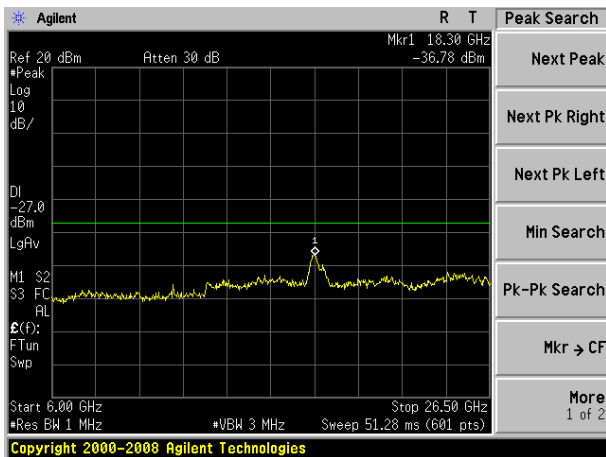

802.11n40 on channel 46

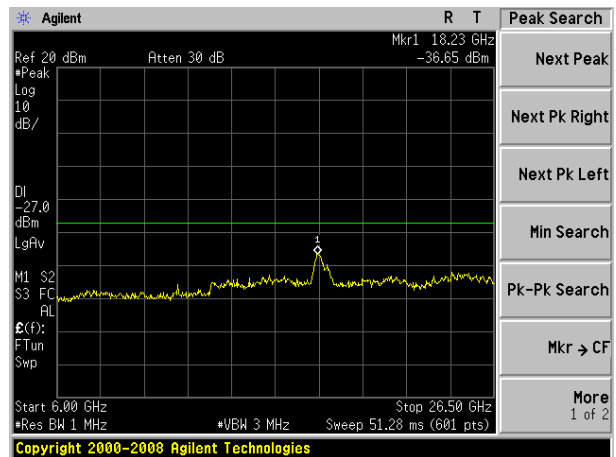

Test Plot

802.11ac20 on channel 36

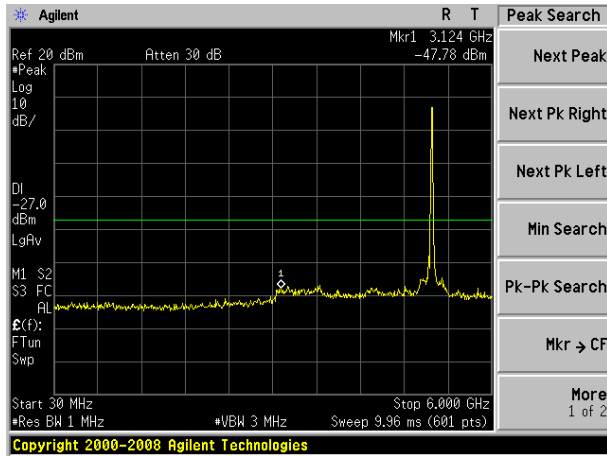

802.11ac20 on channel 40

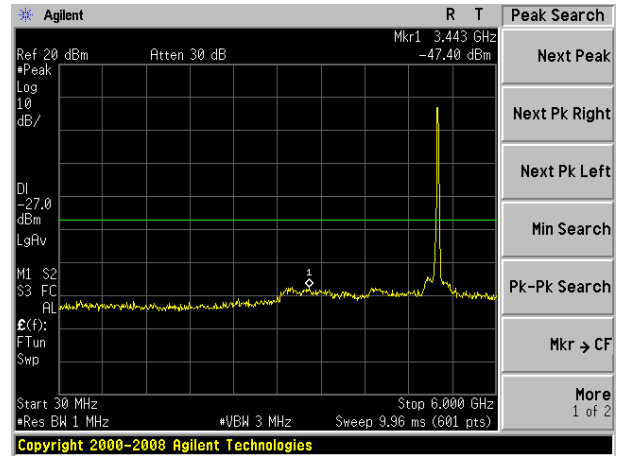

802.11ac20 on channel 36

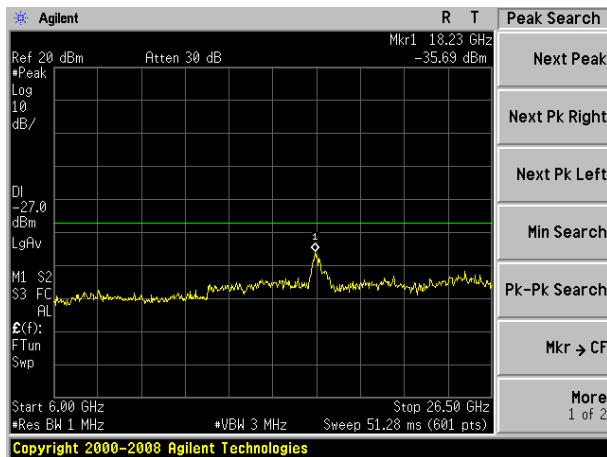

802.11ac20 on channel 40

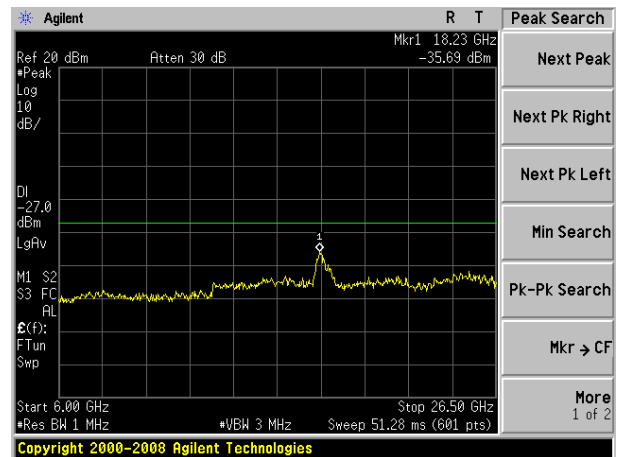

Test Plot

802.11ac20 on channel 48

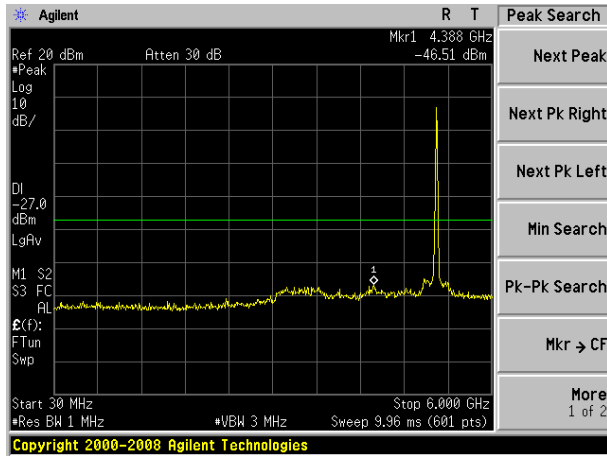

802.11ac40 on channel 38

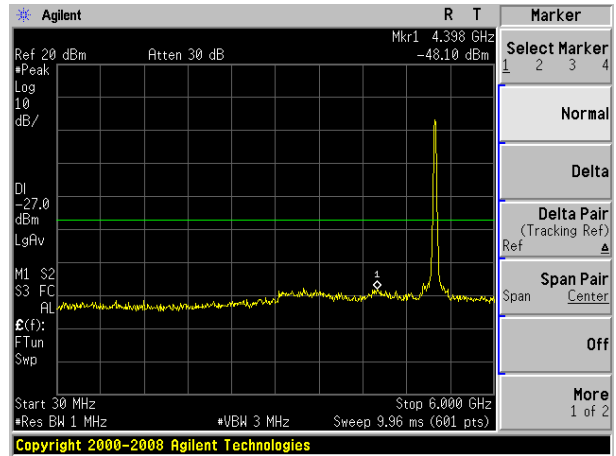

802.11ac20 on channel 48

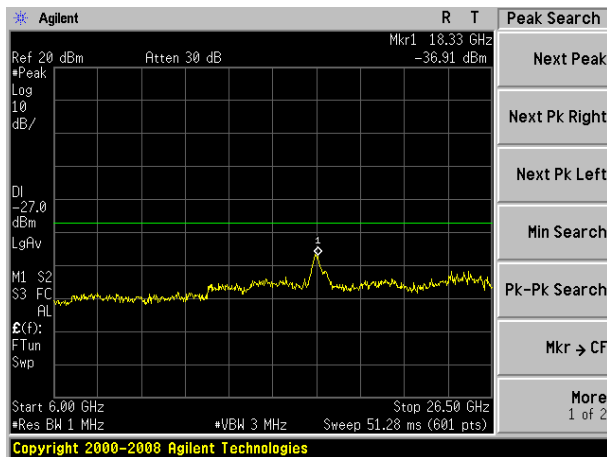

802.11ac40 on channel 38

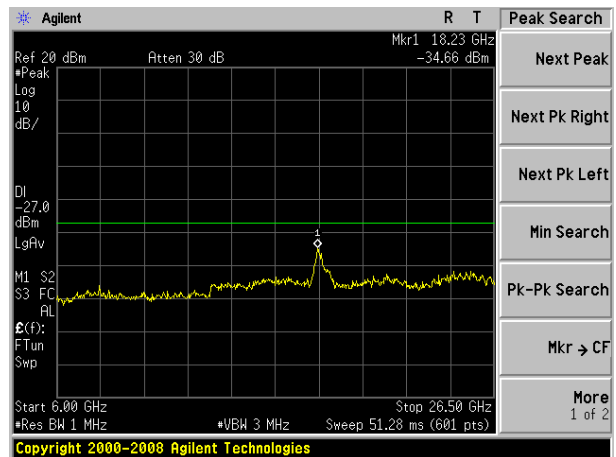

### Test Plot

802.11ac40 on channel 46

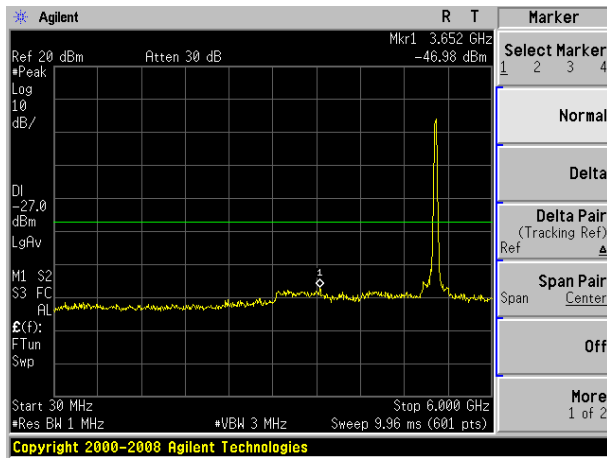

802.11ac80 on channel 42

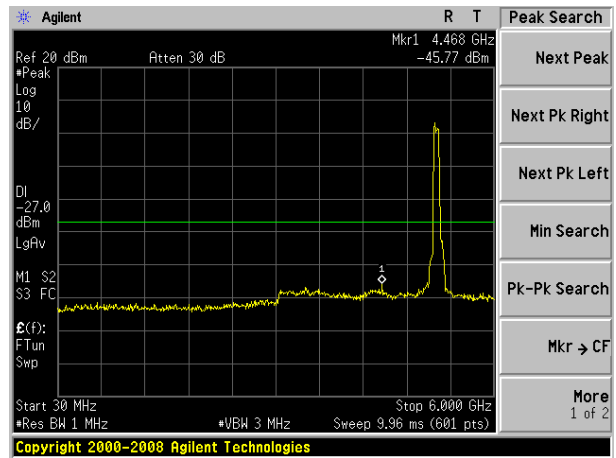

802.11 ac40 on channel 46

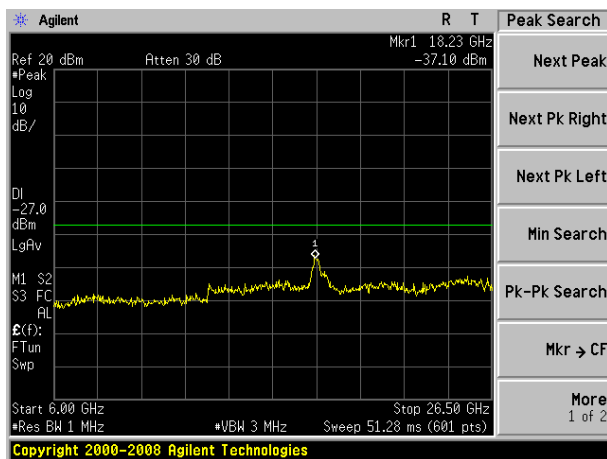

802.11 ac80 on channel 42

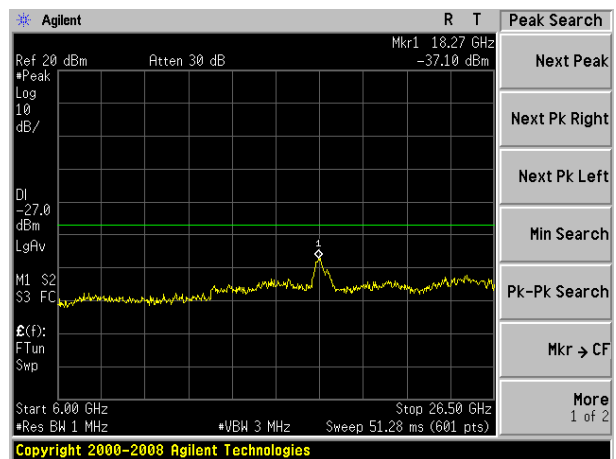

5.8G

Test Plot

802.11a on channel 149

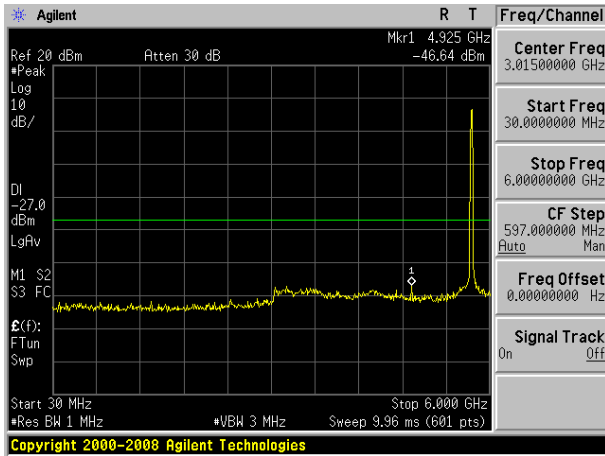

802.11a on channel 157

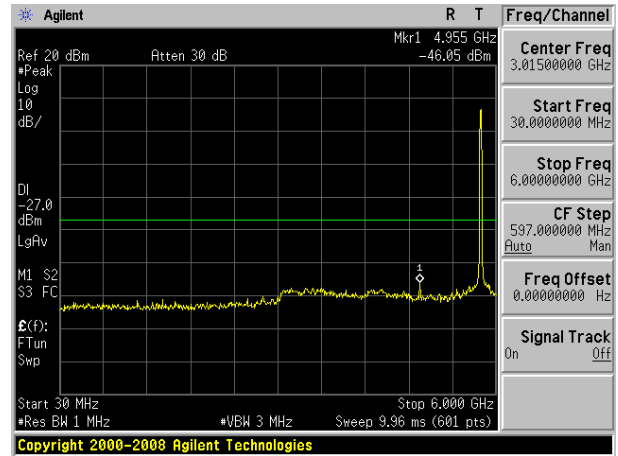

802.11a on channel 149

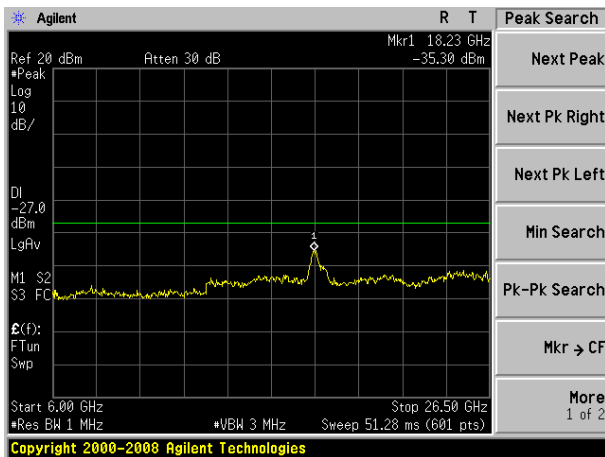

802.11a on channel 157

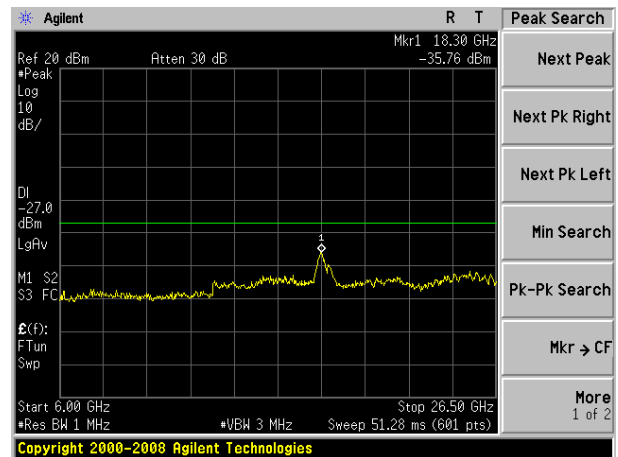

Test Plot

802.11a on channel 165

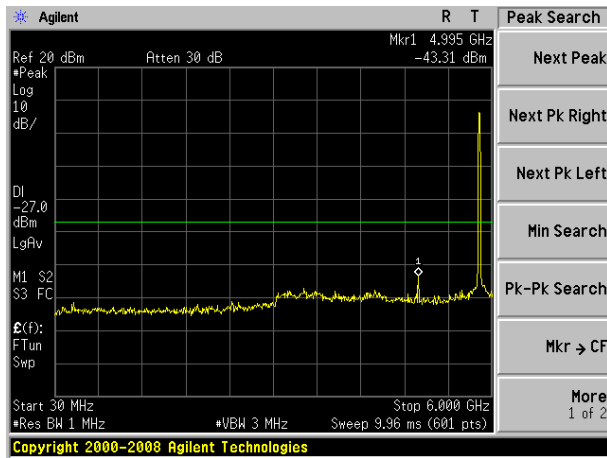

802.11n20 on channel 149

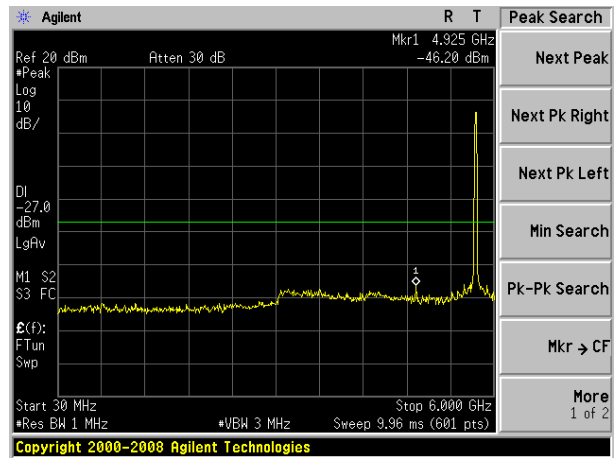

802.11a on channel 165

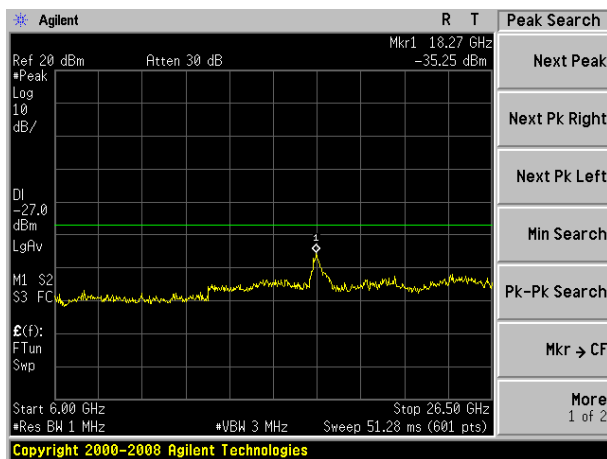

802.11n20 on channel 149

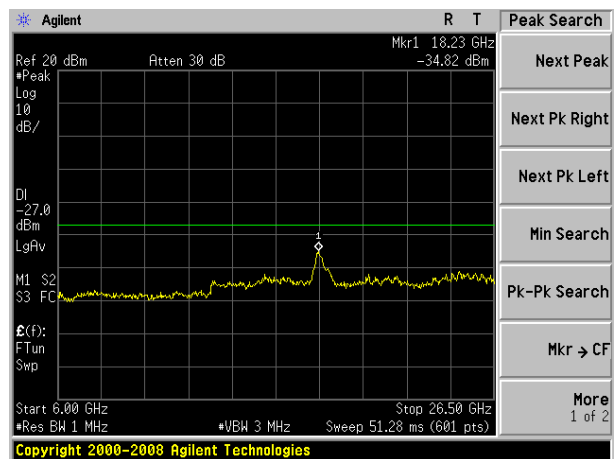

Test Plot

802.11n20 on channel 157

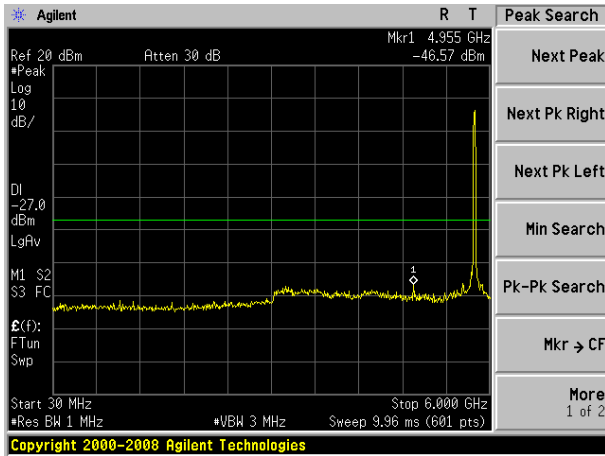

802.11n20 on channel 165

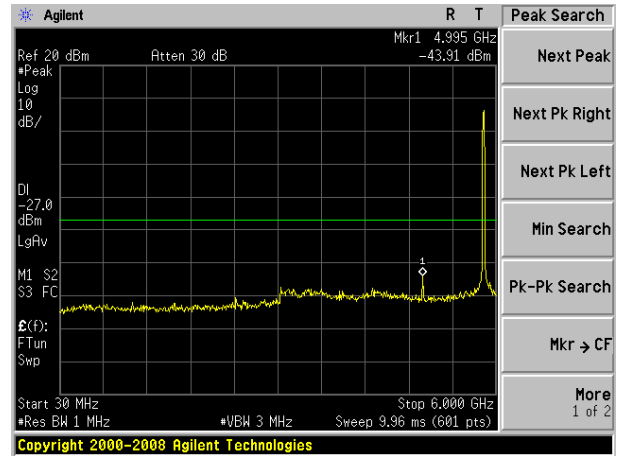

802.11n20 on channel 157

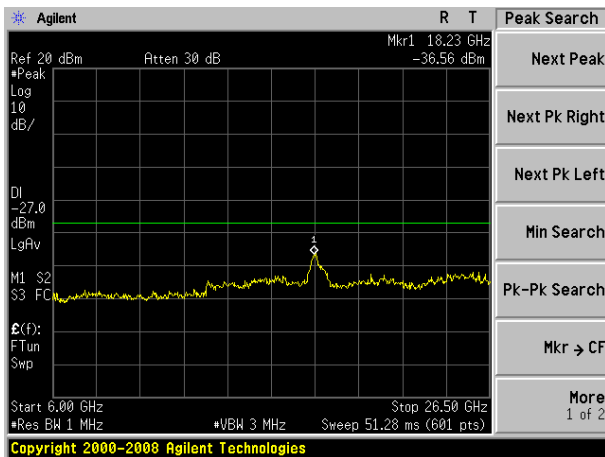

802.11n20 on channel 165

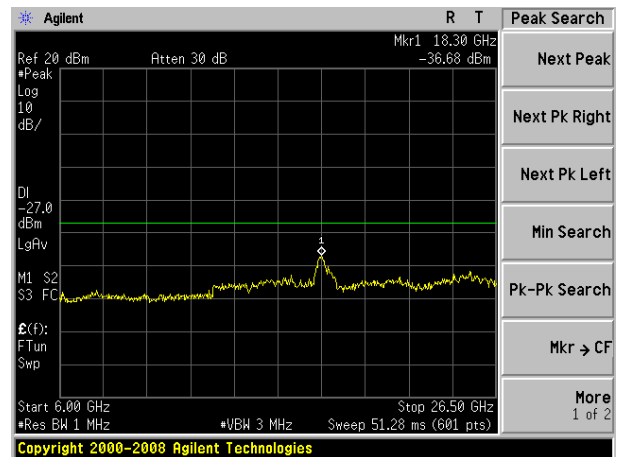

Test Plot

802.11n40 on channel 151

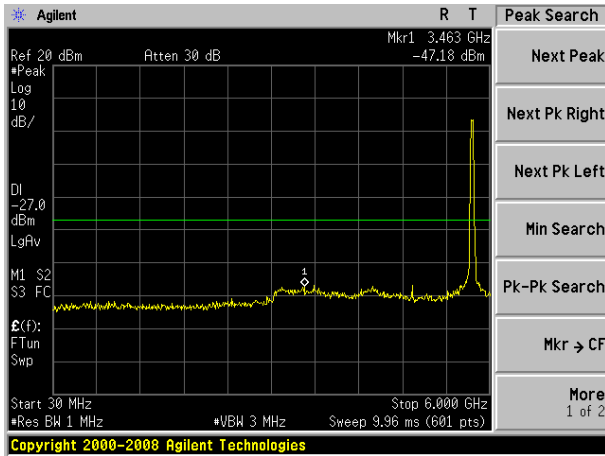

802.11n40 on channel 159

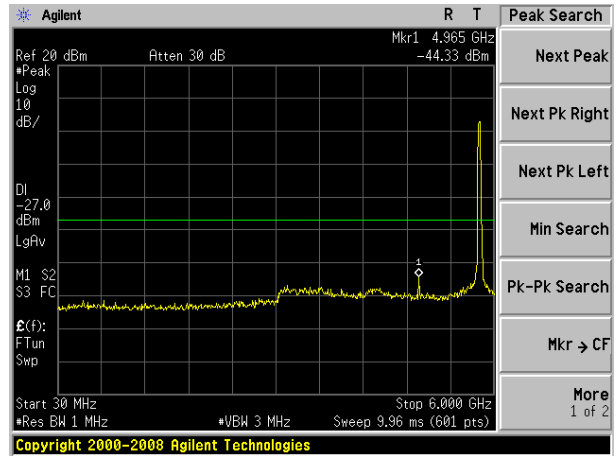

802.11n40 on channel 151

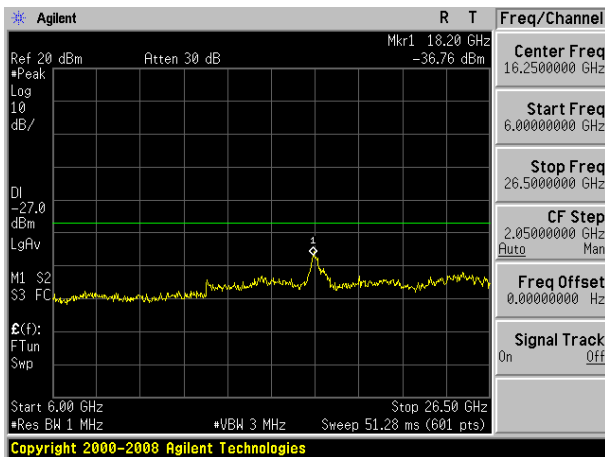

802.11n40 on channel 159

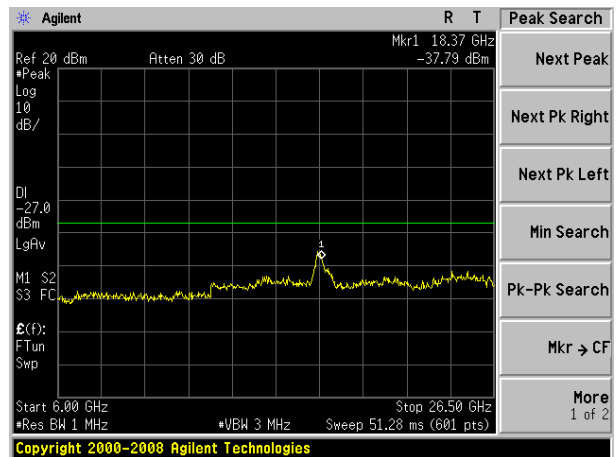



Test Plot

802.11ac20 on channel 149

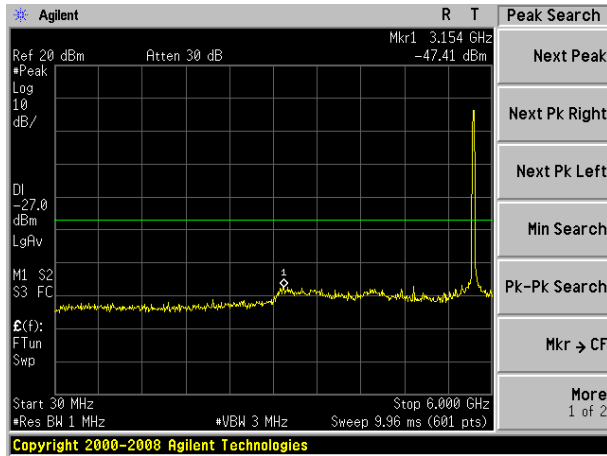

802.11ac20 on channel 157

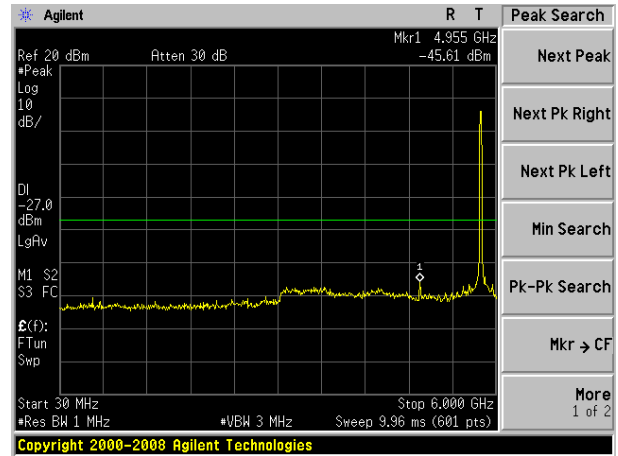

802.11ac20 on channel 149

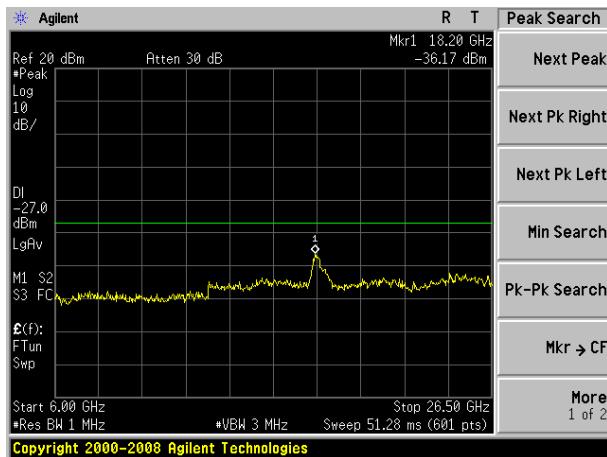

802.11ac20 on channel 157

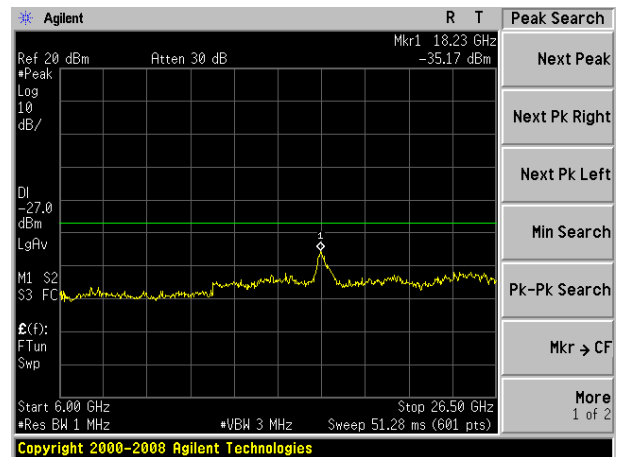

Test Plot

802.11ac20 on channel 165

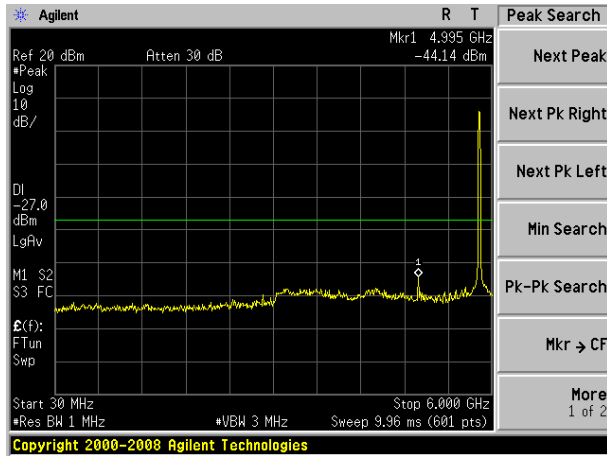

802.11ac40 on channel 151

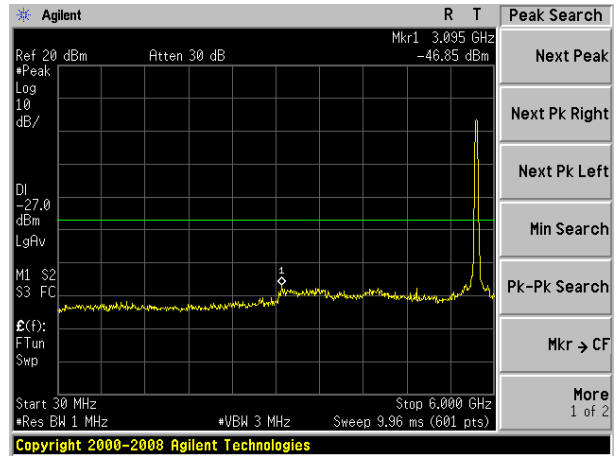

802.11ac20 on channel 165

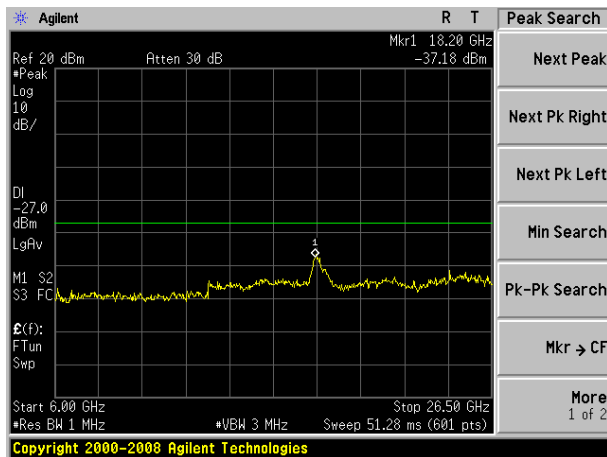

802.11ac40 on channel 151

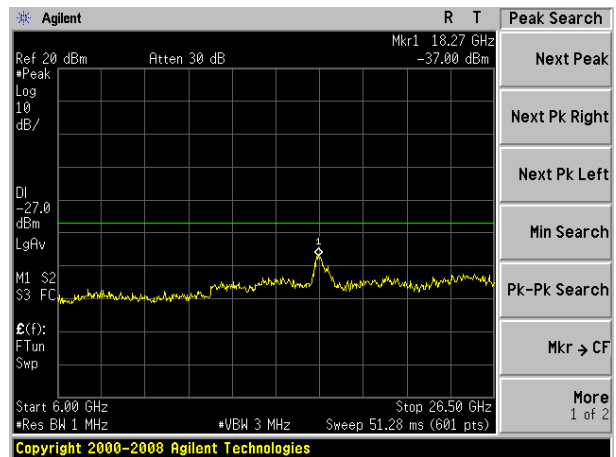

Test Plot

802.11ac40 on channel 159

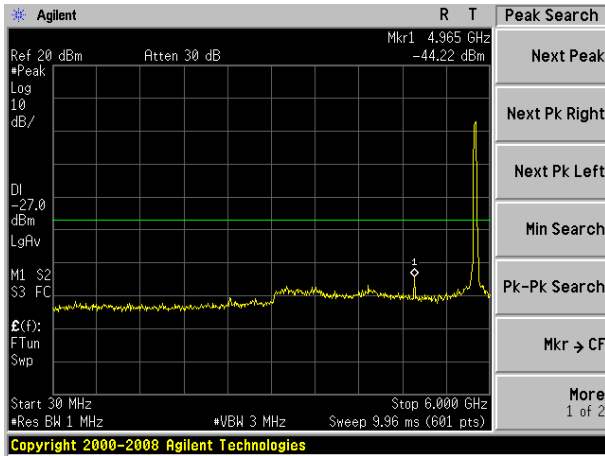

802.11ac80 on channel 155

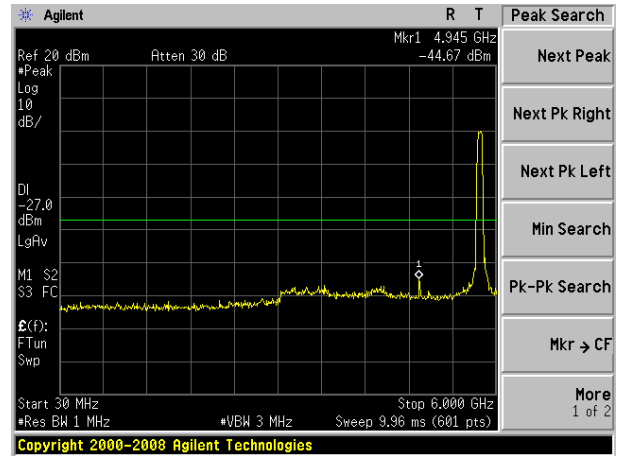

802.11 ac40 on channel 159

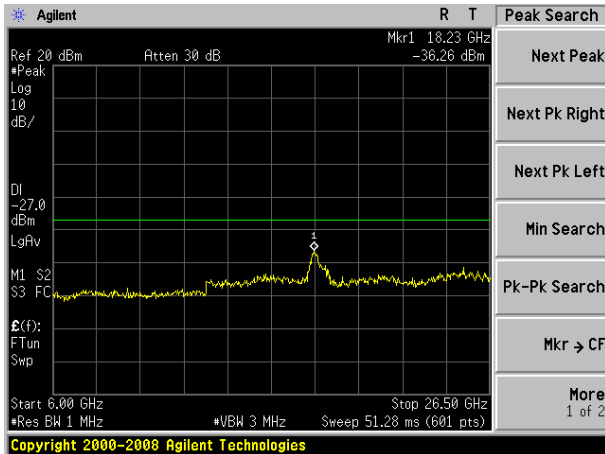

802.11 ac80 on channel 155

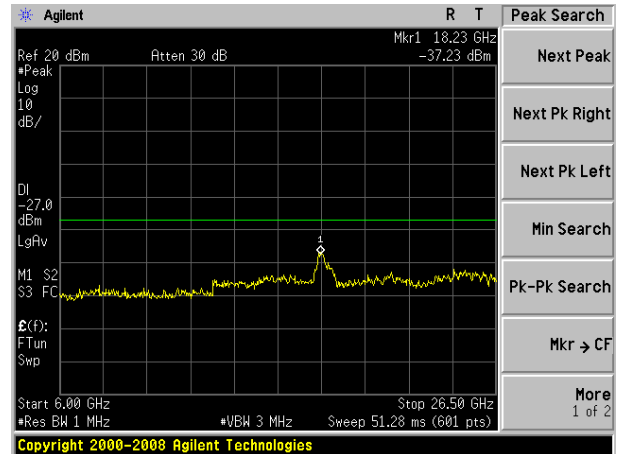

## 10. Frequency Stability Measurement

### 10.1 LIMIT

Manufactures of U-NII devices are responsible for ensuring frequency stability such that an emission is maintained within the band of operation under all conditions of normal operation as specified in the user's manual.

The transmitter center frequency tolerance shall be  $\pm 20$  ppm maximum for the 5 GHz band (IEEE 802.11n specification).

### 10.2 TEST PROCEDURES

1. The transmitter output (antenna port) was connected to the spectrum analyzer.
2. EUT have transmitted absence of modulation signal and fixed channelize.
3. Set the spectrum analyzer span to view the entire absence of modulation emissions bandwidth.
4. Set RBW = 10 kHz, VBW = 10 kHz with peak detector and maxhold settings.
5.  $f_c$  is declaring of channel frequency. Then the frequency error formula is  $(f_c - f) / f_c \times 10^6$  ppm and the limit is less than  $\pm 20$  ppm (IEEE 802.11n specification).
6. The test extreme voltage is to change the primary supply voltage from 85 to 115 percent of the nominal value
7. Extreme temperature is  $-20^\circ\text{C} \sim 70^\circ\text{C}$ .

### 10.3 TEST SETUP LAYOUT

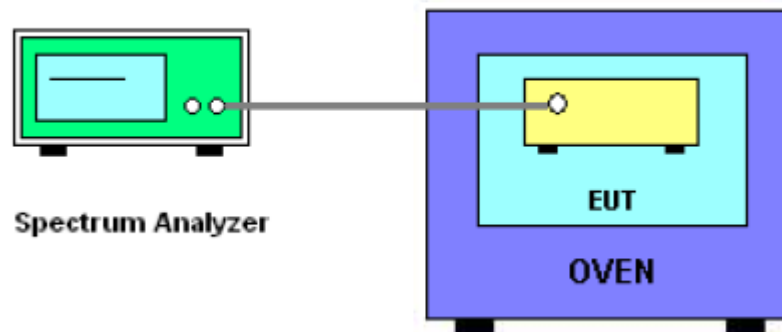

### 10.4 EUT OPERATION DURING TEST

The EUT was programmed to be in continuously un-modulation transmitting mode.

**10.5 TEST RESULTS**

EUT :	notebook	Model Name. :	TEV-EL2in1-116-2
Temperature :	25 °C	Relative Humidity :	56%
Pressure :	1012 hPa	Test Voltage :	DC 7.6V
Test Mode :	TX Frequency Band I (5150-5250MHz)		

**Voltage vs. Frequency Stability**

TEST CONDITIONS				Reference Frequency: 5180MHz			
				f	fc	Max. Deviation (MHz)	Max. Deviation (ppm)
T nom (°C)	20	V nom (V)	7.60	5180.01254	5180	0.01254	-2.4208
		V max (V)	8.74	5180.00852	5180	0.00852	-1.6448
		V min (V)	6.46	5180.01264	5180	0.01264	-2.4402
Limits				Within 5150MHz-5250MHz			
Result				Complies			

**Temperature vs. Frequency Stability**

TEST CONDITIONS				Reference Frequency: 5180MHz			
				f	fc	Max. Deviation (MHz)	Max. Deviation (ppm)
V nom (V)	7.6	T (°C)	-20	5180.00248	5180	0.00248	-0.4788
		T (°C)	-10	5180.00168	5180	0.00168	-0.3243
		T (°C)	0	5180.01672	5180	0.01672	-3.2278
		T (°C)	10	5180.01124	5180	0.01124	-2.1699
		T (°C)	20	5180.01162	5180	0.01162	-2.2432
		T (°C)	30	5180.01265	5180	0.01265	-2.4421
		T (°C)	40	5180.01284	5180	0.01284	-2.4788
		T (°C)	50	5180.01275	5180	0.01275	-2.4614
		T (°C)	60	5180.01368	5180	0.01368	-2.6409
		T (°C)	70	5180.01495	5180	0.01495	-2.8861
Limits				Within 5150MHz-5250MHz			
Result				Complies			

Voltage vs. Frequency Stability

TEST CONDITIONS				Reference Frequency: 5200MHz			
				f	fc	Max. Deviation (MHz)	Max. Deviation (ppm)
T nom (°C)	20	V nom (V)	7.60	5200.02248	5200	0.02248	-4.3231
		V max (V)	8.74	5200.02185	5200	0.02185	-4.2019
		V min (V)	6.46	5200.02294	5200	0.02294	-4.4115
Limits				Within 5150MHz-5250MHz			
Result				Complies			

Temperature vs. Frequency Stability

TEST CONDITIONS				Reference Frequency: 5200MHz			
				f	fc	Max. Deviation (MHz)	Max. Deviation (ppm)
V nom (V)	7.6	T (°C)	-20	5200.00264	5200	0.00264	-0.5077
		T (°C)	-10	5200.00675	5200	0.00675	-1.2981
		T (°C)	0	5200.01668	5200	0.01668	-3.2077
		T (°C)	10	5200.01175	5200	0.01175	-2.2596
		T (°C)	20	5200.01768	5200	0.01768	-3.4000
		T (°C)	30	5200.02116	5200	0.02116	-4.0692
		T (°C)	40	5200.02062	5200	0.02062	-3.9654
		T (°C)	50	5200.02574	5200	0.02574	-4.9500
		T (°C)	60	5200.02263	5200	0.02263	-4.3519
		T (°C)	70	5200.02255	5200	0.02255	-4.3365
Limits				Within 5150MHz-5250MHz			
Result				Complies			

Voltage vs. Frequency Stability

TEST CONDITIONS				Reference Frequency: 5240MHz			
				f	fc	Max. Deviation (MHz)	Max. Deviation (ppm)
T nom (°C)	20	V nom (V)	7.60	5240.00185	5240	0.00185	-0.3531
		V max (V)	8.74	5240.00168	5240	0.00168	-0.3206
		V min (V)	6.46	5240.00648	5240	0.00648	-1.2366
Limits				Within 5150MHz-5250MHz			
Result				Complies			

Temperature vs. Frequency Stability

TEST CONDITIONS				Reference Frequency: 5240MHz			
				f	fc	Max. Deviation (MHz)	Max. Deviation (ppm)
V nom (V)	7.6	T (°C)	-20	5240.01178	5240	0.01178	-2.2481
		T (°C)	-10	5240.00347	5240	0.00347	-0.6622
		T (°C)	0	5240.01162	5240	0.01162	-2.2176
		T (°C)	10	5240.01214	5240	0.01214	-2.3168
		T (°C)	20	5240.01132	5240	0.01132	-2.1603
		T (°C)	30	5240.01385	5240	0.01385	-2.6431
		T (°C)	40	5240.01294	5240	0.01294	-2.4695
		T (°C)	50	5240.01267	5240	0.01267	-2.4179
		T (°C)	60	5240.00375	5240	0.00375	-0.7156
		T (°C)	70	5240.01286	5240	0.01286	-2.4542
Limits				Within 5150MHz-5250MHz			
Result				Complies			

EUT :	notebook	Model Name. :	TEV-EL2in1-116-2
Temperature :	25 °C	Relative Humidity :	56%
Pressure :	1012 hPa	Test Voltage :	DC 7.6V
Test Mode :	TX Frequency(5725-5850MHz)		

TEST CONDITIONS				Reference Frequency: 5745MHz			
				f	fc	Max. Deviation (MHz)	Max. Deviation (ppm)
T nom (°C)	20	V nom (V)	7.60	5745.00435	5745	0.00435	-0.7580
		V max (V)	8.74	5745.01096	5745	0.01096	-1.9070
		V min (V)	6.46	5745.00346	5745	0.00346	-0.6021
Limits				Within 5725-5850MHz			
Result				Complies			

Voltage vs. Frequency Stability

Temperature vs. Frequency Stability

TEST CONDITIONS				Reference Frequency: 5745MHz			
				f	fc	Max. Deviation (MHz)	Max. Deviation (ppm)
V nom (V)	7.6	T (°C)	-20	5745.00631	5745	0.00631	-1.0983
		T (°C)	-10	5745.00250	5745	0.00250	-0.4360
		T (°C)	0	5745.00054	5745	0.00054	-0.0939
		T (°C)	10	5745.00386	5745	0.00386	-0.6711
		T (°C)	20	5745.01197	5745	0.01197	-2.0834
		T (°C)	30	5745.00591	5745	0.00591	-1.0285
		T (°C)	40	5745.00867	5745	0.00867	-1.5085
		T (°C)	50	5745.00030	5745	0.00030	-0.0521
		T (°C)	60	5745.01293	5745	0.01293	-2.2509
		T (°C)	70	5745.00269	5745	0.00269	-0.4684
Limits				Within 5725-5850MHz			
Result				Complies			



Voltage vs. Frequency Stability

TEST CONDITIONS				Reference Frequency: 5785MHz			
				f	fc	Max. Deviation (MHz)	Max. Deviation (ppm)
T nom (°C)	20	V nom (V)	7.60	5785.00056	5785	0.00056	-0.0970
		V max (V)	8.74	5785.00255	5785	0.00255	-0.4410
		V min (V)	6.46	5785.00766	5785	0.00766	-1.3247
Limits				Within 5725-5850MHz			
Result				Complies			

Temperature vs. Frequency Stability

TEST CONDITIONS				Reference Frequency: 5785MHz			
				f	fc	Max. Deviation (MHz)	Max. Deviation (ppm)
V nom (V)	7.6	T (°C)	-20	5785.00689	5785	0.00689	-1.1919
		T (°C)	-10	5785.00163	5785	0.00163	-0.2826
		T (°C)	0	5785.01043	5785	0.01043	-1.8035
		T (°C)	10	5785.01189	5785	0.01189	-2.0554
		T (°C)	20	5785.00156	5785	0.00156	-0.2700
		T (°C)	30	5785.01168	5785	0.01168	-2.0190
		T (°C)	40	5785.00990	5785	0.00990	-1.7106
		T (°C)	50	5785.00817	5785	0.00817	-1.4130
		T (°C)	60	5785.00515	5785	0.00515	-0.8906
		T (°C)	70	5785.00024	5785	0.00024	-0.0421
Limits				Within 5725-5850MHz			
Result				Complies			

Voltage vs. Frequency Stability

TEST CONDITIONS				Reference Frequency: 5825MHz			
				f	fc	Max. Deviation (MHz)	Max. Deviation (ppm)
T nom (°C)	20	V nom (V)	7.60	5825.00503	5825	0.00503	-0.8643
		V max (V)	8.74	5825.01232	5825	0.01232	-2.1153
		V min (V)	6.46	5825.01211	5825	0.01211	-2.0795
Limits				Within 5725-5850MHz			
Result				Complies			

Temperature vs. Frequency Stability

TEST CONDITIONS				Reference Frequency: 5825MHz			
				f	fc	Max. Deviation (MHz)	Max. Deviation (ppm)
V nom (V)	7.6	T (°C)	-20	5825.01163	5825	0.01163	-1.9963
		T (°C)	-10	5825.00965	5825	0.00965	-1.6561
		T (°C)	0	5825.00943	5825	0.00943	-1.6183
		T (°C)	10	5825.00076	5825	0.00076	-0.1312
		T (°C)	20	5825.01104	5825	0.01104	-1.8959
		T (°C)	30	5825.00470	5825	0.00470	-0.8064
		T (°C)	40	5825.00002	5825	0.00002	-0.0032
		T (°C)	50	5825.00064	5825	0.00064	-0.1105
		T (°C)	60	5825.00495	5825	0.00495	-0.8499
		T (°C)	70	5825.00403	5825	0.00403	-0.6911
Limits				Within 5725-5850MHz			
Result				Complies			

## 11. ANTENNA REQUIREMENT

### 11.1 STANDARD REQUIREMENT

15.203 requirement: For intentional device, according to 15.203: an intentional radiator shall be designed to ensure that no antenna other than that furnished by the responsible party shall be used with the device.

### 11.2 EUT ANTENNA

The EUT antenna is permanent attached FPCB antenna(antenna gain:-3.74dBi). It comply with the standard requirement.

END OF REPORT