

# FCC SAR EVALUATION REPORT

**In accordance with the requirements of  
FCC 47 CFR Part 2(2.1093), ANSI/IEEE C95.1-1992 and  
IEEE Std 1528-2013**

**Product Name :** notebook

**Trademark :** N/A

**Model Name :** DTLAPY116-2

**Serial Model :** W1641, W1631, W1637, W1635, W1639, W1640,  
W1645, W1650, W1651, W1656, W1649,  
EV-EL2in1-116-2

**Report No. :** NTEK-2017NT08075522HF-01

**FCC ID :** 2ACPR-DTLAPY116-2

**Prepared for**

SHENZHEN BMORN TECHNOLOGY CO.,LTD.

6/F, Hengfang Verteran Industrial Park, Xingye Road, Xixiang, Bao'an, Shenzhen, Guangdong, China

**Prepared by**

Shenzhen NTEK Testing Technology Co., Ltd.

1/F, Building E, Fenda Science Park, Sanwei Community, Xixiang Street, Bao'an District,  
Shenzhen 518126 P.R.China.

Tel.: +86-755-6115 9388 Fax.: +86-755-6115 6599

Website: <http://www.ntek.org.cn>

### TEST RESULT CERTIFICATION

**Applicant's name**.....: SHENZHEN BMORN TECHNOLOGY CO.,LTD.  
 Address .....: 6/F, Hengfang Verteran Industrial Park, Xingye Road, Xixiang, Bao'an, Shenzhen, Guangdong, China

**Manufacturer's Name**.....: SHENZHEN BMORN TECHNOLOGY CO.,LTD.  
 Address .....: 6/F, Hengfang Verteran Industrial Park, Xingye Road, Xixiang, Bao'an, Shenzhen, Guangdong, China

**Product description**

Product name.....: notebook  
 Trademark .....: N/A  
 Model and/or type reference : DTLAPY116-2  
 Serial Model .....: W1641, W1631, W1637, W1635, W1639, W1640, W1645, W1650, W1651, W1656, W1649, EV-EL2in1-116-2  
 Standards.....: FCC 47 CFR Part 2(2.1093)  
 ANSI/IEEE C95.1-1992  
 IEEE Std 1528-2013  
 Published RF exposure KDB procedures

This device described above has been tested by Shenzhen NTEK. In accordance with the measurement methods and procedures specified in IEEE Std 1528-2013 and KDB 865664 D01. Testing has shown that this device is capable of compliance with localized specific absorption rate (SAR) specified in FCC 47 CFR Part 2(2.1093) and ANSI/IEEE C95.1-1992. The test results in this report apply only to the tested sample of the stated device/equipment. Other similar device/equipment will not necessarily produce the same results due to production tolerance and measurement uncertainties.

This report shall not be reproduced except in full, without the written approval of Shenzhen NTEK, this document may be altered or revised by Shenzhen NTEK, personal only, and shall be noted in the revision of the document.

**Date of Test**

Date (s) of performance of tests .....: Aug. 12, 2017 ~ Aug. 15, 2017  
 Date of Issue.....: May. 28, 2018  
 Test Result.....: **Pass**

*Note: All test data of this report are based on the original test report 2017NT08075522HF, dated by 2017-08-29.*

Prepared By : Cheng Jiawen  
 (Test Engineer) :  
 (Cheng Jiawen)

Approved By : Sam. Chen  
 (Lab Manager) :  
 (Sam Chen)

※ ※ **Revision History** ※ ※

REV.	DESCRIPTION	ISSUED DATE	REMARK
Rev.1.0	Initial Test Report Release	Aug. 29, 2017	Cheng Jiawen
Rev.1.1	Update the address of applicant and manufacture, add one model (EV-EL2in1-116-2)	May. 28, 2018	Cheng Jiawen

## TABLE OF CONTENTS

1. General Information.....	6
1.1. RF exposure limits.....	6
1.2. Statement of Compliance .....	7
1.3. EUT Description .....	8
1.4. Test specification(s).....	9
1.5. Ambient Condition.....	9
2. SAR Measurement System .....	10
2.1. SATIMO SAR Measurement Set-up Diagram .....	10
2.2. Robot .....	11
2.3. E-Field Probe.....	12
2.3.1. E-Field Probe Calibration .....	12
2.4. SAM phantoms .....	13
2.4.1. Technical Data .....	14
2.5. Device Holder .....	15
2.6. Test Equipment List .....	16
3. SAR Measurement Procedures .....	18
3.1. Power Reference .....	18
3.2. Area scan & Zoom scan.....	18
3.3. Description of interpolation/extrapolation scheme .....	20
3.4. Volumetric Scan.....	20
3.5. Power Drift .....	20
4. System Verification Procedure .....	21
4.1. Tissue Verification .....	21
4.1.1. Tissue Dielectric Parameter Check Results.....	22
4.2. System Verification Procedure .....	23
4.2.1. System Verification Results.....	24
5. SAR Measurement variability and uncertainty .....	25
5.1. SAR measurement variability.....	25
5.2. SAR measurement uncertainty .....	25
6. RF Exposure Positions .....	26
6.1. Tablet host platform exposure conditions.....	26
7. RF Output Power.....	27
7.1. Maximum Tune-up Limit.....	27
7.2. WLAN & BT Output Power .....	28
7.2.1. Output Power Results Of WLAN .....	28
7.2.2. Output Power Results Of Bluetooth.....	29
8. Antenna Location.....	30
9. Standalone SAR test exclusion and Simultaneous transmission SAR estimated .....	35
10. SAR Results .....	36
10.1. SAR measurement results.....	36

10.1.1. SAR measurement Result of WLAN 2.4G .....	36
10.1.2. SAR measurement Result of WLAN 5.2G .....	36
10.1.3. SAR measurement Result of WLAN 5.8G .....	37
10.2. Simultaneous Transmission Possibilities .....	37
10.3. SAR Summation Scenario.....	38
11. Appendix A. Photo documentation.....	39
12. Appendix B. System Check Plots .....	44
13. Appendix C. Plots of High SAR Measurement .....	48
14. Appendix D. Calibration Certificate.....	52

## 1. General Information

### 1.1. RF exposure limits

(A).Limits for Occupational/Controlled Exposure (W/kg)

Whole-Body	Partial-Body	Hands, Wrists, Feet and Ankles
0.4	8.0	20.0

(B).Limits for General Population/Uncontrolled Exposure (W/kg)

Whole-Body	Partial-Body	Hands, Wrists, Feet and Ankles
0.08	1.6	4.0

NOTE: **Whole-Body SAR** is averaged over the entire body, **partial-body SAR** is averaged over any 1 gram of tissue defined as a tissue volume in the shape of a cube. **SAR for hands, wrists, feet and ankles** is averaged over any 10 grams of tissue defined as a tissue volume in the shape of a cube.

#### **Occupational/Controlled Environments:**

Are defined as locations where there is exposure that may be incurred by people who are aware of the potential for exposure, (i.e. as a result of employment or occupation).

#### **General Population/Uncontrolled Environments:**

Are defined as locations where there is the exposure of individuals who have no knowledge or control of their exposure.

NOTE  
HEAD AND TRUNK LIMIT  
1.6 W/kg  
APPLIED TO THIS EUT

## 1.2. Statement of Compliance

The maximum results of Specific Absorption Rate (SAR) found during testing for DTLAPY116-2 are as follows.

Band	Max Reported SAR Value(W/kg)	
	1-g Body (Separation distance of 0mm)	Max. SAR Summation
WLAN 2.4G	0.769	1.459
WLAN 5.2G	1.353	
WLAN 5.8G	1.453	

NOTE: The Max. SAR Summation is calculated based on the same configuration and test position.

This device is in compliance with Specific Absorption Rate (SAR) for general population/uncontrolled exposure limits (1.6 W/kg) specified in FCC 47 CFR Part 2(2.1093) and ANSI/IEEE C95.1-1992, and had been tested in accordance with the measurement methods and procedures specified in IEEE Std 1528-2013 & KDB 865664 D01.

### 1.3. EUT Description

Device Information			
Product Name	notebook		
Trademark	N/A		
Model Name	DTLAPY116-2		
Serial Model	W1641, W1631, W1637, W1635, W1639, W1640, W1645, W1650, W1651, W1656, W1649, EV-EL2in1-116-2		
FCC ID	2ACPR-DTLAPY116-2		
Device Phase	Identical Prototype		
Exposure Category	General population / Uncontrolled environment		
Antenna	FPCB Antenna		
Battery Information	DC 7.6V, 4000mAh		
Device Operating Configurations			
Supporting Mode(s)	WLAN 2.4G/5.2G/5.8G, Bluetooth		
Test Modulation	WLAN(DSSS/OFDM), Bluetooth(GFSK, $\pi/4$ -DQPSK, 8DPSK)		
Operating Frequency Range(s)	Band	Tx (MHz)	Rx (MHz)
	WLAN 2.4G	2412-2462	
	WLAN 5.2G	5180-5240	
	WLAN 5.8G	5745-5825	
	Bluetooth	2402-2480	
Test Channels (low-mid-high)	1-3-6-9-11(WLAN 2.4G)		
	36-38-40-42-46-48(WLAN 5.2G)		
	149-151-155-157-159-165(WLAN 5.8G)		



**1.4. Test specification(s)**

FCC 47 CFR Part 2(2.1093)
ANSI/IEEE C95.1-1992
IEEE Std 1528-2013
KDB 865664 D01 SAR measurement 100 MHz to 6 GHz
KDB 865664 D02 RF Exposure Reporting
KDB 447498 D01 General RF Exposure Guidance
KDB 248227 D01 802.11 Wi-Fi SAR
KDB 616217 D04 SAR for laptop and tablets

**1.5. Ambient Condition**

Ambient temperature	20°C – 24°C
Relative Humidity	30% – 70%

## 2. SAR Measurement System

### 2.1. SATIMO SAR Measurement Set-up Diagram

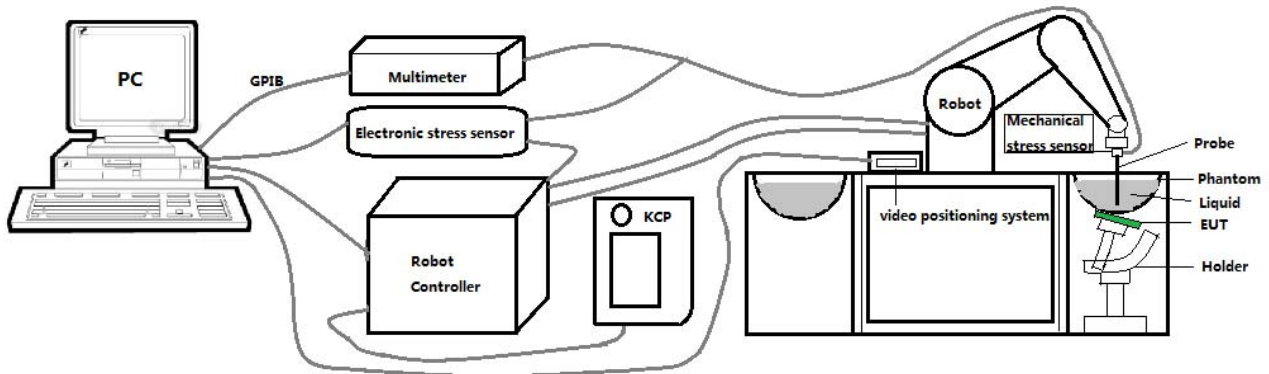

These measurements were performed with the automated near-field scanning system OPENSAR from SATIMO. The system is based on a high precision robot (working range: 901 mm), which positions the probes with a positional repeatability of better than  $\pm 0.03$  mm. The SAR measurements were conducted with dosimetric probe (manufactured by SATIMO), designed in the classical triangular configuration and optimized for dosimetric evaluation.

The first step of the field measurement is the evaluation of the voltages induced on the probe by the device under test. Probe diode detectors are nonlinear. Below the diode compression point, the output voltage is proportional to the square of the applied E-field; above the diode compression point, it is linear to the applied E-field. The compression point depends on the diode, and a calibration procedure is necessary for each sensor of the probe.

The Keithley multimeter reads the voltage of each sensor and send these three values to the PC. The corresponding E field value is calculated using the probe calibration factors, which are stored in the working directory. This evaluation includes linearization of the diode characteristics. The field calculation is done separately for each sensor. Each component of the E field is displayed on the "Dipole Area Scan Interface" and the total E field is displayed on the "3D Interface"

## 2.2. Robot

The SATIMO SAR system uses the high precision robots from KUKA. For the 6-axis controller system, the robot controller version (KUKA) from KUKA is used. The KUKA robot series have many features that are important for our application:



- High precision (repeatability  $\pm 0.03$  mm)
- High reliability (industrial design)
- Jerk-free straight movements
- Low ELF interference (the closed metallic construction shields against motor control fields)

### 2.3. E-Field Probe

This E-field detection probe is composed of three orthogonal dipoles linked to special Schottky diodes with low detection thresholds. The probe allows the measurement of electric fields in liquids such as the one defined in the IEEE and CENELEC standards.

For the measurements the Specific Dosimetric E-Field Probe SN 08/16 EPGO287 with following specifications is used



- Dynamic range: 0.01-100 W/kg
  - Tip Diameter : 2.5 mm
  - Distance between probe tip and sensor center: 1 mm
  - Distance between sensor center and the inner phantom surface: 4 mm (repeatability better than  $\pm 1$  mm).
  - Probe linearity:  $\pm 0.08$  dB
  - Axial isotropy:  $< 0.25$  dB
  - Hemispherical Isotropy:  $< 0.50$  dB
  - Calibration range: 450MHz to 6000MHz for head & body simulating liquid.
  - Lower detection limit: 8mW/kg
- Angle between probe axis (evaluation axis) and surface normal line: less than  $30^\circ$ .

#### 2.3.1. E-Field Probe Calibration

Each probe needs to be calibrated according to a dosimetric assessment procedure with accuracy better than  $\pm 10\%$ . The spherical isotropy shall be evaluated and within  $\pm 0.25$ dB. The sensitivity parameters (Norm X, Norm Y, and Norm Z), the diode compression parameter (DCP) and the conversion factor (Conv F) of the probe are tested. The calibration data can be referred to appendix D of this report.

## 2.4. SAM phantoms

Photo of SAM phantom SN 16/15 SAM119



The SAM phantom is used to measure the SAR relative to people exposed to electro-magnetic field radiated by mobile phones.

2.4.1. Technical Data

Serial Number	Shell thickness	Filling volume	Dimensions	Positionner Material	Permittivity	Loss Tangent
SN 16/15 SAM119	2 mm ±0.2 mm	27 liters	Length:1000 mm Width:500 mm Height:200 mm	Gelcoat with fiberglass	3.4	0.02

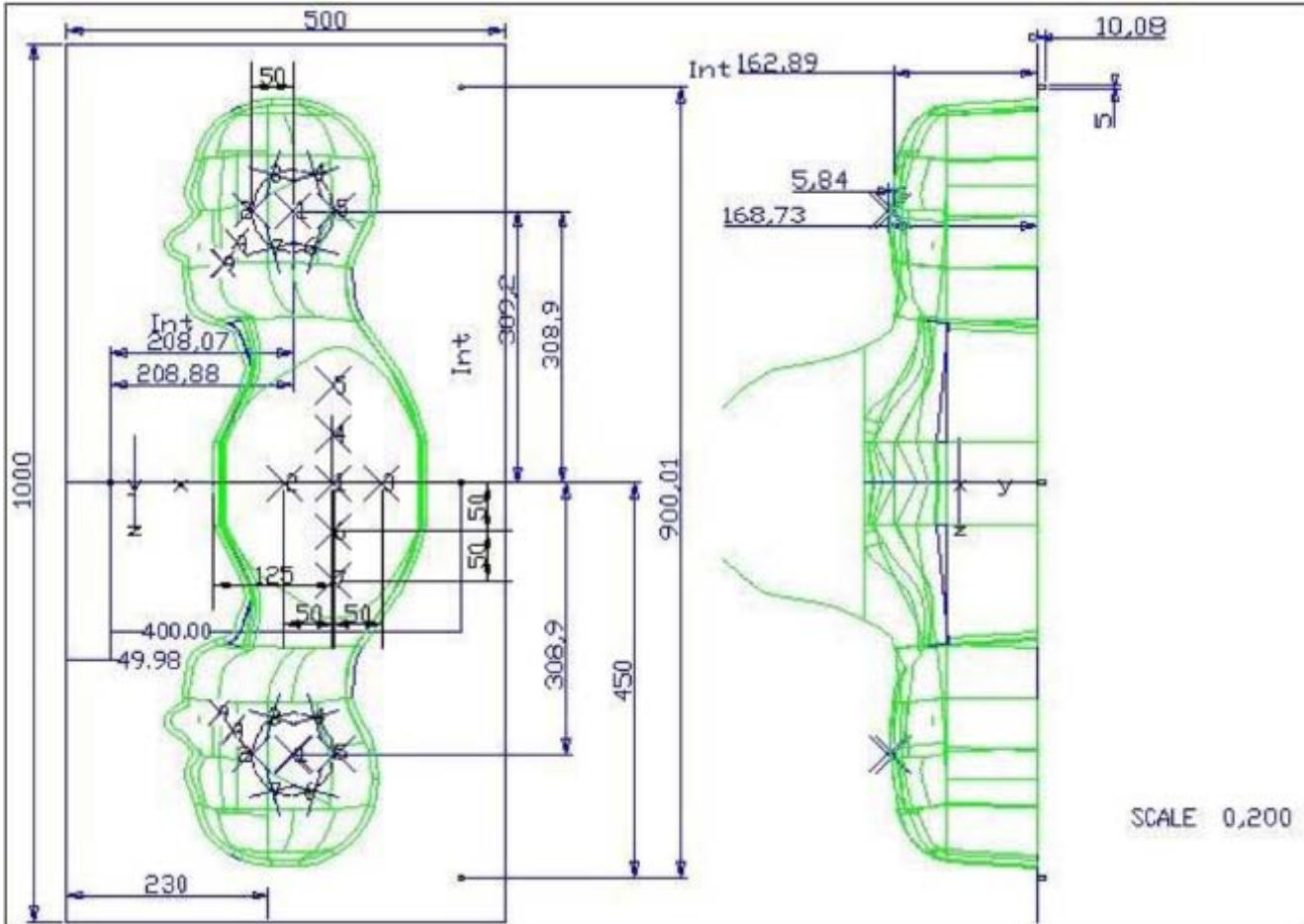

Serial Number	Left Head		Right Head		Flat Part	
	1	2	1	2	1	2
SN 16/15 SAM119	2	2.02	2	2.08	1	2.09
	3	2.05	3	2.06	2	2.06
	4	2.07	4	2.07	3	2.08
	5	2.08	5	2.08	4	2.10
	6	2.05	6	2.07	5	2.10
	7	2.05	7	2.05	6	2.07
	8	2.07	8	2.06	7	2.07
	9	2.08	9	2.06	-	-

The test, based on ultrasonic system, allows measuring the thickness with an accuracy of 10 µm.

**2.5. Device Holder**

The positioning system allows obtaining cheek and tilting position with a very good accuracy. In compliance with CENELEC, the tilt angle uncertainty is lower than 1 degree.

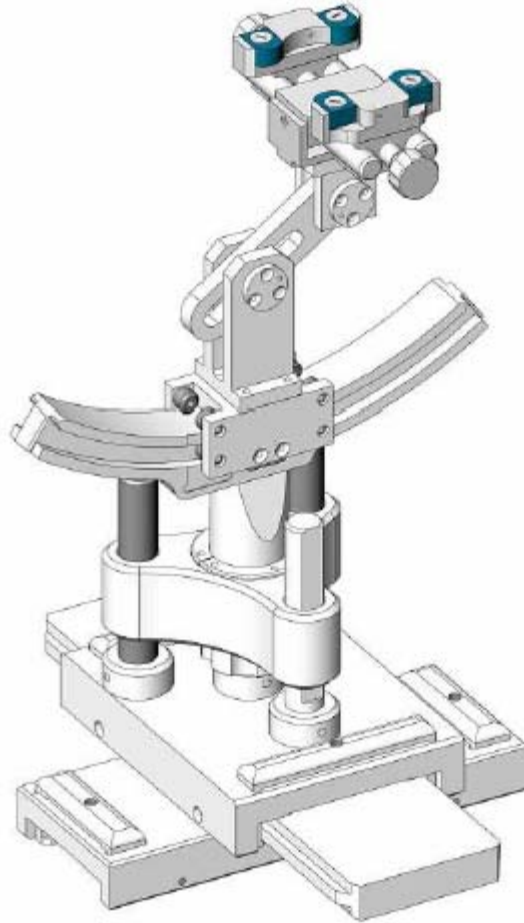

Serial Number	Holder Material	Permittivity	Loss Tangent
SN 16/15 MSH100	Delrin	3.7	0.005

## 2.6. Test Equipment List

This table gives a complete overview of the SAR measurement equipment.

Devices used during the test described are marked

	Manufacturer	Name of Equipment	Type/Model	Serial Number	Calibration	
					Last Cal.	Due Date
<input checked="" type="checkbox"/>	MVG	E FIELD PROBE	SSE2	SN 08/16 EPGO287	Sep. 08, 2016	Sep. 07, 2017
<input type="checkbox"/>	MVG	450 MHz Dipole	SID450	SN 03/15 DIP 0G450-345	Apr. 06, 2015	Apr. 05, 2018
<input type="checkbox"/>	MVG	750 MHz Dipole	SID750	SN 03/15 DIP 0G750-355	Apr. 06, 2015	Apr. 05, 2018
<input type="checkbox"/>	MVG	835 MHz Dipole	SID835	SN 03/15 DIP 0G835-347	Apr. 06, 2015	Apr. 05, 2018
<input type="checkbox"/>	MVG	900 MHz Dipole	SID900	SN 03/15 DIP 0G900-348	Apr. 06, 2015	Apr. 05, 2018
<input type="checkbox"/>	MVG	1800 MHz Dipole	SID1800	SN 03/15 DIP 1G800-349	Apr. 06, 2015	Apr. 05, 2018
<input type="checkbox"/>	MVG	1900 MHz Dipole	SID1900	SN 03/15 DIP 1G900-350	Apr. 06, 2015	Apr. 05, 2018
<input type="checkbox"/>	MVG	2000 MHz Dipole	SID2000	SN 03/15 DIP 2G000-351	Apr. 06, 2015	Apr. 05, 2018
<input checked="" type="checkbox"/>	MVG	2450 MHz Dipole	SID2450	SN 03/15 DIP 2G450-352	Apr. 06, 2015	Apr. 05, 2018
<input type="checkbox"/>	MVG	2600 MHz Dipole	SID2600	SN 03/15 DIP 2G600-356	Apr. 06, 2015	Apr. 05, 2018
<input checked="" type="checkbox"/>	MVG	5000 MHz Dipole	SWG5500	SN 13/14 WGA 33	Apr. 06, 2015	Apr. 05, 2018
<input checked="" type="checkbox"/>	MVG	Liquid measurement Kit	SCLMP	SN 21/15 OCPG 72	NCR	NCR
<input checked="" type="checkbox"/>	MVG	Power Amplifier	N.A	AMPLISAR_28/14_003	NCR	NCR
<input checked="" type="checkbox"/>	KEITHLEY	Millivoltmeter	2000	4072790	NCR	NCR
<input type="checkbox"/>	R&S	Universal radio communication tester	CMU200	117858	Aug. 07, 2017	Aug. 06, 2018
<input type="checkbox"/>	R&S	Wideband radio communication tester	CMW500	103917	Oct. 29, 2016	Oct. 28, 2017
<input checked="" type="checkbox"/>	HP	Network Analyzer	8753D	3410J01136	Aug. 07, 2017	Aug. 06, 2018



<input checked="" type="checkbox"/>	Agilent	PSG Analog Signal Generator	E8257D	MY51110112	Aug. 07, 2017	Aug. 06, 2018
<input checked="" type="checkbox"/>	Agilent	Power meter	E4419B	MY45102538	Aug. 07, 2017	Aug. 06, 2018
<input checked="" type="checkbox"/>	Agilent	Power sensor	E9301A	MY41495644	Aug. 07, 2017	Aug. 06, 2018
<input checked="" type="checkbox"/>	Agilent	Power sensor	E9301A	US39212148	Aug. 07, 2017	Aug. 06, 2018
<input checked="" type="checkbox"/>	MCLI/USA	Directional Coupler	CB11-20	0D2L51502	Aug. 07, 2017	Aug. 06, 2018

### 3. SAR Measurement Procedures

The measurement procedures are as follows:

<Conducted power measurement>

- (a) For WWAN power measurement, use base station simulator to configure EUT WWAN transmission in conducted connection with RF cable, at maximum power in each supported wireless interface and frequency band.
- (b) Read the WWAN RF power level from the base station simulator.
- (c) For WLAN/BT power measurement, use engineering software to configure EUT WLAN/BT continuously transmission, at maximum RF power in each supported wireless interface and frequency band.
- (d) Connect EUT RF port through RF cable to the power meter, and measure WLAN/BT output power.

<SAR measurement>

- (a) Use base station simulator to configure EUT WWAN transmission in radiated connection, and engineering software to configure EUT WLAN/BT continuously transmission, at maximum RF power, in the highest power channel.
- (b) Place the EUT in the positions as Appendix A demonstrates.
- (c) Set scan area, grid size and other setting on the OPENSAR software.
- (d) Measure SAR results for the highest power channel on each testing position.
- (e) Find out the largest SAR result on these testing positions of each band.
- (f) Measure SAR results for other channels in worst SAR testing position if the reported SAR of highest power channel is larger than 0.8 W/kg.

According to the test standard, the recommended procedure for assessing the peak spatial-average SAR value consists of the following steps:

- (a) Power reference measurement
- (b) Area scan
- (c) Zoom scan
- (d) Power drift measurement

#### 3.1. Power Reference

The Power Reference Measurement and Power Drift Measurements are for monitoring the power drift of the device under test in the batch process. The minimum distance of probe sensors to surface determines the closest measurement point to phantom surface. This distance cannot be smaller than the distance of sensor calibration points to probe tip as defined in the probe properties.

#### 3.2. Area scan & Zoom scan

The area scan is a 2D scan to find the hot spot location on the DUT. The zoom scan is a 3D scan above the hot spot to calculate the 1g and 10g SAR value.

Measurement of the SAR distribution with a grid of 8 to 16 mm \* 8 to 16 mm and a constant distance to the inner surface of the phantom. Since the sensors cannot directly measure at the inner phantom surface, the

values between the sensors and the inner phantom surface are extrapolated. With these values the area of the maximum SAR is calculated by an interpolation scheme. Around this point, a cube of 30 \* 30 \* 30 mm or 32 \* 32 \* 32 mm is assessed by measuring 5 or 8 \* 5 or 8 \* 4 or 5 mm. With these data, the peak spatial-average SAR value can be calculated.

From the scanned SAR distribution, identify the position of the maximum SAR value, in addition identify the positions of any local maxima with SAR values within 2 dB of the maximum value that will not be within the zoom scan of other peaks; additional peaks shall be measured only when the primary peak is within 2 dB of the SAR compliance limit (e.g., 1 W/kg for 1,6 W/kg 1 g limit, or 1,26 W/kg for 2 W/kg, 10 g limit).

Area scan & Zoom scan scan parameters extracted from FCC KDB 865664 D01 SAR measurement 100 MHz to 6 GHz.

		≤ 3 GHz	> 3 GHz
Maximum distance from closest measurement point (geometric center of probe sensors) to phantom surface		5 ± 1 mm	$\frac{1}{2} \cdot \delta \cdot \ln(2) \pm 0.5$ mm
Maximum probe angle from probe axis to phantom surface normal at the measurement location		30° ± 1°	20° ± 1°
Maximum area scan spatial resolution: $\Delta x_{Area}$ , $\Delta y_{Area}$		≤ 2 GHz: ≤ 15 mm 2 – 3 GHz: ≤ 12 mm	3 – 4 GHz: ≤ 12 mm 4 – 6 GHz: ≤ 10 mm
		When the x or y dimension of the test device, in the measurement plane orientation, is smaller than the above, the measurement resolution must be ≤ the corresponding x or y dimension of the test device with at least one measurement point on the test device.	
Maximum zoom scan spatial resolution: $\Delta x_{Zoom}$ , $\Delta y_{Zoom}$		≤ 2 GHz: ≤ 8 mm 2 – 3 GHz: ≤ 5 mm *	3 – 4 GHz: ≤ 5 mm * 4 – 6 GHz: ≤ 4 mm *
Maximum zoom scan spatial resolution, normal to phantom surface	uniform grid: $\Delta z_{Zoom}(n)$	≤ 5 mm	3 – 4 GHz: ≤ 4 mm 4 – 5 GHz: ≤ 3 mm 5 – 6 GHz: ≤ 2 mm
	graded grid	$\Delta z_{Zoom}(1)$ : between 1 <sup>st</sup> two points closest to phantom surface	≤ 4 mm  3 – 4 GHz: ≤ 3 mm 4 – 5 GHz: ≤ 2.5 mm 5 – 6 GHz: ≤ 2 mm
		$\Delta z_{Zoom}(n>1)$ : between subsequent points	≤ 1.5 · $\Delta z_{Zoom}(n-1)$
Minimum zoom scan volume	x, y, z	≥ 30 mm	3 – 4 GHz: ≥ 28 mm 4 – 5 GHz: ≥ 25 mm 5 – 6 GHz: ≥ 22 mm

Note:  $\delta$  is the penetration depth of a plane-wave at normal incidence to the tissue medium; see draft standard IEEE P1528-2011 for details.

\* When zoom scan is required and the *reported* SAR from the *area scan based 1-g SAR estimation* procedures of KDB 447498 is ≤ 1.4 W/kg, ≤ 8 mm, ≤ 7 mm and ≤ 5 mm zoom scan resolution may be applied, respectively, for 2 GHz to 3 GHz, 3 GHz to 4 GHz and 4 GHz to 6 GHz.

### **3.3. Description of interpolation/extrapolation scheme**

The local SAR inside the phantom is measured using small dipole sensing elements inside a probe body. The probe tip must not be in contact with the phantom surface in order to minimise measurements errors, but the highest local SAR will occur at the surface of the phantom.

An extrapolation is using to determinate this highest local SAR values. The extrapolation is based on a fourth-order least-square polynomial fit of measured data. The local SAR value is then extrapolated from the liquid surface with a 1 mm step.

The measurements have to be performed over a limited time (due to the duration of the battery) so the step of measurement is high. It could vary between 5 and 8 mm. To obtain an accurate assessment of the maximum SAR averaged over 10 grams and 1 gram requires a very fine resolution in the three dimensional scanned data array.

### **3.4. Volumetric Scan**

The volumetric scan consists to a full 3D scan over a specific area. This 3D scan is useful form multi Tx SAR measurement. Indeed, it is possible with OpenSAR to add, point by point, several volumetric scan to calculate the SAR value of the combined measurement as it is define in the standard IEEE1528 and IEC62209.

### **3.5. Power Drift**

All SAR testing is under the EUT install full charged battery and transmit maximum output power. In OpenSAR measurement software, the power reference measurement and power drift measurement procedures are used for monitoring the power drift of EUT during SAR test. Both these procedures measure the field at a specified reference position before and after the SAR testing. The software will calculate the field difference in V/m. If the power drifts more than  $\pm 5\%$ , the SAR will be retested.

## 4. System Verification Procedure

### 4.1. Tissue Verification

The following tissue formulations are provided for reference only as some of the parameters have not been thoroughly verified. The composition of ingredients may be modified accordingly to achieve the desired target tissue parameters required for routine SAR evaluation.

<b>Ingredients</b> (% of weight)	<b>Head Tissue</b>							
Frequency Band (MHz)	750	835	900	1800	1900	2000	2450	2600
Water	34.40	34.40	34.40	55.36	55.36	57.87	57.87	57.87
NaCl	0.79	0.79	0.79	0.35	0.35	0.16	0.16	0.16
1,2-Propanediol	64.81	64.81	64.81	0.00	0.00	0.00	0.00	0.00
Triton X-100	0.00	0.00	0.00	30.45	30.45	19.97	19.97	19.97
DGBE	0.00	0.00	0.00	13.84	13.84	22.00	22.00	22.00
<b>Ingredients</b> (% of weight)	<b>Body Tissue</b>							
Frequency Band (MHz)	750	835	900	1800	1900	2000	2450	2600
Water	50.30	50.30	50.30	69.91	69.91	71.88	71.88	71.88
NaCl	0.60	0.60	0.60	0.13	0.13	0.16	0.16	0.16
1,2-Propanediol	49.10	49.10	49.10	0.00	0.00	0.00	0.00	0.00
Triton X-100	0.00	0.00	0.00	9.99	9.99	19.97	19.97	19.97
DGBE	0.00	0.00	0.00	19.97	19.97	7.99	7.99	7.99

#### 4.1.1. Tissue Dielectric Parameter Check Results

The simulating liquids should be checked at the beginning of a series of SAR measurements to determine if the dielectric parameters are within the tolerances of the specified target values. The measured conductivity and relative permittivity should be within  $\pm 5\%$  of the target values.

Tissue Type	Measured Frequency (MHz)	Target Tissue		Measured Tissue		Liquid Temp.	Test Date
		$\epsilon_r$ ( $\pm 5\%$ )	$\sigma$ (S/m) ( $\pm 5\%$ )	$\epsilon_r$	$\sigma$ (S/m)		
Body 2450	2450	52.70 (50.07~55.33)	1.95 (1.85~2.04)	52.80	1.97	21.5 °C	Aug. 12, 2017
Body 5000	5200	49.00 (44.10~53.90)	5.30 (4.77~5.83)	49.59	5.29	21.6 °C	Aug. 14, 2017
Body 5000	5800	48.20 (43.38~53.02)	6.00 (5.40~6.60)	48.48	6.03	21.4 °C	Aug. 15, 2017

NOTE: The dielectric parameters of the tissue-equivalent liquid should be measured under similar ambient conditions and within 2 °C of the conditions expected during the SAR evaluation to satisfy protocol requirements.

## 4.2. System Verification Procedure

The system verification is performed for verifying the accuracy of the complete measurement system and performance of the software. The dipole is connected to the signal source consisting of signal generator and amplifier via a directional coupler, N-connector cable and adaption to SMA. It is fed with a power of 100mW (below 5GHz) or 100mW (above 5GHz). To adjust this power a power meter is used. The power sensor is connected to the cable before the system verification to measure the power at this point and do adjustments at the signal generator. At the outputs of the directional coupler both return loss as well as forward power are controlled during the system verification to make sure that emitted power at the dipole is kept constant. This can also be checked by the power drift measurement after the test (result on plot).

The system verification is shown as below picture:

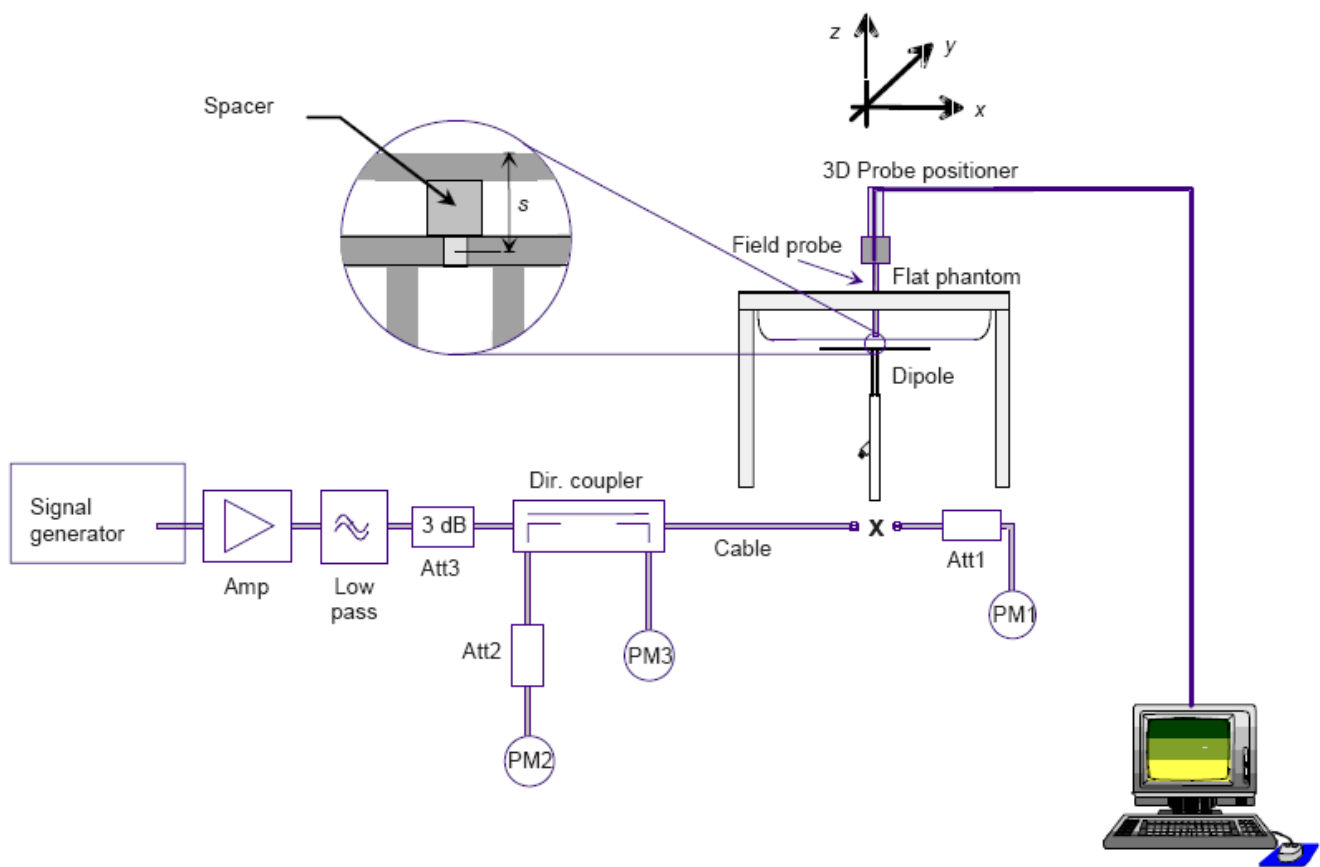

#### 4.2.1. System Verification Results

Comparing to the original SAR value provided by SATIMO, the verification data should be within its specification of  $\pm 10\%$ . Below table shows the target SAR and measured SAR after normalized to 1W input power. The table below indicates the system performance verification can meet the variation criterion and the plots can be referred to Appendix B of this report.

System Verification	Target SAR (1W) ( $\pm 10\%$ )		Measured SAR (Normalized to 1W)		Liquid Temp.	Test Date
	1-g (W/Kg)	10-g (W/Kg)	1-g (W/Kg)	10-g (W/Kg)		
2450MHz Body	49.32 (44.39~54.25)	22.89 (20.60~25.17)	47.51	22.01	21.5 °C	Aug. 12, 2017
5200MHz Body	150.06 (135.05~165.07)	53.20 (47.88~58.52)	146.98	51.67	21.6 °C	Aug. 14, 2017
5800MHz Body	173.64 (156.28~191.00)	59.29 (53.36~65.22)	165.77	56.79	21.4 °C	Aug. 15, 2017



## 5. SAR Measurement variability and uncertainty

### 5.1. SAR measurement variability

Per KDB865664 D01 SAR measurement 100 MHz to 6 GHz, SAR measurement variability must be assessed for each frequency band, which is determined by the SAR probe calibration point and tissue-equivalent medium used for the device measurements. The additional measurements are repeated after the completion of all measurements requiring the same head or body tissue-equivalent medium in a frequency band. The test device should be returned to ambient conditions (normal room temperature) with the battery fully charged before it is re-mounted on the device holder for the repeated measurement(s) to minimize any unexpected variations in the repeated results.

- 1) Repeated measurement is not required when the original highest measured SAR is  $< 0.80$  W/kg; steps 2) through 4) do not apply.
- 2) When the original highest measured SAR is  $\geq 0.80$  W/kg, repeat that measurement once.
- 3) Perform a second repeated measurement only if the ratio of largest to smallest SAR for the original and first repeated measurements is  $> 1.20$  or when the original or repeated measurement is  $\geq 1.45$  W/kg (~ 10% from the 1-g SAR limit).
- 4) Perform a third repeated measurement only if the original, first or second repeated measurement is  $\geq 1.5$  W/kg and the ratio of largest to smallest SAR for the original, first and second repeated measurements is  $> 1.20$ .

### 5.2. SAR measurement uncertainty

Per KDB865664 D01 SAR Measurement 100 MHz to 6 GHz, when the highest measured 1-g SAR within a frequency band is  $< 1.5$  W/kg, the extensive SAR measurement uncertainty analysis described in IEEE Std 1528-2013 is not required in SAR reports submitted for equipment approval. The equivalent ratio (1.5/1.6) is applied to extremity and occupational exposure conditions.

## 6. RF Exposure Positions

### 6.1. Tablet host platform exposure conditions

Per KDB616217 D04, When the modular approach is used, transmitters and modules must be initially tested for standalone operations in generic host conditions according to the following minimum test separation distance and antenna installation requirements for incorporation in the tablet platform. The separation distance required for incorporation in qualified hosts is described in KDB 447498; item 5) of section 4.1 and item 1) of section 5.2.2 etc.

- $\leq 5$  mm between the antenna and user for both back surface and edge exposure conditions
- the antennas used by the host must have been tested for equipment approval or qualify for SAR test exclusion
- the antenna polarization, physical orientation, rotation and installation configurations used by the host must have been tested for compliance or qualify for test exclusion
- when the *SAR Test Exclusion Threshold* in KDB 447498 applies, a *test separation distance* of 5 mm is required to determine test exclusion for the tablet platform

The antennas embedded in tablets are typically  $\leq 5$ mm from the outer housing. The required antenna to user test separation distance is a “not to exceed test” distance required to apply the modular approach. Instead of the typical zero gap tablet edge test requirement between the edge of a tablet and the user, when an antenna has been tested at  $\leq 5$  mm according to the modular approach it can be incorporated into tablets with at least twice the tested distance from the outer housing of the tablet edge; otherwise, the tablet edge zero gap test requirement applies. When the dedicated host approach is applied, the back surface and edges of the tablet should be tested for SAR compliance with the tablet touching the phantom.

## 7. RF Output Power

### 7.1. Maximum Tune-up Limit

Band	Mode		The Tune-up Maximum Power (Customer Declared)(dBm)	Range	Measured Output Maximum Power(dBm)	
					ANT A	ANT B
WLAN 2.4G	802.11b		13±1	12~14	13.50	13.70
	802.11g		9±1	8~10	9.40	9.30
	802.11n(HT20)		9±1	8~10	9.40	9.80
	802.11n(HT40)		9±1	8~10	8.60	8.50
WLAN 5.2G	802.11a		9±1	8~10	9.80	9.90
	802.11n (HT20)		9±1	8~10	8.50	8.40
	802.11n (HT40)		9±1	8~10	8.50	8.60
	802.11ac (VHT20)		9±1	8~10	8.40	8.20
	802.11ac (VHT40)		9±1	8~10	8.20	8.30
	802.11ac (VHT80)		8±1	7~9	7.90	8.10
WLAN 5.8G	802.11a		9±1	8~10	9.90	9.90
	802.11n (HT20)		9±1	8~10	8.30	8.30
	802.11n (HT40)		9±1	8~10	8.30	8.50
	802.11ac (VHT20)		9±1	8~10	8.30	8.20
	802.11ac (VHT40)		9±1	8~10	8.20	8.50
	802.11ac (VHT80)		8±1	7~9	7.80	8.20
Bluetooth	BDR+EDR	1M	0CH	3±1	2~4	2.22
			39CH	3±1	2~4	3.03
			78CH	3±1	2~4	2.62
		2M	0CH	-2±1	-3~-1	-2.33
			39CH	-2±1	-3~-1	-1.38
			78CH	-2±1	-3~-1	-1.66
		3M	0CH	-2±1	-3~-1	-2.18
			39CH	-2±1	-3~-1	-1.25
			78CH	-1±1	-2~0	-0.27
	BLE		1±1	0~2	1.37	

## 7.2. WLAN & BT Output Power

### 7.2.1. Output Power Results Of WLAN

The output power of WLAN is as following:

Mode	Channel	Frequency (MHz)	Tune-up	Output Power (dBm)	
				ANT A	ANT B
802.11b	1	2412	14.00	13.50	13.70
	6	2437	14.00	13.20	13.60
	11	2462	14.00	13.30	13.60
802.11g	1	2412	10.00	9.30	9.30
	6	2437	10.00	9.40	9.20
	11	2462	10.00	9.20	9.20
802.11n(HT20)	1	2412	10.00	9.40	9.80
	6	2437	10.00	9.40	9.70
	11	2462	10.00	9.20	9.70
802.11n(HT40)	3	2422	10.00	8.60	8.50
	6	2437	10.00	8.50	8.20
	9	2452	10.00	8.30	8.10
802.11a	36	5180	10.00	9.80	9.90
	40	5200	10.00	9.70	9.80
	48	5240	10.00	9.60	9.80
802.11n (HT20)	36	5180	10.00	8.50	8.40
	40	5200	10.00	8.40	8.20
	48	5240	10.00	8.30	8.40
802.11n (HT40)	38	5190	10.00	8.50	8.60
	46	5230	10.00	8.30	8.40
802.11ac (VHT20)	36	5180	10.00	8.20	8.00
	40	5200	10.00	8.40	8.20
	48	5240	10.00	8.20	8.10
802.11ac (VHT40)	38	5190	10.00	8.20	8.30
	46	5230	10.00	8.10	8.20
802.11ac (VHT80)	42	5210	9.00	7.90	8.10
802.11a	149	5745	10.00	9.60	9.80
	157	5785	10.00	9.80	9.90
	165	5825	10.00	9.90	9.80
802.11n (HT20)	149	5745	10.00	8.20	8.20
	157	5785	10.00	8.20	8.30
	165	5825	10.00	8.30	8.20
802.11n (HT40)	151	5755	10.00	8.30	8.50
	159	5795	10.00	8.20	8.40

802.11ac (VHT20)	149	5745	10.00	8.20	8.20
	157	5785	10.00	8.30	8.10
	165	5825	10.00	8.30	8.20
802.11ac (VHT40)	151	5755	10.00	8.20	8.20
	159	5795	10.00	8.10	8.50
802.11ac (VHT80)	155	5775	9.00	7.80	8.20

**7.2.2. Output Power Results Of Bluetooth**

The output power of Bluetooth is as following:

	Data Rates	Channel	Tune-up	Output Power (dBm)
	BDR+EDR	1M	0	4.00
39			4.00	3.03
78			4.00	2.62
2M		0	-1.00	-2.33
		39	-1.00	-1.38
		78	-1.00	-1.66
3M		0	-1.00	-2.18
		39	-1.00	-1.25
		78	0.00	-0.27

BLE	Channel	Tune-up	Output Power (dBm)
	0	2.00	0.77
	19	2.00	1.37
	39	2.00	1.05

### 8. Antenna Location

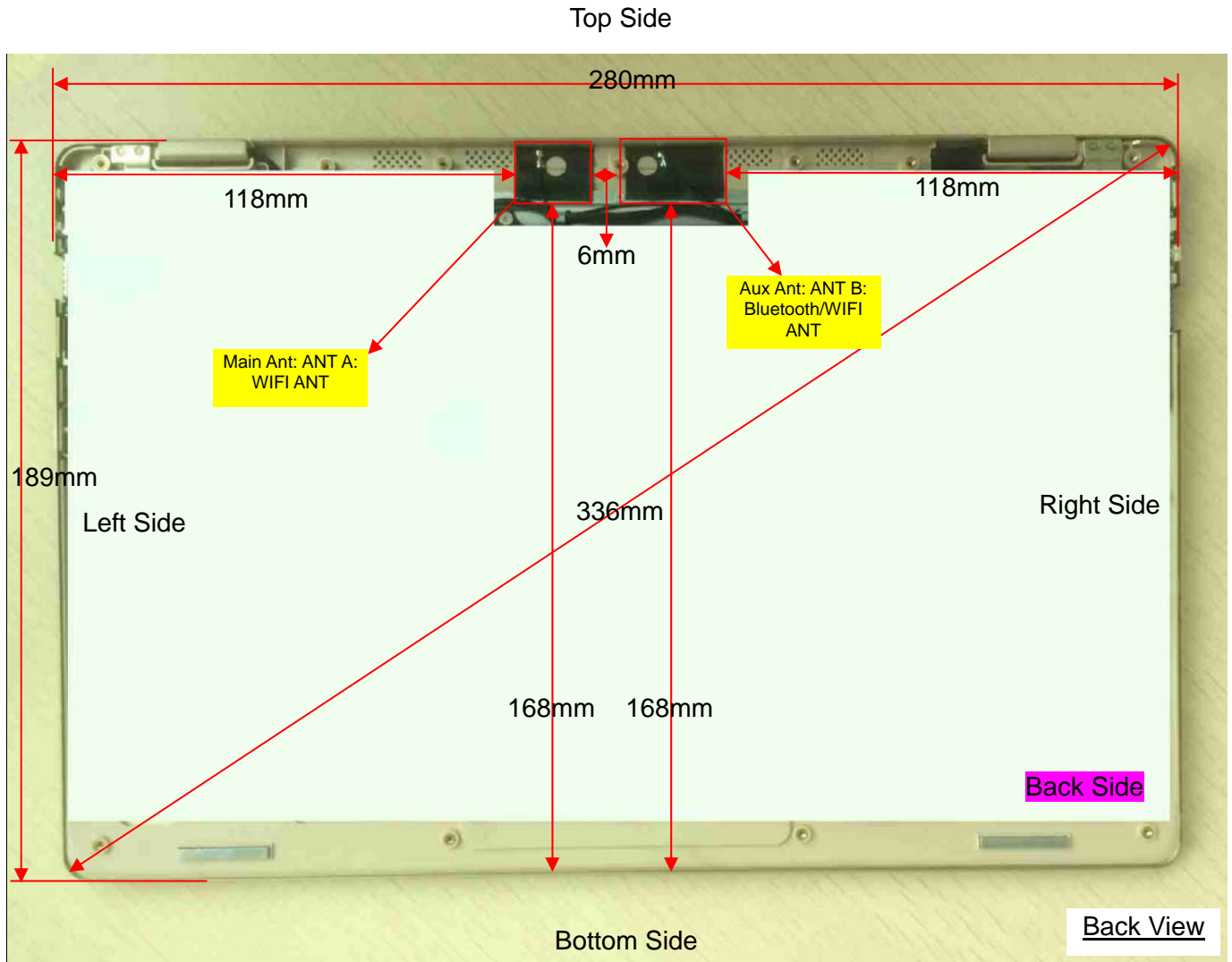

Distance of the Antenna to the EUT surface/edge						
Antennas	Key Side	Back Side	Left Side	Right Side	Top Side	Bottom Side
Ant A	1mm	5mm	118mm	143mm	2mm	168mm
Ant B	1mm	5mm	143mm	118mm	2mm	168mm

Ant A: Positions for SAR tests

Test separation distances  $\leq$  50 mm

Exposure Positions	Tune-up Maximum power of WLAN 2.4G	
	14dBm	
Key Side	Antenna to user(mm)	1
	SAR exclusion threshold	7.883
	SAR testing required?	<b>YES</b>
Back Side	Antenna to user(mm)	5
	SAR exclusion threshold	7.883
	SAR testing required?	<b>YES</b>
Top Side	Antenna to user(mm)	2
	SAR exclusion threshold	7.883
	SAR testing required?	<b>YES</b>
Exposure Positions	Tune-up Maximum power of WLAN 5.2G	
	10dBm	
Key Side	Antenna to user(mm)	1
	SAR exclusion threshold	4.578
	SAR testing required?	<b>YES</b>
Back Side	Antenna to user(mm)	5
	SAR exclusion threshold	4.578
	SAR testing required?	<b>YES</b>
Top Side	Antenna to user(mm)	2
	SAR exclusion threshold	4.578
	SAR testing required?	<b>YES</b>
Exposure Positions	Tune-up Maximum power of WLAN 5.8G	
	10dBm	
Key Side	Antenna to user(mm)	1
	SAR exclusion threshold	4.827
	SAR testing required?	<b>YES</b>
Back Side	Antenna to user(mm)	5
	SAR exclusion threshold	4.827
	SAR testing required?	<b>YES</b>
Top Side	Antenna to user(mm)	2
	SAR exclusion threshold	4.827
	SAR testing required?	<b>YES</b>

NOTE: Refer to section 4.3.1 of KDB 447498 D01.

Ant A: Positions for SAR tests

Test separation distances > 50 mm

Exposure Positions	Tune-up Maximum power of WLAN 2.4G	
	14dBm	25.12mW
Left Side	Antenna to user(mm)	118
	SAR exclusion threshold(mW)	776
	SAR testing required?	<b>NO</b>
Right Side	Antenna to user(mm)	143
	SAR exclusion threshold(mW)	1026
	SAR testing required?	<b>NO</b>
Bottom Side	Antenna to user(mm)	168
	SAR exclusion threshold(mW)	1276
	SAR testing required?	<b>NO</b>
Exposure Positions	Tune-up Maximum power of WLAN 5.2G	
	10dBm	10mW
Left Side	Antenna to user(mm)	118
	SAR exclusion threshold(mW)	746
	SAR testing required?	<b>NO</b>
Right Side	Antenna to user(mm)	143
	SAR exclusion threshold(mW)	996
	SAR testing required?	<b>NO</b>
Bottom Side	Antenna to user(mm)	168
	SAR exclusion threshold(mW)	1246
	SAR testing required?	<b>NO</b>
Exposure Positions	Tune-up Maximum power of WLAN 5.8G	
	10dBm	10mW
Left Side	Antenna to user(mm)	118
	SAR exclusion threshold(mW)	742
	SAR testing required?	<b>NO</b>
Right Side	Antenna to user(mm)	143
	SAR exclusion threshold(mW)	992
	SAR testing required?	<b>NO</b>
Bottom Side	Antenna to user(mm)	168
	SAR exclusion threshold(mW)	1242
	SAR testing required?	<b>NO</b>

NOTE: Refer to section 4.3.1 of KDB 447498 D01.



Ant B: Positions for SAR tests

Test separation distances  $\leq$  50 mm

Exposure Positions	Tune-up Maximum power of WLAN 2.4G	
	14dBm	
Key Side	Antenna to user(mm)	1
	SAR exclusion threshold	7.883
	SAR testing required?	<b>YES</b>
Back Side	Antenna to user(mm)	5
	SAR exclusion threshold	7.883
	SAR testing required?	<b>YES</b>
Top Side	Antenna to user(mm)	2
	SAR exclusion threshold	7.883
	SAR testing required?	<b>YES</b>
Exposure Positions	Tune-up Maximum power of WLAN 5.2G	
	10dBm	
Key Side	Antenna to user(mm)	1
	SAR exclusion threshold	4.578
	SAR testing required?	<b>YES</b>
Back Side	Antenna to user(mm)	5
	SAR exclusion threshold	4.578
	SAR testing required?	<b>YES</b>
Top Side	Antenna to user(mm)	2
	SAR exclusion threshold	4.578
	SAR testing required?	<b>YES</b>
Exposure Positions	Tune-up Maximum power of WLAN 5.8G	
	10dBm	
Key Side	Antenna to user(mm)	1
	SAR exclusion threshold	4.827
	SAR testing required?	<b>YES</b>
Back Side	Antenna to user(mm)	5
	SAR exclusion threshold	4.827
	SAR testing required?	<b>YES</b>
Top Side	Antenna to user(mm)	2
	SAR exclusion threshold	4.827
	SAR testing required?	<b>YES</b>

NOTE: Refer to section 4.3.1 of KDB 447498 D01.

Ant B: Positions for SAR tests

Test separation distances > 50 mm

Exposure Positions	Tune-up Maximum power of WLAN 2.4G	
	14dBm	25.12mW
Left Side	Antenna to user(mm)	143
	SAR exclusion threshold(mW)	1026
	SAR testing required?	<b>NO</b>
Right Side	Antenna to user(mm)	118
	SAR exclusion threshold(mW)	776
	SAR testing required?	<b>NO</b>
Bottom Side	Antenna to user(mm)	168
	SAR exclusion threshold(mW)	1276
	SAR testing required?	<b>NO</b>
Exposure Positions	Tune-up Maximum power of WLAN 5.2G	
	10dBm	10mW
Left Side	Antenna to user(mm)	143
	SAR exclusion threshold(mW)	996
	SAR testing required?	<b>NO</b>
Right Side	Antenna to user(mm)	118
	SAR exclusion threshold(mW)	746
	SAR testing required?	<b>NO</b>
Bottom Side	Antenna to user(mm)	168
	SAR exclusion threshold(mW)	1246
	SAR testing required?	<b>NO</b>
Exposure Positions	Tune-up Maximum power of WLAN 5.8G	
	10dBm	10mW
Left Side	Antenna to user(mm)	143
	SAR exclusion threshold(mW)	992
	SAR testing required?	<b>NO</b>
Right Side	Antenna to user(mm)	118
	SAR exclusion threshold(mW)	742
	SAR testing required?	<b>NO</b>
Bottom Side	Antenna to user(mm)	168
	SAR exclusion threshold(mW)	1242
	SAR testing required?	<b>NO</b>

NOTE: Refer to section 4.3.1 of KDB 447498 D01.

### 9. Standalone SAR test exclusion and Simultaneous transmission SAR estimated

Refer to FCC KDB 447498D01 Appendix A, the 1-g SAR and 10-g SAR test exclusion thresholds for 100 MHz to 6 GHz at test separation distances  $\leq 50$  mm are determined by:

$[(\text{max. power of channel, including tune-up tolerance, mW})/(\text{min. test separation distance, mm})] \cdot [\sqrt{f_{(\text{GHZ})}}] \leq 3.0$  for 1-g SAR and  $\leq 7.5$  for 10-g extremity SAR, where:

- $f_{(\text{GHZ})}$  is the RF channel transmit frequency in GHz
- Power and distance are rounded to the nearest mW and mm before calculation
- The result is rounded to one decimal place for comparison

When the minimum test separation distance is  $< 5$  mm, a distance of 5 mm is applied to determine SAR test exclusion.

Mode	$P_{\text{max}}$ (dBm)	$P_{\text{max}}$ (mW)	Distance (mm)	1-g SAR Test Exclusion Threshold (mW)	SAR test exclusion
Bluetooth (BDR)	4	2.51	5	10	Yes

Note: The maximum tune-up tolerance limit of the BDR mode greater than the BLE and EDR mode. So we only estimated the BDR mode based on the maximum tune-up output power. The BLE and EDR mode is represented by the BDR mode estimated results.

When standalone SAR test exclusion applies to an antenna that transmits simultaneously with other antennas, the standalone SAR must be estimated according to following to determine simultaneous transmission SAR test exclusion:

$[(\text{max. power of channel, including tune-up tolerance, mW})/(\text{min. test separation distance, mm})] * [\sqrt{f_{(\text{GHZ})}}/x]$  W/kg for test separation distances  $\leq 50$ mm, where  $x = 7.5$  for 1-g SAR and  $x = 18.75$  for 10-g SAR.

When the minimum test separation distance is  $< 5$  mm, a distance of 5 mm is applied to determine SAR test exclusion.

Mode	Position	$P_{\text{max}}$ (dBm)	$P_{\text{max}}$ (mW)	Distance (mm)	f (GHz)	x	Estimated SAR (W/Kg)
Bluetooth (BDR)	Body	4	2.51	5	2.480	7.5	0.105

Note: The maximum tune-up tolerance limit of the BDR mode greater than the BLE and EDR mode. So we only estimated the BDR mode based on the maximum tune-up output power. The estimated SAR for the BLE and EDR mode is represented by the BDR mode estimated results.

## 10. SAR Results

### 10.1. SAR measurement results

#### 10.1.1. SAR measurement Result of WLAN 2.4G

Test Position of Body with 0mm	Test channel /Freq.	Test Mode	SAR Value (W/kg)		Power Drift (±5%)	Conducted power (dBm)	Tune-up power (dBm)	Scaled SAR 1g (W/Kg)
			1g	10g				
Ant A								
Key Side	1/2412	802.11b	0.685	0.242	-1.16	13.50	14.00	0.769
Back Side	1/2412	802.11b	0.030	0.012	0.00	13.50	14.00	0.034
Top Side	1/2412	802.11b	0.105	0.046	1.15	13.50	14.00	0.118
Ant B								
Key Side	1/2412	802.11b	0.455	0.237	1.41	13.70	14.00	0.488
Back Side	1/2412	802.11b	0.032	0.013	4.03	13.70	14.00	0.034
Top Side	1/2412	802.11b	0.071	0.035	-1.57	13.70	14.00	0.076

#### 10.1.2. SAR measurement Result of WLAN 5.2G

Test Position of Body with 0mm	Test channel /Freq.	Test Mode	SAR Value (W/kg)		Power Drift (±5%)	Conducted power (dBm)	Tune-up power (dBm)	Scaled SAR 1g (W/Kg)
			1g	10g				
Ant A								
Key Side	36/5180	802.11a	0.943	0.216	0.00	9.80	10.00	0.987
Back Side	36/5180	802.11a	0.039	0.017	4.23	9.80	10.00	0.041
Top Side	36/5180	802.11a	0.173	0.052	-1.57	9.80	10.00	0.181
Key Side	40/5200	802.11a	1.263	0.282	2.32	9.70	10.00	1.353
Key Side Repeated	40/5200	802.11a	1.257	0.274	2.21	9.70	10.00	1.347
Key Side	48/5240	802.11a	0.920	0.223	-1.09	9.60	10.00	1.009
Ant B								
Key Side	36/5180	802.11a	1.094	0.221	2.33	9.90	10.00	1.119
Back Side	36/5180	802.11a	0.045	0.021	2.17	9.90	10.00	0.046
Top Side	36/5180	802.11a	0.095	0.031	-1.16	9.90	10.00	0.097
Key Side	40/5200	802.11a	1.205	0.268	2.47	9.80	10.00	1.262
Key Side Repeated	40/5200	802.11a	1.195	0.262	-1.51	9.80	10.00	1.251
Key Side	48/5240	802.11a	1.176	0.270	0.66	9.80	10.00	1.231

**10.1.3. SAR measurement Result of WLAN 5.8G**

Test Position of Body with 0mm	Test channel /Freq.	Test Mode	SAR Value (W/kg)		Power Drift (±5%)	Conducted power (dBm)	Tune-up power (dBm)	Scaled SAR 1g (W/Kg)
			1g	10g				
<b>Ant A</b>								
Key Side	165/5825	802.11a	0.918	0.203	4.20	9.90	10.00	0.939
Key Side Repeated	165/5825	802.11a	0.895	0.201	-1.51	9.90	10.00	0.916
Back Side	165/5825	802.11a	0.048	0.019	1.27	9.90	10.00	0.049
Top Side	165/5825	802.11a	0.087	0.035	2.01	9.90	10.00	0.089
Key Side	149/5745	802.11a	0.800	0.180	4.02	9.60	10.00	0.877
Key Side	157/5785	802.11a	0.860	0.192	3.87	9.80	10.00	0.901
<b>Ant B</b>								
Key Side	157/5785	802.11a	1.420	0.325	0.49	9.90	10.00	1.453
Key Side Repeated	157/5785	802.11a	1.408	0.311	-1.56	9.90	10.00	1.441
Back Side	157/5785	802.11a	0.089	0.032	-3.42	9.90	10.00	0.091
Top Side	157/5785	802.11a	0.131	0.042	-1.13	9.90	10.00	0.134
Key Side	149/5745	802.11a	1.164	0.209	2.05	9.80	10.00	1.219
Key Side	165/5825	802.11a	1.298	0.293	0.53	9.80	10.00	1.359

**10.2. Simultaneous Transmission Possibilities**

The EUT supports WLAN 2.4GHz (802.11 b/g/n) with SISO 2X2, WLAN 5.2/5.8 GHz {802.11a/n (HT20, HT40), 802.11ac (VHT20, VHT40, VHT80)} with SISO 2X2, Bluetooth (BDR, EDR and BLE). Main Ant: ANT A: WIFI ANT, Aux Ant: ANT B: Bluetooth/WIFI ANT. ANT A: WLAN2.4G and WLAN5.2G/5.8G share the same antenna, and cannot transmit simultaneously. ANT B: WLAN2.4G, WLAN5.2G/5.8G and Bluetooth share the same antenna, and cannot transmit simultaneously. Only supports Ant B (Bluetooth) and Ant A (WLAN 5.2G/5.8G) transmit simultaneously, and/or Ant B (Bluetooth) and Ant A (WLAN 2.4G) transmit simultaneously.

### 10.3. SAR Summation Scenario

Per KDB 447498 D01, simultaneous transmission SAR is compliant if,

- 1) Scalar SAR summation < 1.6W/kg.
- 2)  $SPLSR = (SAR_1 + SAR_2)^{1.5} / (\text{min. separation distance, mm})$ , and the peak separation distance is determined from the square root of  $[(x_1-x_2)^2 + (y_1-y_2)^2 + (z_1-z_2)^2]$ , where  $(x_1, y_1, z_1)$  and  $(x_2, y_2, z_2)$  are the coordinates of the extrapolated peak SAR locations in the zoom scan. If  $SPLSR \leq 0.04$ , simultaneously transmission SAR measurement is not necessary.

Test Position		Scaled SAR <sub>MAX</sub>		Σ 1-g SAR (W/Kg)	SPLSR	Remark
		WLAN 5.2G (Ant A)	Bluetooth (Ant B)			
Body	Key Side	1.353	0.105	1.459	N/A	N/A
	Back Side	0.041	0.105	0.146	N/A	N/A
	Top Side	0.181	0.105	0.287	N/A	N/A

NOTE: 1-g SAR Simultaneous Tx Combination of WLAN 5.2G (Ant A) and Bluetooth (Ant B).

Test Position		Scaled SAR <sub>MAX</sub>		Σ 1-g SAR (W/Kg)	SPLSR	Remark
		WLAN 5.8G (Ant A)	Bluetooth (Ant B)			
Body	Key Side	0.939	0.105	1.045	N/A	N/A
	Back Side	0.049	0.105	0.155	N/A	N/A
	Top Side	0.089	0.105	0.195	N/A	N/A

NOTE: 1-g SAR Simultaneous Tx Combination of WLAN 5.8G (Ant A) and Bluetooth (Ant B).

Test Position		Scaled SAR <sub>MAX</sub>		Σ 1-g SAR (W/Kg)	SPLSR	Remark
		WLAN 2.4G (Ant A)	Bluetooth (Ant B)			
Body	Key Side	0.769	0.105	0.874	N/A	N/A
	Back Side	0.034	0.105	0.139	N/A	N/A
	Top Side	0.118	0.105	0.223	N/A	N/A

NOTE: 1-g SAR Simultaneous Tx Combination of WLAN 2.4G (Ant A) and Bluetooth (Ant B).

## 11. Appendix A. Photo documentation

Table of contents
-------------------

Test Facility
---------------

Product Photo
---------------

Test Positions
----------------

Liquid depth
--------------

**Test Facility**

Measurement System SATIMO





**Product Photo**

Front View



Back View





Reference Line



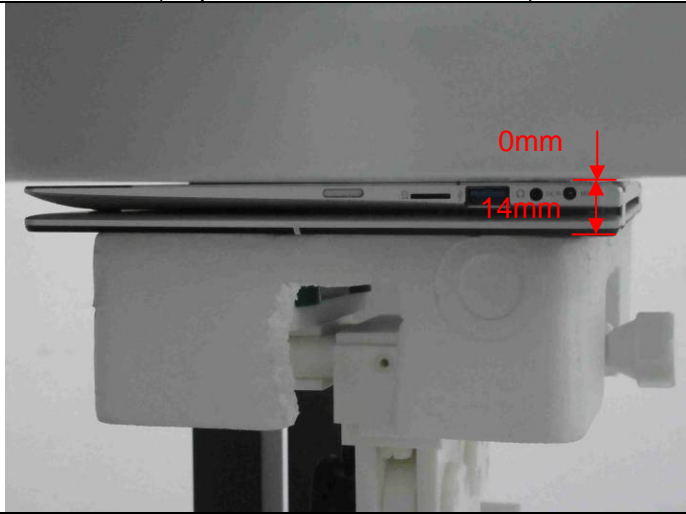
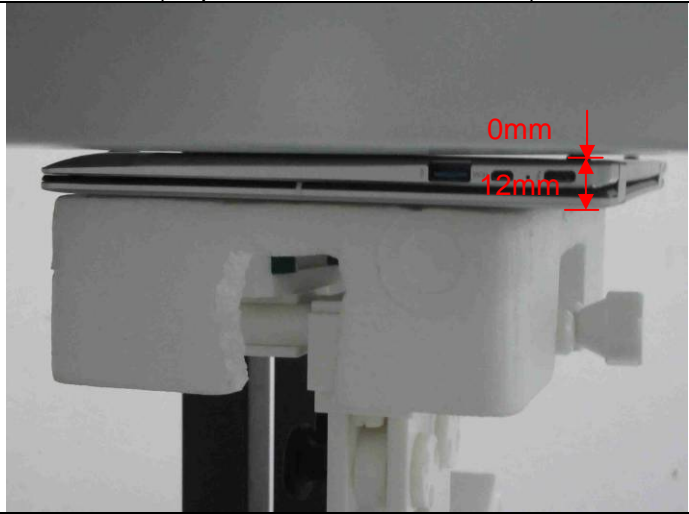

N/A

N/A

**Test Positions**

Key Side (Separation distance of 0mm)	Back Side (Separation distance of 0mm)
	
Top Side (Separation distance of 0mm)	N/A
	N/A

**Liquid depth**

Body Position with 2450MHz liquid depth (15.2cm)	Body Position with 5200MHz liquid depth (15.5cm)
	

## 12. Appendix B. System Check Plots

Table of contents
-------------------

System Performance Check - SID2450-Body
---

System Performance Check - SID5200-Body
---

System Performance Check - SID5800-Body
---

### System Performance Check - SID2450MHz

Date of measurement:	Aug. 12, 2017
Signal:	Communication System: CW; Frequency: 2450.00MHz; Duty Cycle: 1:1.00
ConvF:	2.10
Liquid Parameters:	Relative permittivity (real part): 52.80; Conductivity (S/m): 1.97;
Device Position:	Dipole
Area Scan:	dx=12mm dy=12mm, h=5.00mm
Zoom Scan:	7x7x7, dx=5mm dy=5mm dz=5mm, h=5.00mm

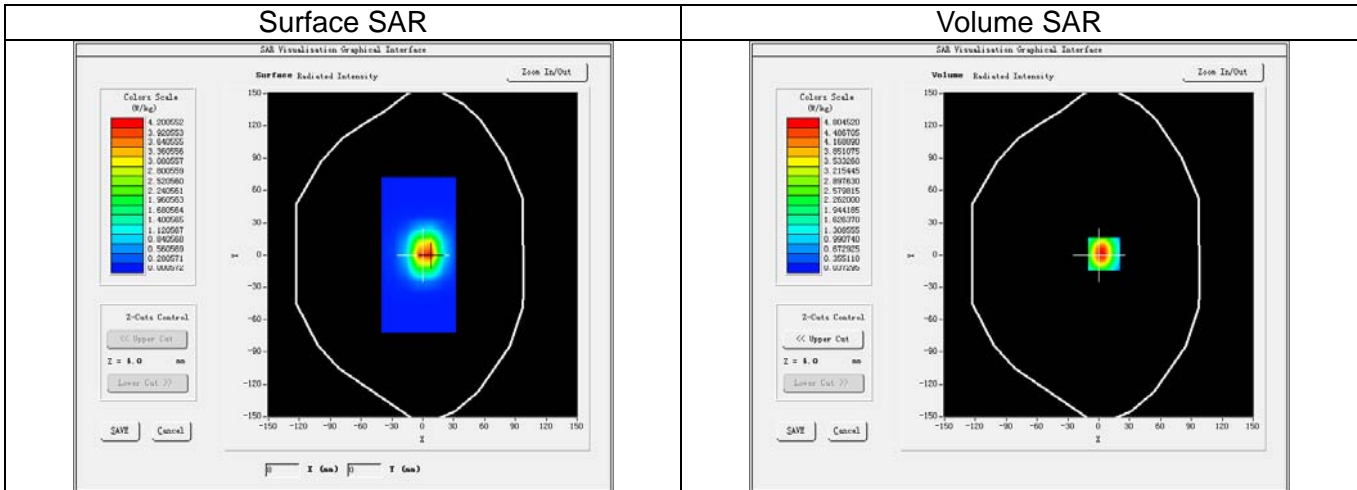

3D screen shot

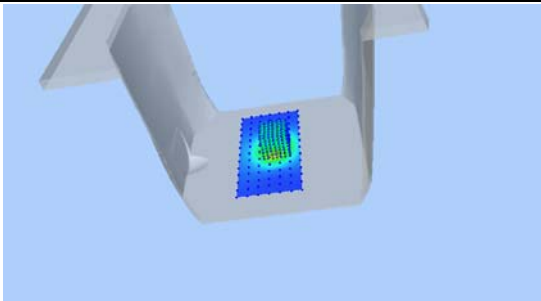

Hot spot position

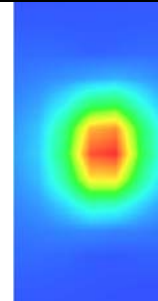

Maximum location: X=5.00, Y=1.00  
SAR Peak: 7.90 W/kg

SAR 1g (W/Kg)	4.751						
SAR 10g (W/Kg)	2.201						
Power Drift (±5%):	-0.54						
Z (mm)	0.00	4.00	9.00	14.00	19.00	24.00	29.00
SAR (W/Kg)	7.6640	4.8045	2.5910	1.4025	0.7740	0.4229	0.2343

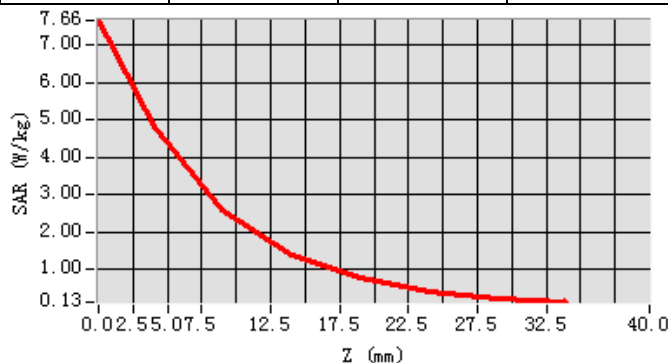

### System Performance Check - SID5200MHz

Date of measurement:	Aug. 14, 2017
Signal:	Communication System: CW; Frequency: 5200.00MHz; Duty Cycle: 1:1.00
ConvF:	2.04
Liquid Parameters:	Relative permittivity (real part): 49.59; Conductivity (S/m): 5.29;
Device Position:	Dipole
Area Scan:	dx=10mm dy=10mm, h=5.00mm
Zoom Scan:	7x7x12, dx=4mm dy=4mm dz=2mm, h=5.00mm

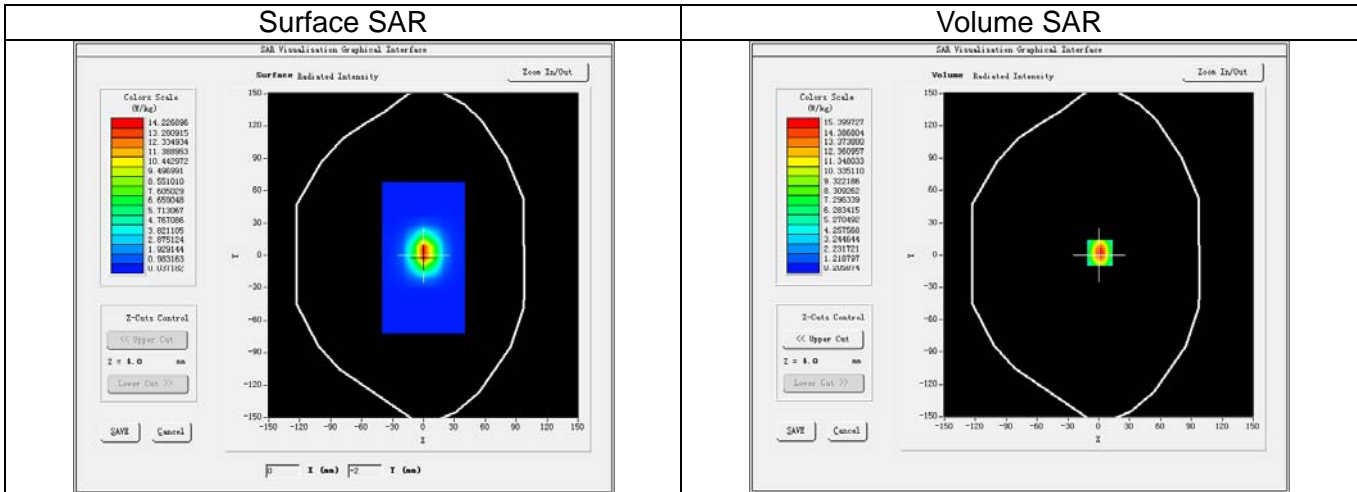

3D screen shot

Hot spot position

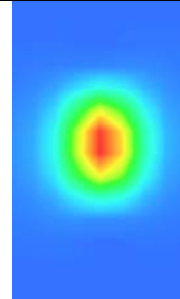
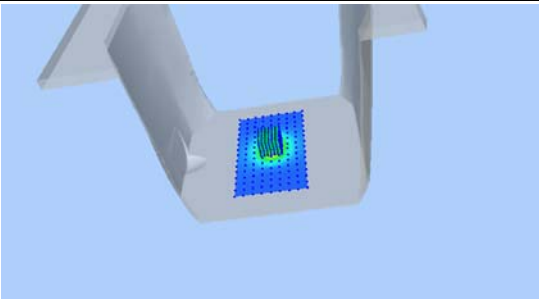

Maximum location: X=1.00, Y=2.00

SAR Peak: 28.39 W/kg

SAR 1g (W/Kg)	14.698						
SAR 10g (W/Kg)	5.167						
Power Drift (±5%):	-0.17						
Z (mm)	0.00	4.00	8.00	12.00	16.00	20.00	22.00
SAR (W/Kg)	28.5173	15.2549	7.5587	4.0128	2.0139	1.0217	0.6502

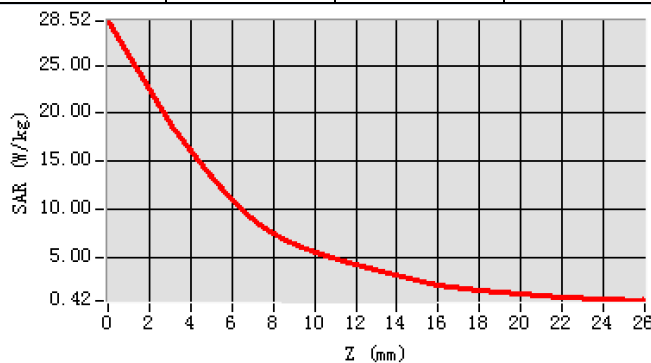



### System Performance Check - SID5800MHz

Date of measurement:	Aug. 15, 2017
Signal:	Communication System: CW; Frequency: 5800.00MHz; Duty Cycle: 1:1.00
ConvF:	2.07
Liquid Parameters:	Relative permittivity (real part): 48.48; Conductivity (S/m): 6.03;
Device Position:	Dipole
Area Scan:	dx=10mm dy=10mm, h=5.00mm
Zoom Scan:	7x7x12, dx=4mm dy=4mm dz=2mm, h=5.00mm

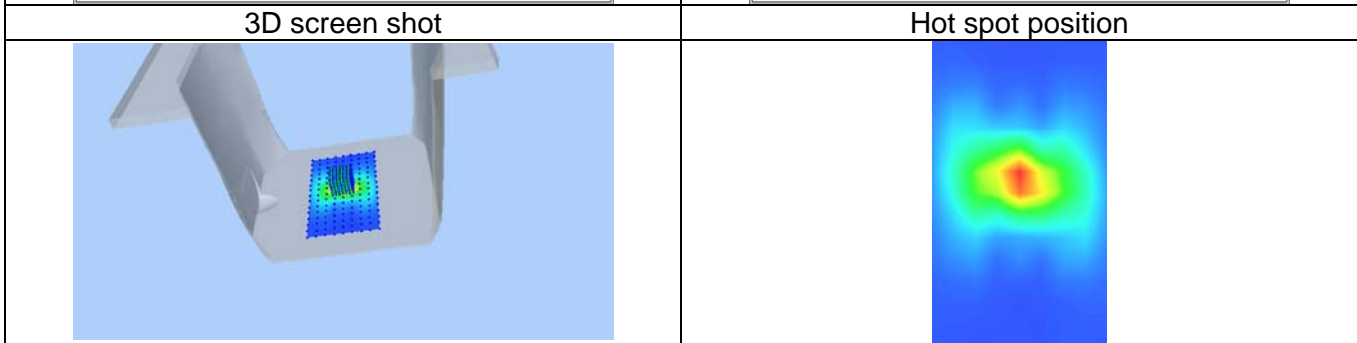
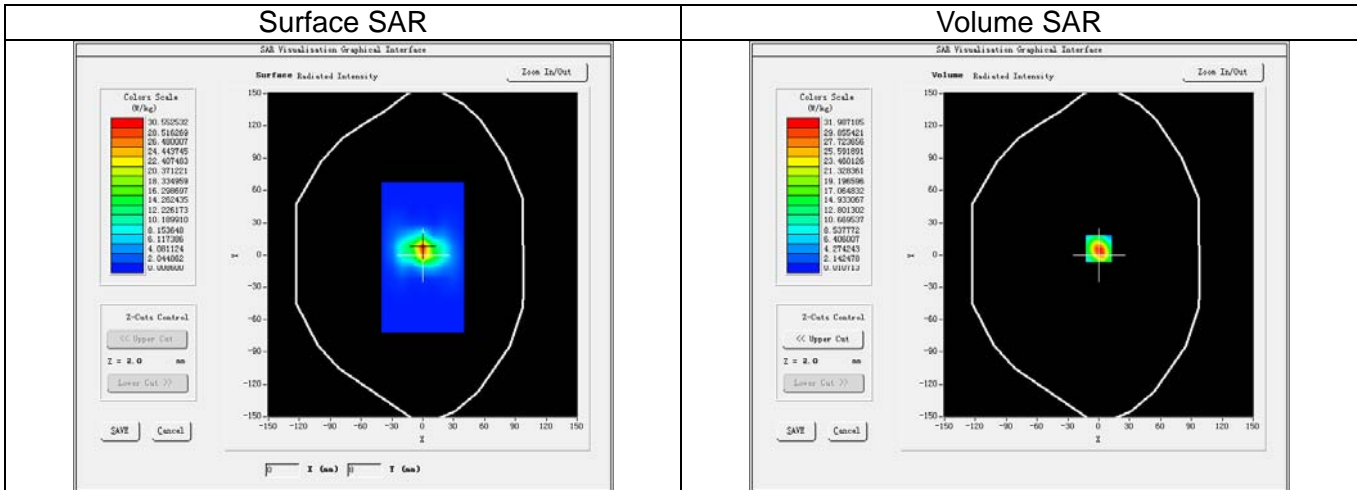

Maximum location: X=0.00, Y=6.00  
SAR Peak: 55.80 W/kg

SAR 1g (W/Kg)	16.577						
SAR 10g (W/Kg)	5.679						
Power Drift (±5%):	-0.11						
Z (mm)	0.00	4.00	8.00	12.00	16.00	20.00	22.00
SAR (W/Kg)	54.1351	16.3527	4.0789	1.0337	0.2725	0.0757	0.0514

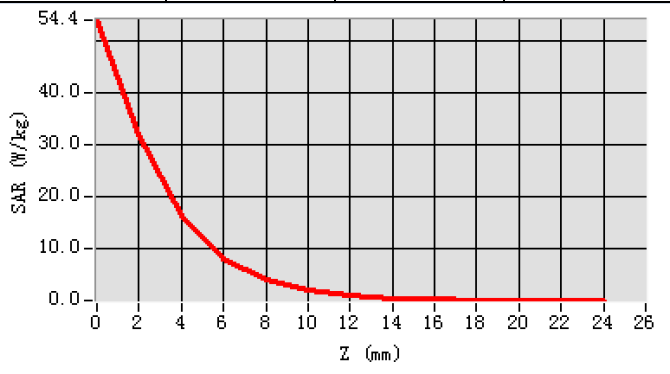

### 13. Appendix C. Plots of High SAR Measurement

<b>Table of contents</b>
--------------------------

<b>WLAN 2.4G Body</b>
-----------------------

<b>WLAN 5.2G Body</b>
-----------------------

<b>WLAN 5.8G Body</b>
-----------------------



**WLAN 2.4G\_802.11b\_Ch1\_Key Side\_0mm\_Ant A**

Date of measurement:	Aug. 12, 2017
Signal:	Communication System: WLAN 802.11a/b/g/n/ac; Frequency: 2412.00MHz; Duty Cycle: 1:1.00
ConvF:	2.10
Liquid Parameters:	Relative permittivity (real part): 53.00; Conductivity (S/m): 1.92;
Device Position:	Body
Area Scan:	dx=12mm dy=12mm, h=5.00mm
Zoom Scan:	7x7x7, dx=5mm dy=5mm dz=5mm, h=5.00mm

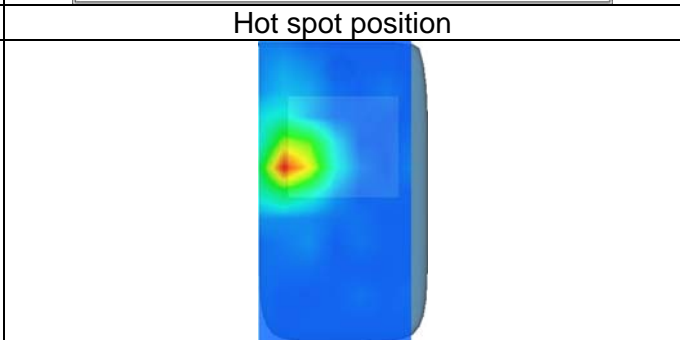
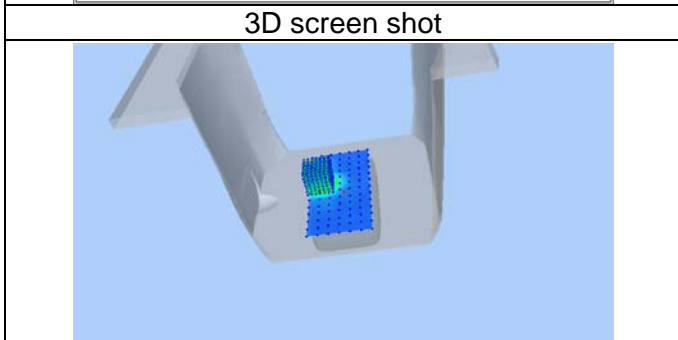
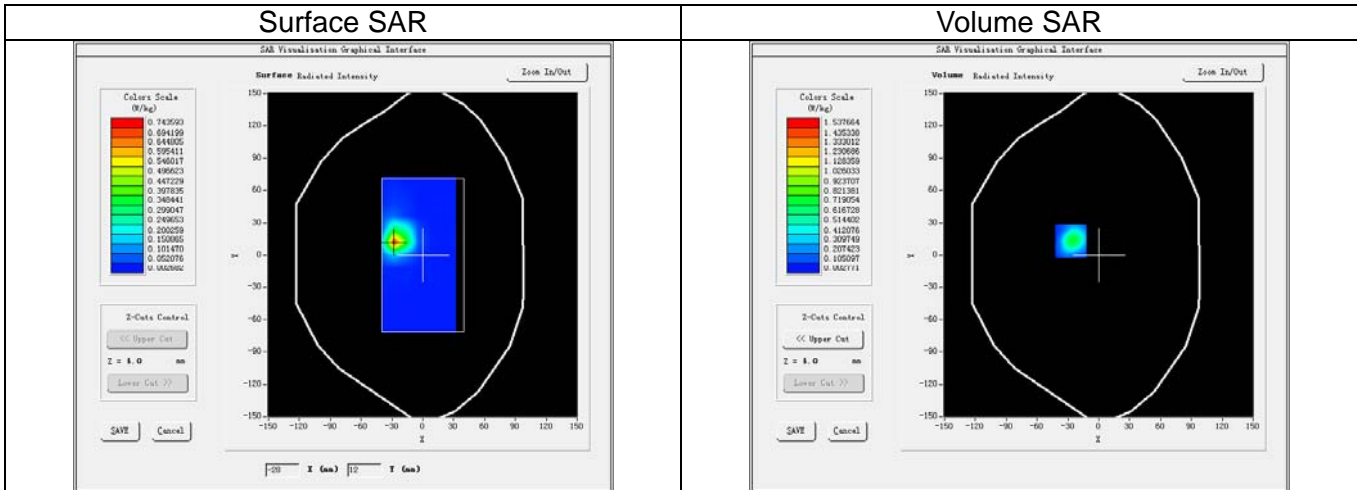

Maximum location: X=-27.00, Y=13.00  
SAR Peak: 1.74 W/kg

SAR 1g (W/Kg)		0.685					
SAR 10g (W/Kg)		0.242					
Power Drift (±5%):		-1.16					
Z (mm)	0.00	4.00	9.00	14.00	19.00	24.00	29.00
SAR (W/Kg)	1.7802	0.9731	0.4142	0.1815	0.0814	0.0386	0.0161

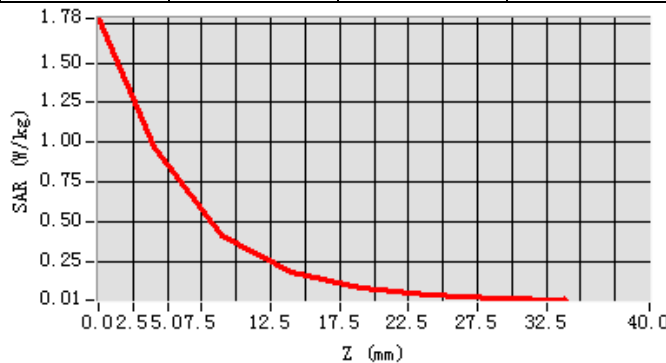

**WLAN 5.2G\_802.11a\_Ch40\_Key Side\_0mm\_Ant A**

Date of measurement:	Aug. 14, 2017
Signal:	Communication System: WLAN 802.11a/b/g/n/ac; Frequency: 5200.00MHz; Duty Cycle: 1:1.00
ConvF:	2.04
Liquid Parameters:	Relative permittivity (real part): 49.59; Conductivity (S/m): 5.29;
Device Position:	Body
Area Scan:	dx=10mm dy=10mm, h=5.00mm
Zoom Scan:	7x7x12, dx=4mm dy=4mm dz=2mm, h=5.00mm

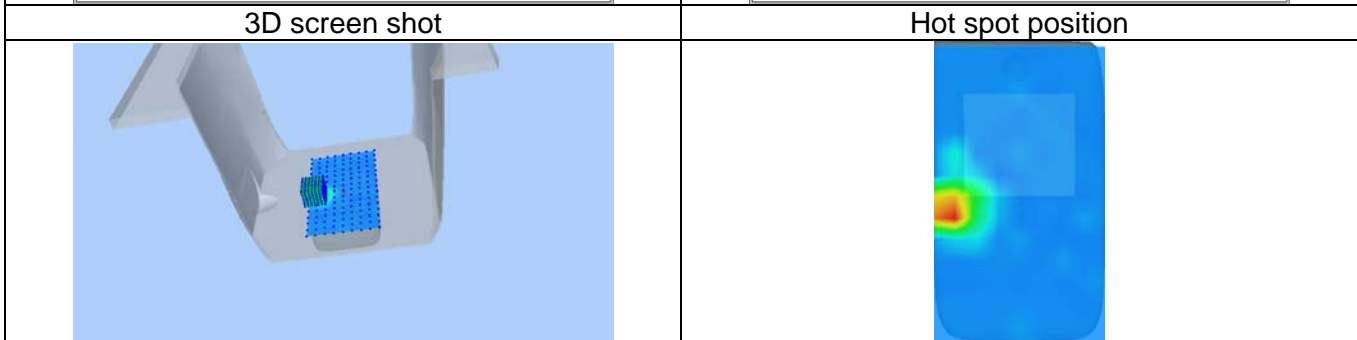
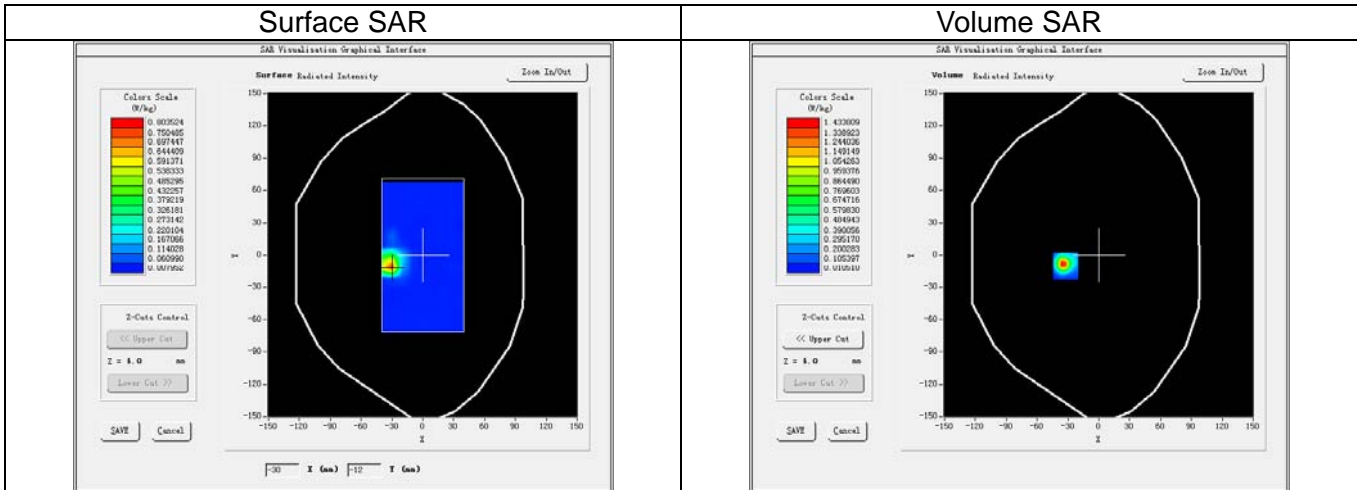

Maximum location: X=-32.00, Y=-10.00  
SAR Peak: 4.50 W/kg

SAR 1g (W/Kg)	1.263
SAR 10g (W/Kg)	0.282
Power Drift (±5%):	2.32

Z (mm)	0.00	6.00	10.00	14.00	18.00	22.00	24.00
SAR (W/Kg)	4.6950	0.7262	0.0708	0.0263	0.0171	0.0107	0.0127

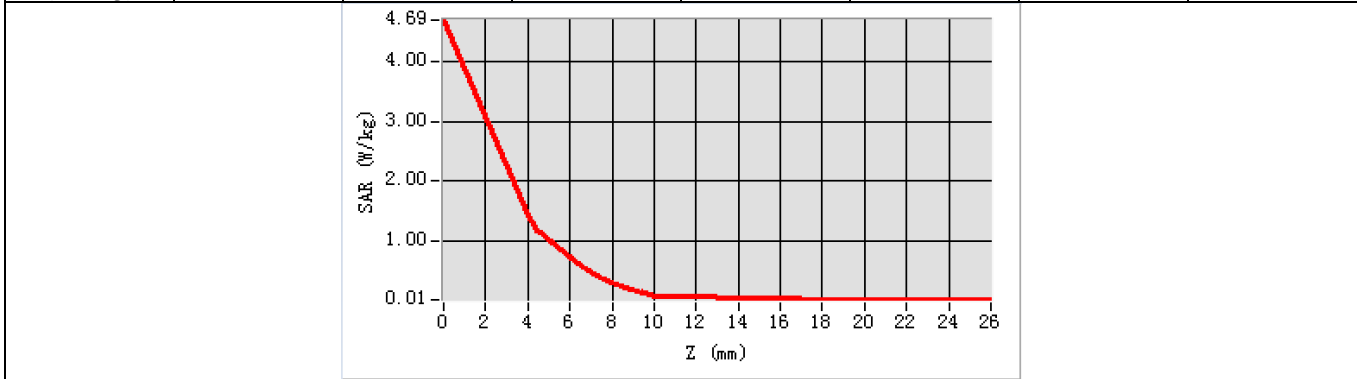

**WLAN 5.8G\_802.11a\_Ch157\_Key Side\_0mm\_Ant B**

Date of measurement:	Aug. 15, 2017
Signal:	Communication System: WLAN 802.11a/b/g/n/ac; Frequency: 5785.00MHz; Duty Cycle: 1:1.00
ConvF:	2.07
Liquid Parameters:	Relative permittivity (real part): 48.55; Conductivity (S/m): 5.98;
Device Position:	Body
Area Scan:	dx=10mm dy=10mm, h=5.00mm
Zoom Scan:	7x7x12, dx=4mm dy=4mm dz=2mm, h=5.00mm

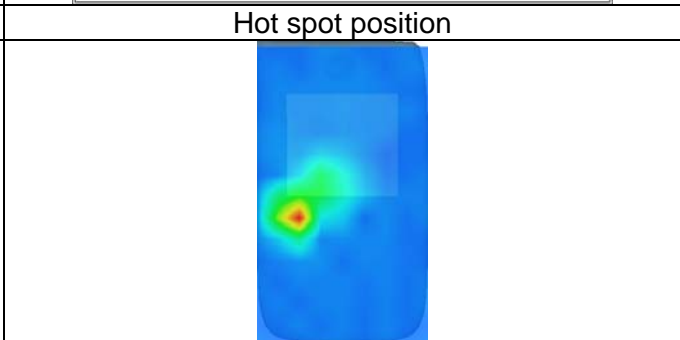
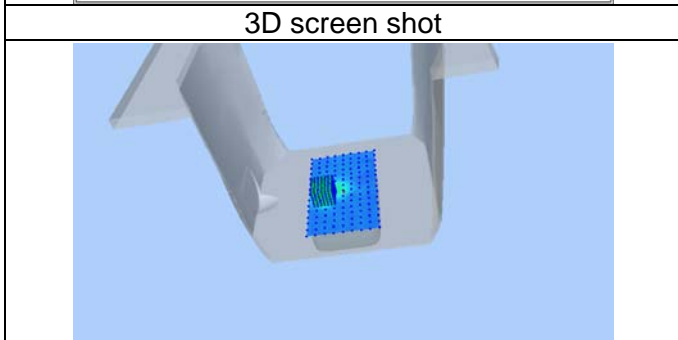
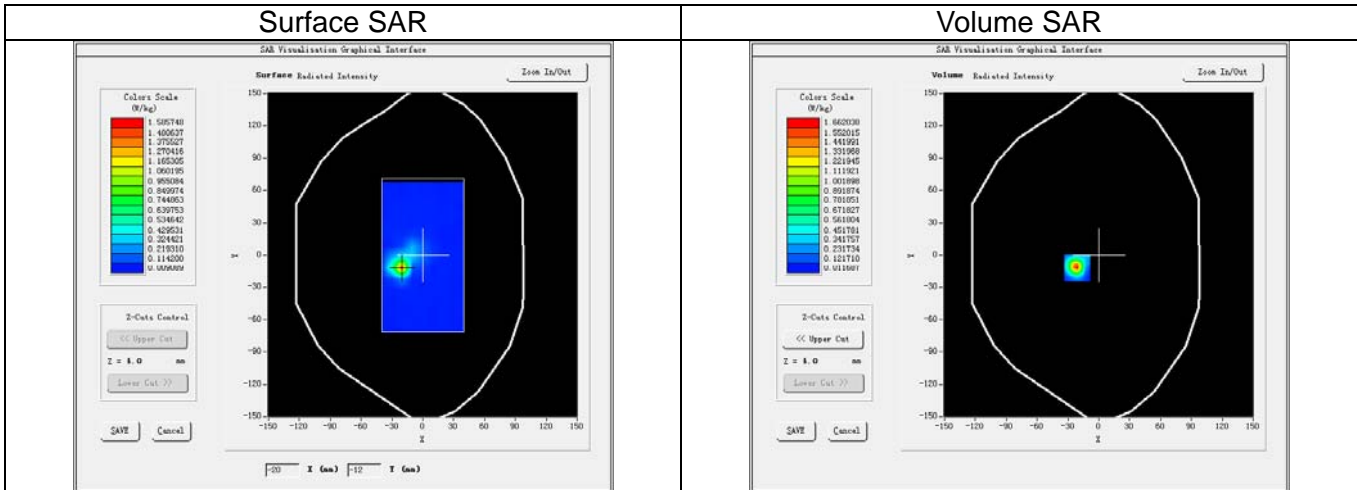

Maximum location: X=-21.00, Y=-12.00  
SAR Peak: 5.06 W/kg

SAR 1g (W/Kg)		1.420					
SAR 10g (W/Kg)		0.325					
Power Drift (±5%):		0.49					
Z (mm)	0.00	6.00	10.00	14.00	18.00	22.00	24.00
SAR (W/Kg)	5.0057	0.7253	0.1273	0.0291	0.0199	0.0124	0.0122

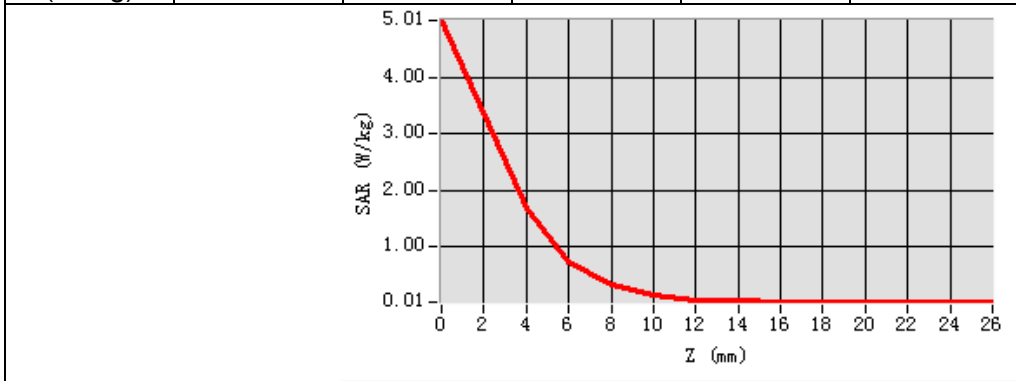

## 14. Appendix D. Calibration Certificate

Table of contents
-------------------

E Field Probe - SN 08/16 EPGO287
----------------------------------

2450 MHz Dipole - SN 03/15 DIP 2G450-352
--

5000-6000 MHz Dipole - SN 13/14 WGA 33
--

Extended Calibration Certificate
----------------------------------



## COMOSAR E-Field Probe Calibration Report

Ref : ACR.263.1.16.SATU.A

**NTEK TESTING TECHNOLOGY CO., LTD.**  
**BUILDING E, FENDA SCIENCE PARK, SANWEI**  
**COMMUNITY, XIXIANG STREET,**  
**BAO'AN DISTRICT, SHENZHEN GUANGDONG, CHINA**  
**MVG COMOSAR DOSIMETRIC E-FIELD PROBE**  
**SERIAL NO.: SN 08/16 EPGO287**

**Calibrated at MVG US**  
**2105 Barrett Park Dr. - Kennesaw, GA 30144**



**Calibration Date: 09/08/2016**

*Summary:*

This document presents the method and results from an accredited COMOSAR Dosimetric E-Field Probe calibration performed in MVG USA using the CALISAR / CALIBAIR test bench, for use with a COMOSAR system only. All calibration results are traceable to national metrology institutions.



COMOSAR E-FIELD PROBE CALIBRATION REPORT

Ref. ACR.263.1.16.SATU.A

	<i>Name</i>	<i>Function</i>	<i>Date</i>	<i>Signature</i>
<i>Prepared by :</i>	Jérôme LUC	Product Manager	9/19/2016	<i>JL</i>
<i>Checked by :</i>	Jérôme LUC	Product Manager	9/19/2016	<i>JL</i>
<i>Approved by :</i>	Kim RUTKOWSKI	Quality Manager	9/19/2016	<i>Kim Rutkowski</i>

	<i>Customer Name</i>
<i>Distribution :</i>	NTEK TESTING TECHNOLOGY CO., LTD.

<i>Issue</i>	<i>Date</i>	<i>Modifications</i>
A	9/19/2016	Initial release



COMOSAR E-FIELD PROBE CALIBRATION REPORT

Ref. ACR.263.1.16.SATU.A

TABLE OF CONTENTS

1	Device Under Test .....	4
2	Product Description .....	4
2.1	General Information .....	4
3	Measurement Method .....	4
3.1	Linearity .....	4
3.2	Sensitivity .....	5
3.3	Lower Detection Limit .....	5
3.4	Isotropy .....	5
3.5	Boundary Effect .....	5
4	Measurement Uncertainty .....	5
5	Calibration Measurement Results .....	6
5.1	Sensitivity in air .....	6
5.2	Linearity .....	7
5.3	Sensitivity in liquid .....	7
5.4	Isotropy .....	8
6	List of Equipment .....	10





**COMOSAR E-FIELD PROBE CALIBRATION REPORT**

Ref: ACR.263.1.16.SATU.A

**1 DEVICE UNDER TEST**

Device Under Test	
Device Type	COMOSAR DOSIMETRIC E FIELD PROBE
Manufacturer	MVG
Model	SSE2
Serial Number	SN 08/16 EPGO287
Product Condition (new / used)	New
Frequency Range of Probe	0.7 GHz-6GHz
Resistance of Three Dipoles at Connector	Dipole 1: R1=0.206 MΩ Dipole 2: R2=0.193 MΩ Dipole 3: R3=0.194 MΩ

A yearly calibration interval is recommended.

**2 PRODUCT DESCRIPTION**

**2.1 GENERAL INFORMATION**

MVG's COMOSAR E field Probes are built in accordance to the IEEE 1528, OET 65 Bulletin C and CEI/IEC 62209 standards.



**Figure 1 – MVG COMOSAR Dosimetric E field Dipole**

Probe Length	330 mm
Length of Individual Dipoles	2 mm
Maximum external diameter	8 mm
Probe Tip External Diameter	2.5 mm
Distance between dipoles / probe extremity	1 mm

**3 MEASUREMENT METHOD**

The IEEE 1528, OET 65 Bulletin C, CENELEC EN50361 and CEI/IEC 62209 standards provide recommended practices for the probe calibrations, including the performance characteristics of interest and methods by which to assess their affect. All calibrations / measurements performed meet the fore mentioned standards.

**3.1 LINEARITY**

The evaluation of the linearity was done in free space using the waveguide, performing a power sweep to cover the SAR range 0.01W/kg to 100W/kg.





COMOSAR E-FIELD PROBE CALIBRATION REPORT

Ref: ACR.263.1.16.SATU.A

3.2 SENSITIVITY

The sensitivity factors of the three dipoles were determined using a two step calibration method (air and tissue simulating liquid) using waveguides as outlined in the standards.

3.3 LOWER DETECTION LIMIT

The lower detection limit was assessed using the same measurement set up as used for the linearity measurement. The required lower detection limit is 10 mW/kg.

3.4 ISOTROPY

The axial isotropy was evaluated by exposing the probe to a reference wave from a standard dipole with the dipole mounted under the flat phantom in the test configuration suggested for system validations and checks. The probe was rotated along its main axis from 0 - 360 degrees in 15 degree steps. The hemispherical isotropy is determined by inserting the probe in a thin plastic box filled with tissue-equivalent liquid, with the plastic box illuminated with the fields from a half wave dipole. The dipole is rotated about its axis (0°–180°) in 15° increments. At each step the probe is rotated about its axis (0°–360°).

3.5 BOUNDARY EFFECT

The boundary effect is defined as the deviation between the SAR measured data and the expected exponential decay in the liquid when the probe is oriented normal to the interface. To evaluate this effect, the liquid filled flat phantom is exposed to fields from either a reference dipole or waveguide. With the probe normal to the phantom surface, the peak spatial average SAR is measured and compared to the analytical value at the surface.

4 MEASUREMENT UNCERTAINTY

The guidelines outlined in the IEEE 1528, OET 65 Bulletin C, CENELEC EN50361 and CEI/IEC 62209 standards were followed to generate the measurement uncertainty associated with an E-field probe calibration using the waveguide technique. All uncertainties listed below represent an expanded uncertainty expressed at approximately the 95% confidence level using a coverage factor of k=2, traceable to the Internationally Accepted Guides to Measurement Uncertainty.

Uncertainty analysis of the probe calibration in waveguide					
ERROR SOURCES	Uncertainty value (%)	Probability Distribution	Divisor	ci	Standard Uncertainty (%)
Incident or forward power	3.00%	Rectangular	$\sqrt{3}$	1	1.732%
Reflected power	3.00%	Rectangular	$\sqrt{3}$	1	1.732%
Liquid conductivity	5.00%	Rectangular	$\sqrt{3}$	1	2.887%
Liquid permittivity	4.00%	Rectangular	$\sqrt{3}$	1	2.309%
Field homogeneity	3.00%	Rectangular	$\sqrt{3}$	1	1.732%
Field probe positioning	5.00%	Rectangular	$\sqrt{3}$	1	2.887%



COMOSAR E-FIELD PROBE CALIBRATION REPORT

Ref: ACR.263.1.16.SATU.A

Field probe linearity	3.00%	Rectangular	$\sqrt{3}$	1	1.732%
<b>Combined standard uncertainty</b>					5.831%
<b>Expanded uncertainty</b> 95 % confidence level k = 2					12.0%

5 CALIBRATION MEASUREMENT RESULTS

Calibration Parameters	
Liquid Temperature	21 °C
Lab Temperature	21 °C
Lab Humidity	45 %

5.1 SENSITIVITY IN AIR

Normx dipole 1 ( $\mu\text{V}/(\text{V}/\text{m})^2$ )	Normy dipole 2 ( $\mu\text{V}/(\text{V}/\text{m})^2$ )	Normz dipole 3 ( $\mu\text{V}/(\text{V}/\text{m})^2$ )
0.70	0.81	0.63

DCP dipole 1 (mV)	DCP dipole 2 (mV)	DCP dipole 3 (mV)
91	90	94

Calibration curves  $e_i=f(V)$  ( $i=1,2,3$ ) allow to obtain H-field value using the formula:

$$E = \sqrt{E_1^2 + E_2^2 + E_3^2}$$

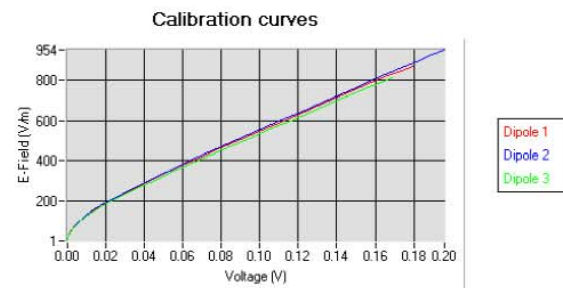



COMOSAR E-FIELD PROBE CALIBRATION REPORT

Ref: ACR.263.1.16.SATU.A

5.2 LINEARITY

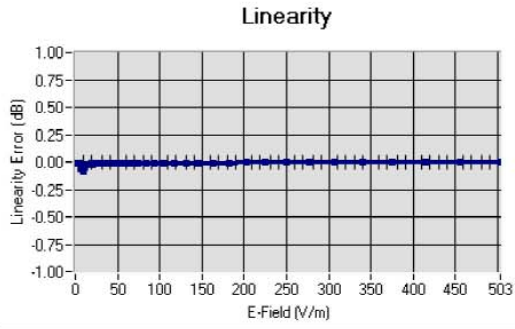

Linearity  $\pm$ 1.83% ( $\pm$ 0.08dB)

5.3 SENSITIVITY IN LIQUID

Liquid	Frequency (MHz +/- 100MHz)	Permittivity	Epsilon (S/m)	ConvF
HL450	450	42.17	0.86	1.51
BL450	450	57.65	0.95	1.55
HL750	750	40.03	0.93	1.36
BL750	750	56.83	1.00	1.41
HL850	835	42.19	0.90	1.53
BL850	835	54.67	1.01	1.59
HL900	900	42.08	1.01	1.43
BL900	900	55.25	1.08	1.48
HL1800	1800	41.68	1.46	1.66
BL1800	1800	53.86	1.46	1.69
HL1900	1900	38.45	1.45	1.94
BL1900	1900	53.32	1.56	2.00
HL2000	2000	38.26	1.38	1.87
BL2000	2000	52.70	1.51	1.94
HL2450	2450	37.50	1.80	2.03
BL2450	2450	53.22	1.89	2.10
HL2600	2600	39.80	1.99	2.11
BL2600	2600	52.52	2.23	2.17
HL5200	5200	35.64	4.67	1.99
BL5200	5200	48.64	5.51	2.04
HL5400	5400	36.44	4.87	2.09
BL5400	5400	46.52	5.77	2.16
HL5600	5600	36.66	5.17	2.10
BL5600	5600	46.79	5.77	2.17
HL5800	5800	35.31	5.31	2.02
BL5800	5800	47.04	6.10	2.07

LOWER DETECTION LIMIT: 8mW/kg



COMOSAR E-FIELD PROBE CALIBRATION REPORT

Ref: ACR.263.1.16.SATU.A

5.4 ISOTROPY

**HL900 MHz**

- Axial isotropy: 0.04 dB
- Hemispherical isotropy: 0.07 dB

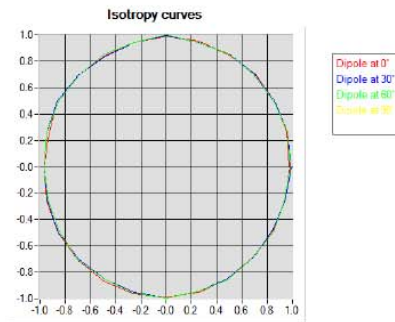

**HL1800 MHz**

- Axial isotropy: 0.05 dB
- Hemispherical isotropy: 0.07 dB

