FCC Test Report

Report No.: AGC00081190903FE03

FCC ID : 2ACP4LBT985
APPLICATION PURPOSE : Original Equipment
PRODUCT DESIGNATION : Bluetooth Earphone
BRAND NAME : SENTRY
MODEL NAME : BT985, BL985
APPLICANT : Sentry Industries Limited
DATE OF ISSUE : Oct. 09, 2019
STANDARD(S) : FCC Part 15.247
REPORT VERSION : V1.0

Attestation of Global Compliance (Shenzhen) Co., Ltd

CAUTION:

This report shall not be reproduced except in full without the written permission of the test laboratory and shall not be quoted out of context.



REPORT REVISE RECORD

Report Version	Revise Time	Issued Date	Valid Version	Notes
V1.0	/	Oct. 09, 2019	Valid	Initial Release



TABLE OF CONTENTS

1. VERIFICATION OF CONFORMITY 5

2. GENERAL INFORMATION..... 6

2.1. PRODUCT DESCRIPTION 6

2.2. TABLE OF CARRIER FREQUENCIES 6

2.3. RECEIVER INPUT BANDWIDTH 7

2.4. EXAMPLE OF A HOPPING SEQUENCY IN DATA MODE 7

2.5. EQUALLY AVERAGE USE OF FREQUENCIES AND BEHAVIOUR 7

2.6. RELATED SUBMITTAL(S) / GRANT (S) 8

2.7. TEST METHODOLOGY 8

2.8. SPECIAL ACCESSORIES 8

2.9. EQUIPMENT MODIFICATIONS 8

3. MEASUREMENT UNCERTAINTY 9

4. DESCRIPTION OF TEST MODES..... 10

5. SYSTEM TEST CONFIGURATION11

5.1. CONFIGURATION OF EUT SYSTEM 11

5.2. EQUIPMENT USED IN TESTED SYSTEM..... 11

5.3. SUMMARY OF TEST RESULTS..... 11

6. TEST FACILITY 12

7. PEAK OUTPUT POWER 13

7.1. MEASUREMENT PROCEDURE 13

7.2. TEST SET-UP (BLOCK DIAGRAM OF CONFIGURATION)..... 13

7.3. LIMITS AND MEASUREMENT RESULT 14

8. 20DB BANDWIDTH 18

8.1. MEASUREMENT PROCEDURE 18

8.2. TEST SET-UP (BLOCK DIAGRAM OF CONFIGURATION)..... 18

8.3. LIMITS AND MEASUREMENT RESULTS 18

9. CONDUCTED SPURIOUS EMISSION 23

9.1. MEASUREMENT PROCEDURE 23

9.2. TEST SET-UP (BLOCK DIAGRAM OF CONFIGURATION)..... 23



9.3. MEASUREMENT EQUIPMENT USED	23
9.4. LIMITS AND MEASUREMENT RESULT	23
10. RADIATED EMISSION.....	31
10.1. MEASUREMENT PROCEDURE	31
10.2. TEST SETUP.....	33
10.3. LIMITS AND MEASUREMENT RESULT	34
10.4. TEST RESULT.....	34
11. NUMBER OF HOPPING FREQUENCY	44
11.1. MEASUREMENT PROCEDURE	44
11.2. TEST SETUP (BLOCK DIAGRAM OF CONFIGURATION).....	44
11.3. MEASUREMENT EQUIPMENT USED	44
11.4. LIMITS AND MEASUREMENT RESULT	44
12. TIME OF OCCUPANCY (DWELL TIME)	45
12.1. MEASUREMENT PROCEDURE	45
12.2. TEST SETUP (BLOCK DIAGRAM OF CONFIGURATION).....	45
12.3. MEASUREMENT EQUIPMENT USED	45
12.4. LIMITS AND MEASUREMENT RESULT	45
13. FREQUENCY SEPARATION.....	49
13.1. MEASUREMENT PROCEDURE	49
13.2. TEST SETUP (BLOCK DIAGRAM OF CONFIGURATION).....	49
13.3. MEASUREMENT EQUIPMENT USED	49
13.4. LIMITS AND MEASUREMENT RESULT	49
14. FCC LINE CONDUCTED EMISSION TEST	50
14.1. LIMITS OF LINE CONDUCTED EMISSION TEST.....	50
14.2. BLOCK DIAGRAM OF LINE CONDUCTED EMISSION TEST	50
14.3. PRELIMINARY PROCEDURE OF LINE CONDUCTED EMISSION TEST	51
14.4. FINAL PROCEDURE OF LINE CONDUCTED EMISSION TEST	51
14.5. TEST RESULT OF LINE CONDUCTED EMISSION TEST	51
APPENDIX A: PHOTOGRAPHS OF TEST SETUP	52
APPENDIX B: PHOTOGRAPHS OF EUT	54

1. VERIFICATION OF CONFORMITY

Applicant	Sentry Industries Limited
Address	Room 904, 9/F Chinachem Golden Plaza, 77 Mody Road, Tsimshatsui East, Kowloon, Hong Kong
Manufacturer	Guangdong SAIYO Electronics Industry Co., Ltd
Address	Xibian Industry Zone, Tongyu Town, Chaoyang District, Shantou City, Guangdong Province
Factory	Guangdong SAIYO Electronics Industry Co., Ltd
Address	Xibian Industry Zone, Tongyu Town, Chaoyang District, Shantou City, Guangdong Province
Product Designation	Bluetooth Earphone
Brand Name	SENTRY
Test Model	BT985
Series Model	BL985
Difference Description	All the same except for the model name
Date of test	Sep. 23, 2019 to Sep. 25, 2019
Deviation	None
Condition of Test Sample	Normal
Test Result	Pass
Report Template	AGCRT-US-BR/RF

We hereby certify that:

The above equipment was tested by Attestation of Global Compliance (Shenzhen) Co., Ltd. The test data, data evaluation, test procedures, and equipment configurations shown in this report were made in accordance with the procedures given in ANSI C63.10 (2013) and the energy emitted by the sample EUT tested as described in this report is in compliance with radiated emission limits of FCC PART 15.247.

Prepared By



John Zeng
Project Engineer

Sep. 25, 2019

Reviewed By



Max Zhang
Reviewer

Oct. 09, 2019

Approved By



Forrest Lei
Authorized Officer

Oct. 09, 2019

2. GENERAL INFORMATION

2.1. PRODUCT DESCRIPTION

The EUT is designed as “Bluetooth Earphone”. It is designed by way of utilizing the GFSK, Pi/4 DQPSK technology to achieve the system operation.

A major technical description of EUT is described as following

Operation Frequency	2.402 GHz to 2.480GHz
RF Output Power	-2.197dBm(Max)
Bluetooth Version	V5.0
Modulation	BR <input checked="" type="checkbox"/> GFSK, EDR <input checked="" type="checkbox"/> π /4-DQPSK, <input type="checkbox"/> 8DPSK BLE <input type="checkbox"/> GFSK 1Mbps <input type="checkbox"/> GFSK 2Mbps
Number of channels	79 Channels
Hardware Version	V1.1
Software Version	V1.0
Antenna Designation	Ceramic Antenna(Comply with requirements of the FCC part 15.203)
Antenna Gain	-4dBi
Power Supply	DC 3.7V by battery

Note: The EUT doesn't support 8DPSK and BLE.

2.2. TABLE OF CARRIER FREQUENCIES

Frequency Band	Channel Number	Frequency
2402~2480MHZ	0	2402MHZ
	1	2403MHZ
	:	:
	38	2440 MHZ
	39	2441 MHZ
	40	2442 MHZ
	:	:
	77	2479 MHZ
	78	2480 MHZ



2.3. RECEIVER INPUT BANDWIDTH

The input bandwidth of the receiver is 1.3MHz. In every connection one Bluetooth device is the master and the other one is slave. The master determines the hopping sequence. The slave follows this sequence. Both devices shift between RX and TX time slot according to the clock of the master. Additionally the type of connection (e.g. single or multislot packet) is set up at the beginning of the connection. The master adapts its hopping frequency and its TX/RX timing according to the packet type of the connection. Also the slave of the connection will use these settings.

Repeating of a packet has no influence on the hopping sequence. The hopping sequence generated by the master of the connection will be followed in any case. That means, a repeated packet will not be sent on the same frequency, it is sent on the next frequency of the hopping sequence.

2.4. EXAMPLE OF A HOPPING SEQUENCE IN DATA MODE

Example of a 79 hopping sequence in data mode:

40,21,44,23,42,53,46,55,48,33,52,35,50,65,54,67
56,37,60,39,58,69,62,71,64,25,68,27,66,57,70,59
72,29,76,31,74,61,78,63,01,41,05,43,03,73,07,75
09,45,13,47,11,77,15,00,64,49,66,53,68,02,70,06
01, 51, 03, 55, 05, 04

2.5. EQUALLY AVERAGE USE OF FREQUENCIES AND BEHAVIOUR

The generation of the hopping sequence in connection mode depends essentially on two input values:

1. LAP/UAP of the master of the connection.
2. Internal master clock

The LAP (lower address part) are the 24 LSB's of the 48 BD_ADDRESS. The BD_ADDRESS is an unambiguous number of every Bluetooth unit. The UAP (upper address part) are the 24 MSB's of the 48 BD_ADDRESS.

The internal clock of a Bluetooth unit is derived from a free running clock which is never adjusted and is never turned off. For synchronization with other units only offsets are used. It has no relation to the time of the day. Its resolution is at least half the RX/TX slot length of 312.5us. The clock has a cycle of about one day (23h30). In most cases it is implemented as a 28-bit counter. For the deriving of the hopping sequence the entire LAP (24 bits), 4 LSB's (4 bits) (Input 1) and the 27 MSB's of the clock (Input 2) are used. With these input values different mathematical procedures (permutations, additions, XOR-operations) are performed to generate the sequence. This will be done at the beginning of every new transmission.

Regarding short transmissions the Bluetooth system has the following behavior:

The first connection between the two devices is established, a hopping sequence was generated. For transmitting the wanted data the complete hopping sequence was not used. The connection ended.

The second connection will be established. A new hopping sequence is generated. Due to the fact the Bluetooth clock has a different value, because the period between the two transmissions is longer (and it cannot be shorter) than the minimum resolution of the clock (312.5us). The hopping sequence will always differ from the first one.

2.6. RELATED SUBMITTAL(S) / GRANT (S)

This submittal(s) (test report) is intended for **FCC ID:2ACP4LBT985** filing to comply with the FCC PART 15.247 requirements.

2.7. TEST METHODOLOGY

Both conducted and radiated testing was performed according to the procedures in ANSI C63.10 (2013). Radiated testing was performed at an antenna to EUT distance 3 meters.

2.8. SPECIAL ACCESSORIES

Refer to section 5.2.

2.9. EQUIPMENT MODIFICATIONS

Not available for this EUT intended for grant.



3. MEASUREMENT UNCERTAINTY

The reported uncertainty of measurement $y \pm U$, where expanded uncertainty U is based on a standard uncertainty multiplied by a coverage factor of $k=2$, providing a level of confidence of approximately 95%.

- Uncertainty of Conducted Emission, $U_c = \pm 3.2$ dB
- Uncertainty of Radiated Emission below 1GHz, $U_c = \pm 3.9$ dB
- Uncertainty of Radiated Emission above 1GHz, $U_c = \pm 4.8$ dB
- Uncertainty of total RF power, conducted, $U_c = \pm 0.8$ dB
- Uncertainty of spurious emissions, conducted, $U_c = \pm 2.7$ dB
- Uncertainty of Occupied Channel Bandwidth: $U_c = \pm 2$ %
- Uncertainty of Dwell Time: $U_c = \pm 2$ %
- Uncertainty of Frequency: $U_c = \pm 2$ %



4. DESCRIPTION OF TEST MODES

NO.	TEST MODE DESCRIPTION
1	Low channel GFSK
2	Middle channel GFSK
3	High channel GFSK
4	Low channel $\pi/4$ -DQPSK
5	Middle channel $\pi/4$ -DQPSK
6	High channel $\pi/4$ -DQPSK
7	Hopping mode GFSK
8	Hopping mode $\pi/4$ -DQPSK

- Note: 1. Only the result of the worst case was recorded in the report, if no other cases.
 2. For Radiated Emission, 3axis were chosen for testing for each applicable mode.
 3. For Conducted Test method, a temporary antenna connector is provided by the manufacture.

Software Setting

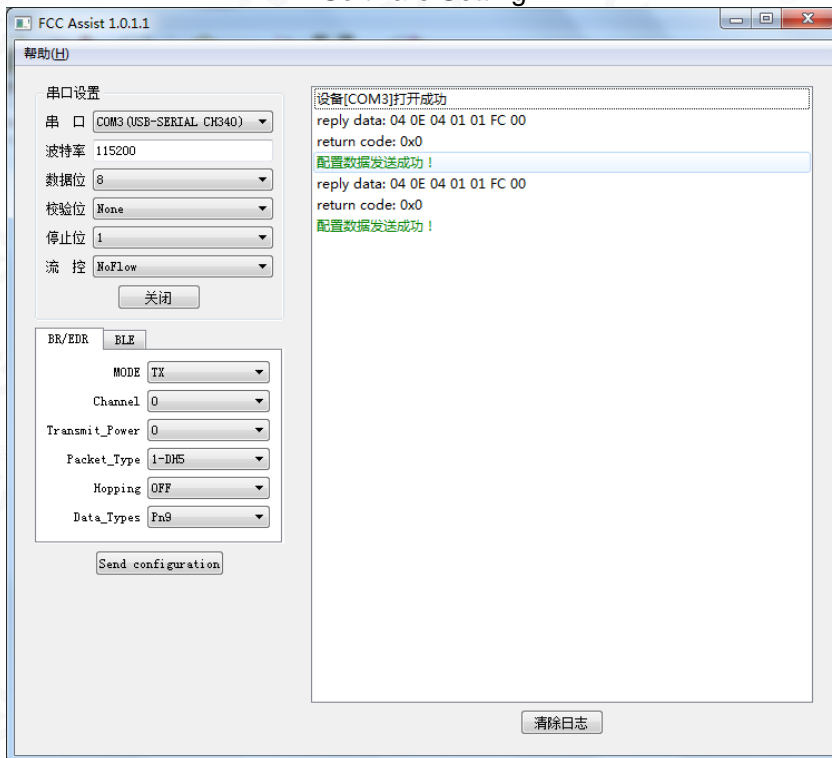

5. SYSTEM TEST CONFIGURATION

5.1. CONFIGURATION OF EUT SYSTEM

Radiated Emission Configure :

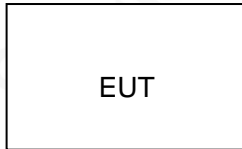

Conducted Configure :

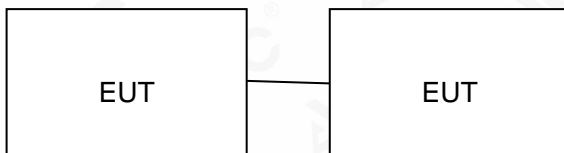

5.2. EQUIPMENT USED IN TESTED SYSTEM

Item	Equipment	Model No.	ID or Specification	Remark
1	Bluetooth Earphone	BT985	2ACP4LBT985	EUT
2	Control Box	N/A	USB-TTL	AE

5.3. SUMMARY OF TEST RESULTS

FCC RULES	DESCRIPTION OF TEST	RESULT
15.247 (b)(1)	Peak Output Power	Compliant
15.247 (a)(1)	20 dB Bandwidth	Compliant
15.247 (d)	Conducted Spurious Emission	Compliant
15.209	Radiated Emission	Compliant
15.247 (a)(1)(iii)	Number of Hopping Frequency	Compliant
15.247 (a)(1)(iii)	Time of Occupancy	Compliant
15.247 (a)(1)	Frequency Separation	Compliant
15.207	Conducted Emission	N/A

Note: The EUT can not use the BT function with charging

6. TEST FACILITY

Test Site	Attestation of Global Compliance (Shenzhen) Co., Ltd
Location	1-2/F, Building 19, Junfeng Industrial Park, Chongqing Road, Heping Community, Fuhai Street, Bao'an District, Shenzhen, Guangdong, China
Designation Number	CN1259
FCC Test Firm Registration Number	975832
A2LA Cert. No.	5054.02
Description	Attestation of Global Compliance(Shenzhen) Co., Ltd is accredited by A2LA

TEST EQUIPMENT OF RADIATED EMISSION TEST

Equipment	Manufacturer	Model	S/N	Cal. Date	Cal. Due
TEST RECEIVER	R&S	ESCI	10096	Jun. 12, 2019	Jun. 11, 2020
EXA Signal Analyzer	Aglient	N9010A	MY53470504	Dec. 20, 2018	Dec. 19, 2019
2.4GHz Fliter	EM Electronics	2400-2500MHz	N/A	Feb. 27, 2019	Feb. 26, 2020
Attenuator	ZHINAN	E-002	N/A	Aug. 26, 2019	Aug. 25, 2020
Horn antenna	SCHWARZBECK	BBHA 9170	#768	Sep. 21, 2017	Sep. 20, 2020
Active loop antenna (9K-30MHz)	ZHINAN	ZN30900C	18051	Jun. 14, 2018	Jun. 13, 2020
Double-Ridged Waveguide Horn	ETS LINDGREN	3117	00034609	May. 26, 2018	May. 25, 2020
Broadband Preamplifier	ETS LINDGREN	3117PA	00225134	Oct. 25, 2018	Oct. 24, 2019
ANTENNA	SCHWARZBECK	VULB9168	D69250	Sep. 28, 2017	Sep. 27, 2019



7. PEAK OUTPUT POWER

7.1. MEASUREMENT PROCEDURE

For peak power test:

1. Connect EUT RF output port to the Spectrum Analyzer through an RF attenuator
2. Span: Approximately five times the 20 dB bandwidth, centered on a hopping channel.
3. RBW > 20 dB bandwidth of the emission being measured.
4. VBW \geq RBW.
5. Sweep: Auto.
6. Detector function: Peak.
7. Trace: Max hold.

Allow trace to stabilize. Use the marker-to-peak function to set the marker to the peak of the emission. The indicated level is the peak output power, after any corrections for external attenuators and cables.

7.2. TEST SET-UP (BLOCK DIAGRAM OF CONFIGURATION)

PEAK POWER TEST SETUP

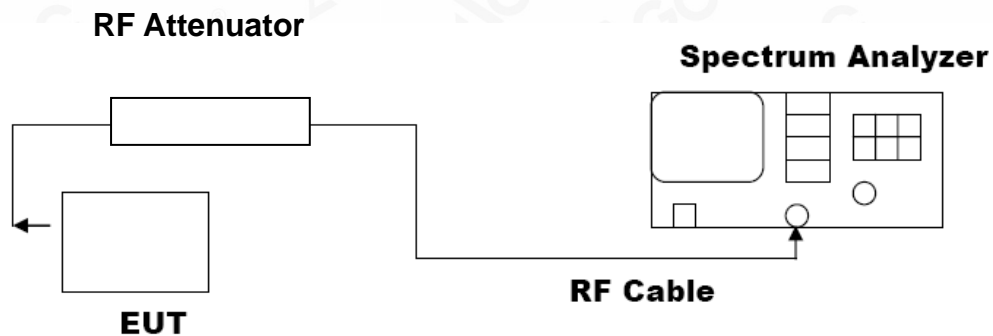

7.3. LIMITS AND MEASUREMENT RESULT

PEAK OUTPUT POWER MEASUREMENT RESULT FOR GFSK MOUDULATION			
Frequency (GHz)	Peak Power (dBm)	Applicable Limits (dBm)	Pass or Fail
2.402	-3.648	30	Pass
2.441	-3.188	30	Pass
2.480	-3.093	30	Pass

CH0



Attestation of Global Compliance

Attestation of Global Compliance(Shenzhen)Co.,Ltd.
Add: 2/F., Building 2, Sanwei Chaxi Industrial Park, Sanwei Community,
Hangcheng Street, Bao'an District, Shenzhen, Guangdong, China
Tel: +86-755 2523 4088 E-mail: agc@agc-cert.com Service Hotline:400 089 2118

CH39



CH78



Attestation of Global Compliance

Attestation of Global Compliance(Shenzhen)Co.,Ltd.
Add: 2/F., Building 2, Sanwei Chaxi Industrial Park, Sanwei Community,
Hangcheng Street, Bao'an District, Shenzhen, Guangdong, China
Tel: +86-755 2523 4088 E-mail: agc@agc-cert.com Service Hotline:400 089 2118

PEAK OUTPUT POWER MEASUREMENT RESULT FOR $\Pi/4$ -DQPSK MODULATION			
Frequency (GHz)	Peak Power (dBm)	Applicable Limits (dBm)	Pass or Fail
2.402	-2.768	30	Pass
2.441	-2.304	30	Pass
2.480	-2.197	30	Pass

CH0



Attestation of Global Compliance

Attestation of Global Compliance(Shenzhen)Co.,Ltd.

Add: 2/F., Building 2, Sanwei Chaxi Industrial Park, Sanwei Community,
Hangcheng Street, Bao'an District, Shenzhen, Guangdong, China

Tel: +86-755 2523 4088

E-mail: agc@agc-cert.com

Service Hotline: 400 089 2118

CH39

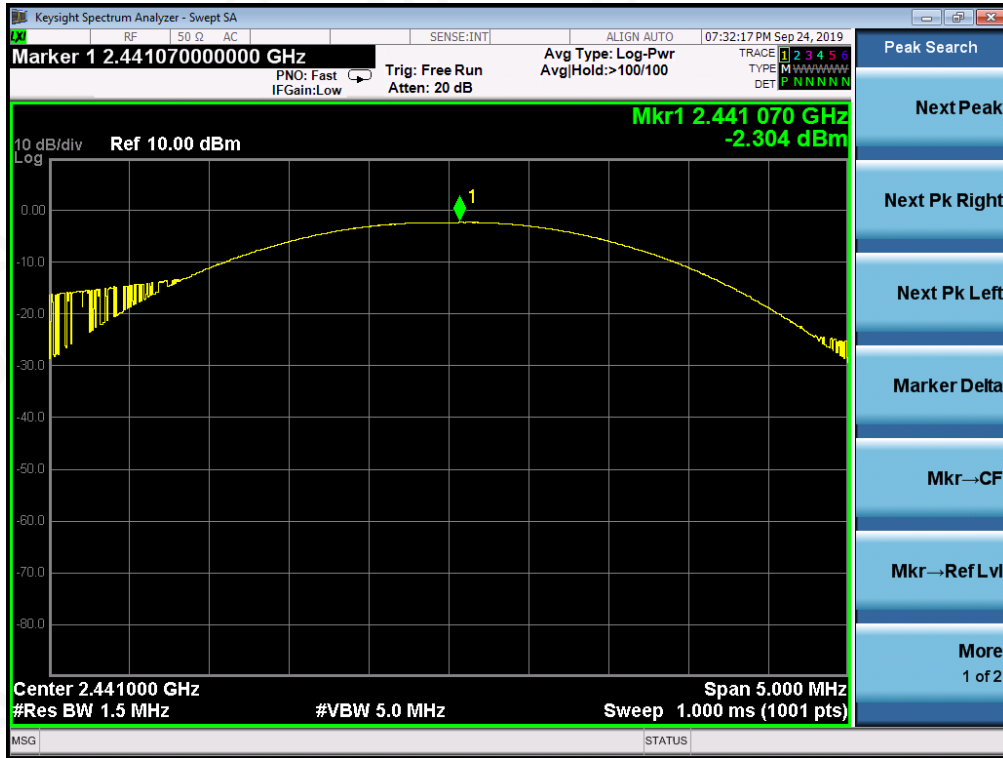

CH78

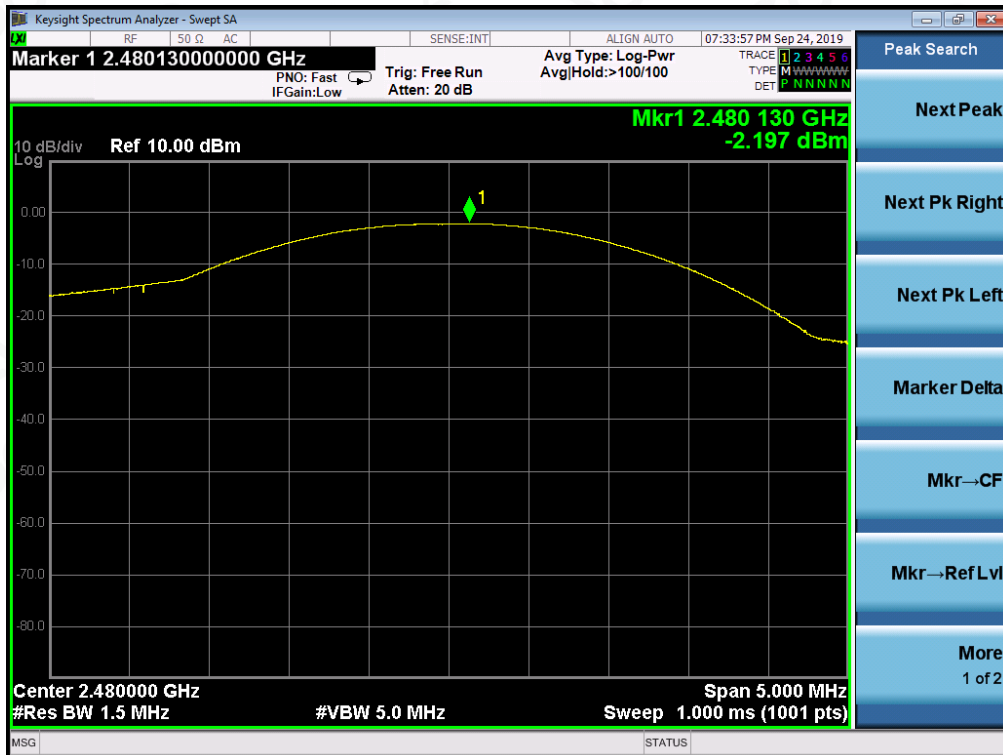

Attestation of Global Compliance

Attestation of Global Compliance(Shenzhen)Co.,Ltd.
Add: 2/F., Building 2, Sanwei Chaxi Industrial Park, Sanwei Community,
Hangcheng Street, Bao'an District, Shenzhen, Guangdong, China
Tel: +86-755 2523 4088 E-mail: agc@agc-cert.com Service Hotline:400 089 2118

8. 20DB BANDWIDTH

8.1. MEASUREMENT PROCEDURE

1. Connect EUT RF output port to the Spectrum Analyzer through an RF attenuator
2. Set the EUT Work on the top, the middle and the bottom operation frequency individually.
3. Set Span = approximately 2 to 5 times the 20 dB bandwidth, centered on a hoping channel
The nominal IF filter bandwidth (3 dB RBW) shall be in the range of 1% to 5% of the OBW and video bandwidth (VBW) shall be approximately three times RBW; Sweep = auto; Detector function = peak
4. Set SPA Trace 1 Max hold, then View.

8.2. TEST SET-UP (BLOCK DIAGRAM OF CONFIGURATION)

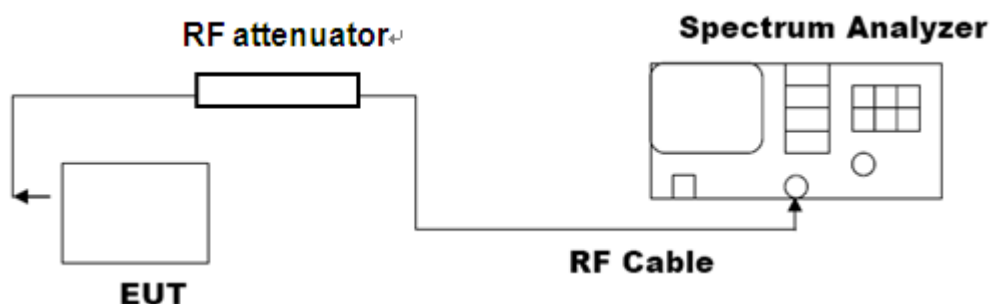

8.3. LIMITS AND MEASUREMENT RESULTS

MEASUREMENT RESULT FOR GFSK MOUDULATION			
Applicable Limits	Measurement Result		
	Test Data (MHz)		Criteria
N/A	Low Channel	0.8454	PASS
	Middle Channel	0.8106	PASS
	High Channel	0.8531	PASS



TEST PLOT OF BANDWIDTH FOR LOW CHANNEL

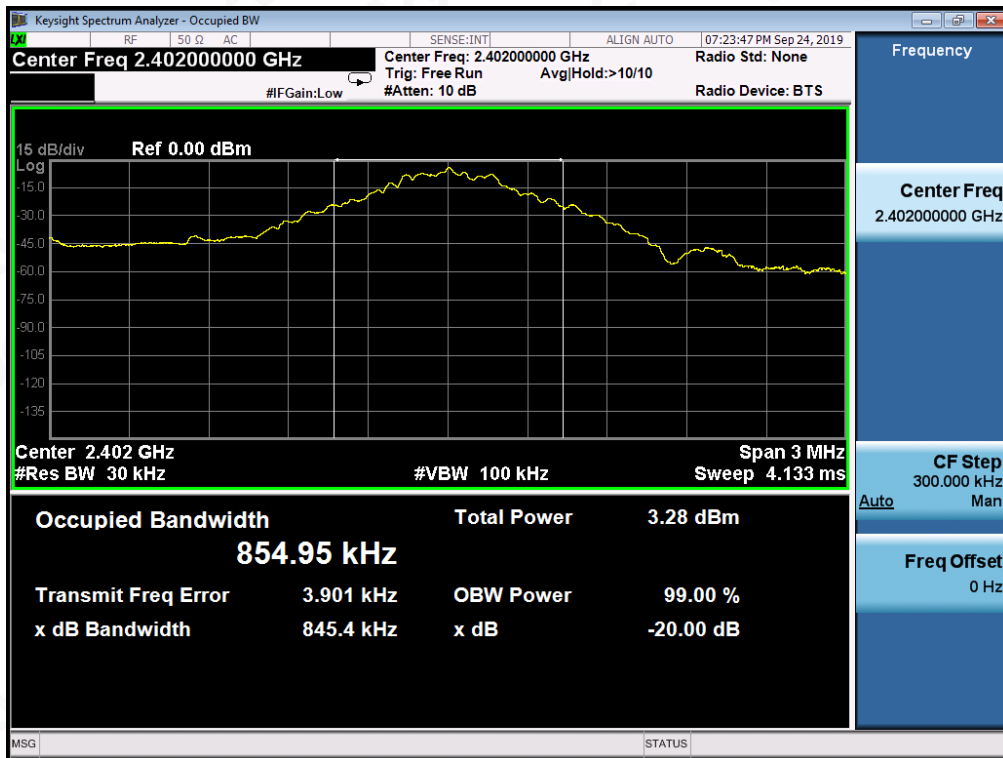

TEST PLOT OF BANDWIDTH FOR MIDDLE CHANNEL

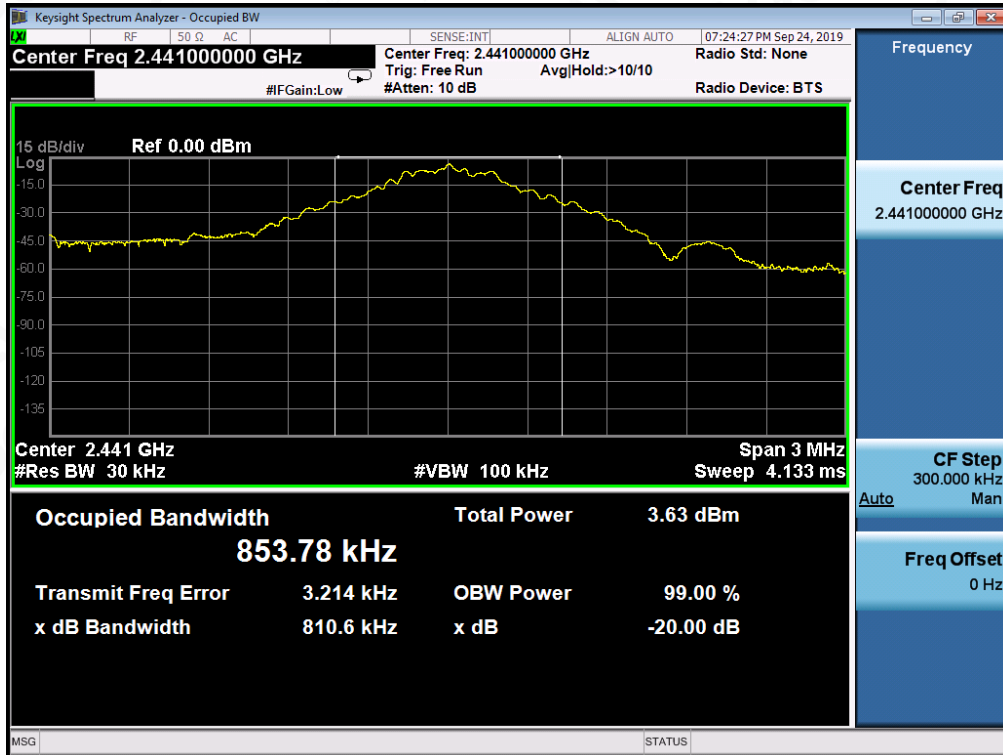

TEST PLOT OF BANDWIDTH FOR HIGH CHANNEL

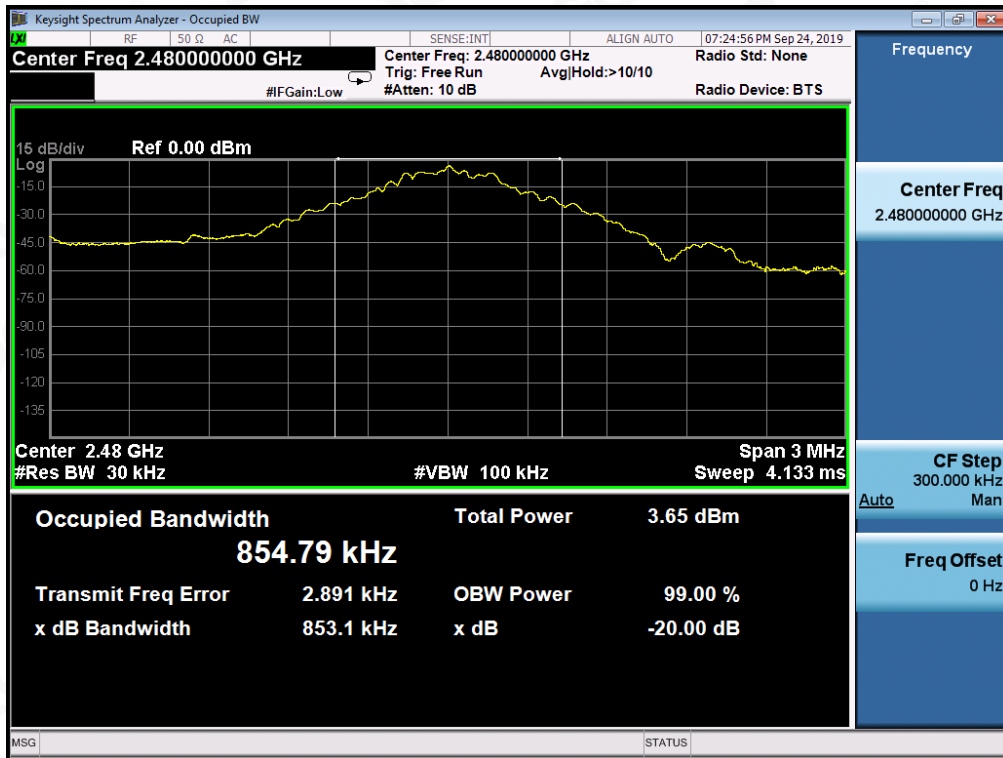

MEASUREMENT RESULT FOR II /4-DQPSK MODULATION			
Applicable Limits	Measurement Result		
	Test Data (MHz)		Criteria
N/A	Low Channel	1.241	PASS
	Middle Channel	1.236	PASS
	High Channel	1.237	PASS

TEST PLOT OF BANDWIDTH FOR LOW CHANNEL

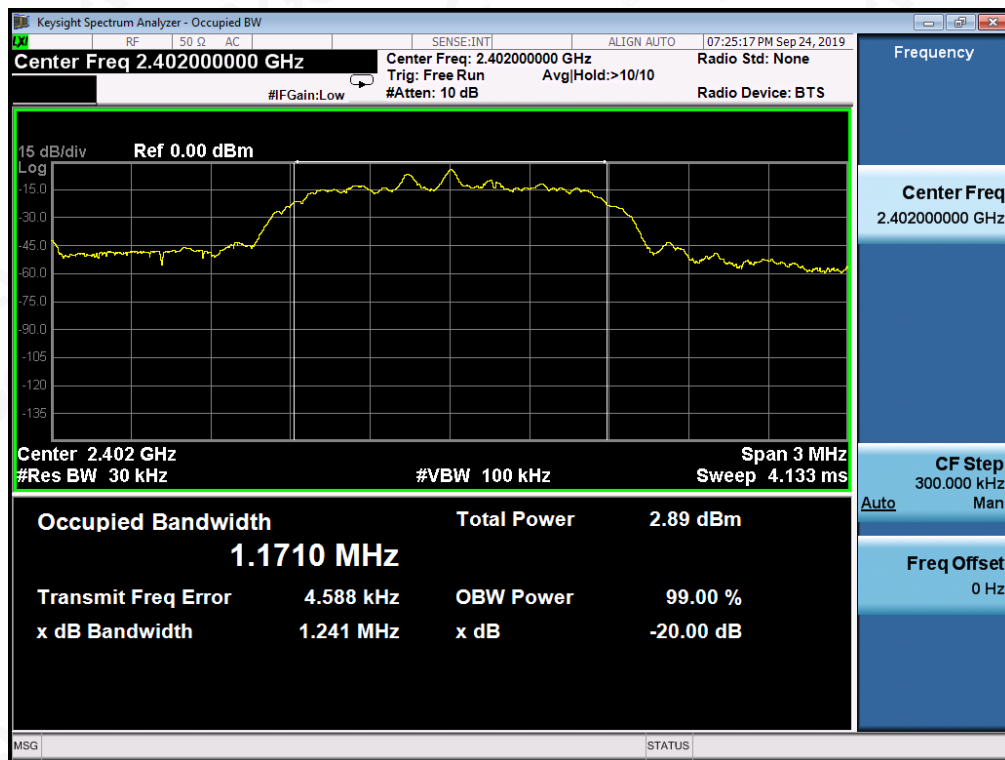

TEST PLOT OF BANDWIDTH FOR MIDDLE CHANNEL

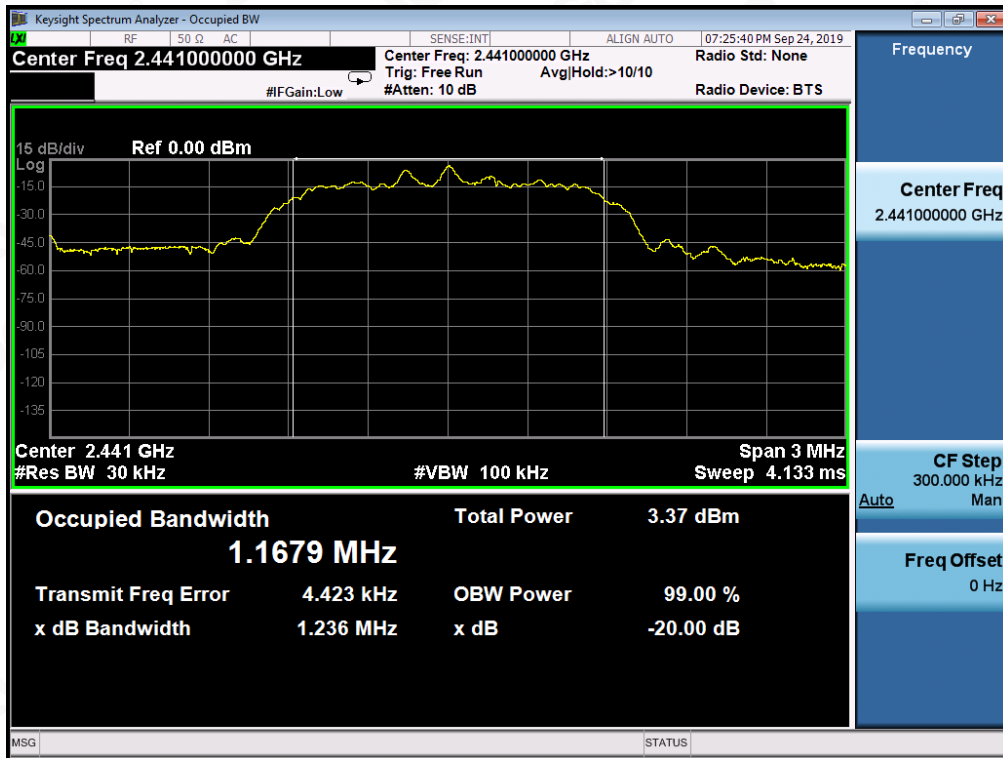

TEST PLOT OF BANDWIDTH FOR HIGH CHANNEL

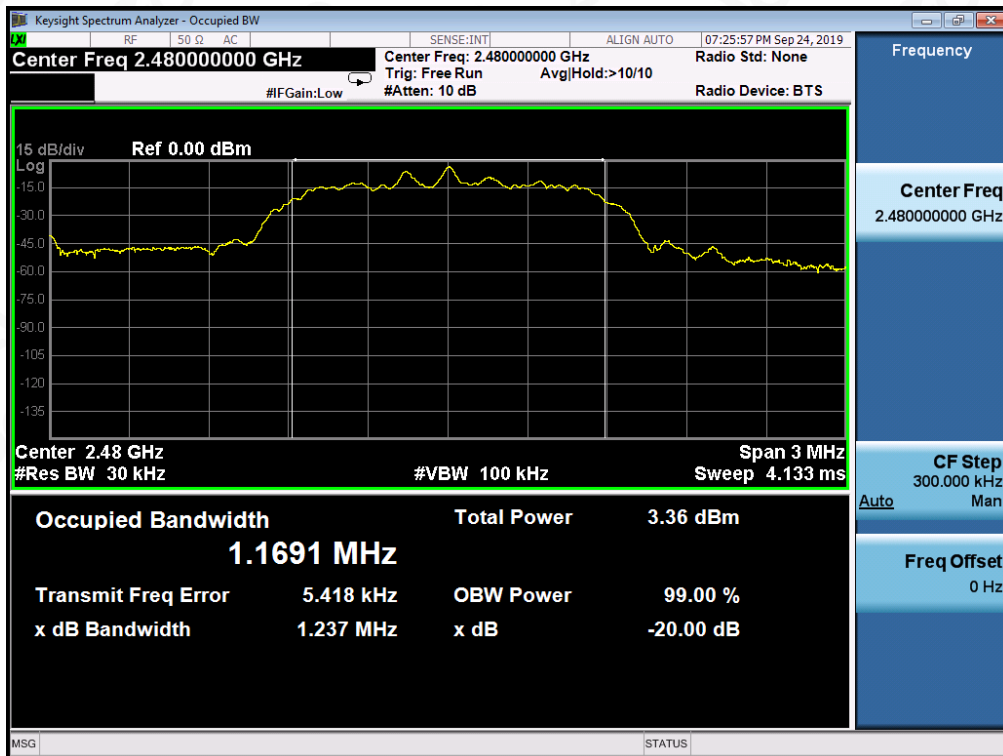

9. CONDUCTED SPURIOUS EMISSION

9.1. MEASUREMENT PROCEDURE

1. Connect EUT RF output port to the Spectrum Analyzer through an RF attenuator
2. Set the EUT Work on the top, the Middle and the bottom operation frequency individually.
3. Set the Span = wide enough to capture the peak level of the in-band emission and all spurious emissions from the lowest frequency generated in the EUT up through the 10th harmonic.
RBW = 100 kHz; VBW= 300 kHz; Sweep = auto; Detector function = peak.
4. Set SPA Trace 1 Max hold, then View.

9.2. TEST SET-UP (BLOCK DIAGRAM OF CONFIGURATION)

The same as described in section 8.2

9.3. MEASUREMENT EQUIPMENT USED

The same as described in section 6

9.4. LIMITS AND MEASUREMENT RESULT

LIMITS AND MEASUREMENT RESULT		
Applicable Limits	Measurement Result	
	Test Data	Criteria
In any 100 KHz Bandwidth Outside the frequency band in which the spread spectrum intentional radiator is operating, the radio frequency power that is produce by the intentional radiator shall be at least 20 dB below that in 100KHz bandwidth within the band that contains the highest level of the desired power. In addition, radiation emissions which fall in the restricted bands, as defined in §15.205(a), must also comply with the radiated emission limits specified in§15.209(a)	At least -20dBc than the limit Specified on the BOTTOM Channel	PASS
	At least -20dBc than the limit Specified on the TOP Channel	PASS



TEST RESULT FOR ENTIRE FREQUENCY RANGE
TEST PLOT OF OUT OF BAND EMISSIONS WITH THE WORST CASE
OF $\pi/4$ -DQPSK MODULATION IN LOW CHANNEL

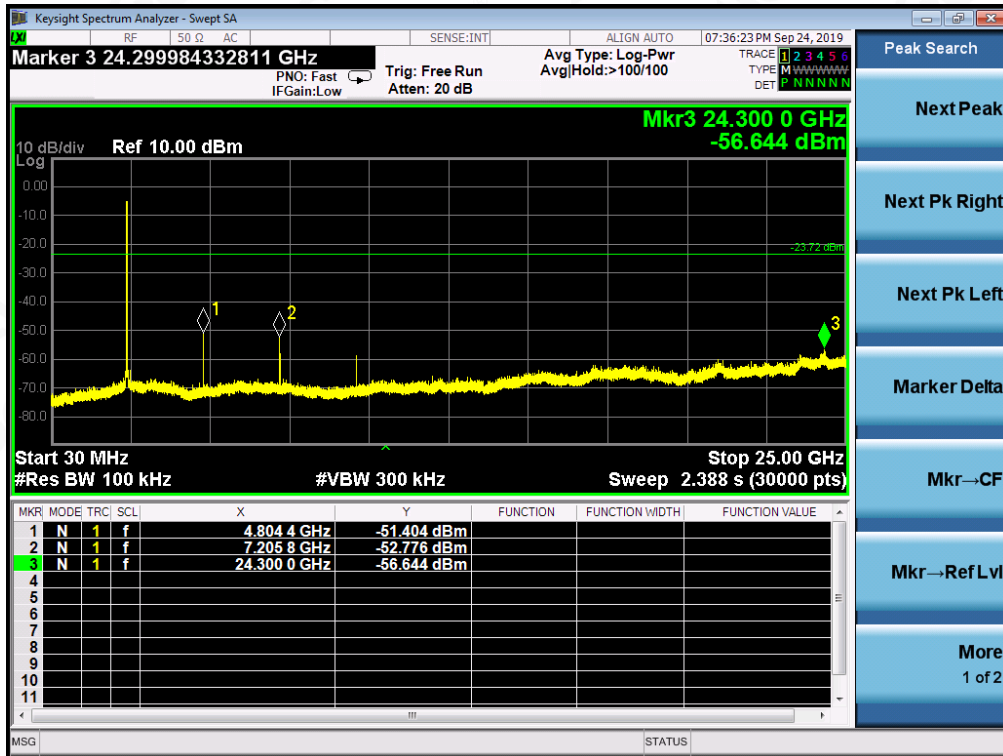
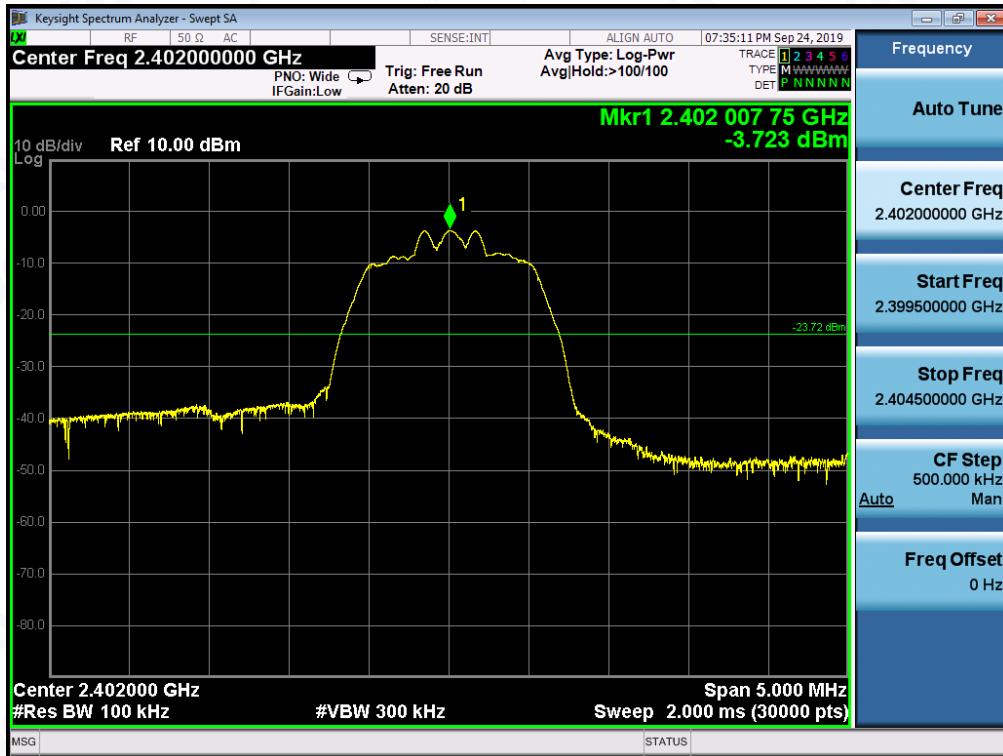

Attestation of Global Compliance

Attestation of Global Compliance(Shenzhen)Co.,Ltd.

Add: 2/F., Building 2, Sanwei Chaxi Industrial Park, Sanwei Community,
Hangcheng Street, Bao'an District, Shenzhen, Guangdong, China

Tel: +86-755 2523 4088

E-mail: agc@agc-cert.com

Service Hotline: 400 089 2118

TEST PLOT OF OUT OF BAND EMISSIONS
OF $\pi/4$ -DQPSK MODULATION IN MIDDLE CHANNEL

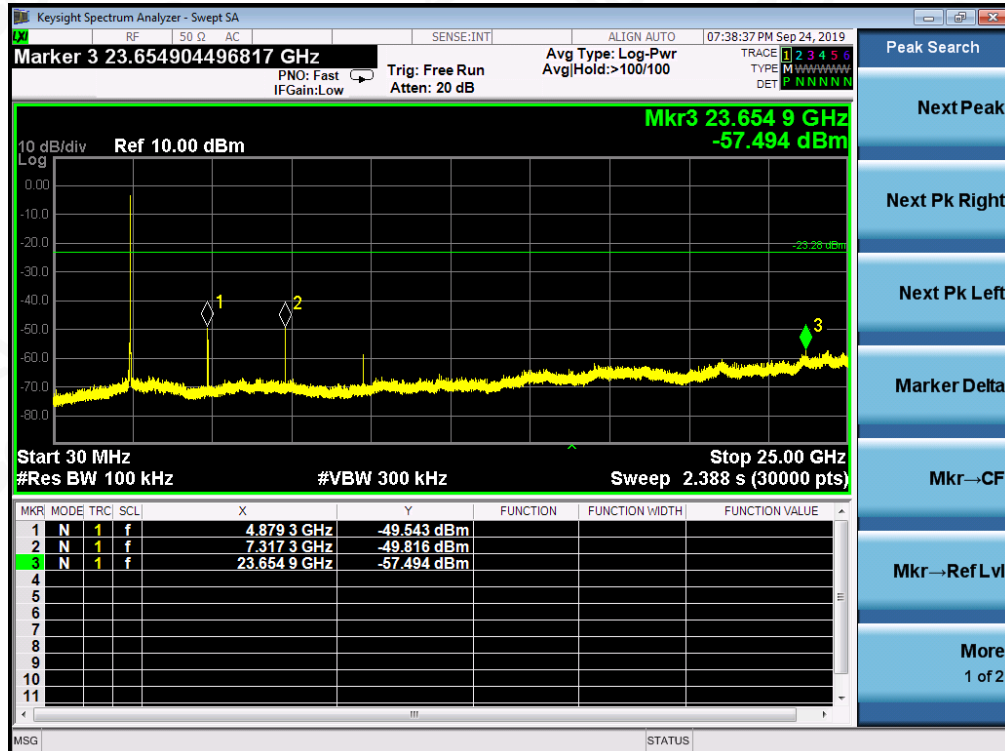

Attestation of Global Compliance

Attestation of Global Compliance(Shenzhen)Co.,Ltd.

Add: 2/F., Building 2, Sanwei Chaxi Industrial Park, Sanwei Community,
Hangcheng Street, Bao'an District, Shenzhen, Guangdong, China

Tel: +86-755 2523 4088

E-mail: agc@agc-cert.com

Service Hotline: 400 089 2118

TEST PLOT OF OUT OF BAND EMISSIONS
OF $\pi/4$ -DQPSK MODULATION IN HIGH CHANNEL

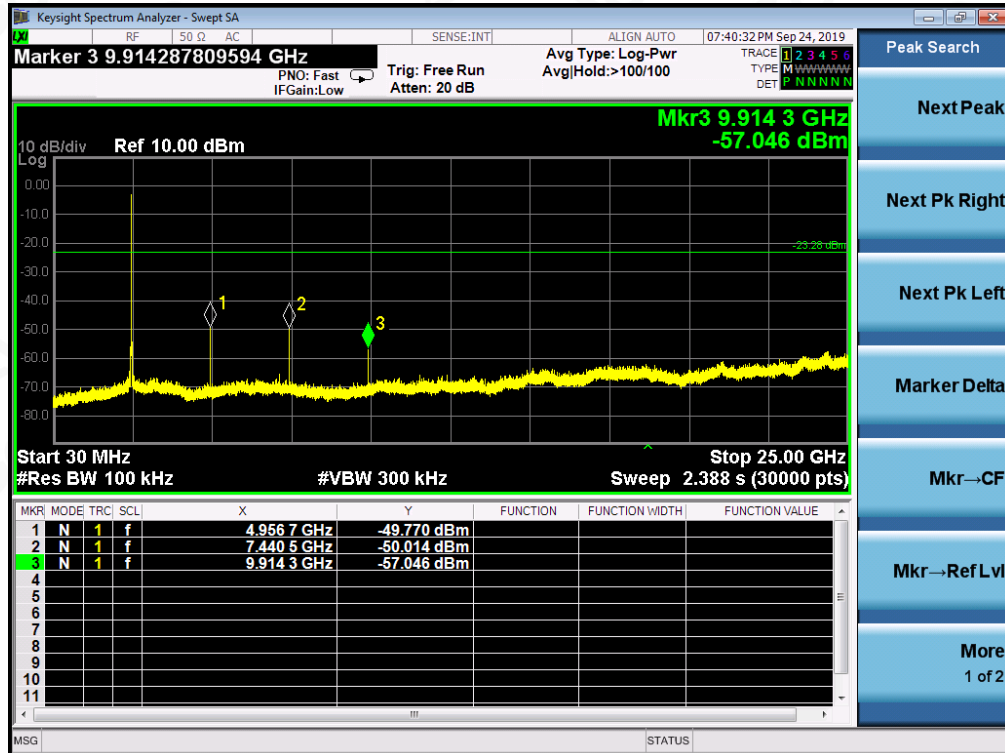

Note: The peak emissions without marker on the above plots are fundamental wave and need not to compare with the limit. The $\pi/4$ -DQPSK modulation is the worst case and only those data recorded in the report.

TEST RESULT FOR BAND EDGE
GFSK MODULATION IN LOW CHANNEL
Hopping off

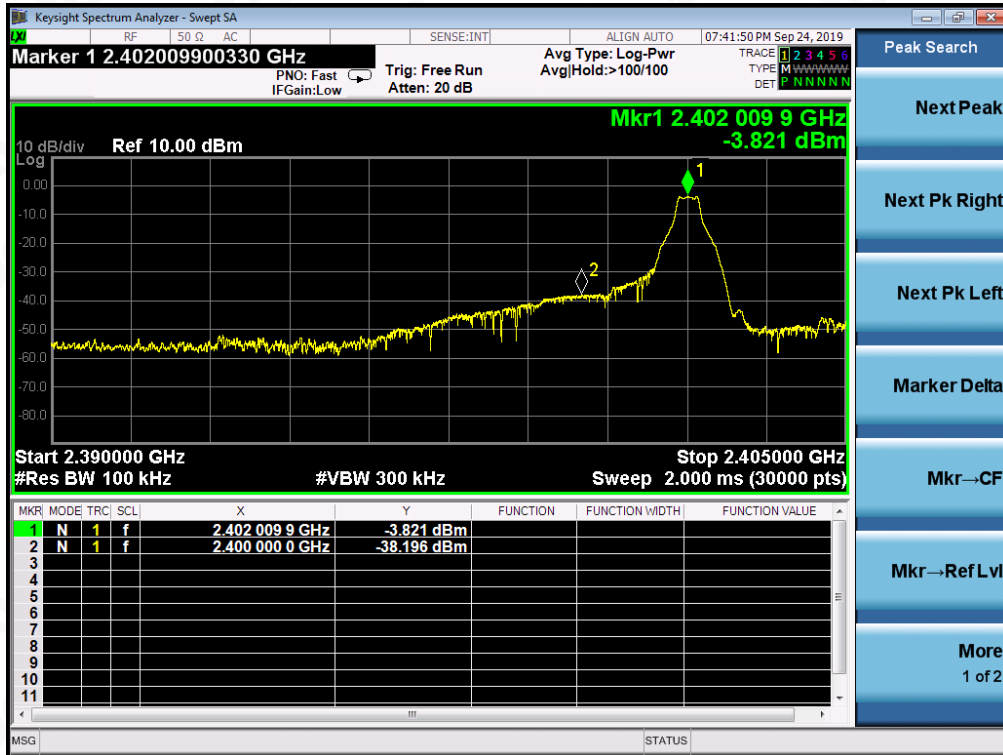

Hopping on

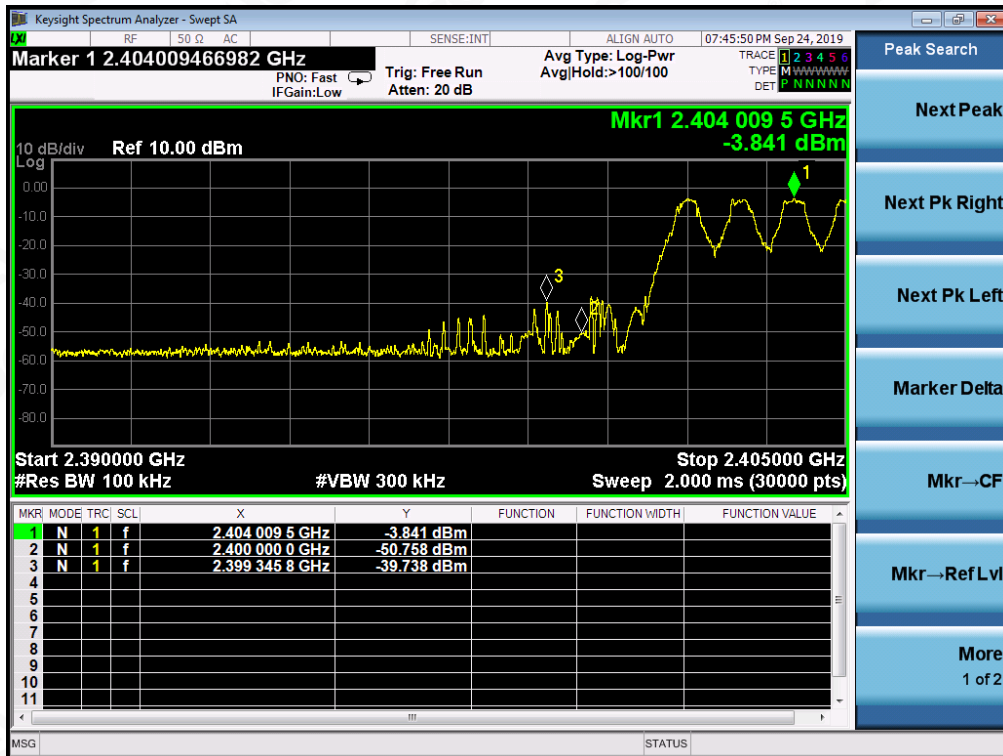

GFSK MODULATION IN HIGH CHANNEL Hopping off

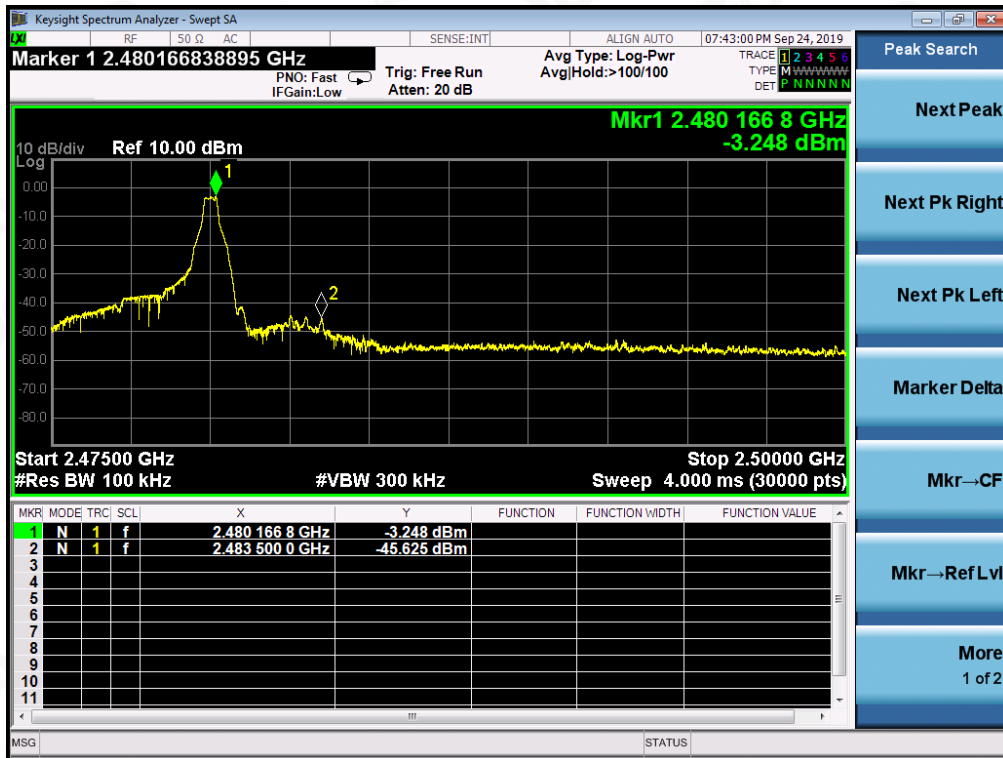

Hopping on

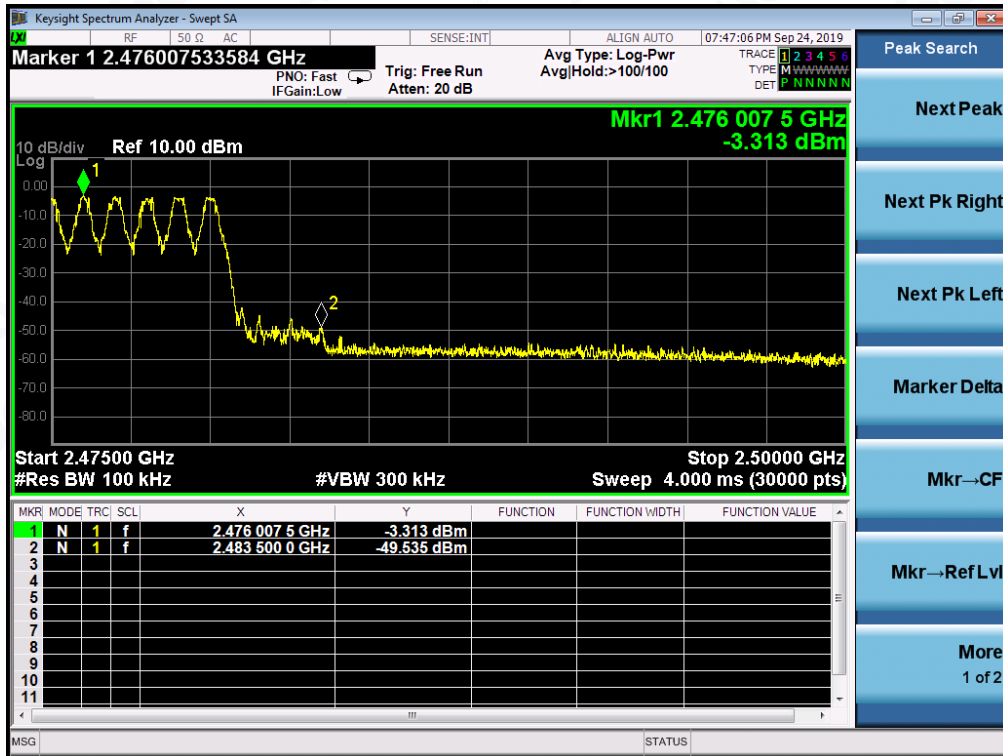

π /4-DQPSK MODULATION IN LOW CHANNEL
Hopping off

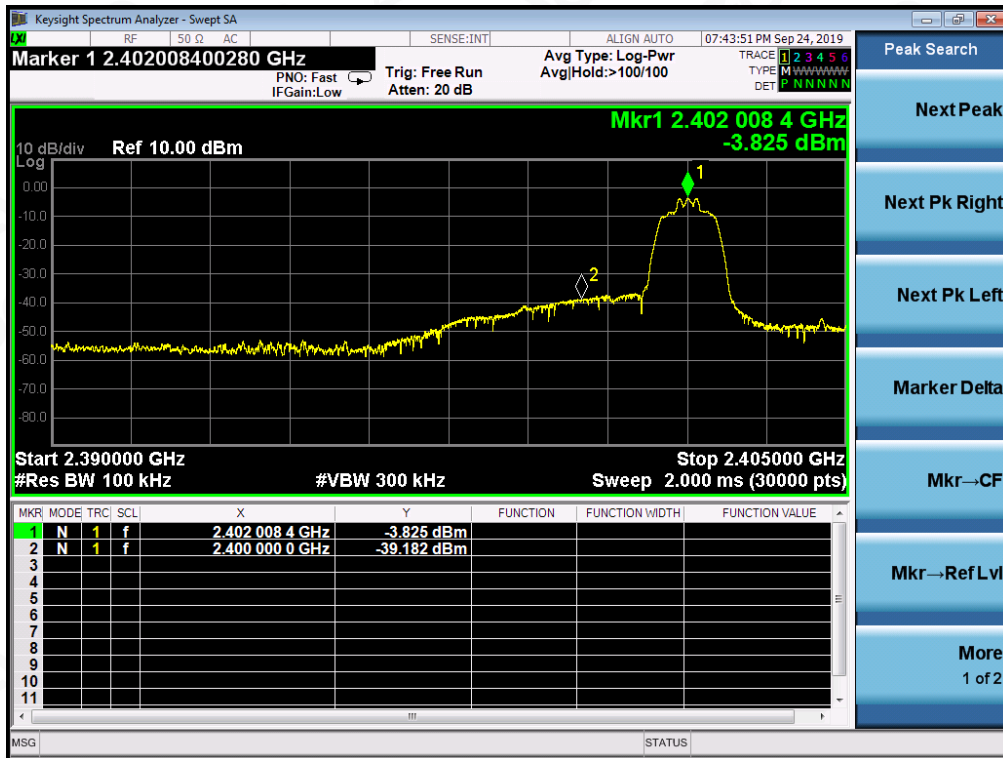

Hopping on

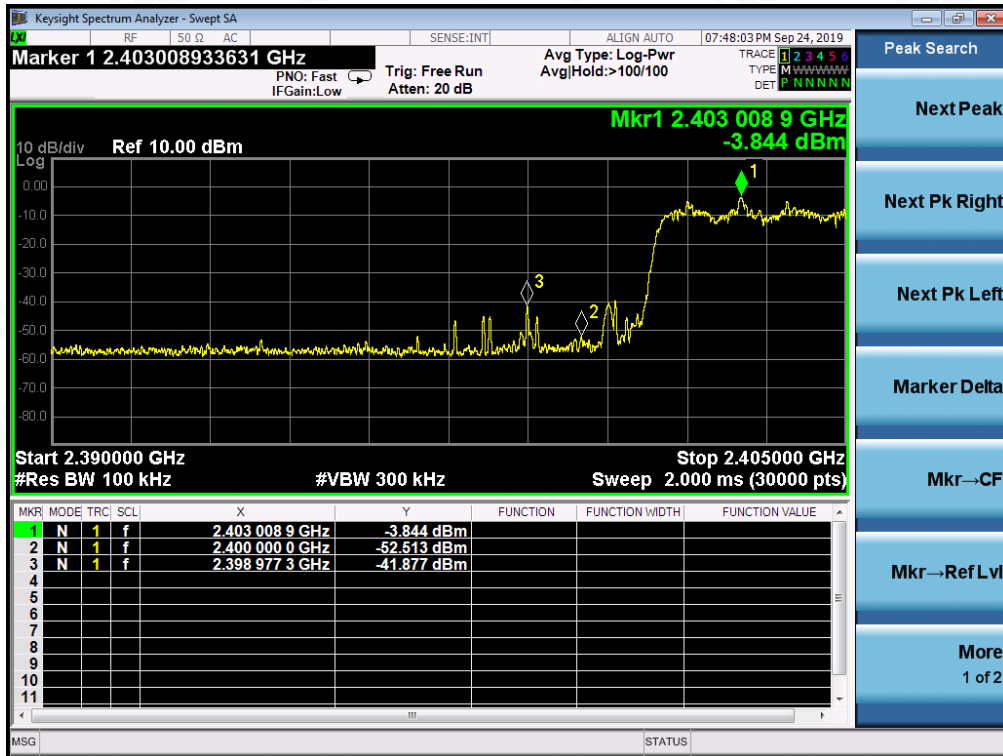

Attestation of Global Compliance

Attestation of Global Compliance(Shenzhen)Co.,Ltd.

Add: 2/F., Building 2, Sanwei Chaxi Industrial Park, Sanwei Community,
Hangcheng Street, Bao'an District, Shenzhen, Guangdong, China

Tel: +86-755 2523 4088

E-mail: agc@agc-cert.com

Service Hotline:400 089 2118

π /4-DQPSK MODULATION IN HIGH CHANNEL
Hopping off

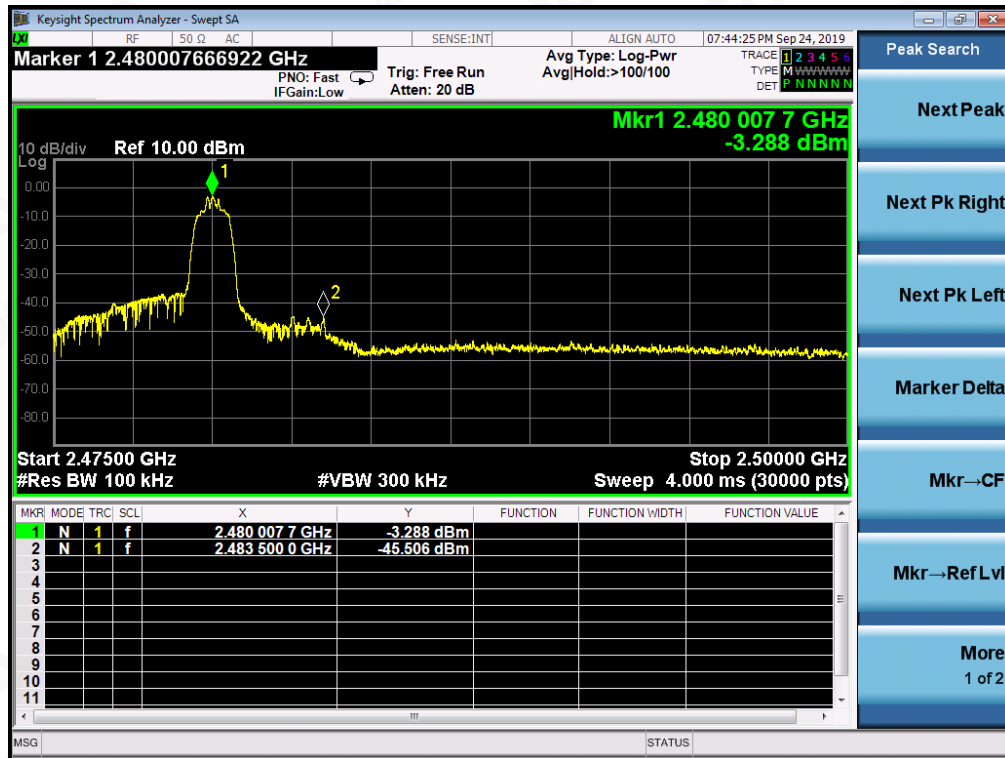

Hopping on

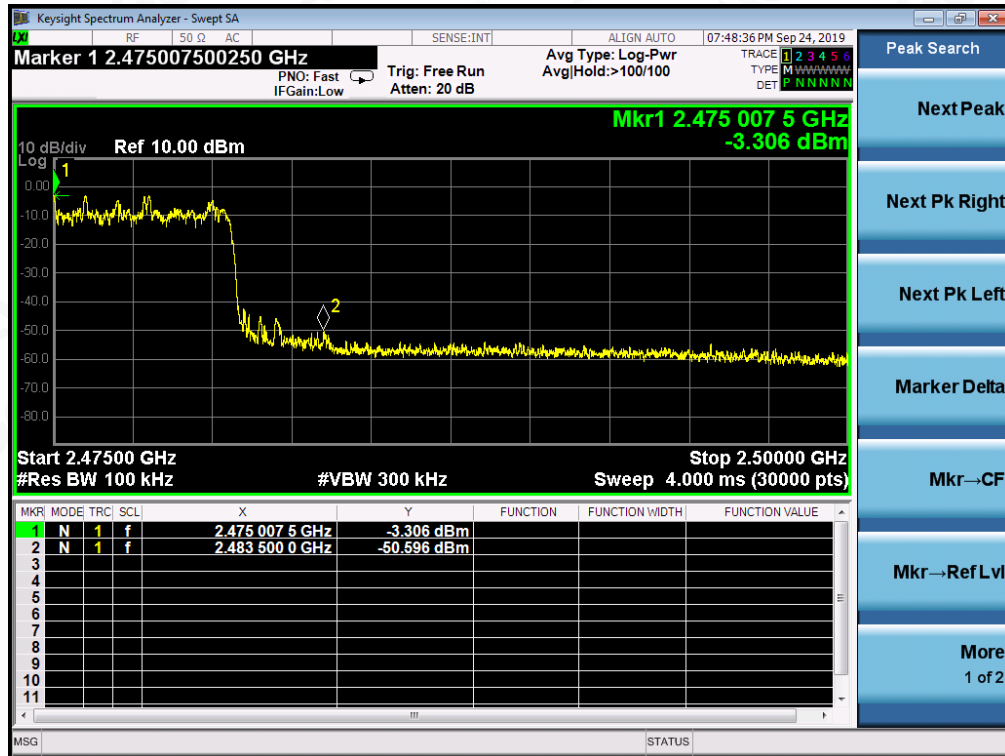

Attestation of Global Compliance

Attestation of Global Compliance(Shenzhen)Co.,Ltd.
Add: 2/F., Building 2, Sanwei Chaxi Industrial Park, Sanwei Community,
Hangcheng Street, Bao'an District, Shenzhen, Guangdong, China
Tel: +86-755 2523 4088 E-mail: agc@agc-cert.com Service Hotline:400 089 2118

10. RADIATED EMISSION

10.1. MEASUREMENT PROCEDURE

1. The EUT was placed on the top of the turntable 0.8 or 1.5 meter above ground. The phase center of the receiving antenna mounted on the top of a height-variable antenna tower was placed 3 meters far away from the turntable.
2. Power on the EUT and all the supporting units. The turntable was rotated by 360 degrees to determine the position of the highest radiation.
3. The height of the broadband receiving antenna was varied between one meter and four meters above ground to find the maximum emissions field strength of both horizontal and vertical polarization.
4. For each suspected emissions, the antenna tower was scan (from 1 M to 4 M) and then the turntable was rotated (from 0 degree to 360 degrees) to find the maximum reading.
5. Set the test-receiver system to Peak or CISPR quasi-peak Detect Function with specified bandwidth under Maximum Hold Mode.
6. For emissions above 1GHz, use 1MHz RBW and 3MHz VBW for peak reading. Place the measurement antenna away from each area of the EUT determined to be a source of emissions at the specified measurement distance, while keeping the measurement antenna aimed at the source of emissions at each frequency of significant emissions, with polarization oriented for maximum response. The measurement antenna may have to be higher or lower than the EUT, depending on the radiation pattern of the emission and staying aimed at the emission source for receiving the maximum signal. The final measurement antenna elevation shall be that which maximizes the emissions. The measurement antenna elevation for maximum emissions shall be restricted to a range of heights of from 1 m to 4 m above the ground or reference ground plane.
7. When the radiated emissions limits are expressed in terms of the average value of the emissions, and pulsed operation is employed, the measurement field strength shall be determined by averaging over one complete pulse train, including blanking intervals, as long as the pulse train does not exceed 0.1 seconds. As an alternative (provided the transmitter operates for longer than 0.1 seconds) or in cases where the pulse train exceeds 0.1 seconds, the measured field strength shall be determined from the average absolute voltage during a 0.1 second interval during which the field strength is at its maximum values.
8. If the emissions level of the EUT in peak mode was 3 dB lower than the average limit specified, then testing will be stopped and peak values of EUT will be reported, otherwise, the emissions which do not have 3 dB margin will be repeated one by one using the quasi-peak method for below 1GHz.
9. For testing above 1GHz, the emissions level of the EUT in peak mode was lower than average limit (that means the emissions level in peak mode also complies with the limit in average mode), then testing will be stopped and peak values of EUT will be reported, otherwise, the emissions will be measured in average mode again and reported.
10. In case the emission is lower than 30MHz, loop antenna has to be used for measurement and the recorded data should be QP measured by receiver. High - Low scan is not required in this case.

The following table is the setting of spectrum analyzer and receiver.

Spectrum Parameter	Setting
Start ~Stop Frequency	9KHz~150KHz/RB 200Hz for QP
Start ~Stop Frequency	150KHz~30MHz/RB 9KHz for QP
Start ~Stop Frequency	30MHz~1000MHz/RB 120KHz for QP
Start ~Stop Frequency	1GHz~26.5GHz 1MHz/3MHz for Peak, 1MHz/3MHz for Average

Receiver Parameter	Setting
Start ~Stop Frequency	9KHz~150KHz/RB 200Hz for QP
Start ~Stop Frequency	150KHz~30MHz/RB 9KHz for QP
Start ~Stop Frequency	30MHz~1000MHz/RB 120KHz for QP



10.2. TEST SETUP

Radiated Emission Test-Setup Frequency Below 30MHz

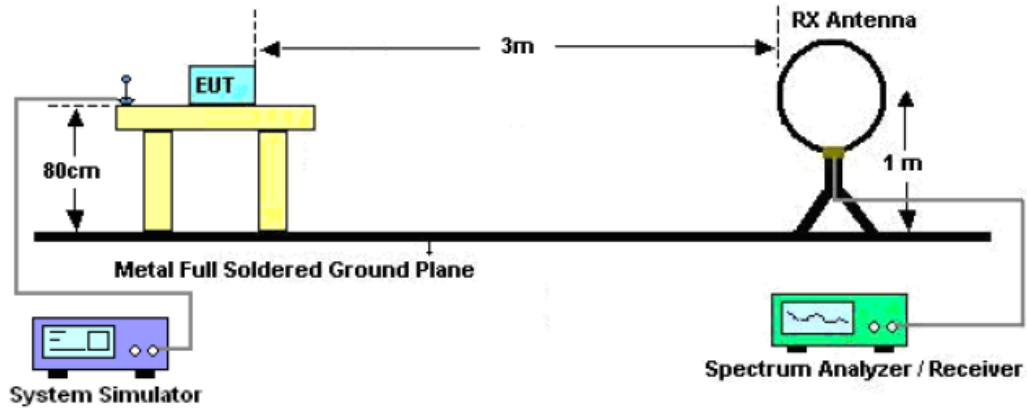

RADIATED EMISSION TEST SETUP 30MHz-1000MHz

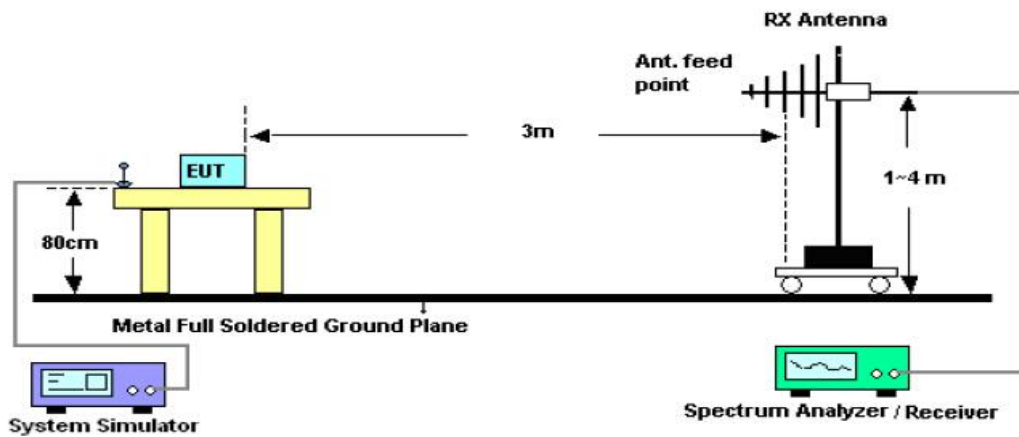

RADIATED EMISSION TEST SETUP ABOVE 1000MHz

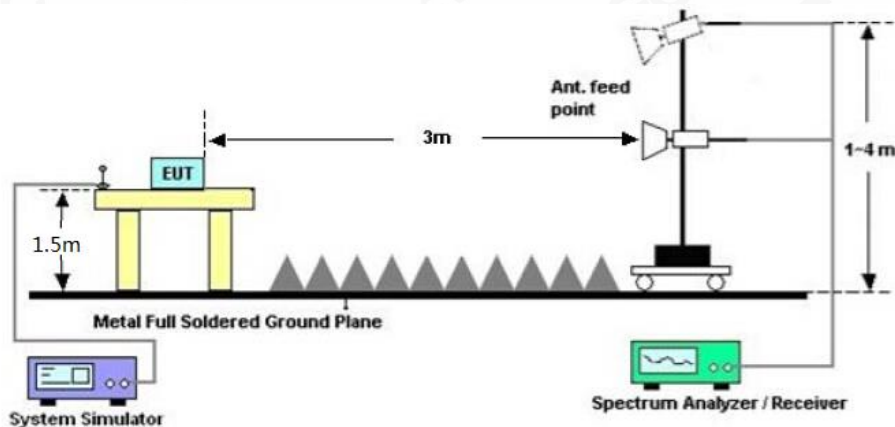

10.3. LIMITS AND MEASUREMENT RESULT

15.209 Limit in the below table has to be followed

Frequencies (MHz)	Field Strength (micorvolts/meter)	Measurement Distance (meters)
0.009~0.490	2400/F(KHz)	300
0.490~1.705	24000/F(KHz)	30
1.705~30.0	30	30
30~88	100	3
88~216	150	3
216~960	200	3
Above 960	500	3

Note: All modes were tested For restricted band radiated emission, the test records reported below are the worst result compared to other modes.

10.4. TEST RESULT

RADIATED EMISSION BELOW 30MHZ

No emission found between lowest internal used/generated frequencies to 30MHz.



RADIATED EMISSION BELOW 1GHZ

EUT	Bluetooth Earphone	Model Name	BT985
Temperature	25°C	Relative Humidity	55.4%
Pressure	960hPa	Test Voltage	Normal Voltage
Test Mode	Mode 6	Antenna	Horizontal

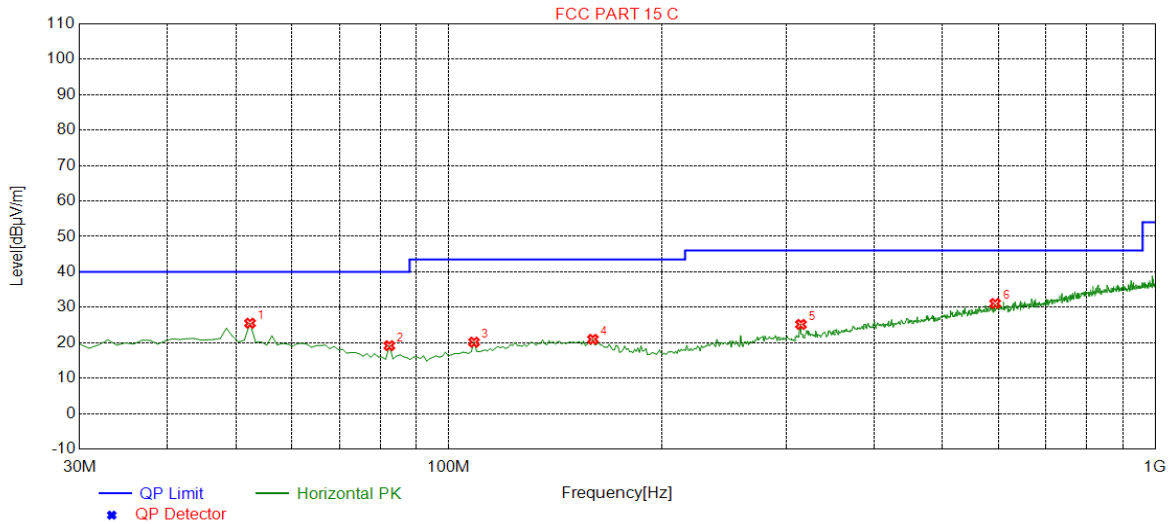

NO.	Freq. [MHz]	Level [dBuV/m]	Factor [dB]	Limit [dBuV/m]	Margin [dB]	Height [cm]	Angle [°]	Polarity
1	52.3100	25.51	14.49	40.00	14.49	150	256	Horizontal
2	82.3800	19.17	10.17	40.00	20.83	150	34	Horizontal
3	108.5700	20.16	12.27	43.50	23.34	150	117	Horizontal
4	159.9800	20.97	14.94	43.50	22.53	100	4	Horizontal
5	315.1800	25.17	16.48	46.00	20.83	100	89	Horizontal
6	593.5700	31.07	24.20	46.00	14.93	100	324	Horizontal

RESULT: PASS



Attestation of Global Compliance

Attestation of Global Compliance(Shenzhen)Co.,Ltd.
Add: 2/F., Building 2, Sanwei Chaxi Industrial Park, Sanwei Community,
Hangcheng Street, Bao'an District, Shenzhen, Guangdong, China
Tel: +86-755 2523 4088 E-mail: agc@agc-cert.com Service Hotline: 400 089 2118

EUT	Bluetooth Earphone	Model Name	BT985
Temperature	25°C	Relative Humidity	55.4%
Pressure	960hPa	Test Voltage	Normal Voltage
Test Mode	Mode 6	Antenna	Vertical

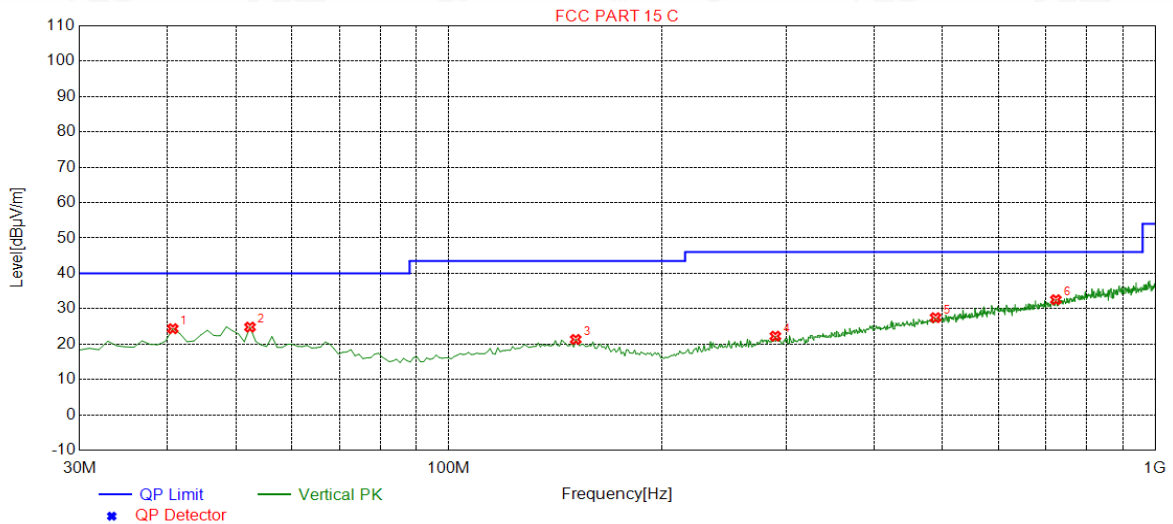

NO.	Freq [MHz]	Level [dBuV/m]	Factor [dB]	Limit [dBuV/m]	Margin [dB]	Height [cm]	Angle [°]	Polarity
1	40.6700	24.35	14.91	40.00	15.65	100	260	Vertical
2	52.3100	24.80	14.49	40.00	15.20	100	74	Vertical
3	151.2500	21.32	14.89	43.50	22.18	100	359	Vertical
4	289.9600	22.24	16.11	46.00	23.76	100	70	Vertical
5	488.8100	27.48	21.92	46.00	18.52	100	46	Vertical
6	723.5500	32.56	26.54	46.00	13.44	100	9	Vertical

RESULT: PASS

Note: 1. Factor=Antenna Factor + Cable loss, Margin=Measurement-Limit.

2. All test modes had been pre-tested. The mode 6 is the worst case and recorded in the report.



Attestation of Global Compliance

Attestation of Global Compliance(Shenzhen)Co.,Ltd.

Add: 2/F., Building 2, Sanwei Chaxi Industrial Park, Sanwei Community,
Hangcheng Street, Bao'an District, Shenzhen, Guangdong, China

Tel: +86-755 2523 4088

E-mail: agc@agc-cert.com

Service Hotline: 400 089 2118

RADIATED EMISSION ABOVE 1GHZ

EUT	Bluetooth Earphone	Model Name	BT985
Temperature	25°C	Relative Humidity	55.4%
Pressure	960hPa	Test Voltage	Normal Voltage
Test Mode	Mode 4	Antenna	Horizontal

Frequency (MHz)	Meter Reading (dBµV)	Factor (dB)	Emission Level (dBµV/m)	Limits (dBµV/m)	Margin (dB)	Value Type
4804.000	54.91	0.08	54.99	74	-19.01	peak
4804.000	45.74	0.08	45.82	54	-8.18	AVG
7206.000	52.64	2.21	54.85	74	-19.15	peak
7206.000	44.88	2.21	47.09	54	-6.91	AVG

Remark:
Factor = Antenna Factor + Cable Loss – Pre-amplifier.

EUT	Bluetooth Earphone	Model Name	BT985
Temperature	25°C	Relative Humidity	55.4%
Pressure	960hPa	Test Voltage	Normal Voltage
Test Mode	Mode 4	Antenna	Vertical

Frequency (MHz)	Meter Reading (dBµV)	Factor (dB)	Emission Level (dBµV/m)	Limits (dBµV/m)	Margin (dB)	Value Type
4804.000	55.79	0.08	55.87	74	-18.13	peak
4804.000	45.42	0.08	45.5	54	-8.5	AVG
7206.000	53.66	2.21	55.87	74	-18.13	peak
7206.000	43.72	2.21	45.93	54	-8.07	AVG

Remark:
Factor = Antenna Factor + Cable Loss – Pre-amplifier.



EUT	Bluetooth Earphone	Model Name	BT985
Temperature	25°C	Relative Humidity	55.4%
Pressure	960hPa	Test Voltage	Normal Voltage
Test Mode	Mode 5	Antenna	Horizontal

Frequency (MHz)	Meter Reading (dBμV)	Factor (dB)	Emission Level (dBμV/m)	Limits (dBμV/m)	Margin (dB)	Value Type
4882.000	56.72	0.14	56.86	74	-17.14	peak
4882.000	46.88	0.14	47.02	54	-6.98	AVG
7323.000	54.99	2.36	57.35	74	-16.65	peak
7323.000	45.69	2.36	48.05	54	-5.95	AVG

Remark:
Factor = Antenna Factor + Cable Loss – Pre-amplifier.

EUT	Bluetooth Earphone	Model Name	BT985
Temperature	25°C	Relative Humidity	55.4%
Pressure	960hPa	Test Voltage	Normal Voltage
Test Mode	Mode 5	Antenna	Vertical

Frequency (MHz)	Meter Reading (dBμV)	Factor (dB)	Emission Level (dBμV/m)	Limits (dBμV/m)	Margin (dB)	Value Type
4882.000	55.43	0.14	55.57	74	-18.43	peak
4882.000	47.52	0.14	47.66	54	-6.34	AVG
7323.000	56.83	2.36	59.19	74	-14.81	peak
7323.000	46.74	2.36	49.1	54	-4.9	AVG

Remark:
Factor = Antenna Factor + Cable Loss – Pre-amplifier.

EUT	Bluetooth Earphone	Model Name	BT985
Temperature	25°C	Relative Humidity	55.4%
Pressure	960hPa	Test Voltage	Normal Voltage
Test Mode	Mode 6	Antenna	Horizontal

Frequency (MHz)	Meter Reading (dBμV)	Factor (dB)	Emission Level (dBμV/m)	Limits (dBμV/m)	Margin (dB)	Value Type
4960.000	57.52	0.22	57.74	74	-16.26	peak
4960.000	47.21	0.22	47.43	54	-6.57	AVG
7440.000	56.34	2.64	58.98	74	-15.02	peak
7440.000	46.21	2.64	48.85	54	-5.15	AVG

Remark:
Factor = Antenna Factor + Cable Loss – Pre-amplifier.

EUT	Bluetooth Earphone	Model Name	BT985
Temperature	25°C	Relative Humidity	55.4%
Pressure	960hPa	Test Voltage	Normal Voltage
Test Mode	Mode 6	Antenna	Vertical

Frequency (MHz)	Meter Reading (dBμV)	Factor (dB)	Emission Level (dBμV/m)	Limits (dBμV/m)	Margin (dB)	Value Type
4960.000	58.64	0.22	58.86	74	-15.14	peak
4960.000	48.01	0.22	48.23	54	-5.77	AVG
7440.000	57.57	2.64	60.21	74	-13.79	peak
7440.000	46.55	2.64	49.19	54	-4.81	AVG

Remark:
Factor = Antenna Factor + Cable Loss – Pre-amplifier.

RESULT: PASS

Note: Other emissions from 1G to 25 GHz are considered as ambient noise. No recording in the test report.
Factor = Antenna Factor + Cable loss - Amplifier gain, Over=Measure-Limit.

The “Factor” value can be calculated automatically by software of measurement system.

All test modes had been tested. The π/4-DQPSK modulation is the worst case and recorded in the report.



TEST RESULT FOR RESTRICTED BANDS REQUIREMENTS

EUT	Bluetooth Earphone	Model Name	BT985
Temperature	25°C	Relative Humidity	55.4%
Pressure	960hPa	Test Voltage	Normal Voltage
Test Mode	Mode 4	Antenna	Horizontal

PK

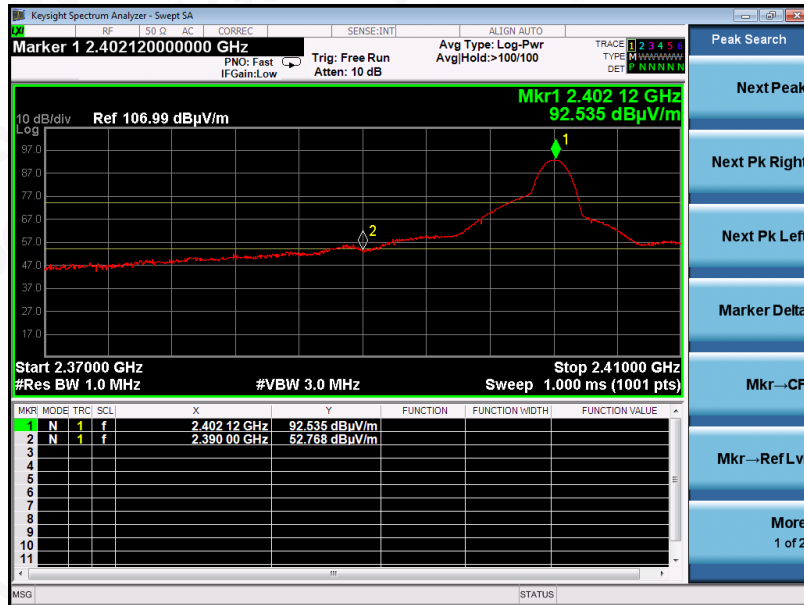

AV

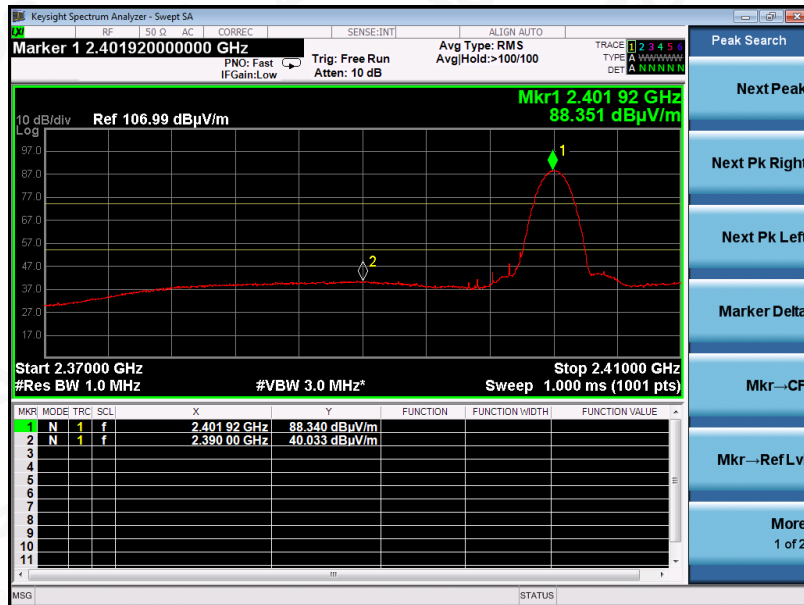

RESULT: PASS



Attestation of Global Compliance

Attestation of Global Compliance(Shenzhen)Co.,Ltd.
 Add: 2/F., Building 2, Sanwei Chaxi Industrial Park, Sanwei Community,
 Hangcheng Street, Bao'an District, Shenzhen, Guangdong, China
 Tel: +86-755 2523 4088 E-mail: agc@agc-cert.com Service Hotline:400 089 2118

EUT	Bluetooth Earphone	Model Name	BT985
Temperature	25°C	Relative Humidity	55.4%
Pressure	960hPa	Test Voltage	Normal Voltage
Test Mode	Mode 4	Antenna	Vertical

PK

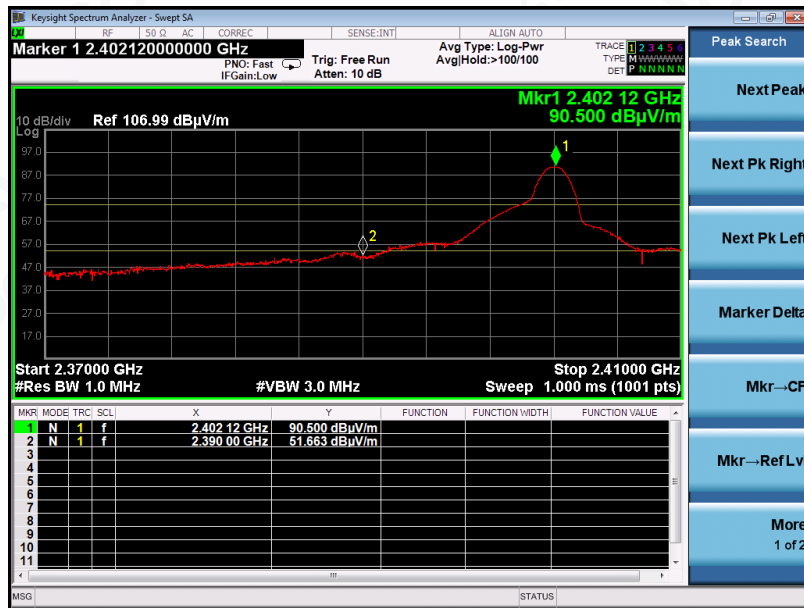

AV

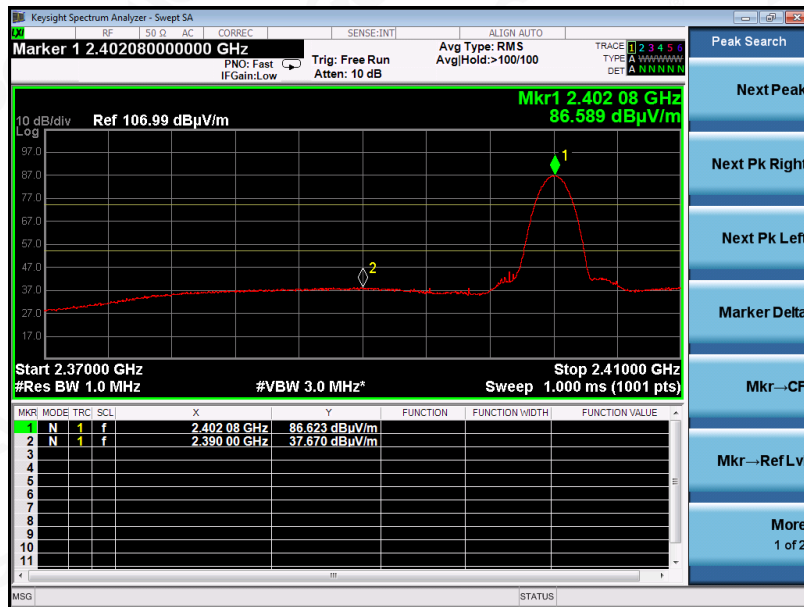

RESULT: PASS



Attestation of Global Compliance

Attestation of Global Compliance(Shenzhen)Co.,Ltd.
Add: 2/F., Building 2, Sanwei Chaxi Industrial Park, Sanwei Community,
Hangcheng Street, Bao'an District, Shenzhen, Guangdong, China
Tel: +86-755 2523 4088 E-mail: agc@agc-cert.com Service Hotline:400 089 2118

EUT	Bluetooth Earphone	Model Name	BT985
Temperature	25°C	Relative Humidity	55.4%
Pressure	960hPa	Test Voltage	Normal Voltage
Test Mode	Mode 6	Antenna	Horizontal

PK



AV

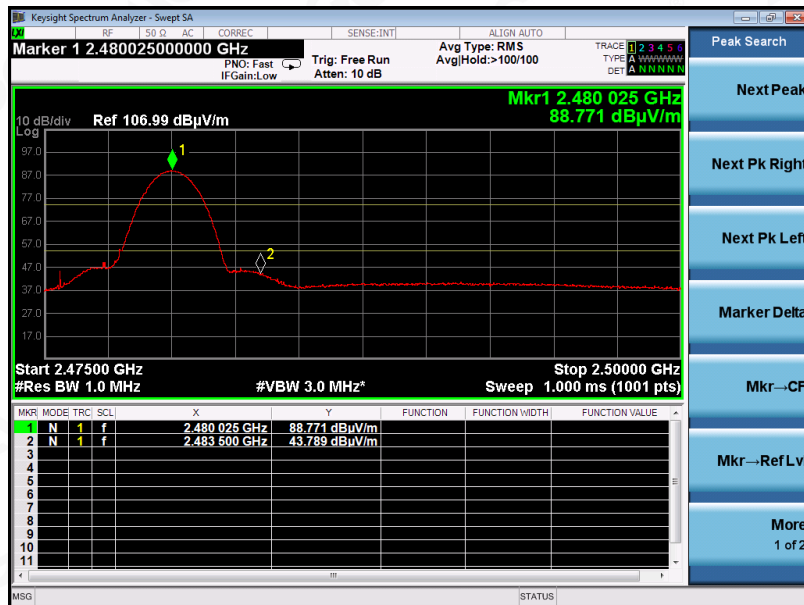

RESULT: PASS



Attestation of Global Compliance

Attestation of Global Compliance(Shenzhen)Co.,Ltd.

Add: 2/F., Building 2, Sanwei Chaxi Industrial Park, Sanwei Community,
Hangcheng Street, Bao'an District, Shenzhen, Guangdong, China

Tel: +86-755 2523 4088

E-mail: agc@agc-cert.com

Service Hotline: 400 089 2118

EUT	Bluetooth Earphone	Model Name	BT985
Temperature	25°C	Relative Humidity	55.4%
Pressure	960hPa	Test Voltage	Normal Voltage
Test Mode	Mode 6	Antenna	Vertical

PK



AV

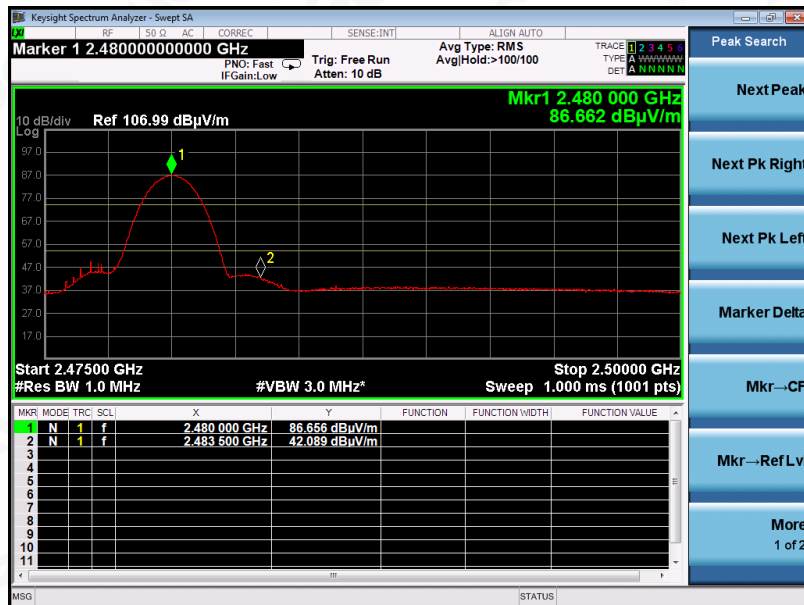

RESULT: PASS

Note: The factor had been edited in the “Input Correction” of the Spectrum Analyzer. So the Amplitude of test plots is equal to Reading level plus the Factor in dB. Use the A dB(µV) to represent the Amplitude. Use the F dB(µV/m) to represent the Field Strength. So A=F. All test modes had been pre-tested. The $\pi/4$ -DQPSK modulation is the worst case and recorded in the report.



Attestation of Global Compliance

Attestation of Global Compliance(Shenzhen)Co.,Ltd.

Add: 2/F., Building 2, Sanwei Chaxi Industrial Park, Sanwei Community,
Hangcheng Street, Bao'an District, Shenzhen, Guangdong, China

Tel: +86-755 2523 4088 E-mail: agc@agc-cert.com Service Hotline:400 089 2118

11. NUMBER OF HOPPING FREQUENCY

11.1. MEASUREMENT PROCEDURE

The EUT shall have its hopping function enabled. Use the following spectrum analyzer settings:

1. Span: The frequency band of operation. Depending on the number of channels the device supports, it may be necessary to divide the frequency range of operation across multiple spans, to allow the individual channels to be clearly seen.
2. RBW: To identify clearly the individual channels, set the RBW to less than 30% of the channel spacing or the 20 dB bandwidth, whichever is smaller.
3. VBW \geq RBW. Sweep: Auto. Detector function: Peak. Trace: Max hold.
4. Allow the trace to stabilize.

11.2. TEST SETUP (BLOCK DIAGRAM OF CONFIGURATION)

Same as described in section 8.2

11.3. MEASUREMENT EQUIPMENT USED

The same as described in section 6

11.4. LIMITS AND MEASUREMENT RESULT

TOTAL NO. OF HOPPING CHANNEL	LIMIT (NO. OF CH)	MEASUREMENT (NO. OF CH)	RESULT
	≥ 15	79	PASS

TEST PLOT FOR NO. OF TOTAL CHANNELS

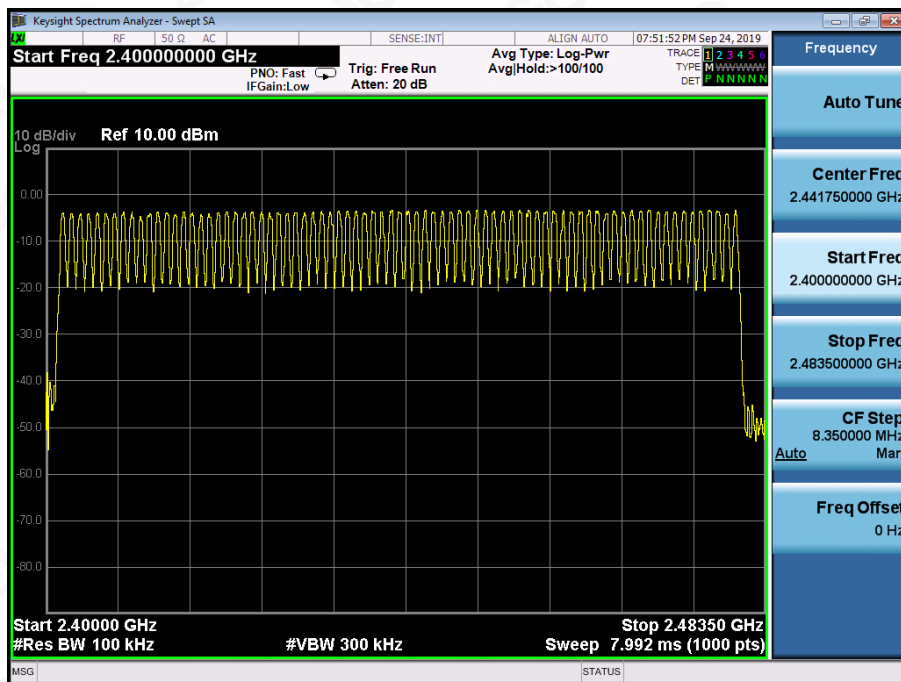

Note: The GFSK modulation is the worst case and recorded in the report.

12. TIME OF OCCUPANCY (DWELL TIME)

12.1. MEASUREMENT PROCEDURE

The EUT shall have its hopping function enabled. Use the following spectrum analyzer settings:

1. Span: Zero span, centered on a hopping channel.
2. RBW shall be \leq channel spacing and where possible RBW should be set $\gg 1 / T$, where T is the expected dwell time per channel.
3. Sweep: As necessary to capture the entire dwell time per hopping channel; where possible use a video trigger and trigger delay so that the transmitted signal starts a little to the right of the start of the plot. The trigger level might need slight adjustment to prevent triggering when the system hops on an adjacent channel; a second plot might be needed with a longer sweep time to show two successive hops on a channel.
4. Detector function: Peak. Trace: Max hold.
5. Use the marker-delta function to determine the transmit time per hop.
6. Repeat the measurement using a longer sweep time to determine the number of hops over the period specified in the requirements. The sweep time shall be equal to, or less than, the period specified in the requirements. Determine the number of hops over the sweep time and calculate the total number of hops in the period specified in the requirements, using the following equation:

$$(\text{Number of hops in the period specified in the requirements}) = (\text{number of hops on spectrum analyzer}) \times (\text{period specified in the requirements} / \text{analyzer sweep time})$$

7. The average time of occupancy is calculated from the transmit time per hop multiplied by the number of hops in the period specified in the requirements.

12.2. TEST SETUP (BLOCK DIAGRAM OF CONFIGURATION)

Same as described in section 8.2

12.3. MEASUREMENT EQUIPMENT USED

The same as described in section 6

12.4. LIMITS AND MEASUREMENT RESULT

Channel	Time of Pulse for DH5 (ms)	Number of hops in the period specified in the requirements	Sweep Time (ms)	Limit (ms)
Low	2.912	28*4	326.928	400
Middle	2.920	27*4	315.360	400
High	2.919	25*4	291.900	400

Note: The $\pi/4$ -DQPSK modulation is the worst case and recorded in the report.

TEST PLOT OF LOW CHANNEL

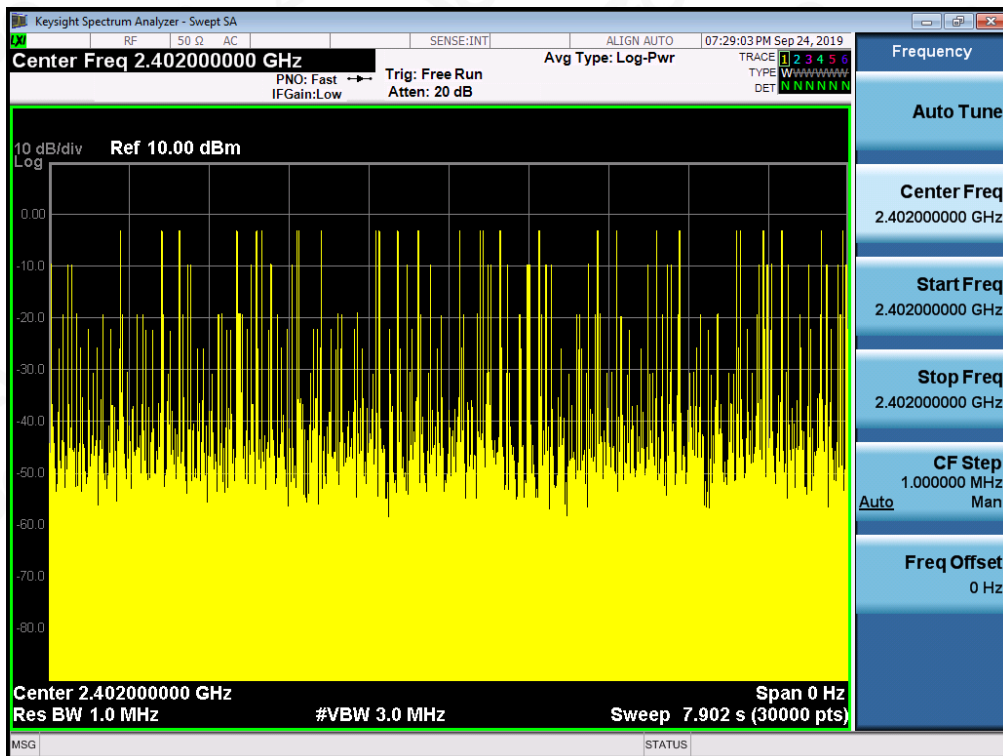
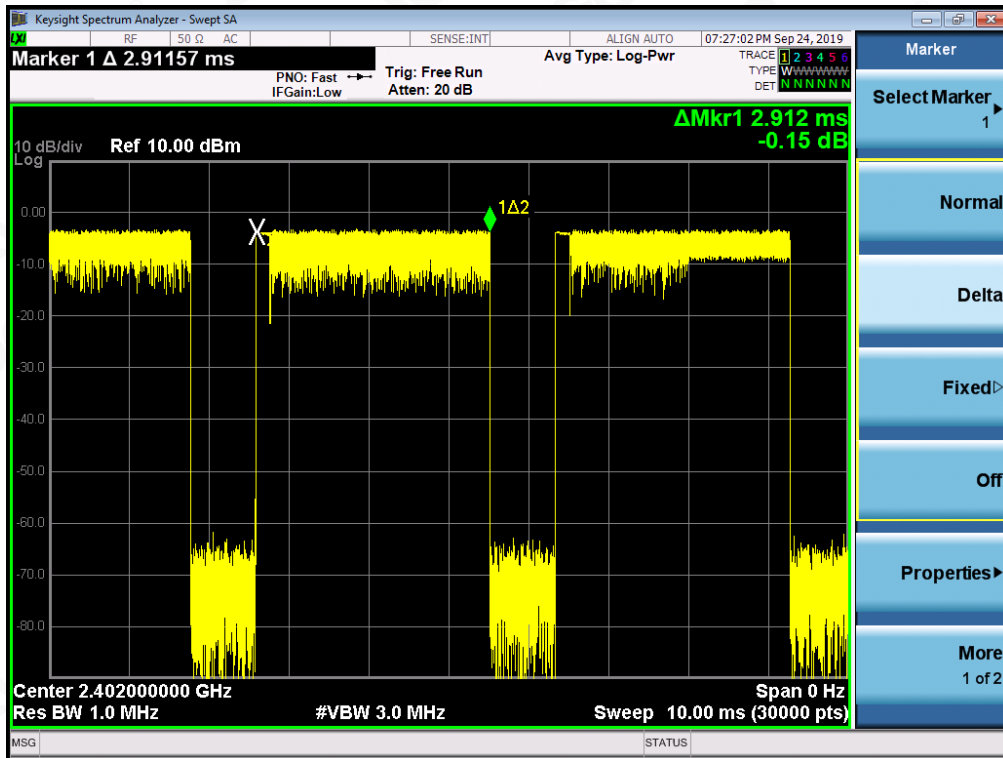

Attestation of Global Compliance

Attestation of Global Compliance(Shenzhen)Co.,Ltd.
Add: 2/F., Building 2, Sanwei Chaxi Industrial Park, Sanwei Community,
Hangcheng Street, Bao'an District, Shenzhen, Guangdong, China
Tel: +86-755 2523 4088 E-mail: agc@agc-cert.com Service Hotline:400 089 2118

TEST PLOT OF MIDDLE CHANNEL

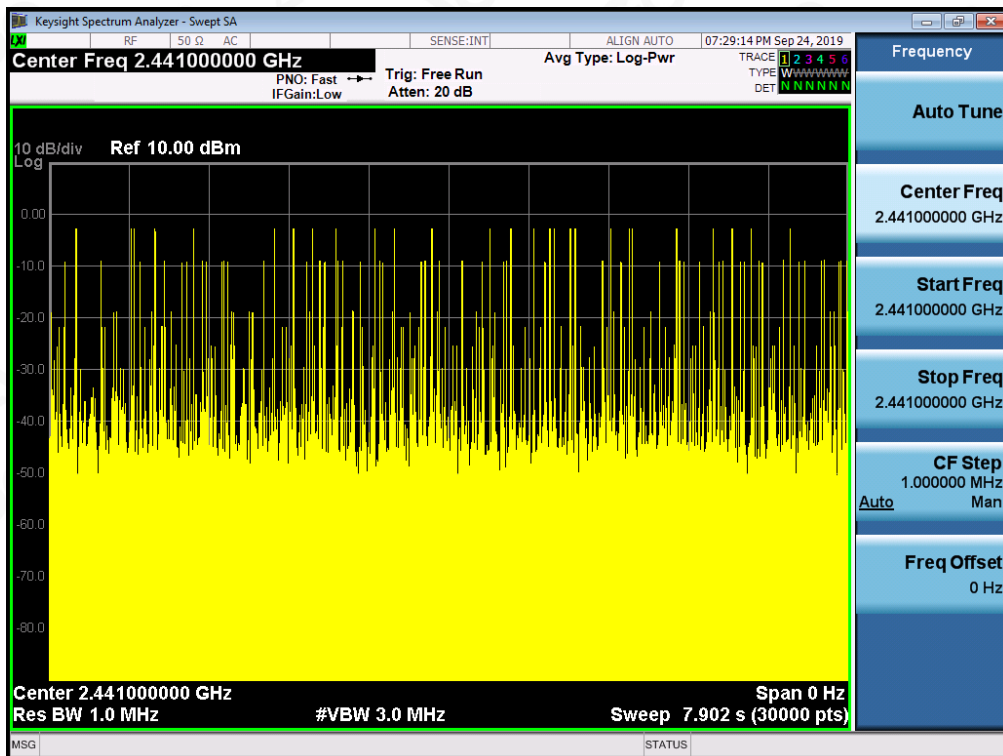
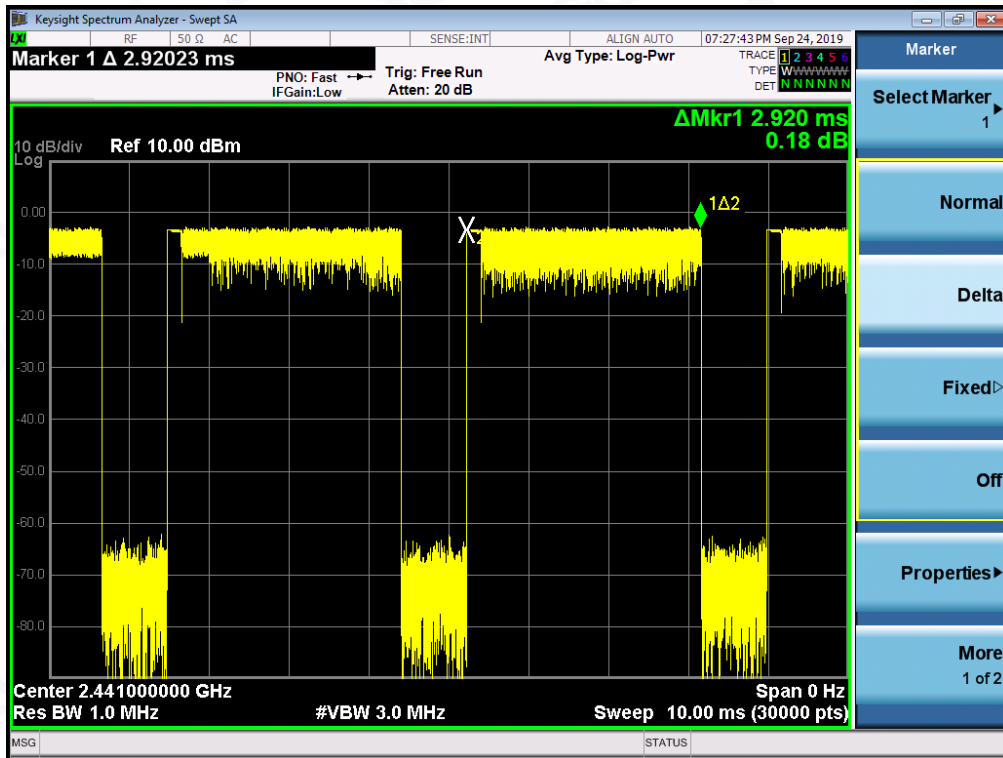

Attestation of Global Compliance

Attestation of Global Compliance(Shenzhen)Co.,Ltd.
Add: 2/F., Building 2, Sanwei Chaxi Industrial Park, Sanwei Community,
Hangcheng Street, Bao'an District, Shenzhen, Guangdong, China
Tel: +86-755 2523 4088 E-mail: agc@agc-cert.com Service Hotline:400 089 2118

TEST PLOT OF HIGH CHANNEL

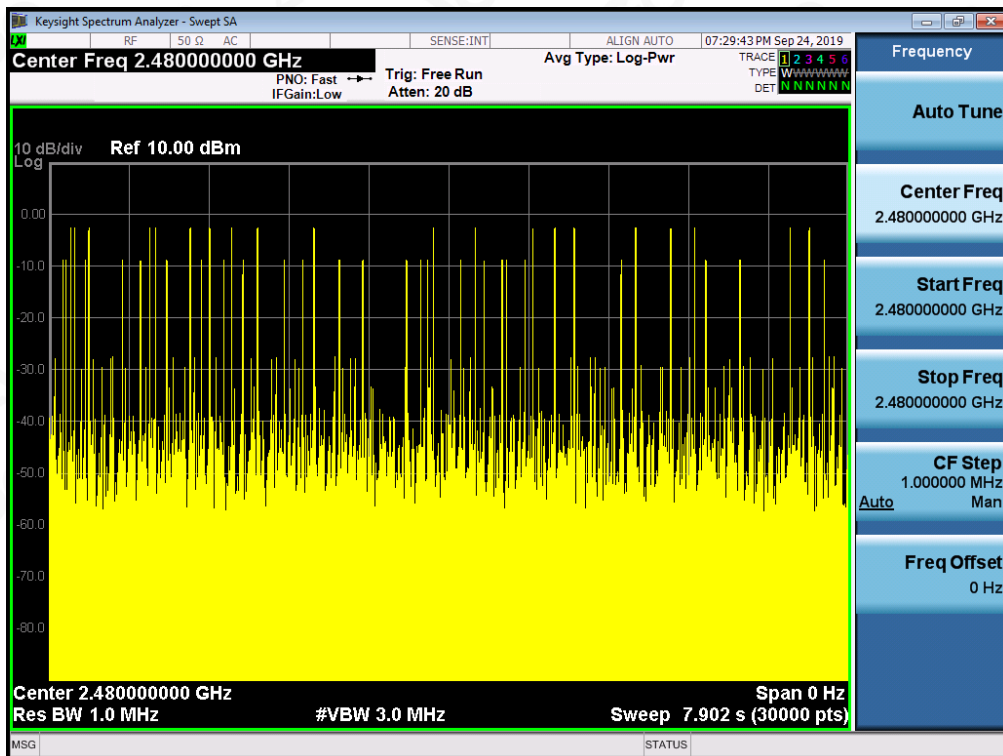
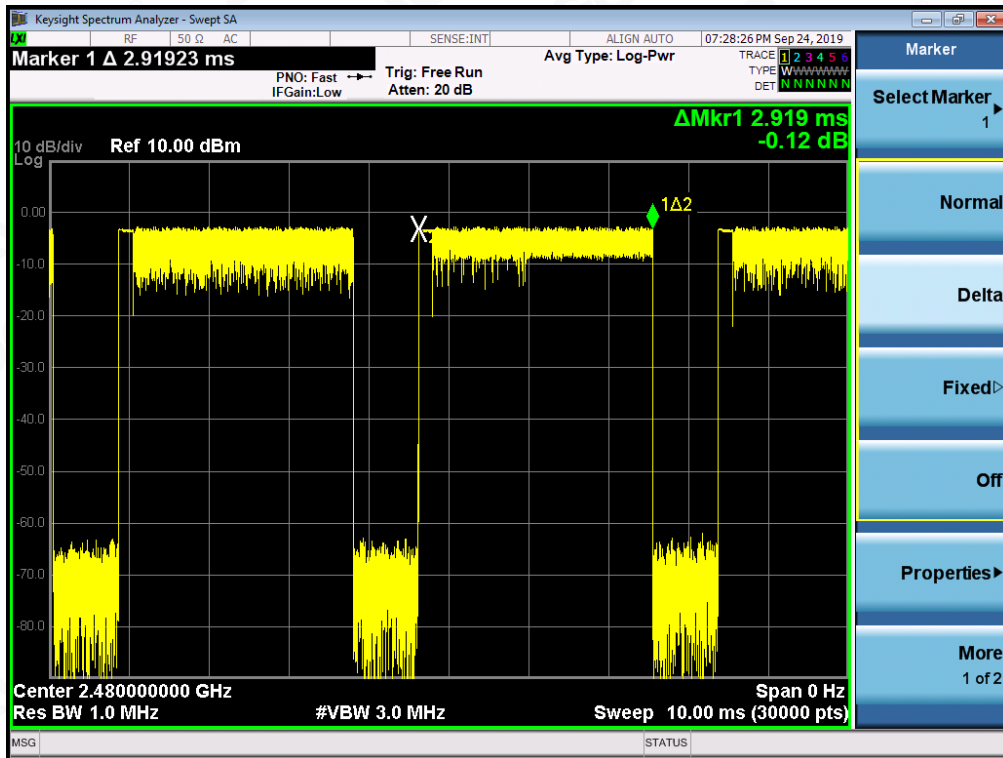

Attestation of Global Compliance

Attestation of Global Compliance(Shenzhen)Co.,Ltd.

Add: 2/F., Building 2, Sanwei Chaxi Industrial Park, Sanwei Community,
Hangcheng Street, Bao'an District, Shenzhen, Guangdong, China

Tel: +86-755 2523 4088

E-mail: agc@agc-cert.com

Service Hotline: 400 089 2118

13. FREQUENCY SEPARATION

13.1. MEASUREMENT PROCEDURE

The EUT shall have its hopping function enabled. Use the following spectrum analyzer settings:

1. Span: Wide enough to capture the peaks of two adjacent channels.
 2. RBW: Start with the RBW set to approximately 30% of the channel spacing; adjust as necessary to best identify the center of each individual channel.
 3. Video (or average) bandwidth (VBW) \geq RBW.
 4. Sweep: Auto. e) Detector function: Peak. f) Trace: Max hold. g) Allow the trace to stabilize.
- Use the marker-delta function to determine the separation between the peaks of the adjacent channels.

13.2. TEST SETUP (BLOCK DIAGRAM OF CONFIGURATION)

Same as described in section 6.2

13.3. MEASUREMENT EQUIPMENT USED

The same as described in section 6.3

13.4. LIMITS AND MEASUREMENT RESULT

CHANNEL	CHANNEL SEPARATION KHz	LIMIT (KHz)	RESULT
CH01-CH02	1001	≥ 25 KHz or 2/3 20 dB BW	PASS

TEST PLOT FOR FREQUENCY SEPARATION



Note: The $\pi/4$ -DQPSK modulation is the worst case and recorded in the report.

14. FCC LINE CONDUCTED EMISSION TEST

14.1. LIMITS OF LINE CONDUCTED EMISSION TEST

Frequency	Maximum RF Line Voltage	
	Q.P.(dBuV)	Average(dBuV)
150kHz~500kHz	66-56	56-46
500kHz~5MHz	56	46
5MHz~30MHz	60	50

Note: 1. The lower limit shall apply at the transition frequency.

2. The limit decreases linearly with the logarithm of the frequency in the range 0.15 MHz to 0.50 MHz.

14.2. BLOCK DIAGRAM OF LINE CONDUCTED EMISSION TEST

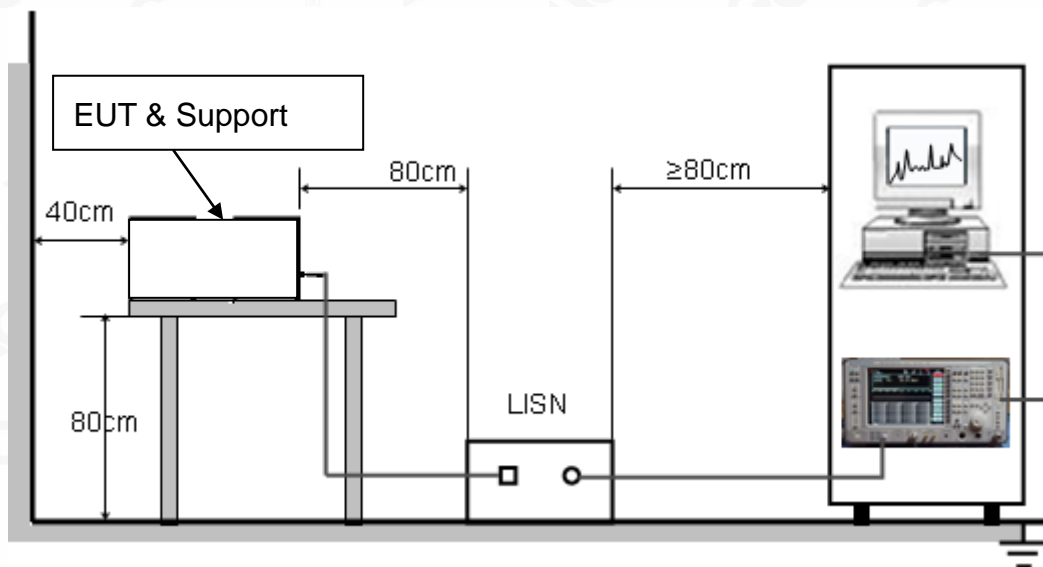

14.3. PRELIMINARY PROCEDURE OF LINE CONDUCTED EMISSION TEST

1. The equipment was set up as per the test configuration to simulate typical actual usage per the user's manual. When the EUT is a tabletop system, a wooden table with a height of 0.8 meters is used and is placed on the ground plane as per ANSI C63.10 (see Test Facility for the dimensions of the ground plane used). When the EUT is a floor-standing equipment, it is placed on the ground plane which has a 3-12 mm non-conductive covering to insulate the EUT from the ground plane.
2. Support equipment, if needed, was placed as per ANSI C63.10.
3. All I/O cables were positioned to simulate typical actual usage as per ANSI C63.10.
4. All support equipments received AC120V/60Hz power from a LISN, if any.
5. The EUT received DC charging voltage by adapter which received AC120V/60Hz power by a LISN.
6. The test program was started. Emissions were measured on each current carrying line of the EUT using a spectrum Analyzer / Receiver connected to the LISN powering the EUT. The LISN has two monitoring points: Line 1 (Hot Side) and Line 2 (Neutral Side). Two scans were taken: one with Line 1 connected to Analyzer / Receiver and Line 2 connected to a 50 ohm load; the second scan had Line 1 connected to a 50 ohm load and Line 2 connected to the Analyzer / Receiver.
7. Analyzer / Receiver scanned from 150 kHz to 30MHz for emissions in each of the test modes.
8. During the above scans, the emissions were maximized by cable manipulation.
9. The test mode(s) were scanned during the preliminary test.

Then, the EUT configuration and cable configuration of the above highest emission level were recorded for reference of final testing.

14.4. FINAL PROCEDURE OF LINE CONDUCTED EMISSION TEST

1. EUT and support equipment was set up on the test bench as per step 2 of the preliminary test.
2. A scan was taken on both power lines, Line 1 and Line 2, recording at least the six highest emissions. Emission frequency and amplitude were recorded into a computer in which correction factors were used to calculate the emission level and compare reading to the applicable limit. If EUT emission level was less -2dB to the A.V. limit in Peak mode, then the emission signal was re-checked using Q.P and Average detector.
3. The test data of the worst case condition(s) was reported on the Summary Data page.

14.5. TEST RESULT OF LINE CONDUCTED EMISSION TEST

N/A

Note: The EUT can not use the BT function with charging

APPENDIX A: PHOTOGRAPHS OF TEST SETUP

RADIATED EMISSION TEST SETUP BELOW 1GHZ



RADIATED EMISSION TEST SETUP ABOVE 1GHZ



CONDUCTED TEST SETUP

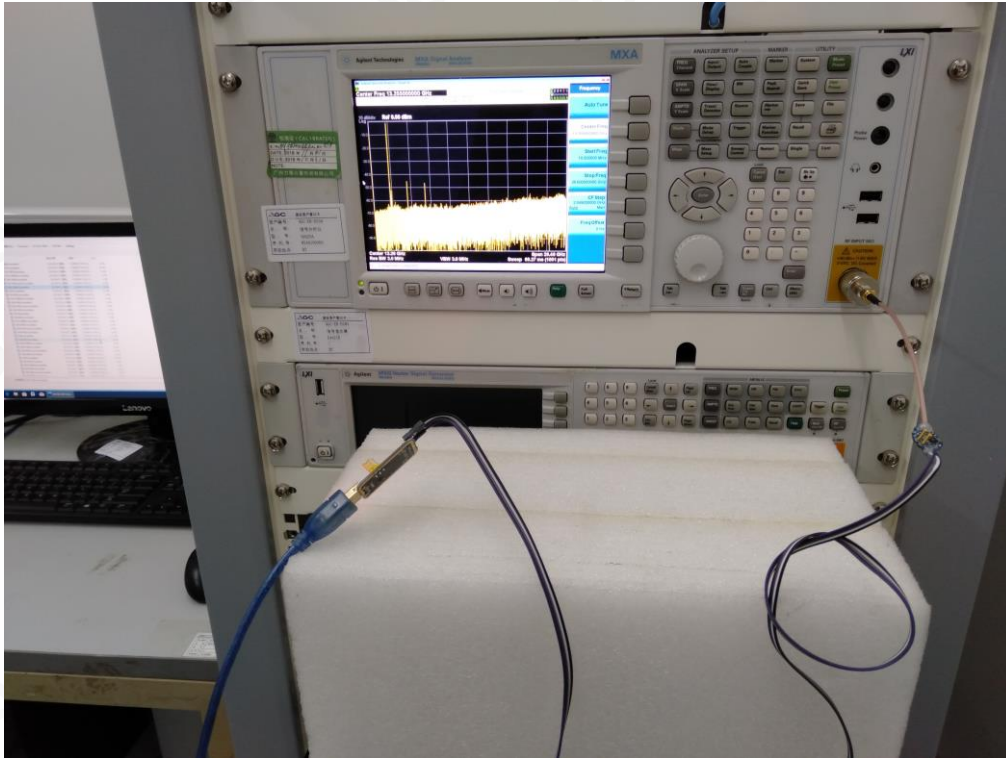

APPENDIX B: PHOTOGRAPHS OF EUT

TOP VIEW OF EUT



BOTTOM VIEW OF EUT

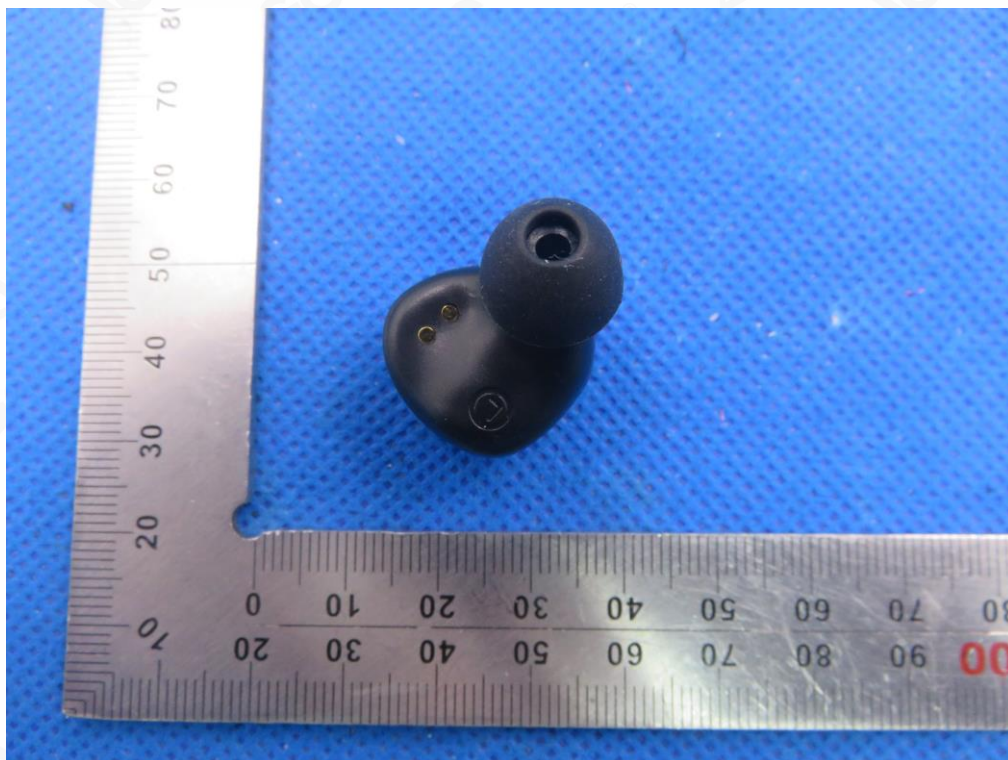

FRONT VIEW OF EUT

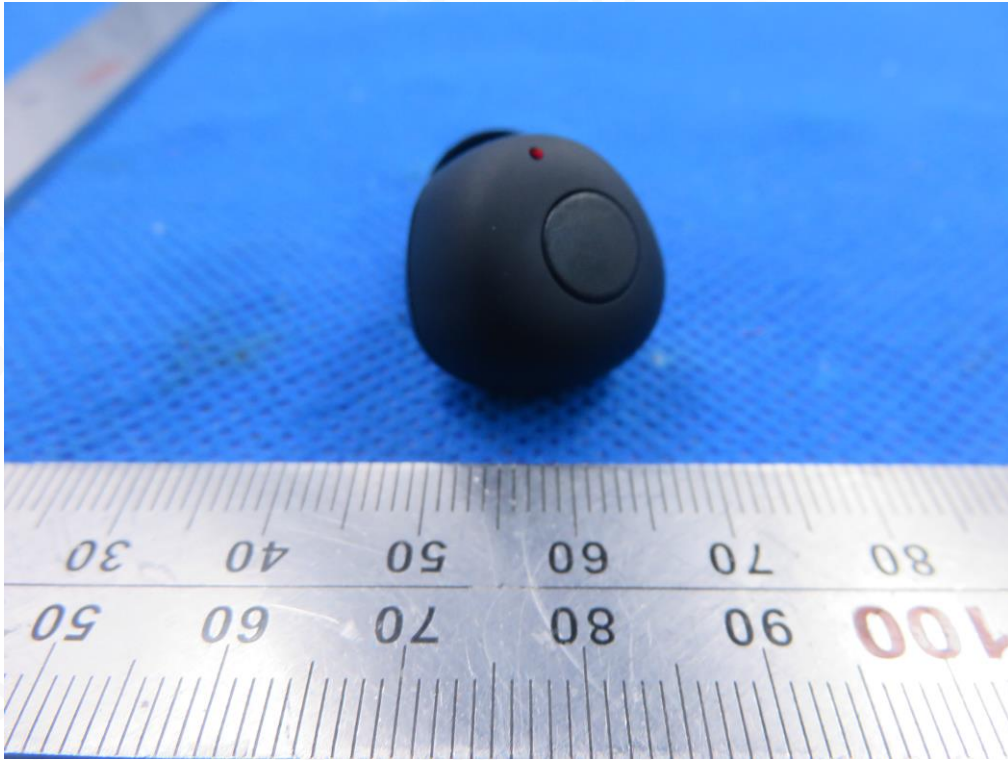

BACK VIEW OF EUT

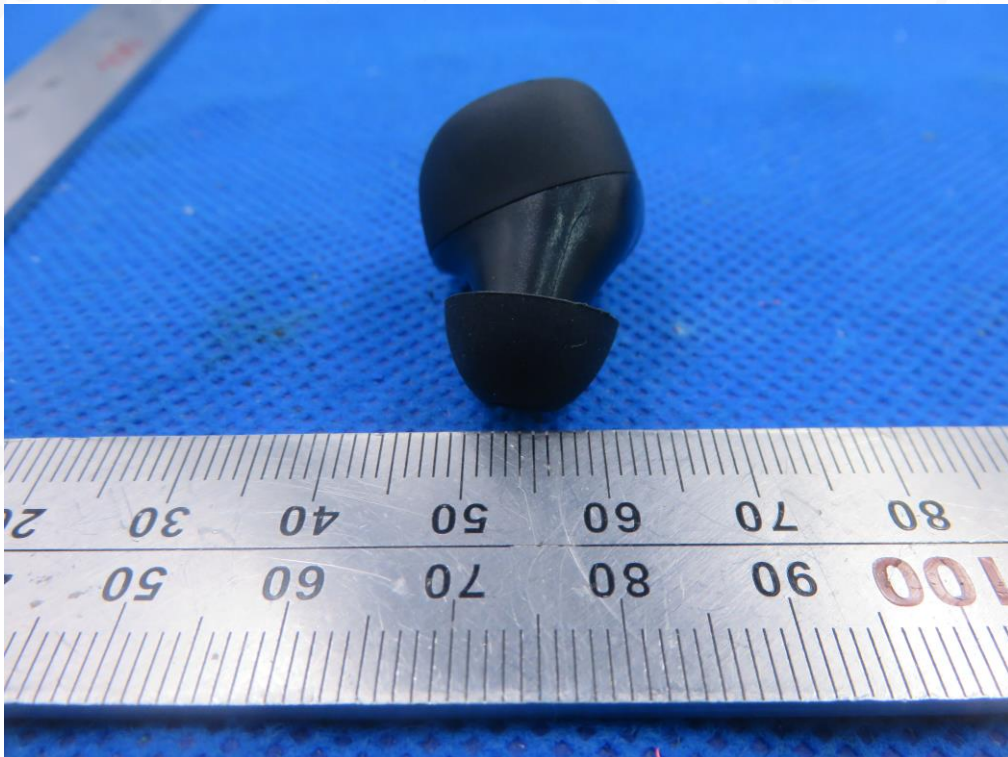

LEFT VIEW OF EUT



RIGHT VIEW OF EUT

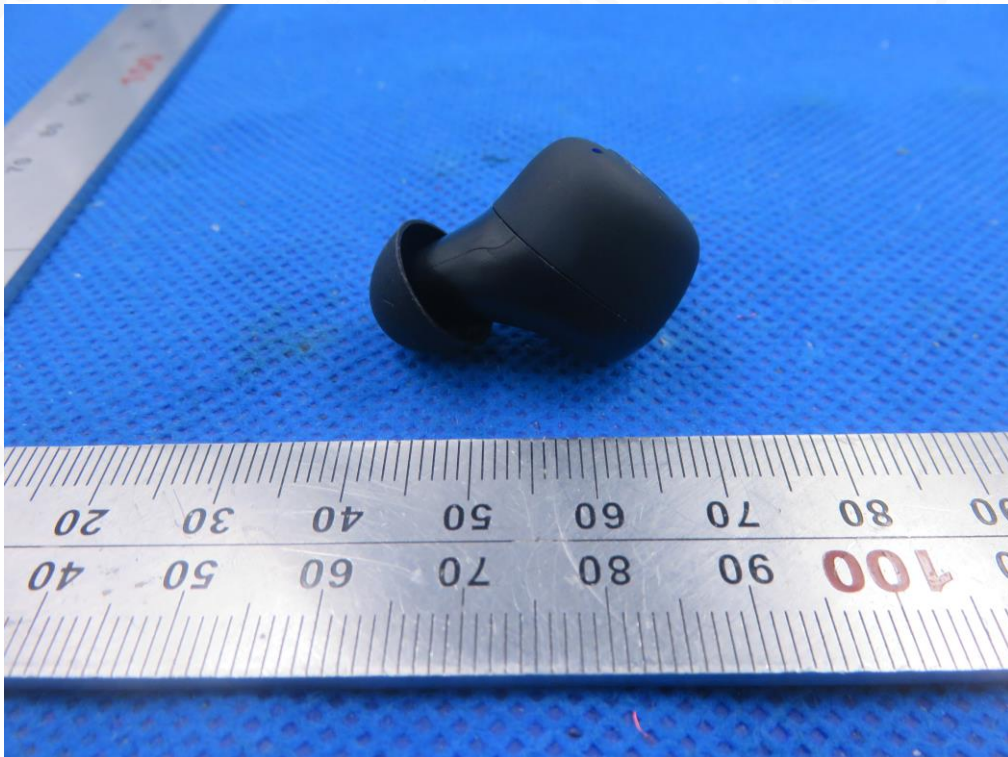

VIEW OF EUT(PORT)



OPEN VIEW OF EUT

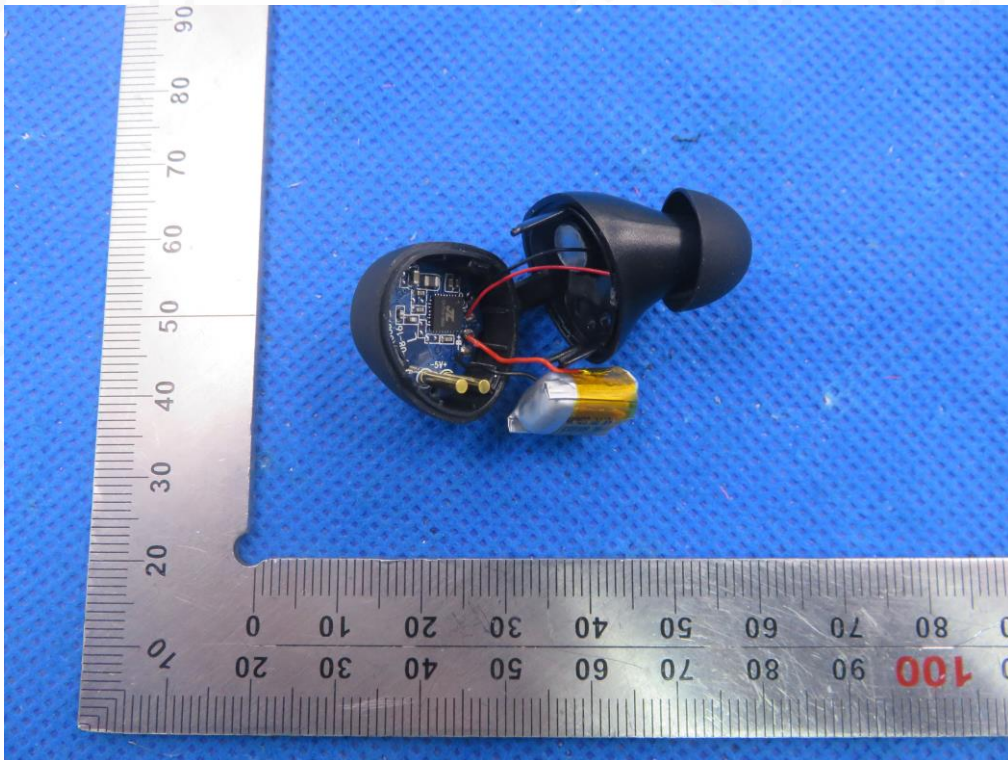

VIEW OF BATTERY

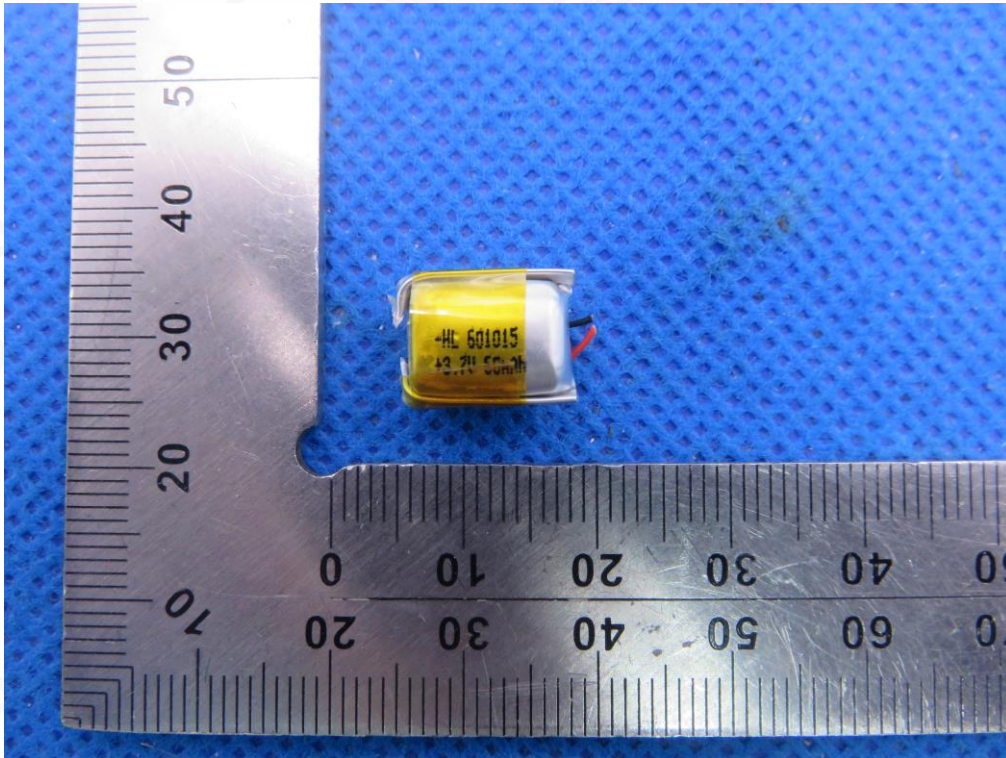

INTERNAL VIEW OF EUT-1

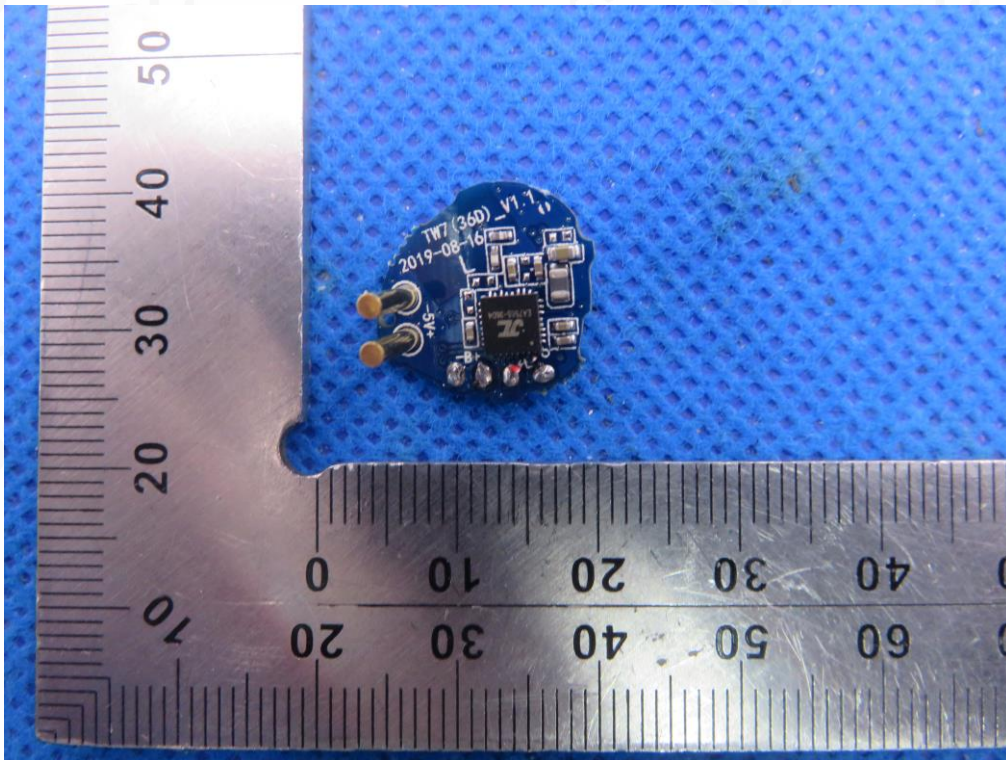

INTERNAL VIEW OF EUT-2

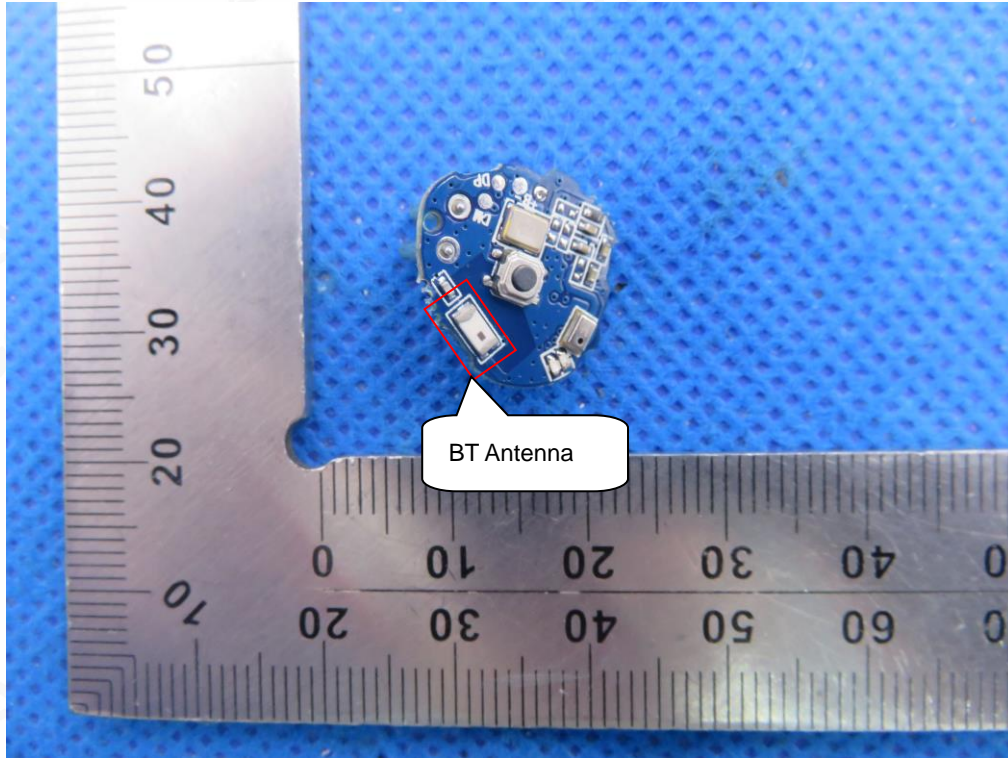

INTERNAL VIEW OF EUT-3

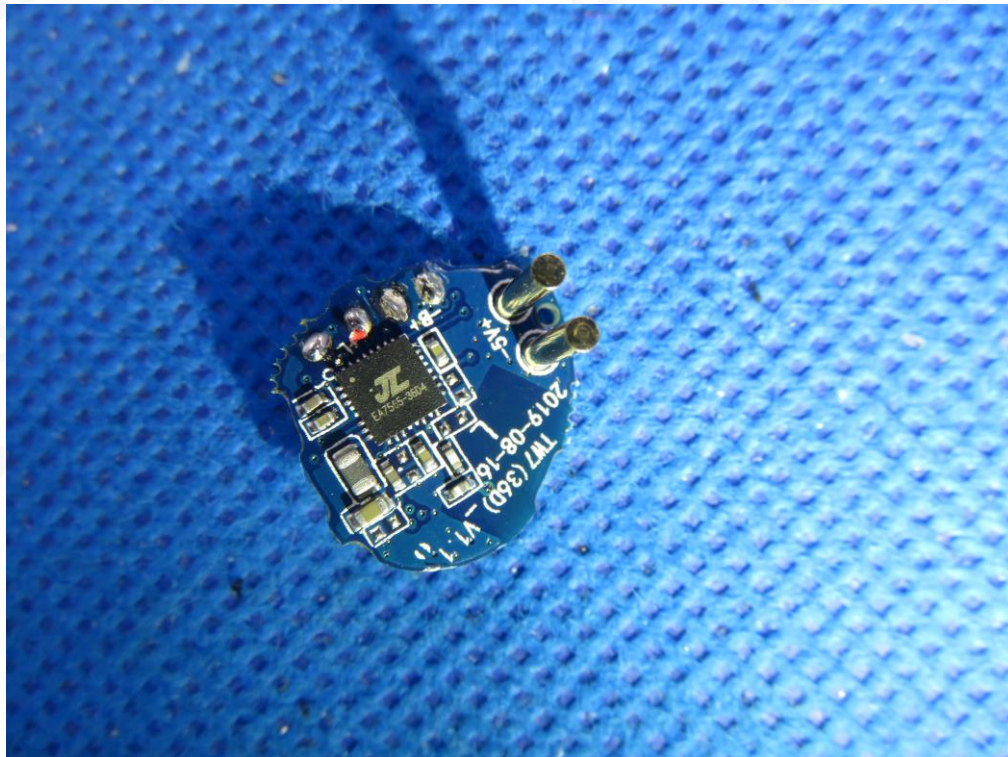

Charging Dock
TOP VIEW OF EUT



BOTTOM VIEW OF EUT

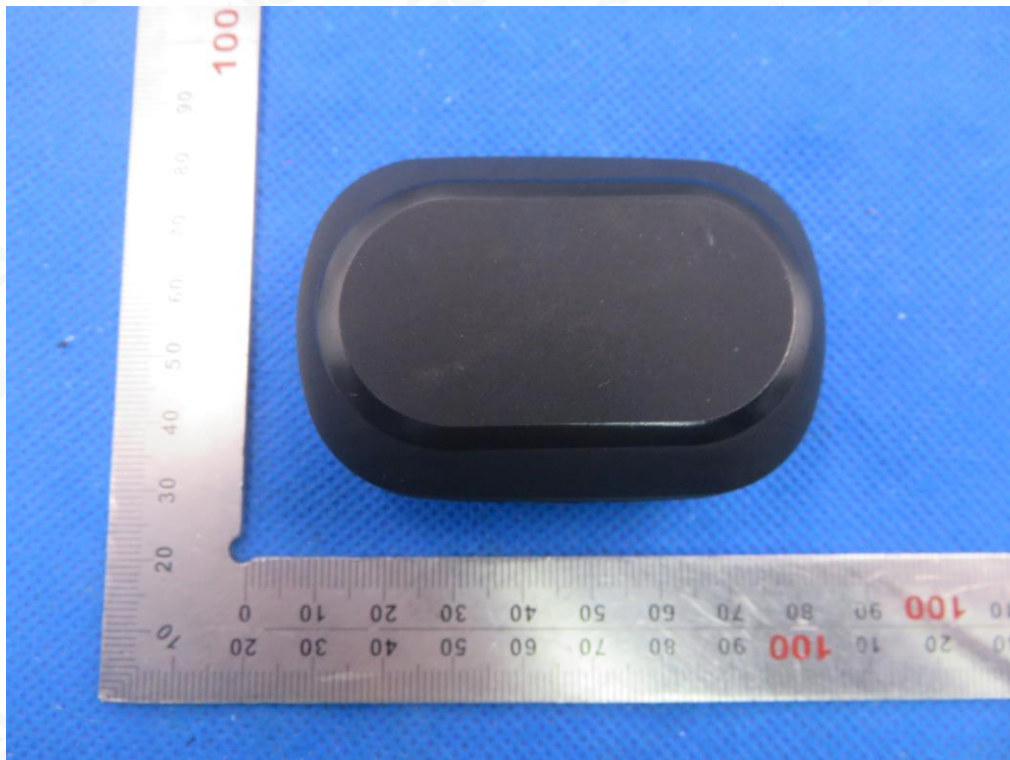

VIEW OF EUT(PORT)



----END OF REPORT----

