

---

# FCC Test Report

---

Report No.: AGC04303150401FE03

**FCC ID** : 2ACP4BT200  
**APPLICATION PURPOSE** : Original Equipment  
**PRODUCT DESIGNATION** : Bluetooth Headset  
**BRAND NAME** : SENTRY  
**MODEL NAME** : See page 4  
**CLIENT** : Sentry Industries limited  
**DATE OF ISSUE** : May 05,2015  
**STANDARD(S)**  
**TEST PROCEDURE(S)** : FCC Part 15 Rules  
**REPORT VERSION** : V1.0

Attestation of Global Compliance (Shenzhen) Co., Ltd



**CAUTION:**

This report shall not be reproduced except in full without the written permission of the test laboratory and shall not be quoted out of context.



**Report Revise Record**

<b>Report Version</b>	<b>Revise Time</b>	<b>Issued Date</b>	<b>Valid Version</b>	<b>Notes</b>
V1.0	/	May 05,2015	Valid	Original Report

## TABLE OF CONTENTS

<b>1. VERIFICATION OF CONFORMITY .....</b>	<b>4</b>
<b>2. GENERAL INFORMATION .....</b>	<b>5</b>
2.1. PRODUCT DESCRIPTION.....	5
2.2. TABLE OF CARRIER FREQUENCYS.....	5
<b>3. MEASUREMENT UNCERTAINTY.....</b>	<b>6</b>
<b>4. DESCRIPTION OF TEST MODES.....</b>	<b>6</b>
<b>5. SYSTEM TEST CONFIGURATION .....</b>	<b>7</b>
5.1. CONFIGURATION OF EUT SYSTEM .....	7
5.2. EQUIPMENT USED IN EUT SYSTEM .....	7
5.3. SUMMARY OF TEST RESULTS .....	7
<b>6. TEST FACILITY .....</b>	<b>8</b>
<b>7 ALL TEST EQUIPMENT LIST .....</b>	<b>8</b>
<b>8. RADIATED EMISSION .....</b>	<b>9</b>
8.1TEST LIMIT.....	9
8.2. MEASUREMENT PROCEDURE .....	10
8.3. TEST SETUP.....	12
8.4. TEST RESULT(Worst modulation:GFSK).....	14
<b>9. BAND EDGE EMISSION .....</b>	<b>27</b>
9.1. MEASUREMENT PROCEDURE .....	27
9.2 TEST SETUP .....	27
9.3 RADIATED TEST RESULT(Worst modulation:GFSK).....	28
<b>10. 20DB BANDWIDTH.....</b>	<b>32</b>
10.1. MEASUREMENT PROCEDURE .....	32
10.2. TEST SET-UP (BLOCK DIAGRAM OF CONFIGURATION).....	32
10.3. LIMITS AND MEASUREMENT RESULTS.....	32
<b>11. FCC LINE CONDUCTED EMISSION TEST .....</b>	<b>39</b>
11.1. LIMITS OF LINE CONDUCTED EMISSION TEST .....	39
11.2. BLOCK DIAGRAM OF LINE CONDUCTED EMISSION TEST.....	39
11.3. PRELIMINARY PROCEDURE OF LINE CONDUCTED EMISSION TEST .....	40
11.4. FINAL PROCEDURE OF LINE CONDUCTED EMISSION TEST.....	40
11.5. TEST RESULT OF LINE CONDUCTED EMISSION TEST.....	41
<b>APPENDIX A: PHOTOGRAPHS OF TEST SETUP .....</b>	<b>43</b>
<b>APPENDIX B: PHOTOGRAPHS OF EUT .....</b>	<b>45</b>

## 1. VERIFICATION OF CONFORMITY

<b>Applicant</b>	Sentry Industries limited
<b>Address</b>	507 Houston Centre,63 Mody Road,TST,HK
<b>Manufacturer</b>	Guangdong SAIYO Electronics Industry Co., Ltd.
<b>Address</b>	Xibian Industry Zone, Tongyu Town, Chaoyang District, Shantou City, Guangdong Province, China
<b>Product Designation</b>	Bluetooth Headset
<b>Brand Name</b>	SENTRY
<b>Test Model</b>	BT200
<b>Series Model</b>	BT100, BT150, BT250, BT300, BT350, BT400, BT450, BT500, BT550, BT600, BT650, BT700, BT750, BT800, BT850,BT900,BT950, BT201, BT202, BT203, BT204, BT205
<b>Different Description</b>	All the same except for the model name
<b>Date of test</b>	May 04,2015 to May 05,2015
<b>Deviation</b>	None
<b>Condition of Test Sample</b>	Normal
<b>Report Template</b>	AGCRT-US-BR/RF

We hereby certify that:

The above equipment was tested by Compliance Certification Service(Shenzhen) Inc. The test data, data evaluation, test procedures, and equipment configurations shown in this report were made in accordance with the procedures given in ANSI C63.4 (2009) and the energy emitted by the sample EUT tested as described in this report is in compliance with radiated emission limits of FCC Rules Part 15.249.

Prepared By

*Time Huang*

Time Huang      May 05,2015

Checked By

*Forrest Lei*

Forrest Lei      May 05,2015

Authorized By

*Solger Zhang*

Solger Zhang      May 05,2015

## 2. GENERAL INFORMATION

### 2.1. PRODUCT DESCRIPTION

A major technical description of EUT is described as following

<b>Operation Frequency</b>	2.402 GHz to 2.480GHz
<b>RF Output Power</b>	1.55dBm(Max)
<b>Bluetooth Version</b>	V2.1+EDR
<b>Modulation</b>	GFSK, $\pi/4$ -DQPSK, 8DPSK
<b>Number of channels</b>	79
<b>Hardware Version</b>	V1.1
<b>Software Version</b>	V1.1
<b>Antenna Designation</b>	PCB Antenna (Met 15.203 Antenna requirement)
<b>Antenna Gain</b>	0dBi
<b>Power Supply</b>	DC 3.7V

Note: The USB port only used for charging and can't be used to transfer data with PC.

### 2.2. TABLE OF CARRIER FREQUENCIES

Frequency Band	Channel Number	Frequency
2400~2483.5MHZ	0	2402MHZ
	1	2403MHZ
	:	:
	38	2440 MHZ
	39	2441 MHZ
	40	2442 MHZ
	:	:
	77	2479 MHZ
	78	2480 MHZ

### 3. MEASUREMENT UNCERTAINTY

The reported uncertainty of measurement  $y \pm U$ , where expanded uncertainty  $U$  is based on a standard uncertainty multiplied by a coverage factor of  $k=2$ , providing a level of confidence of approximately 95 %.

No.	Item	Uncertainty
1	Conducted Emission Test	$\pm 3.18\text{dB}$
2	All emissions, radiated	$\pm 3.91\text{dB}$
3	Temperature	$\pm 0.5^\circ\text{C}$
4	Humidity	$\pm 2\%$

### 4. DESCRIPTION OF TEST MODES

NO.	TEST MODE DESCRIPTION
1	Low channel GFSK
2	Middle channel GFSK
3	High channel GFSK
4	Low channel $\pi/4$ -DQPSK
5	Middle channel $\pi/4$ -DQPSK
6	High channel $\pi/4$ -DQPSK
7	Low channel 8DPSK
8	Middle channel 8DPSK
9	High channel 8DPSK
10	Normal operation (BT)

**Note:**

1. All the test modes can be supply by battery, only the result of the worst case was recorded in the report, if no other cases.
2. For Radiated Emission, 3axis were chosen for testing for each applicable mode.

## 5. SYSTEM TEST CONFIGURATION

### 5.1. CONFIGURATION OF EUT SYSTEM

Configure 1: (Normal hopping)

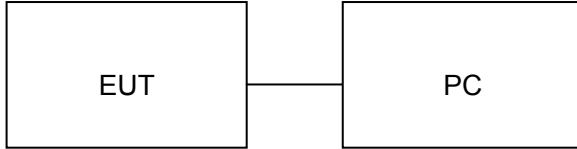

Configure 2: (Control continuous TX)

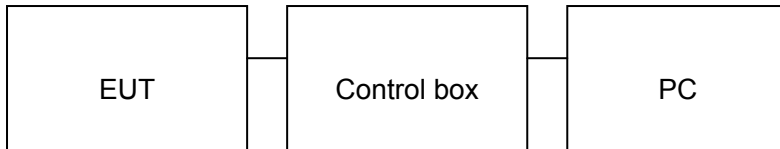

### 5.2. EQUIPMENT USED IN EUT SYSTEM

Item	Equipment	Model No.	ID or Specification	Remark
1	Bluetooth Headset	SENTRY	BT200	EUT
2	Control box	N/A	N/A	A.E
3	PC	Dell	INSPIRON	A.E

### 5.3. SUMMARY OF TEST RESULTS

FCC RULES	DESCRIPTION OF TEST	RESULT
§15.249	Radiated Emission	Compliant
§15.249	Band Edges	Compliant
§15.207	Conduction Emission	Compliant

**6. TEST FACILITY**

<b>Site</b>	Compliance Certification Service(Shenzhen) Inc.
<b>Location</b>	No.10-1 Mingkeda Logistics Park, No.18 Huanguan South RD. Guan lan Town,Baoan Distr
<b>FCC Registration No.</b>	441872
<b>Description</b>	The test site is constructed and calibrated to meet the FCC requirements in documents ANSI C63.4:2009.

**7 ALL TEST EQUIPMENT LIST**

<b>Radiated Emission Test Site 966(2)</b>					
<b>Name of Equipment</b>	<b>Manufacturer</b>	<b>Model Number</b>	<b>Serial Number</b>	<b>Last Calibration</b>	<b>Due Calibration</b>
PSA Series Spectrum Analyzer	Agilent	E4446A	US44300399	03/01/2015	03/01/2016
EMI TEST RECEIVER	ROHDE&SCHWARZ	ESCI	100783	03/09/2015	03/08/2016
Amplifier	MITEQ	AM-1604-3000	1123808	03/18/2015	03/17/2016
High Noise Amplifier	Agilent	8449B	3008A01838	03/18/2015	03/17/2016
Board-Band Horn Antenna	Schwarzbeck	BBHA 9170	9170-497	07/10/2014	07/09/2015
Bilog Antenna	SCHAFFNER	CBL6143	5082	03/01/2015	03/01/2016
Horn Antenna	SCHWARZBECK	BBHA9120	D286	03/01/2015	03/01/2016
Loop Antenna	COM-POWER	AL-130	121044	09/27/2014	09/26/2015
Turn Table	N/A	N/A	N/A	N.C.R	N.C.R
Controller	Sunol Sciences	SC104V	022310-1	N.C.R	N.C.R
Controller	CT	N/A	N/A	N.C.R	N.C.R
Temp. / Humidity Meter	Anymetre	JR913	N/A	02/28/2015	02/27/2016
Antenna Tower	SUNOL	TLT2	N/A	N.C.R	N.C.R
Test S/W	FARAD	LZ-RF / CCS-SZ-3A2			

<b>Conducted Emission Test Site</b>					
<b>Name of Equipment</b>	<b>Manufacturer</b>	<b>Model Number</b>	<b>Serial Number</b>	<b>Last Calibration</b>	<b>Due Calibration</b>
EMI TEST RECEIVER	ROHDE&SCHWARZ	ESCI	100783	03/09/2015	03/08/2016
LISN(EUT)	ROHDE&SCHWARZ	ENV216	101543-WX	03/09/2015	03/08/2016
LISN	EMCO	3825/2	8901-1459	03/09/2015	03/08/2016
Temp. / Humidity Meter	VICTOR	HTC-1	N/A	03/04/2015	03/03/2016
Test S/W	FARAD	EZ-EMC/ CCS-3A1-CE			



## 8. RADIATED EMISSION

### 8.1 TEST LIMIT

#### Standard FCC15.249

Fundamental Frequency	Field Strength of Fundamental (millivolts/meter)	Field Strength of Harmonics (microvolts/meter)
900-928MHz	50	500
2400-2483.5MHz	50	500
5725-5875MHz	50	500
24.0-24.25GHz	250	2500

#### Standard FCC 15.209

Frequency (MHz)	Distance Meters	Field Strengths Limit	
		$\mu$ V/m	dB( $\mu$ V)/m
0.009 ~ 0.490	300	2400/F(kHz)	---
0.490 ~ 1.705	30	24000/F(kHz)	---
1.705 ~ 30	30	30	---
30 ~ 88	3	100	40.0
88 ~ 216	3	150	43.5
216 ~ 960	3	200	46.0
960 ~ 1000	3	500	54.0
Above 1000	3	Other:74.0 dB( $\mu$ V)/m (Peak) 54.0 dB( $\mu$ V)/m (Average)	

Remark: (1) Emission level dB  $\mu$  V = 20 log Emission level  $\mu$  V/m  
(2) The smaller limit shall apply at the cross point between two frequency bands.  
(3) Distance is the distance in meters between the measuring instrument, antenna and the closest point of any part of the device or system.

## 8.2. MEASUREMENT PROCEDURE

1. Configure the EUT according to ANSI C63.4. The EUT was placed on the top of the turntable 0.8 meter above ground. The phase center of the receiving antenna mounted on the top of a height-variable antenna tower was placed 3 meters far away from the turntable.
2. Power on the EUT and all the supporting units. The turntable was rotated by 360 degrees to determine the position of the highest radiation.
3. The height of the broadband receiving antenna was varied between one meter and four meters above ground to find the maximum emissions field strength of both horizontal and vertical polarization.
4. For each suspected emissions, the antenna tower was scan (from 1 M to 4 M) and then the turntable was rotated (from 0 degree to 360 degrees) to find the maximum reading.
5. Set the test-receiver system to Peak or CISPR quasi-peak Detect Function with specified bandwidth under Maximum Hold Mode.
6. For emissions above 1GHz, use 1MHz VBW and RBW for peak reading. Then 1MHz RBW and 10Hz VBW for average reading in spectrum analyzer.
7. When the radiated emissions limits are expressed in terms of the average value of the emissions, and pulsed operation is employed, the measurement field strength shall be determined by averaging over one complete pulse train, including blanking intervals, as long as the pulse train does not exceed 0.1 seconds. As an alternative (provided the transmitter operates for longer than 0.1 seconds) or in cases where the pulse train exceeds 0.1 seconds, the measured field strength shall be determined from the average absolute voltage during a 0.1 second interval during which the field strength is at its maximum values.
8. If the emissions level of the EUT in peak mode was 3 dB lower than the average limit specified, then testing will be stopped and peak values of EUT will be reported, otherwise, the emissions which do not have 3 dB margin will be repeated one by one using the quasi-peak method for below 1GHz.
9. For testing above 1GHz, the emissions level of the EUT in peak mode was lower than average limit (that means the emissions level in peak mode also complies with the limit in average mode), then testing will be stopped and peak values of EUT will be reported, otherwise, the emissions will be measured in average mode again and reported.
10. In case the emission is lower than 30MHz, loop antenna has to be used for measurement and the recorded data should be QP measured by receiver. High - Low scan is not required in this case.

The following table is the setting of spectrum analyzer and receiver.

<b>Spectrum Parameter</b>	<b>Setting</b>
Start ~Stop Frequency	9KHz~150KHz/RB 200Hz for QP
Start ~Stop Frequency	150KHz~30MHz/RB 9KHz for QP
Start ~Stop Frequency	30MHz~1000MHz/RB 120KHz for QP
Start ~Stop Frequency	1GHz~26.5GHz 1MHz/1MHz for Peak, 1MHz/10Hz for Average

<b>Receiver Parameter</b>	<b>Setting</b>
Start ~Stop Frequency	9KHz~150KHz/RB 200Hz for QP
Start ~Stop Frequency	150KHz~30MHz/RB 9KHz for QP
Start ~Stop Frequency	30MHz~1000MHz/RB 120KHz for QP

**8.3. TEST SETUP**

**Radiated Emission Test-Setup Frequency Below 30MHz**

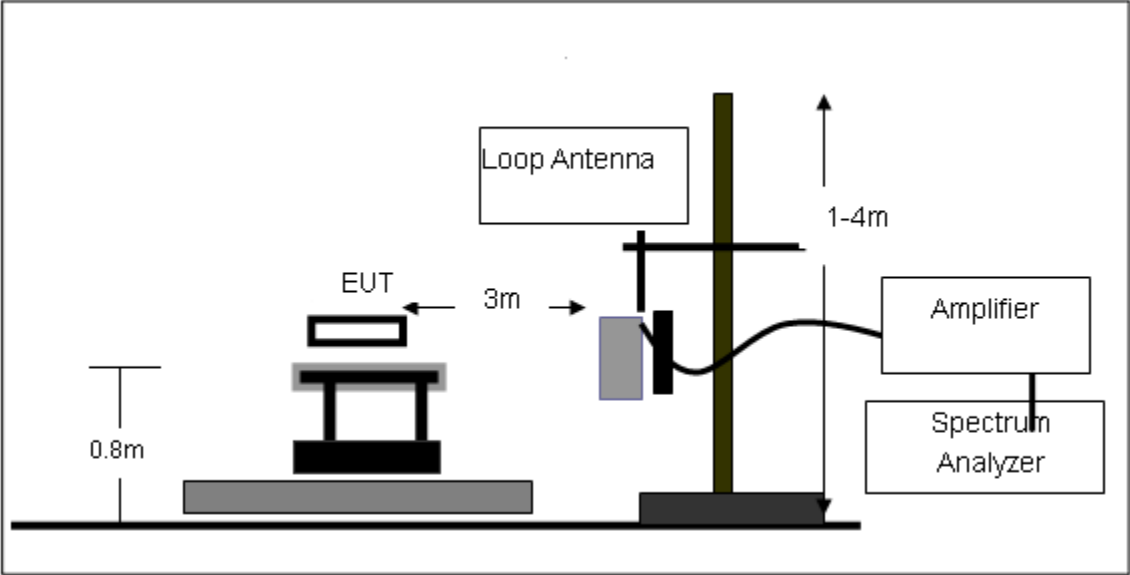

**RADIATED EMISSION TEST SETUP 30MHz-1000MHz**

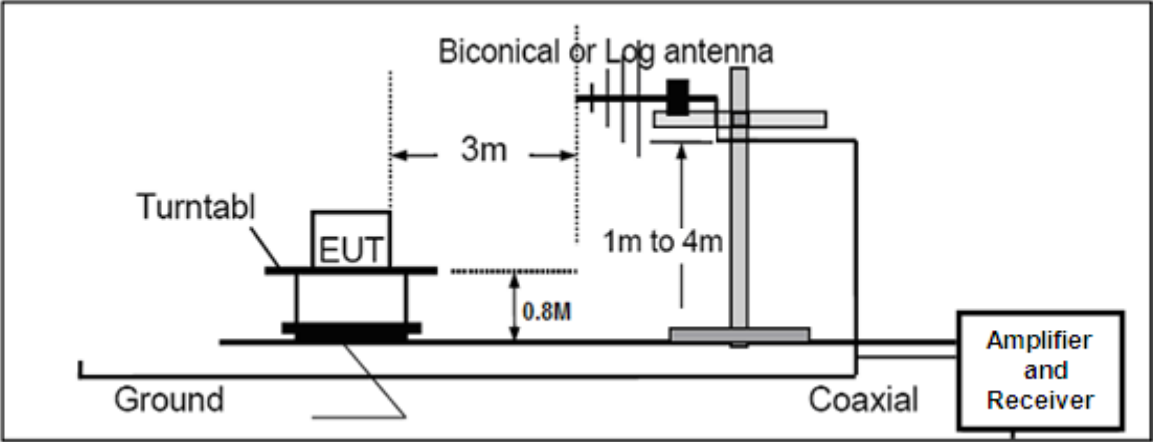

RADIATED EMISSION TEST SETUP ABOVE 1000MHz

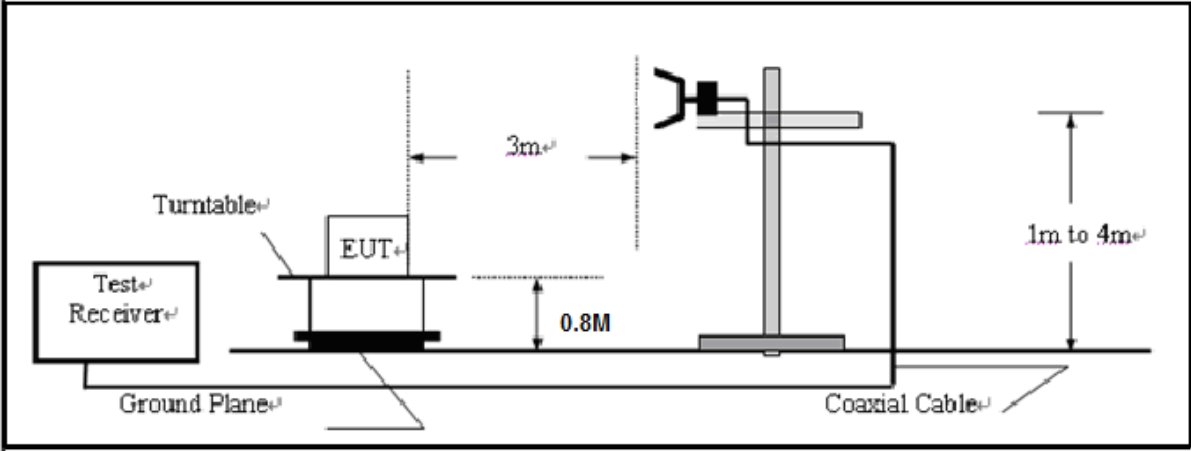

8.4. TEST RESULT(Worst modulation:GFSK)

**RADIATED EMISSION BELOW 30MHZ**

No emission found between lowest internal used/generated frequencies to 30MHz.

**RADIATED EMISSION BELOW 1GHZ**

RADIATED EMISSION TEST- (30MHZ-1GHZ)-LOW CHANNEL-HORIZONTAL

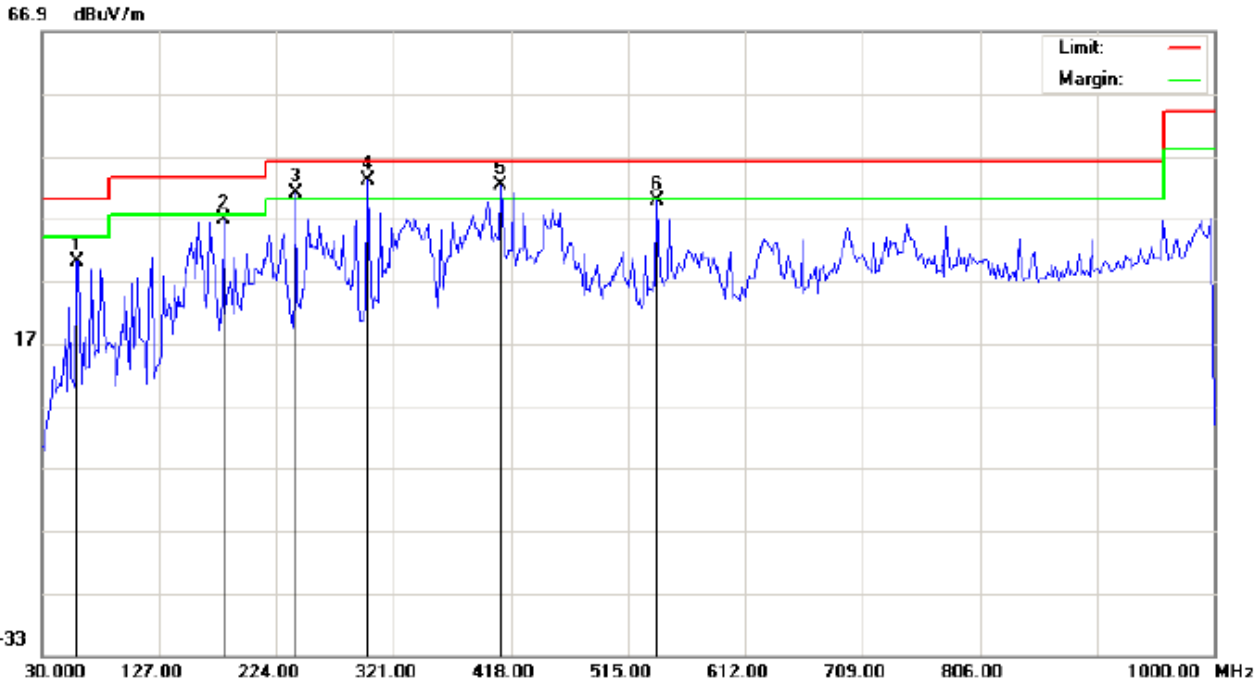

Site: site #1  
 Limit: FCC Class B 3M Radiation  
 EUT:Bluetooth Headset  
 M/N: BT200  
 Mode: Low Channel TX  
 Note:

Polarization: *Horizontal*  
 Power:  
 Distance: 3m

Temperature: 26  
 Humidity: 60 %

No.	Mk	Freq.	Reading	Factor	Measurement	Limit	Over	Detector	Antenna Height	Table Degree	Comment
		MHz	dBuV	dB/m	dBuV/m	dBuV/m	dB		cm	degree	
1		59.1000	18.95	11.16	30.11	40.00	-9.89	peak			
2		180.3500	25.62	11.09	36.71	43.50	-6.79	peak			
3	!	240.1667	27.47	13.53	41.00	46.00	-5.00	peak			
4	*	299.9833	27.65	15.41	43.06	46.00	-2.94	peak			
5	!	409.9167	22.87	19.37	42.24	46.00	-3.76	peak			
6		539.2500	17.69	22.19	39.88	46.00	-6.12	peak			

**RESULT: PASS**

RADIATED EMISSION TEST- (30MHZ-1GHZ)-LOW CHANNEL -VERTICAL

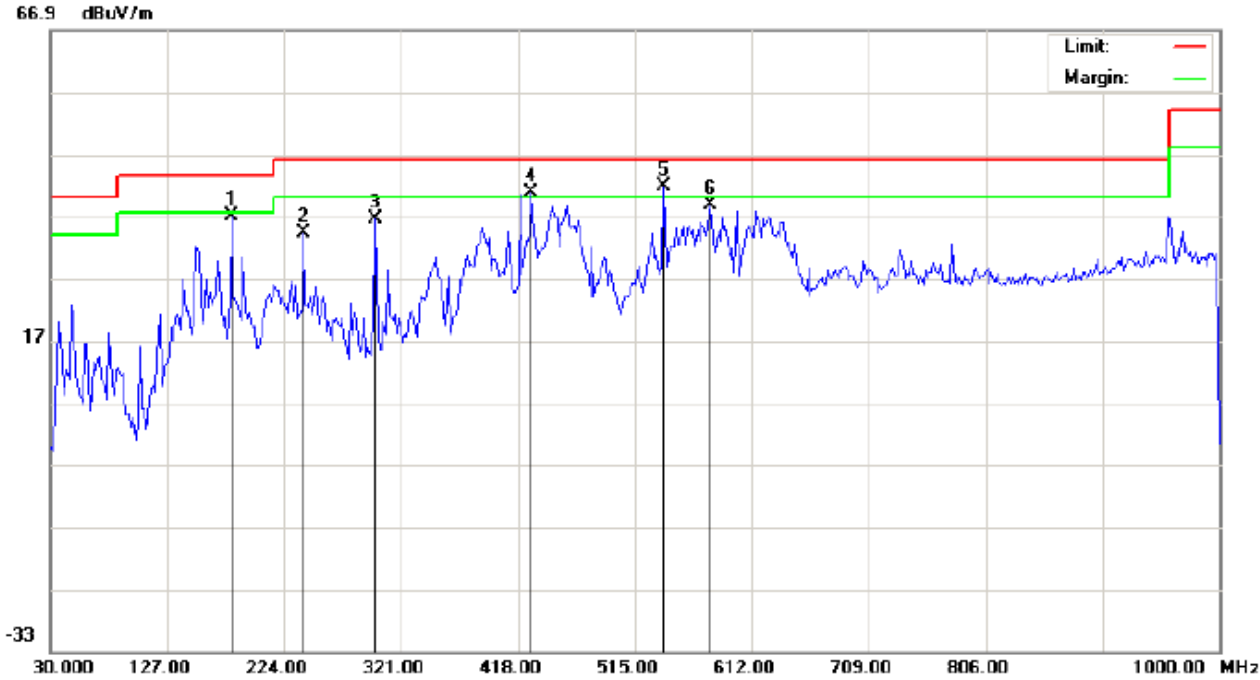

Site: site #1  
 Limit: FCC Class B 3M Radiation  
 EUT:Bluetooth Headset  
 M/N: BT200  
 Mode: Low Channel TX  
 Note:

Polarization: *Vertical*  
 Power:  
 Distance: 3m

Temperature: 26  
 Humidity: 60 %

No.	Mk	Freq.	Reading	Factor	Measurement	Limit	Over	Detector	Antenna Height	Table Degree	Comment
		MHz	dBuV	dB/m	dBuV/m	dBuV/m	dB		cm	degree	
1		180.3500	23.05	13.98	37.03	43.50	-6.47	peak			
2		240.1667	21.41	12.94	34.35	46.00	-11.65	peak			
3		299.9833	21.11	15.41	36.52	46.00	-9.48	peak			
4	!	429.3167	20.71	19.96	40.67	46.00	-5.33	peak			
5	*	539.2500	19.71	22.19	41.90	46.00	-4.10	peak			
6		578.0500	16.11	22.62	38.73	46.00	-7.27	peak			

**RESULT: PASS**

- Note:** 1. Factor=Antenna Factor + Cable loss, Margin=Measurement-Limit.  
 2. The "Factor" value can be calculated automatically by software of measurement system.

RADIATED EMISSION TEST- (30MHZ-1GHZ)-MIDDLE CHANNEL-HORIZONTAL

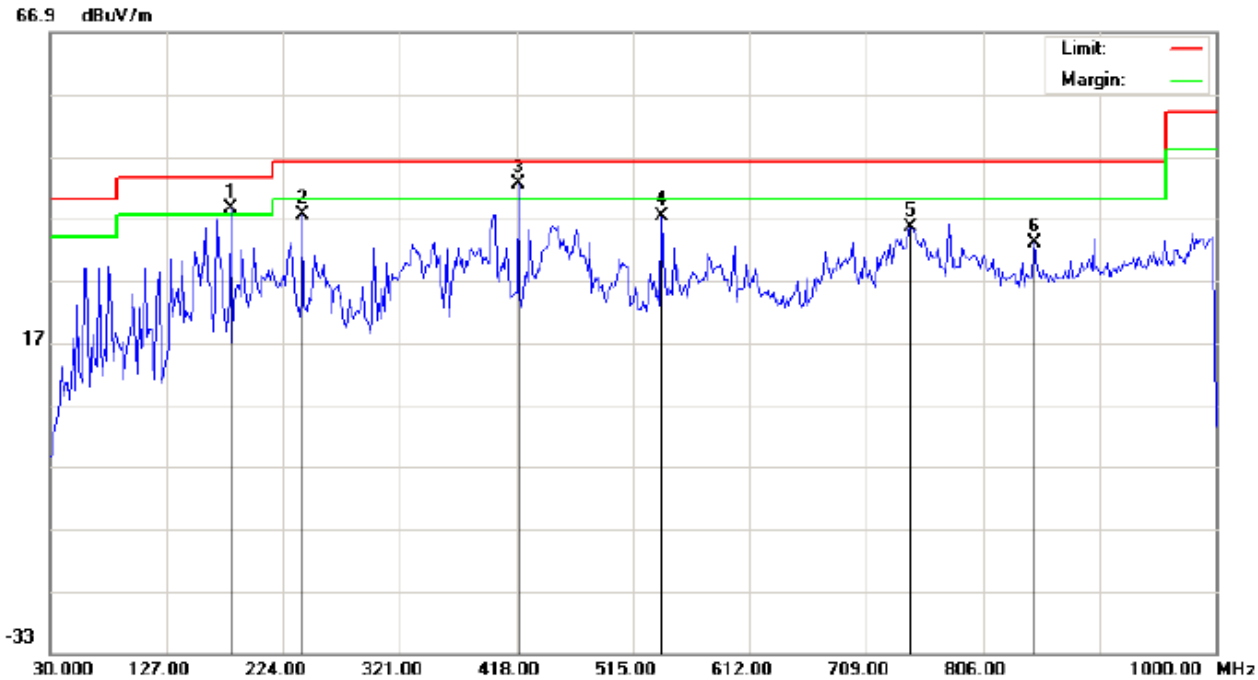

Site: site #1  
 Limit: FCC Class B 3M Radiation  
 EUT:Bluetooth Headset  
 M/N: BT200  
 Mode: Middle Channel TX  
 Note:

Polarization: *Horizontal*  
 Power:  
 Distance: 3m

Temperature: 26  
 Humidity: 60 %

No.	Mk	Freq.	Reading	Factor	Measurement	Limit	Over	Detector	Antenna Height	Table Degree	Comment
		MHz	dBuV	dB/m	dBuV/m	dBuV/m	dB		cm	degree	
1	!	180.3500	27.36	11.09	38.45	43.50	-5.05	peak			
2		240.1667	23.99	13.53	37.52	46.00	-8.48	peak			
3	*	419.6167	22.79	19.67	42.46	46.00	-3.54	peak			
4		539.2500	15.10	22.19	37.29	46.00	-8.71	peak			
5		746.1833	9.01	26.52	35.53	46.00	-10.47	peak			
6		849.6500	5.76	27.31	33.07	46.00	-12.93	peak			

RESULT: PASS



RADIATED EMISSION TEST- (30MHZ-1GHZ)- MIDDLE CHANNEL -VERTICAL

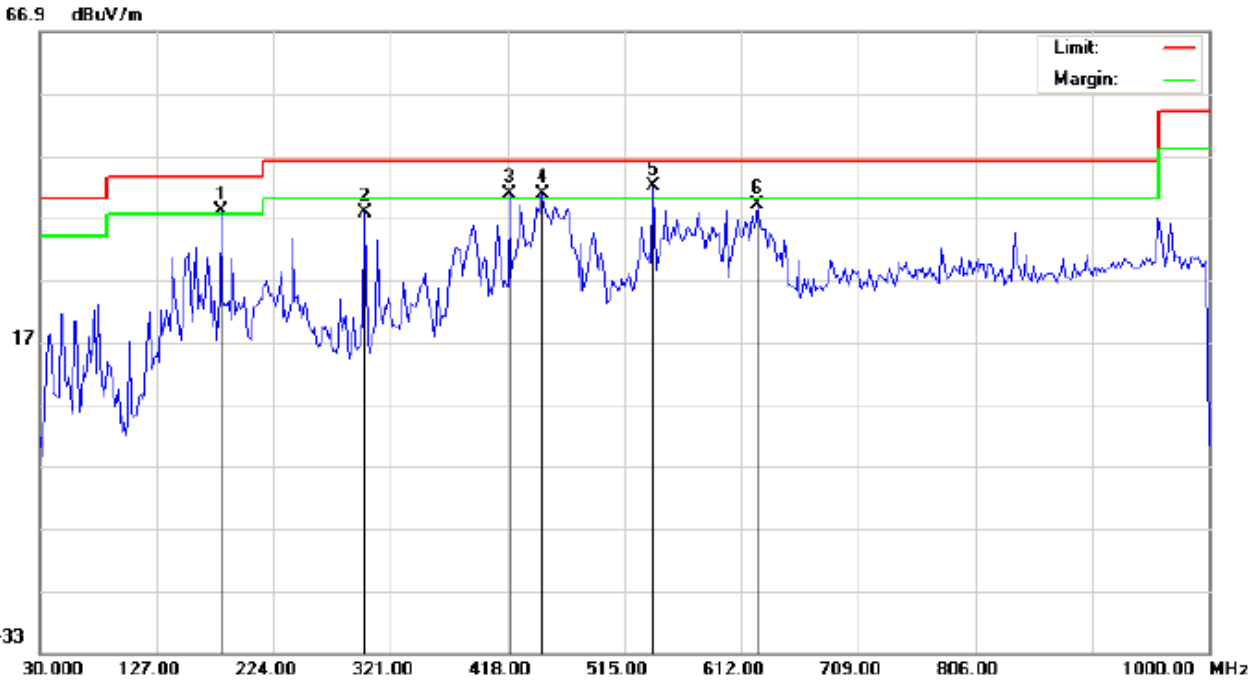

Site: site #1  
 Limit: FCC Class B 3M Radiation  
 EUT:Bluetooth Headset  
 M/N: BT200  
 Mode: Middle Channel TX  
 Note:

Polarization: **Vertical**  
 Power:  
 Distance: 3m

Temperature: 26  
 Humidity: 60 %

No.	Mk	Freq.	Reading	Factor	Measurement	Limit	Over	Detector	Antenna Height	Table Degree	Comment
		MHz	dBuV	dB/m	dBuV/m	dBuV/m	dB		cm	degree	
1	!	180.3500	24.11	13.98	38.09	43.50	-5.41	peak			
2		299.9833	22.43	15.41	37.84	46.00	-8.16	peak			
3	!	419.6167	21.12	19.67	40.79	46.00	-5.21	peak			
4	!	447.1000	20.30	20.50	40.80	46.00	-5.20	peak			
5	*	539.2500	19.80	22.19	41.99	46.00	-4.01	peak			
6		624.9333	15.62	23.29	38.91	46.00	-7.09	peak			

**RESULT: PASS**

**Note:** 1. Factor=Antenna Factor + Cable loss, Margin=Measurement-Limit.

2. The "Factor" value can be calculated automatically by software of measurement system.

RADIATED EMISSION TEST- (30MHZ-1GHZ)-HIGH CHANNEL-HORIZONTAL

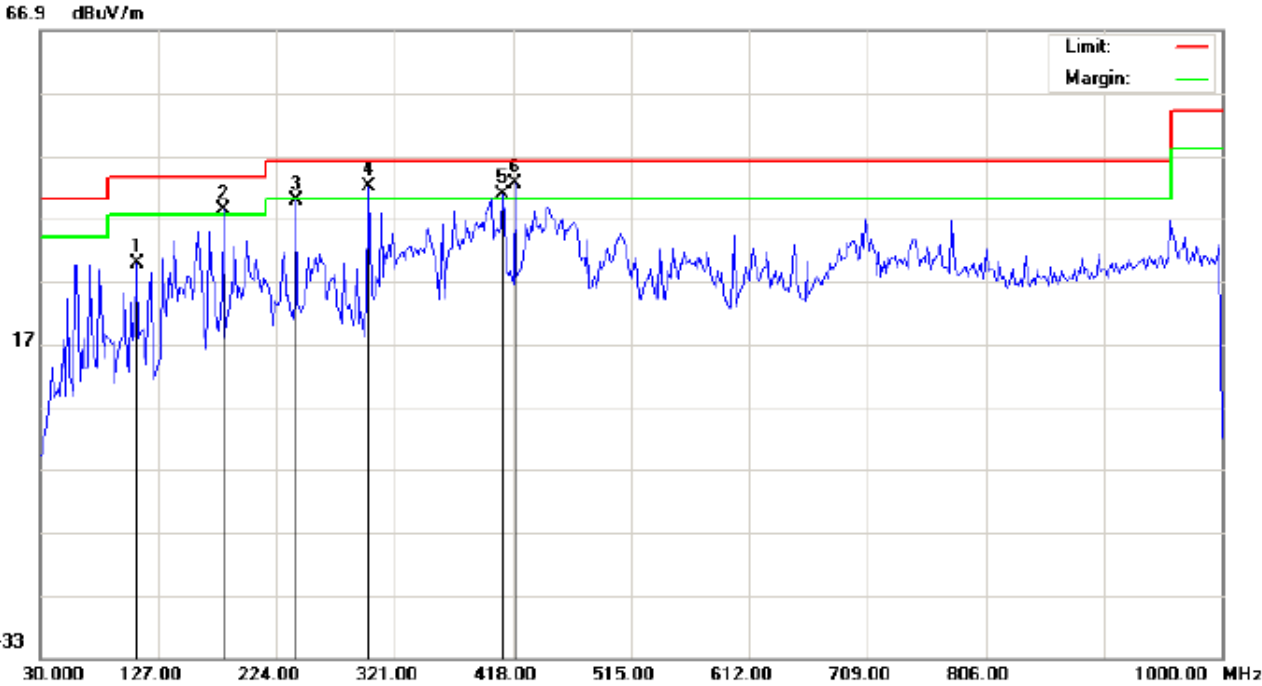

Site: site #1  
 Limit: FCC Class B 3M Radiation  
 EUT:Bluetooth Headset  
 M/N: BT200  
 Mode: High Channel TX  
 Note:

Polarization: *Horizontal*  
 Power:  
 Distance: 3m

Temperature: 26  
 Humidity: 60 %

No.	Mk	Freq.	Reading	Factor	Measurement	Limit	Over	Detector	Antenna Height	Table Degree	Comment
		MHz	dBuV	dB/m	dBuV/m	dBuV/m	dB		cm	degree	
1		109.2167	18.60	11.12	29.72	43.50	-13.78	peak			
2	!	180.3500	27.07	11.09	38.16	43.50	-5.34	peak			
3		240.1667	26.20	13.53	39.73	46.00	-6.27	peak			
4	!	299.9833	26.57	15.41	41.98	46.00	-4.02	peak			
5	!	409.9167	21.39	19.37	40.76	46.00	-5.24	peak			
6	*	419.6167	22.89	19.67	42.56	46.00	-3.44	peak			

**RESULT: PASS**

RADIATED EMISSION TEST- (30MHZ-1GHZ)-HIGH CHANNEL -VERTICAL

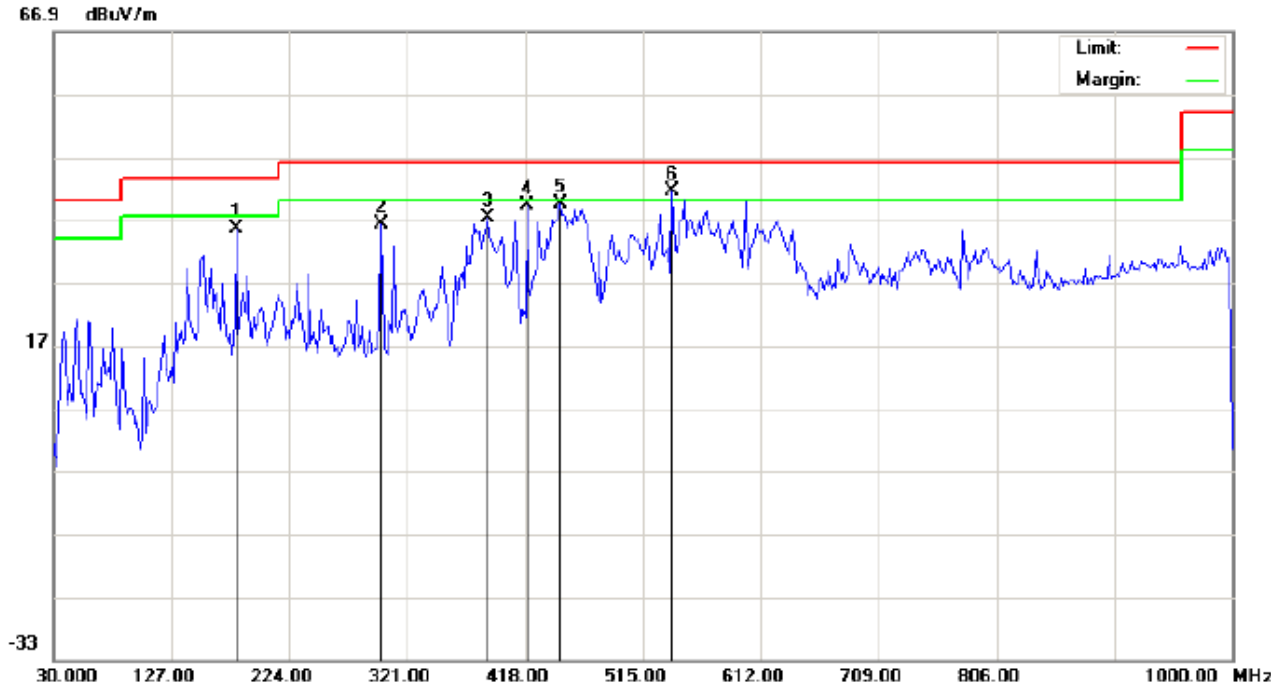

Site: site #1  
 Limit: FCC Class B 3M Radiation  
 EUT:Bluetooth Headset  
 M/N: BT200  
 Mode: High Channel TX  
 Note:

Polarization: *Vertical*  
 Power:  
 Distance: 3m

Temperature: 26  
 Humidity: 60 %

No.	Mk	Freq.	Reading	Factor	Measurement	Limit	Over	Detector	Antenna	Table	Comment
		MHz	dBuV	dB/m	dBuV/m	dBuV/m	dB		Height	Degree	
									cm	degree	
1		180.3500	21.64	13.98	35.62	43.50	-7.88	peak			
2		299.9833	20.95	15.41	36.36	46.00	-9.64	peak			
3		387.2833	18.29	18.99	37.28	46.00	-8.72	peak			
4		419.6167	19.67	19.67	39.34	46.00	-6.66	peak			
5		447.1000	18.96	20.50	39.46	46.00	-6.54	peak			
6	*	539.2500	19.35	22.19	41.54	46.00	-4.46	peak			

**RESULT: PASS**

- Note:** 1. Factor=Antenna Factor + Cable loss, Margin=Measurement-Limit.  
 2. The "Factor" value can be calculated automatically by software of measurement system.

**RADIATED EMISSION ABOVE 1GHZ**

**RADIATED EMISSION TEST- (ABOVE 1GHZ)-LOW CHANNEL-HORIZONTAL**

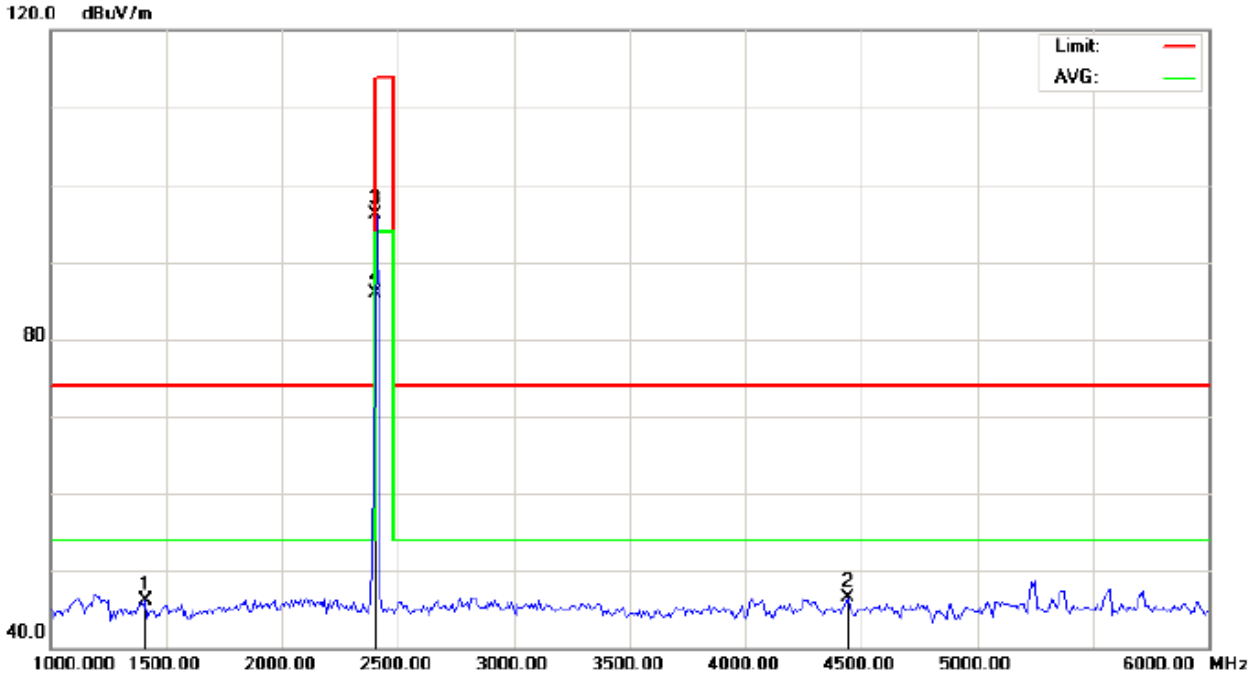

Site: site #1  
 Limit: FCC Class B 3M Radiation above 1GHZ(PK)-  
 EUT:Bluetooth Headset  
 M/N: BT200  
 Mode: Low Channel TX  
 Note:

Polarization: *Horizontal*  
 Power:  
 Distance: 3m

Temperature: 26  
 Humidity: 60 %

No.	Mk	Freq.	Reading	Factor	Measurement	Limit	Over	Detector	Antenna Height	Table Degree	Comment
		MHz	dBuV	dB/m	dBuV/m	dBuV/m	dB		cm	degree	
1		1408.333	61.47	-15.42	46.05	74.00	-27.95	peak			
2		4441.667	49.87	-3.31	46.56	74.00	-27.44	peak			
3		2402.000	105.73	-9.68	96.05	114.00	-17.95	peak			
4	*	2402.000	95.62	-9.68	85.94	94.00	-8.06	AVG	150	360	

**RESULT: PASS**

RADIATED EMISSION TEST- (ABOVE 1GHZ)-LOW CHANNEL- VERTICAL

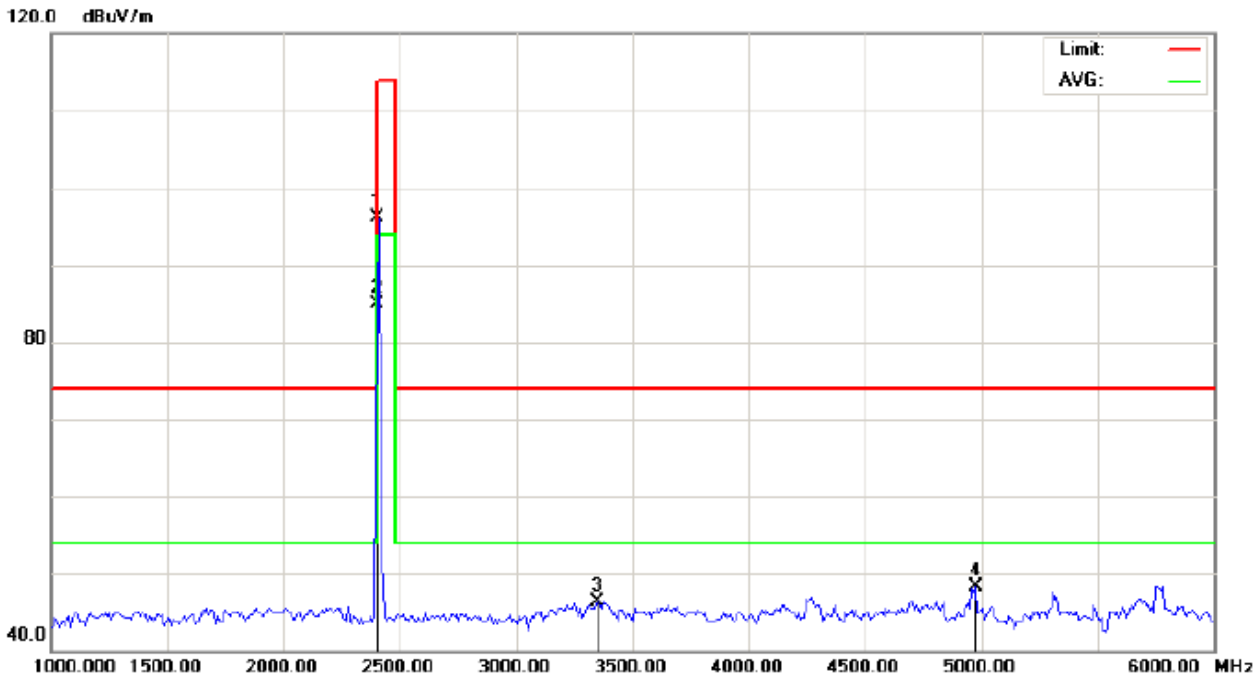

Site: site #1 Polarization: *Vertical* Temperature: 26  
 Limit: FCC Class B 3M Radiation above 1GHZ(PK)- Power: Humidity: 60 %  
 EUT: Bluetooth Headset Distance: 3m  
 M/N: BT200  
 Mode: Low Channel TX  
 Note:

No.	Mk	Freq.	Reading	Factor	Measurement	Limit	Over	Detector	Antenna Height	Table Degree	Comment
		MHz	dBuV	dB/m	dBuV/m	dBuV/m	dB		cm	degree	
1		2402.000	105.70	-9.68	96.02	114.00	-17.98	peak			
2	*	2402.000	94.52	-9.68	84.84	94.00	-9.16	AVG	150	39	
3		3350.000	54.39	-8.03	46.36	74.00	-27.64	peak			
4		4975.000	50.19	-1.87	48.32	74.00	-25.68	peak			

**RESULT: PASS**

RADIATED EMISSION TEST- (ABOVE 1GHZ)-MIDDLE CHANNEL-HORIZONTAL

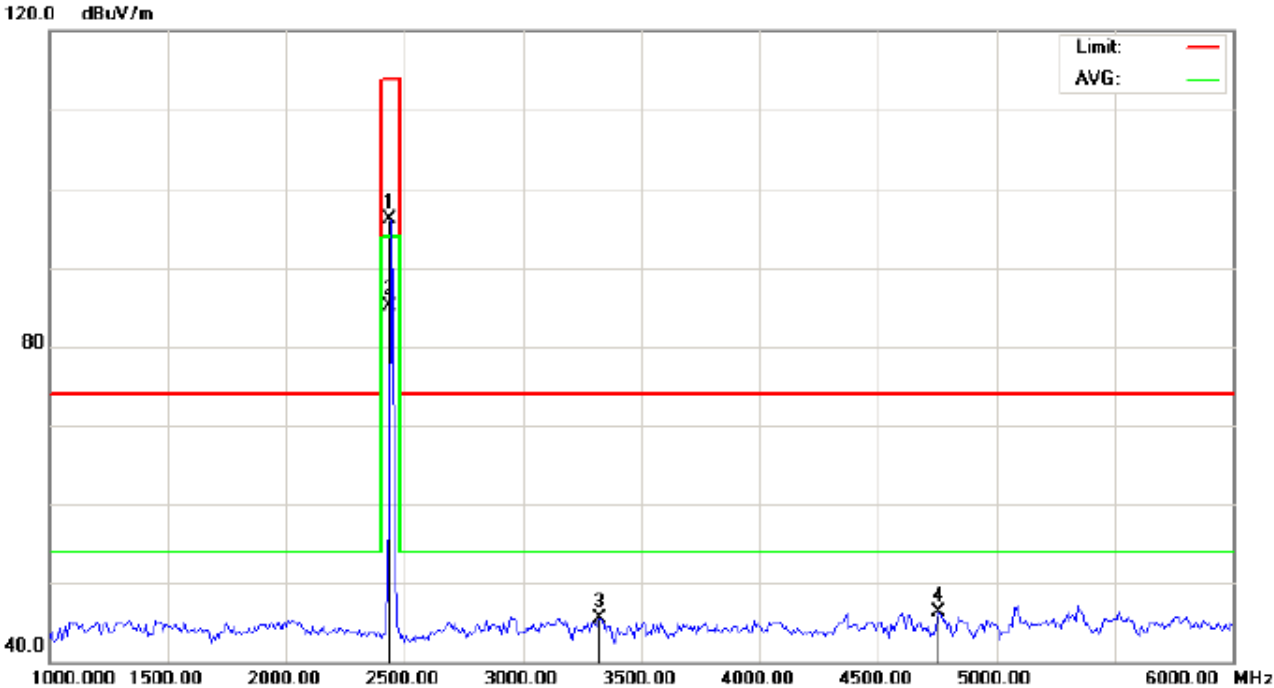

Site: site #1  
 Limit: FCC Class B 3M Radiation above 1GHZ(PK)-  
 EUT:Bluetooth Headset  
 M/N: BT200  
 Mode: Middle Channel TX  
 Note:

Polarization: *Horizontal*  
 Power:  
 Distance: 3m

Temperature: 26  
 Humidity: 60 %

No.	Mk	Freq.	Reading	Factor	Measurement	Limit	Over	Detector	Antenna Height	Table Degree	Comment
		MHz	dBuV	dB/m	dBuV/m	dBuV/m	dB		cm	degree	
1		2440.000	105.80	-9.64	96.16	114.00	-17.84	peak			
2	*	2440.000	94.78	-9.64	85.14	94.00	-8.86	AVG	150	167	
3		3325.000	53.56	-8.05	45.51	74.00	-28.49	peak			
4		4758.333	48.65	-2.43	46.22	74.00	-27.78	peak			

RESULT: PASS

RADIATED EMISSION TEST- (ABOVE 1GHZ)-MIDDLE CHANNEL- VERTICAL

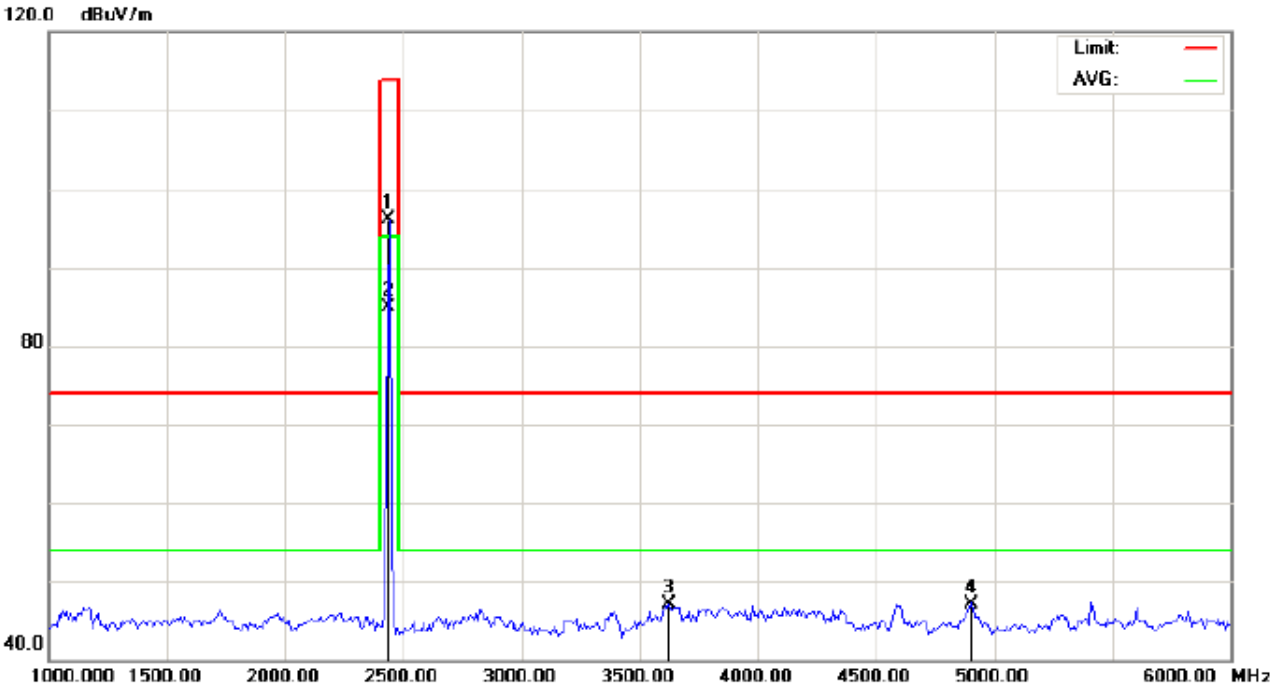

Site: site #1  
 Limit: FCC Class B 3M Radiation above 1GHZ(PK)-  
 EUT:Bluetooth Headset  
 M/N: BT200  
 Mode: Middle Channel TX  
 Note:

Polarization: *Vertical*  
 Power:  
 Distance: 3m

Temperature: 26  
 Humidity: 60 %

No.	Mk	Freq.	Reading	Factor	Measurement	Limit	Over	Detector	Antenna Height	Table Degree	Comment
		MHz	dBuV	dB/m	dBuV/m	dBuV/m	dB		cm	degree	
1		2440.000	105.76	-9.64	96.12	114.00	-17.88	peak			
2	*	2440.000	94.58	-9.64	84.94	94.00	-9.06	AVG	150	19	
3		3625.000	54.13	-7.12	47.01	74.00	-26.99	peak			
4		4900.000	49.26	-2.06	47.20	74.00	-26.80	peak			

**RESULT: PASS**

RADIATED EMISSION TEST- (ABOVE 1GHZ)-HIGH CHANNEL-HORIZONTAL

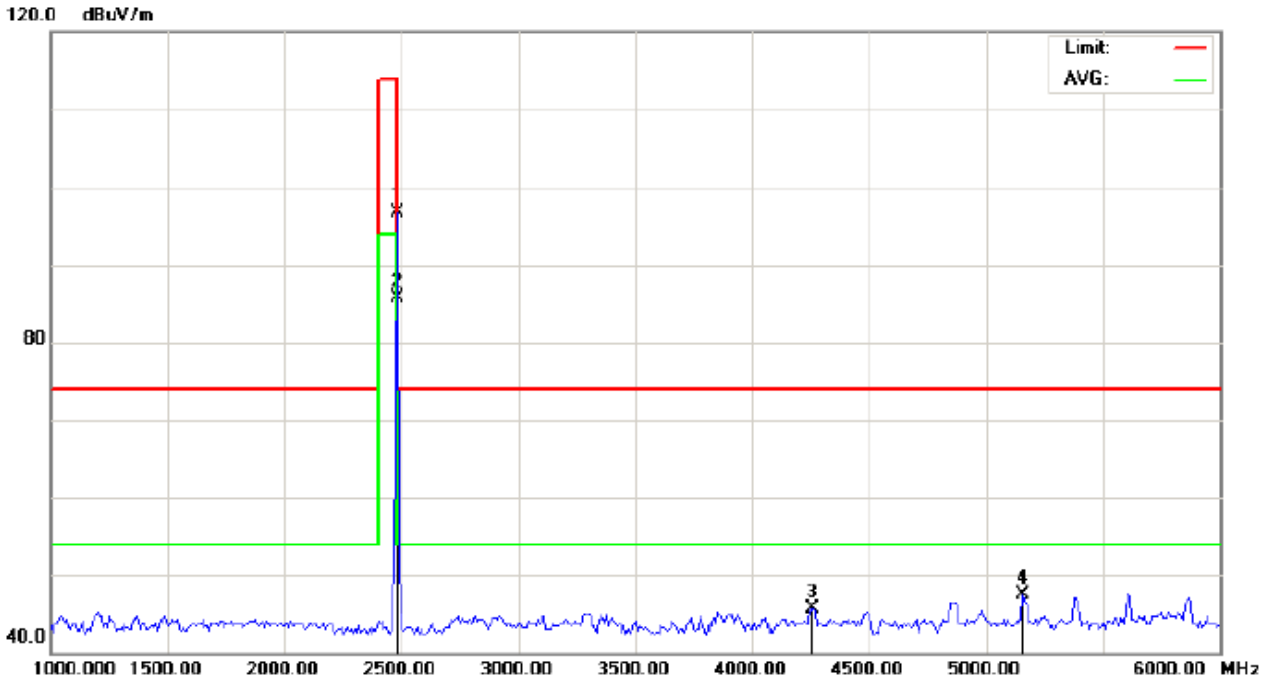

Site: site #1  
 Limit: FCC Class B 3M Radiation above 1GHZ(PK)-  
 EUT:Bluetooth Headset  
 M/N: BT200  
 Mode: High Channel TX  
 Note:

Polarization: *Horizontal*  
 Power:  
 Distance: 3m

Temperature: 26  
 Humidity: 60 %

No.	Mk	Freq.	Reading	Factor	Measurement	Limit	Over	Detector	Antenna Height	Table Degree	Comment
		MHz	dBuV	dB/m	dBuV/m	dBuV/m	dB		cm	degree	
1		2480.000	106.37	-9.59	96.78	114.00	-17.22	peak			
2	*	2480.000	95.37	-9.59	85.78	94.00	-8.22	AVG	150	245	
3		4258.333	49.65	-3.93	45.72	74.00	-28.28	peak			
4		5158.333	49.29	-1.80	47.49	74.00	-26.51	peak			

RESULT: PASS



### RADIATED EMISSION TEST- (ABOVE 1GHZ)-HIGH CHANNEL- VERTICAL

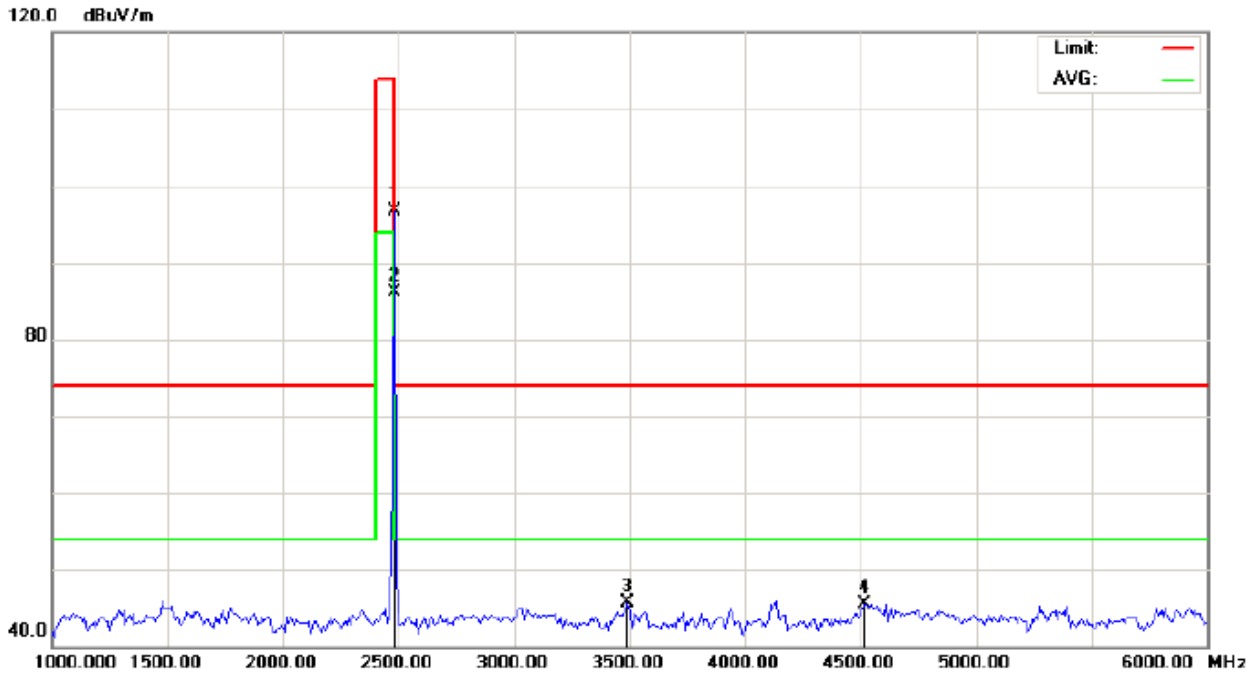

Site: site #1      Polarization: *Vertical*      Temperature: 26  
Limit: FCC Class B 3M Radiation above 1GHz(PK)-      Power:      Humidity: 60 %  
EUT:Bluetooth Headset      Distance: 3m  
M/N: BT200  
Mode: High Channel TX  
Note:

No.	Mk	Freq.	Reading	Factor	Measurement	Limit	Over	Detector	Antenna Height	Table Degree	Comment
		MHz	dBuV	dB/m	dBuV/m	dBuV/m	dB		cm	degree	
1	-	2480.000	106.35	-9.59	96.76	114.00	-17.24	peak			
2	*	2480.000	95.74	-9.59	86.15	94.00	-7.85	AVG	150	360	
3		3491.667	53.63	-7.90	45.73	74.00	-28.27	peak			
4		4516.667	48.61	-3.07	45.54	74.00	-28.46	peak			

**RESULT: PASS**

**Note:** 6~25GHz at least have 20dB margin. No recording in the test report.

Factor=Antenna Factor + Cable loss - Amplifier gain, Margin=Measurement-Limit.

The “Factor” value can be calculated automatically by software of measurement system.

**Field strength of the fundamental signal****Peak value**

Frequency	Reading Level	Factor	Measurement	Limit	Over	Antenna
(MHz)	(dBuv)	(dB/m)	(dBuv/m)	(dBuv/m)	(dB)	Polarization
2402	105.73	-9.68	96.05	114	-17.95	Horizontal
2402	105.70	-9.68	96.02	114	-17.98	Vertical
2440	105.80	-9.64	96.16	114	-17.84	Horizontal
2440	105.76	-9.64	96.12	114	-17.88	Vertical
2480	106.37	-9.59	96.78	114	-17.22	Horizontal
2480	106.35	-9.59	96.76	114	-17.24	Vertical

**Average value**

Frequency	Reading Level	Factor	Measurement	Limit	Over	Antenna
(MHz)	(dBuv)	(dB/m)	(dBuv/m)	(dBuv/m)	(dB)	Polarization
2402	95.62	-9.68	85.94	94	-8.06	Horizontal
2402	94.52	-9.68	84.84	94	-9.16	Vertical
2440	94.78	-9.64	85.14	94	-8.86	Horizontal
2440	94.58	-9.64	84.94	94	-9.06	Vertical
2480	95.37	-9.59	85.78	94	-8.22	Horizontal
2480	95.74	-9.59	86.15	94	-7.85	Vertical

### 9. BAND EDGE EMISSION

#### 9.1. MEASUREMENT PROCEDURE

1The EUT operates at hopping-off test mode. The lowest or highest channels are tested to verify the largest transmission and spurious emissions power at the continuous transmission mode.

2Max hold the trace of the setp 1,and the EUT operates at hopping-on test mode to verify the largest spurious emissions power.

3Set the spectrum analyzer in the following setting in order to capture the lower and upper band-edges of the emission: (a) PEAK: RBW=VBW=1MHz / Sweep=AUTO

(b) AVERAGE: RBW=1MHz ; VBW=1/on time(1KHz) / Sweep=AUTO

#### 9.2 TEST SETUP

RADIATED EMISSION TEST SETUP

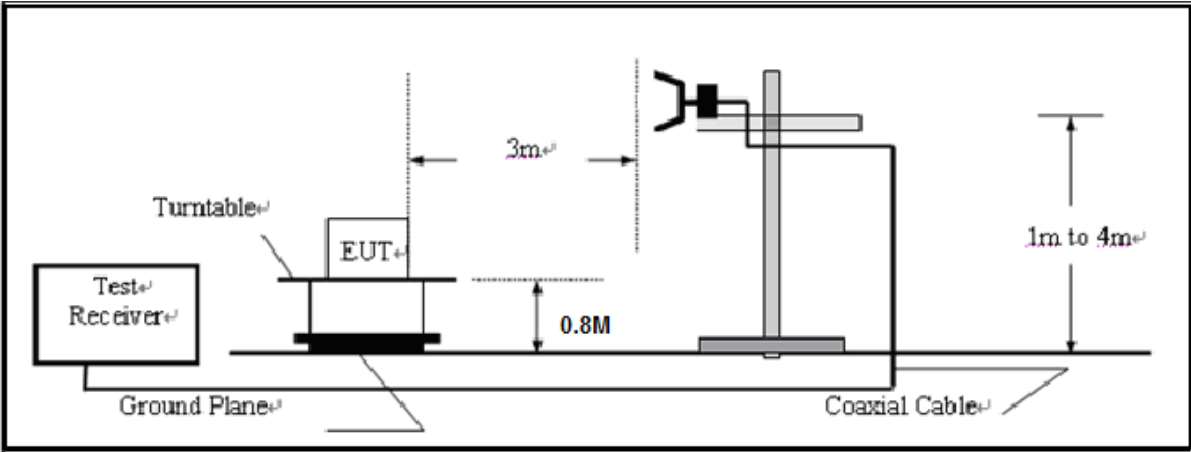

CONDUCTED TEST SETUP

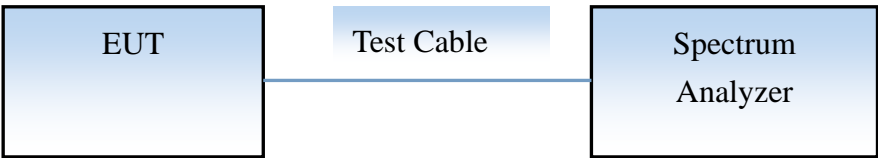

9.3 RADIATED TEST RESULT(Worst modulation:GFSK)

TEST PLOT OF BAND EDGE FOR LOW CHANNEL-Horizontal

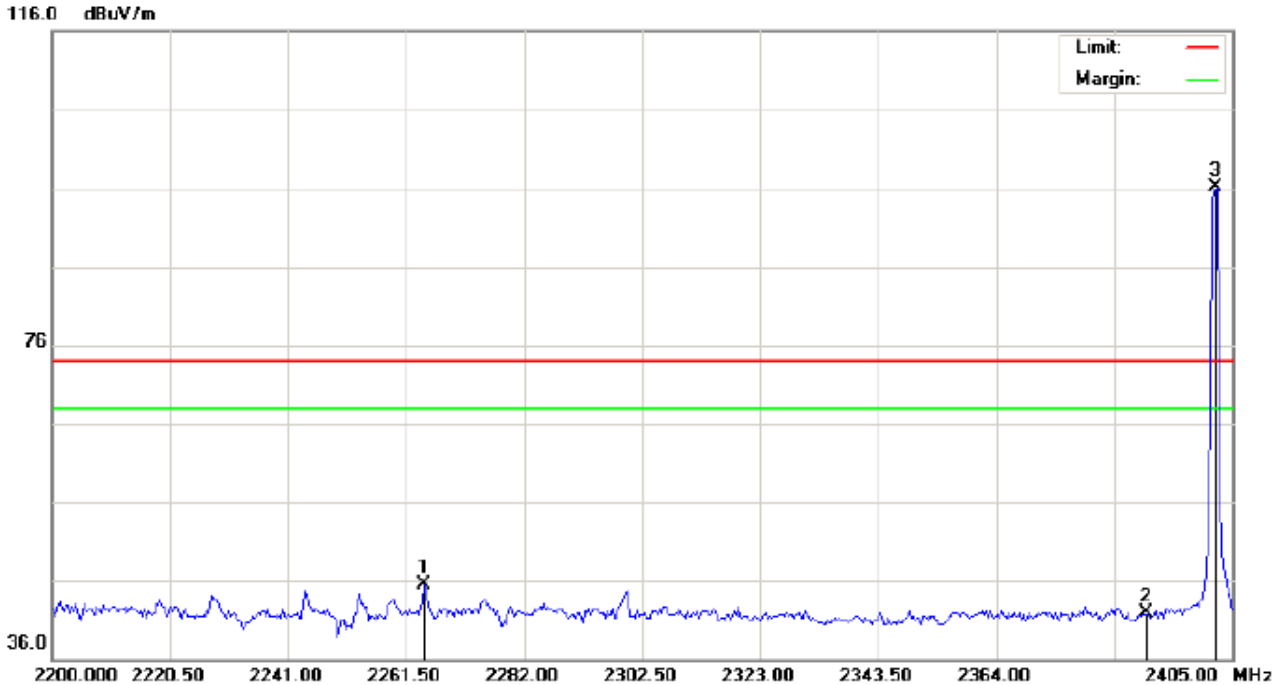

Site: site #1  
 Limit: FCC Class B 3M Radiation above 1GHZ(PK)  
 EUT:Bluetooth Headset  
 M/N: BT200  
 Mode: Low Channel TX  
 Note:

Polarization: *Horizontal*  
 Power:  
 Distance:

Temperature: 26  
 Humidity: 60 %

No.	Mk	Freq.	Reading	Factor	Measurement	Limit	Over	Detector	Antenna Height	Table Degree	Comment
		MHz	dBuV	dB/m	dBuV/m	dBuV/m	dB		cm	degree	
1		2264.575	35.25	10.17	45.42	74.00	-28.58	peak			
2		2390.000	31.50	10.31	41.81	74.00	-32.19	peak			
3	*	2402.000	85.72	10.32	96.04	74.00	22.04	peak			

TEST PLOT OF BAND EDGE FOR LOW CHANNEL -Vertical

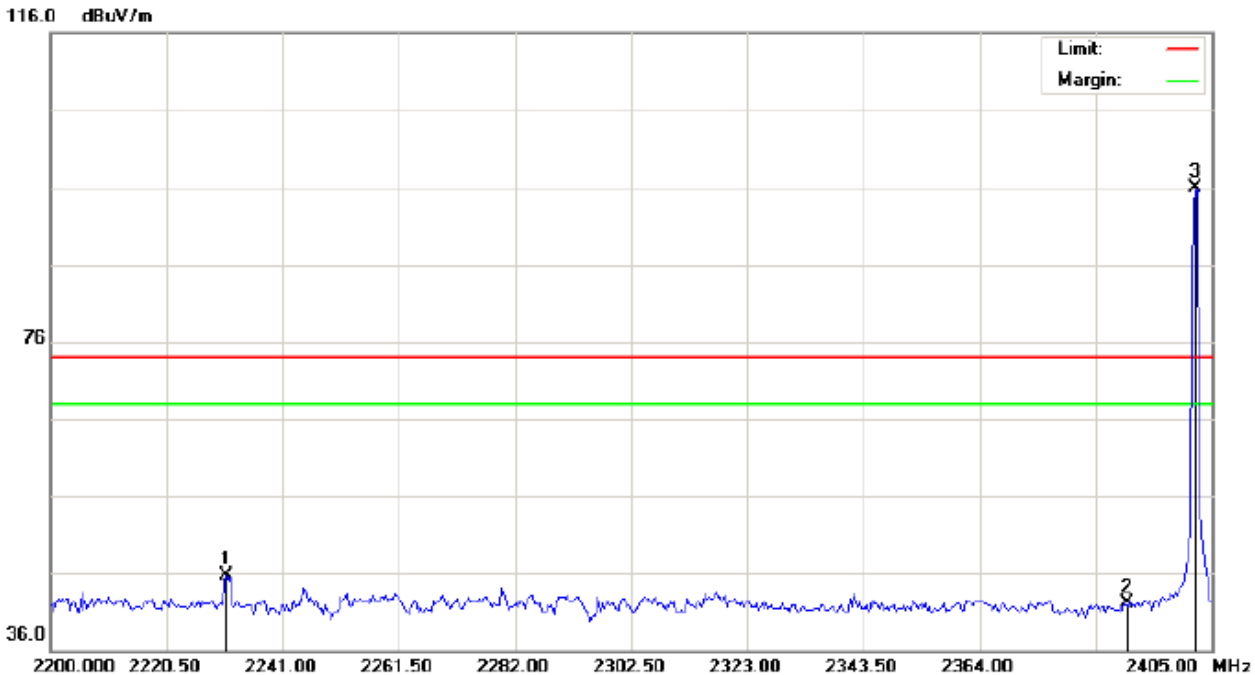

Site: site #1	Polarization: <i>Vertical</i>	Temperature: 26
Limit: FCC Class B 3M Radiation above 1GHZ(PK)	Power:	Humidity: 60 %
EUT:Bluetooth Headset	Distance:	
M/N: BT200		
Mode: Low Channel TX		
Note:		

No.	Mk	Freq.	Reading	Factor	Measurement	Limit	Over	Detector	Antenna Height	Table Degree	Comment
		MHz	dBuV	dB/m	dBuV/m	dBuV/m	dB		cm	degree	
1		2231.092	35.54	10.13	45.67	74.00	-28.33	peak			
2		2390.000	31.71	10.31	42.02	74.00	-31.98	peak			
3	*	2402.000	85.59	10.32	95.91	74.00	21.91	peak			

TEST PLOT OF BAND EDGE FOR HIGH CHANNEL -Horizontal

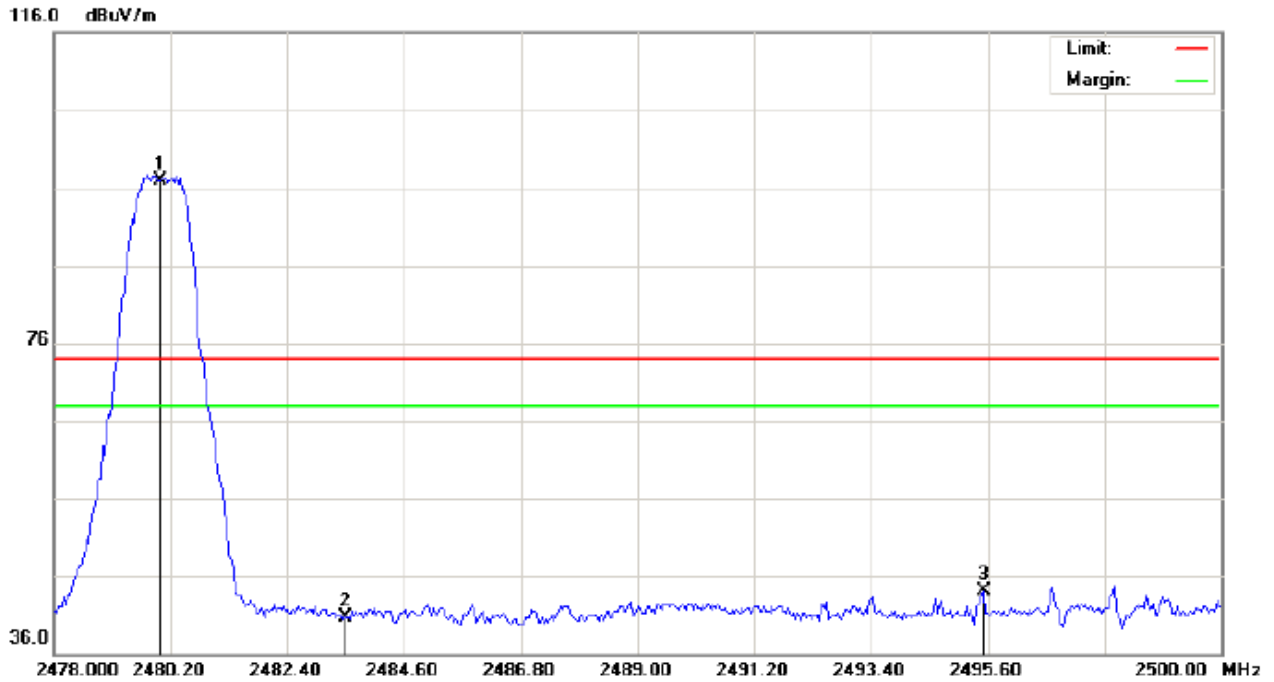

Site: site #1 Polarization: *Horizontal* Temperature: 26  
 Limit: FCC Class B 3M Radiation above 1GHZ(PK) Power: Humidity: 60 %  
 EUT:Bluetooth Headset Distance:  
 M/N: BT200  
 Mode: High Channel TX  
 Note:

No.	Mk	Freq.	Reading	Factor	Measurement	Limit	Over	Detector	Antenna	Table	Comment
		MHz	dBuV	dB/m	dBuV/m	dBuV/m	dB		Height	Degree	
									cm	degree	
1	*	2480.000	86.53	10.41	96.94	74.00	22.94	peak			
2		2483.500	30.19	10.41	40.60	74.00	-33.40	peak			
3		2495.527	33.67	10.42	44.09	74.00	-29.91	peak			

TEST PLOT OF BAND EDGE FOR HIGH CHANNEL-Vertical

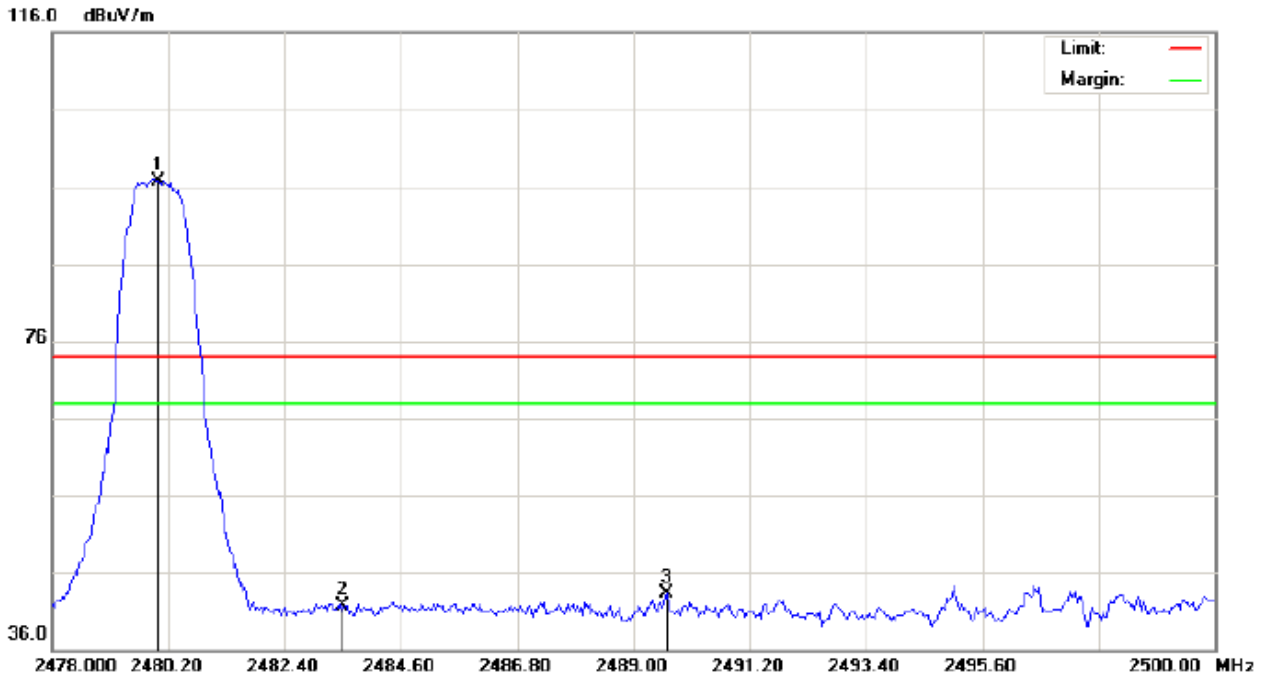

Site: site #1

Polarization: *Vertical*

Temperature: 26

Limit: FCC Class B 3M Radiation above 1GHZ(PK)

Power:

Humidity: 60 %

EUT:Bluetooth Headset

Distance:

M/N: BT200

Mode: High Channel TX

Note:

No.	Mk	Freq.	Reading	Factor	Measurement	Limit	Over	Detector	Antenna Height	Table Degree	Comment
		MHz	dBuV	dB/m	dBuV/m	dBuV/m	dB		cm	degree	
1	*	2480.000	86.32	10.41	96.73	74.00	22.73	peak			
2		2483.500	31.26	10.41	41.67	74.00	-32.33	peak			
3		2489.623	32.95	10.42	43.37	74.00	-30.63	peak			

**RESULT: PASS**

**Note:** The other modes radiation emission have enough 20dB margin.

Factor=Antenna Factor + Cable loss - Amplifier gain, Over=Measure-Limit.

The “Factor” value can be calculated automatically by software of measurement system.

## 10. 20DB BANDWIDTH

### 10.1. MEASUREMENT PROCEDURE

1. Connect EUT RF output port to the Spectrum Analyzer through an RF attenuator
2. Set the EUT Work on the top, the middle and the bottom operation frequency individually.
3. Set Span = approximately 2 to 3 times the 20 dB bandwidth, centered on a hopping channel  
RBW  $\geq$  1% of the 20 dB bandwidth, VBW  $\geq$  RBW; Sweep = auto; Detector function = peak
4. Set SPA Trace 1 Max hold, then View.

### 10.2. TEST SET-UP (BLOCK DIAGRAM OF CONFIGURATION)

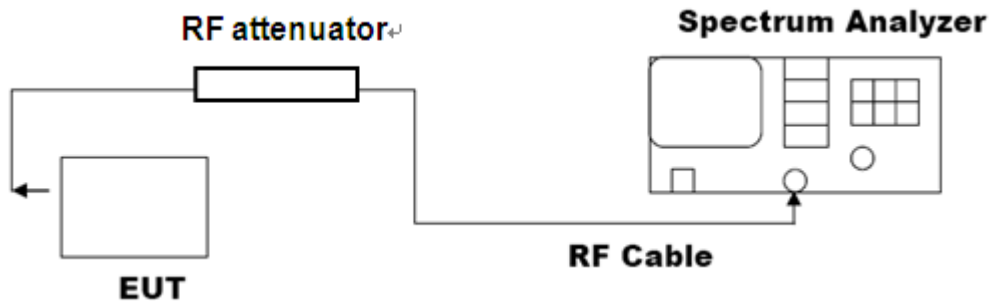

### 10.3. LIMITS AND MEASUREMENT RESULTS

BLUETOOTH 1MBPS LIMITS AND MEASUREMENT RESULT			
Applicable Limits	Measurement Result		
	Test Data (MHz)		Criteria
N/A	Low Channel	0.855	PASS
	Middle Channel	0.816	PASS
	High Channel	0.840	PASS



TEST PLOT OF BANDWIDTH FOR LOW CHANNEL

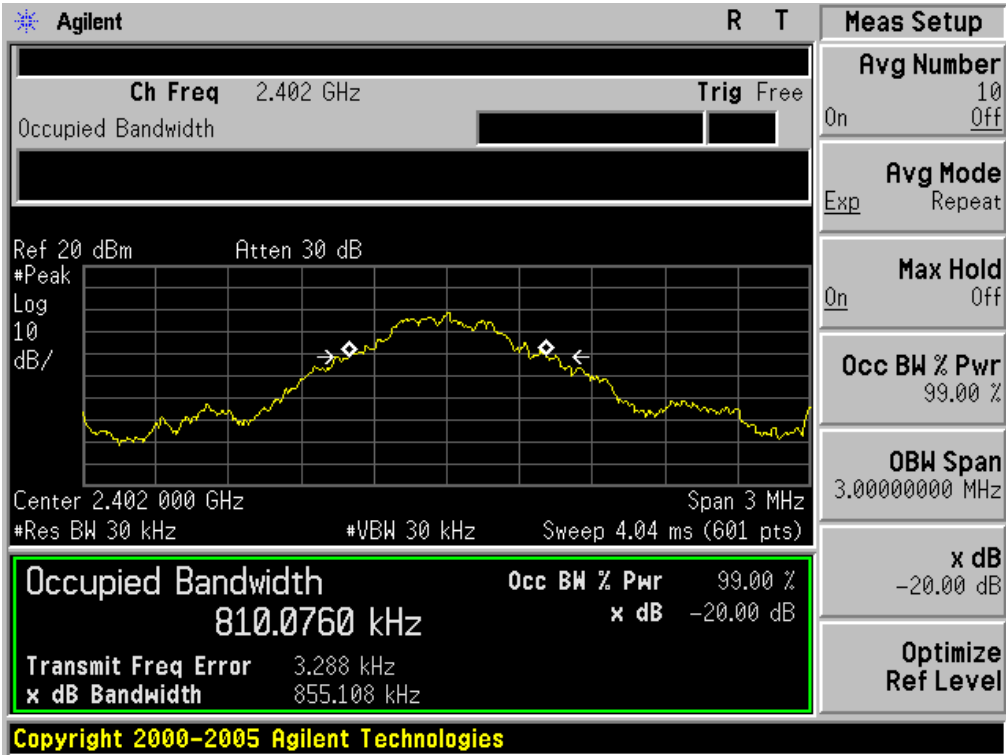

TEST PLOT OF BANDWIDTH FOR MIDDLE CHANNEL

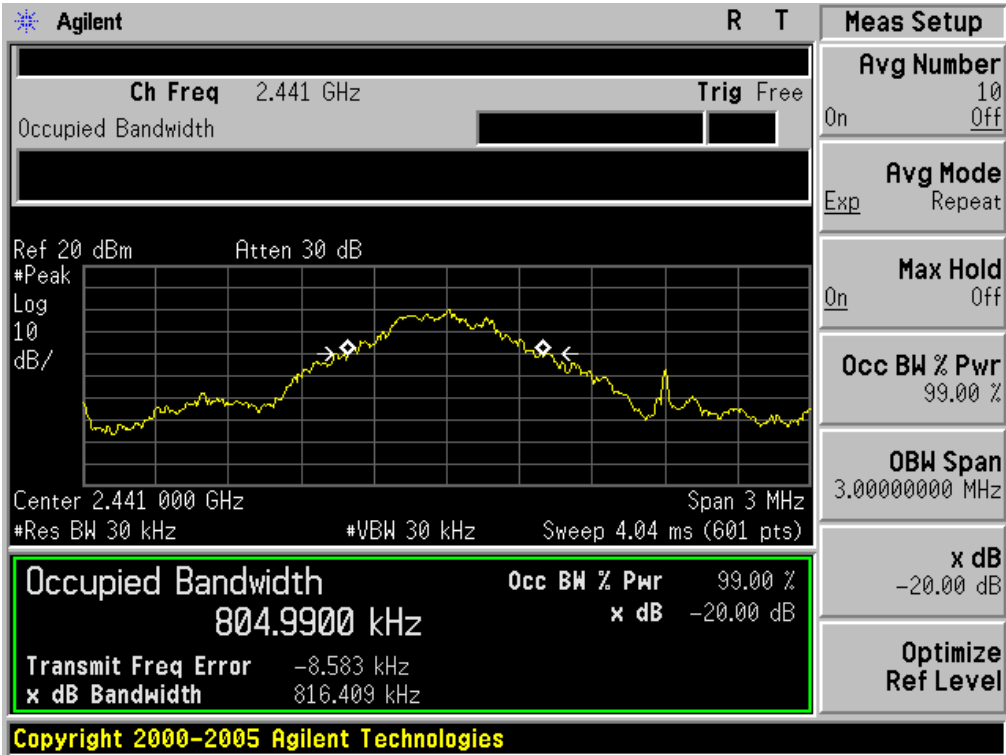

TEST PLOT OF BANDWIDTH FOR HIGH CHANNEL

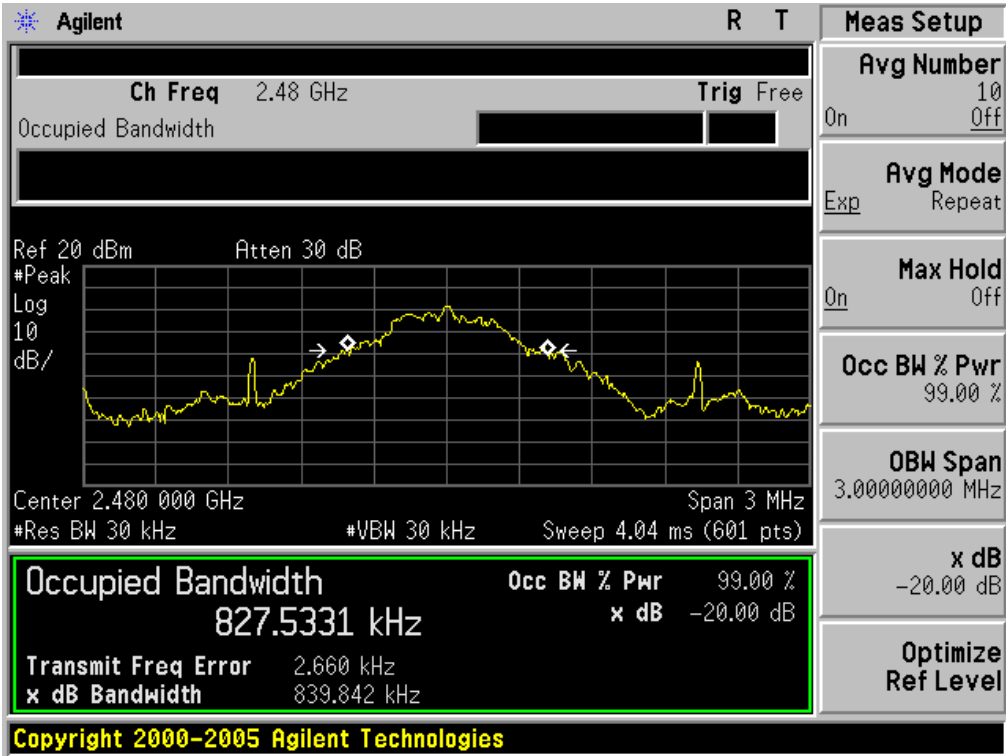

BLUETOOTH 2Mbps LIMITS AND MEASUREMENT RESULT			
Applicable Limits	Measurement Result		
	Test Data (MHz)		Criteria
N/A	Low Channel	1.379	PASS
	Middle Channel	1.375	PASS
	High Channel	1.329	PASS

TEST PLOT OF BANDWIDTH FOR LOW CHANNEL

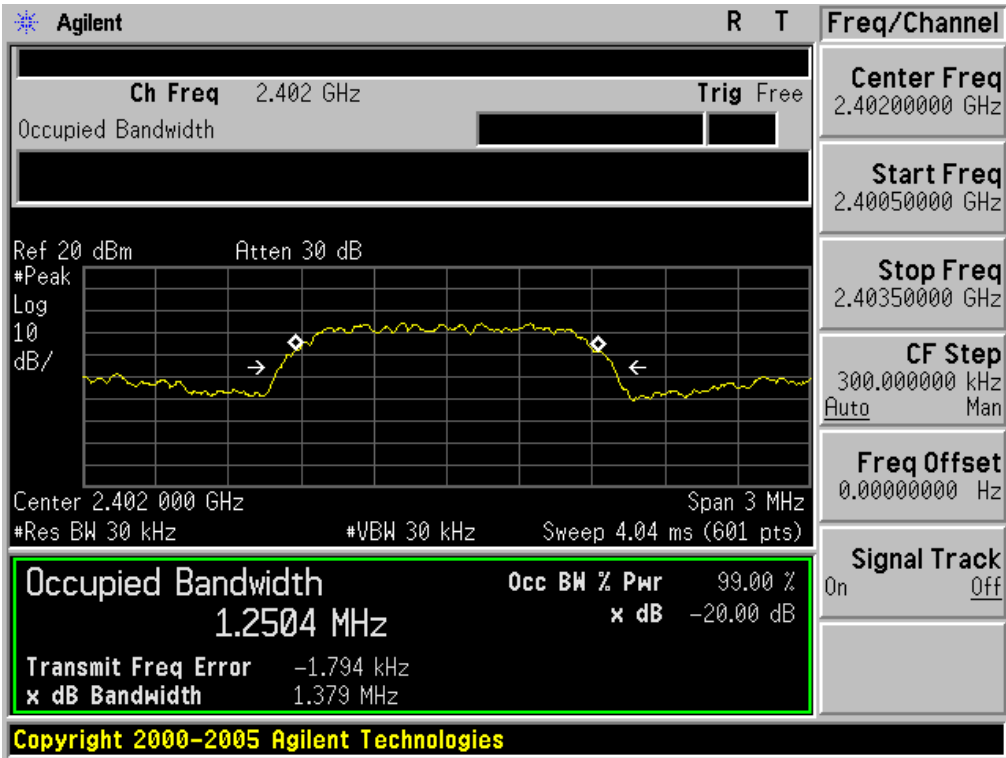

TEST PLOT OF BANDWIDTH FOR MIDDLE CHANNEL

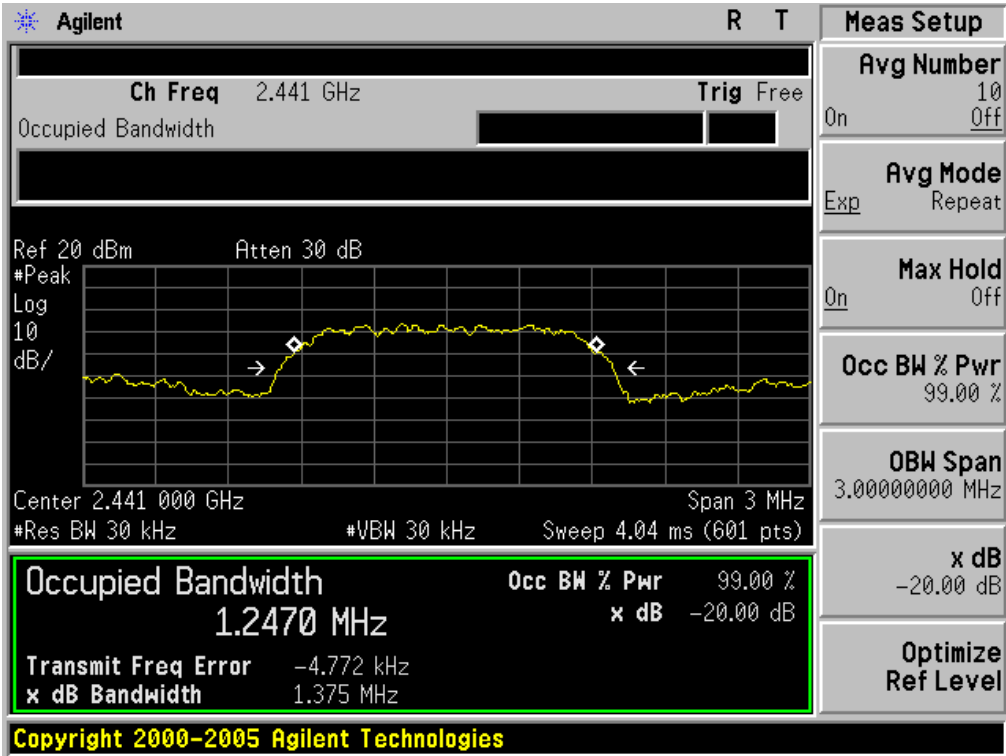

TEST PLOT OF BANDWIDTH FOR HIGH CHANNEL

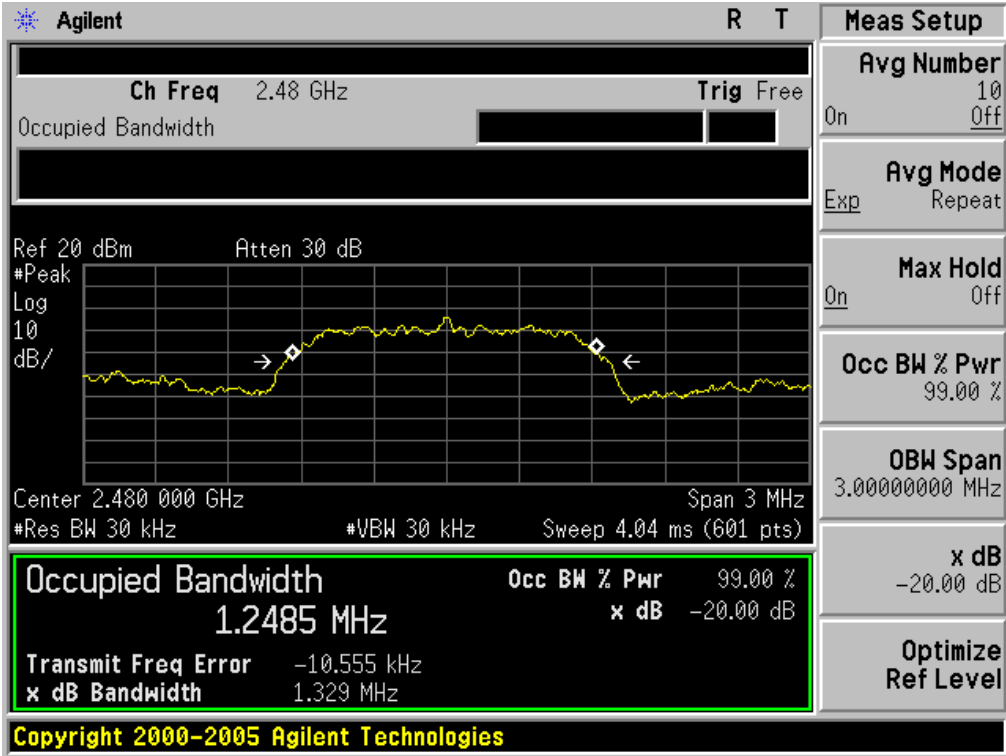

BLUETOOTH 3MBPS LIMITS AND MEASUREMENT RESULT			
Applicable Limits	Measurement Result		
	Test Data (MHz)		Criteria
N/A	Low Channel	1.359	PASS
	Middle Channel	1.349	PASS
	High Channel	1.379	PASS

TEST PLOT OF BANDWIDTH FOR LOW CHANNEL

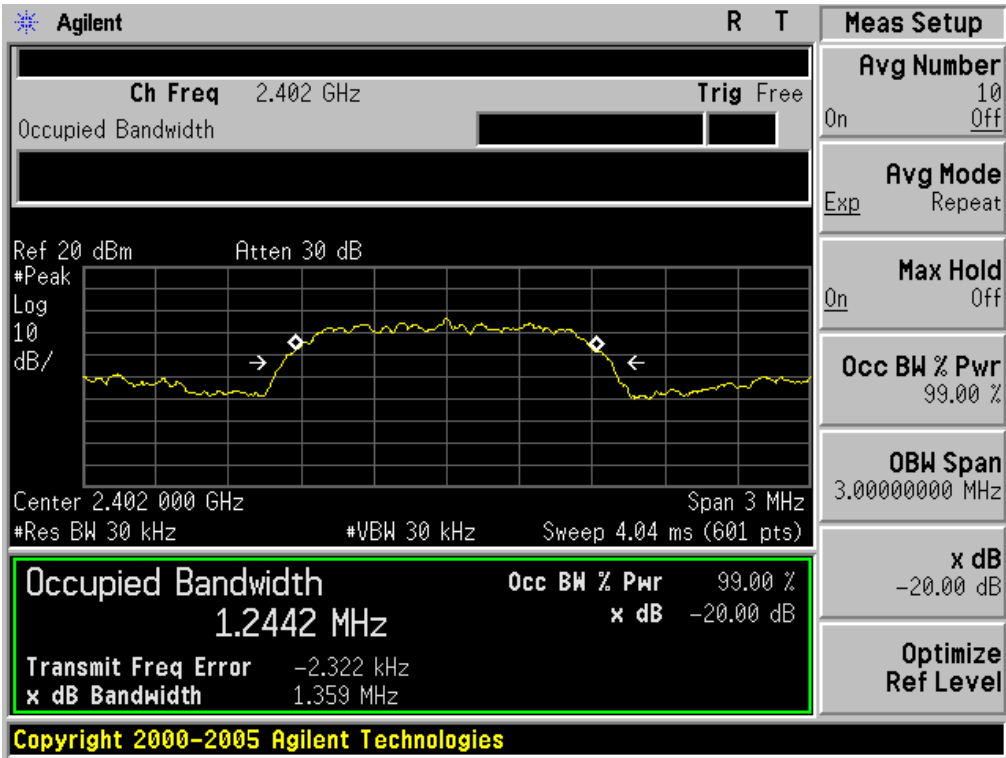

TEST PLOT OF BANDWIDTH FOR MIDDLE CHANNEL

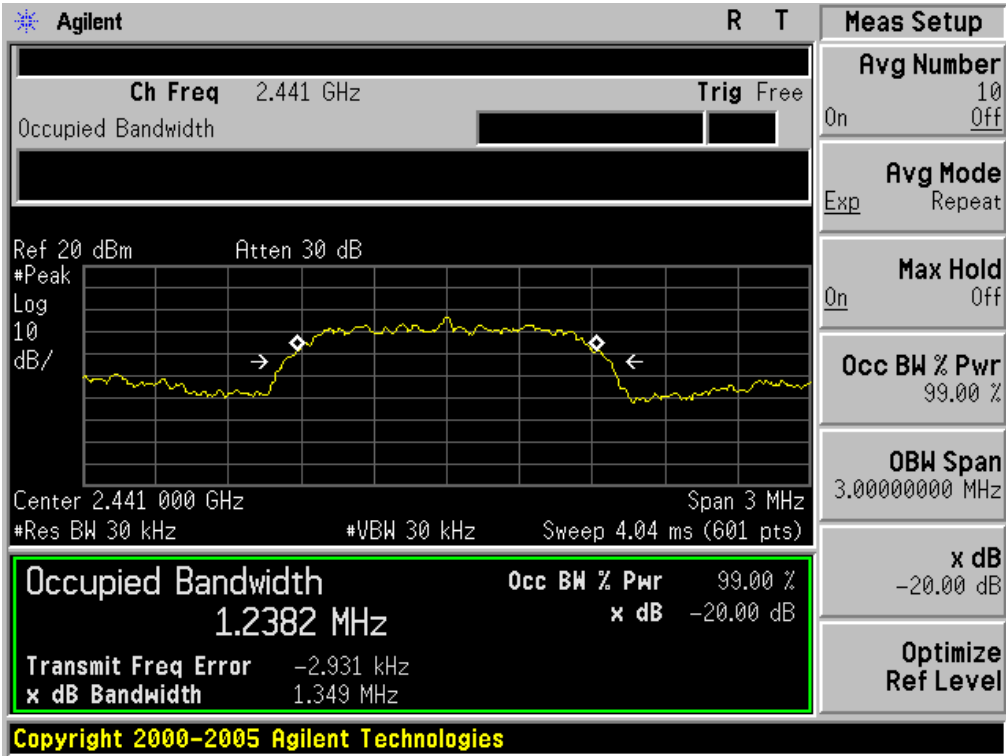

TEST PLOT OF BANDWIDTH FOR HIGH CHANNEL

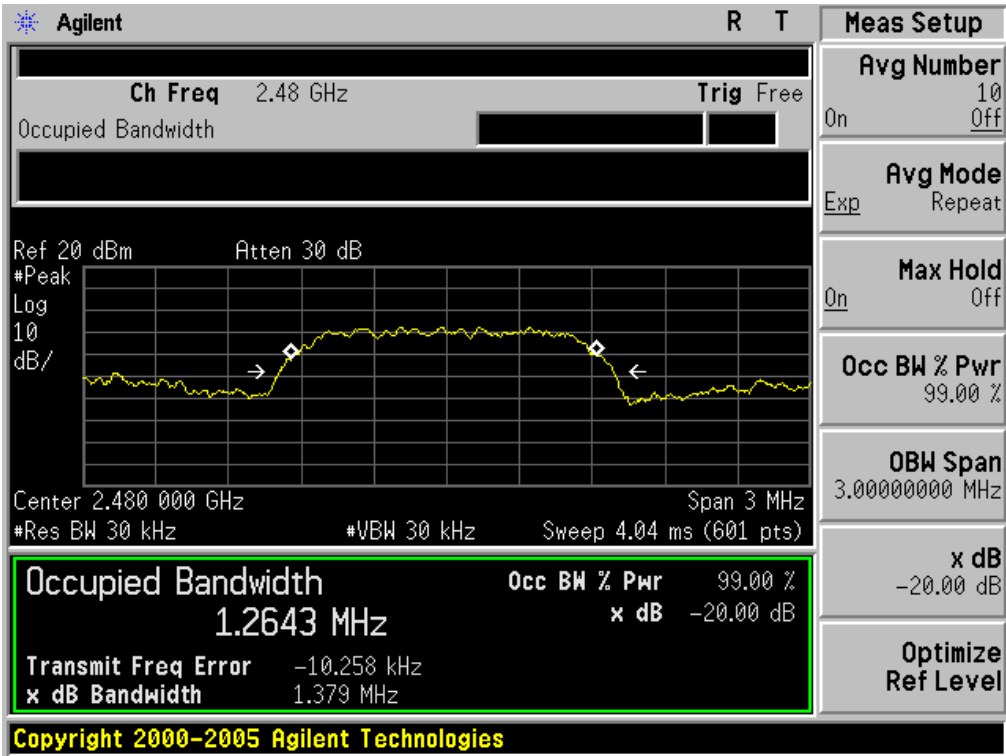

**11. FCC LINE CONDUCTED EMISSION TEST**

**11.1. LIMITS OF LINE CONDUCTED EMISSION TEST**

Frequency	Maximum RF Line Voltage	
	Q.P.( dBuV)	Average( dBuV)
150kHz~500kHz	66-56	56-46
500kHz~5MHz	56	46
5MHz~30MHz	60	50

Note:

1. The lower limit shall apply at the transition frequency.
2. The limit decreases linearly with the logarithm of the frequency in the range 0.15 MHz to 0.50 MHz.

**11.2. BLOCK DIAGRAM OF LINE CONDUCTED EMISSION TEST**

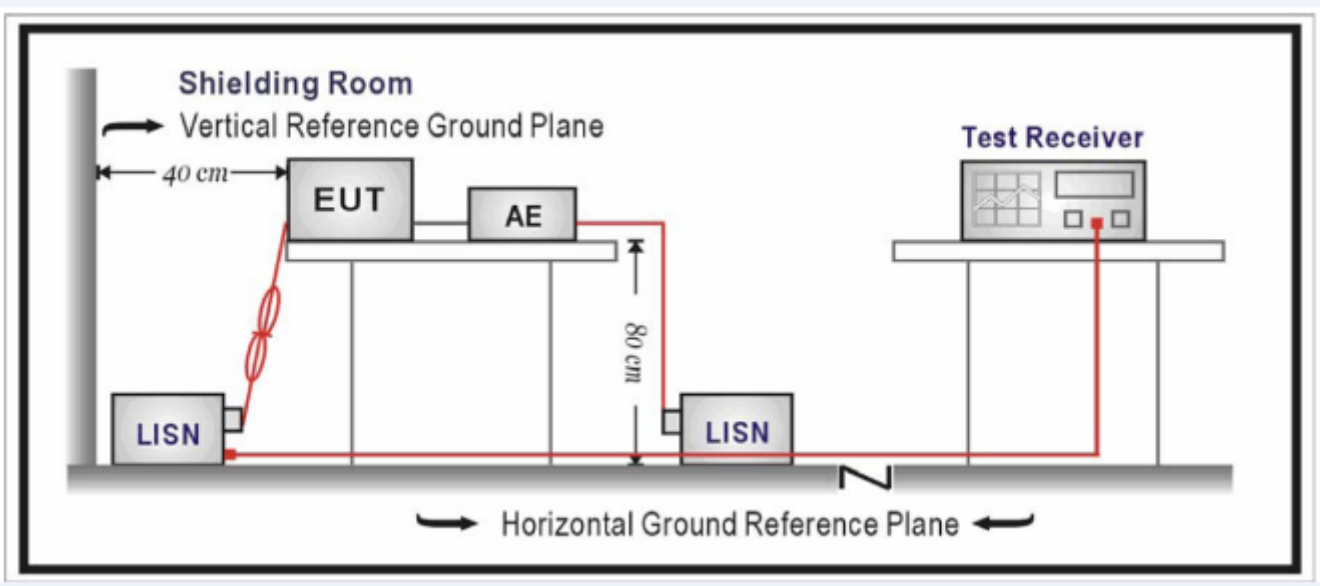

### **11.3. PRELIMINARY PROCEDURE OF LINE CONDUCTED EMISSION TEST**

1. The equipment was set up as per the test configuration to simulate typical actual usage per the user's manual. When the EUT is a tabletop system, a wooden table with a height of 0.8 meters is used and is placed on the ground plane as per ANSI C63.4 (see Test Facility for the dimensions of the ground plane used). When the EUT is a floor-standing equipment, it is placed on the ground plane which has a 3-12 mm non-conductive covering to insulate the EUT from the ground plane.
2. Support equipment, if needed, was placed as per ANSI C63.4.
3. All I/O cables were positioned to simulate typical actual usage as per ANSI C63.4.
4. All support equipments received AC120V/60Hz power from a LISN, if any.
5. The EUT received DC charging voltage by PC which received 120V/60Hz power by a LISN..
6. The test program was started. Emissions were measured on each current carrying line of the EUT using a spectrum Analyzer / Receiver connected to the LISN powering the EUT. The LISN has two monitoring points: Line 1 (Hot Side) and Line 2 (Neutral Side). Two scans were taken: one with Line 1 connected to Analyzer / Receiver and Line 2 connected to a 50 ohm load; the second scan had Line 1 connected to a 50 ohm load and Line 2 connected to the Analyzer / Receiver.
7. Analyzer / Receiver scanned from 150 kHz to 30MHz for emissions in each of the test modes.
8. During the above scans, the emissions were maximized by cable manipulation.
9. The test mode(s) were scanned during the preliminary test.

Then, the EUT configuration and cable configuration of the above highest emission level were recorded for reference of final testing.

### **11.4. FINAL PROCEDURE OF LINE CONDUCTED EMISSION TEST**

- EUT and support equipment was set up on the test bench as per step 2 of the preliminary test.
2. A scan was taken on both power lines, Line 1 and Line 2, recording at least the six highest emissions. Emission frequency and amplitude were recorded into a computer in which correction factors were used to calculate the emission level and compare reading to the applicable limit. If EUT emission level was less -2dB to the A.V. limit in Peak mode, then the emission signal was re-checked using Q.P and Average detector.
3. The test data of the worst case condition(s) was reported on the Summary Data page.



11.5. TEST RESULT OF LINE CONDUCTED EMISSION TEST

Line Conducted Emission Test Line 1-L

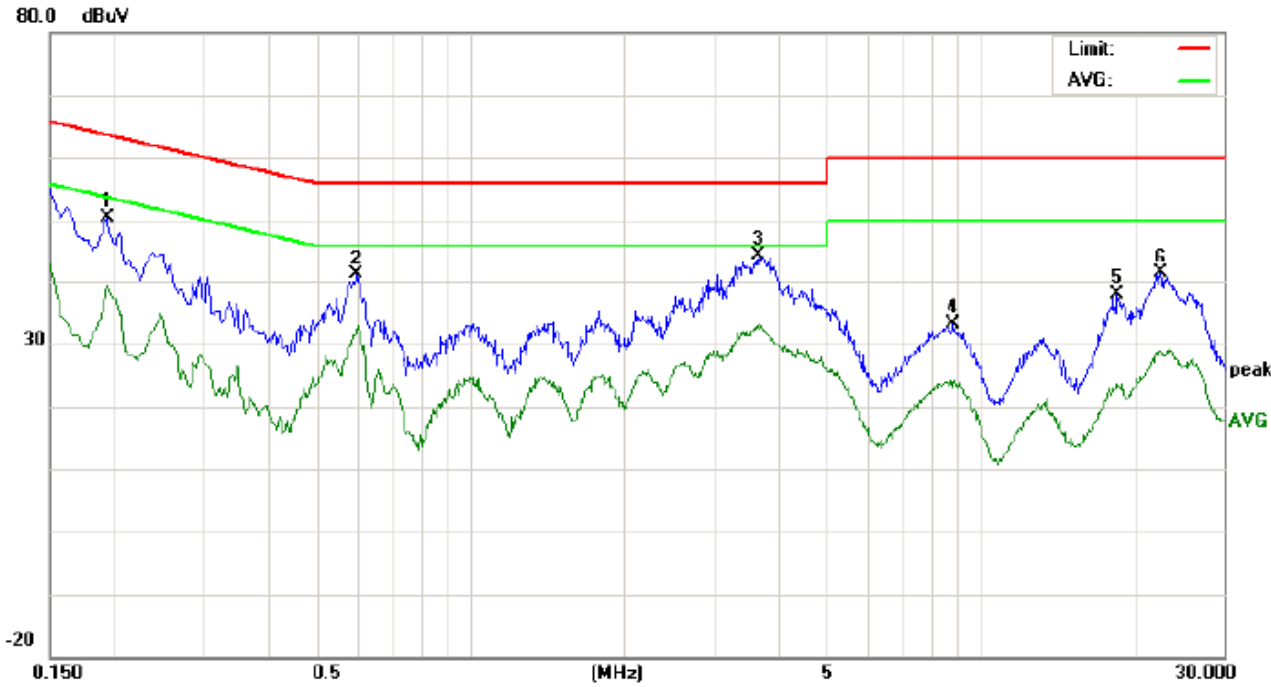

Site: Conduction Phase: L1 Temperature: 26  
 Limit: FCC Class B Conduction(QP) Power: Humidity: 60 %  
 EUT:Bluetooth Headset  
 M/N:BT200  
 Mode: Normal operation with charging  
 Note:

No.	Freq. (MHz)	Reading_Level (dBuV)			Correct Factor (dB)	Measurement (dBuV)			Limit (dBuV)		Margin (dB)		P/F	Comment
		Peak	QP	AVG		Peak	QP	AVG	QP	AVG	QP	AVG		
1	0.1940	40.13		29.19	10.21	50.34		39.40	63.86	53.86	-13.52	-14.46	P	
2	0.5980	30.86		21.66	10.31	41.17		31.97	56.00	46.00	-14.83	-14.03	P	
3	3.6740	33.97		22.63	10.48	44.45		33.11	56.00	46.00	-11.55	-12.89	P	
4	8.8660	22.98		13.41	10.24	33.22		23.65	60.00	50.00	-26.78	-26.35	P	
5	18.5540	27.78		13.43	10.12	37.90		23.55	60.00	50.00	-22.10	-26.45	P	
6	22.5860	31.17		18.80	10.11	41.28		28.91	60.00	50.00	-18.72	-21.09	P	

Line Conducted Emission Test Line 2-N

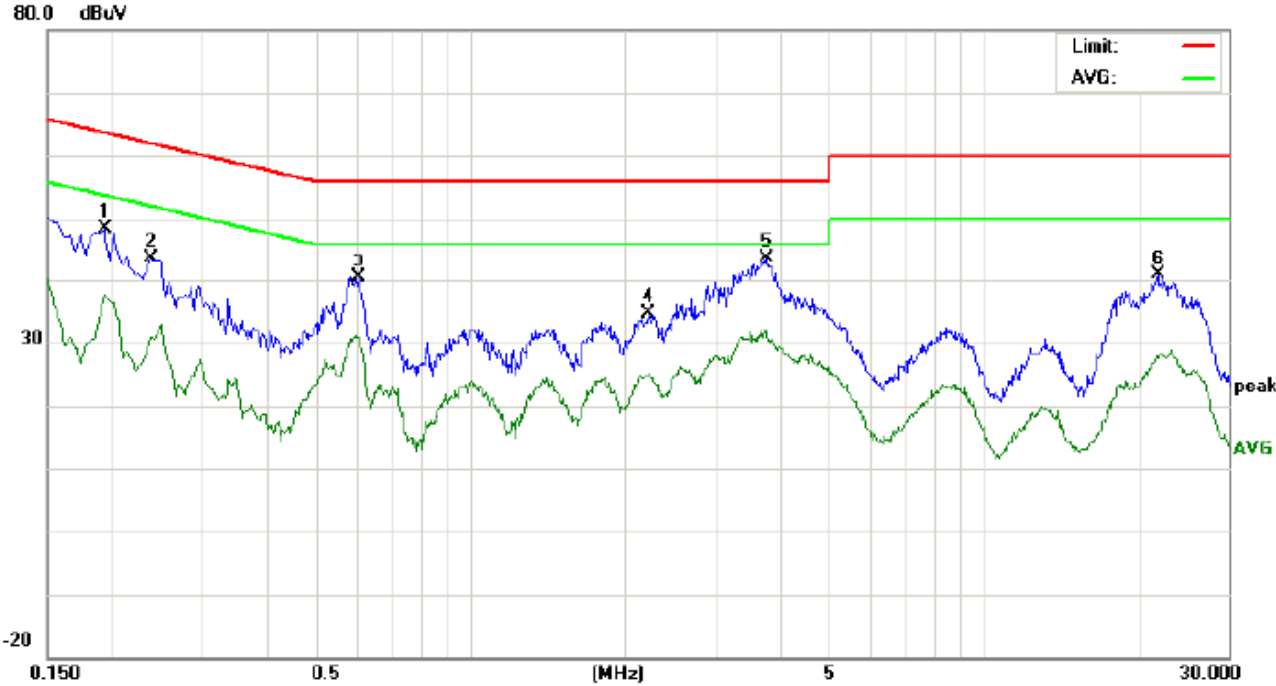

Site: Conduction Phase: **N** Temperature: 26  
 Limit: FCC Class B Conduction(QP) Power: Humidity: 60 %  
 EUT:Bluetooth Headset  
 M/N:BT200  
 Mode: Normal operation with charging  
 Note:

No.	Freq. (MHz)	Reading_Level (dBuV)			Correct Factor (dB)	Measurement (dBuV)			Limit (dBuV)		Margin (dB)		P/F	Comment
		Peak	QP	AVG		Peak	QP	AVG	QP	AVG	QP	AVG		
1	0.1940	38.20		27.33	10.21	48.41		37.54	63.86	53.86	-15.45	-16.32	P	
2	0.2380	33.34		20.61	10.26	43.60		30.87	62.16	52.16	-18.56	-21.29	P	
3	0.6060	30.05		20.54	10.31	40.36		30.85	56.00	46.00	-15.64	-15.15	P	
4	2.2300	24.18		14.88	10.32	34.50		25.20	56.00	46.00	-21.50	-20.80	P	
5	3.7900	33.29		20.70	10.46	43.75		31.16	56.00	46.00	-12.25	-14.84	P	
6	21.8980	30.64		17.62	10.12	40.76		27.74	60.00	50.00	-19.24	-22.26	P	

**APPENDIX A: PHOTOGRAPHS OF TEST SETUP**  
FCC LINE CONDUCTED EMISSION TEST SETUP



FCC RADIATED EMISSION TEST SETUP







**APPENDIX B: PHOTOGRAPHS OF EUT**  
TOTAL VIEW OF EUT



TOP VIEW OF EUT



BOTTOM VIEW OF EUT



FRONT VIEW OF EUT





BACK VIEW OF EUT



LEFT VIEW OF EUT



RIGHT VIEW OF EUT



VIEW OF EUT (PORT)





OPEN VIEW OF EUT-1



OPEN VIEW OF EUT-2

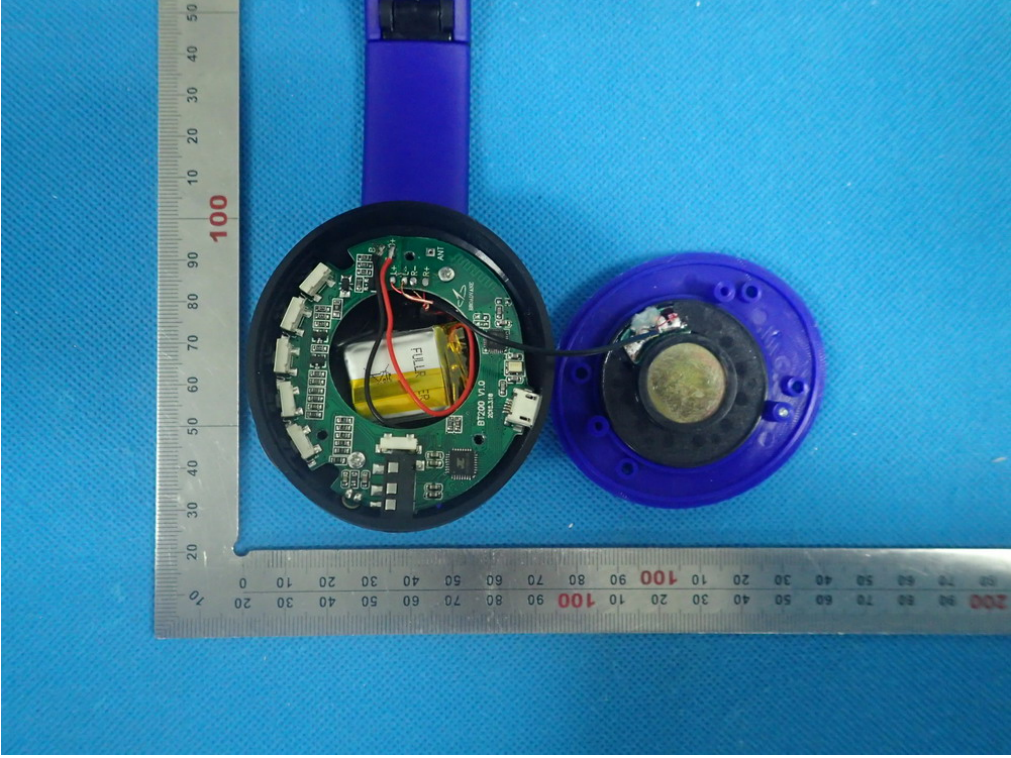



INTERNAL VIEW OF EUT-1

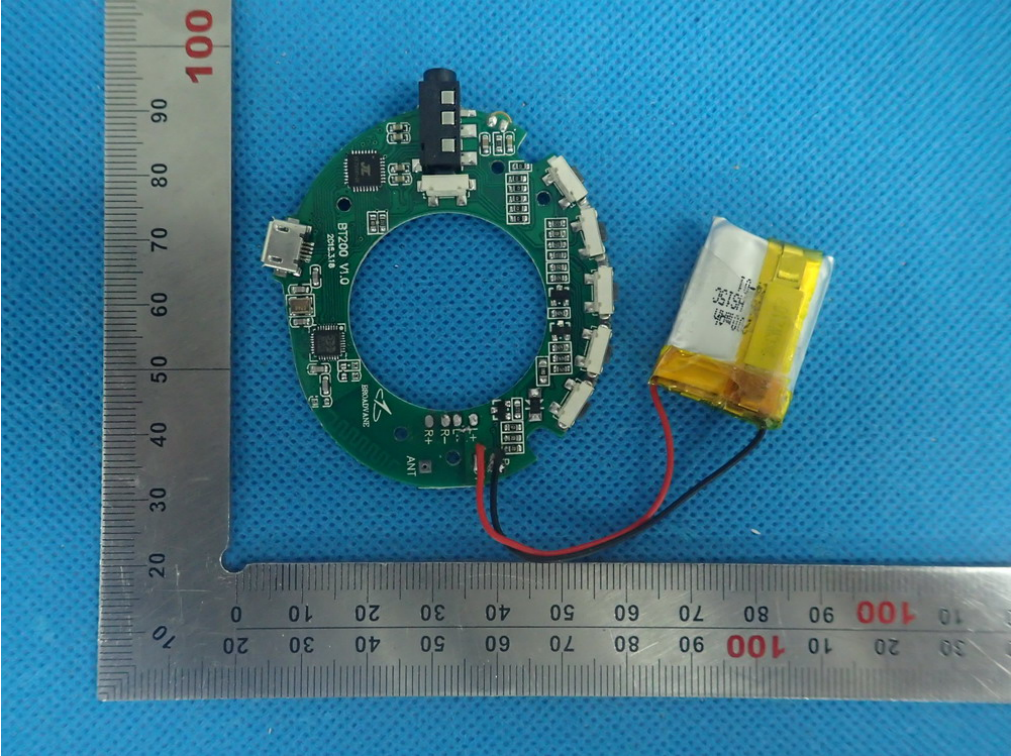

INTERNAL VIEW OF EUT-2

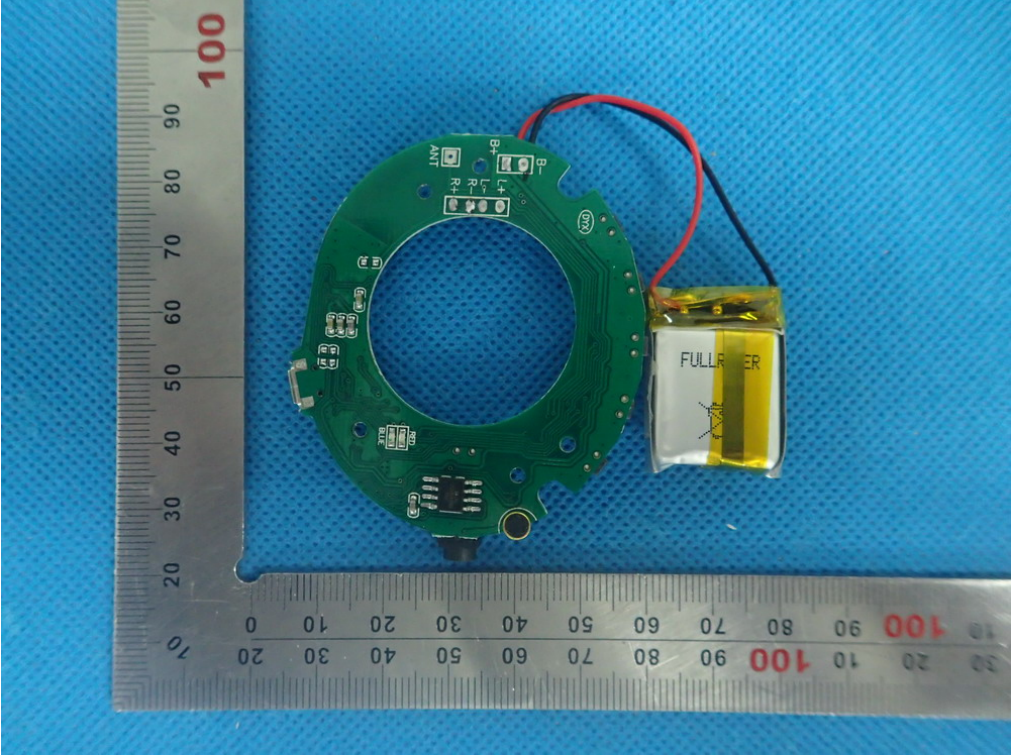

INTERNAL VIEW OF EUT-3

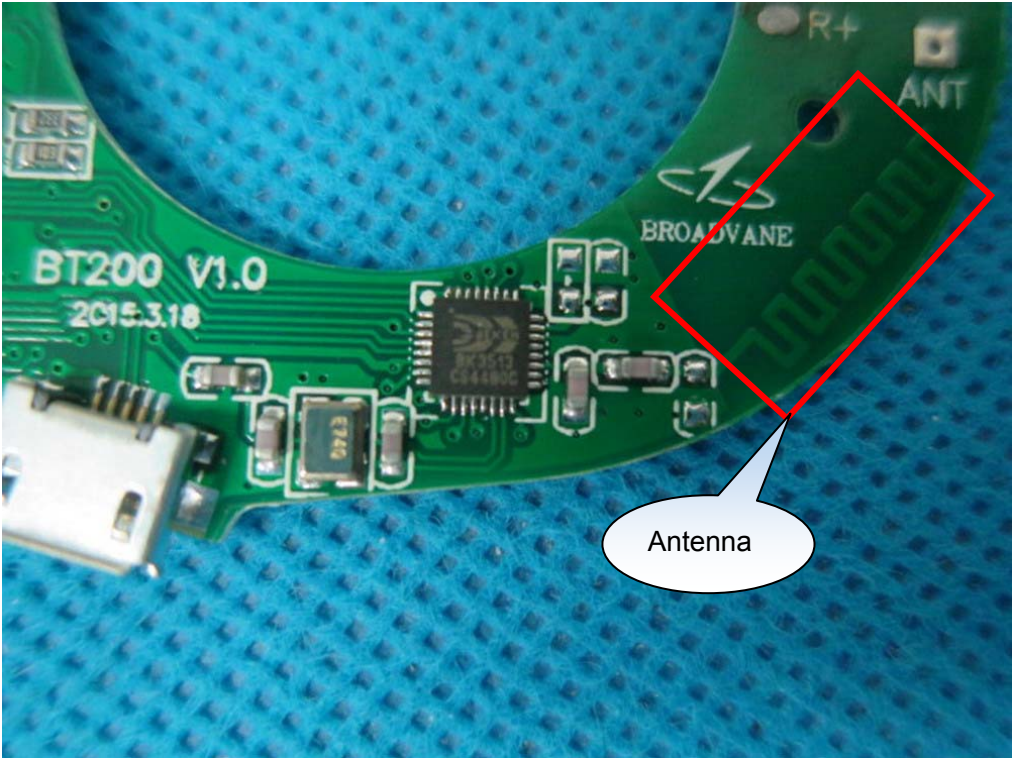

----END OF REPORT----