FCC Test Report

Report No.: AGC08189230302FE03

FCC ID : 2ACP4-SPBT9

APPLICATION PURPOSE : Original Equipment

PRODUCT DESIGNATION : Bluetooth speaker

BRAND NAME : SENTRY

MODEL NAME : SPBT9, BTSP9, BTSP2, BTSP, BTSP1, BTSPK, SPBT9W, SPBT9B

APPLICANT : Sentry Industries Limited

DATE OF ISSUE : Apr. 11, 2023

STANDARD(S) : FCC Part 15.247

REPORT VERSION : V1.0

Attestation of Global Compliance (Shenzhen) Co., Ltd



Any report having not been signed by authorized approver, or having been altered without authorization, or having not been stamped by the "Dedicated Testing/Inspection Stamp" is deemed to be invalid. Copying or excerpting portion of, or altering the content of the report is not permitted without the written authorization of AGC. The test results presented in the report apply only to the tested sample. Any objections to report issued by AGC should be submitted to AGC within 15days after the issuance of the test report. Further enquiry of validity or verification of the test report should be addressed to AGC by agc01@agccert.com.

Attestation of Global Compliance(Shenzhen)Co., Ltd
Attestation of Global Compliance(Shenzhen)Std & Tech Co., Ltd
Tel: +86-755 2523 4088 E-mail: agc@agccert.com Web: <http://www.agccert.com/>



REPORT REVISE RECORD

Report Version	Revise Time	Issued Date	Valid Version	Notes
V1.0	/	Apr. 11, 2023	Valid	Initial Release

Any report having not been signed by authorized approver, or having been altered without authorization, or having not been stamped by the “Dedicated Testing/Inspection Stamp” is deemed to be invalid. Copying or excerpting portion of, or altering the content of the report is not permitted without the written authorization of AGC. The test results presented in the report apply only to the tested sample. Any objections to report issued by AGC should be submitted to AGC within 15days after the issuance of the test report. Further enquiry of validity or verification of the test report should be addressed to AGC by agc01@agccert.com.

TABLE OF CONTENTS

1. VERIFICATION OF CONFORMITY..... 5

2. GENERAL INFORMATION 6

 2.1. PRODUCT DESCRIPTION 6

 2.2. TABLE OF CARRIER FREQUENCIES 6

 2.3. RECEIVER INPUT BANDWIDTH 7

 2.4. EXAMPLE OF A HOPPING SEQUENCY IN DATA MODE 7

 2.5. EQUALLY AVERAGE USE OF FREQUENCIES AND BEHAVIOUR 7

 2.6. RELATED SUBMITTAL(S) / GRANT (S) 8

 2.7. TEST METHODOLOGY 8

 2.8. SPECIAL ACCESSORIES 8

 2.9. EQUIPMENT MODIFICATIONS..... 8

 2.10. ANTENNA REQUIREMENT..... 8

3. MEASUREMENT UNCERTAINTY 9

4. DESCRIPTION OF TEST MODES 10

5. SYSTEM TEST CONFIGURATION 11

 5.1. CONFIGURATION OF EUT SYSTEM..... 11

 5.2. EQUIPMENT USED IN TESTED SYSTEM..... 11

 5.3. SUMMARY OF TEST RESULTS 11

6. TEST FACILITY 12

7. PEAK OUTPUT POWER..... 13

 7.1. MEASUREMENT PROCEDURE 13

 7.2. TEST SET-UP (BLOCK DIAGRAM OF CONFIGURATION) 13

 7.3. LIMITS AND MEASUREMENT RESULT 14

8. 20DB BANDWIDTH..... 19

 8.1. MEASUREMENT PROCEDURE 19

 8.2. TEST SET-UP (BLOCK DIAGRAM OF CONFIGURATION) 19

 8.3. LIMITS AND MEASUREMENT RESULTS 20

9. CONDUCTED SPURIOUS EMISSION..... 25

 9.1. MEASUREMENT PROCEDURE 25

Any report having not been signed by authorized approver, or having been altered without authorization, or having not been stamped by the “Dedicated Testing/Inspection Stamp” is deemed to be invalid. Copying or excerpting portion of, or altering the content of the report is not permitted without the written authorization of AGC. The test results presented in the report apply only to the tested sample. Any objections to report issued by AGC should be submitted to AGC within 15days after the issuance of the test report. Further enquiry of validity or verification of the test report should be addressed to AGC by agc01@agccert.com.

9.2. TEST SET-UP (BLOCK DIAGRAM OF CONFIGURATION)	25
9.3. MEASUREMENT EQUIPMENT USED	25
9.4. LIMITS AND MEASUREMENT RESULT	25
10. RADIATED EMISSION	46
10.1. MEASUREMENT PROCEDURE	46
10.2. TEST SETUP	48
10.3. LIMITS AND MEASUREMENT RESULT	49
10.4. TEST RESULT.....	49
11. NUMBER OF HOPPING FREQUENCY	59
11.1. MEASUREMENT PROCEDURE.....	59
11.2. TEST SETUP (BLOCK DIAGRAM OF CONFIGURATION)	59
11.3. MEASUREMENT EQUIPMENT USED	59
11.4. LIMITS AND MEASUREMENT RESULT	59
12. TIME OF OCCUPANCY (DWELL TIME).....	60
12.1. MEASUREMENT PROCEDURE	60
12.2. TEST SETUP (BLOCK DIAGRAM OF CONFIGURATION)	60
12.3. MEASUREMENT EQUIPMENT USED	60
12.4. LIMITS AND MEASUREMENT RESULT	60
13. FREQUENCY SEPARATION	64
13.1. MEASUREMENT PROCEDURE	64
13.2. TEST SETUP (BLOCK DIAGRAM OF CONFIGURATION)	64
13.3. MEASUREMENT EQUIPMENT USED	64
13.4. LIMITS AND MEASUREMENT RESULT	64
14. LINE CONDUCTED EMISSION TEST	65
14.1. LIMITS OF LINE CONDUCTED EMISSION TEST	65
14.2. BLOCK DIAGRAM OF LINE CONDUCTED EMISSION TEST.....	65
14.3. PRELIMINARY PROCEDURE OF LINE CONDUCTED EMISSION TEST	66
14.4. FINAL PROCEDURE OF LINE CONDUCTED EMISSION TEST.....	66
14.5. TEST RESULT OF LINE CONDUCTED EMISSION TEST	67
APPENDIX A: PHOTOGRAPHS OF TEST SETUP	69
APPENDIX B: PHOTOGRAPHS OF EUT	69



Any report having not been signed by authorized approver, or having been altered without authorization, or having not been stamped by the “Dedicated Testing/Inspection Stamp” is deemed to be invalid. Copying or excerpting portion of, or altering the content of the report is not permitted without the written authorization of AGC. The test results presented in the report apply only to the tested sample. Any objections to report issued by AGC should be submitted to AGC within 15days after the issuance of the test report. Further enquiry of validity or verification of the test report should be addressed to AGC by agc01@agccert.com.

1. VERIFICATION OF CONFORMITY

Applicant	Sentry Industries Limited
Address	Unit 904, 9/F Chinachem Golden Plaza, 77 Mody Road, Tsim Sha Tsui East, Kowloon, Hong Kong, China
Manufacturer	Golden Technology Group Ltd.
Address	No. 51 Guangtian Road, Luotian, Songgang Town, Bao'an, Shenzhen, China
Factory	Golden Technology Group Ltd.
Address	No. 51 Guangtian Road, Luotian, Songgang Town, Bao'an, Shenzhen, China
Product Designation	Bluetooth speaker
Brand Name	SENTRY
Test Model	SPBT9
Series model	BTSP9, BTSP2, BTSP, BTSP1, BTSPK, SPBT9W, SPBT9B
Difference description	All the series models are the same as the test model except for the model names.
Date of receipt of test item	Mar. 24, 2023
Date of test	Mar. 24, 2023 to Apr. 11, 2023
Deviation	No any deviation from the test method
Condition of Test Sample	Normal
Test Result	Pass
Report Template	AGCRT-US-BR/RF

We hereby certify that:

The above equipment was tested by Attestation of Global Compliance (Shenzhen) Co., Ltd. The test data, data evaluation, test procedures, and equipment configurations shown in this report were made in accordance with the procedures given in ANSI C63.10 (2013) and the energy emitted by the sample EUT tested as described in this report is in compliance with radiated emission limits of FCC PART 15.247.

Prepared By		
	Alan Duan (Project Engineer)	Apr. 11, 2023
Reviewed By		
	Calvin Liu (Reviewer)	Apr. 11, 2023
Approved By		
	Max Zhang (Authorized Officer)	Apr. 11, 2023

Any report having not been signed by authorized approver, or having been altered without authorization, or having not been stamped by the "Dedicated Testing/Inspection Stamp" is deemed to be invalid. Copying or excerpting portion of, or altering the content of the report is not permitted without the written authorization of AGC. The test results presented in the report apply only to the tested sample. Any objections to report issued by AGC should be submitted to AGC within 15days after the issuance of the test report. Further enquiry of validity or verification of the test report should be addressed to AGC by agc01@agccert.com.

2. GENERAL INFORMATION

2.1. PRODUCT DESCRIPTION

The EUT is designed as “Bluetooth speaker”. It is designed by way of utilizing the GFSK, Pi/4 DQPSK and 8DPSK technology to achieve the system operation.

A major technical description of EUT is described as following

Operation Frequency	2.402 GHz to 2.480 GHz
RF Output Power	4.304dBm (Max)
Bluetooth Version	V5.2
Modulation	BR <input checked="" type="checkbox"/> GFSK, EDR <input checked="" type="checkbox"/> π /4-DQPSK, <input checked="" type="checkbox"/> 8DPSK BLE <input type="checkbox"/> GFSK 1Mbps <input type="checkbox"/> GFSK 2Mbps
Number of channels	79
Hardware Version	V1.1
Software Version	V5.0
Antenna Designation	PCB Antenna (Comply with requirements of the FCC part 15.203)
Antenna Gain	-0.68dBi
Power Supply	DC 3.7V by battery or DC 5V by adapter

2.2. TABLE OF CARRIER FREQUENCIES

Frequency Band	Channel Number	Frequency
2402~2480MHz	0	2402 MHz
	1	2403 MHz
	:	:
	38	2440 MHz
	39	2441 MHz
	40	2442 MHz
	:	:
	77	2479 MHz
	78	2480 MHz

Any report having not been signed by authorized approver, or having been altered without authorization, or having not been stamped by the “Dedicated Testing/Inspection Stamp” is deemed to be invalid. Copying or excerpting portion of, or altering the content of the report is not permitted without the written authorization of AGC. The test results presented in the report apply only to the tested sample. Any objections to report issued by AGC should be submitted to AGC within 15days after the issuance of the test report. Further enquiry of validity or verification of the test report should be addressed to AGC by agc01@agccert.com.

2.3. RECEIVER INPUT BANDWIDTH

The input bandwidth of the receiver is 1.3MHz, in every connection one Bluetooth device is the master and the other one is slave. The master determines the hopping sequence. The slave follows this sequence. Both devices shift between RX and TX time slot according to the clock of the master. Additionally, the type of connection (e.g. single or multi slot packet) is set up at the beginning of the connection. The master adapts its hopping frequency and its TX/RX timing according to the packet type of the connection. Also, the slave of the connection will use these settings. Repeating of a packet has no influence on the hopping sequence. The hopping sequence generated by the master of the connection will be followed in any case. That means, a repeated packet will not be send on the same frequency, it is send on the next frequency of the hopping sequence.

2.4. EXAMPLE OF A HOPPING SEQUENCY IN DATA MODE

Example of a hopping sequence in data mode:

40, 21, 44, 23, 04, 15, 66, 56, 19, 78, 07, 28, 69, 55,
36, 45, 05, 13, 43, 74, 57, 35, 67, 76, 02, 34, 54, 63,
42, 11, 30, 06, 64, 25, 75, 48, 17, 33, 58, 01, 29, 14,
51, 72, 03, 31, 50, 61, 77, 18, 10, 47, 12, 68, 08, 49,
20, 00, 73, 09, 16, 60, 71, 41, 24, 53, 38, 26, 46, 37,
65, 32, 70, 52, 27, 59, 22, 62, 39

2.5. EQUALLY AVERAGE USE OF FREQUENCIES AND BEHAVIOUR

The generation of the hopping sequence in connection mode depends essentially on two input values:

1. LAP/UAP of the master of the connection.
2. Internal master clock.

The LAP (lower address part) are the 24 LSB's of the 48 BD_ADDRESS. The BD_ADDRESS is an unambiguous number of every Bluetooth unit. The UAP (upper address part) are the 24MSB's of the 48BD_ADDRESS

The internal clock of a Bluetooth unit is derived from a free running clock which is never adjusted and is never turned off. For behavior action with other units only offset is used. It has no relation to the time of the day. Its resolution is at least half the RX/TX slot length of 312.5us. The clock has a cycle of about one day(23h30). In most case it is implemented as 28 bits counter. For the deriving of the hopping sequence the entire. LAP (24 bits),4LSB's(4bits) (Input 1) and the 27MSB's of the clock (Input 2) are used. With this input values different mathematical procedures (permutations, additions, XOR-operations) are performed to generate the Sequence. This will be done at the beginning of every new transmission.

Regarding short transmissions the Bluetooth system has the following behavior:

The first connection between the two devices is established, a hopping sequence was generated. For Transmitting the wanted data the complete hopping sequence was not used. The connection ended.

Any report having not been signed by authorized approver, or having been altered without authorization, or having not been stamped by the "Dedicated Testing/Inspection Stamp" is deemed to be invalid. Copying or excerpting portion of, or altering the content of the report is not permitted without the written authorization of AGC. The test results presented in the report apply only to the tested sample. Any objections to report issued by AGC should be submitted to AGC within 15days after the issuance of the test report. Further enquiry of validity or verification of the test report should be addressed to AGC by agc01@agccert.com.

The second connection will be established. A new hopping sequence is generated. Due to the fact the Bluetooth clock has a different value, because the period between the two transmission is longer (and it cannot be shorter) than the minimum resolution of the clock(312.5us). The hopping sequence will always differ from the first one.

2.6. RELATED SUBMITTAL(S) / GRANT (S)

This submittal(s) (test report) is intended for **FCC ID: 2ACP4-SPBT9** filing to comply with the FCC PART 15.247 requirements.

2.7. TEST METHODOLOGY

Both conducted and radiated testing was performed according to the procedures in ANSI C63.10 (2013). Radiated testing was performed at an antenna to EUT distance 3 meters.

2.8. SPECIAL ACCESSORIES

Refer to section 5.2.

2.9. EQUIPMENT MODIFICATIONS

Not available for this EUT intended for grant.

2.10. ANTENNA REQUIREMENT

This intentional radiator is designed with a permanently attached antenna of an antenna to ensure that no antenna other than that furnished by the responsible party shall be used with the device.

For more information of the antenna, please refer to the APPENDIX B: PHOTOGRAPHS OF EUT.

3. MEASUREMENT UNCERTAINTY

The reported uncertainty of measurement $y \pm U$, where expanded uncertainty U is based on a standard uncertainty multiplied by a coverage factor of $k=2$, providing a level of confidence of approximately 95%.

Item	Measurement Uncertainty
Uncertainty of Conducted Emission for AC Port	$U_c = \pm 3.1$ dB
Uncertainty of Radiated Emission below 1GHz	$U_c = \pm 4.0$ dB
Uncertainty of Radiated Emission above 1GHz	$U_c = \pm 4.8$ dB
Uncertainty of total RF power, conducted	$U_c = \pm 0.8$ dB
Uncertainty of RF power density, conducted	$U_c = \pm 2.6$ dB
Uncertainty of spurious emissions, conducted	$U_c = \pm 2$ %
Uncertainty of Occupied Channel Bandwidth	$U_c = \pm 2$ %

Any report having not been signed by authorized approver, or having been altered without authorization, or having not been stamped by the "Dedicated Testing/Inspection Stamp" is deemed to be invalid. Copying or excerpting portion of, or altering the content of the report is not permitted without the written authorization of AGC. The test results presented in the report apply only to the tested sample. Any objections to report issued by AGC should be submitted to AGC within 15days after the issuance of the test report. Further enquiry of validity or verification of the test report should be addressed to AGC by agc01@agccert.com.

4. DESCRIPTION OF TEST MODES

NO.	TEST MODE DESCRIPTION
1	Low channel GFSK
2	Middle channel GFSK
3	High channel GFSK
4	Low channel $\pi/4$ -DQPSK
5	Middle channel $\pi/4$ -DQPSK
6	High channel $\pi/4$ -DQPSK
7	Low channel 8DPSK
8	Middle channel 8DPSK
9	High channel 8DPSK
10	Hopping mode GFSK
11	Hopping mode $\pi/4$ -DQPSK
12	Hopping mode 8DPSK

Note:

1. Only the result of the worst case was recorded in the report, if no other cases.
2. For Radiated Emission, 3axis were chosen for testing for each applicable mode.
3. For Conducted Test method, a temporary antenna connector is provided by the manufacture.

Software Setting

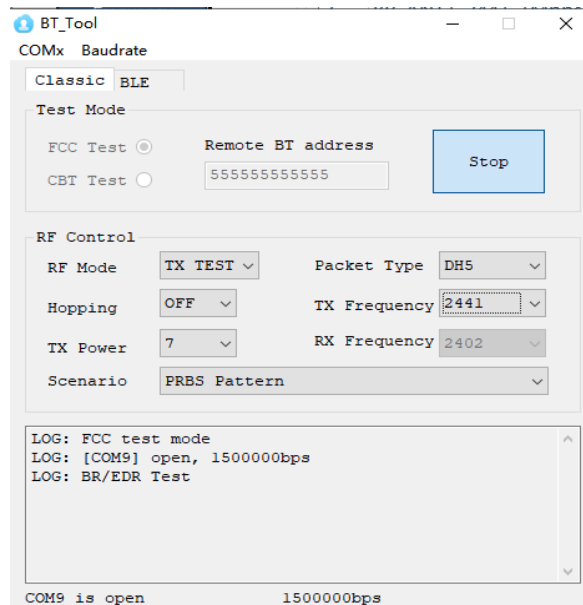

Any report having not been signed by authorized approver, or having been altered without authorization, or having not been stamped by the “Dedicated Testing/Inspection Stamp” is deemed to be invalid. Copying or excerpting portion of, or altering the content of the report is not permitted without the written authorization of AGC. The test results presented in the report apply only to the tested sample. Any objections to report issued by AGC should be submitted to AGC within 15days after the issuance of the test report. Further enquiry of validity or verification of the test report should be addressed to AGC by agc01@agccert.com.

5. SYSTEM TEST CONFIGURATION

5.1. CONFIGURATION OF EUT SYSTEM

Radiated Emission Configure:



Conducted Emission Configure:

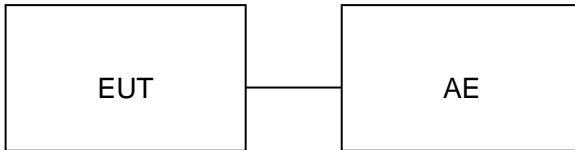

5.2. EQUIPMENT USED IN TESTED SYSTEM

Item	Equipment	Model No.	ID or Specification	Remark
1	Bluetooth speaker	SPBT9	2ACP4-SPBT9	EUT
2	Control Box	USB-TTL	N/A	AE
3	Xiaomi phone	Mi 10	N/A	AE
4	Adapter	HW-050200C01	N/A	AE

5.3. SUMMARY OF TEST RESULTS

FCC RULES	DESCRIPTION OF TEST	RESULT
15.247 (b)(1)	Peak Output Power	Compliant
15.247 (a)(1)	20 dB Bandwidth	Compliant
15.247 (d)	Conducted Spurious Emission	Compliant
15.209	Radiated Emission	Compliant
15.247 (a)(1)(iii)	Number of Hopping Frequency	Compliant
15.247 (a)(1)(iii)	Time of Occupancy	Compliant
15.247 (a)(1)	Frequency Separation	Compliant
15.207	Conducted Emission	Compliant

Any report having not been signed by authorized approver, or having been altered without authorization, or having not been stamped by the "Dedicated Testing/Inspection Stamp" is deemed to be invalid. Copying or excerpting portion of, or altering the content of the report is not permitted without the written authorization of AGC. The test results presented in the report apply only to the tested sample. Any objections to report issued by AGC should be submitted to AGC within 15days after the issuance of the test report. Further enquiry of validity or verification of the test report should be addressed to AGC by agc01@agccert.com.

6. TEST FACILITY

Test Site	Attestation of Global Compliance (Shenzhen) Co., Ltd
Location	1-2/F, Building 19, Junfeng Industrial Park, Chongqing Road, Heping Community, Fuhai Street, Bao'an District, Shenzhen, Guangdong, China
Designation Number	CN1259
FCC Test Firm Registration Number	975832
A2LA Cert. No.	5054.02
Description	Attestation of Global Compliance (Shenzhen) Co., Ltd is accredited by A2LA

TEST EQUIPMENT OF CONDUCTED EMISSION TEST

Equipment	Manufacturer	Model	S/N	Cal. Date	Cal. Due
TEST RECEIVER	R&S	ESPI	101206	Aug. 04, 2022	Aug. 03, 2023
LISN	R&S	ESH2-Z5	100086	Jun. 08, 2022	Jun. 07, 2023
Test software	FARA	EZ-EMC	Ver. AGC-CON03A1	N/A	N/A

TEST EQUIPMENT OF RADIATED EMISSION TEST

Equipment	Manufacturer	Model	S/N	Cal. Date	Cal. Due
TEST RECEIVER	R&S	ESCI	10096	Feb. 18, 2023	Feb. 17, 2024
EXA Signal Analyzer	Aglient	N9010A	MY53470504	Aug. 04, 2022	Aug. 03, 2023
Signal Analyzer	Aglient	N9020A	MY52090123	Aug. 04, 2022	Aug. 03, 2023
2.4GHz Filter	EM Electronics	2400-2500MHz	N/A	Mar. 23, 2022	Mar. 22, 2024
Attenuator	ZHINAN	E-002	N/A	Aug. 03, 2022	Aug. 02, 2024
Horn antenna	SCHWARZBECK	BBHA 9170	#768	Oct. 31, 2021	Oct. 30, 2023
Active loop antenna (9K-30MHz)	ZHINAN	ZN30900C	18051	Mar. 12, 2022	Mar. 11, 2024
Double-Ridged Waveguide Horn	ETS LINDGREN	3117	00034609	Apr. 23, 2021	Apr. 22, 2023
Broadband Preamplifier	ETS LINDGREN	3117PA	00225134	Aug. 03, 2022	Aug. 02, 2024
ANTENNA	SCHWARZBECK	VULB9168	494	Jan. 05, 2023	Jan. 04, 2024
Test software	Tonscend	JS32-RE	Ver.2.5	N/A	N/A

Any report having not been signed by authorized approver, or having been altered without authorization, or having not been stamped by the "Dedicated Testing/Inspection Stamp" is deemed to be invalid. Copying or excerpting portion of, or altering the content of the report is not permitted without the written authorization of AGC. The test results presented in the report apply only to the tested sample. Any objections to report issued by AGC should be submitted to AGC within 15days after the issuance of the test report. Further enquiry of validity or verification of the test report should be addressed to AGC by agc01@agccert.com.

7. PEAK OUTPUT POWER

7.1. MEASUREMENT PROCEDURE

For peak power test:

1. Connect EUT RF output port to the Spectrum Analyzer through an RF attenuator
2. Span: Approximately five times the 20 dB bandwidth, centered on a hopping channel.
3. RBW > 20 dB bandwidth of the emission being measured.
4. VBW \geq RBW.
5. Sweep: Auto.
6. Detector function: Peak.
7. Trace: Max hold.

Allow trace to stabilize. Use the marker-to-peak function to set the marker to the peak of the emission. The indicated level is the peak output power, after any corrections for external attenuators and cables.

7.2. TEST SET-UP (BLOCK DIAGRAM OF CONFIGURATION)

PEAK POWER TEST SETUP

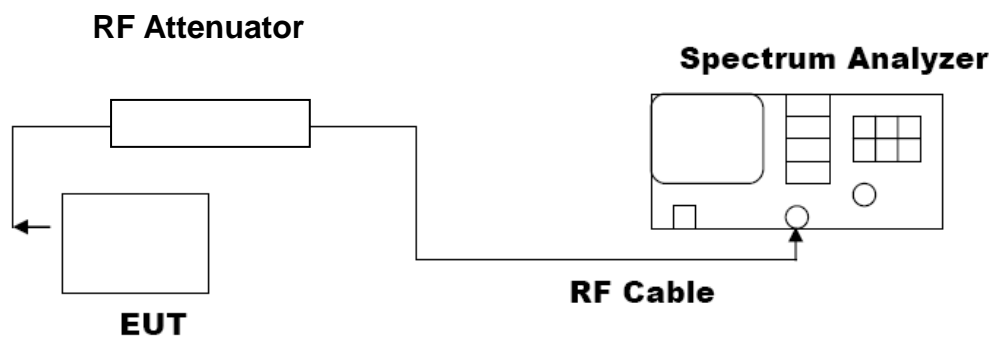

Any report having not been signed by authorized approver, or having been altered without authorization, or having not been stamped by the "Dedicated Testing/Inspection Stamp" is deemed to be invalid. Copying or excerpting portion of, or altering the content of the report is not permitted without the written authorization of AGC. The test results presented in the report apply only to the tested sample. Any objections to report issued by AGC should be submitted to AGC within 15days after the issuance of the test report. Further enquiry of validity or verification of the test report should be addressed to AGC by agc01@agccert.com.

7.3. LIMITS AND MEASUREMENT RESULT

Test Data of Conducted Output Power				
Test Mode	Test Channel (MHz)	Peak Power (dBm)	Limits (dBm)	Pass or Fail
GFSK	2402	0.687	≤21	Pass
	2441	1.196	≤21	Pass
	2480	0.602	≤21	Pass
π /4-DQPSK	2402	3.281	≤21	Pass
	2441	3.734	≤21	Pass
	2480	3.021	≤21	Pass
8DPSK	2402	3.852	≤21	Pass
	2441	4.304	≤21	Pass
	2480	3.651	≤21	Pass

Test Graphs of Conducted Output Power

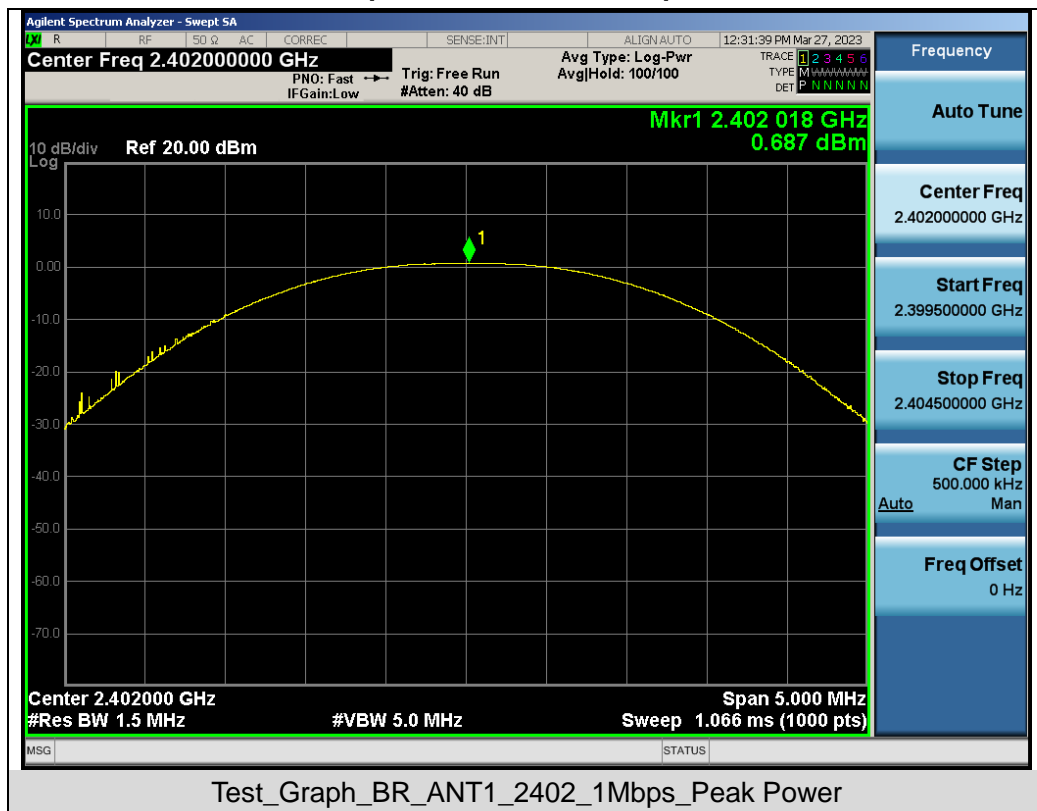

Any report having not been signed by authorized approver, or having been altered without authorization, or having not been stamped by the “Dedicated Testing/Inspection Stamp” is deemed to be invalid. Copying or excerpting portion of, or altering the content of the report is not permitted without the written authorization of AGC. The test results presented in the report apply only to the tested sample. Any objections to report issued by AGC should be submitted to AGC within 15days after the issuance of the test report. Further enquiry of validity or verification of the test report should be addressed to AGC by agc01@agccert.com.

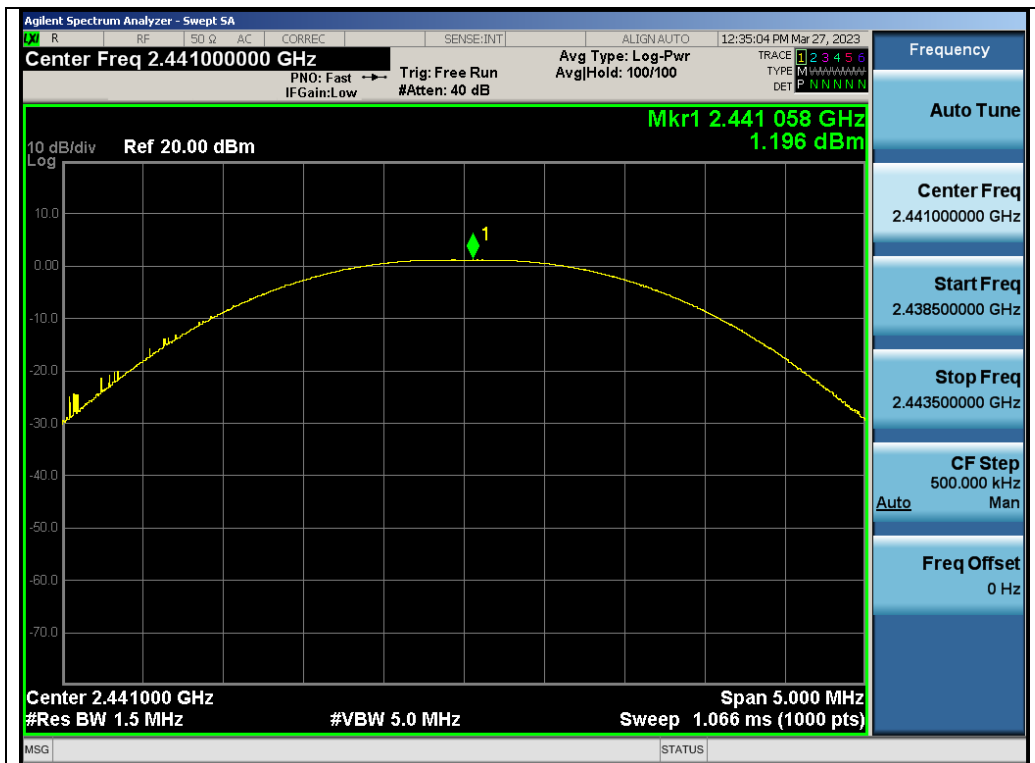

Test_Graph_BR_ANT1_2441_1Mbps_Peak Power

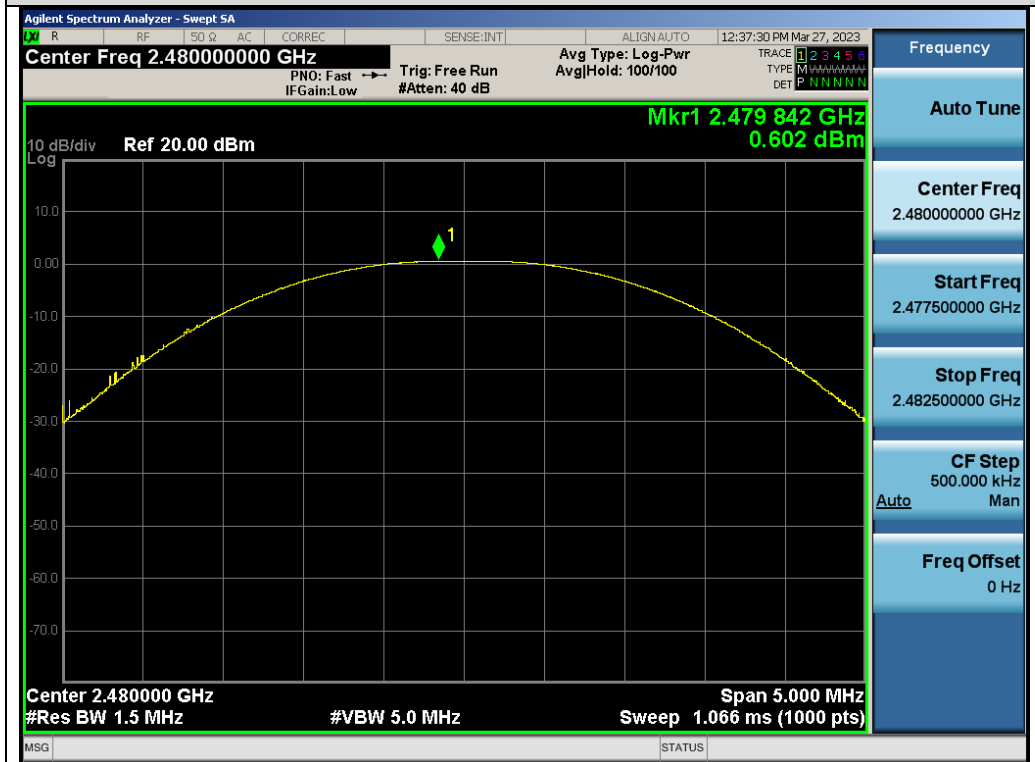

Test_Graph_BR_ANT1_2480_1Mbps_Peak Power

Any report having not been signed by authorized approver, or having been altered without authorization, or having not been stamped by the "Dedicated Testing/Inspection Stamp" is deemed to be invalid. Copying or excerpting portion of, or altering the content of the report is not permitted without the written authorization of AGC. The test results presented in the report apply only to the tested sample. Any objections to report issued by AGC should be submitted to AGC within 15days after the issuance of the test report. Further enquiry of validity or verification of the test report should be addressed to AGC by agc01@agccert.com.

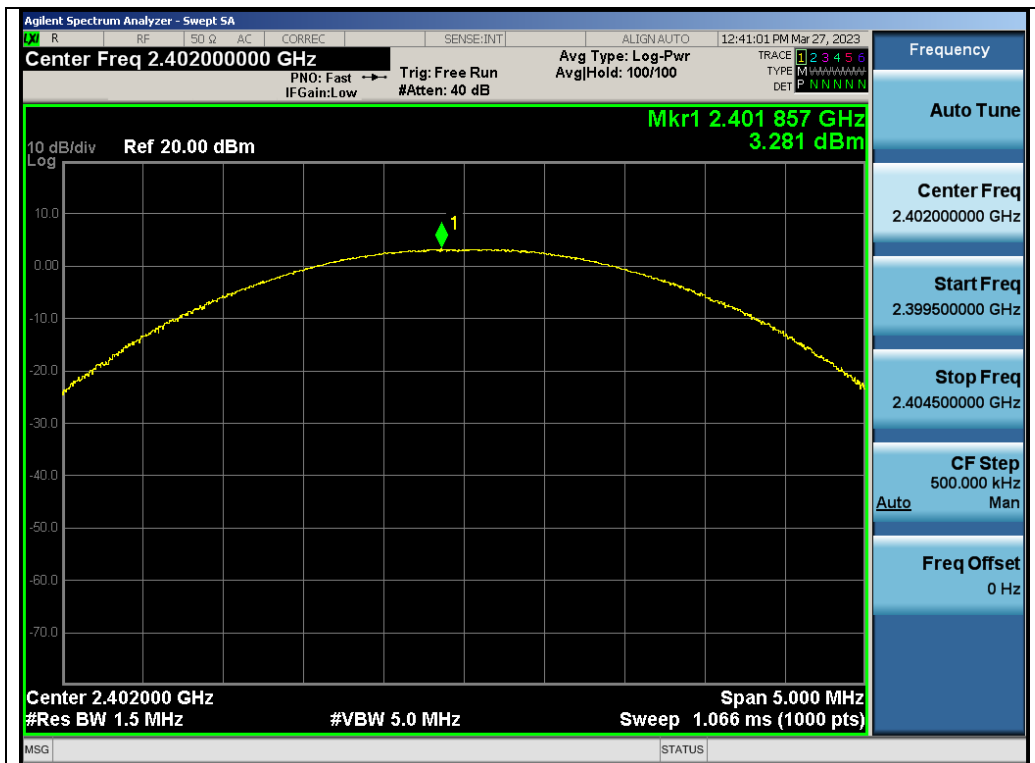

Test_Graph_EDR_ANT1_2402_2Mbps_Peak Power

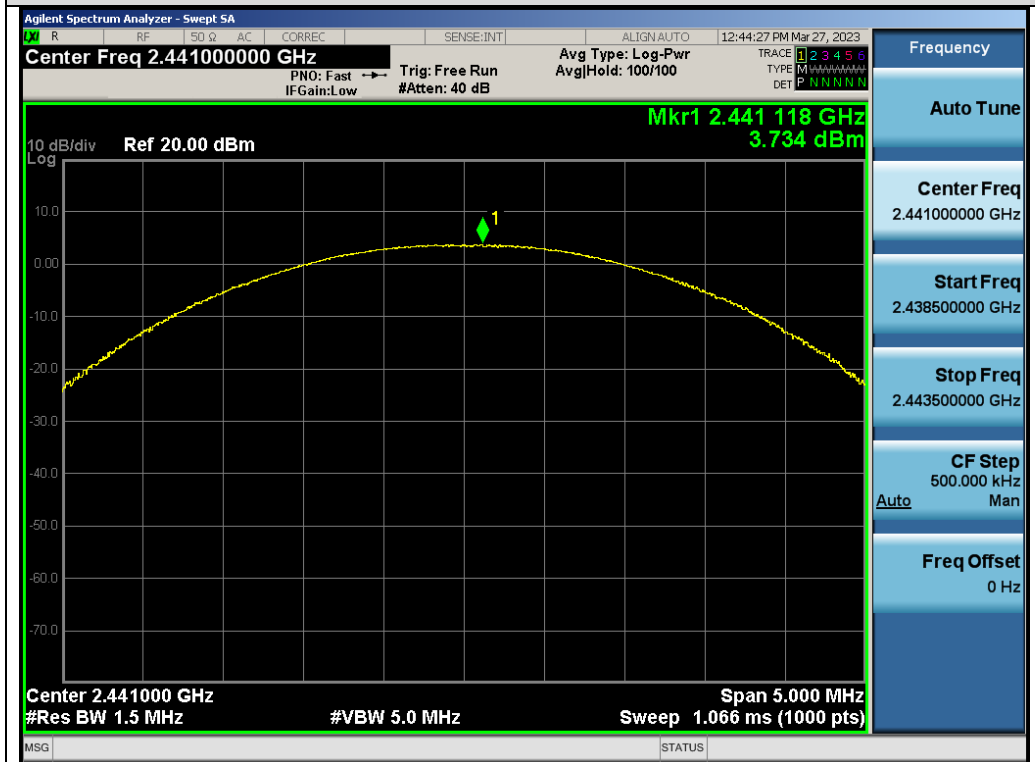

Test_Graph_EDR_ANT1_2441_2Mbps_Peak Power

Any report having not been signed by authorized approver, or having been altered without authorization, or having not been stamped by the "Dedicated Testing/Inspection Stamp" is deemed to be invalid. Copying or excerpting portion of, or altering the content of the report is not permitted without the written authorization of AGC. The test results presented in the report apply only to the tested sample. Any objections to report issued by AGC should be submitted to AGC within 15days after the issuance of the test report. Further enquiry of validity or verification of the test report should be addressed to AGC by agc01@agccert.com.

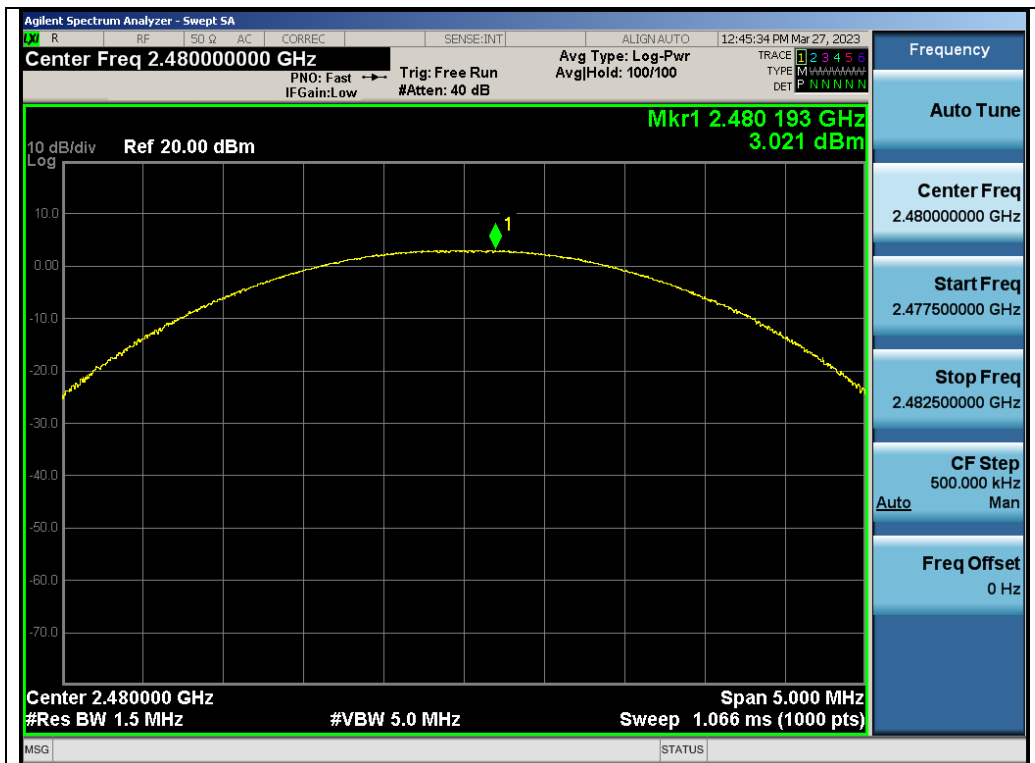

Test_Graph_EDR_ANT1_2480_2Mbps_Peak Power

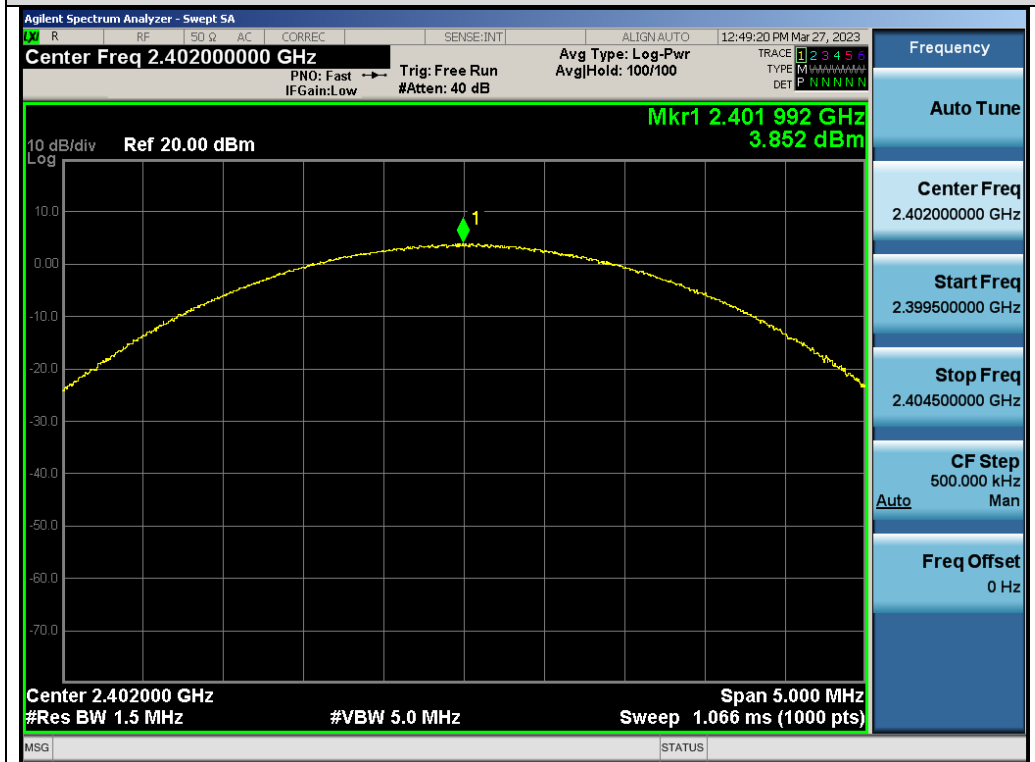

Test_Graph_EDR_ANT1_2402_3Mbps_Peak Power

Any report having not been signed by authorized approver, or having been altered without authorization, or having not been stamped by the "Dedicated Testing/Inspection Stamp" is deemed to be invalid. Copying or excerpting portion of, or altering the content of the report is not permitted without the written authorization of AGC. The test results presented in the report apply only to the tested sample. Any objections to report issued by AGC should be submitted to AGC within 15days after the issuance of the test report. Further enquiry of validity or verification of the test report should be addressed to AGC by agc01@agccert.com.

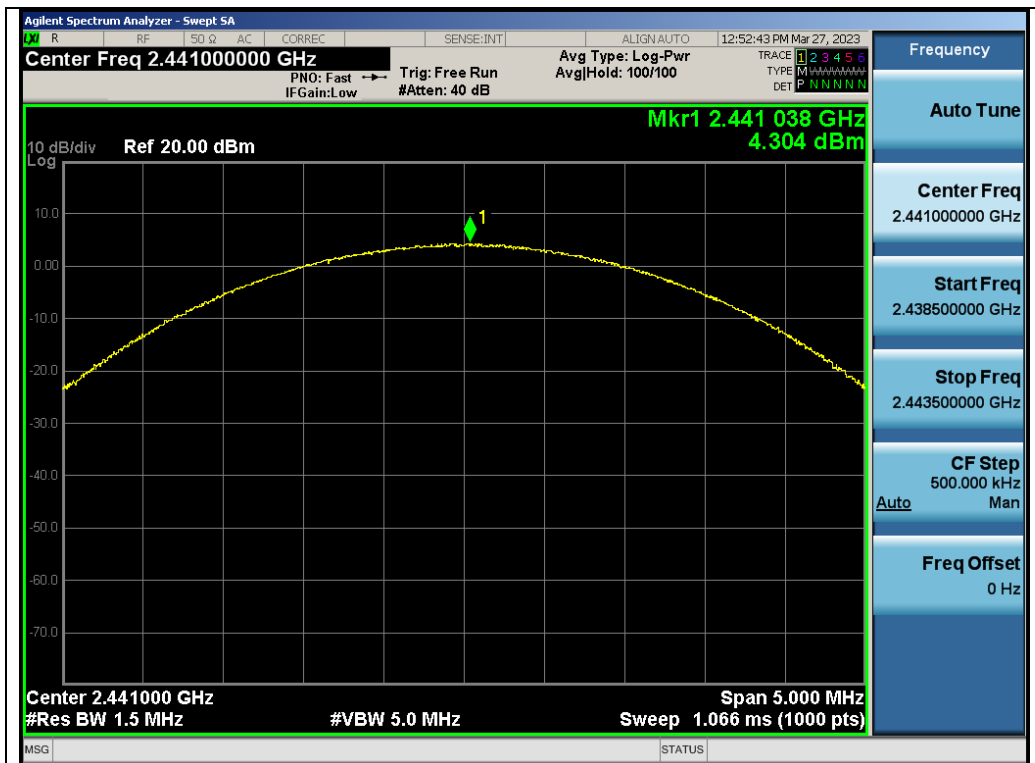

Test_Graph_EDR_ANT1_2441_3Mbps_Peak Power

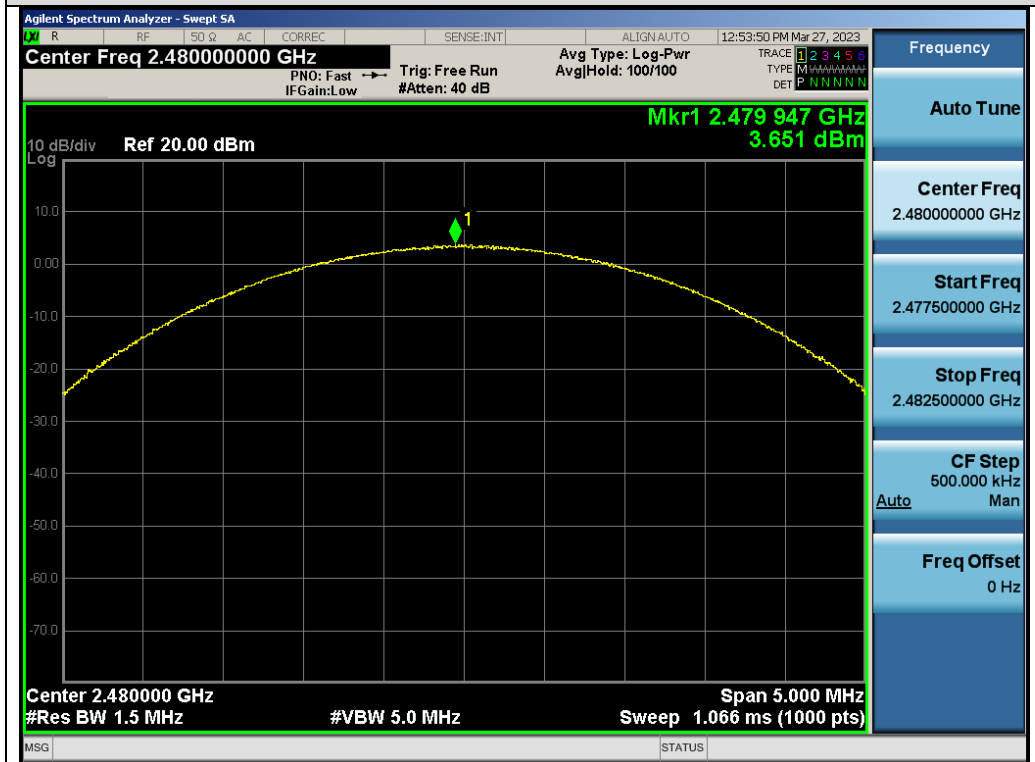

Test_Graph_EDR_ANT1_2480_3Mbps_Peak Power

Any report having not been signed by authorized approver, or having been altered without authorization, or having not been stamped by the "Dedicated Testing/Inspection Stamp" is deemed to be invalid. Copying or excerpting portion of, or altering the content of the report is not permitted without the written authorization of AGC. The test results presented in the report apply only to the tested sample. Any objections to report issued by AGC should be submitted to AGC within 15days after the issuance of the test report. Further enquiry of validity or verification of the test report should be addressed to AGC by agc01@agccert.com.

8. 20DB BANDWIDTH

8.1. MEASUREMENT PROCEDURE

1. Connect EUT RF output port to the Spectrum Analyzer through an RF attenuator
2. Set the EUT Work on the top, the middle and the bottom operation frequency individually.
3. Set Span = approximately 2 to 5 times the 20 dB bandwidth, centered on a hopping channel
The nominal IF filter bandwidth (3 dB RBW) shall be in the range of 1% to 5% of the OBW and video bandwidth (VBW) shall be approximately three times RBW; Sweep = auto; Detector function = peak
4. Set SPA Trace 1 Max hold, then View.

8.2. TEST SET-UP (BLOCK DIAGRAM OF CONFIGURATION)

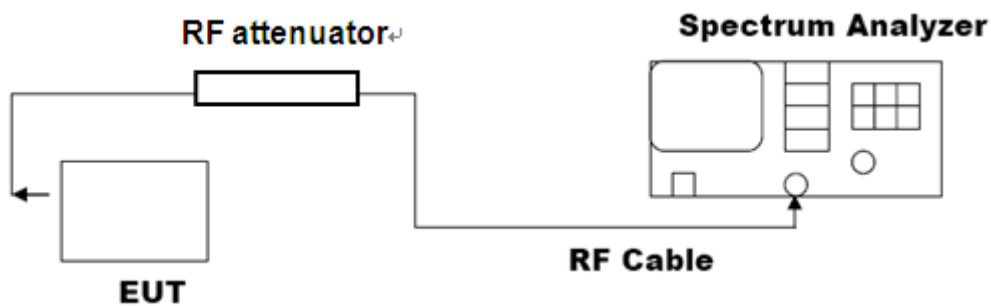

Any report having not been signed by authorized approver, or having been altered without authorization, or having not been stamped by the "Dedicated Testing/Inspection Stamp" is deemed to be invalid. Copying or excerpting portion of, or altering the content of the report is not permitted without the written authorization of AGC. The test results presented in the report apply only to the tested sample. Any objections to report issued by AGC should be submitted to AGC within 15days after the issuance of the test report. Further enquiry of validity or verification of the test report should be addressed to AGC by agc01@agccert.com.

8.3. LIMITS AND MEASUREMENT RESULTS

Test Data of Occupied Bandwidth and -20dB Bandwidth					
Test Mode	Test Channel (MHz)	99% Occupied Bandwidth (MHz)	-20dB Bandwidth (MHz)	Limits	Pass or Fail
GFSK	2402	0.838	0.865	N/A	Pass
	2441	0.832	0.859	N/A	Pass
	2480	0.834	0.859	N/A	Pass
π /4-DQPSK	2402	1.176	1.277	N/A	Pass
	2441	1.170	1.278	N/A	Pass
	2480	1.174	1.277	N/A	Pass
8DPSK	2402	1.182	1.289	N/A	Pass
	2441	1.186	1.301	N/A	Pass
	2480	1.182	1.279	N/A	Pass

Test Graphs of Occupied Bandwidth and -20 Bandwidth

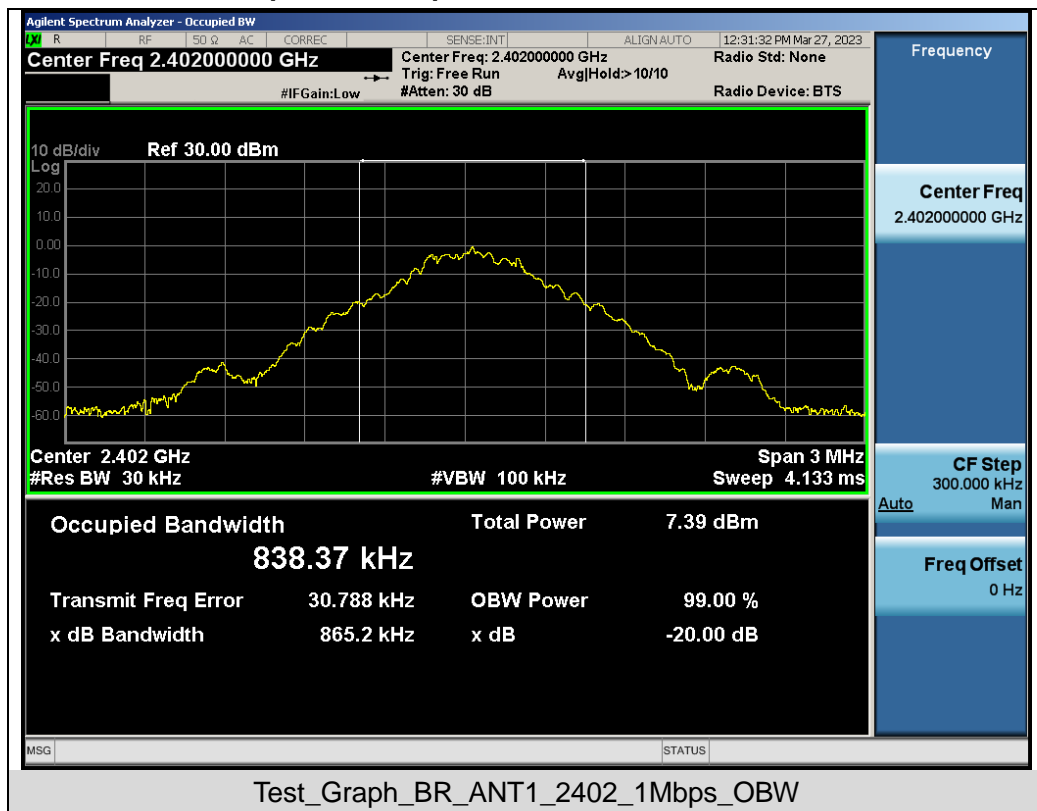

Any report having not been signed by authorized approver, or having been altered without authorization, or having not been stamped by the "Dedicated Testing/Inspection Stamp" is deemed to be invalid. Copying or excerpting portion of, or altering the content of the report is not permitted without the written authorization of AGC. The test results presented in the report apply only to the tested sample. Any objections to report issued by AGC should be submitted to AGC within 15days after the issuance of the test report. Further enquiry of validity or verification of the test report should be addressed to AGC by agc01@agccert.com.

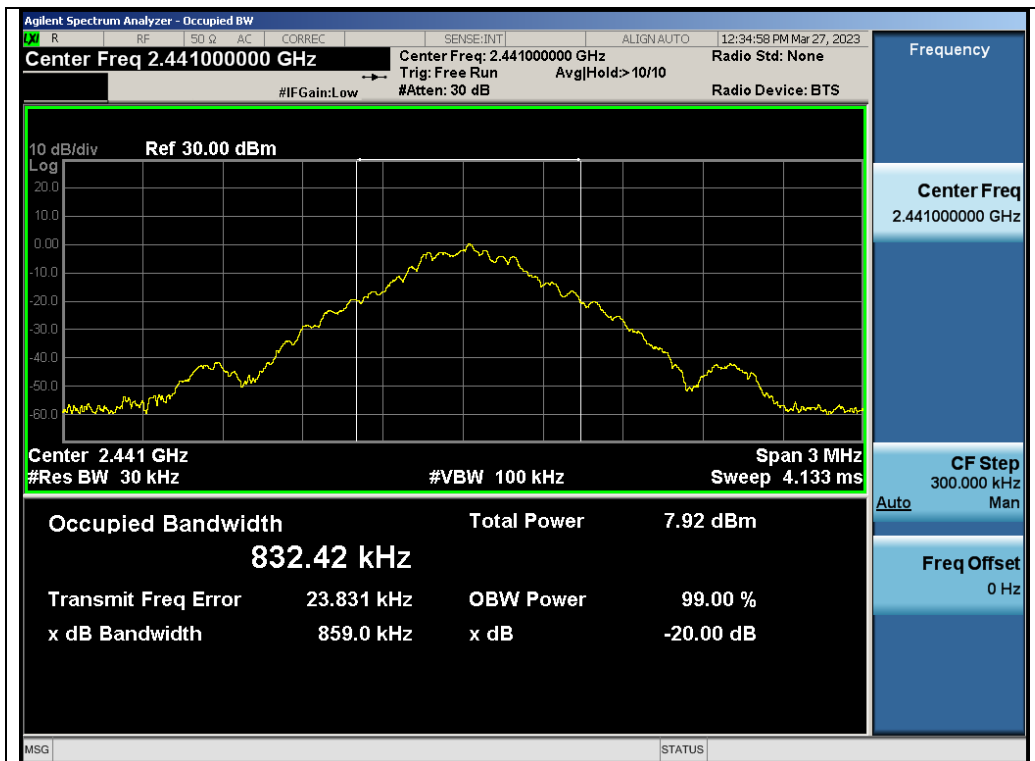

Test_Graph_BR_ANT1_2441_1Mbps_OBW

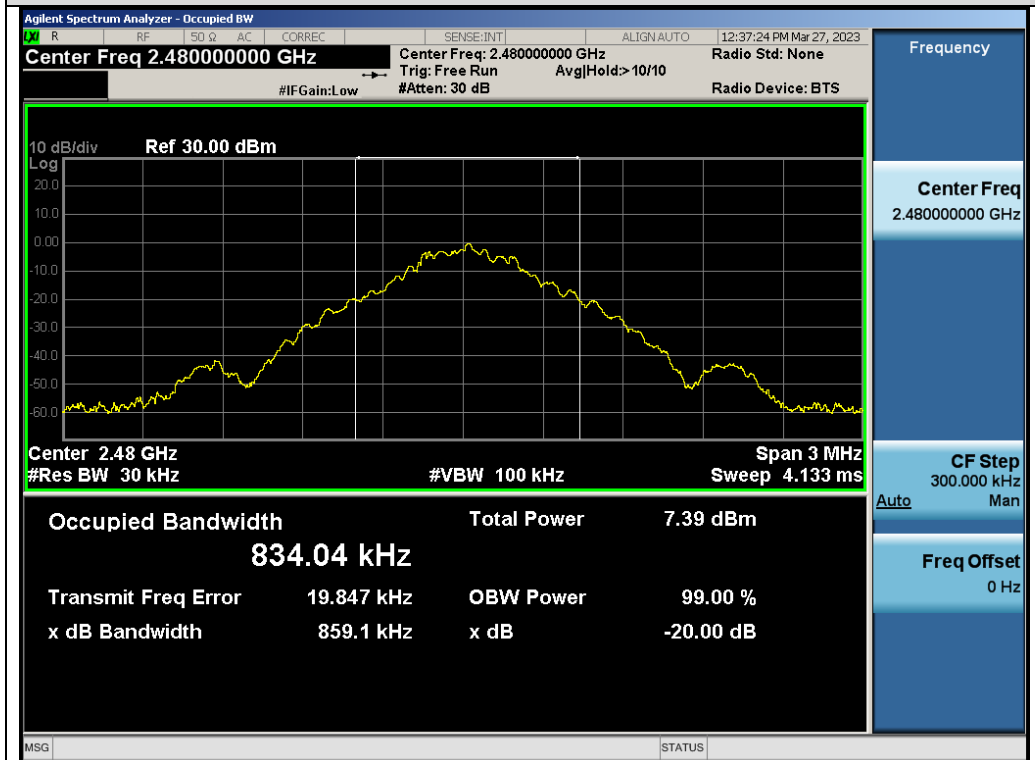

Test_Graph_BR_ANT1_2480_1Mbps_OBW

Any report having not been signed by authorized approver, or having been altered without authorization, or having not been stamped by the "Dedicated Testing/Inspection Stamp" is deemed to be invalid. Copying or excerpting portion of, or altering the content of the report is not permitted without the written authorization of AGC. The test results presented in the report apply only to the tested sample. Any objections to report issued by AGC should be submitted to AGC within 15days after the issuance of the test report. Further enquiry of validity or verification of the test report should be addressed to AGC by agc01@agccert.com.

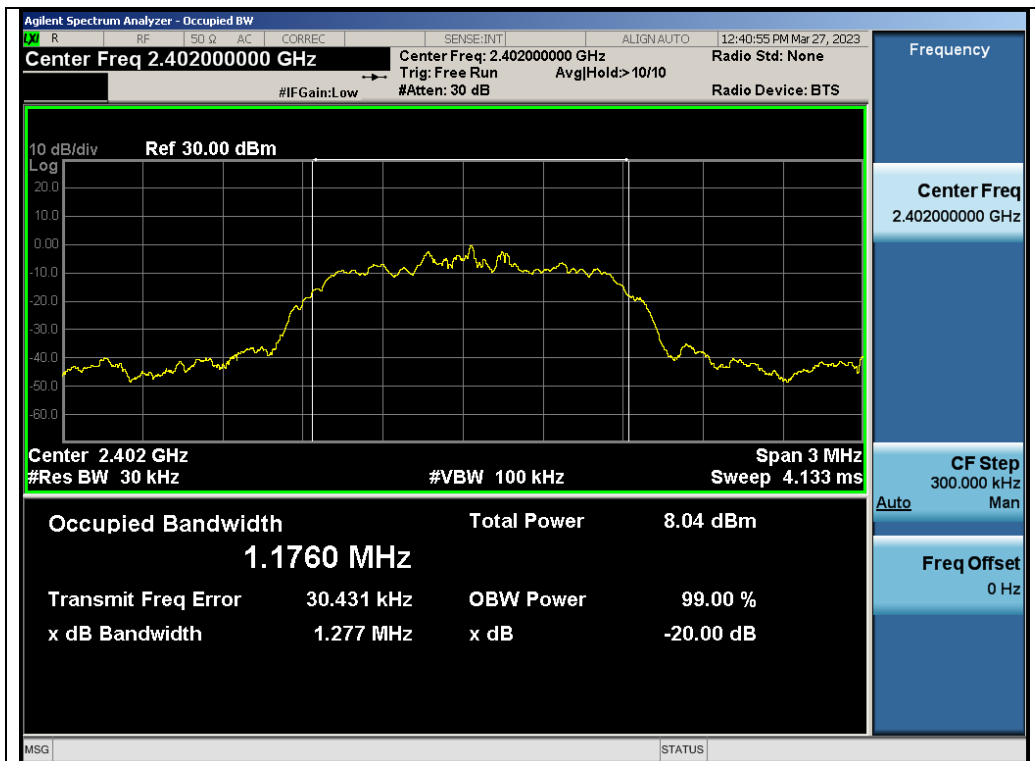

Test_Graph_EDR_ANT1_2402_2Mbps_OBW

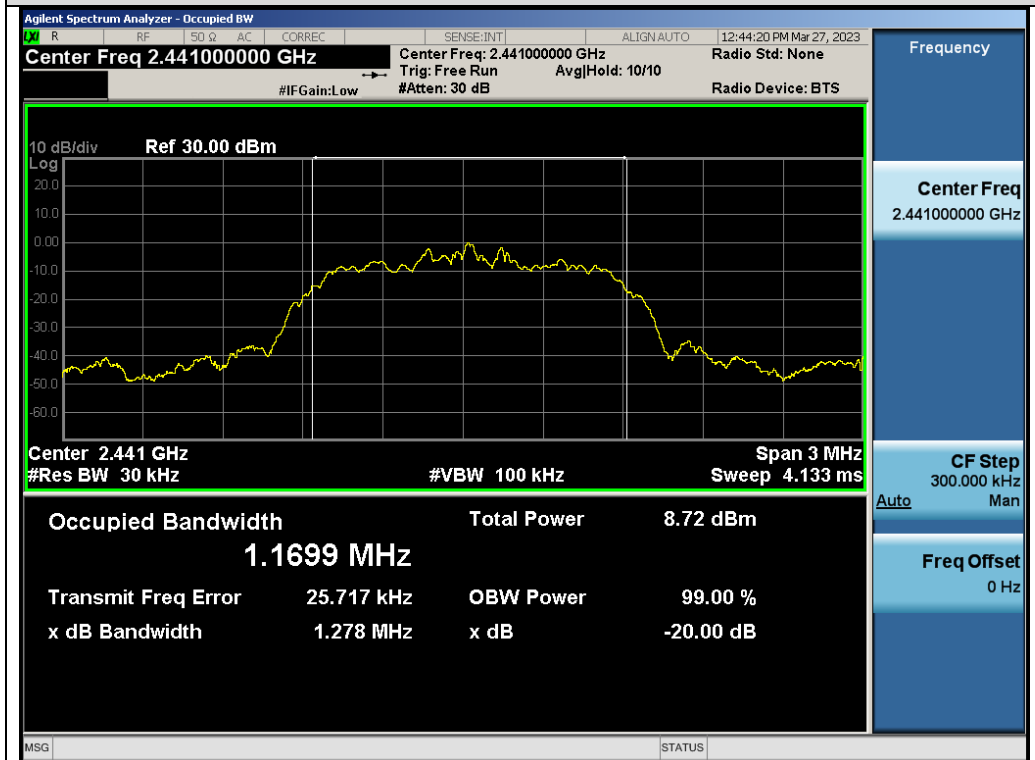

Test_Graph_EDR_ANT1_2441_2Mbps_OBW

Any report having not been signed by authorized approver, or having been altered without authorization, or having not been stamped by the "Dedicated Testing/Inspection Stamp" is deemed to be invalid. Copying or excerpting portion of, or altering the content of the report is not permitted without the written authorization of AGC. The test results presented in the report apply only to the tested sample. Any objections to report issued by AGC should be submitted to AGC within 15 days after the issuance of the test report. Further enquiry of validity or verification of the test report should be addressed to AGC by agc01@agccert.com.

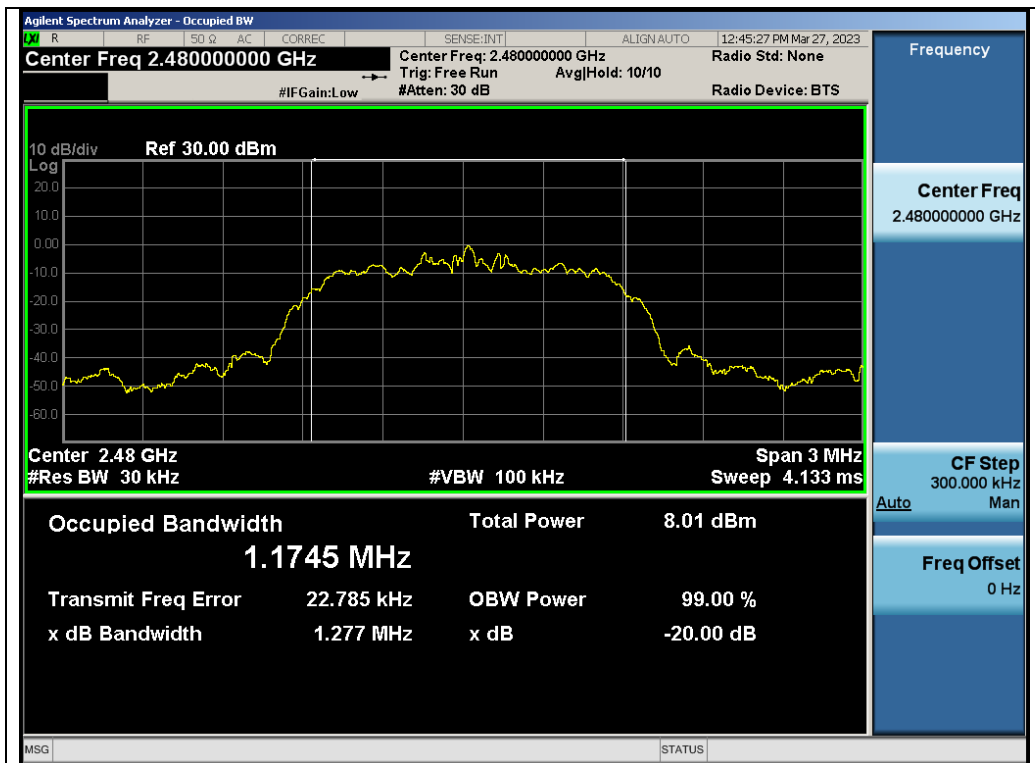

Test_Graph_EDR_ANT1_2480_2Mbps_OBW

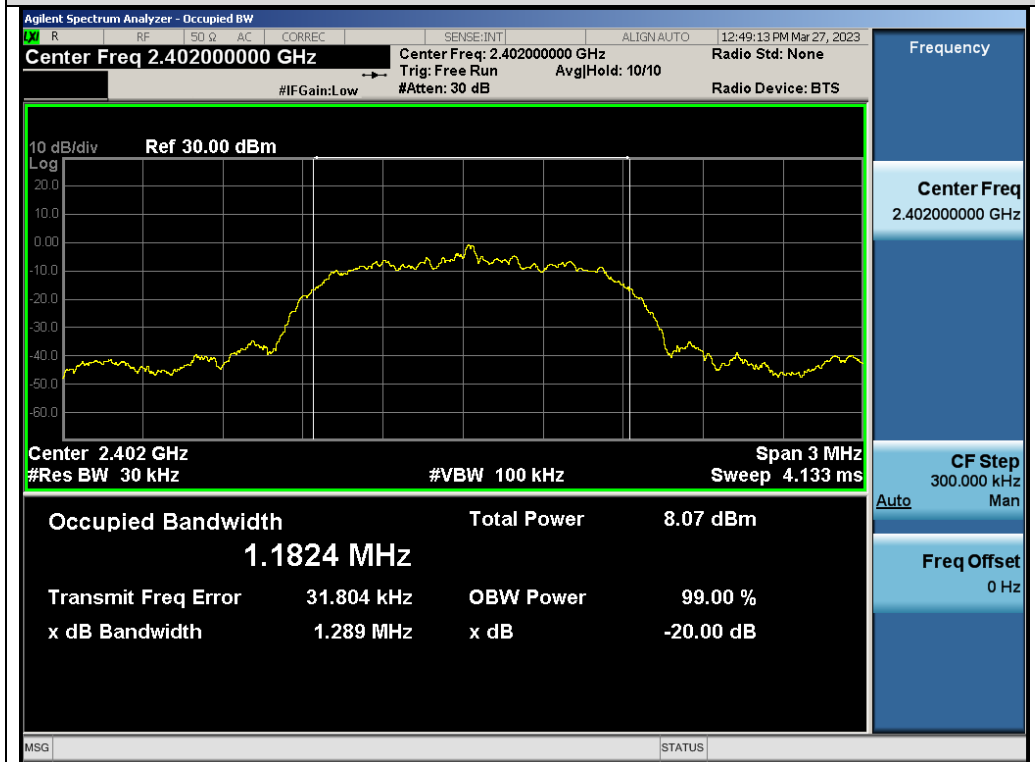

Test_Graph_EDR_ANT1_2402_3Mbps_OBW

Any report having not been signed by authorized approver, or having been altered without authorization, or having not been stamped by the "Dedicated Testing/Inspection Stamp" is deemed to be invalid. Copying or excerpting portion of, or altering the content of the report is not permitted without the written authorization of AGC. The test results presented in the report apply only to the tested sample. Any objections to report issued by AGC should be submitted to AGC within 15 days after the issuance of the test report. Further enquiry of validity or verification of the test report should be addressed to AGC by agc01@agccert.com.

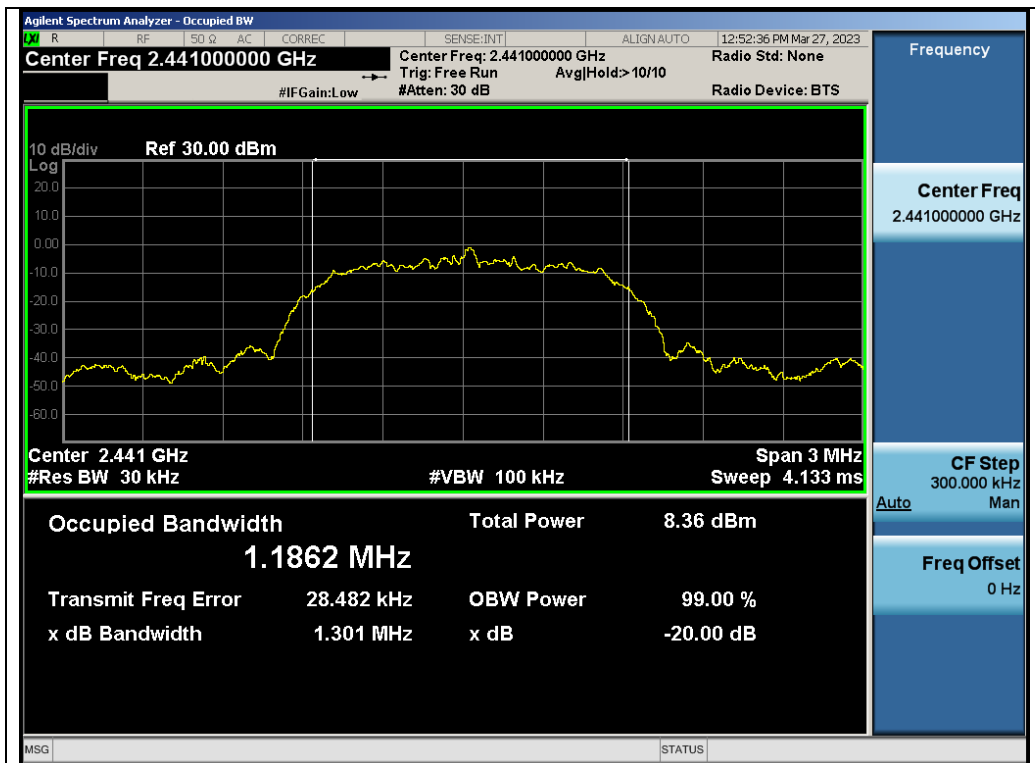

Test_Graph_EDR_ANT1_2441_3Mbps_OBW

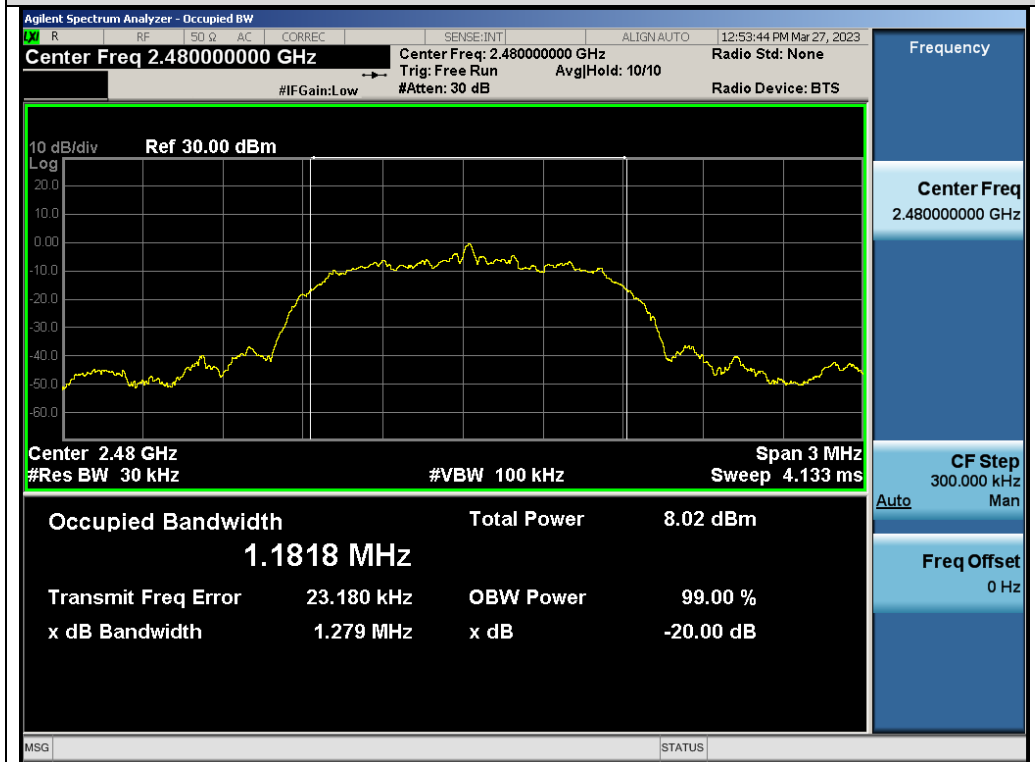

Test_Graph_EDR_ANT1_2480_3Mbps_OBW

Any report having not been signed by authorized approver, or having been altered without authorization, or having not been stamped by the "Dedicated Testing/Inspection Stamp" is deemed to be invalid. Copying or excerpting portion of, or altering the content of the report is not permitted without the written authorization of AGC. The test results presented in the report apply only to the tested sample. Any objections to report issued by AGC should be submitted to AGC within 15 days after the issuance of the test report. Further enquiry of validity or verification of the test report should be addressed to AGC by agc01@agccert.com.

9. CONDUCTED SPURIOUS EMISSION

9.1. MEASUREMENT PROCEDURE

1. Connect EUT RF output port to the Spectrum Analyzer through an RF attenuator
2. Set the EUT Work on the top, the Middle and the bottom operation frequency individually.
3. Set the Span = wide enough to capture the peak level of the in-band emission and all spurious emissions from the lowest frequency generated in the EUT up through the 10th harmonic.
RBW = 100 kHz; VBW= 300 kHz; Sweep = auto; Detector function = peak.
4. Set SPA Trace 1 Max hold, then View.

9.2. TEST SET-UP (BLOCK DIAGRAM OF CONFIGURATION)

The same as described in section 8.2

9.3. MEASUREMENT EQUIPMENT USED

The same as described in section 6

9.4. LIMITS AND MEASUREMENT RESULT

LIMITS AND MEASUREMENT RESULT		
Applicable Limits	Measurement Result	
	Test Data	Criteria
In any 100 kHz Bandwidth Outside the frequency band in which the spread spectrum intentional radiator is operating, the radio frequency power that is produce by the intentional radiator shall be at least 20 dB below that in 100KHz bandwidth within the band that contains the highest level of the desired power. In addition, radiation emissions which fall in the restricted bands, as defined in §15.205(a), must also comply with the radiated emission limits specified in§15.209(a)	At least -20dBc than the limit Specified on the BOTTOM Channel	PASS
	At least -20dBc than the limit Specified on the TOP Channel	PASS

Any report having not been signed by authorized approver, or having been altered without authorization, or having not been stamped by the "Dedicated Testing/Inspection Stamp" is deemed to be invalid. Copying or excerpting portion of, or altering the content of the report is not permitted without the written authorization of AGC. The test results presented in the report apply only to the tested sample. Any objections to report issued by AGC should be submitted to AGC within 15days after the issuance of the test report. Further enquiry of validity or verification of the test report should be addressed to AGC by agc01@agccert.com.

Test Graphs of Spurious Emissions in Non-Restricted Frequency Bands



Test_Graph_BR_ANT1_2402_1Mbps_Reference Level

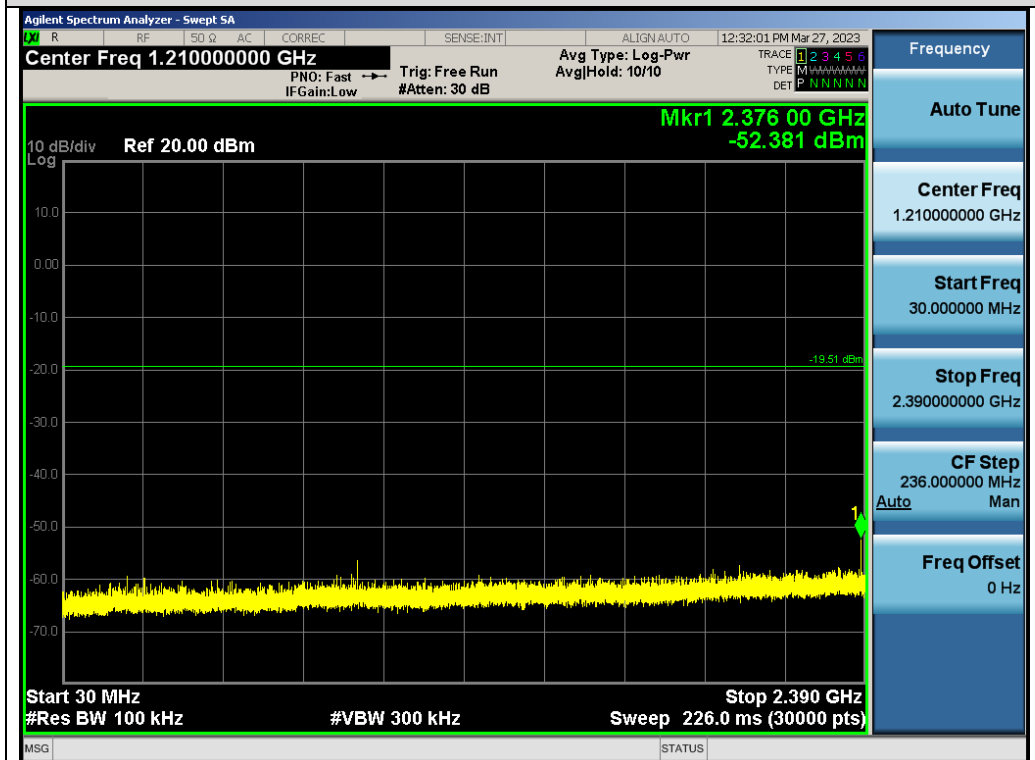

Test_Graph_BR_ANT1_2402_1Mbps_Lower Band Emissions

Any report having not been signed by authorized approver, or having been altered without authorization, or having not been stamped by the "Dedicated Testing/Inspection Stamp" is deemed to be invalid. Copying or excerpting portion of, or altering the content of the report is not permitted without the written authorization of AGC. The test results presented in the report apply only to the tested sample. Any objections to report issued by AGC should be submitted to AGC within 15days after the issuance of the test report. Further enquiry of validity or verification of the test report should be addressed to AGC by agc01@agccert.com.

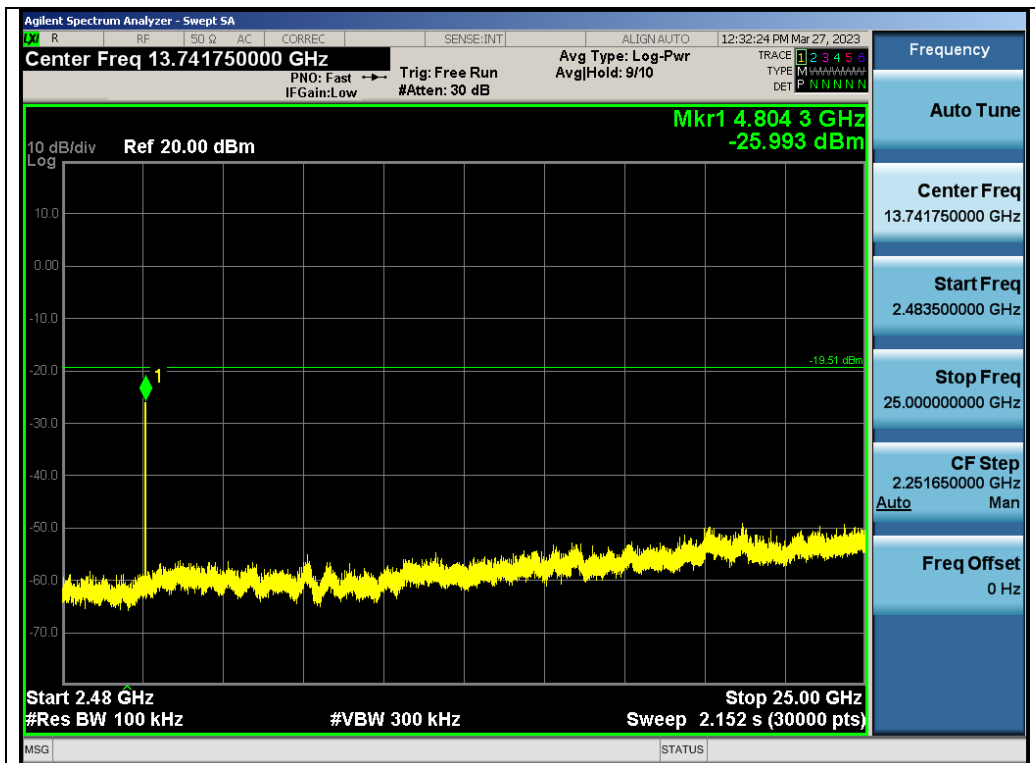

Test_Graph_BR_ANT1_2402_1Mbps_Higher Band Emissions



Test_Graph_BR_ANT1_2441_1Mbps_Reference Level

Any report having not been signed by authorized approver, or having been altered without authorization, or having not been stamped by the "Dedicated Testing/Inspection Stamp" is deemed to be invalid. Copying or excerpting portion of, or altering the content of the report is not permitted without the written authorization of AGC. The test results presented in the report apply only to the tested sample. Any objections to report issued by AGC should be submitted to AGC within 15days after the issuance of the test report. Further enquiry of validity or verification of the test report should be addressed to AGC by agc01@agccert.com.

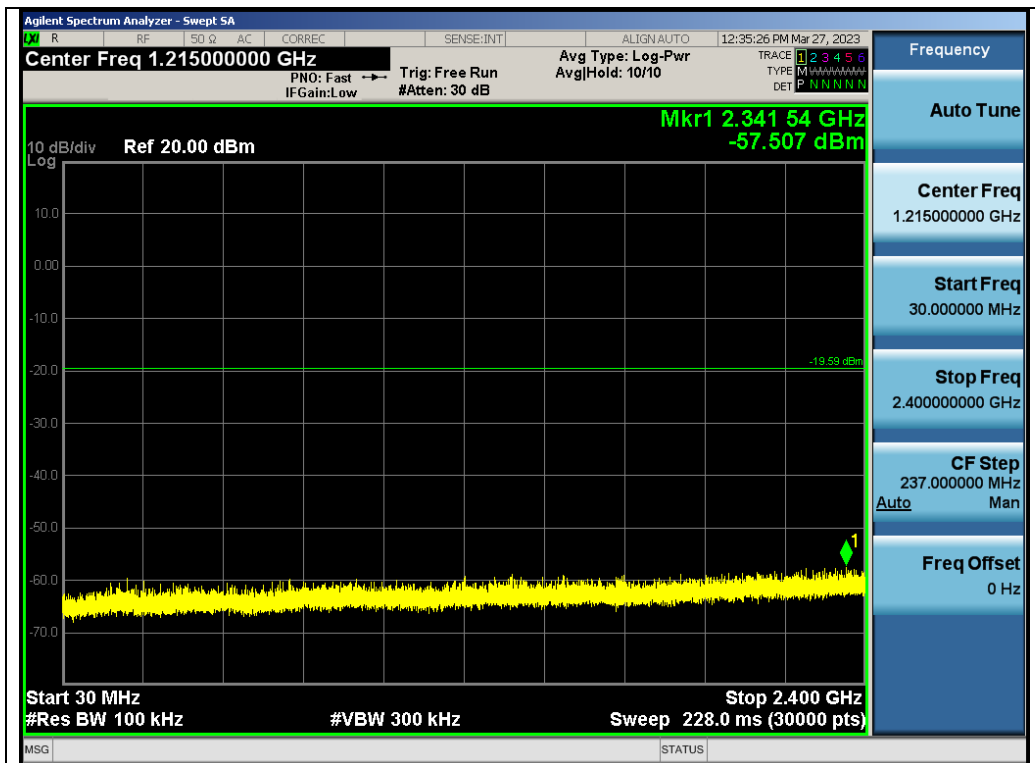

Test_Graph_BR_ANT1_2441_1Mbps_Lower Band Emissions

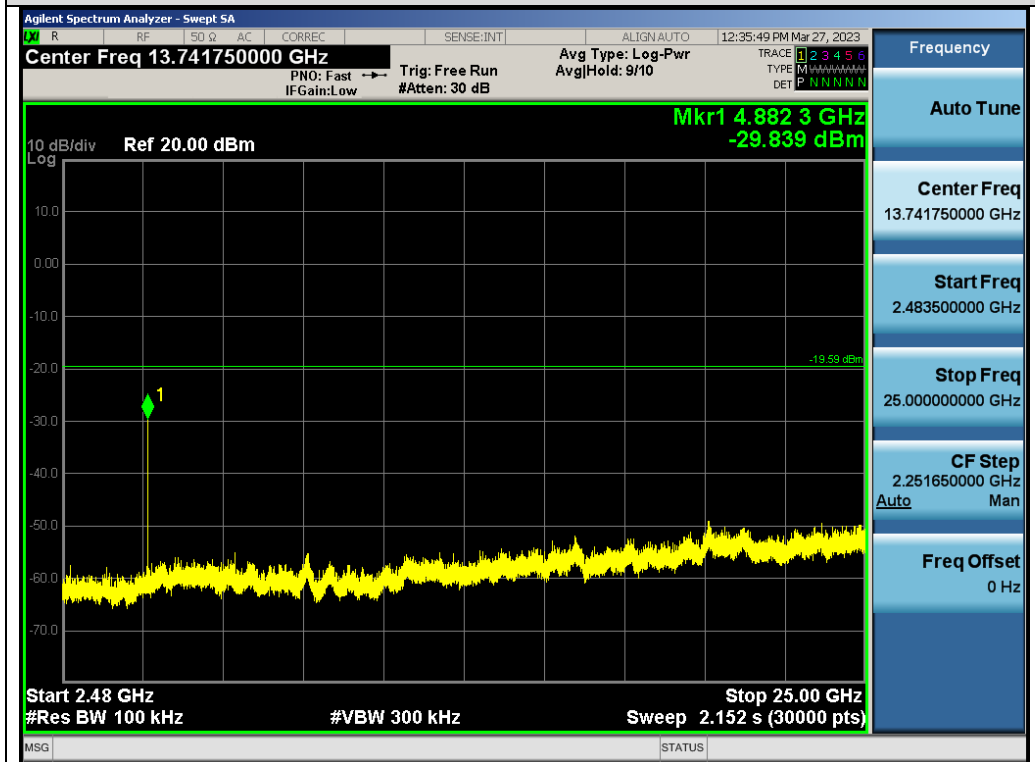

Test_Graph_BR_ANT1_2441_1Mbps_Higher Band Emissions

Any report having not been signed by authorized approver, or having been altered without authorization, or having not been stamped by the "Dedicated Testing/Inspection Stamp" is deemed to be invalid. Copying or excerpting portion of, or altering the content of the report is not permitted without the written authorization of AGC. The test results presented in the report apply only to the tested sample. Any objections to report issued by AGC should be submitted to AGC within 15days after the issuance of the test report. Further enquiry of validity or verification of the test report should be addressed to AGC by agc01@agccert.com.

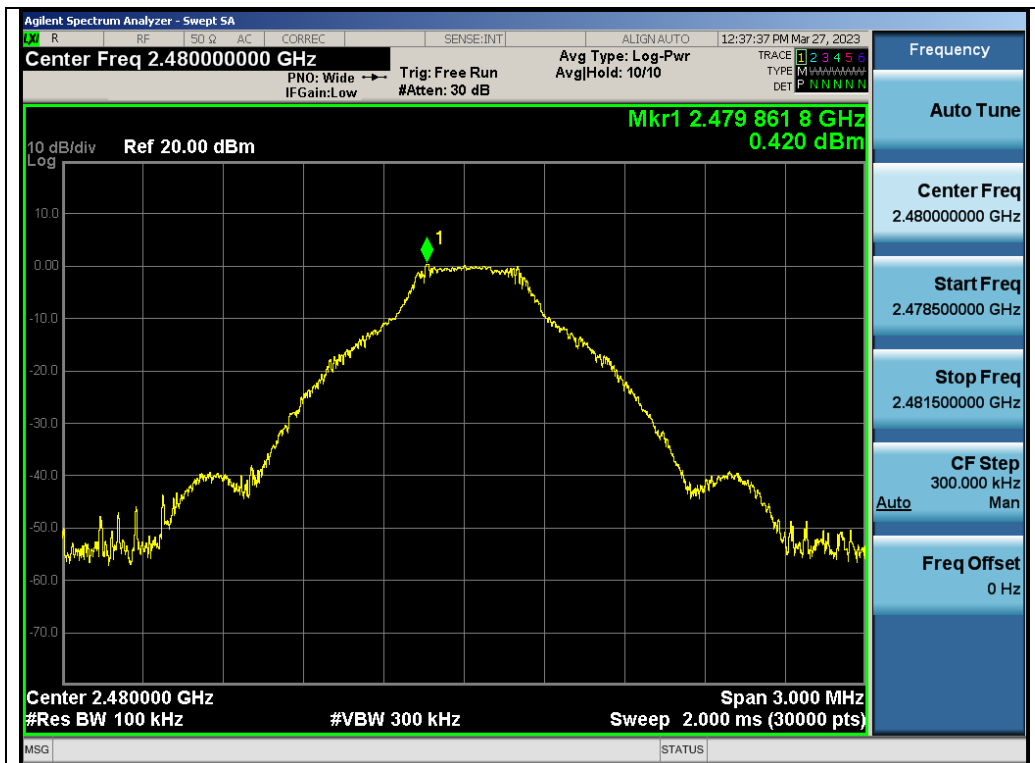

Test_Graph_BR_ANT1_2480_1Mbps_Reference Level

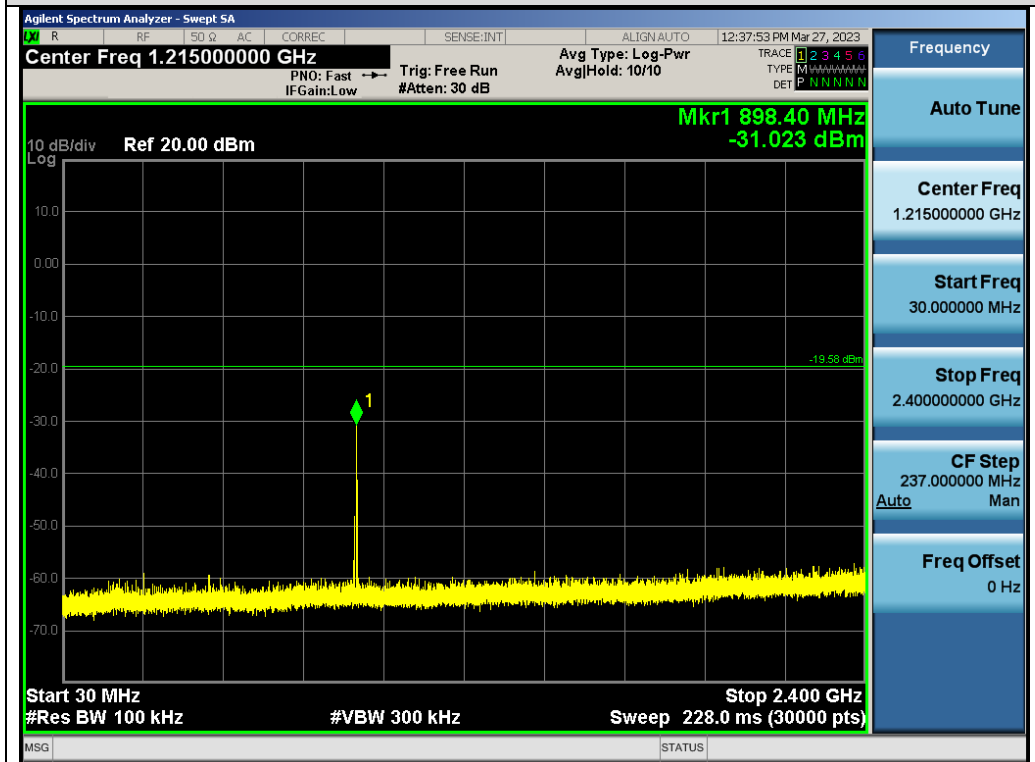

Test_Graph_BR_ANT1_2480_1Mbps_Lower Band Emissions

Any report having not been signed by authorized approver, or having been altered without authorization, or having not been stamped by the "Dedicated Testing/Inspection Stamp" is deemed to be invalid. Copying or excerpting portion of, or altering the content of the report is not permitted without the written authorization of AGC. The test results presented in the report apply only to the tested sample. Any objections to report issued by AGC should be submitted to AGC within 15days after the issuance of the test report. Further enquiry of validity or verification of the test report should be addressed to AGC by agc01@agccert.com.

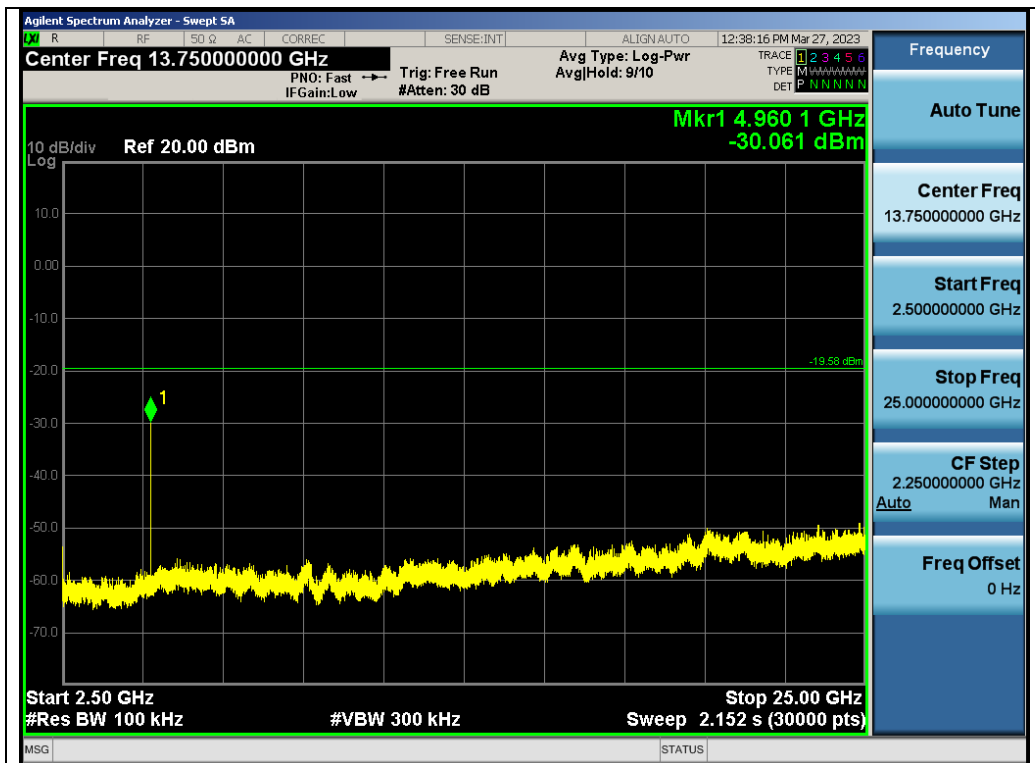

Test_Graph_BR_ANT1_2480_1Mbps_Higher Band Emissions



Test_Graph_EDR_ANT1_2402_2Mbps_Reference Level

Any report having not been signed by authorized approver, or having been altered without authorization, or having not been stamped by the "Dedicated Testing/Inspection Stamp" is deemed to be invalid. Copying or excerpting portion of, or altering the content of the report is not permitted without the written authorization of AGC. The test results presented in the report apply only to the tested sample. Any objections to report issued by AGC should be submitted to AGC within 15days after the issuance of the test report. Further enquiry of validity or verification of the test report should be addressed to AGC by agc01@agccert.com.

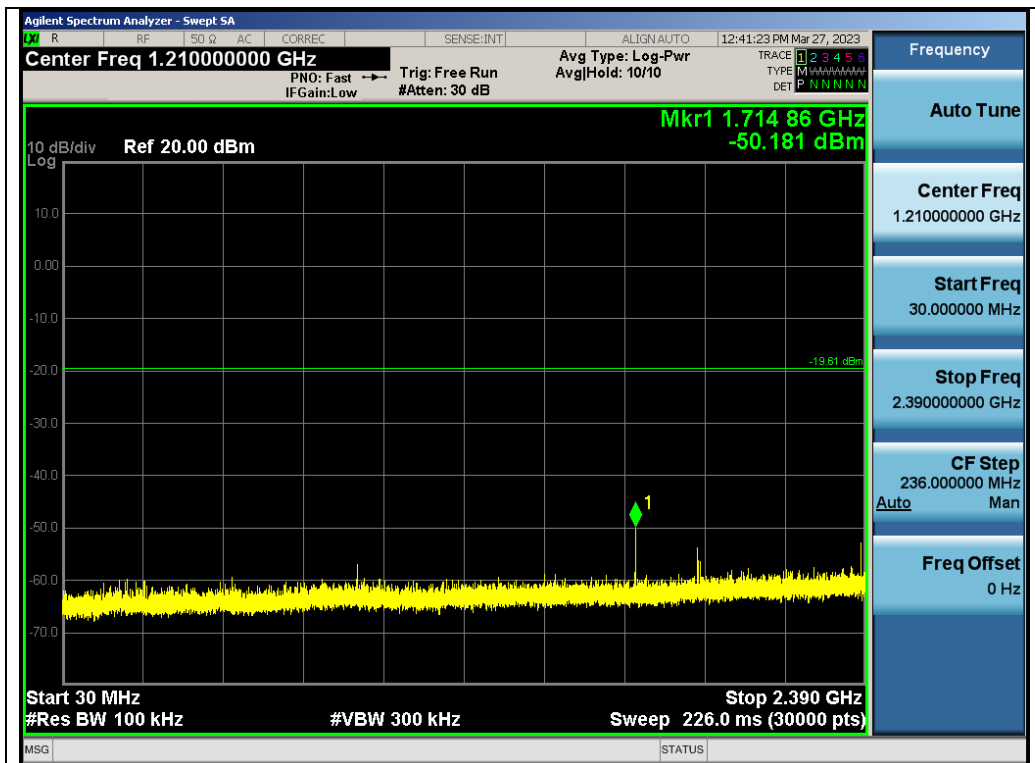

Test_Graph_EDR_ANT1_2402_2Mbps_Lower Band Emissions

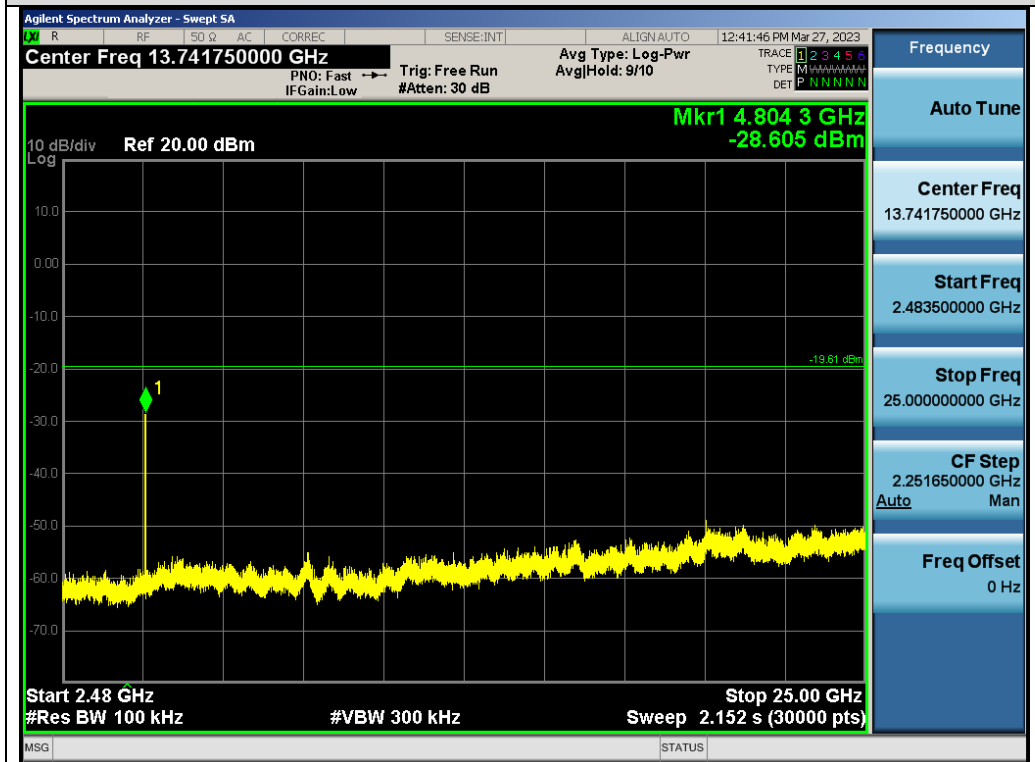

Test_Graph_EDR_ANT1_2402_2Mbps_Higher Band Emissions

Any report having not been signed by authorized approver, or having been altered without authorization, or having not been stamped by the "Dedicated Testing/Inspection Stamp" is deemed to be invalid. Copying or excerpting portion of, or altering the content of the report is not permitted without the written authorization of AGC. The test results presented in the report apply only to the tested sample. Any objections to report issued by AGC should be submitted to AGC within 15days after the issuance of the test report. Further enquiry of validity or verification of the test report should be addressed to AGC by agc01@agccert.com.

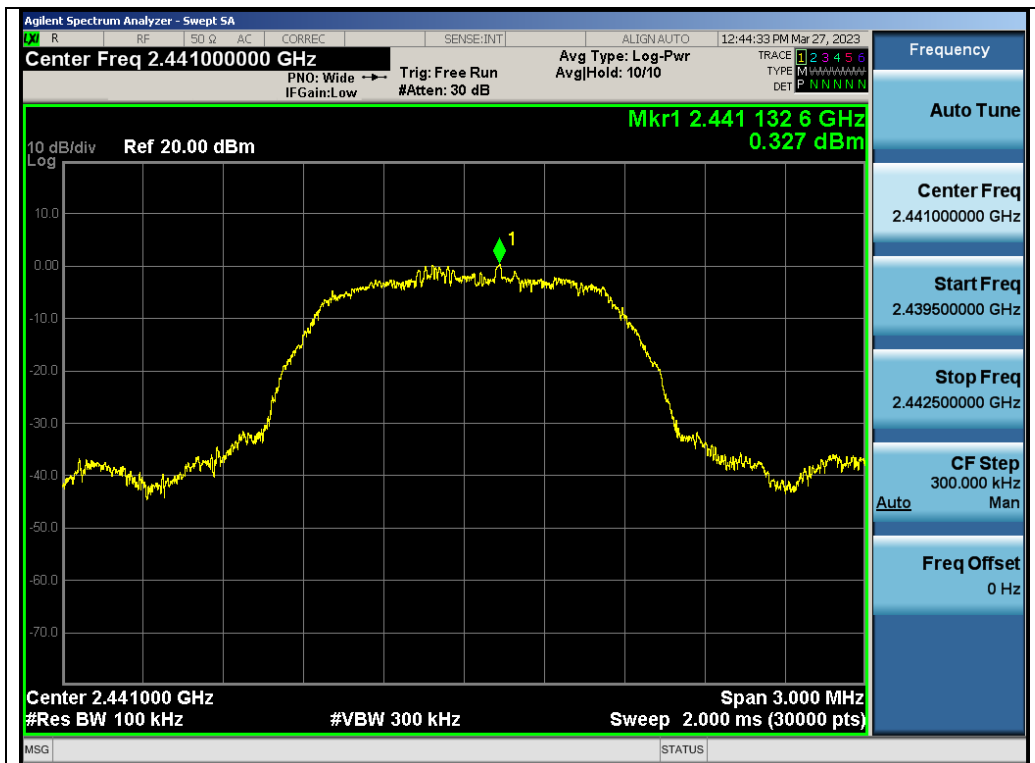

Test_Graph_EDR_ANT1_2441_2Mbps_Reference Level

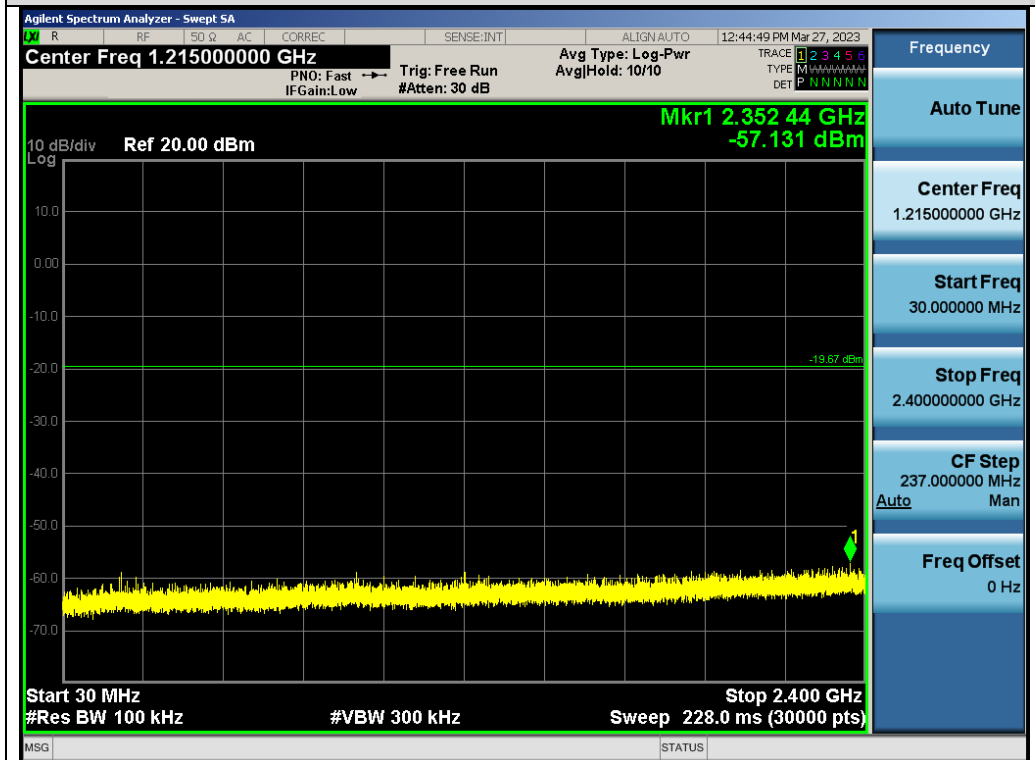

Test_Graph_EDR_ANT1_2441_2Mbps_Lower Band Emissions

Any report having not been signed by authorized approver, or having been altered without authorization, or having not been stamped by the "Dedicated Testing/Inspection Stamp" is deemed to be invalid. Copying or excerpting portion of, or altering the content of the report is not permitted without the written authorization of AGC. The test results presented in the report apply only to the tested sample. Any objections to report issued by AGC should be submitted to AGC within 15days after the issuance of the test report. Further enquiry of validity or verification of the test report should be addressed to AGC by agc01@agccert.com.

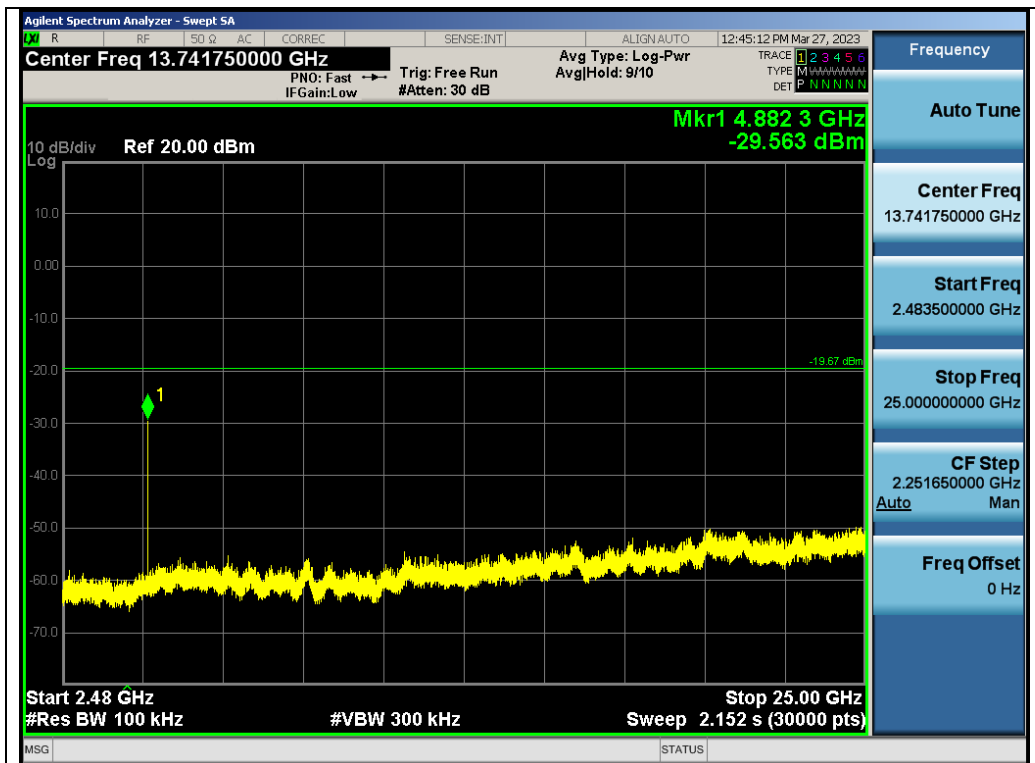

Test_Graph_EDR_ANT1_2441_2Mbps_Higher Band Emissions

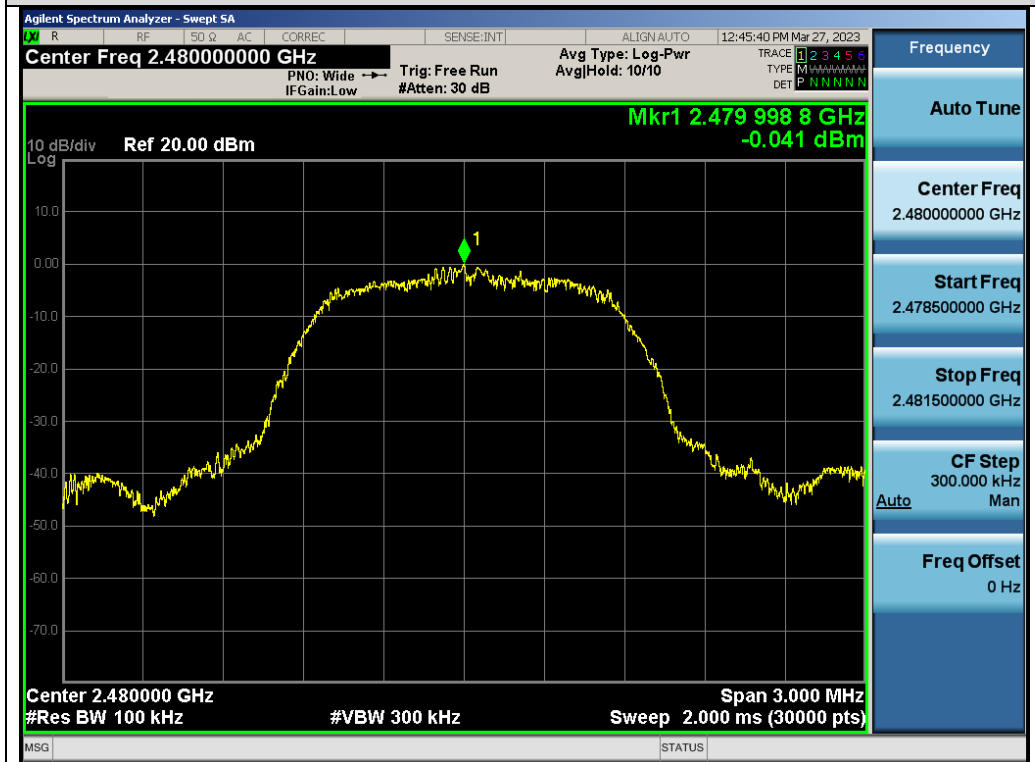

Test_Graph_EDR_ANT1_2480_2Mbps_Reference Level

Any report having not been signed by authorized approver, or having been altered without authorization, or having not been stamped by the "Dedicated Testing/Inspection Stamp" is deemed to be invalid. Copying or excerpting portion of, or altering the content of the report is not permitted without the written authorization of AGC. The test results presented in the report apply only to the tested sample. Any objections to report issued by AGC should be submitted to AGC within 15days after the issuance of the test report. Further enquiry of validity or verification of the test report should be addressed to AGC by agc01@agccert.com.

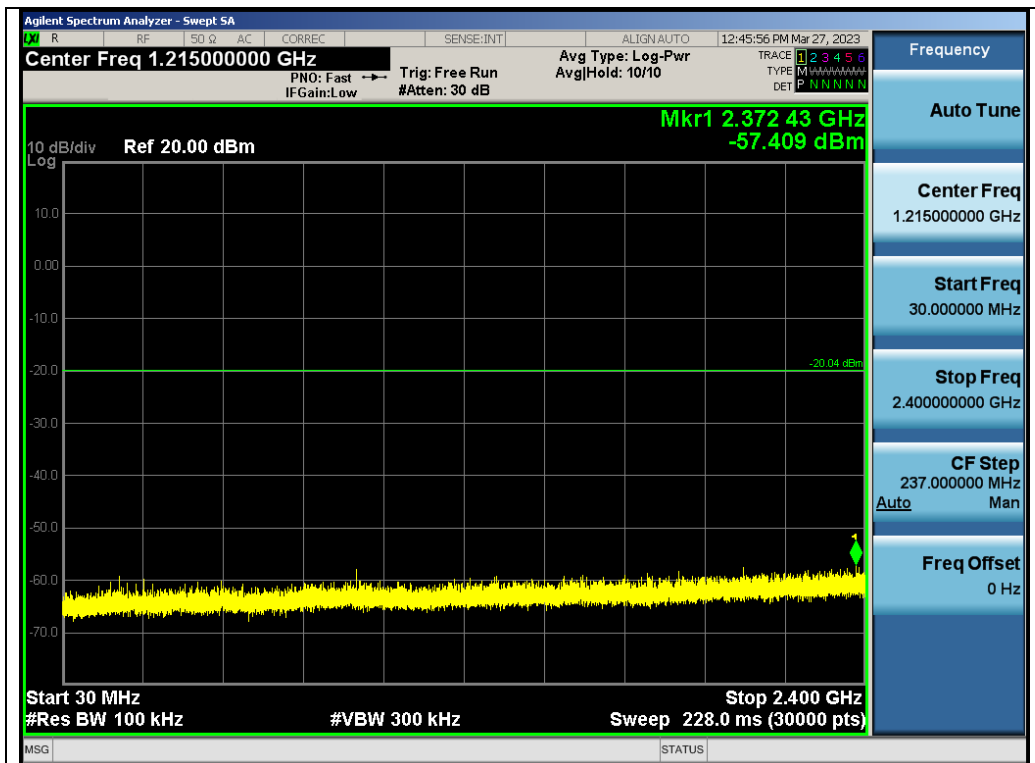

Test_Graph_EDR_ANT1_2480_2Mbps_Lower Band Emissions

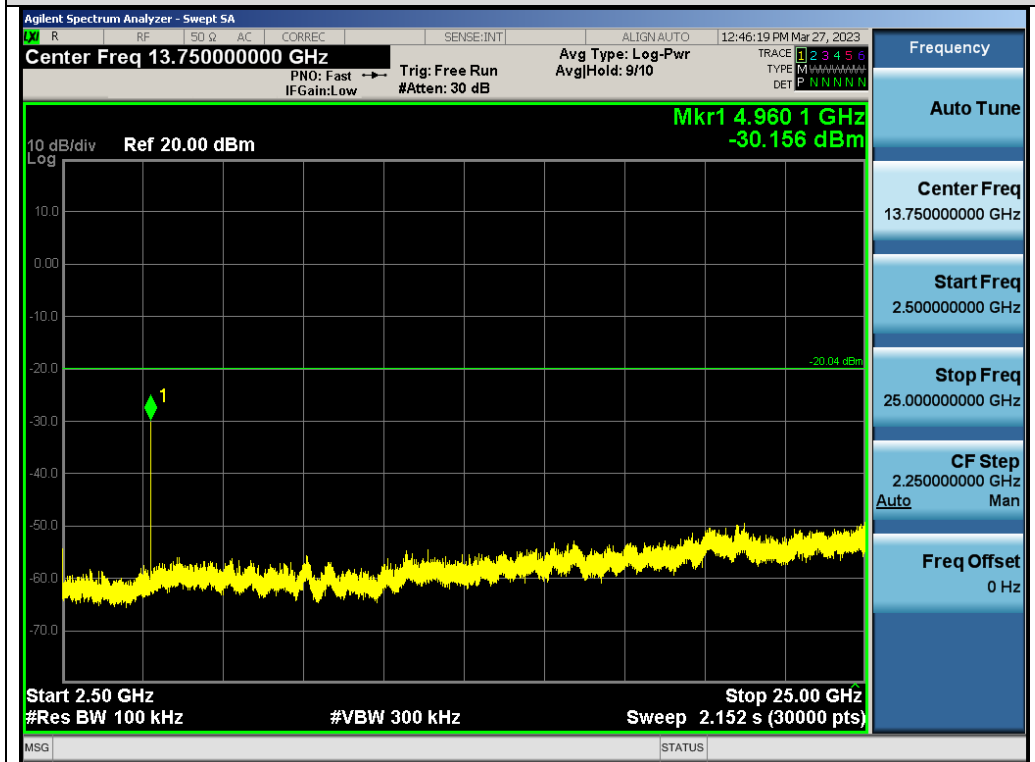

Test_Graph_EDR_ANT1_2480_2Mbps_Higher Band Emissions

Any report having not been signed by authorized approver, or having been altered without authorization, or having not been stamped by the "Dedicated Testing/Inspection Stamp" is deemed to be invalid. Copying or excerpting portion of, or altering the content of the report is not permitted without the written authorization of AGC. The test results presented in the report apply only to the tested sample. Any objections to report issued by AGC should be submitted to AGC within 15days after the issuance of the test report. Further enquiry of validity or verification of the test report should be addressed to AGC by agc01@agccert.com.

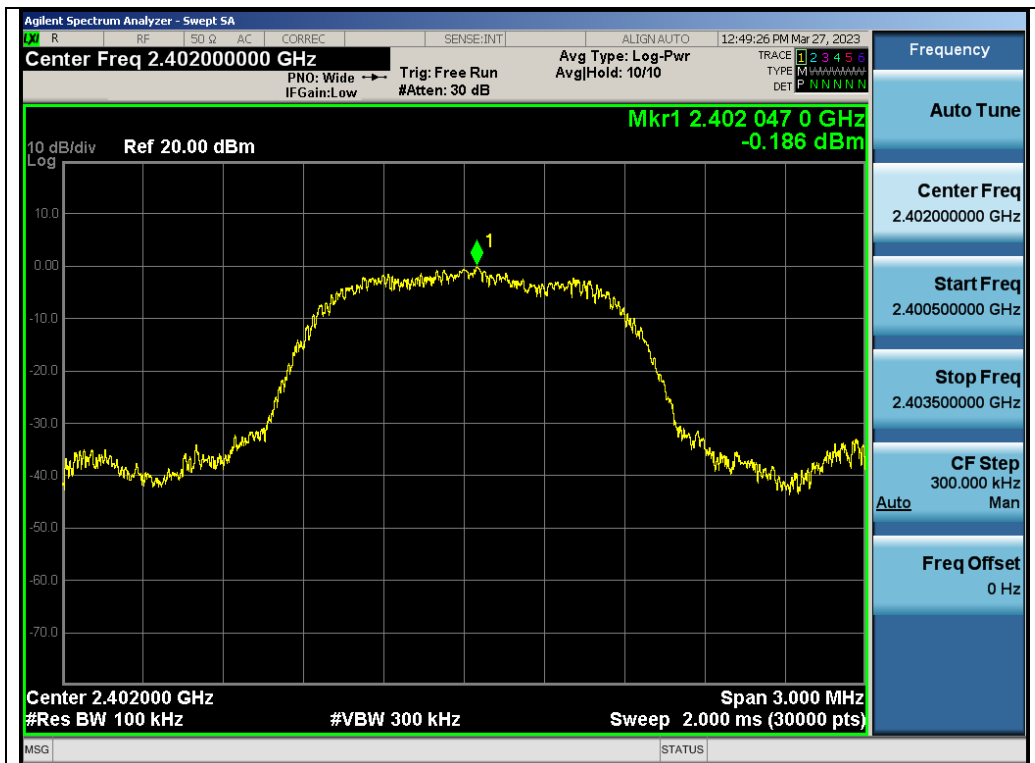

Test_Graph_EDR_ANT1_2402_3Mbps_Reference Level

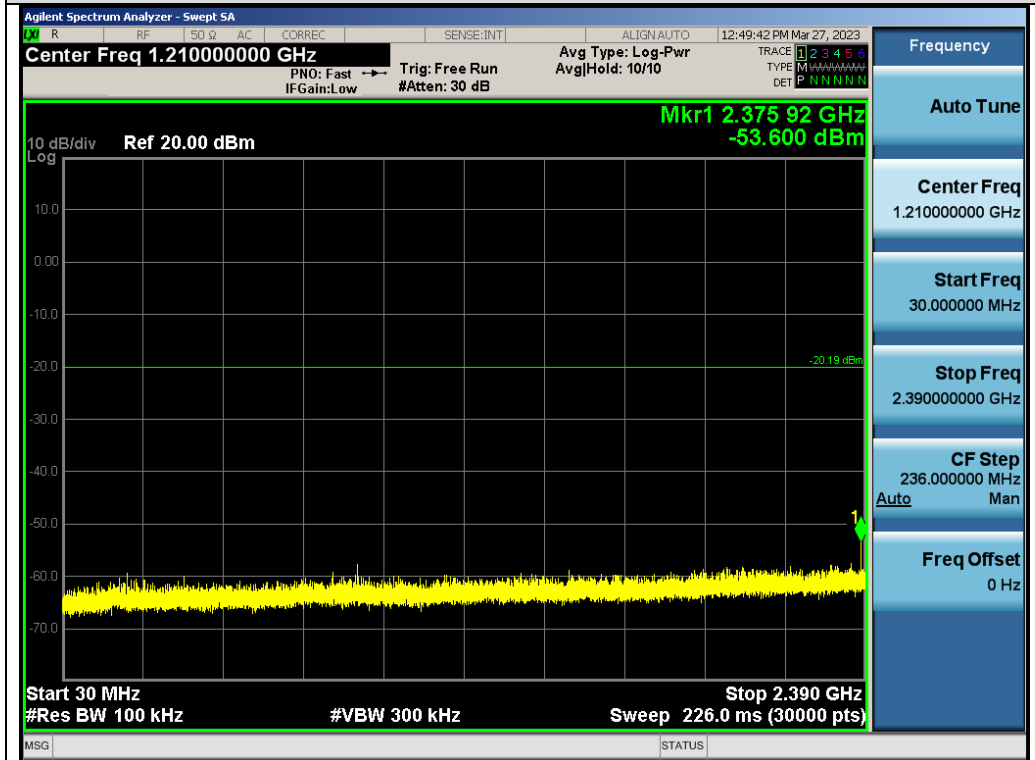

Test_Graph_EDR_ANT1_2402_3Mbps_Lower Band Emissions

Any report having not been signed by authorized approver, or having been altered without authorization, or having not been stamped by the "Dedicated Testing/Inspection Stamp" is deemed to be invalid. Copying or excerpting portion of, or altering the content of the report is not permitted without the written authorization of AGC. The test results presented in the report apply only to the tested sample. Any objections to report issued by AGC should be submitted to AGC within 15days after the issuance of the test report. Further enquiry of validity or verification of the test report should be addressed to AGC by agc01@agccert.com.

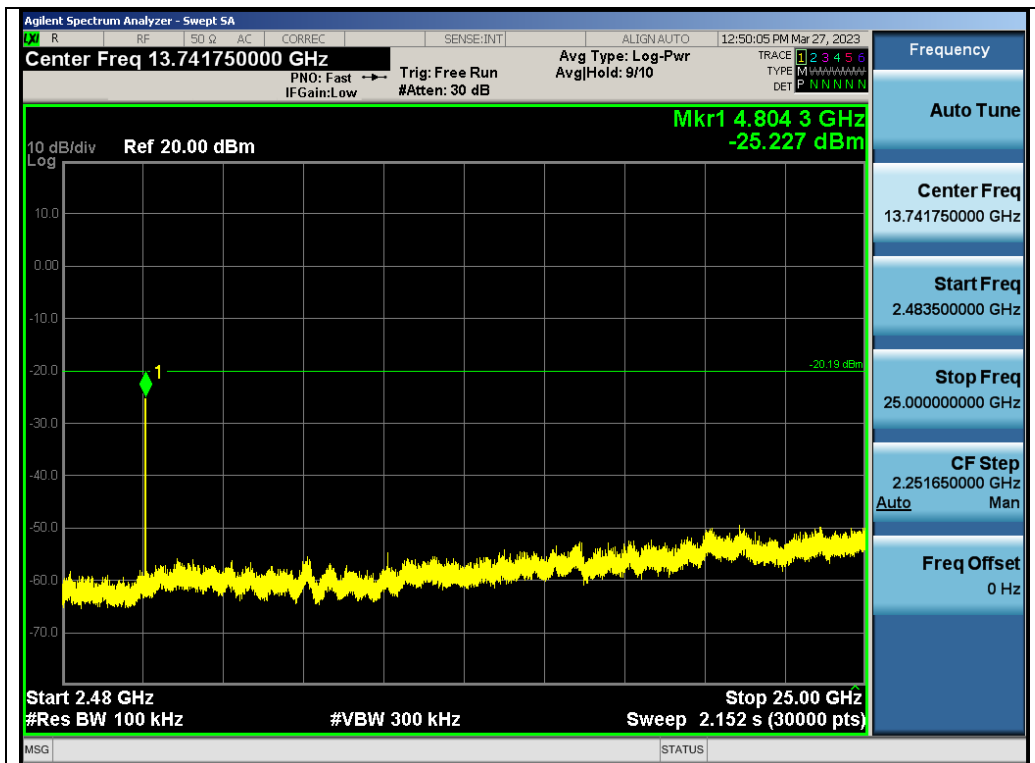

Test_Graph_EDR_ANT1_2402_3Mbps_Higher Band Emissions



Test_Graph_EDR_ANT1_2441_3Mbps_Reference Level

Any report having not been signed by authorized approver, or having been altered without authorization, or having not been stamped by the "Dedicated Testing/Inspection Stamp" is deemed to be invalid. Copying or excerpting portion of, or altering the content of the report is not permitted without the written authorization of AGC. The test results presented in the report apply only to the tested sample. Any objections to report issued by AGC should be submitted to AGC within 15days after the issuance of the test report. Further enquiry of validity or verification of the test report should be addressed to AGC by agc01@agccert.com.

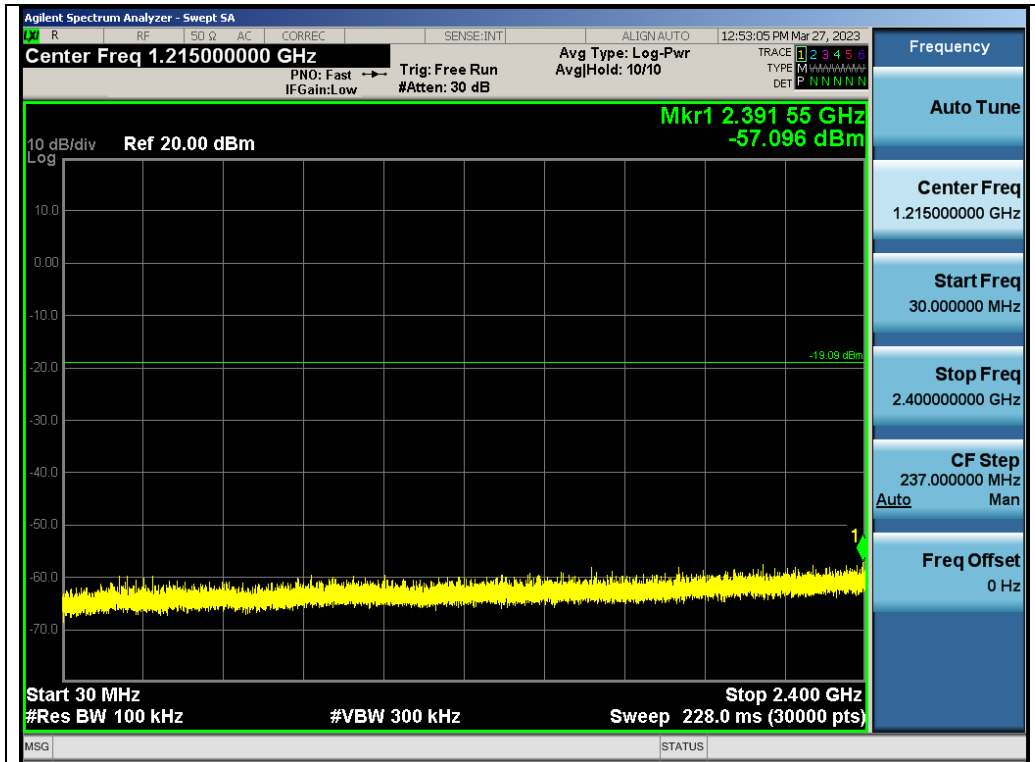

Test_Graph_EDR_ANT1_2441_3Mbps_Lower Band Emissions

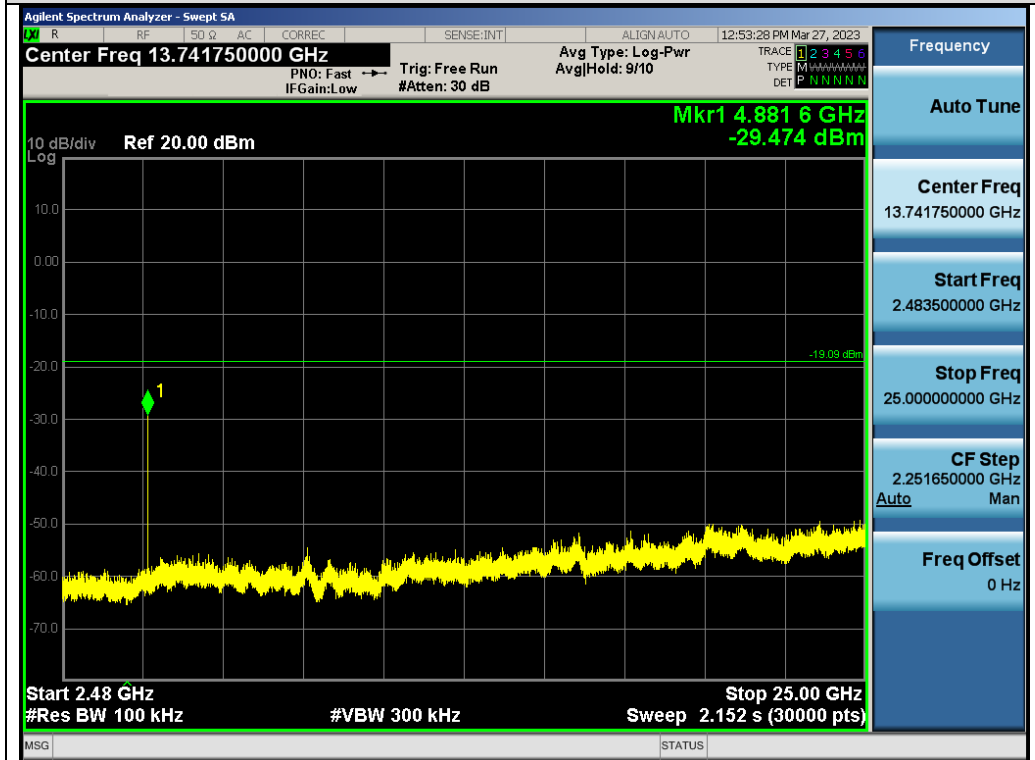

Test_Graph_EDR_ANT1_2441_3Mbps_Higher Band Emissions

Any report having not been signed by authorized approver, or having been altered without authorization, or having not been stamped by the "Dedicated Testing/Inspection Stamp" is deemed to be invalid. Copying or excerpting portion of, or altering the content of the report is not permitted without the written authorization of AGC. The test results presented in the report apply only to the tested sample. Any objections to report issued by AGC should be submitted to AGC within 15days after the issuance of the test report. Further enquiry of validity or verification of the test report should be addressed to AGC by agc01@agccert.com.

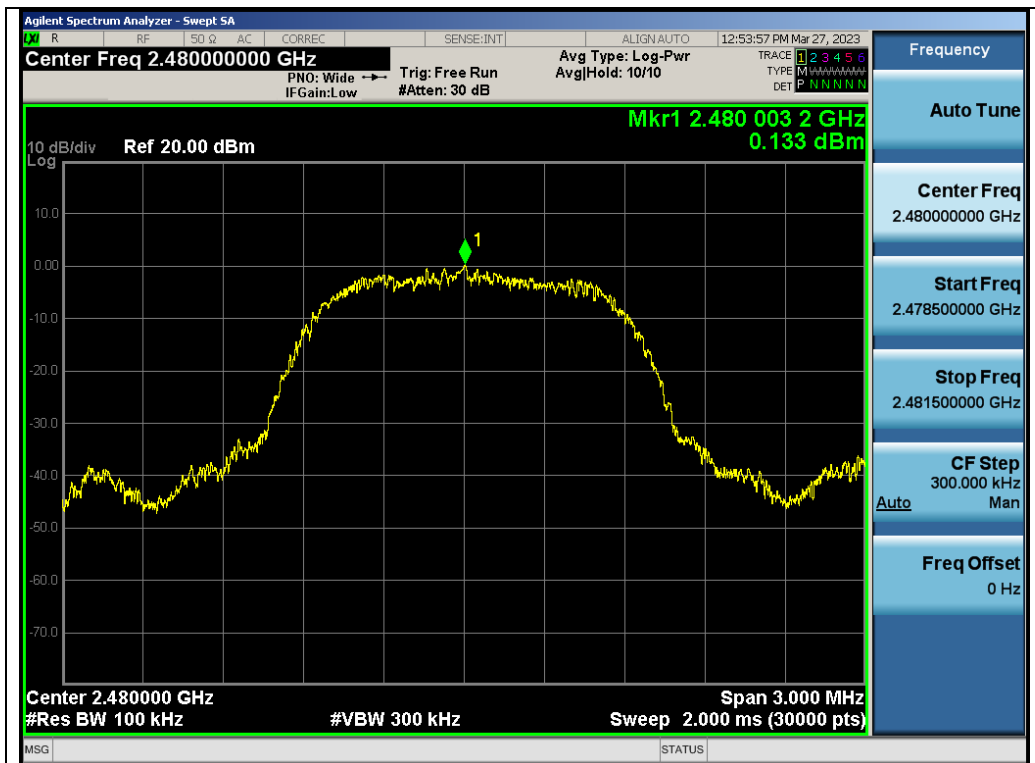

Test_Graph_EDR_ANT1_2480_3Mbps_Reference Level

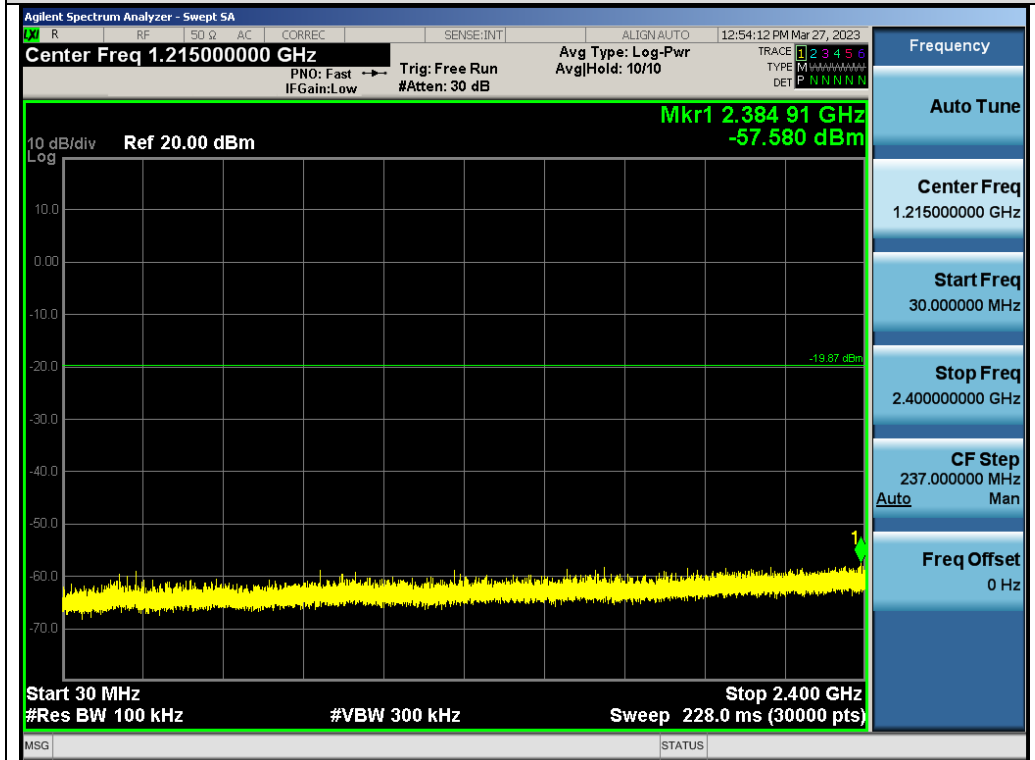

Test_Graph_EDR_ANT1_2480_3Mbps_Lower Band Emissions

Any report having not been signed by authorized approver, or having been altered without authorization, or having not been stamped by the "Dedicated Testing/Inspection Stamp" is deemed to be invalid. Copying or excerpting portion of, or altering the content of the report is not permitted without the written authorization of AGC. The test results presented in the report apply only to the tested sample. Any objections to report issued by AGC should be submitted to AGC within 15days after the issuance of the test report. Further enquiry of validity or verification of the test report should be addressed to AGC by agc01@agccert.com.

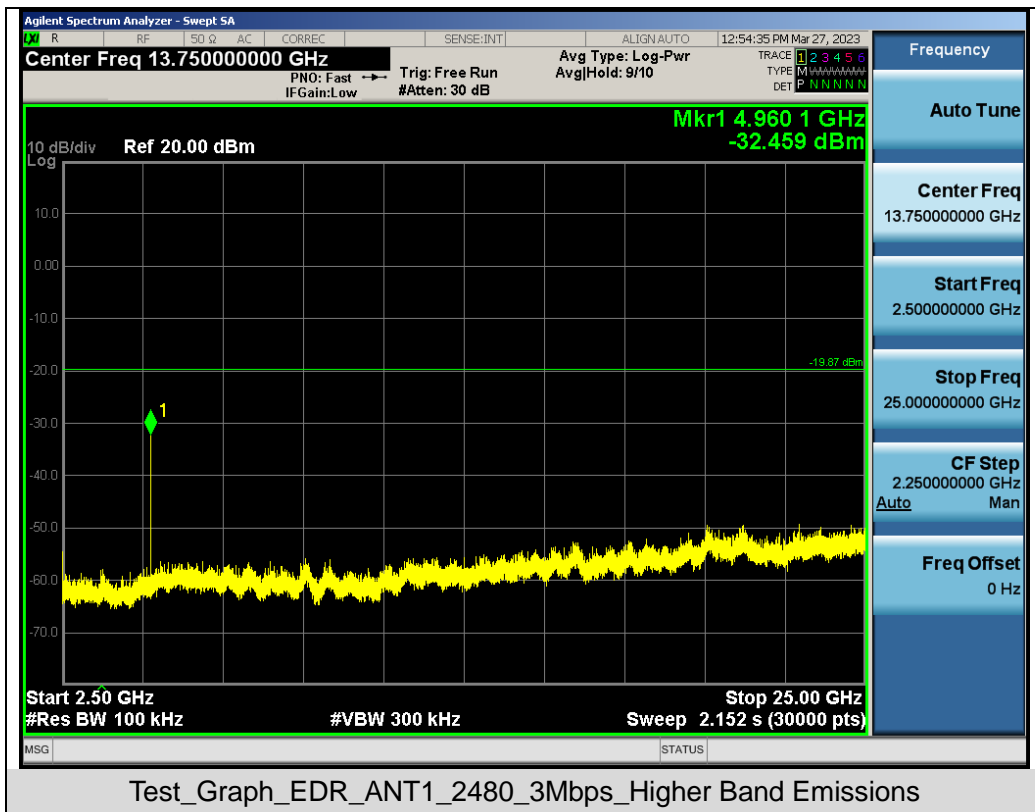

Any report having not been signed by authorized approver, or having been altered without authorization, or having not been stamped by the "Dedicated Testing/Inspection Stamp" is deemed to be invalid. Copying or excerpting portion of, or altering the content of the report is not permitted without the written authorization of AGC. The test results presented in the report apply only to the tested sample. Any objections to report issued by AGC should be submitted to AGC within 15days after the issuance of the test report. Further enquiry of validity or verification of the test report should be addressed to AGC by agc01@agccert.com.

Attestation of Global Compliance(Shenzhen)Co., Ltd
 Attestation of Global Compliance(Shenzhen)Std & Tech Co., Ltd
 Tel: +86-755 2523 4088 E-mail: agc@agccert.com Web: http://www.agccert.com/

Test Graphs of Band Edge Emissions in Non-Restricted Frequency Bands

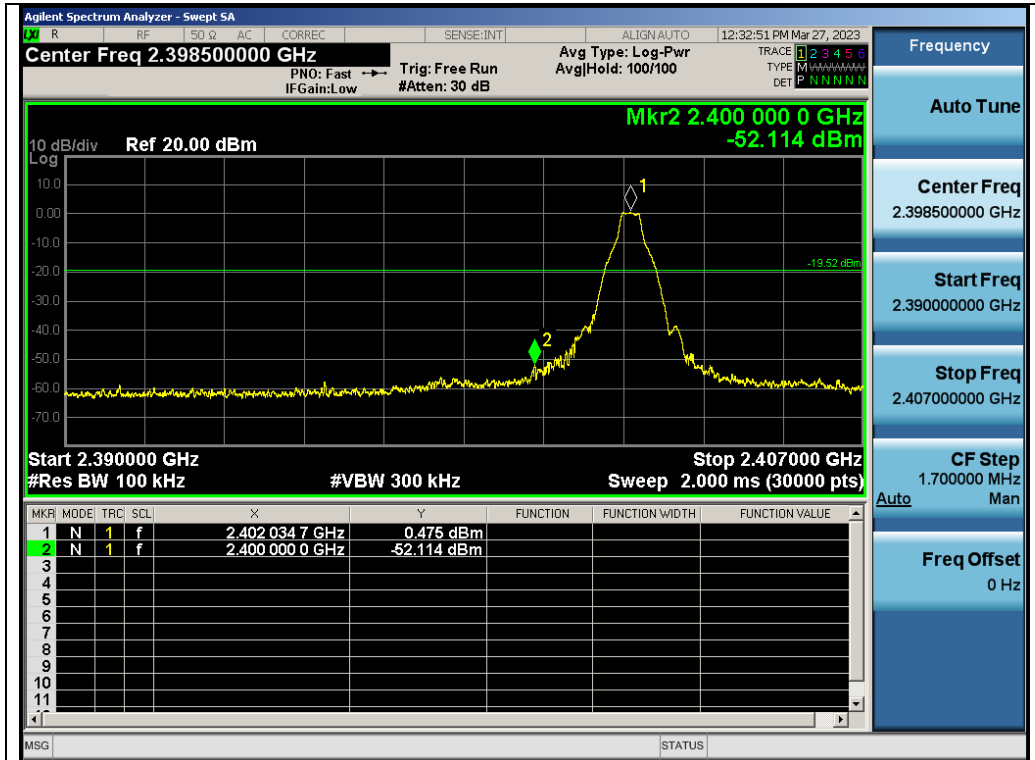

Test_Graph_BR_ANT1_2402_1Mbps_Lower Band Edge Emissions

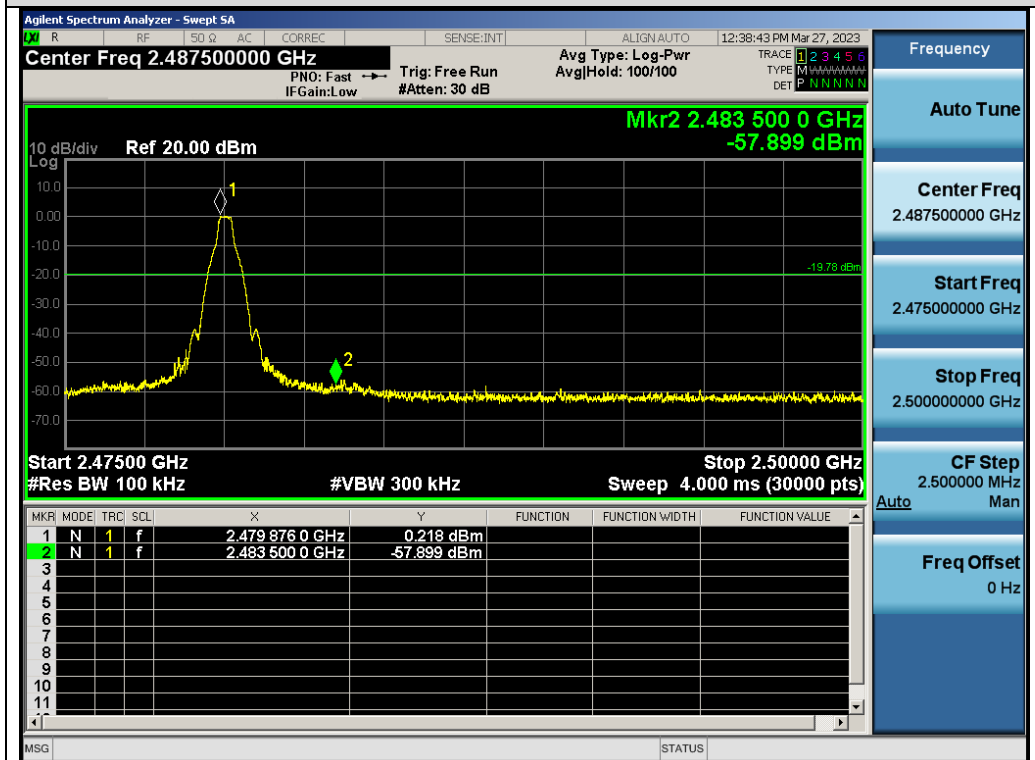

Test_Graph_BR_ANT1_2480_1Mbps_Higher Band Edge Emissions

Any report having not been signed by authorized approver, or having been altered without authorization, or having not been stamped by the "Dedicated Testing/Inspection Stamp" is deemed to be invalid. Copying or excerpting portion of, or altering the content of the report is not permitted without the written authorization of AGC. The test results presented in the report apply only to the tested sample. Any objections to report issued by AGC should be submitted to AGC within 15days after the issuance of the test report. Further enquiry of validity or verification of the test report should be addressed to AGC by agc01@agccert.com.

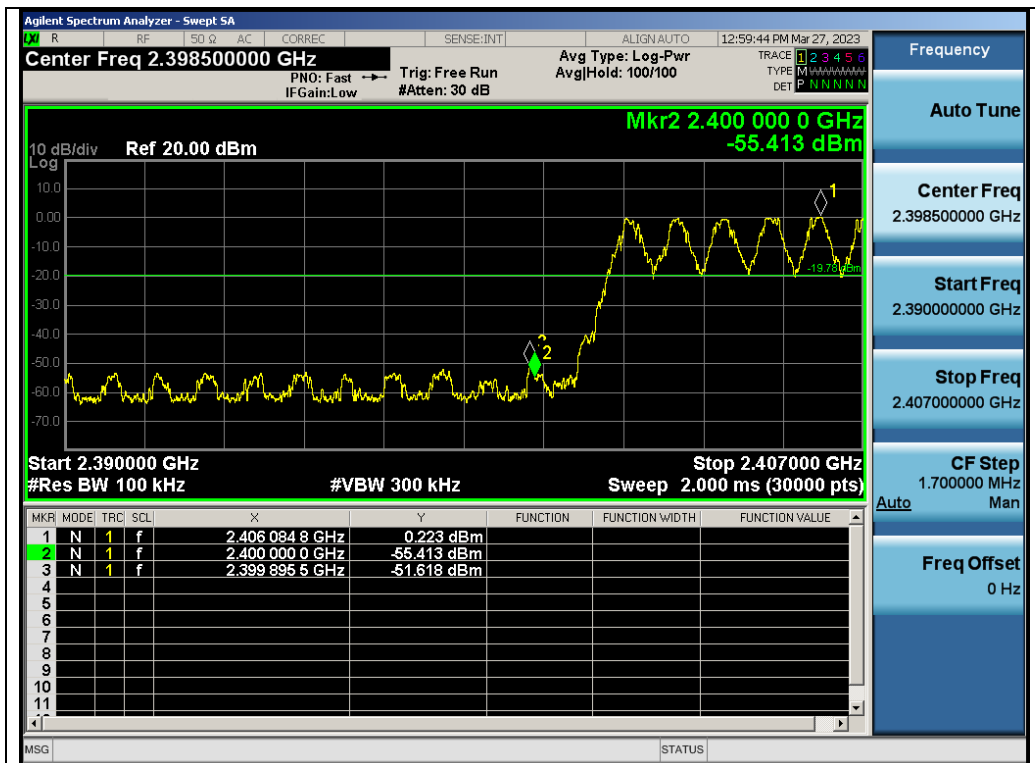

Test_Graph_BR_HOP_ANT1_NA_1Mbps_Lower Band Edge Emissions

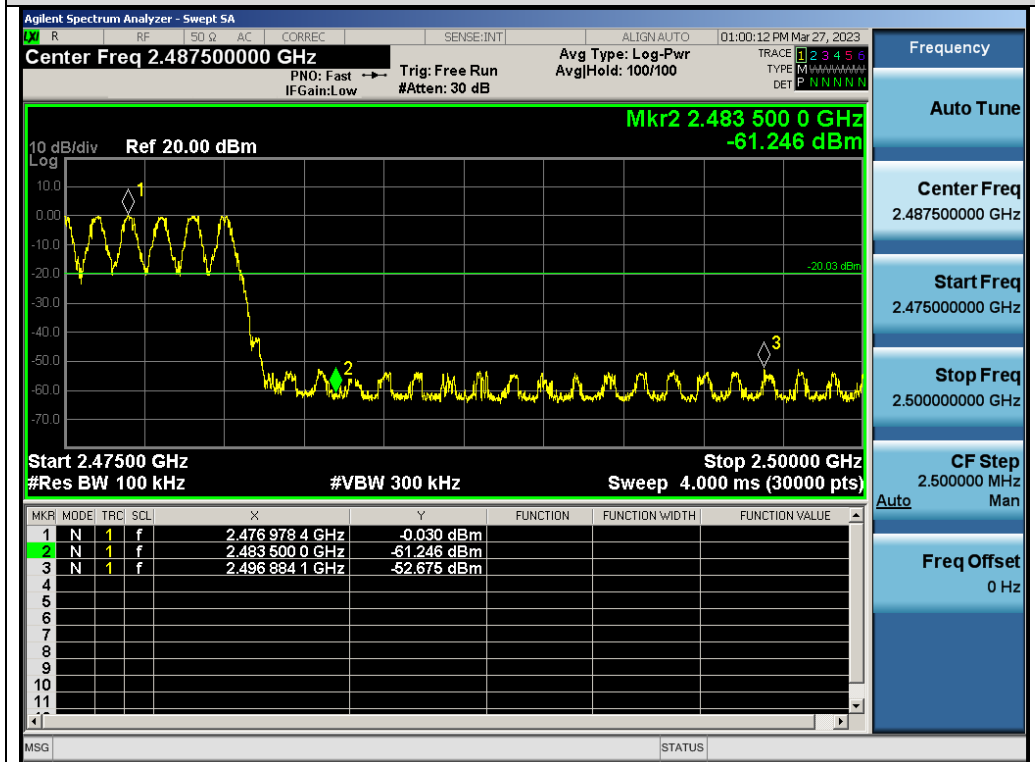

Test_Graph_BR_HOP_ANT1_NA_1Mbps_Higher Band Edge Emissions

Any report having not been signed by authorized approver, or having been altered without authorization, or having not been stamped by the "Dedicated Testing/Inspection Stamp" is deemed to be invalid. Copying or excerpting portion of, or altering the content of the report is not permitted without the written authorization of AGC. The test results presented in the report apply only to the tested sample. Any objections to report issued by AGC should be submitted to AGC within 15days after the issuance of the test report. Further enquiry of validity or verification of the test report should be addressed to AGC by agc01@agccert.com.

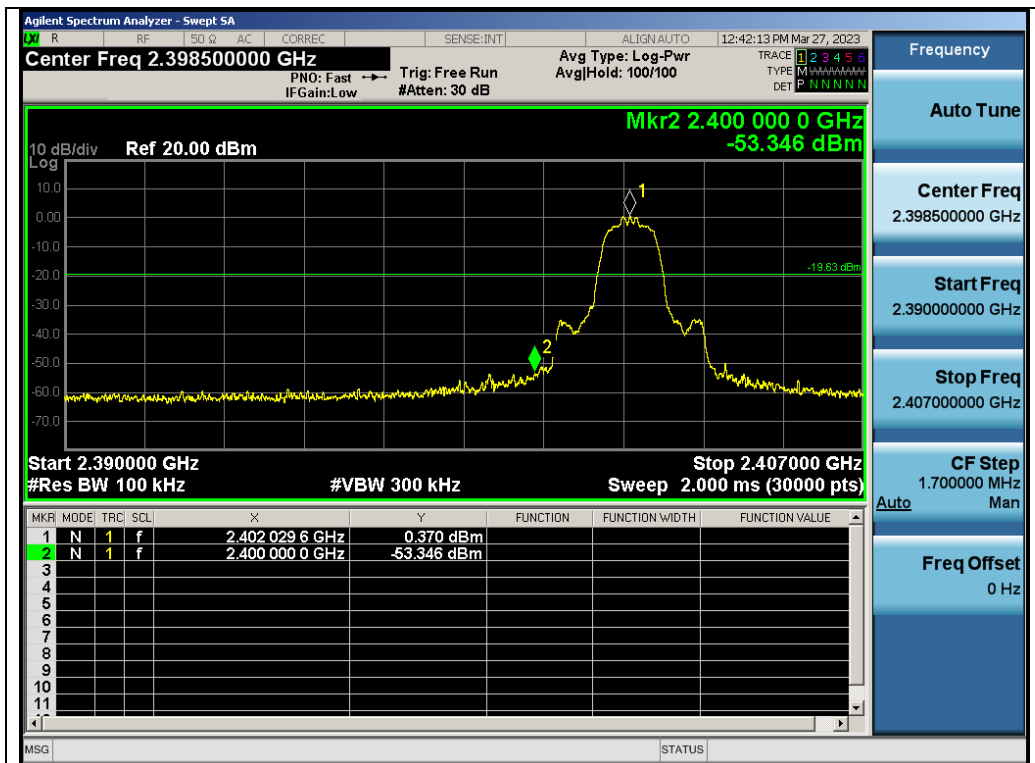

Test_Graph_EDR_ANT1_2402_2Mbps_Lower Band Edge Emissions

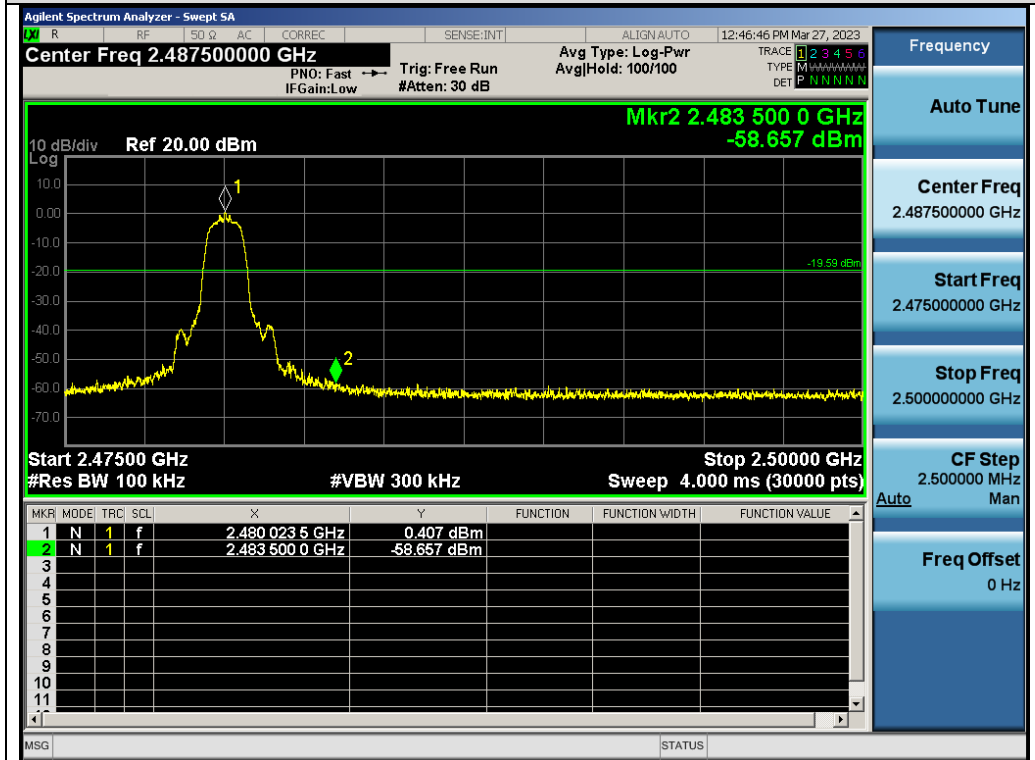

Test_Graph_EDR_ANT1_2480_2Mbps_Higher Band Edge Emissions

Any report having not been signed by authorized approver, or having been altered without authorization, or having not been stamped by the "Dedicated Testing/Inspection Stamp" is deemed to be invalid. Copying or excerpting portion of, or altering the content of the report is not permitted without the written authorization of AGC. The test results presented in the report apply only to the tested sample. Any objections to report issued by AGC should be submitted to AGC within 15days after the issuance of the test report. Further enquiry of validity or verification of the test report should be addressed to AGC by agc01@agccert.com.

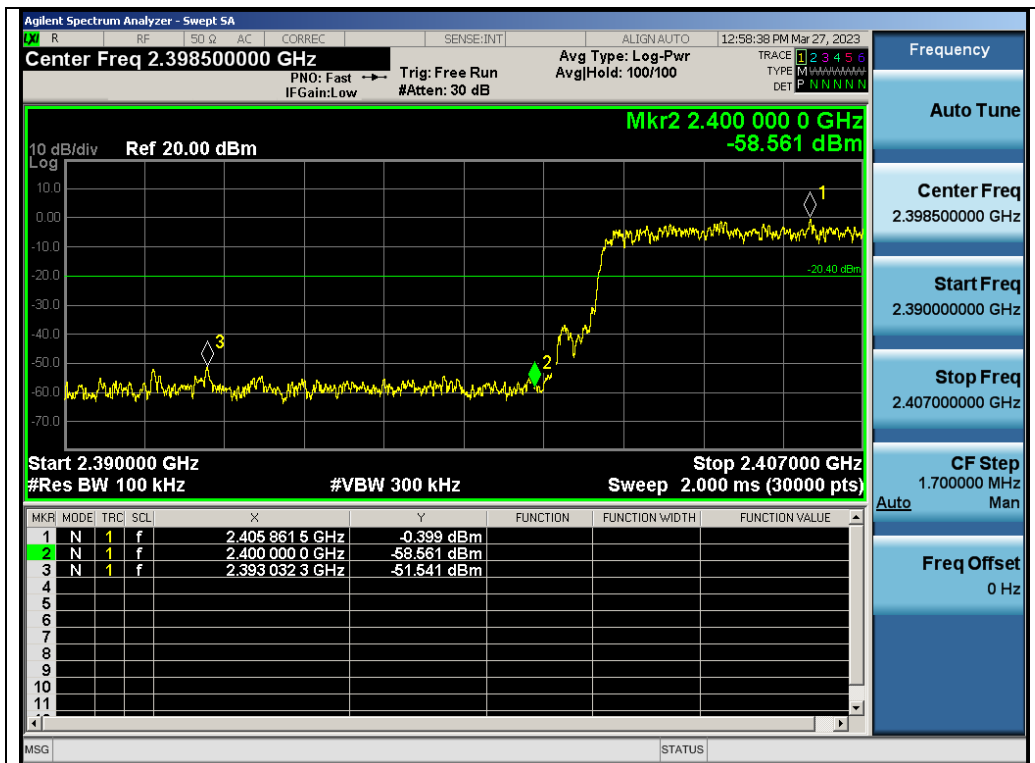

Test_Graph_EDR_HOP_ANT1_NA_2Mbps_Lower Band Edge Emissions

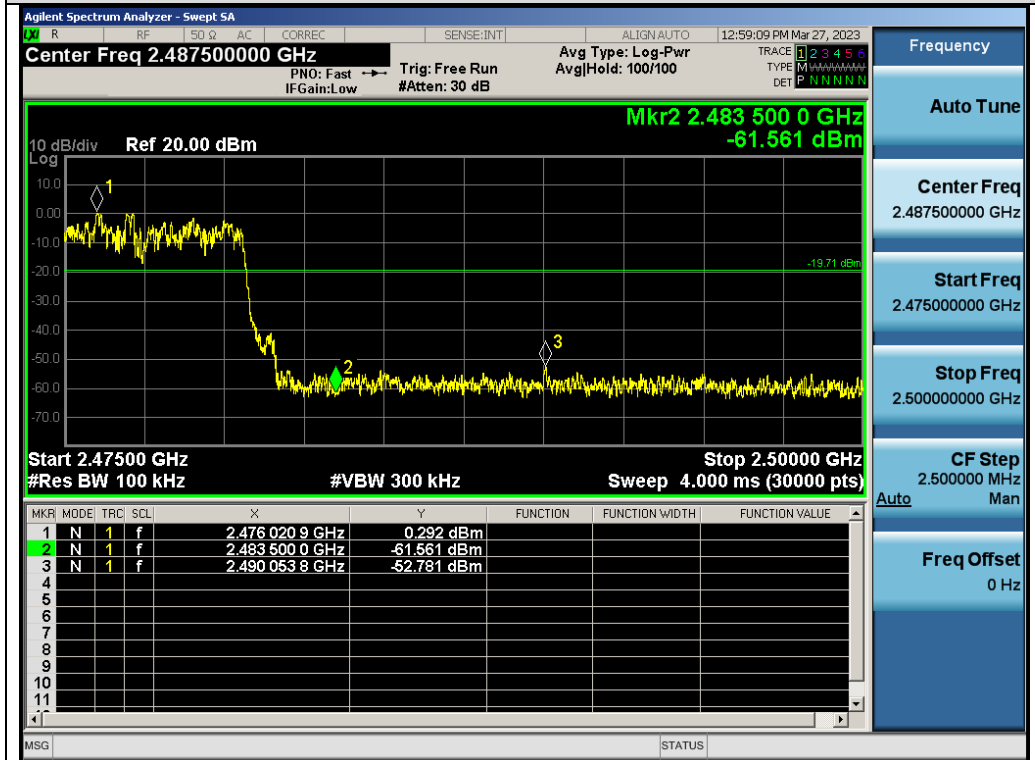

Test_Graph_EDR_HOP_ANT1_NA_2Mbps_Higher Band Edge Emissions

Any report having not been signed by authorized approver, or having been altered without authorization, or having not been stamped by the "Dedicated Testing/Inspection Stamp" is deemed to be invalid. Copying or excerpting portion of, or altering the content of the report is not permitted without the written authorization of AGC. The test results presented in the report apply only to the tested sample. Any objections to report issued by AGC should be submitted to AGC within 15days after the issuance of the test report. Further enquiry of validity or verification of the test report should be addressed to AGC by agc01@agccert.com.

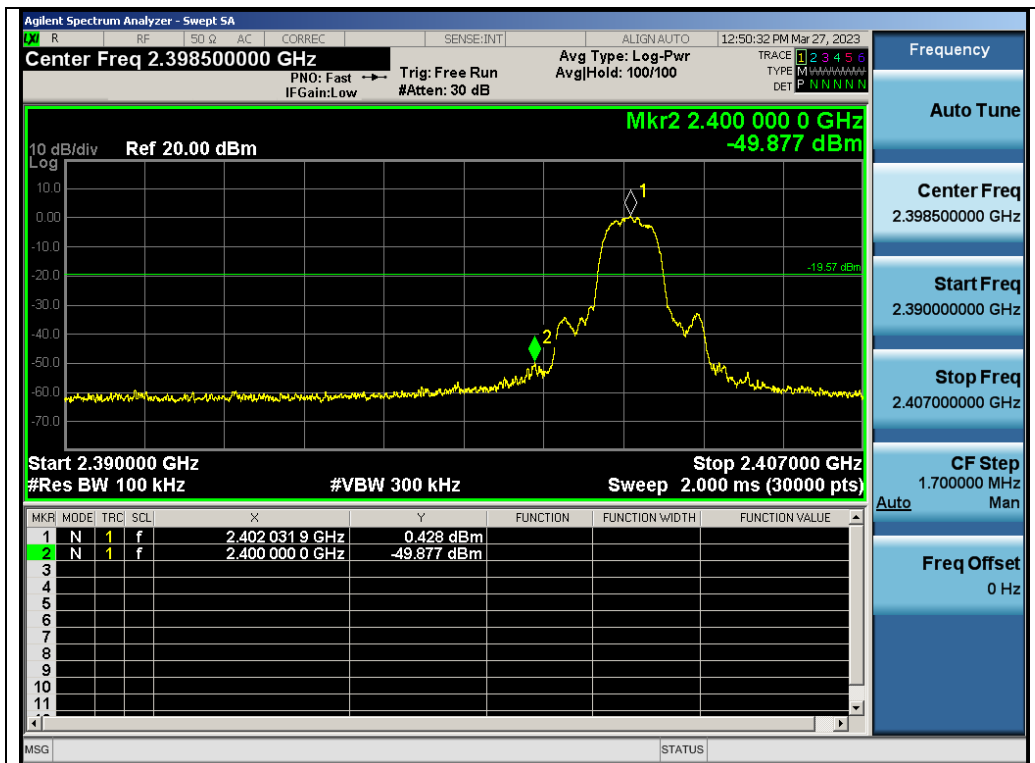

Test_Graph_EDR_ANT1_2402_3Mbps_Lower Band Edge Emissions

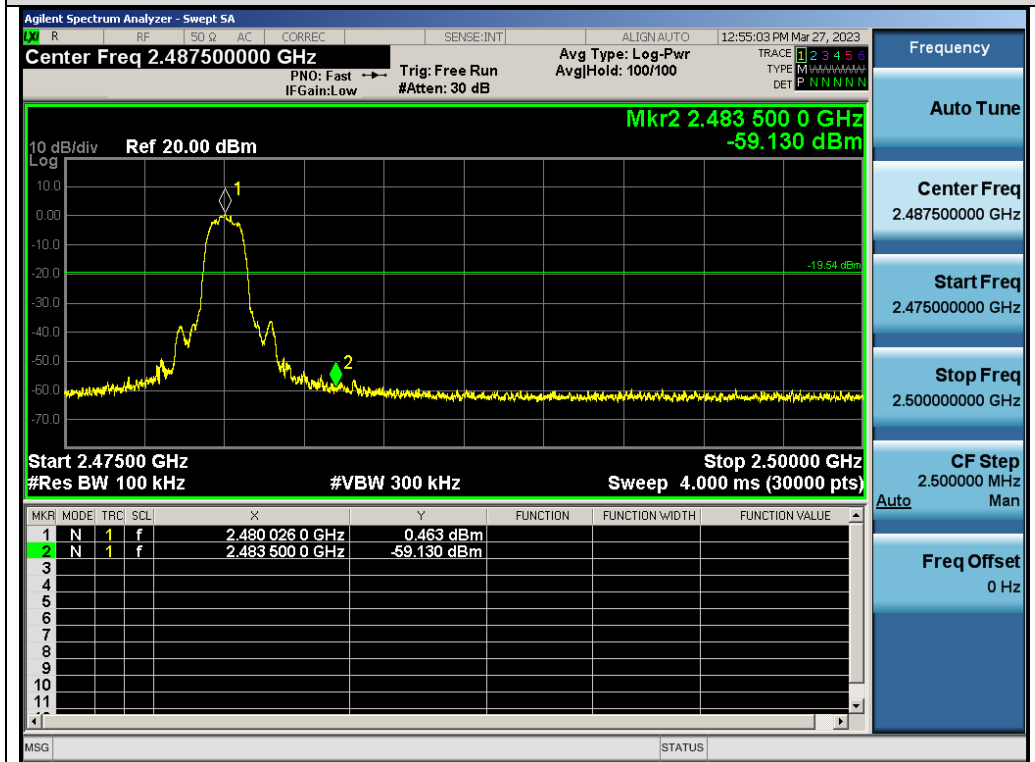

Test_Graph_EDR_ANT1_2480_3Mbps_Higher Band Edge Emissions

Any report having not been signed by authorized approver, or having been altered without authorization, or having not been stamped by the "Dedicated Testing/Inspection Stamp" is deemed to be invalid. Copying or excerpting portion of, or altering the content of the report is not permitted without the written authorization of AGC. The test results presented in the report apply only to the tested sample. Any objections to report issued by AGC should be submitted to AGC within 15days after the issuance of the test report. Further enquiry of validity or verification of the test report should be addressed to AGC by agc01@agccert.com.

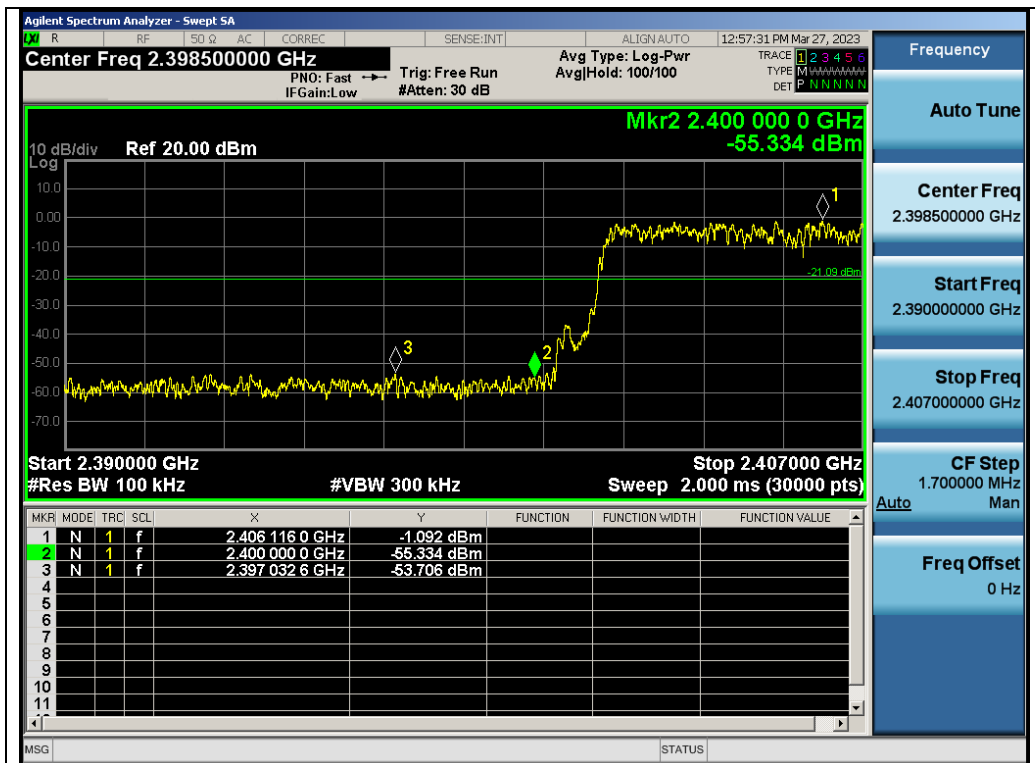

Test_Graph_EDR_HOP_ANT1_NA_3Mbps_Lower Band Edge Emissions

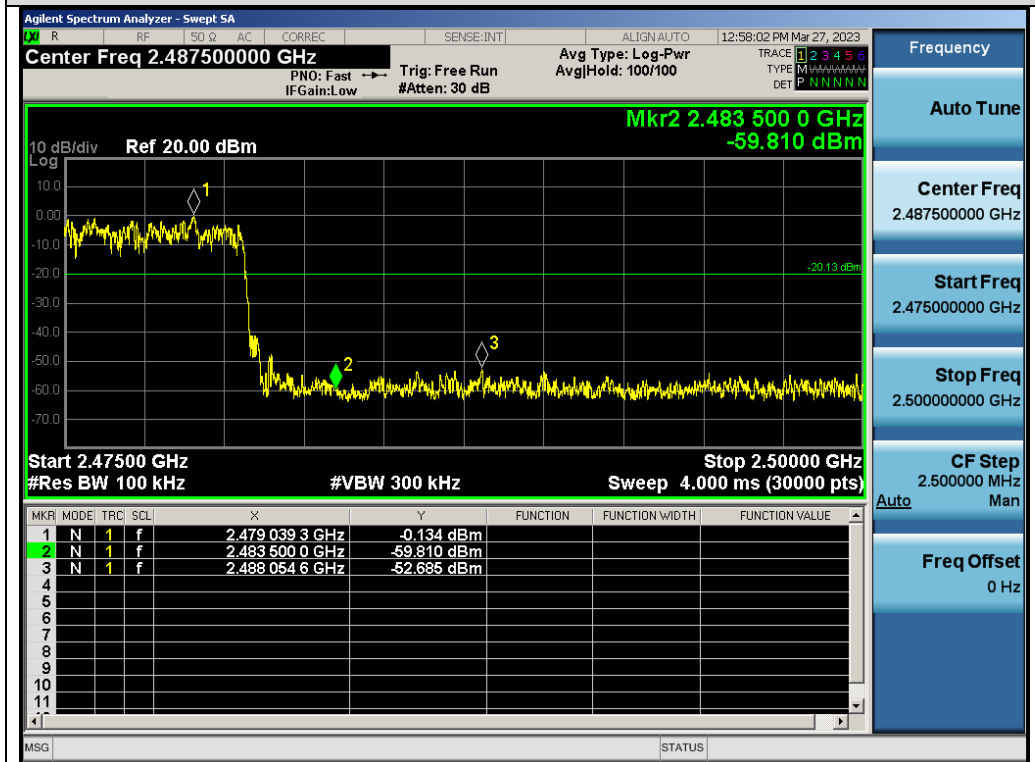

Test_Graph_EDR_HOP_ANT1_NA_3Mbps_Higher Band Edge Emissions

Any report having not been signed by authorized approver, or having been altered without authorization, or having not been stamped by the "Dedicated Testing/Inspection Stamp" is deemed to be invalid. Copying or excerpting portion of, or altering the content of the report is not permitted without the written authorization of AGC. The test results presented in the report apply only to the tested sample. Any objections to report issued by AGC should be submitted to AGC within 15days after the issuance of the test report. Further enquiry of validity or verification of the test report should be addressed to AGC by agc01@agccert.com.

10. RADIATED EMISSION

10.1. MEASUREMENT PROCEDURE

1. The EUT was placed on the top of the turntable 0.8 or 1.5 meter above ground. The phase center of the receiving antenna mounted on the top of a height-variable antenna tower was placed 3 meters far away from the turntable.
2. Power on the EUT and all the supporting units. The turntable was rotated by 360 degrees to determine the position of the highest radiation.
3. The height of the broadband receiving antenna was varied between one meter and four meters above ground to find the maximum emissions field strength of both horizontal and vertical polarization.
4. For each suspected emission, the antenna tower was scan (from 1 M to 4 M) and then the turntable was rotated (from 0 degree to 360 degrees) to find the maximum reading.
5. Set the test-receiver system to Peak or CISPR quasi-peak Detect Function with specified bandwidth under Maximum Hold Mode.
6. For emissions above 1GHz, use 1MHz RBW and 3MHz VBW for peak reading. Place the measurement antenna away from each area of the EUT determined to be a source of emissions at the specified measurement distance, while keeping the measurement antenna aimed at the source of emissions at each frequency of significant emissions, with polarization oriented for maximum response. The measurement antenna may have to be higher or lower than the EUT, depending on the radiation pattern of the emission and staying aimed at the emission source for receiving the maximum signal. The final measurement antenna elevation shall be that which maximizes the emissions. The measurement antenna elevation for maximum emissions shall be restricted to a range of heights of from 1 m to 4 m above the ground or reference ground plane.
7. When the radiated emissions limits are expressed in terms of the average value of the emissions, and pulsed operation is employed, the measurement field strength shall be determined by averaging over one complete pulse train, including blanking intervals, as long as the pulse train does not exceed 0.1 seconds. As an alternative (provided the transmitter operates for longer than 0.1 seconds) or in cases where the pulse train exceeds 0.1 seconds, the measured field strength shall be determined from the average absolute voltage during a 0.1 second interval during which the field strength is at its maximum values.
8. If the emissions level of the EUT in peak mode was 3 dB lower than the average limit specified, then testing will be stopped and peak values of EUT will be reported, otherwise, the emissions which do not have 3 dB margin will be repeated one by one using the quasi-peak method for below 1GHz.
9. For testing above 1GHz, the emissions level of the EUT in peak mode was lower than average limit (that means the emissions level in peak mode also complies with the limit in average mode), then testing will be stopped and peak values of EUT will be reported, otherwise, the emissions will be measured in average mode again and reported.
10. In case the emission is lower than 30MHz, loop antenna has to be used for measurement and the recorded data should be QP measured by receiver. High - Low scan is not required in this case.

Any report having not been signed by authorized approver, or having been altered without authorization, or having not been stamped by the "Dedicated Testing/Inspection Stamp" is deemed to be invalid. Copying or excerpting portion of, or altering the content of the report is not permitted without the written authorization of AGC. The test results presented in the report apply only to the tested sample. Any objections to report issued by AGC should be submitted to AGC within 15days after the issuance of the test report. Further enquiry of validity or verification of the test report should be addressed to AGC by agc01@agccert.com.

The following table is the setting of spectrum analyzer and receiver.

Spectrum Parameter	Setting
Start ~Stop Frequency	9KHz~150KHz/RB 200Hz for QP
Start ~Stop Frequency	150KHz~30MHz/RB 9KHz for QP
Start ~Stop Frequency	30MHz~1000MHz/RB 120KHz for QP
Start ~Stop Frequency	1GHz~26.5GHz 1MHz/3MHz for Peak, 1MHz/3MHz for Average

Receiver Parameter	Setting
Start ~Stop Frequency	9KHz~150KHz/RB 200Hz for QP
Start ~Stop Frequency	150KHz~30MHz/RB 9KHz for QP
Start ~Stop Frequency	30MHz~1000MHz/RB 120KHz for QP

Any report having not been signed by authorized approver, or having been altered without authorization, or having not been stamped by the "Dedicated Testing/Inspection Stamp" is deemed to be invalid. Copying or excerpting portion of, or altering the content of the report is not permitted without the written authorization of AGC. The test results presented in the report apply only to the tested sample. Any objections to report issued by AGC should be submitted to AGC within 15days after the issuance of the test report. Further enquiry of validity or verification of the test report should be addressed to AGC by agc01@agccert.com.

10.2. TEST SETUP

Radiated Emission Test-Setup Frequency Below 30MHz

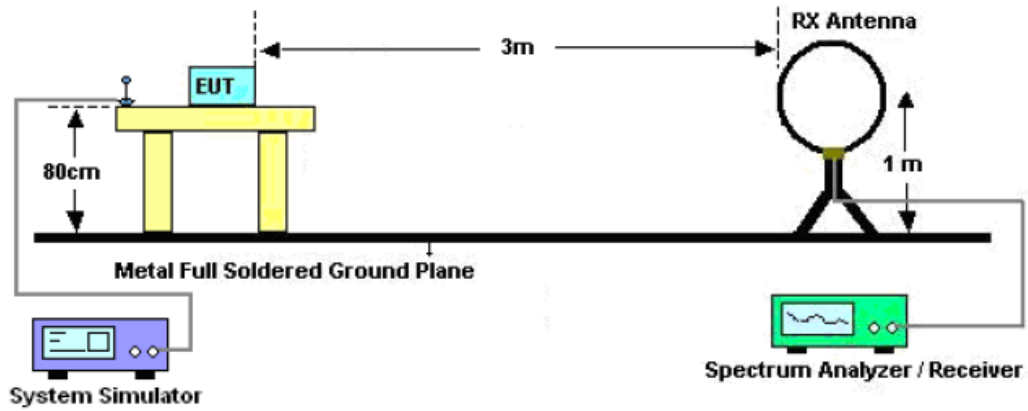

RADIATED EMISSION TEST SETUP 30MHz-1000MHz

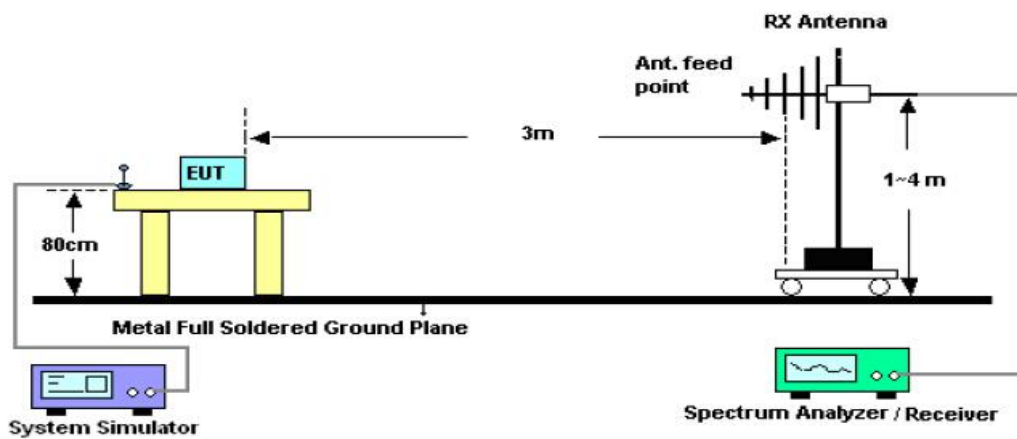

RADIATED EMISSION TEST SETUP ABOVE 1000MHz

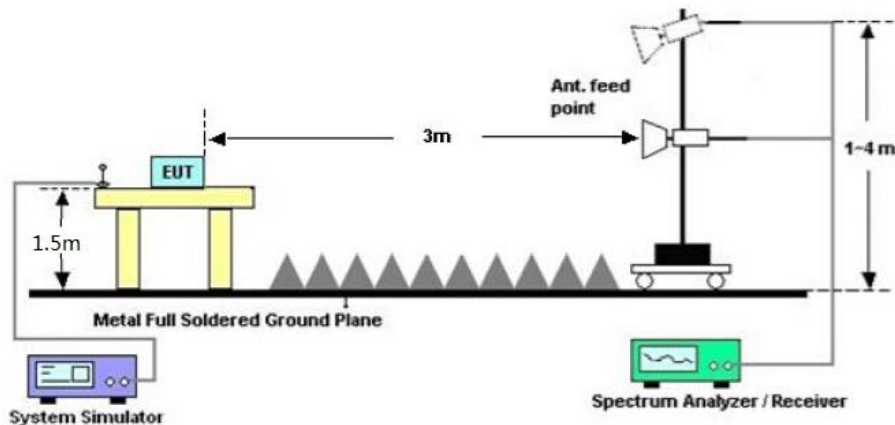

Any report having not been signed by authorized approver, or having been altered without authorization, or having not been stamped by the “Dedicated Testing/Inspection Stamp” is deemed to be invalid. Copying or excerpting portion of, or altering the content of the report is not permitted without the written authorization of AGC. The test results presented in the report apply only to the tested sample. Any objections to report issued by AGC should be submitted to AGC within 15days after the issuance of the test report. Further enquiry of validity or verification of the test report should be addressed to AGC by agc01@agccert.com.

10.3. LIMITS AND MEASUREMENT RESULT

15.209 Limit in the below table has to be followed

Frequencies (MHz)	Field Strength (microvolts/meter)	Measurement Distance (meters)
0.009~0.490	2400/F(kHz)	300
0.490~1.705	24000/F(kHz)	30
1.705~30.0	30	30
30~88	100	3
88~216	150	3
216~960	200	3
Above 960	500	3

Note: All modes were tested for restricted band radiated emission, the test records reported below are the worst result compared to other modes.

10.4. TEST RESULT

Radiated emission below 30MHz

The amplitude of spurious emissions from 9kHz to 30MHz which are attenuated more than 20 dB below the permissible value need not be reported.

Radiated emission from 30MHz to 1000MHz

EUT	Bluetooth speaker	Model Name	SPBT9
Temperature	21.6°C	Relative Humidity	55.8%
Pressure	960hPa	Test Voltage	Normal Voltage
Test Mode	Mode 8	Antenna	Horizontal

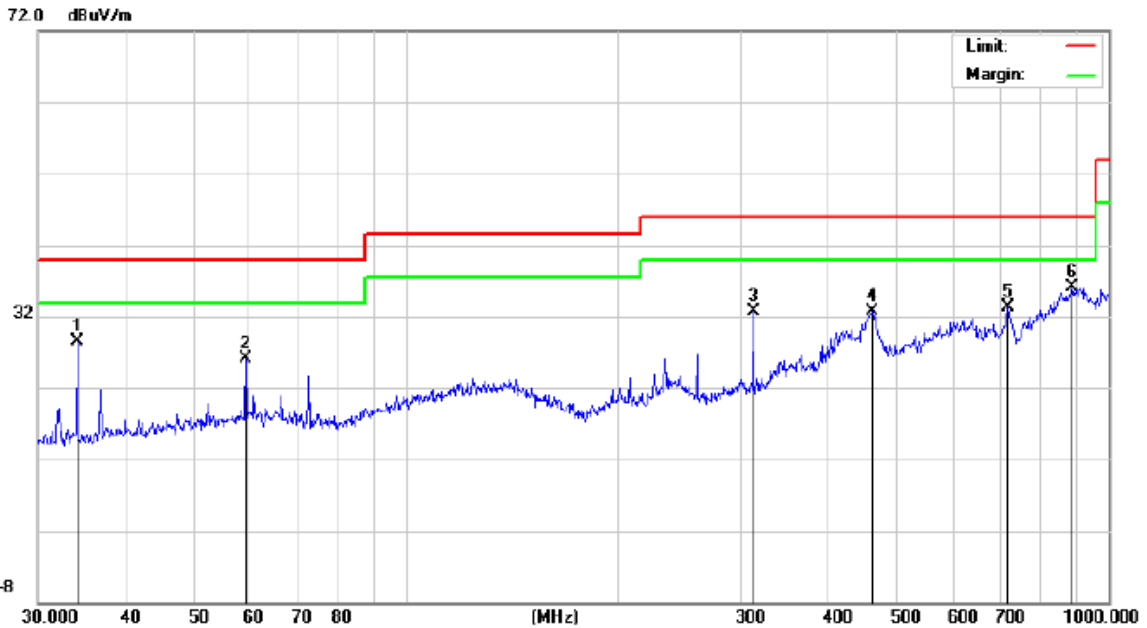

No.	Mk.	Freq. MHz	Reading Level dBuV	Correct Factor dB	Measure- ment dBuV/m	Limit dB/m	Over dB	Detector
1		34.0363	18.35	10.12	28.47	40.00	-11.53	peak
2		59.2325	13.02	13.11	26.13	40.00	-13.87	peak
3		312.1792	15.30	17.50	32.80	46.00	-13.20	peak
4		460.7271	5.50	27.23	32.73	46.00	-13.27	peak
5		719.1994	6.52	26.69	33.21	46.00	-12.79	peak
6	*	887.6099	5.84	30.25	36.09	46.00	-9.91	peak

RESULT: PASS

Any report having not been signed by authorized approver, or having been altered without authorization, or having not been stamped by the "Dedicated Testing/Inspection Stamp" is deemed to be invalid. Copying or excerpting portion of, or altering the content of the report is not permitted without the written authorization of AGC. The test results presented in the report apply only to the tested sample. Any objections to report issued by AGC should be submitted to AGC within 15days after the issuance of the test report. Further enquiry of validity or verification of the test report should be addressed to AGC by agc01@agccert.com.

EUT	Bluetooth speaker	Model Name	SPBT9
Temperature	21.6°C	Relative Humidity	55.8%
Pressure	960hPa	Test Voltage	Normal Voltage
Test Mode	Mode 8	Antenna	Vertical

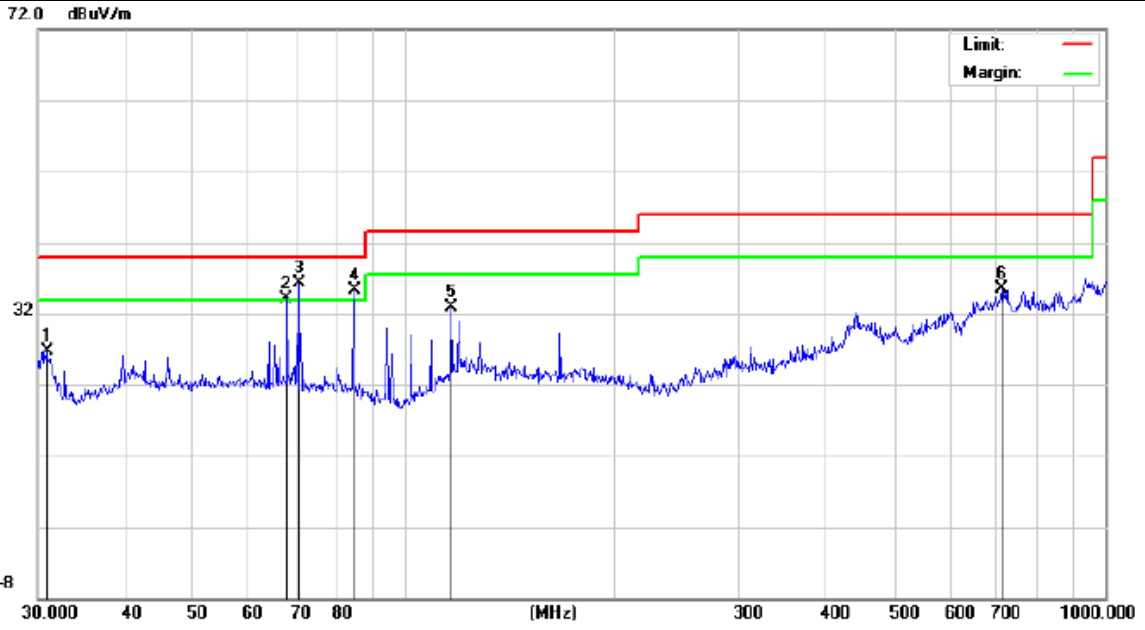

No.	Mk.	Freq. MHz	Reading Level dBuV	Correct Factor dB	Measure- ment dBuV/m	Limit dB/m	Over dB	Detector
1		30.8535	12.82	13.88	26.70	40.00	-13.30	peak
2	!	67.9128	17.11	17.02	34.13	40.00	-5.87	peak
3	*	70.5836	19.31	16.99	36.30	40.00	-3.70	peak
4	!	84.7018	19.09	16.27	35.36	40.00	-4.64	peak
5		116.5400	14.14	18.75	32.89	43.50	-10.61	peak
6		711.6734	6.96	28.51	35.47	46.00	-10.53	peak

RESULT: PASS

Note: 1. Factor=Antenna Factor + Cable loss, Over=Measurement-Limit.

2. All test modes had been pre-tested. The mode 8 is the worst case and recorded in the report.

Any report having not been signed by authorized approver, or having been altered without authorization, or having not been stamped by the "Dedicated Testing/Inspection Stamp" is deemed to be invalid. Copying or excerpting portion of, or altering the content of the report is not permitted without the written authorization of AGC. The test results presented in the report apply only to the tested sample. Any objections to report issued by AGC should be submitted to AGC within 15days after the issuance of the test report. Further enquiry of validity or verification of the test report should be addressed to AGC by agc01@agccert.com.

Radiated emission above 1GHz

EUT	Bluetooth speaker	Model Name	SPBT9
Temperature	21.6°C	Relative Humidity	55.8%
Pressure	960hPa	Test Voltage	Normal Voltage
Test Mode	Mode 7	Antenna	Horizontal

Frequency (MHz)	Meter Reading (dBµV)	Factor (dB)	Emission Level (dBµV/m)	Limits (dBµV/m)	Margin (dB)	Value Type
4804.000	44.21	0.08	44.29	74	-29.71	peak
4804.000	37.12	0.08	37.2	54	-16.8	AVG
7206.000	40.58	2.21	42.79	74	-31.21	peak
7206.000	32.86	2.21	35.07	54	-18.93	AVG

Remark:

Factor = Antenna Factor + Cable Loss – Pre-amplifier.

EUT	Bluetooth speaker	Model Name	SPBT9
Temperature	21.6°C	Relative Humidity	55.8%
Pressure	960hPa	Test Voltage	Normal Voltage
Test Mode	Mode 7	Antenna	Vertical

Frequency (MHz)	Meter Reading (dBµV)	Factor (dB)	Emission Level (dBµV/m)	Limits (dBµV/m)	Margin (dB)	Value Type
4804.000	43.98	0.08	44.06	74	-29.94	peak
4804.000	36.46	0.08	36.54	54	-17.46	AVG
7206.000	40.04	2.21	42.25	74	-31.75	peak
7206.000	31.52	2.21	33.73	54	-20.27	AVG

Remark:

Factor = Antenna Factor + Cable Loss – Pre-amplifier.

Any report having not been signed by authorized approver, or having been altered without authorization, or having not been stamped by the “Dedicated Testing/Inspection Stamp” is deemed to be invalid. Copying or excerpting portion of, or altering the content of the report is not permitted without the written authorization of AGC. The test results presented in the report apply only to the tested sample. Any objections to report issued by AGC should be submitted to AGC within 15days after the issuance of the test report. Further enquiry of validity or verification of the test report should be addressed to AGC by agc01@agccert.com.

EUT	Bluetooth speaker	Model Name	SPBT9
Temperature	21.6°C	Relative Humidity	55.8%
Pressure	960hPa	Test Voltage	Normal Voltage
Test Mode	Mode 8	Antenna	Horizontal

Frequency (MHz)	Meter Reading (dBµV)	Factor (dB)	Emission Level (dBµV/m)	Limits (dBµV/m)	Margin (dB)	Value Type
4882.000	45.79	0.14	45.93	74	-28.07	peak
4882.000	38.15	0.14	38.29	54	-15.71	AVG
7323.000	41.61	2.36	43.97	74	-30.03	peak
7323.000	34.24	2.36	36.6	54	-17.4	AVG

Remark:

Factor = Antenna Factor + Cable Loss – Pre-amplifier.

EUT	Bluetooth speaker	Model Name	SPBT9
Temperature	21.6°C	Relative Humidity	55.8%
Pressure	960hPa	Test Voltage	Normal Voltage
Test Mode	Mode 8	Antenna	Vertical

Frequency (MHz)	Meter Reading (dBµV)	Factor (dB)	Emission Level (dBµV/m)	Limits (dBµV/m)	Margin (dB)	Value Type
4882.000	45.25	0.14	45.39	74	-28.61	peak
4882.000	37.64	0.14	37.78	54	-16.22	AVG
7323.000	40.96	2.36	43.32	74	-30.68	peak
7323.000	33.78	2.36	36.14	54	-17.86	AVG

Remark:

Factor = Antenna Factor + Cable Loss – Pre-amplifier.

Any report having not been signed by authorized approver, or having been altered without authorization, or having not been stamped by the “Dedicated Testing/Inspection Stamp” is deemed to be invalid. Copying or excerpting portion of, or altering the content of the report is not permitted without the written authorization of AGC. The test results presented in the report apply only to the tested sample. Any objections to report issued by AGC should be submitted to AGC within 15days after the issuance of the test report. Further enquiry of validity or verification of the test report should be addressed to AGC by agc01@agccert.com.

EUT	Bluetooth speaker	Model Name	SPBT9
Temperature	21.6°C	Relative Humidity	55.8%
Pressure	960hPa	Test Voltage	Normal Voltage
Test Mode	Mode 9	Antenna	Horizontal

Frequency (MHz)	Meter Reading (dBμV)	Factor (dB)	Emission Level (dBμV/m)	Limits (dBμV/m)	Margin (dB)	Value Type
4960.000	46.57	0.22	46.79	74	-27.21	peak
4960.000	38.41	0.22	38.63	54	-15.37	AVG
7440.000	41.24	2.64	43.88	74	-30.12	peak
7440.000	32.89	2.64	35.53	54	-18.47	AVG

Remark:

Factor = Antenna Factor + Cable Loss – Pre-amplifier.

EUT	Bluetooth speaker	Model Name	SPBT9
Temperature	21.6°C	Relative Humidity	55.8%
Pressure	960hPa	Test Voltage	Normal Voltage
Test Mode	Mode 9	Antenna	Vertical

Frequency (MHz)	Meter Reading (dBμV)	Factor (dB)	Emission Level (dBμV/m)	Limits (dBμV/m)	Margin (dB)	Value Type
4960.000	46.15	0.22	46.37	74	-27.63	peak
4960.000	38.56	0.22	38.78	54	-15.22	AVG
7440.000	40.78	2.64	43.42	74	-30.58	peak
7440.000	31.93	2.64	34.57	54	-19.43	AVG

Remark:

Factor = Antenna Factor + Cable Loss – Pre-amplifier.

RESULT: PASS

Note:

The amplitude of other spurious emissions from 1G to 25 GHz which are attenuated more than 20 dB below the permissible value need not be reported.

Factor = Antenna Factor + Cable loss - Amplifier gain, Margin=Level-Limit.

The “Factor” value can be calculated automatically by software of measurement system.

All test modes had been tested. The 8DPSK modulation is the worst case and recorded in the report.

Any report having not been signed by authorized approver, or having been altered without authorization, or having not been stamped by the “Dedicated Testing/Inspection Stamp” is deemed to be invalid. Copying or excerpting portion of, or altering the content of the report is not permitted without the written authorization of AGC. The test results presented in the report apply only to the tested sample. Any objections to report issued by AGC should be submitted to AGC within 15days after the issuance of the test report. Further enquiry of validity or verification of the test report should be addressed to AGC by agc01@agccert.com.

Attestation of Global Compliance(Shenzhen)Co., Ltd

Attestation of Global Compliance(Shenzhen)Std & Tech Co., Ltd

Tel: +86-755 2523 4088 E-mail: agc@agccert.com Web: http://www.agccert.com/

Test result for band edge emission at restricted bands

EUT	Bluetooth speaker	Model Name	SPBT9
Temperature	21.6°C	Relative Humidity	55.8%
Pressure	960hPa	Test Voltage	Normal Voltage
Test Mode	Mode 7	Antenna	Horizontal

Test Graph for Peak Measurement

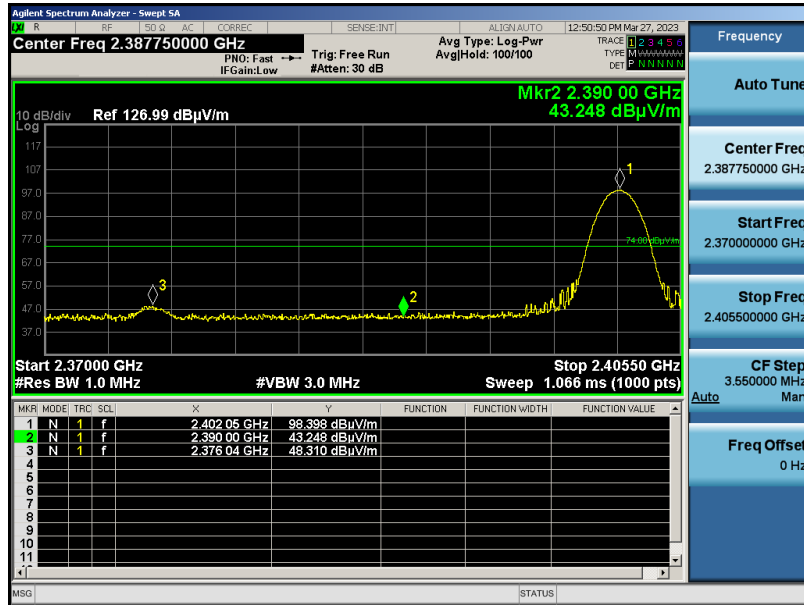

Test Graph for Average Measurement

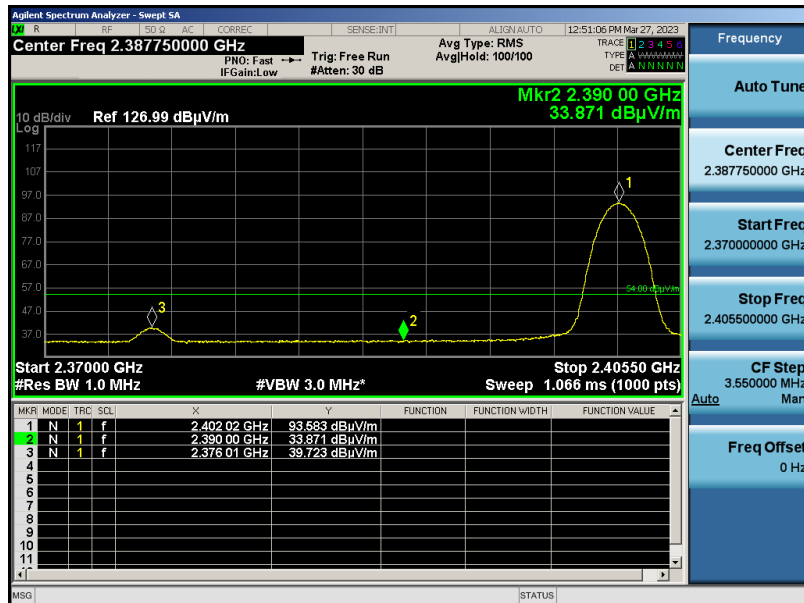

RESULT: PASS

Any report having not been signed by authorized approver, or having been altered without authorization, or having not been stamped by the "Dedicated Testing/Inspection Stamp" is deemed to be invalid. Copying or excerpting portion of, or altering the content of the report is not permitted without the written authorization of AGC. The test results presented in the report apply only to the tested sample. Any objections to report issued by AGC should be submitted to AGC within 15days after the issuance of the test report. Further enquiry of validity or verification of the test report should be addressed to AGC by agc01@agccert.com.

EUT	Bluetooth speaker	Model Name	SPBT9
Temperature	21.6°C	Relative Humidity	55.8%
Pressure	960hPa	Test Voltage	Normal Voltage
Test Mode	Mode 7	Antenna	Vertical

Test Graph for Peak Measurement

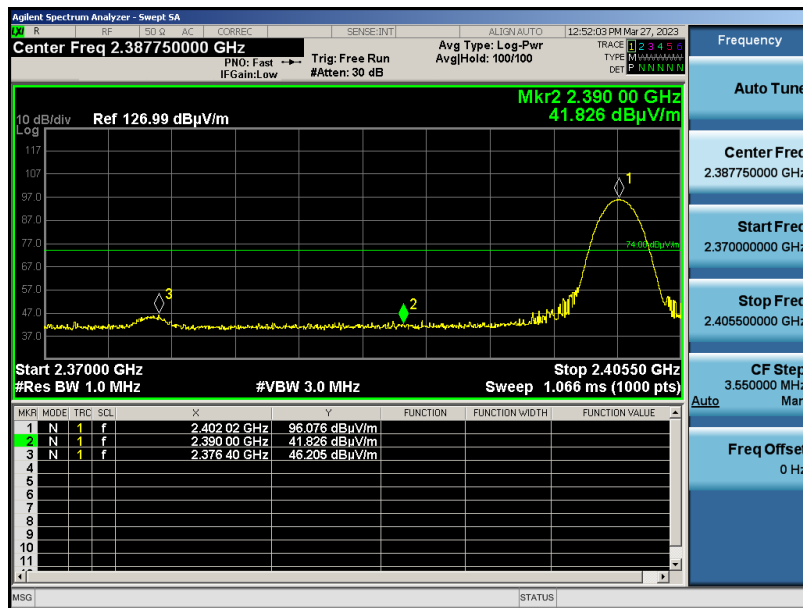

Test Graph for Average Measurement

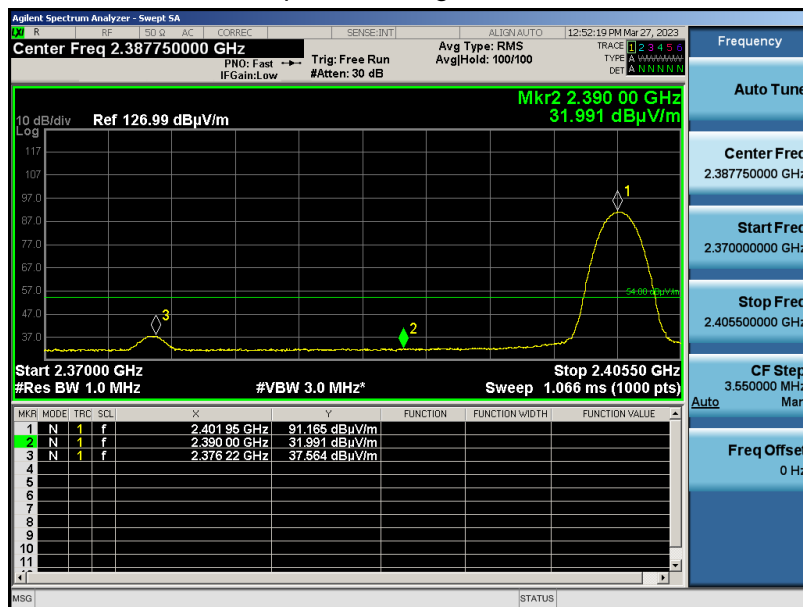

RESULT: PASS

Any report having not been signed by authorized approver, or having been altered without authorization, or having not been stamped by the "Dedicated Testing/Inspection Stamp" is deemed to be invalid. Copying or excerpting portion of, or altering the content of the report is not permitted without the written authorization of AGC. The test results presented in the report apply only to the tested sample. Any objections to report issued by AGC should be submitted to AGC within 15days after the issuance of the test report. Further enquiry of validity or verification of the test report should be addressed to AGC by agc01@agccert.com.

EUT	Bluetooth speaker	Model Name	SPBT9
Temperature	21.6°C	Relative Humidity	55.8%
Pressure	960hPa	Test Voltage	Normal Voltage
Test Mode	Mode 9	Antenna	Horizontal

Test Graph for Peak Measurement

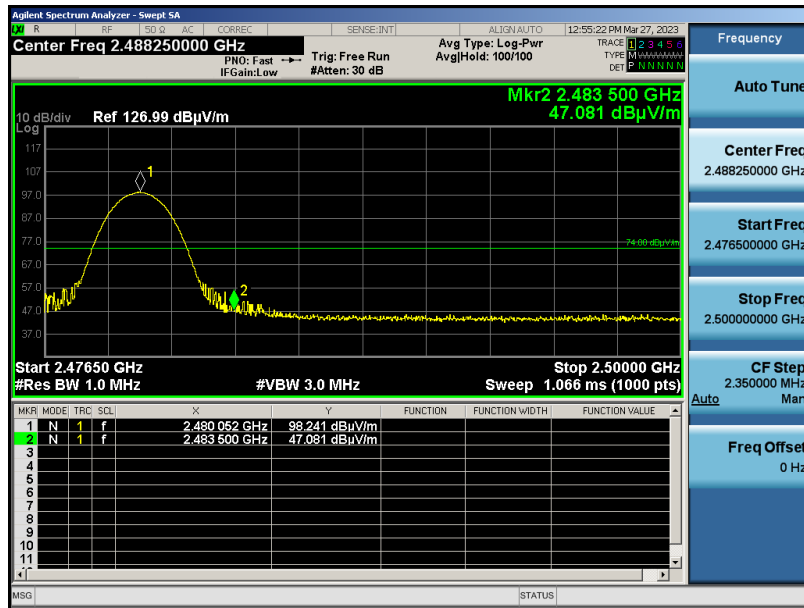

Test Graph for Average Measurement

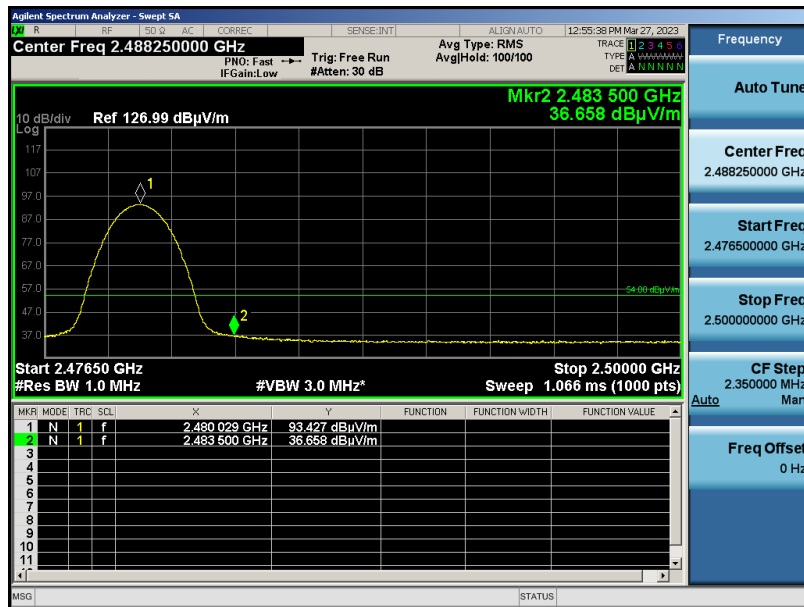

RESULT: PASS

Any report having not been signed by authorized approver, or having been altered without authorization, or having not been stamped by the "Dedicated Testing/Inspection Stamp" is deemed to be invalid. Copying or excerpting portion of, or altering the content of the report is not permitted without the written authorization of AGC. The test results presented in the report apply only to the tested sample. Any objections to report issued by AGC should be submitted to AGC within 15days after the issuance of the test report. Further enquiry of validity or verification of the test report should be addressed to AGC by agc01@agccert.com.

EUT	Bluetooth speaker	Model Name	SPBT9
Temperature	21.6°C	Relative Humidity	55.8%
Pressure	960hPa	Test Voltage	Normal Voltage
Test Mode	Mode 9	Antenna	Vertical

Test Graph for Peak Measurement

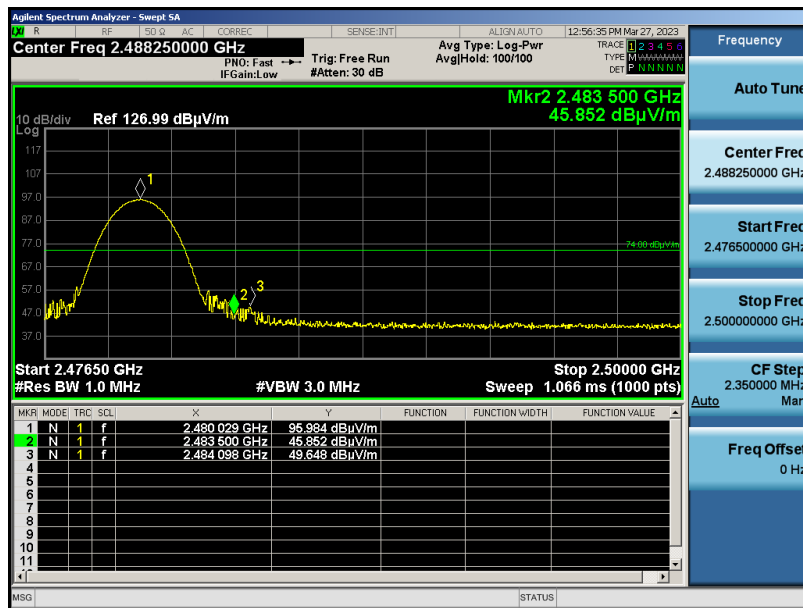

Test Graph for Average Measurement

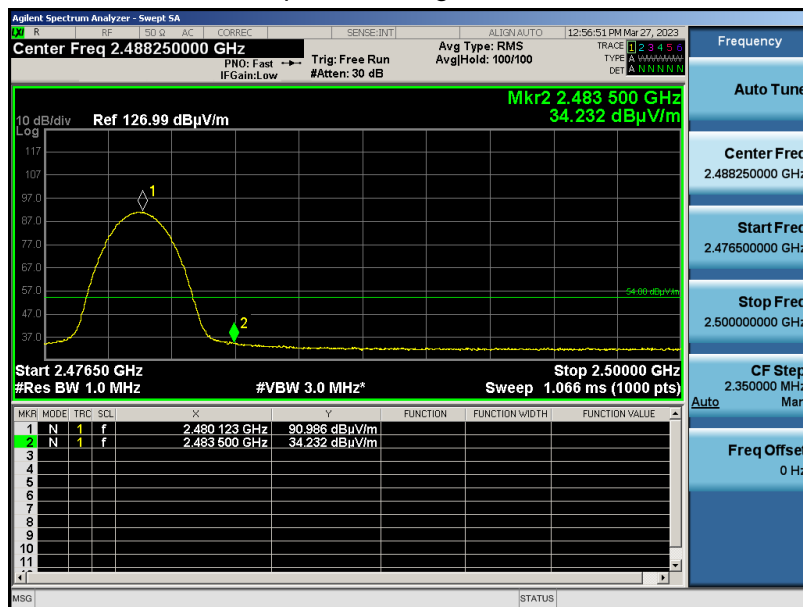

RESULT: PASS

Note: The factor had been edited in the “Input Correction” of the Spectrum Analyzer. The 8DPSK modulation is the worst case and recorded in the report.

Any report having not been signed by authorized approver, or having been altered without authorization, or having not been stamped by the “Dedicated Testing/Inspection Stamp” is deemed to be invalid. Copying or excerpting portion of, or altering the content of the report is not permitted without the written authorization of AGC. The test results presented in the report apply only to the tested sample. Any objections to report issued by AGC should be submitted to AGC within 15days after the issuance of the test report. Further enquiry of validity or verification of the test report should be addressed to AGC by agc01@agccert.com.

11. NUMBER OF HOPPING FREQUENCY

11.1. MEASUREMENT PROCEDURE

The EUT shall have its hopping function enabled. Use the following spectrum analyzer settings:

1. Span: The frequency band of operation. Depending on the number of channels the device supports, it may be necessary to divide the frequency range of operation across multiple spans, to allow the individual channels to be clearly seen.
2. RBW: To identify clearly the individual channels, set the RBW to less than 30% of the channel spacing or the 20 dB bandwidth, whichever is smaller.
3. VBW \geq RBW. Sweep: Auto. Detector function: Peak. Trace: Max hold.
4. Allow the trace to stabilize.

11.2. TEST SETUP (BLOCK DIAGRAM OF CONFIGURATION)

Same as described in section 8.2

11.3. MEASUREMENT EQUIPMENT USED

The same as described in section 6

11.4. LIMITS AND MEASUREMENT RESULT

Test Data of Number of Hopping Frequency			
Test Mode	Number of Hopping Frequency	Limits	Pass or Fail
GFSK Hopping	79	≥ 15	Pass

Test Graphs of Number of Hopping Frequency

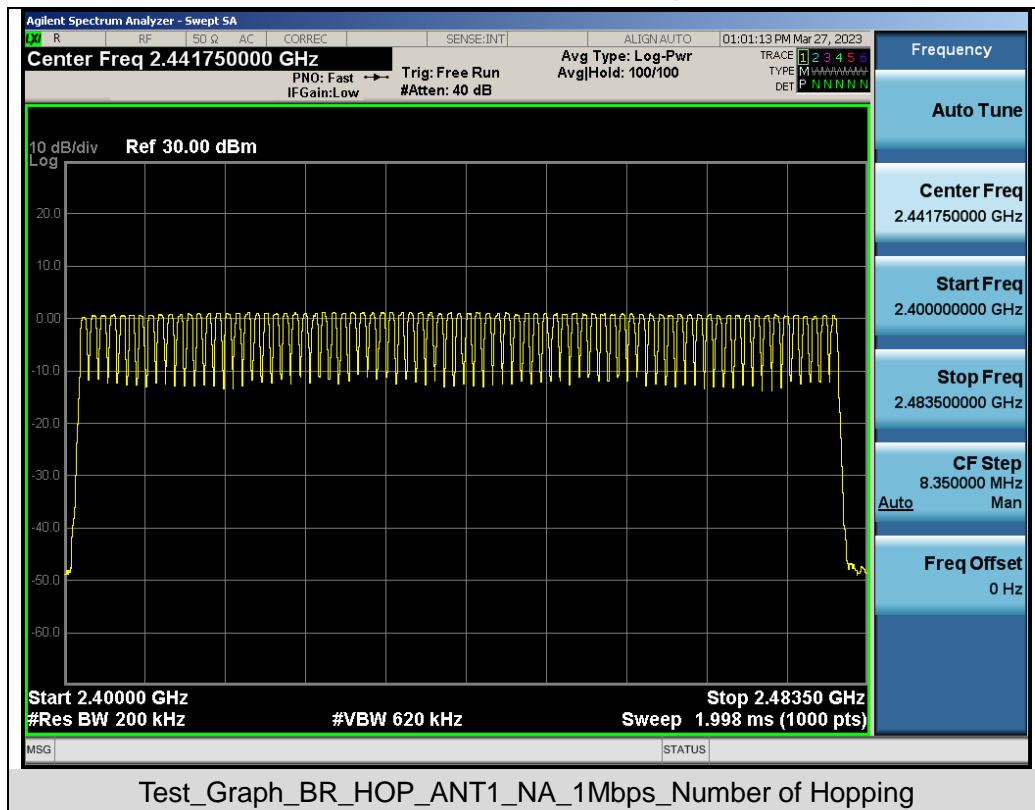

Note: The GFSK modulation is the worst case and recorded in the report.

Any report having not been signed by authorized approver, or having been altered without authorization, or having not been stamped by the "Dedicated Testing/Inspection Stamp" is deemed to be invalid. Copying or excerpting portion of, or altering the content of the report is not permitted without the written authorization of AGC. The test results presented in the report apply only to the tested sample. Any objections to report issued by AGC should be submitted to AGC within 15 days after the issuance of the test report. Further enquiry of validity or verification of the test report should be addressed to AGC by agc01@agccert.com.

12. TIME OF OCCUPANCY (DWELL TIME)

12.1. MEASUREMENT PROCEDURE

The EUT shall have its hopping function enabled. Use the following spectrum analyzer settings:

1. Span: Zero span, centered on a hopping channel.
2. RBW shall be \leq channel spacing and where possible RBW should be set $\gg 1 / T$, where T is the expected dwell time per channel.
3. Sweep: As necessary to capture the entire dwell time per hopping channel; where possible use a video trigger and trigger delay so that the transmitted signal starts a little to the right of the start of the plot. The trigger level might need slight adjustment to prevent triggering when the system hops on an adjacent channel; a second plot might be needed with a longer sweep time to show two successive hops on a channel.
4. Detector function: Peak. Trace: Max hold.
5. Use the marker-delta function to determine the transmit time per hop.
6. Repeat the measurement using a longer sweep time to determine the number of hops over the period specified in the requirements. The sweep time shall be equal to, or less than, the period specified in the requirements. Determine the number of hops over the sweep time and calculate the total number of hops in the period specified in the requirements, using the following equation:
(Number of hops in the period specified in the requirements) = (number of hops on spectrum analyzer) \times (period specified in the requirements / analyzer sweep time)
7. The average time of occupancy is calculated from the transmit time per hop multiplied by the number of hops in the period specified in the requirements.

12.2. TEST SETUP (BLOCK DIAGRAM OF CONFIGURATION)

Same as described in section 8.2

12.3. MEASUREMENT EQUIPMENT USED

The same as described in section 6

12.4. LIMITS AND MEASUREMENT RESULT

Test Data of Dwell Time					
Channel	Time of Pulse for DH5 (ms)	Number of hops in the period specified in the requirements	Sweep Time (ms)	Limit (ms)	Pass or Fail
2402	2.910	33.0*4	384.120	400	Pass
2441	2.910	29.0*4	337.560	400	Pass
2480	2.910	23.0*4	267.720	400	Pass

Note: The 8DPSK modulation is the worst case and recorded in the report.

Test Graphs of Dwell Time

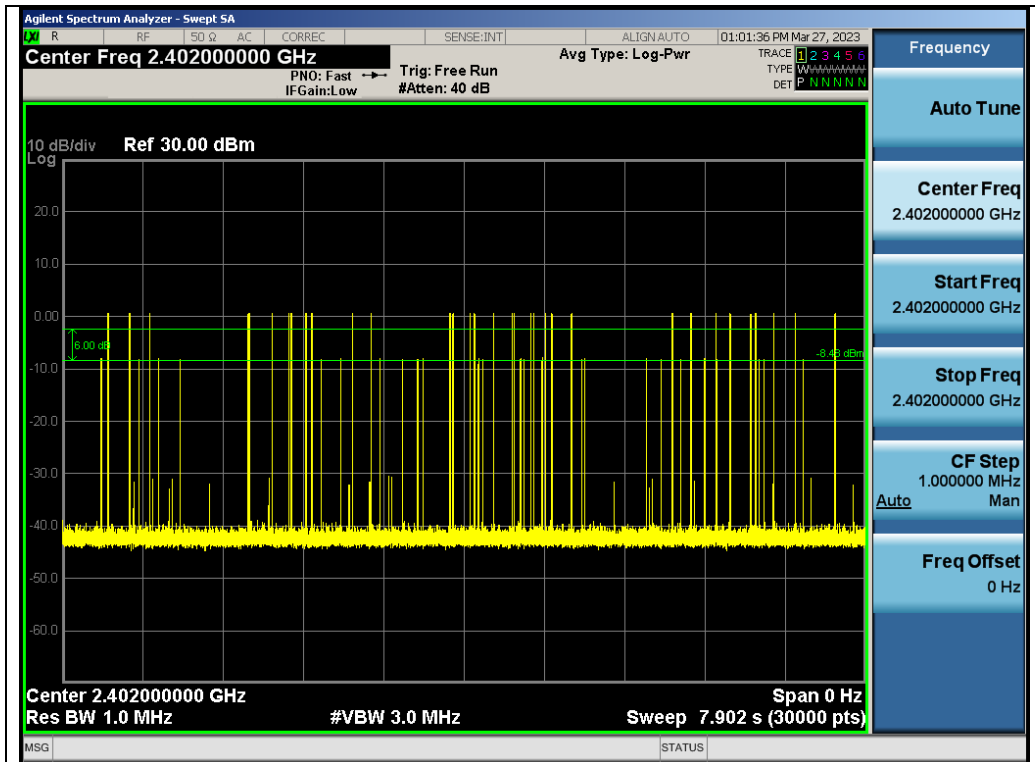

Test_Graph_BR_HOP_ANT1_NA_1Mbps_2402_Number of Burst

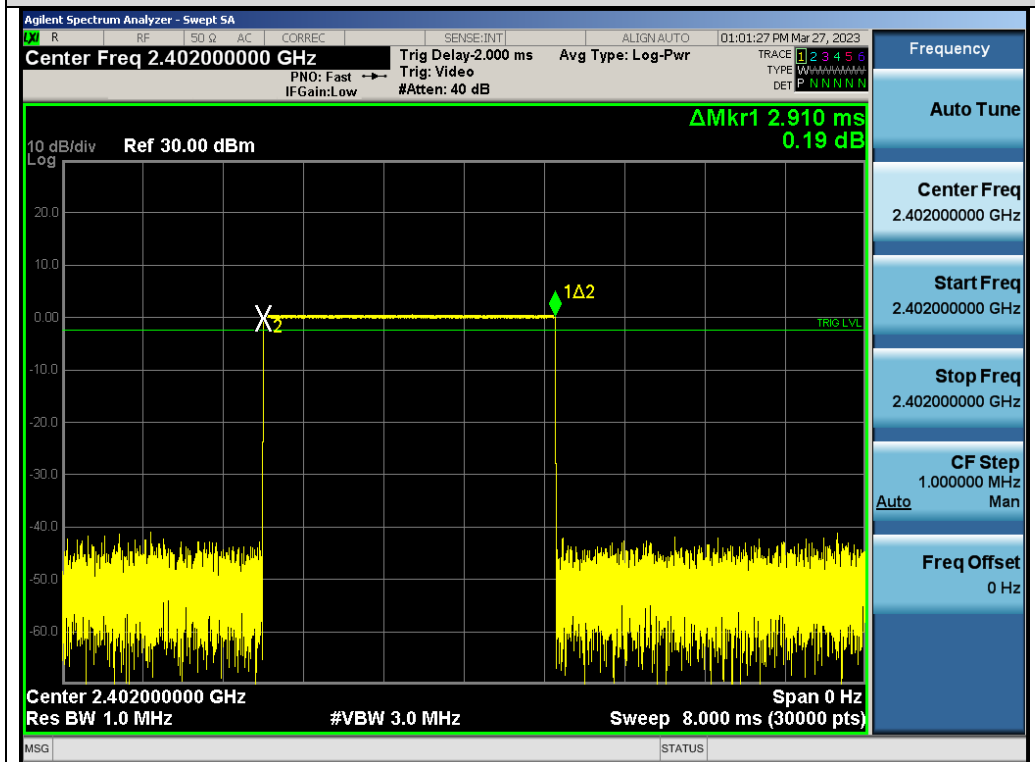

Test_Graph_BR_HOP_ANT1_NA_1Mbps_2402_Time per Burst

Any report having not been signed by authorized approver, or having been altered without authorization, or having not been stamped by the "Dedicated Testing/Inspection Stamp" is deemed to be invalid. Copying or excerpting portion of, or altering the content of the report is not permitted without the written authorization of AGC. The test results presented in the report apply only to the tested sample. Any objections to report issued by AGC should be submitted to AGC within 15days after the issuance of the test report. Further enquiry of validity or verification of the test report should be addressed to AGC by agc01@agccert.com.

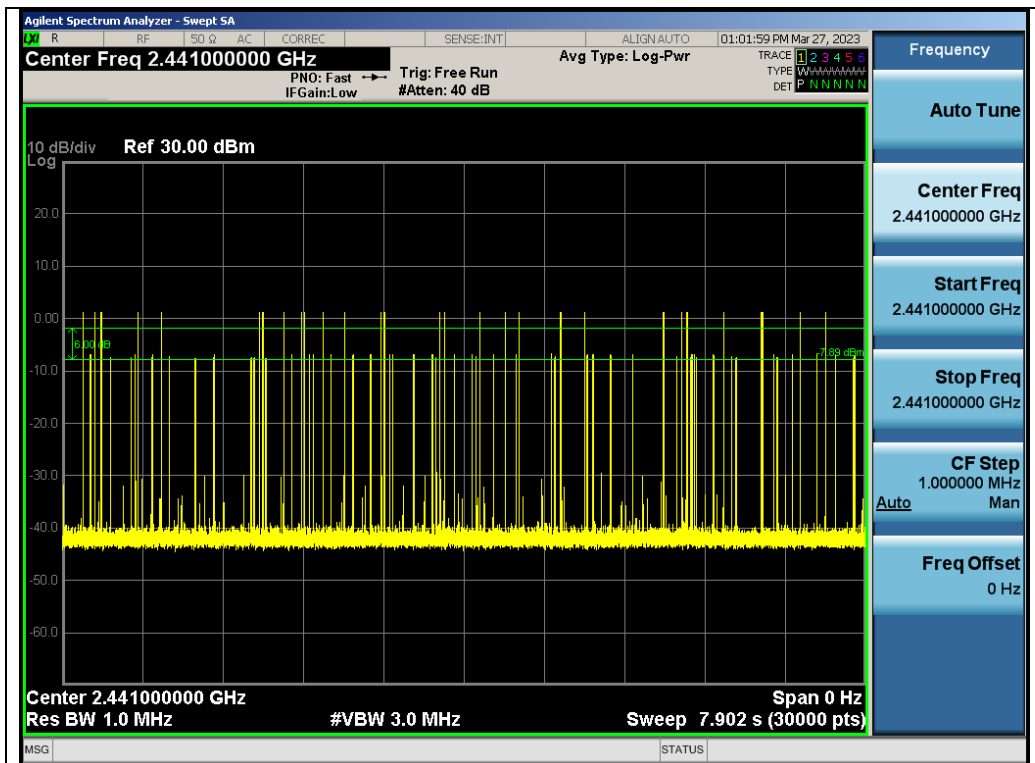

Test_Graph_BR_HOP_ANT1_NA_1Mbps_2441_Number of Burst

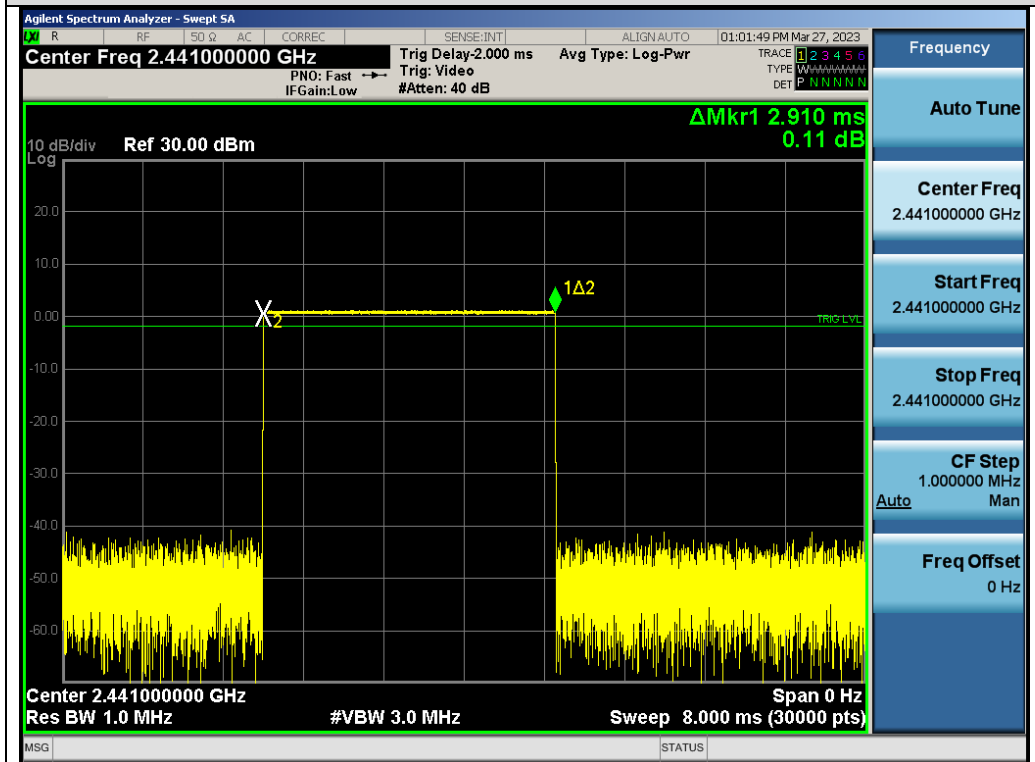

Test_Graph_BR_HOP_ANT1_NA_1Mbps_2441_Time per Burst

Any report having not been signed by authorized approver, or having been altered without authorization, or having not been stamped by the "Dedicated Testing/Inspection Stamp" is deemed to be invalid. Copying or excerpting portion of, or altering the content of the report is not permitted without the written authorization of AGC. The test results presented in the report apply only to the tested sample. Any objections to report issued by AGC should be submitted to AGC within 15days after the issuance of the test report. Further enquiry of validity or verification of the test report should be addressed to AGC by agc01@agccert.com.

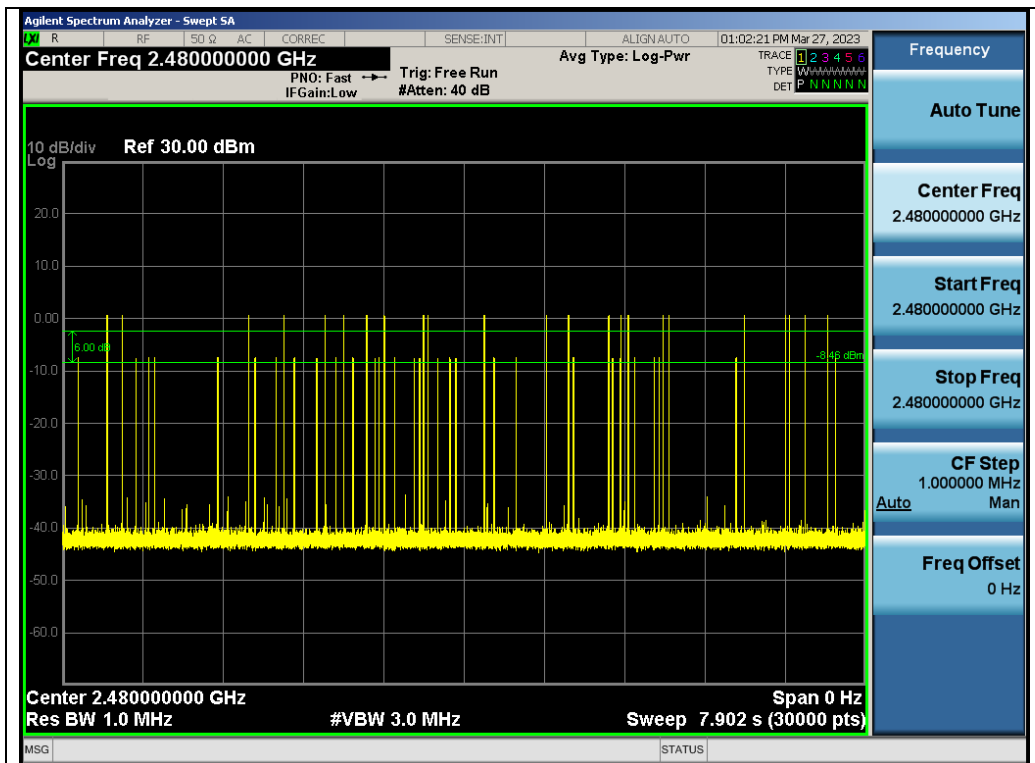

Test_Graph_BR_HOP_ANT1_NA_1Mbps_2480_Number of Burst

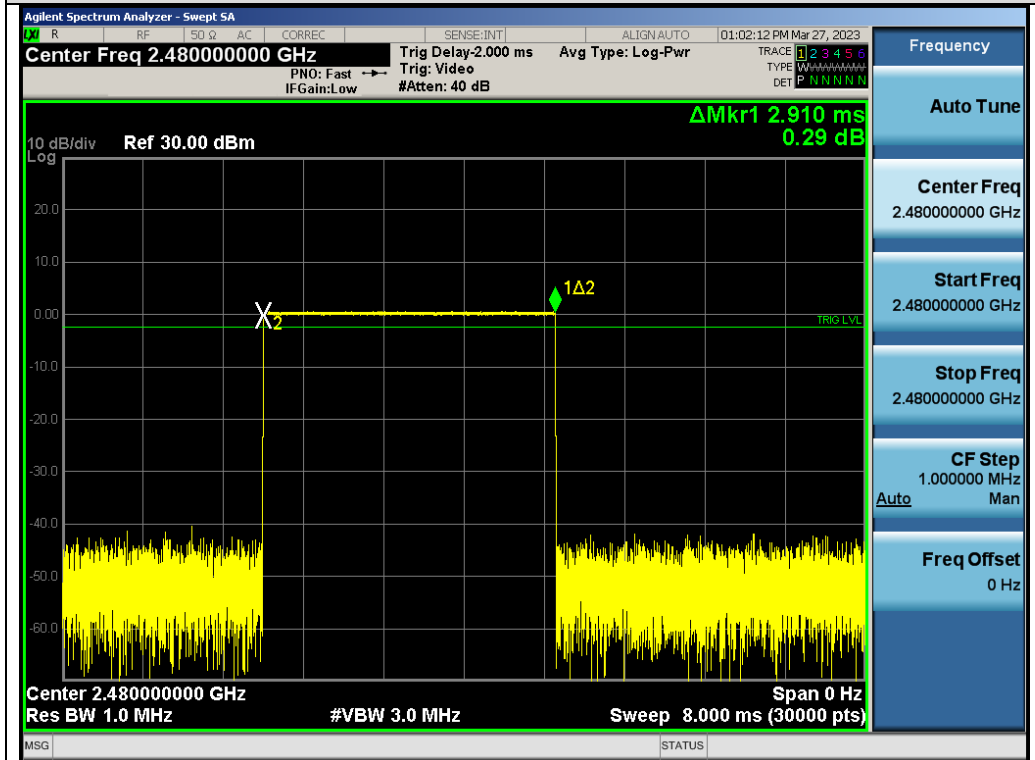

Test_Graph_BR_HOP_ANT1_NA_1Mbps_2480_Time per Burst

Any report having not been signed by authorized approver, or having been altered without authorization, or having not been stamped by the "Dedicated Testing/Inspection Stamp" is deemed to be invalid. Copying or excerpting portion of, or altering the content of the report is not permitted without the written authorization of AGC. The test results presented in the report apply only to the tested sample. Any objections to report issued by AGC should be submitted to AGC within 15days after the issuance of the test report. Further enquiry of validity or verification of the test report should be addressed to AGC by agc01@agccert.com.

13. FREQUENCY SEPARATION

13.1. MEASUREMENT PROCEDURE

The EUT shall have its hopping function enabled. Use the following spectrum analyzer settings:

1. Span: Wide enough to capture the peaks of two adjacent channels.
2. RBW: Start with the RBW set to approximately 30% of the channel spacing; adjust as necessary to best identify the center of each individual channel.
3. Video (or average) bandwidth (VBW) \geq RBW.
4. Sweep: Auto. e) Detector function: Peak. f) Trace: Max hold. g) Allow the trace to stabilize.

Use the marker-delta function to determine the separation between the peaks of the adjacent channels.

13.2. TEST SETUP (BLOCK DIAGRAM OF CONFIGURATION)

Same as described in section 6.2

13.3. MEASUREMENT EQUIPMENT USED

The same as described in section 6.3

13.4. LIMITS AND MEASUREMENT RESULT

Test Data of Frequency Separation			
Test Mode	Channel Separation (MHz)	Limits	Pass or Fail
GFSK Hopping	1.005	$\geq 2/3$ -20dB BW	Pass

Test Graphs of Number of Hopping Frequency

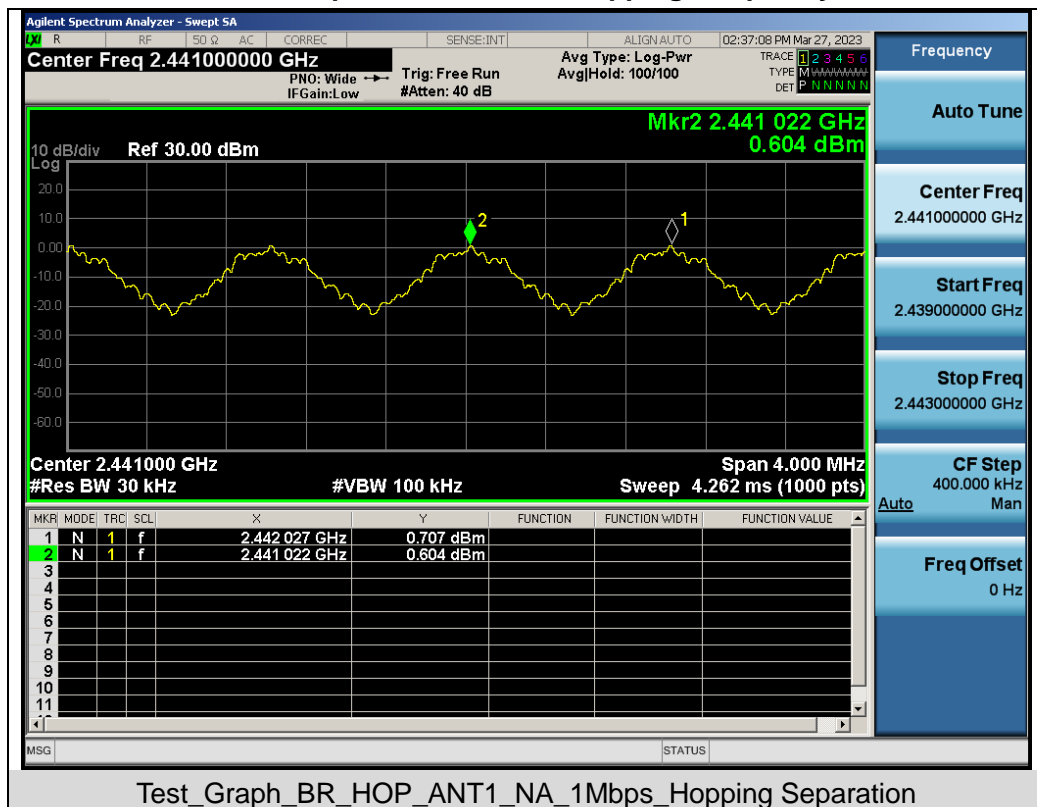

Note: The GFSK modulation is the worst case and recorded in the report.

Any report having not been signed by authorized approver, or having been altered without authorization, or having not been stamped by the "Dedicated Testing/Inspection Stamp" is deemed to be invalid. Copying or excerpting portion of, or altering the content of the report is not permitted without the written authorization of AGC. The test results presented in the report apply only to the tested sample. Any objections to report issued by AGC should be submitted to AGC within 15days after the issuance of the test report. Further enquiry of validity or verification of the test report should be addressed to AGC by agc01@agccert.com.

14. LINE CONDUCTED EMISSION TEST

14.1. LIMITS OF LINE CONDUCTED EMISSION TEST

Frequency	Maximum RF Line Voltage	
	Q.P. (dB μ V)	Average (dB μ V)
150kHz~500kHz	66-56	56-46
500kHz~5MHz	56	46
5MHz~30MHz	60	50

Note:

1. The lower limit shall apply at the transition frequency.
2. The limit decreases linearly with the logarithm of the frequency in the range 0.15 MHz to 0.50 MHz.

14.2. BLOCK DIAGRAM OF LINE CONDUCTED EMISSION TEST

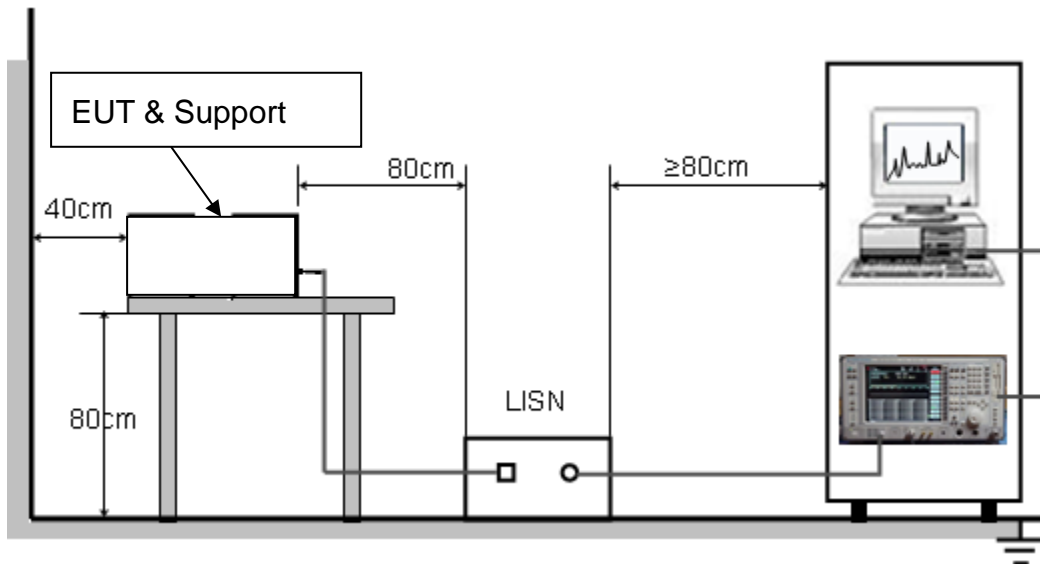

Any report having not been signed by authorized approver, or having been altered without authorization, or having not been stamped by the "Dedicated Testing/Inspection Stamp" is deemed to be invalid. Copying or excerpting portion of, or altering the content of the report is not permitted without the written authorization of AGC. The test results presented in the report apply only to the tested sample. Any objections to report issued by AGC should be submitted to AGC within 15days after the issuance of the test report. Further enquiry of validity or verification of the test report should be addressed to AGC by agc01@agccert.com.

14.3. PRELIMINARY PROCEDURE OF LINE CONDUCTED EMISSION TEST

1. The equipment was set up as per the test configuration to simulate typical actual usage per the user's manual. When the EUT is a tabletop system, a wooden table with a height of 0.8 meters is used and is placed on the ground plane as per ANSI C63.10 (see Test Facility for the dimensions of the ground plane used). When the EUT is a floor-standing equipment, it is placed on the ground plane which has a 3-12 mm non-conductive covering to insulate the EUT from the ground plane.
2. Support equipment, if needed, was placed as per ANSI C63.10.
3. All I/O cables were positioned to simulate typical actual usage as per ANSI C63.10.
4. All support equipment received AC120V/60Hz power from a LISN, if any.
5. The EUT received DC 5V power from adapter which received AC120V/60Hz power from a LISN.
6. The test program was started. Emissions were measured on each current carrying line of the EUT using a spectrum Analyzer / Receiver connected to the LISN powering the EUT. The LISN has two monitoring points: Line 1 (Hot Side) and Line 2 (Neutral Side). Two scans were taken: one with Line 1 connected to Analyzer / Receiver and Line 2 connected to a 50 ohm load; the second scan had Line 1 connected to a 50 ohm load and Line 2 connected to the Analyzer / Receiver.
7. Analyzer / Receiver scanned from 150 kHz to 30MHz for emissions in each of the test modes.
8. During the above scans, the emissions were maximized by cable manipulation.
9. The test mode(s) were scanned during the preliminary test.

Then, the EUT configuration and cable configuration of the above highest emission level were recorded for reference of final testing.

14.4. FINAL PROCEDURE OF LINE CONDUCTED EMISSION TEST

1. EUT and support equipment was set up on the test bench as per step 2 of the preliminary test.
2. A scan was taken on both power lines, Line 1 and Line 2, recording at least the six highest emissions. Emission frequency and amplitude were recorded into a computer in which correction factors were used to calculate the emission level and compare reading to the applicable limit. If EUT emission level was less – 2dB to the A.V. limit in Peak mode, then the emission signal was re-checked using Q.P and Average detector.
3. The test data of the worst case condition(s) was reported on the Summary Data page.

14.5. TEST RESULT OF LINE CONDUCTED EMISSION TEST

Line Conducted Emission Test Line 1-L

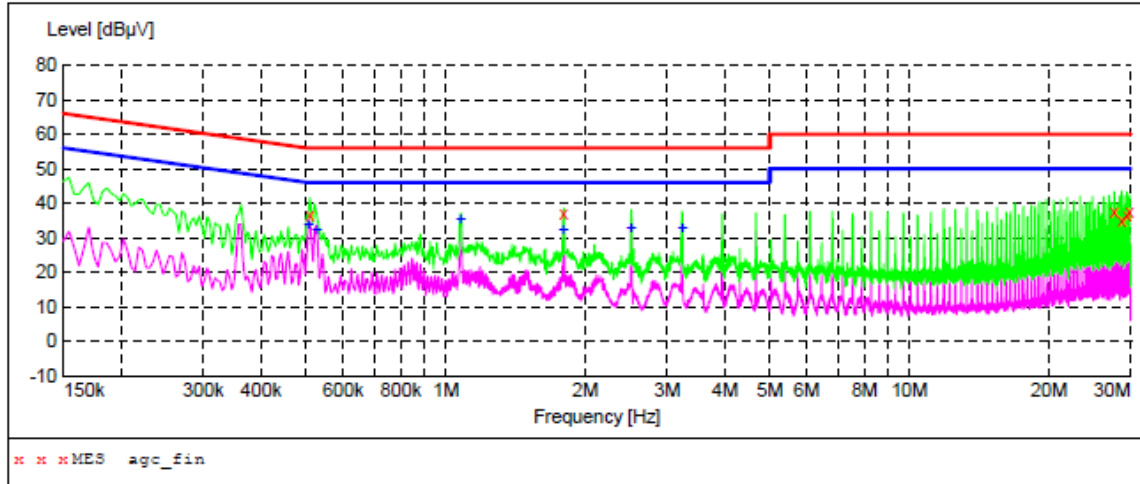

MEASUREMENT RESULT: "agc_fin"

2023/3/27 14:44

Frequency MHz	Level dBuV	Transd dB	Limit dBuV	Margin dB	Detector	Line
0.510000	36.60	5.4	56	19.4	QP	L1
1.798000	36.80	6.3	56	19.2	QP	L1
27.666000	37.40	9.4	60	22.6	QP	L1
28.730000	34.90	9.5	60	25.1	QP	L1
29.466000	36.40	9.5	60	23.6	QP	L1
29.826000	37.40	9.6	60	22.6	QP	L1

MEASUREMENT RESULT: "agc_fin2"

2023/3/27 14:44

Frequency MHz	Level dBuV	Transd dB	Limit dBuV	Margin dB	Detector	Line
0.506000	33.80	5.4	46	12.2	AV	L1
0.526000	32.50	5.4	46	13.5	AV	L1
1.078000	35.40	5.5	46	10.6	AV	L1
1.794000	32.60	6.3	46	13.4	AV	L1
2.514000	33.10	6.5	46	12.9	AV	L1
3.234000	33.00	6.5	46	13.0	AV	L1

Any report having not been signed by authorized approver, or having been altered without authorization, or having not been stamped by the "Dedicated Testing/Inspection Stamp" is deemed to be invalid. Copying or excerpting portion of, or altering the content of the report is not permitted without the written authorization of AGC. The test results presented in the report apply only to the tested sample. Any objections to report issued by AGC should be submitted to AGC within 15days after the issuance of the test report. Further enquiry of validity or verification of the test report should be addressed to AGC by agc01@agccert.com.

Line Conducted Emission Test Line 2-N

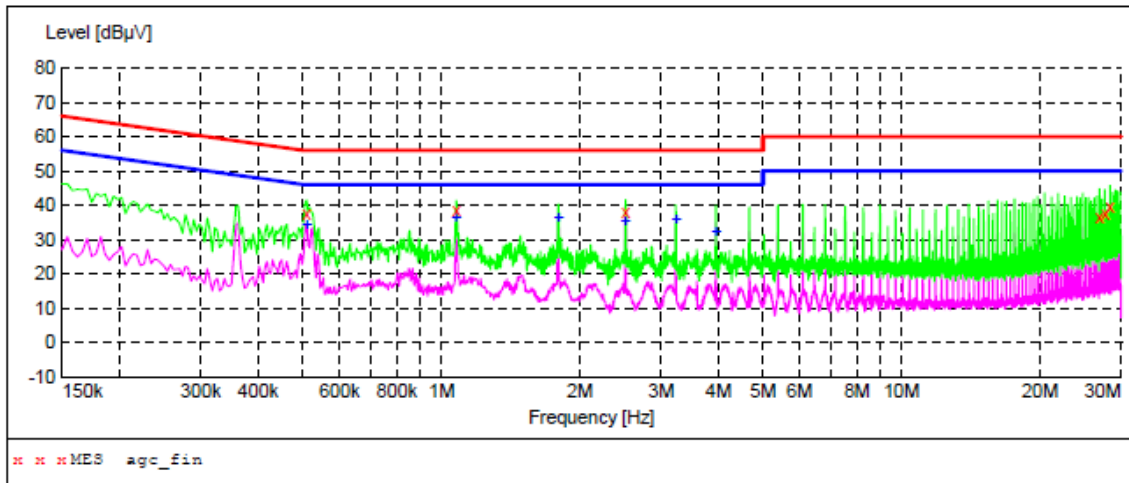

MEASUREMENT RESULT: "agc_fin"

2023/3/27 14:47

Frequency MHz	Level dBµV	Transd dB	Limit dBµV	Margin dB	Detector	Line
0.510000	37.70	5.4	56	18.3	QP	N
1.078000	38.50	5.5	56	17.5	QP	N
2.514000	38.00	6.5	56	18.0	QP	N
26.938000	36.50	9.3	60	23.5	QP	N
27.682000	37.60	9.4	60	22.4	QP	N
28.386000	39.60	9.5	60	20.4	QP	N

MEASUREMENT RESULT: "agc_fin2"

2023/3/27 14:47

Frequency MHz	Level dBµV	Transd dB	Limit dBµV	Margin dB	Detector	Line
0.510000	34.30	5.4	46	11.7	AV	N
1.078000	36.30	5.5	46	9.7	AV	N
1.798000	36.50	6.3	46	9.5	AV	N
2.514000	35.20	6.5	46	10.8	AV	N
3.234000	36.00	6.5	46	10.0	AV	N
3.954000	32.60	6.5	46	13.4	AV	N

RESULT: PASS

Note: All the test modes had been tested, the mode 8 was the worst case. Only the data of the worst case would be record in this test report.

Any report having not been signed by authorized approver, or having been altered without authorization, or having not been stamped by the "Dedicated Testing/Inspection Stamp" is deemed to be invalid. Copying or excerpting portion of, or altering the content of the report is not permitted without the written authorization of AGC. The test results presented in the report apply only to the tested sample. Any objections to report issued by AGC should be submitted to AGC within 15days after the issuance of the test report. Further enquiry of validity or verification of the test report should be addressed to AGC by agc01@agccert.com.

APPENDIX A: PHOTOGRAPHS OF TEST SETUP

Refer to the Report No.: AGC08189230302AP01

APPENDIX B: PHOTOGRAPHS OF EUT

Refer to the Report No.: AGC08189230302AP02

----END OF REPORT----

Any report having not been signed by authorized approver, or having been altered without authorization, or having not been stamped by the "Dedicated Testing/Inspection Stamp" is deemed to be invalid. Copying or excerpting portion of, or altering the content of the report is not permitted without the written authorization of AGC. The test results presented in the report apply only to the tested sample. Any objections to report issued by AGC should be submitted to AGC within 15days after the issuance of the test report. Further enquiry of validity or verification of the test report should be addressed to AGC by agc01@agccert.com.

Attestation of Global Compliance(Shenzhen)Co., Ltd

Attestation of Global Compliance(Shenzhen)Std & Tech Co., Ltd

Tel: +86-755 2523 4088 E-mail: agc@agccert.com Web: <http://www.agccert.com/>



Conditions of Issuance of Test Reports

1. All samples and goods are accepted by the Attestation of Global Compliance (Shenzhen) Co., Ltd (the “Company”) solely for testing and reporting in accordance with the following terms and conditions. The company provides its services on the basis that such terms and conditions constitute express agreement between the company and any person, firm or company requesting its services (the “Clients”).
2. Any report issued by Company as a result of this application for testing services (the “Report”) shall be issued in confidence to the Clients and the Report will be strictly treated as such by the Company. It may not be reproduced either in its entirety or in part and it may not be used for advertising or other unauthorized purposes without the written consent of the Company. The Clients to whom the Report is issued may, however, show or send it, or a certified copy thereof prepared by the Company to its customer, supplier or other persons directly concerned. The Company will not, without the consent of the Clients, enter into any discussion or correspondence with any third party concerning the contents of the Report, unless required by the relevant governmental authorities, laws or court orders.
3. The Company shall not be called or be liable to be called to give evidence or testimony on the Report in a court of law without its prior written consent, unless required by the relevant governmental authorities, laws or court orders.
4. In the event of the improper use of the report as determined by the Company, the Company reserves the right to withdraw it, and to adopt any other additional remedies which may be appropriate.
5. Samples submitted for testing are accepted on the understanding that the Report issued cannot form the basis of, or be the instrument for, any legal action against the Company.
6. The Company will not be liable for or accept responsibility for any loss or damage however arising from the use of information contained in any of its Reports or in any communication whatsoever about its said tests or investigations.
7. Clients wishing to use the Report in court proceedings or arbitration shall inform the Company to that effect prior to submitting the sample for testing.
8. The Company is not responsible for recalling the electronic version of the original report when any revision is made to them. The Client assumes the responsibility to providing the revised version to any interested party who uses them.
9. Subject to the variable length of retention time for test data and report stored hereinto as otherwise specifically required by individual accreditation authorities, the Company will only keep the supporting test data and information of the test report for a period of six years. The data and information will be disposed of after the aforementioned retention period has elapsed. Under no circumstances shall we provide any data and information which has been disposed of after retention period. Under no circumstances shall we be liable for damage of any kind, including (but not limited to) compensatory damages, lost profits, lost data, or any form of special, incidental, indirect, consequential or punitive damages of any kind, whether based on breach of contract of warranty, tort (including negligence), product liability or otherwise, even if we are informed in advance of the possibility of such damages.

Any report having not been signed by authorized approver, or having been altered without authorization, or having not been stamped by the “Dedicated Testing/Inspection Stamp” is deemed to be invalid. Copying or excerpting portion of, or altering the content of the report is not permitted without the written authorization of AGC. The test results presented in the report apply only to the tested sample. Any objections to report issued by AGC should be submitted to AGC within 15days after the issuance of the test report. Further enquiry of validity or verification of the test report should be addressed to AGC by agc01@agccert.com.