



FCC Test Report

Report No: HX230905R002

Issued for

Applicant:	Skylab M&C Technology Co., Ltd.
Address:	6/F,Building 9,Lijincheng Scientific&Technical park, Gongye East Road, Longhua District, Shenzhen, 518109 China
Product Name:	Wifi module
Model Name:	WG221BL
FCC ID:	2ACOE-WG221BL
Issued By: Shenzhen Huaxin Information Technology Service Co., Ltd Add: 101, R & D Building, No.3 guansheng 4th Road, Luhu Community · Guanhu Street, Longhua District, Shenzhen, Guangdong, China	

TEST RESULT CERTIFICATION

Applicant's Name.....: Skylab M&C Technology Co., Ltd.
 Address.....: 6/F,Building 9,Lijincheng Scientific&Technical park,Gongye East Road, Longhua District, Shenzhen, 518109 China
 Manufacture's Name.....: Skylab M&C Technology Co., Ltd.
 Address.....: 6/F,Building 9,Lijincheng Scientific&Technical park,Gongye East Road, Longhua District, Shenzhen, 518109 China

Product Description

Product Name.....: Wifi module
 Brand Name.....: /
 Model Name.....: WG221BL
 Series Model.....: /
 Test Standards.....: FCC Rules and Regulations Part 15 Subpart C, Section 247
 Test Procedure.....: ANSI C63.10:2013

This device described above has been tested by Shenzhen Huaxin Information Technology Service Co., Ltd, the test results show that the equipment under test (EUT) is in compliance with the FCC requirements. And it is applicable only to the tested sample identified in the report. This report shall not be reproduced except in full, without the written approval of Shenzhen Huaxin Information Technology Service Co., Ltd, this document may be altered or revised by Shenzhen Huaxin Information Technology Service Co., Ltd, personal only, and shall be noted in the revision of the document..

Date of Test.....:
 Date (s) of performance of tests.: Sept 4th,2023 ~ Sept 5th,2023
 Date of Issue.....: Sept 5th, 2023
 Test Result.....: Pass

Tested by : Eason Tan

 (Eason Tan)
 Approved by : Michael wu

 (Michael Wu)



Table of Contents	Page
1. SUMMARY OF TEST RESULTS	6
1.1 TEST FACTORY	7
1.2 MEASUREMENT UNCERTAINTY	7
2. GENERAL INFORMATION	8
2.1 GENERAL DESCRIPTION OF THE EUT	8
2.2 DESCRIPTION OF THE TEST MODES	10
2.3 TEST SOFTWARE AND POWER LEVEL	11
2.4 DESCRIPTION OF NECESSARY ACCESSORIES AND SUPPORT UNITS	11
2.5 EQUIPMENTS LIST FOR ALL TEST ITEMS	12
3. EMC EMISSION TEST	13
3.1 CONDUCTED EMISSION MEASUREMENT	13
3.2 RADIATED EMISSION MEASUREMENT	17
4. CONDUCTED SPURIOUS & BAND EDGE EMISSION	30
4.1 LIMIT	30
4.2 TEST PROCEDURE	30
4.3 DEVIATION FROM STANDARD	30
4.4 TEST SETUP	30
4.5 EUT OPERATION CONDITIONS	31
4.6 TEST RESULTS	31
5. POWER SPECTRAL DENSITY TEST	32
5.1 LIMIT	32
5.2 TEST PROCEDURE	32
5.3 DEVIATION FROM STANDARD	32
5.4 TEST SETUP	32
5.5 EUT OPERATION CONDITIONS	32
5.6 TEST RESULTS	33
6. BANDWIDTH TEST	34
6.1 LIMIT	34
6.2 TEST PROCEDURE	34
6.3 DEVIATION FROM STANDARD	34

Table of Contents	Page
6.4 TEST SETUP	34
6.5 EUT OPERATION CONDITIONS	34
6.6 TEST RESULTS	35
7. PEAK OUTPUT POWER TEST	36
7.1 LIMIT	36
7.2 TEST PROCEDURE	36
7.3 DEVIATION FROM STANDARD	36
7.4 TEST SETUP	36
7.5 EUT OPERATION CONDITIONS	36
7.6 TEST RESULTS	37
8. BAND EDGE CHECK	38
8.1 TEST LIMITS	38
8.2 TEST PROCEDURE	38
8.3 TEST SETUP	38
8.4 TEST RESULTS	38
9. ANTENNA REQUIREMENT	41
9.1 STANDARD REQUIREMENT	41
9.2 EUT ANTENNA	41
APPENDIX I: TEST RESULTS	42
APPENDIX II: EXTERNAL PHOTOS	43
APPENDIX III: INTERNAL PHOTOS	44
APPENDIX IV: TEST SETUP PHOTOS	45

Revision History

Rev.	Issue Date	Contents
V0	Sept 5th, 2023	Initial Issue

1. SUMMARY OF TEST RESULTS

Test procedures according to the technical standards:

KDB 558074 D01 15.247 Meas Guidance v05r02.

FCC Part 15.247, Subpart C			
Standard Section	Test Item	Judgment	Remark
15.207	Conducted Emission	PASS	--
15.247 (a)(2)	6dB Bandwidth	PASS	--
15.247 (b)(3)	Output Power	PASS	--
15.209	Radiated Spurious Emission	PASS	--
15.247 (d)	Conducted Spurious & Band Edge Emission	PASS	--
15.247 (e)	Power Spectral Density	PASS	--
15.203	Antenna Requirement	PASS	--

NOTE:

- (1) 'N/A' denotes test is not applicable in this Test Report.
- (2) The conclusion of this test report is judged by actual test data without considering measurement uncertainty.

1.1 TEST FACTORY

Company Name:	Shenzhen Huaxin Information Technology Service Co., Ltd
Address:	101, R & D Building, No.3 guansheng 4th Road, Luhua Community · Guanhu Street, Longhua District, Shenzhen, Guangdong, China
Telephone:	0775-21018313
Fax:	0775-21018313
FCC Test Firm Registration Number: 932271 Designation Number: CN1344 CAB ID : CN0147	

1.2 MEASUREMENT UNCERTAINTY

The reported uncertainty of measurement $y \pm U$, where expanded uncertainty U is based on a standard uncertainty multiplied by a coverage factor of $k=2$, providing a level of confidence of approximately **95** %.

Item	MU	Remark
Conducted Emission (9K ~ 0.15MHz)	2.18dB	
Conducted Emission (0.15M ~ 30MHz)	2.17dB	
Radiation Emission ,3m (30MHz ~ 1GHz)	4.45 dB	Polarize: V
	2.76 dB	Polarize: H
Radiation Emission, 3m (1GHz ~ 6GHz)	4.02 dB	
Radiation Emission ,3m (6GHz ~ 18GHz)	4.30 dB	
RF output power (conducted)	0.41 dB	
Power Spectral Density (conducted)	0.39 dB	
Spurious emissions (conducted)	0.59 dB	
Occupied Channel Bandwidth (conducted)	4.22%	

2. GENERAL INFORMATION

2.1 GENERAL DESCRIPTION OF THE EUT

Product Name	Wifi module	
Trade Mark	/	
Model Name	WG221BL	
Series Model	/	
Model Difference	/	
Product Description	The EUT is a WG221BL	
	Operation Frequency:	802.11b/g/n20 2412~2462 MHz 802.11n40:2422~2452MHz
	Modulation Type:	802.11b(DSSS):CCK,DQPSK,DBPSK 802.11g(OFDM):BPSK,QPSK,16-QAM,64-QAM 802.11n(OFDM):BPSK,QPSK,16-QAM,64-QAM
	Number of Channel:	802.11b/g/n/20: 11CH 802.11n/40: 7CH
	Antenna Designation:	External antenna
	Antenna Gain(dBi):	3.81
	Duty Cycle:	>98%
Channel List	Please refer to the Note 2.	
Adapter	N/A	
Battery	N/A	
Hardware version number	V1.0	
Software versionnumber	V1.0	
Connecting I/O Port(s)	Please refer to the Note 1.	

Note:

1. For a more detailed features description, please refer to the manufacturer's specifications or the User Manual.

2.

Operation Frequency of channel			
802.11b/g/n(20MHz)		Channel List for 802.11n(40MHz)	
Channel	Frequency	Channel	Frequency
01	2412	03	2422
02	2417	04	2427
03	2422	05	2432
04	2427	06	2437
05	2432	07	2442
06	2437	08	2447
07	2442	09	2452
08	2447		
09	2452		
10	2457		
11	2462		

Note:

In section 15.31(m), regards to the operating frequency range over 10 MHz, the Lowest frequency, the middle frequency, and the highest frequency of channel were selected to perform the test, and the selected channel see below:

Carrier Frequency Channel

2.4GHz Test Frequency:

For 802.11b/g/n (HT20)		For 802.11n (HT40)	
Channel	Freq.(MHz)	Channel	Freq.(MHz)
01	2412	03	2422
06	2437	06	2437
11	2462	09	2452

Note: The antenna information refer the manufacturer provide report, applicable only to the tested sample identified in the report.

2.2 DESCRIPTION OF THE TEST MODES

Each of these EUT operation mode(s) or test configuration mode(s) mentioned above was evaluated respectively.

Worst Mode	Description	Data Rate
Mode 1	TX IEEE 802.11b CH1	1 Mbps
Mode 2	TX IEEE 802.11b CH6	1 Mbps
Mode 3	TX IEEE 802.11 b CH11	1 Mbps
Mode 4	TX IEEE 802.11g CH1	6 Mbps
Mode 5	TX IEEE 802.11g CH6	6 Mbps
Mode 6	TX IEEE 802.11g CH11	6 Mbps
Mode 7	TX IEEE 802.11n HT20 CH1	MCS 0
Mode 8	TX IEEE 802.11n HT20 CH6	MCS 0
Mode 9	TX IEEE 802.11n HT20 CH11	MCS 0
Mode 10	TX IEEE 802.11n HT40 CH3	MCS 0
Mode 11	TX IEEE 802.11n HT40 CH6	MCS 0
Mode 12	TX IEEE 802.11n HT40 CH9	MCS 0

Note:

- (1) The measurements are performed at all Bit Rate of Transmitter, the worst data was reported.
- (2) The battery is fully-charged during the radited and RF conducted test.

2.3 TEST SOFTWARE AND POWER LEVEL

During testing channel & power controlling software provided by the customer was used to control the operating channel as well as the output power level.

Accessories Equipment

Description	Manufacturer	Model	S/N	Rating
/	/	/	/	/
/	/	/	/	/

2.4 DESCRIPTION OF NECESSARY ACCESSORIES AND SUPPORT UNITS

The EUT has been tested as an independent unit together with other necessary accessories or support units. The following support units or accessories were used to form a representative test configuration during the tests.

Note:

- (1) For detachable type I/O cable should be specified the length in cm in 『Length』 column.
- (2) “YES” is means “with core”; “NO” is means “without core”.

2.5 EQUIPMENTS LIST FOR ALL TEST ITEMS

Equipment	Manufacturer	Model No.	Firmware version	Serial No.	Last cal.	Cal. Due day
9*6*6 anechoic chamber	Mao Rui	9*6*6m	/	N/A	2022.06.15	2025.06.14
EMI receiver	R&S	ESR7	5.812	102543	2022.10.20	2023.10.19
Spectrum analyzer	R&S	FSV40-N	V7.0-4-62-2	101795	2022.09.19	2023.09.18
Pre-amplifier	HP	8447D	/	1616A02061	2023.04.15	2024.04.14
Pre-amplifier	Agilent	8449B	/	9008A00551	2023.04.15	2024.04.14
Bilog Antenna	Schwarzbeck	VULB 9168	/	/	2022.06.19	2024.06.18
Horn antenna	A.H. System, Inc	SAS-571	/	915	2023.06.17	2024.06.16
Loop Antenna	Schwarzbeck	FMZB 1519B	/	/	2023.06.17	2024.06.16
LISN	R&S	ENV216		101291	2023.03.28	2024.03.27
LISN	R&S	ESH3-Z5		894981/024	2023.03.28	2024.03.27
Analog signal Generato	Agilent	N5181A	A.01.87	MY47421151	2022.09.17	2023.09.16
Vector Signal Generator	Keysight	N5182A	A.01.87	MY50140428	2022.09.17	2023.09.16
Wideband Radio communication tester	R&S	CMW500	V3.7.22	157762	2022.09.17	2023.09.16
Spectrum analyzer	Agilent	N9020A	A.14.16	MY51280803	2023.04.15	2024.04.14
RF Cable	/	(10G)9m	/	/	2022.09.17	2023.09.16
RF Cable	/	(10G)10m	/	/	2022.09.17	2023.09.16
RF Cable	/	(18G)10m	/	/	2022.09.17	2023.09.16
attenuation pad	/	6dB	/	/	2022.09.17	2023.09.16
attenuation pad	/	10dB	/	16280012	2022.09.17	2023.09.16

Software Information			
Test Item	Software Name	Manufacturer	Version
RE	EMC-I	SKET	V1.4.0.1
CE	EMC-I	SKET	V1.4.0.1
RF-CE	RF Test Software	TACHOY	V2.0

3. EMC EMISSION TEST

3.1 CONDUCTED EMISSION MEASUREMENT

3.1.1 POWER LINE CONDUCTED EMISSION LIMITS

The radio frequency voltage that is conducted back onto the AC power line on any frequency or frequencies, within the band 150 kHz to 30 MHz, shall not exceed the limits in the following table.

FREQUENCY (MHz)	Conducted Emissionlimit (dBuV)	
	Quasi-peak	Average
0.15 -0.5	66 – 56 *	56 – 46 *
0.50 -5.0	56.00	46.00
5.0 -30.0	60.00	50.00

Note:

- (1) The tighter limit applies at the band edges.
- (2) The limit of “ * ” marked band means the limitation decreases linearly with the logarithm of the frequency in the range.

The following table is the setting of the receiver

Receiver Parameters	Setting
Attenuation	10 dB
Start Frequency	0.15 MHz
Stop Frequency	30 MHz
IF Bandwidth	9 kHz

3.1.2 TEST PROCEDURE

- The EUT is 0.8 m from the horizontal ground plane and 0.4 m from the vertical ground plane with EUT being connected to the power mains through a line impedance stabilization network (LISN). All other support equipments are powered from additional LISN(s). The LISN provides 50 Ohm/ 50uH of coupling impedance for the measuring instrument.
- Interconnecting cables that hang closer than 40 cm to the ground plane shall be folded back and forth in the center forming a bundle 30 to 40 cm long.
- I/O cables that are not connected to a peripheral shall be bundled in the center. The end of the cable may be terminated, if required, using the correct terminating impedance. The overall length shall not exceed 1 m.
- LISN is at least 80 cm from the nearest part of EUT chassis.
- For the actual test configuration, please refer to the related Item –EUT Test Photos.

3.1.3 TEST SETUP

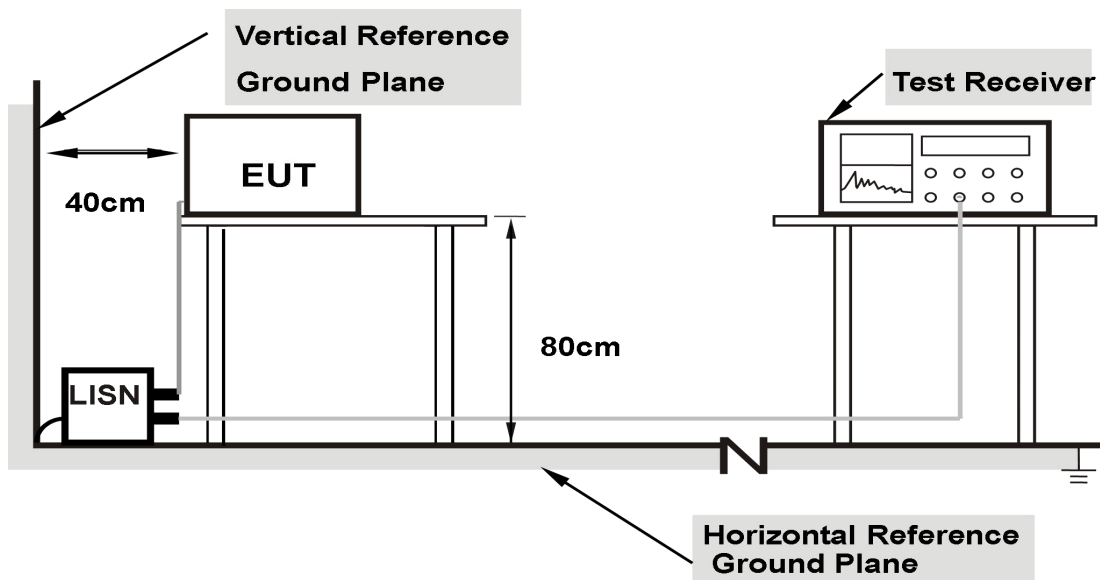

Note: 1. Support units were connected to second LISN.

2. Both of LISNs (AMN) are 80 cm from EUT and at least 80 cm from other units and other metal planes support units.

3.1.4 EUT OPERATING CONDITIONS

The EUT was configured for testing in a typical fashion (as a customer would normally use it). The EUT has been programmed to continuously transmit during test. This operating condition was tested and used to collect the included data.

3.1.5 TEST RESULT

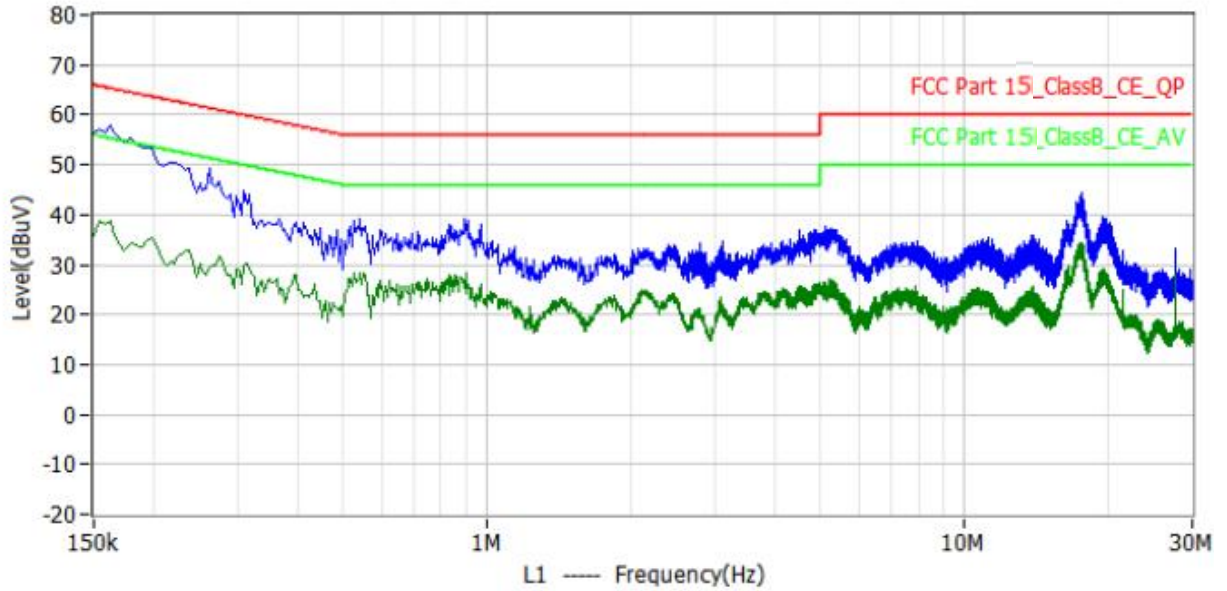

No.	Frequency	Reading dBuV	Factor dB	Level dBuV	Limit dBuV	Delta dB	Detector	Polar
1*	162.000kHz	48.2	9.6	57.8	65.4	-7.6	QP	L1
2*	262.000kHz	39.2	10.0	49.2	61.4	-12.2	QP	L1
3*	17.614MHz	34.2	10.2	44.4	60.0	-15.6	QP	L1
4*	898.000kHz	29.4	9.8	39.2	56.0	-16.8	QP	L1
5*	4.498MHz	27.1	9.8	36.9	56.0	-19.1	QP	L1
6*	27.650MHz	22.8	10.3	33.1	60.0	-26.9	QP	L1
7*	17.686MHz	24.2	10.2	34.4	50.0	-15.6	AV	L1
8*	162.000kHz	29.2	9.6	38.8	55.4	-16.6	AV	L1
9*	550.000kHz	18.7	9.7	28.4	46.0	-17.6	AV	L1
10*	234.000kHz	22.9	9.9	32.8	52.3	-19.5	AV	L1
11*	27.646MHz	17.7	10.3	28.0	50.0	-22.0	AV	L1
12*	5.194MHz	17.3	9.8	27.1	50.0	-22.9	AV	L1

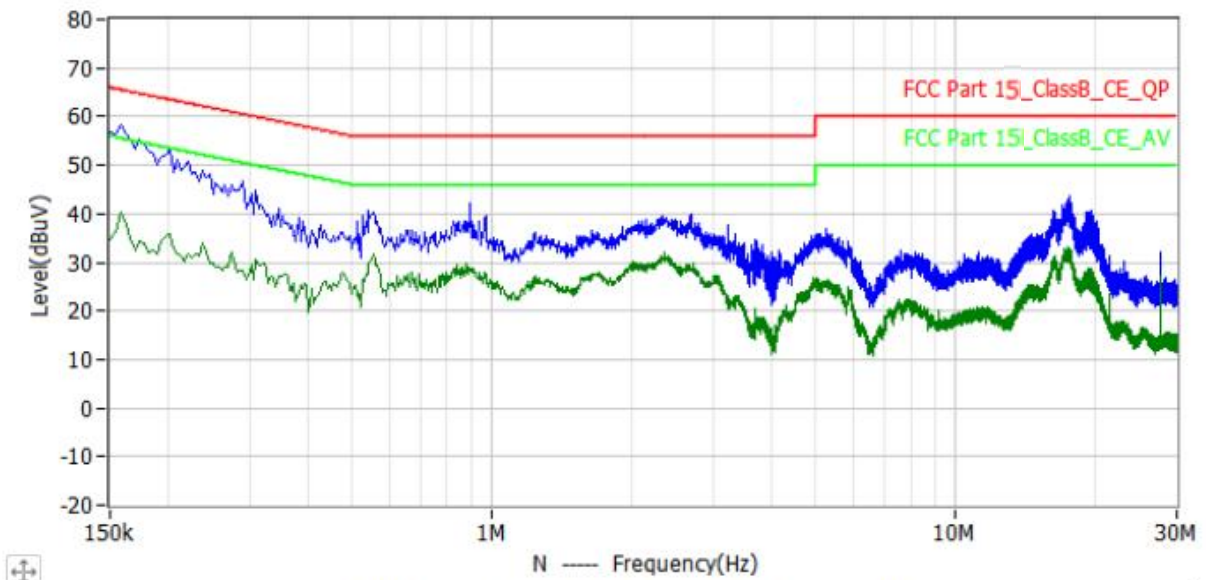

No.	Frequency	Reading dBuV	Factor dB	Level dBuV	Limit dBuV	Delta dB	Detector	Polar
1*	158.000kHz	48.4	9.9	58.3	65.6	-7.3	QP	N
2*	290.000kHz	37.0	9.8	46.8	60.5	-13.7	QP	N
3*	898.000kHz	32.6	9.6	42.2	56.0	-13.8	QP	N
4*	2.694MHz	30.3	9.7	40.0	56.0	-16.0	QP	N
5*	17.642MHz	33.4	10.3	43.7	60.0	-16.3	QP	N
6*	5.242MHz	26.9	9.9	36.8	60.0	-23.2	QP	N
7*	2.358MHz	22.5	9.6	32.1	46.0	-13.9	AV	N
8*	554.000kHz	22.1	9.7	31.8	46.0	-14.2	AV	N
9*	158.000kHz	30.3	9.9	40.2	55.6	-15.4	AV	N
10*	17.394MHz	22.7	10.3	33.0	50.0	-17.0	AV	N
11*	27.646MHz	17.0	10.4	27.4	50.0	-22.6	AV	N
12*	5.030MHz	16.8	9.9	26.7	50.0	-23.3	AV	N

3.2 RADIATED EMISSION MEASUREMENT

3.2.1 RADIATED EMISSION LIMITS

In any 100 kHz bandwidth outside the operating frequency band. In case the emission fall within the Restricted band specified on Part15.205(a)&209(a) limit in the table and according to ANSI C63.10-2013 below has to be followed.

LIMITS OF RADIATED EMISSION MEASUREMENT (0.009MHz - 1000MHz)

Frequencies (MHz)	Field Strength (microvolts/meter)	Measurement Distance (meters)
0.009~0.490	2400/F(KHz)	300
0.490~1.705	24000/F(KHz)	30
1.705~30.0	30	30
30~88	100	3
88~216	150	3
216~960	200	3
Above 960	500	3

LIMITS OF RADIATED EMISSION MEASUREMENT (1000MHz-25GHz)

FREQUENCY (MHz)	(dBuV/m) (at 3M)	
	PEAK	AVERAGE
Above 1000	74	54

Notes:

- (1) The limit for radiated test was performed according to FCC PART 15C.
- (2) The tighter limit applies at the band edges.
- (3) Emission level (dBuV/m)=20log Emission level (uV/m).

LIMITS OF RESTRICTED FREQUENCY BANDS

FREQUENCY (MHz)	FREQUENCY (MHz)	FREQUENCY (MHz)	FREQUENCY (GHz)
0.090-0.110	16.42-16.423	399.9-410	4.5-5.15
0.495-0.505	16.69475-16.69525	608-614	5.35-5.46
2.1735-2.1905	16.80425-16.80475	960-1240	7.25-7.75
4.125-4.128	25.5-25.67	1300-1427	8.025-8.5
4.17725-4.17775	37.5-38.25	1435-1626.5	9.0-9.2
4.20725-4.20775	73-74.6	1645.5-1646.5	9.3-9.5
6.215-6.218	74.8-75.2	1660-1710	10.6-12.7
6.26775-6.26825	108-121.94	1718.8-1722.2	13.25-13.4
6.31175-6.31225	123-138	2200-2300	14.47-14.5
8.291-8.294	149.9-150.05	2310-2390	15.35-16.2
8.362-8.366	156.52475-156.52525	2483.5-2500	17.7-21.4
8.37625-8.38675	156.7-156.9	2690-2900	22.01-23.12
8.41425-8.41475	162.0125-167.17	3260-3267	23.6-24.0
12.29-12.293	167.72-173.2	3332-3339	31.2-31.8
12.51975-12.52025	240-285	3345.8-3358	36.43-36.5
12.57675-12.57725	322-335.4	3600-4400	Above 38.6

13.36-13.41			
-------------	--	--	--

For Radiated Emission

Spectrum Parameter	Setting
Attenuation	Auto
Detector	Peak/QP/AV
Start Frequency	9 KHz/150KHz(Peak/QP/AV)
Stop Frequency	150KHz/30MHz(Peak/QP/AV)
RB / VB (emission in restricted band)	200Hz (From 9kHz to 0.15MHz)/ 9KHz (From 0.15MHz to 30MHz); 200Hz (From 9kHz to 0.15MHz)/ 9KHz (From 0.15MHz to 30MHz)

Spectrum Parameter	Setting
Attenuation	Auto
Detector	Peak/QP
Start Frequency	30 MHz(Peak/QP)
Stop Frequency	1000 MHz (Peak/QP)
RB / VB (emission in restricted band)	120 KHz / 300 KHz

Spectrum Parameter	Setting
Attenuation	Auto
Detector	Peak/AV
Start Frequency	1000 MHz(Peak/AV)
Stop Frequency	10th carrier hamonic(Peak/AV)
RB / VB (emission in restricted band)	1 MHz / 3 MHz(Peak) 1 MHz/1/T MHz(AVG)

For Restricted band

Spectrum Parameter	Setting
Detector	Peak/AV
Start/Stop Frequency	Lower Band Edge: 2310 to 2430 MHz Upper Band Edge: 2445 to 2500 MHz
RB / VB	1 MHz / 3 MHz(Peak) 1 MHz/1/T MHz(AVG)

Receiver Parameter	Setting
Start ~ Stop Frequency	9kHz~90kHz / RB 200Hz for PK & AV
Start ~ Stop Frequency	90kHz~110kHz / RB 200Hz for QP
Start ~ Stop Frequency	110kHz~490kHz / RB 200Hz for PK & AV
Start ~ Stop Frequency	490kHz~30MHz / RB 9kHz for QP
Start ~ Stop Frequency	30MHz~1000MHz / RB 120kHz for QP

3.2.2 TEST PROCEDURE

- a. The measuring distance at 3 m shall be used for measurements at frequency 0.009MHz up to 1GHz, and above 1GHz.
- b. The EUT was placed on the top of a rotating table 0.8 m (above 1GHz is 1.5 m) above the ground at a 3 m anechoic chamber test site. The table was rotated 360 degree to determine the position of the highest radiation.
- c. The height of the equipment shall be 0.8 m (above 1GHz is 1.5 m); the height of the test antenna shall vary between 1 m to 4 m. Horizontal and vertical polarization of the antenna are set to make the measurement.
- d. The initial step in collecting conducted emission data is a spectrum analyzer peak detector mode pre-scanning the measurement frequency range. Significant peaks are then marked and QuasiPeak detector mode will be re-measured.
- e. If the Peak Mode measured value is compliance with and lower than Quasi Peak Mode Limit, the EUT shall be deemed to meet QP Limits and no additional QP Mode measurement was performed.
- f. For the actual test configuration, please refer to the related Item –EUT Test Photos.

Note:

Both horizontal and vertical antenna polarities were tested and performed pretest to three orthogonal axis. The worst case emissions were reported.

3.2.3 TEST SETUP

(A) Radiated Emission Test-Up Frequency Below 30MHz

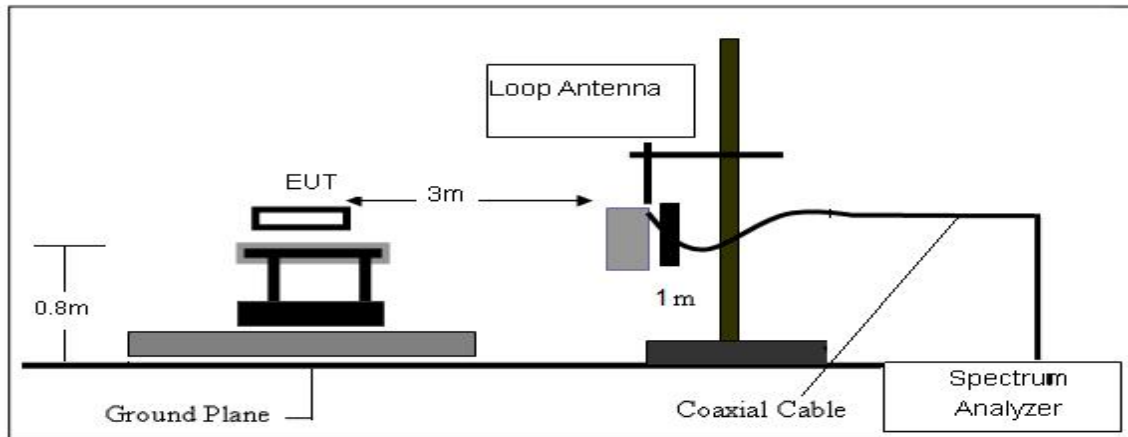

(B) Radiated Emission Test-Up Frequency 30MHz~1GHz

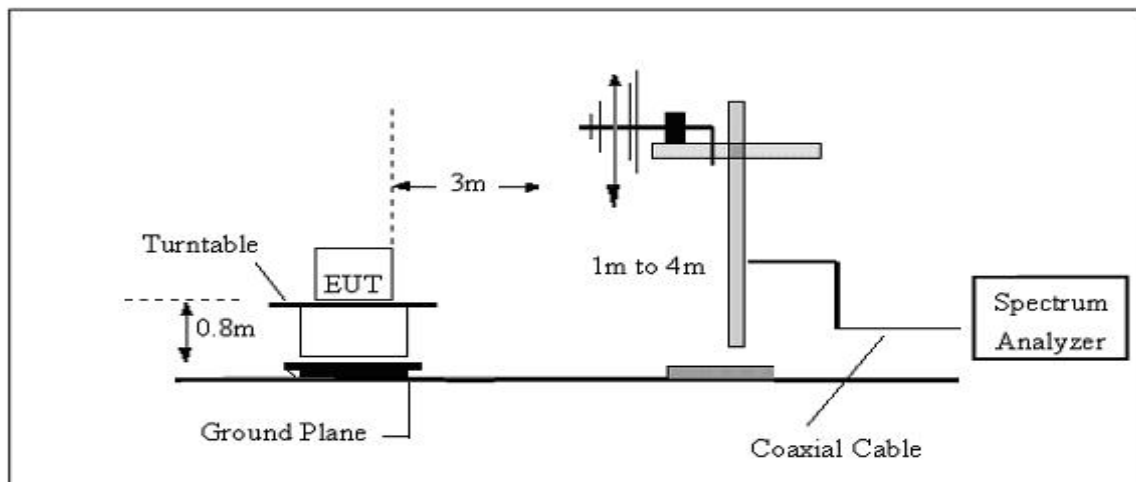

(C) Radiated Emission Test-Up Frequency Above 1GHz

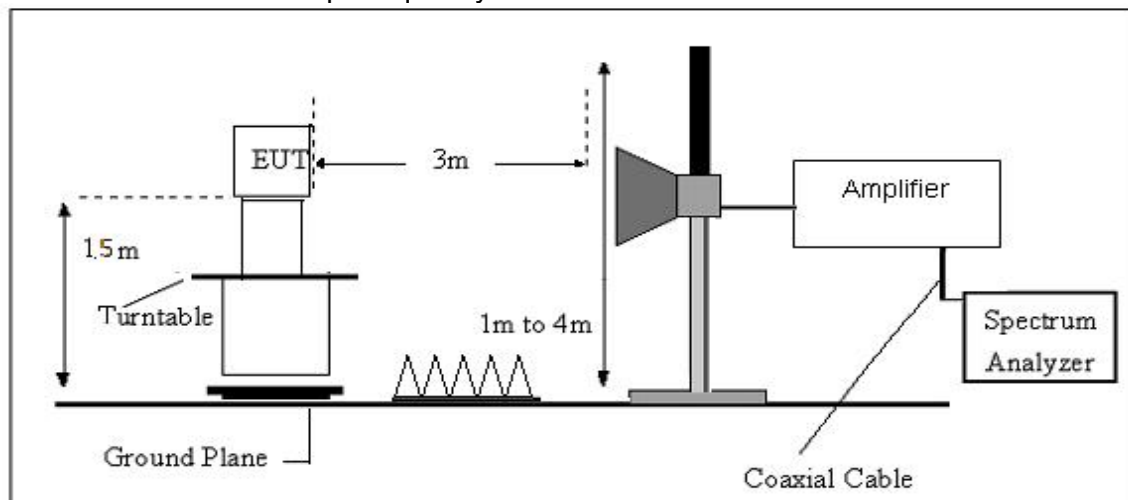

3.2.4 EUT OPERATING CONDITIONS

Please refer to section 3.1.4 of this report.

3.2.5 FIELD STRENGTH CALCULATION

The field strength is calculated by adding the Antenna Factor and Cable Factor and subtracting the Amplifier Gain and Duty Cycle Correction Factor (if any) from the measured reading. The basic equation with a sample calculation is as follows:

$$FS = RA + AF + CL - AG$$

Where

FS = Field Strength

CL = Cable Attenuation Factor (Cable Loss)

RA = Reading Amplitude

AG = Amplifier Gain

AF = Antenna Factor

For example

Frequency	FS	RA	AF	CL	AG	Factor
(MHz)	(dB μ V/m)	(dB μ V/m)	(dB)	(dB)	(dB)	(dB)
300	40	58.1	12.2	1.6	31.9	-18.1

3.2.6 TEST RESULT

We have scanned the 10th harmonic from 9KHz to the EUT' s highest frequency.

Detailed information please see the following page.

From 9KHz to 30MHz Conclusion: PASS

Note: The amplitude of spurious emissions which are attenuated by more than 20dB below the permissible value has no need to be reported.

30-1G Remark: All modes have been tested, and only worst data of 802.11 B mode, Channel 2412MHz was listed in this report.

1-18G Remark: All modes have been tested, and only worst data of 802.11 B mode, was listed in this report.

Test Mode: Mode1

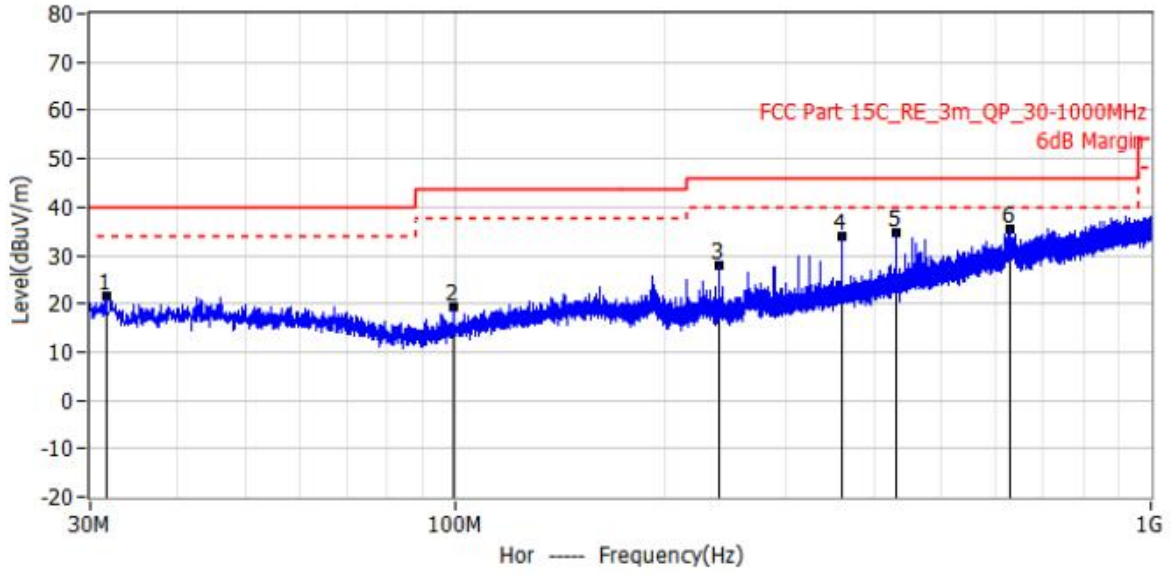

No.	Frequency	Reading dBuV	Factor dB/m	Level dBuV/m	Limit dBuV/m	Delta dB	Detector	Polar	Height cm	Angle deg
1*	31.680MHz	8.4	13.1	21.5	40.0	-18.5	QP	Hor	100.0	60.0
2*	99.660MHz	8.9	10.5	19.4	43.5	-24.1	QP	Hor	100.0	65.0
3*	239.880MHz	14.8	13.3	28.1	46.0	-17.9	QP	Hor	100.0	75.0
4*	359.760MHz	16.9	17.1	34.0	46.0	-12.0	QP	Hor	100.0	164.0
5*	431.640MHz	15.8	18.8	34.6	46.0	-11.4	QP	Hor	100.0	0.0
6*	629.280MHz	12.0	23.6	35.6	46.0	-10.4	QP	Hor	100.0	108.0

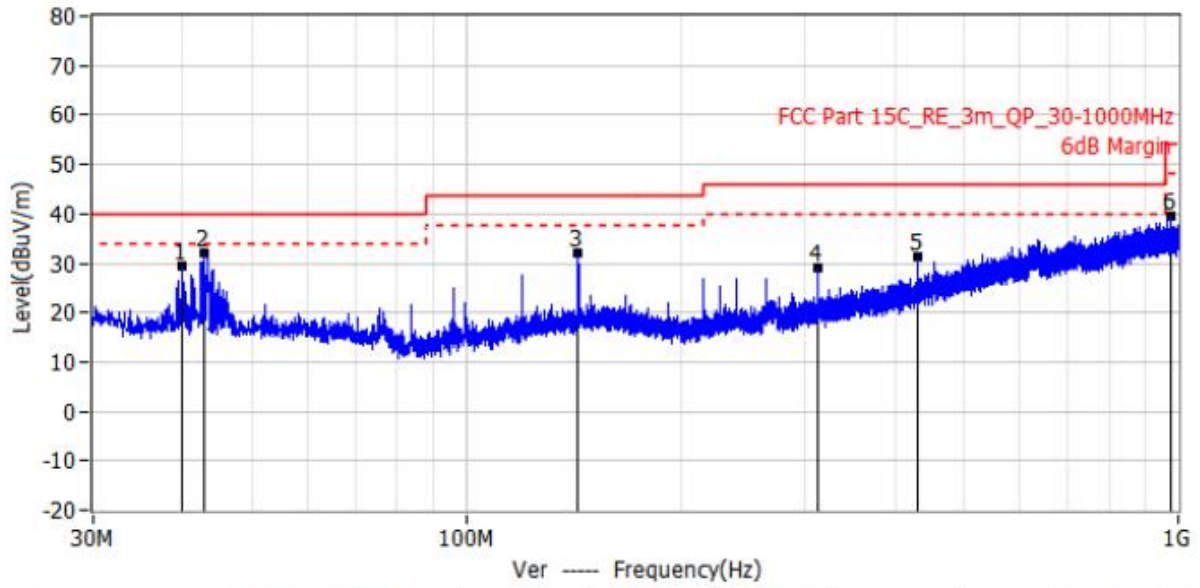

No.	Frequency	Reading dBuV	Factor dB/m	Level dBuV/m	Limit dBuV/m	Delta dB	Detector	Polar	Height cm	Angle deg
1*	40.020MHz	15.0	14.3	29.3	40.0	-10.7	QP	Ver	100.0	136.0
2*	42.900MHz	18.0	14.2	32.2	40.0	-7.8	QP	Ver	100.0	0.0
3*	143.880MHz	18.0	14.0	32.0	43.5	-11.5	QP	Ver	100.0	0.0
4*	311.700MHz	13.2	15.7	28.9	46.0	-17.1	QP	Ver	100.0	195.0
5*	431.640MHz	12.5	18.8	31.3	46.0	-14.7	QP	Ver	100.0	106.0
6*	977.940MHz	11.0	28.5	39.5	54.0	-14.5	QP	Ver	100.0	299.0

Test Mode: Mode1

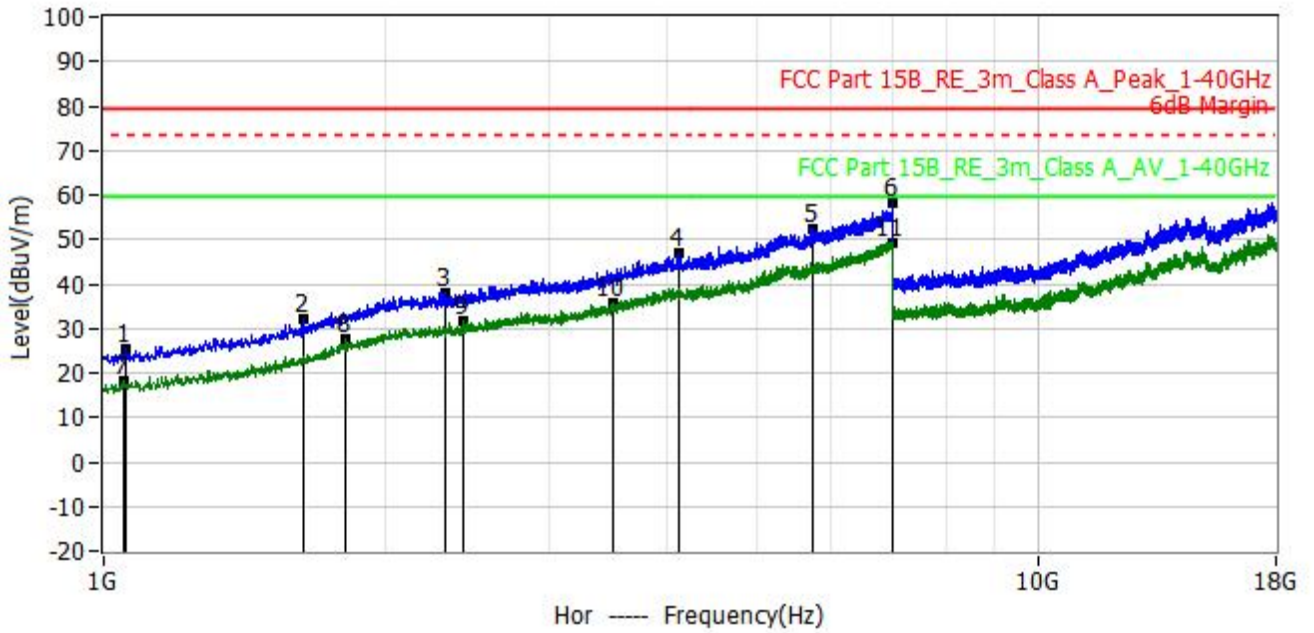

No.	Frequency	Reading dBuV	Factor dB/m	Level dBuV/m	Limit dBuV/m	Delta dB	Detector	Polar	Height cm	Angle deg
1*	1.053GHz	36.25	-10.95	25.29	79.50	-54.21	PK	Hor	100.0	240.0
2*	1.637GHz	37.29	-5.10	32.19	79.50	-47.31	PK	Hor	100.0	358.0
3*	2.316GHz	37.38	0.62	38.00	79.50	-41.50	PK	Hor	200.0	187.0
4*	4.122GHz	40.47	6.35	46.82	79.50	-32.68	PK	Hor	200.0	22.0
5*	5.755GHz	42.10	10.38	52.48	79.50	-27.02	PK	Hor	200.0	53.0
6*	6.985GHz	44.70	13.29	57.99	79.50	-21.51	PK	Hor	200.0	149.0
7*	1.049GHz	29.34	-11.01	18.33	59.50	-41.17	AV	Hor	100.0	72.0
8*	1.818GHz	30.60	-2.88	27.72	59.50	-31.78	AV	Hor	100.0	118.0
9*	2.422GHz	30.50	1.08	31.58	59.50	-27.92	AV	Hor	200.0	176.0
10*	3.512GHz	31.79	4.00	35.79	59.50	-23.71	AV	Hor	200.0	267.0
11*	6.991GHz	36.10	13.30	49.40	59.50	-10.10	AV	Hor	200.0	26.0

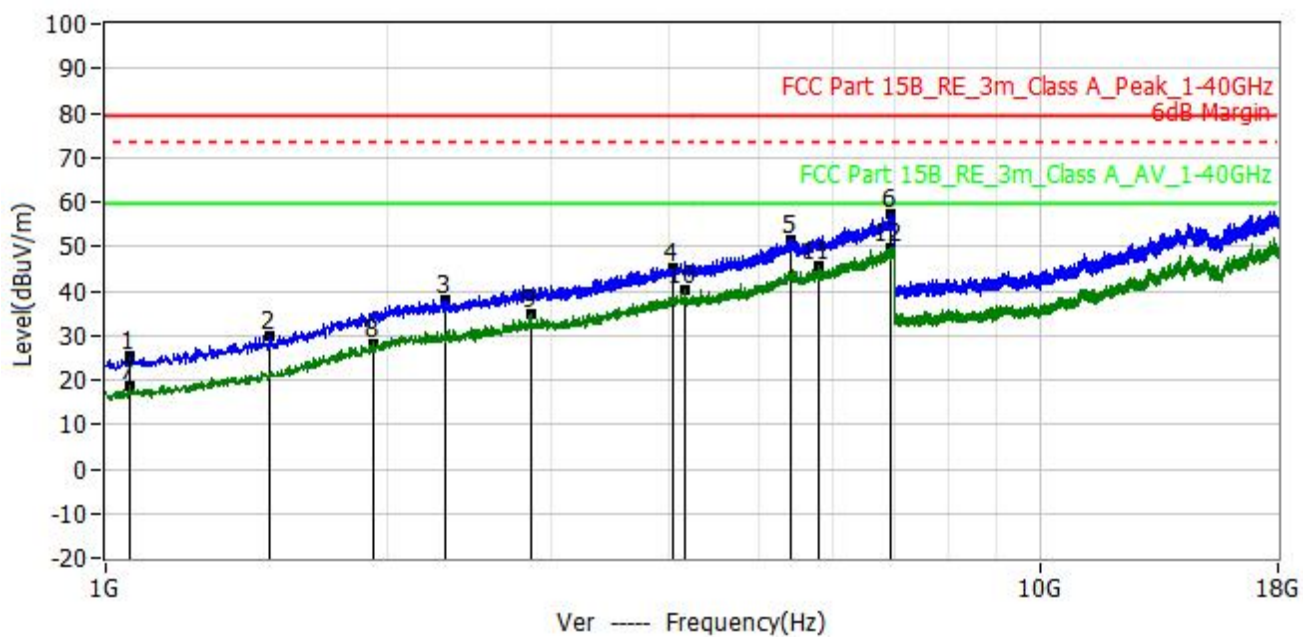

No.	Frequency	Reading dBuV	Factor dB/m	Level dBuV/m	Limit dBuV/m	Delta dB	Detector	Polar	Height cm	Angle deg
1*	1.060GHz	36.00	-10.84	25.16	79.50	-54.34	PK	Ver	100.0	290.0
2*	1.493GHz	36.99	-6.91	30.08	79.50	-49.42	PK	Ver	100.0	245.0
3*	2.314GHz	37.23	0.61	37.84	79.50	-41.66	PK	Ver	200.0	0.0
4*	4.052GHz	39.22	6.16	45.38	79.50	-34.12	PK	Ver	200.0	49.0
5*	5.415GHz	41.80	9.77	51.57	79.50	-27.93	PK	Ver	200.0	128.0
6*	6.935GHz	44.32	13.18	57.50	79.50	-22.00	PK	Ver	200.0	331.0
7*	1.063GHz	29.68	-10.84	18.84	59.50	-40.66	AV	Ver	100.0	344.0
8*	1.933GHz	29.61	-1.46	28.15	59.50	-31.35	AV	Ver	100.0	298.0
9*	2.848GHz	32.61	2.32	34.93	59.50	-24.57	AV	Ver	200.0	290.0
10*	4.161GHz	33.91	6.38	40.29	59.50	-19.21	AV	Ver	200.0	66.0
11*	5.789GHz	35.32	10.48	45.80	59.50	-13.70	AV	Ver	200.0	0.0
12*	6.937GHz	36.46	13.18	49.64	59.50	-9.86	AV	Ver	200.0	331.0

Test Mode: Mode2

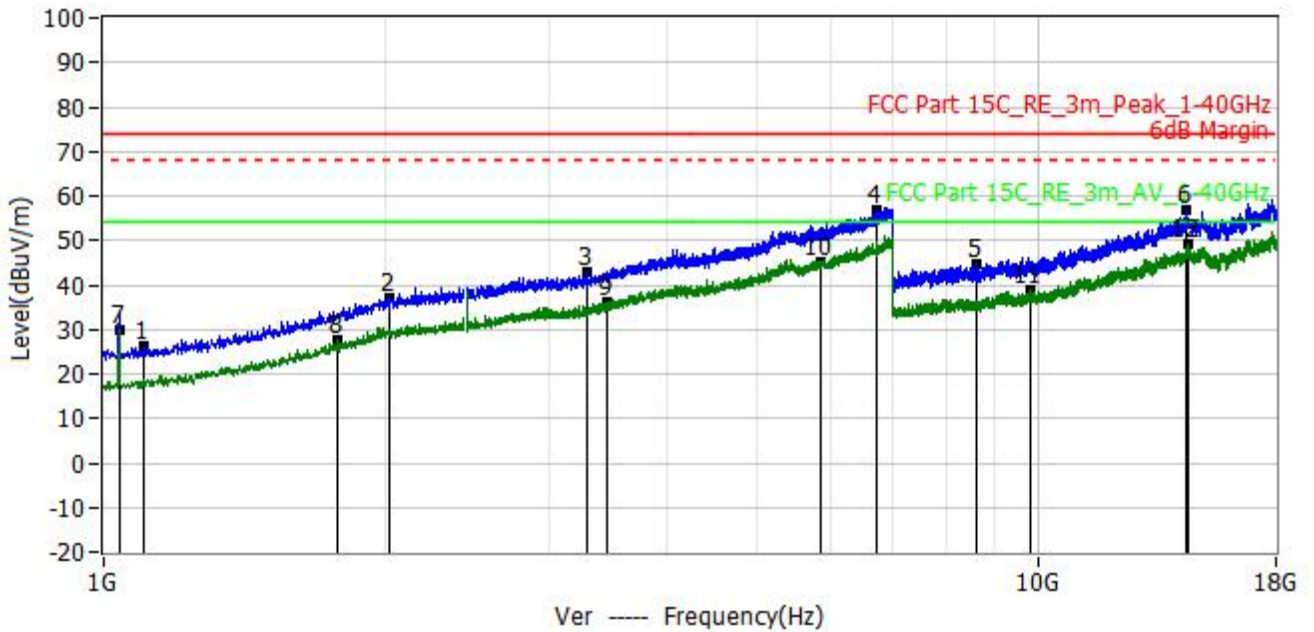

No.	Frequency	Reading dBuV	Factor dB/m	Level dBuV/m	Limit dBuV/m	Delta dB	Detector	Polar	Height cm	Angle deg
1*	1.105GHz	36.65	-10.53	26.12	74.00	-47.88	PK	Ver	100.0	147.0
2*	2.017GHz	37.81	-0.55	37.26	74.00	-36.73	PK	Ver	100.0	107.0
3*	3.288GHz	39.47	3.46	42.93	74.00	-31.07	PK	Ver	200.0	255.0
4*	6.707GHz	44.21	12.68	56.89	74.00	-17.11	PK	Ver	200.0	330.0
5*	8.614GHz	39.59	5.16	44.75	74.00	-29.25	PK	Ver	200.0	237.0
6*	14.399GHz	42.75	13.92	56.67	74.00	-17.33	PK	Ver	200.0	147.0
7*	1.039GHz	40.78	-11.09	29.69	54.00	-24.31	AV	Ver	100.0	195.0
8*	1.782GHz	30.84	-3.31	27.53	54.00	-26.47	AV	Ver	100.0	240.0
9*	3.452GHz	32.18	3.80	35.98	54.00	-18.02	AV	Ver	200.0	176.0
10*	5.847GHz	34.67	10.64	45.31	54.00	-8.69	AV	Ver	200.0	217.0
11*	9.809GHz	33.02	5.75	38.77	54.00	-15.23	AV	Ver	200.0	120.0
12*	14.506GHz	35.25	13.88	49.13	54.00	-4.87	AV	Ver	200.0	195.0

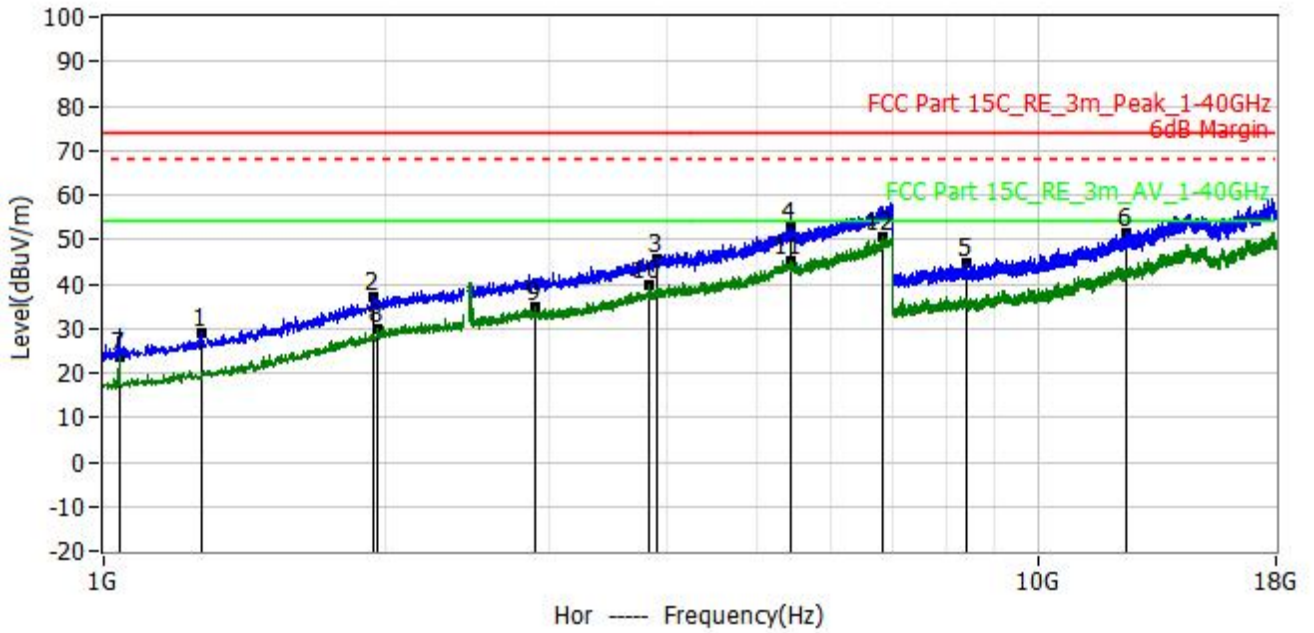

No.	Frequency	Reading dBuV	Factor dB/m	Level dBuV/m	Limit dBuV/m	Delta dB	Detector	Polar	Height cm	Angle deg
1*	1.270GHz	37.70	-8.93	28.77	74.00	-45.23	PK	Hor	100.0	122.0
2*	1.940GHz	38.24	-1.35	36.89	74.00	-37.11	PK	Hor	100.0	50.0
3*	3.917GHz	39.83	5.80	45.63	74.00	-28.37	PK	Hor	200.0	279.0
4*	5.427GHz	42.97	9.84	52.81	74.00	-21.19	PK	Hor	200.0	122.0
5*	8.374GHz	39.60	4.99	44.59	74.00	-29.41	PK	Hor	200.0	79.0
6*	12.442GHz	40.84	10.46	51.30	74.00	-22.70	PK	Hor	200.0	298.0
7*	1.039GHz	34.77	-11.09	23.68	54.00	-30.32	AV	Hor	100.0	50.0
8*	1.966GHz	30.98	-1.10	29.88	54.00	-24.12	AV	Hor	100.0	114.0
9*	2.894GHz	32.15	2.49	34.64	54.00	-19.36	AV	Hor	200.0	61.0
10*	3.844GHz	34.39	5.48	39.87	54.00	-14.13	AV	Hor	200.0	0.0
11*	5.448GHz	35.48	9.90	45.38	54.00	-8.62	AV	Hor	200.0	218.0
12*	6.840GHz	37.80	12.97	50.77	54.00	-3.23	AV	Hor	200.0	129.0

Test Mode: Mode3

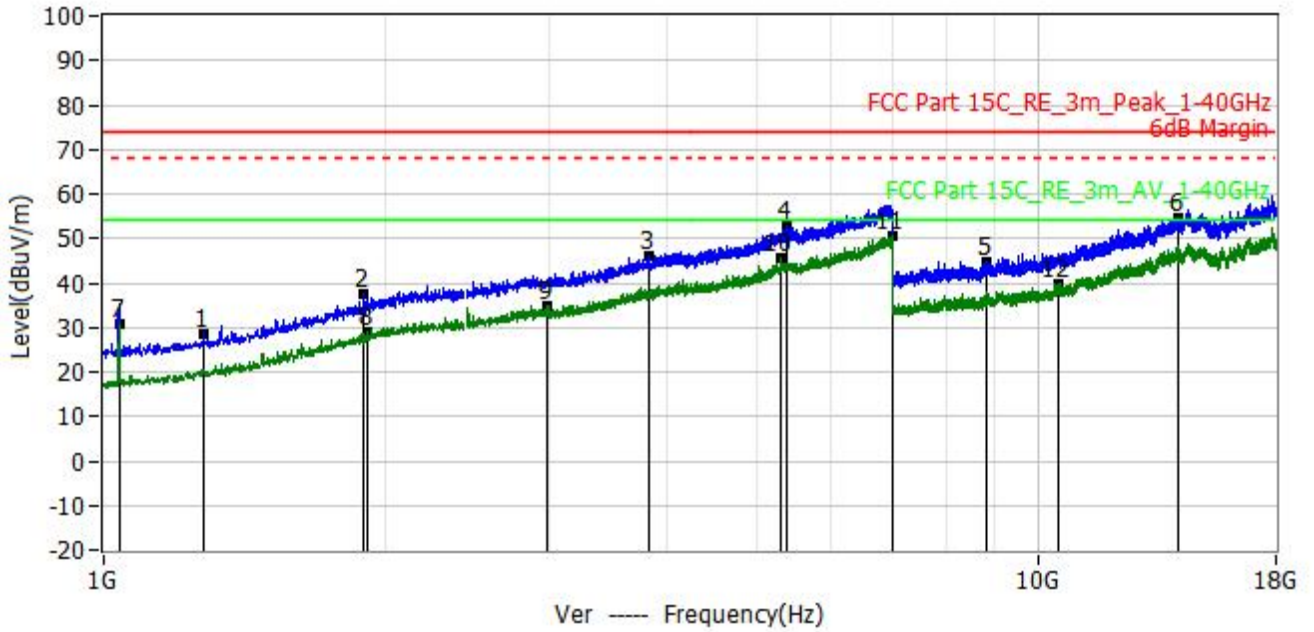

No.	Frequency	Reading dBuV	Factor dB/m	Level dBuV/m	Limit dBuV/m	Delta dB	Detector	Polar	Height cm	Angle deg
1*	1.281GHz	37.47	-8.85	28.62	74.00	-45.38	PK	Ver	100.0	146.0
2*	1.896GHz	39.49	-1.96	37.53	74.00	-36.47	PK	Ver	100.0	0.0
3*	3.827GHz	40.41	5.44	45.85	74.00	-28.15	PK	Ver	200.0	220.0
4*	5.388GHz	43.15	9.63	52.78	74.00	-21.22	PK	Ver	200.0	157.0
5*	8.807GHz	39.24	5.33	44.57	74.00	-29.43	PK	Ver	200.0	71.0
6*	14.127GHz	40.72	14.00	54.72	74.00	-19.28	PK	Ver	200.0	174.0
7*	1.039GHz	42.00	-11.09	30.91	54.00	-23.09	AV	Ver	100.0	185.0
8*	1.920GHz	30.52	-1.67	28.85	54.00	-25.15	AV	Ver	100.0	123.0
9*	2.984GHz	31.98	2.77	34.75	54.00	-19.25	AV	Ver	200.0	112.0
10*	5.298GHz	36.25	9.25	45.50	54.00	-8.50	AV	Ver	200.0	249.0
11*	6.990GHz	37.17	13.30	50.47	54.00	-3.53	AV	Ver	200.0	207.0
12*	10.524GHz	33.02	6.83	39.85	54.00	-14.15	AV	Ver	200.0	0.0

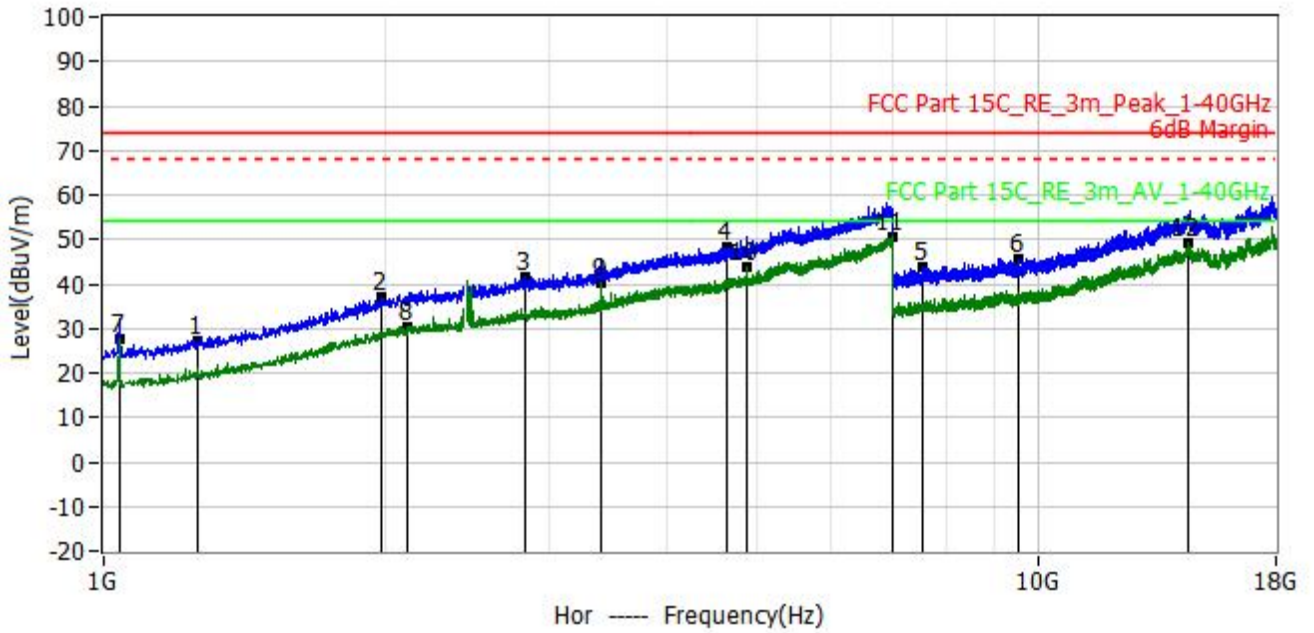

No.	Frequency	Reading dBuV	Factor dB/m	Level dBuV/m	Limit dBuV/m	Delta dB	Detector	Polar	Height cm	Angle deg
1*	1.262GHz	36.35	-9.00	27.35	74.00	-46.65	PK	Hor	100.0	144.0
2*	1.986GHz	37.77	-0.83	36.94	74.00	-37.10	PK	Hor	100.0	266.0
3*	2.828GHz	39.20	2.28	41.48	74.00	-32.52	PK	Hor	200.0	38.0
4*	4.652GHz	40.78	7.34	48.12	74.00	-25.88	PK	Hor	200.0	288.0
5*	7.532GHz	39.35	4.35	43.70	74.00	-30.30	PK	Hor	200.0	159.0
6*	9.514GHz	40.10	5.69	45.79	74.00	-28.21	PK	Hor	200.0	34.0
7*	1.039GHz	38.55	-11.09	27.46	54.00	-26.54	AV	Hor	100.0	49.0
8*	2.110GHz	30.79	-0.23	30.56	54.00	-23.44	AV	Hor	100.0	344.0
9*	3.407GHz	36.37	3.66	40.03	54.00	-13.97	AV	Hor	200.0	0.0
10*	4.873GHz	36.00	7.93	43.93	54.00	-10.07	AV	Hor	200.0	6.0
11*	6.990GHz	37.37	13.30	50.67	54.00	-3.33	AV	Hor	200.0	259.0
12*	14.508GHz	35.13	13.88	49.01	54.00	-4.99	AV	Hor	200.0	125.0

4. CONDUCTED SPURIOUS & BAND EDGE EMISSION

4.1 LIMIT

According to FCC section 15.247(d), in any 100kHz bandwidth outside the frequency band in which the spread spectrum or digitally modulated intentional radiator is operating, the radio frequency power that is produced by the intentional radiator shall be at least 20dB below that in the 100kHz bandwidth within the band that contains the highest level of the desired power, based on either an RF conducted or a radiated measurement.

4.2 TEST PROCEDURE

Spectrum Parameter	Setting
Detector	Peak
Start/Stop Frequency	30 MHz to 10th carrier harmonic
RB / VB (emission in restricted band)	100 KHz/300 KHz
Trace-Mode:	Max hold

For Band edge

Spectrum Parameter	Setting
Detector	Peak
Start/Stop Frequency	Lower Band Edge: 2300 to 2432 MHz Upper Band Edge: 2442 to 2500 MHz
RB / VB (emission in restricted band)	100 KHz/300 KHz
Trace-Mode:	Max hold

4.3 DEVIATION FROM STANDARD

No deviation.

4.4 TEST SETUP



The EUT which is powered by the { Power }, is connected to the Spectrum Analyzer; the RF load attached to the EUT antenna terminal is 50Ohm; the path loss as the factor is calibrated to correct the reading.

Make the measurement with the spectrum analyzer's resolution bandwidth (RBW) = 100 kHz. In order to make an accurate measurement, set the span greater than RBW.

4.5 EUT OPERATION CONDITIONS

Please refer to section 3.1.4 of this report.

4.6 TEST RESULTS

For the measurement records · refer to the appendix I.

5. POWER SPECTRAL DENSITY TEST

5.1 LIMIT

FCC Part15.247 , Subpart C				
Section	Test Item	Limit	Frequency Range (MHz)	Result
15.247(e)	Power Spectral Density	≤ 8 dBm (RBW ≥ 3 KHz)	2400-2483.5	PASS

5.2 TEST PROCEDURE

1. Set analyzer center frequency to DTS channel center frequency.
2. Set the span to 1.5 times the DTS channel bandwidth.
3. Set the $100 \text{ kHz} \geq \text{RBW} \geq 3 \text{ kHz}$.
4. Set the $\text{VBW} \geq 3 \times \text{RBW}$.
5. Detector = peak.
6. Sweep time = auto couple.
7. Trace mode = max hold.
8. Allow trace to fully stabilize.
9. Use the peak marker function to determine the maximum amplitude level.
10. If measured value exceeds limit, reduce RBW (no less than 3 kHz) and repeat.

5.3 DEVIATION FROM STANDARD

No deviation.

5.4 TEST SETUP



5.5 EUT OPERATION CONDITIONS

Please refer to section 3.1.4 of this report.

5.6 TEST RESULTS

For the measurement records · refer to the appendix I.

6. BANDWIDTH TEST

6.1 LIMIT

FCC Part 15.247, Subpart C				
Section	Test Item	Limit	Frequency Range (MHz)	Result
15.247(a)(2)	Bandwidth	$\geq 500\text{KHz}$ (6dB bandwidth)	2400-2483.5	PASS

6.2 TEST PROCEDURE

The automatic bandwidth measurement capability of an instrument may be employed using the X dB bandwidth mode with X set to 6 dB, if the functionality described above (i.e., RBW = 100 kHz, VBW ≥ 3 RBW, peak detector with maximum hold) is implemented by the instrumentation function. When using this capability, care shall be taken so that the bandwidth measurement is not influenced by any intermediate power nulls in the fundamental emission that might be ≥ 6 dB.

6.3 DEVIATION FROM STANDARD

No deviation.

6.4 TEST SETUP



6.5 EUT OPERATION CONDITIONS

Please refer to section 3.1.4 of this report.

6.6 TEST RESULTS

For the measurement records · refer to the appendix I.

7. PEAK OUTPUT POWER TEST

7.1 LIMIT

FCC Part15.247,Subpart C				
Section	Test Item	Limit	Frequency Range (MHz)	Result
15.247(b)(3)	Output Power	1 watt or 30dBm	2400-2483.5	PASS

7.2 TEST PROCEDURE

One of the following procedures may be used to determine the maximum peak conducted output power of a DTS EUT.

RBW \geq DTS bandwidth

The following procedure shall be used when an instrument with a resolution bandwidth that is greater than the DTS bandwidth is available to perform the measurement:

- Set the RBW \geq DTS bandwidth.
- Set VBW \geq [3 \times RBW].
- Set span \geq [3 \times RBW].
- Sweep time = auto couple.
- Detector = peak.
- Trace mode = max hold.
- Allow trace to fully stabilize.
- Use peak marker function to determine the peak amplitude level.

Integrated band power method:

The following procedure can be used when the maximum available RBW of the instrument is less than the

DTS bandwidth:

- Set the RBW = 1 MHz.
- Set the VBW \geq [3 \times RBW].
- Set the span \geq [1.5 \times DTS bandwidth].
- Detector = peak.
- Sweep time = auto couple.
- Trace mode = max hold.
- Allow trace to fully stabilize.
- Use the instrument's band/channel power measurement function with the band limits set equal to the DTS bandwidth edges (for some instruments, this may require a manual override to select the peak detector). If the instrument does not have a band power function, then sum the spectrum levels (in linear power units) at intervals equal to the RBW extending across the DTS channel bandwidth.

PKPM1 Peak power meter method:

The maximum peak conducted output power may be measured using a broadband peak RF power meter. The power meter shall have a video bandwidth that is greater than or equal to the DTS bandwidth and shall use a fast-responding diode detector.

7.3 DEVIATION FROM STANDARD

No deviation.

7.4 TEST SETUP

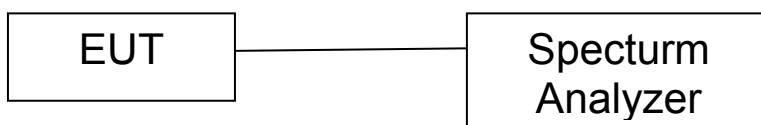

7.5 EUT OPERATION CONDITIONS

Please refer to section 3.1.4 of this report.

7.6 TEST RESULTS

For the measurement records · refer to the appendix I.

8.BAND EDGE CHECK

8.1 TEST LIMITS

Please refer RSS-GEN & FCC PART 15: 15.247

All the lower and upper band-edges emissions appearing within 2310MHz to 2390MHz and 2483.5MHz to 2500MHz restricted frequency bands shall not exceed the limits shown in 15.209, all the other emissions outside operation frequency band 2400MHz to 2483.5MHz shall be at least 20dB below the fundamental emissions, or comply with 15.209 limits and RSS-GEN limits.

8.2 TEST PROCEDURE

Details see the KDB558074 D01 Meas Guidance v05r02

8.2.1 Put the EUT on a 1.5m high table, power on the EUT. Emissions were scanned and measured rotating the EUT to 360 degrees, Find the maximum Emission

8.2.2 Check the spurious emissions out of band.

8.2.3 RBW 1MHz, VBW 3MHz, peak detector for peak value, RBW 1MHz, VBW 10Hz, RMS detector for AV value.

8.3 TEST SETUP

Same as 5.2.2.

8.4 TEST RESULTS

PASS.

Detailed information please see the following page.

Radiated Method:

Test Mode: IEEE 802.11b-Low

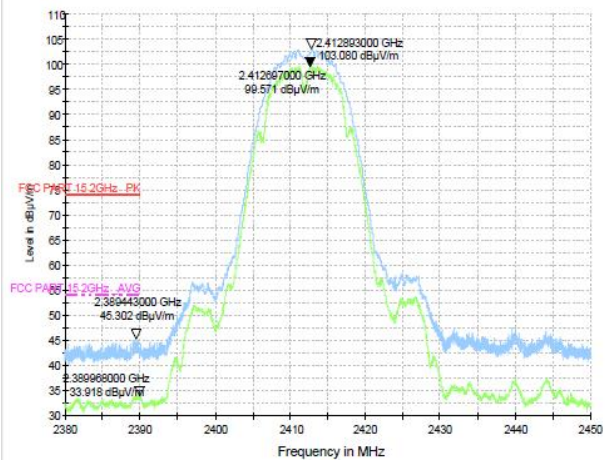

Test Mode: IEEE 802.11b-High

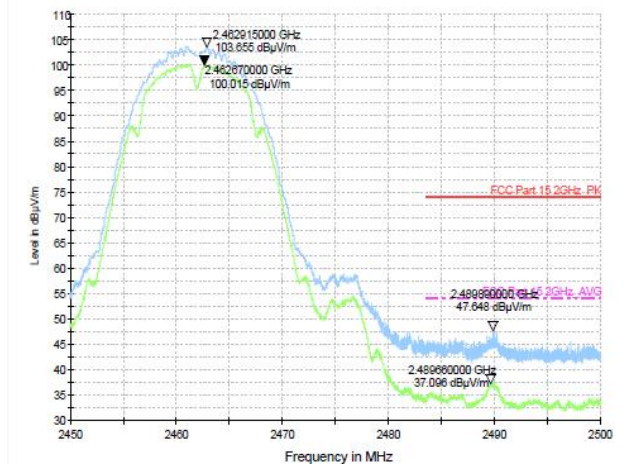

Test Mode: IEEE 802.11g-Low

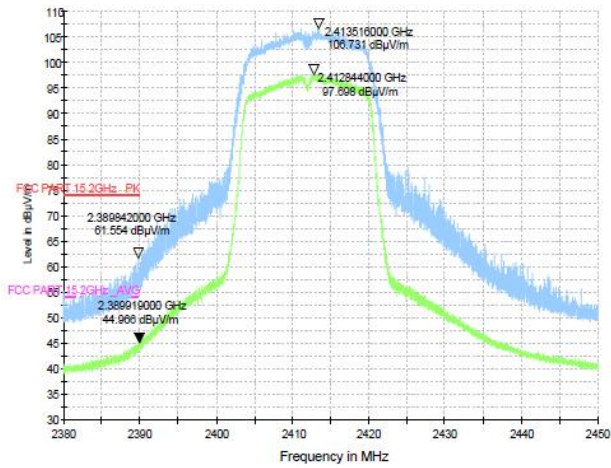

Test Mode: IEEE 802.11g-High

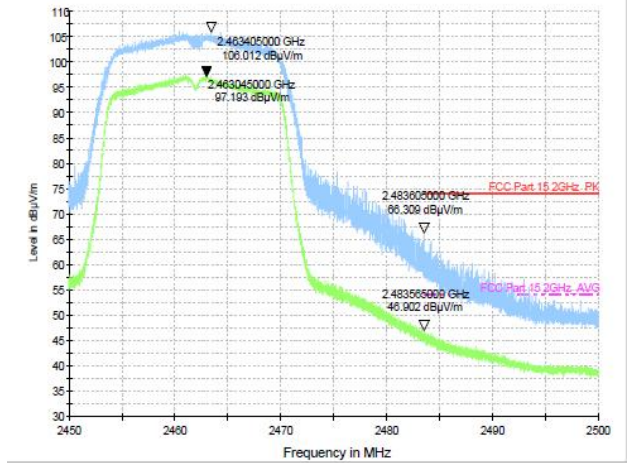

Test Mode: IEEE 802.11n20-Low

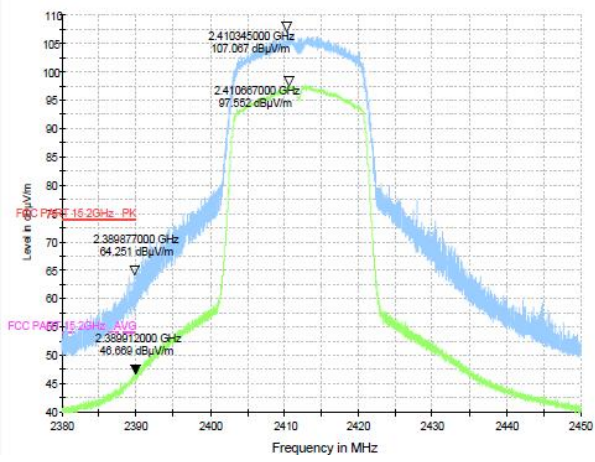

Test Mode: IEEE 802.11n20-High

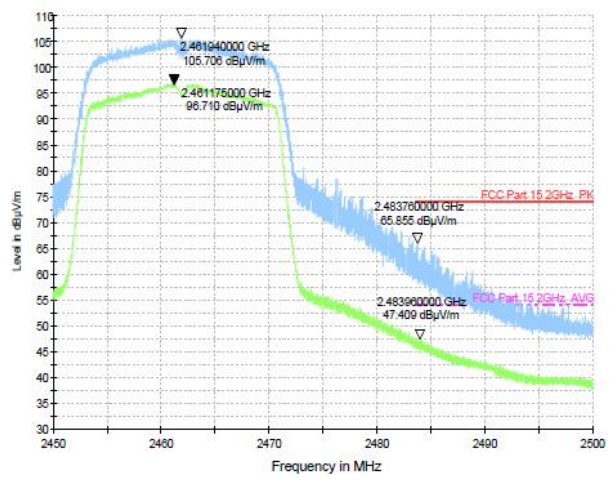

Test Mode: IEEE 802.11n40-Low

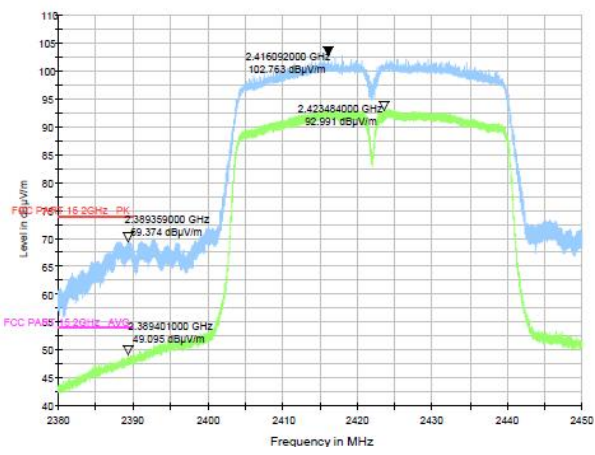

Test Mode: IEEE 802.11n40-High

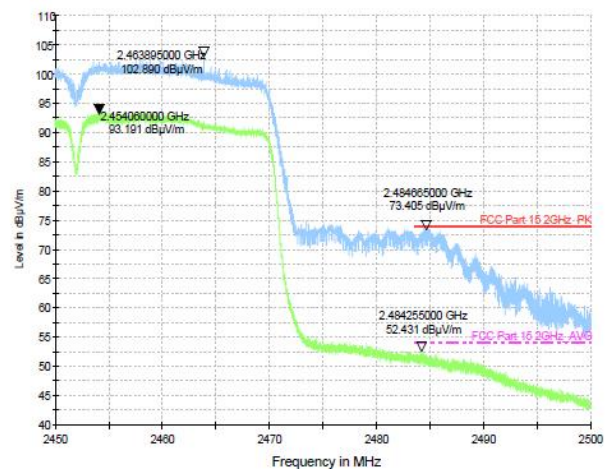

Conducted Method:

For the measurement records · refer to the appendix I.

9. ANTENNA REQUIREMENT

9.1 STANDARD REQUIREMENT

15.203 requirement: For intentional device, according to 15.203: an intentional radiator shall be designed to ensure that no antenna other than that furnished by the responsible party shall be used with the device.

9.2 EUT ANTENNA

The EUT antenna is External antenna. It comply with the standard requirement.

APPENDIX I:TEST RESULTS

Please refer to separated files for APPENDIX I TEST RESULTS.

APPENDIX II: External Photos

Please refer to separated files for APPENDIX II .

APPENDIX III: Internal Photos

Please refer to separated files for APPENDIX III .

APPENDIX IV: Test Setup Photos

Please refer to separated files for APPENDIX IV Test Setup Photos.