



FCC RADIO TEST REPORT

FCC ID: 2ACOE-WG209

Product : wifi module

Trade Name : SKYLAB

Model Name : WG209

Serial Model : N/A

Report No. : NTEK-2014NT0612909F

Prepared for

Skylab M&C Technology Co.,Ltd.

9th Floor,zhongguang Building,Yayuan Road,Bantian,Shenzhen

Prepared by

Shenzhen NTEK Testing Technology Co., Ltd.

1/F, Building E, Fenda Science Park, Sanwei Community, Xixiang Street
Bao'an District, Shenzhen P.R. China

Tel.: +86-0755-61156588 Fax.: +86-0755-61156599

Website:www.ntek.org.cn

TEST RESULT CERTIFICATION

Applicant's name Skylab M&C Technology Co.,Ltd.
Address 9th Floor,zhongguang Building,Yayuan Road,Bantian,Shenzhen
Manufacturer's Name... Skylab M&C Technology Co.,Ltd.
Address 9th Floor,zhongguang Building,Yayuan Road,Bantian,Shenzhen

Product description

Product name wifi module
Model and/or type reference WG209
Serial Model N/A

Standards FCC Part15.247 Oct. 1, 2013

Test procedure ANSI C63.4-2003 and 558074 D01 DTS Meas Guidance v03r02

This device described above has been tested by NTEK, and the test results show that the equipment under test (EUT) is in compliance with the FCC requirements. And it is applicable only to the tested sample identified in the report.

This report shall not be reproduced except in full, without the written approval of NTEK, this document may be altered or revised by NTEK, personal only, and shall be noted in the revision of the document.

Date of Test

Date (s) of performance of tests 12 Jun. 2014 ~26 Jun. 2014

Date of Issue..... 26 Jun. 2014

Test Result..... **Pass**

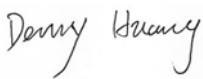
Testing Engineer : 
Denny Huang

Technical Manager : 
(Brown Lu)

Authorized Signatory : 
(Bill Yao)

Table of Contents

	Page
1 . SUMMARY OF TEST RESULTS	5
1.1 TEST FACILITY	6
1.2 MEASUREMENT UNCERTAINTY	6
2 . GENERAL INFORMATION	7
2.1 GENERAL DESCRIPTION OF EUT	7
2.2 DESCRIPTION OF TEST MODES	9
2.3 BLOCK DIGRAM SHOWING THE CONFIGURATION OF SYSTEM TESTED	10
2.4 DESCRIPTION OF SUPPORT UNITS(CONDUCTED MODE)	11
2.5 EQUIPMENTS LIST FOR ALL TEST ITEMS	12
3 . EMC EMISSION TEST	13
3.1 CONDUCTED EMISSION MEASUREMENT	13
3.1.1 POWER LINE CONDUCTED EMISSION LIMITS	13
3.1.2 TEST PROCEDURE	14
3.1.3 DEVIATION FROM TEST STANDARD	14
3.1.4 TEST SETUP	14
3.1.5 EUT OPERATING CONDITIONS	14
3.1.6 TEST RESULTS	15
3.2 RADIATED EMISSION MEASUREMENT	17
3.2.1 RADIATED EMISSION LIMITS	17
3.2.2 TEST PROCEDURE	18
3.2.3 DEVIATION FROM TEST STANDARD	18
3.2.4 TEST SETUP	19
3.2.5 EUT OPERATING CONDITIONS	20
3.2.6 TEST RESULTS (BETWEEN 9KHZ – 30 MHZ)	21
3.2.7 TEST RESULTS (BETWEEN 30MHZ – 1GHZ)	22
3.2.8 TEST RESULTS (ABOVE 1000 MHZ)	23
4 . POWER SPECTRAL DENSITY TEST	36
4.1 APPLIED PROCEDURES / LIMIT	36
4.1.1 TEST PROCEDURE	36
4.1.2 DEVIATION FROM STANDARD	36
4.1.3 TEST SETUP	36
4.1.4 EUT OPERATION CONDITIONS	36
4.1.5 TEST RESULTS	37
5 . BANDWIDTH TEST	45
5.1 APPLIED PROCEDURES / LIMIT	45
5.1.1 TEST PROCEDURE	45

Table of Contents

	Page
TEST SETUP	45
5.1.2 EUT OPERATION CONDITIONS	45
5.1.3 TEST RESULTS	46
6 . PEAK OUTPUT POWER TEST	54
6.1 APPLIED PROCEDURES / LIMIT	54
6.1.1 TEST PROCEDURE	54
6.1.2 DEVIATION FROM STANDARD	54
6.1.3 TEST SETUP	54
6.1.4 EUT OPERATION CONDITIONS	54
6.1.5 TEST RESULTS	55
7 . 100 KHZ BANDWIDTH OF FREQUENCY BAND EDGE	56
7.1 DEVIATION FROM STANDARD	56
7.2 TEST SETUP	56
7.3 EUT OPERATION CONDITIONS	56
7.4 TEST RESULTS	57
8 . ANTENNA REQUIREMENT	63
8.1 STANDARD REQUIREMENT	63
8.2 EUT ANTENNA	63
9 . EUT TEST PHOTO	64
APPENDIX-PHOTOGRAPHS OF EUT CONSTRUCTIONAL DETAILS	

1. SUMMARY OF TEST RESULTS

Test procedures according to the technical standards:

FCC Part15 (15.247) , Subpart C			
Standard Section	Test Item	Judgment	Remark
15.207	Conducted Emission	PASS	
15.247 (a)(2)	6dB Bandwidth	PASS	
15.247 (b)	Peak Output Power	PASS	
15.247 (c)	Radiated Spurious Emission	PASS	
15.247 (d)	Power Spectral Density	PASS	
15.205	Band Edge Emission	PASS	
15.203	Antenna Requirement	PASS	

NOTE:

(1) "N/A" denotes test is not applicable in this Test Report

1.1 TEST FACILITY

NTEK Testing Technology Co., Ltd
 Add.:1/F, Building E, Fenda Science Park, Sanwei Community, Xixiang Street, Bao'an District, Shenzhen P.R. China.
 FCC Registration No.:238937; IC Registration No.:9270A-1
 CNAS Registration No.:L5516

1.2 MEASUREMENT UNCERTAINTY

The reported uncertainty of measurement $y \pm U$, where expanded uncertainty U is based on a standard uncertainty multiplied by a coverage factor of $k=2$, providing a level of confidence of approximately 95 %.

No.	Item	Uncertainty
1	Conducted Emission Test	$\pm 1.38\text{dB}$
2	RF power,conducted	$\pm 0.16\text{dB}$
3	Spurious emissions,conducted	$\pm 0.21\text{dB}$
4	All emissions,radiated(<1G)	$\pm 4.68\text{dB}$
5	All emissions,radiated(>1G)	$\pm 4.89\text{dB}$
6	Temperature	$\pm 0.5^\circ\text{C}$
7	Humidity	$\pm 2\%$

2. GENERAL INFORMATION

2.1 GENERAL DESCRIPTION OF EUT

Equipment	wifi module	
Trade Name	SKYLAB	
Model Name	WG209	
Serial Model	N/A	
Model Difference	N/A	
Product Description	The EUT is a wifi module	
	Operation Frequency:	802.11b/g/n(20MHz): 2412~2462MHz 802.11n(40MHz):2422~2452MHz
	Modulation Type:	CCK/OFDM/DBPSK/DAPSK
	Bit Rate of Transmitter	802.11b:11/5.5/2/1 Mbps 802.11g:54/48/36/24/18/12/9/6Mbps 802.11n(20MHz/40MHz):150/144.44/130/117/115.56/104/86.67/78/52/6.5Mbps
	Number Of Channel	802.11b/g/n20MHz:11CH 802.11n40MHz:7CH
	Antenna Designation:	Please see Note 3.
	Output Power(Conducted):	802.11b: 17.42 dBm (Max.) 802.11g: 15.22 dBm (Max.) 802.11n(20M): 14.96 dBm (Max.) 802.11n(40M): 14.85 dBm (Max.)
	Antenna Gain (dBi)	1.0 dbi
	Based on the application, features, or specification exhibited in User's Manual, the EUT is considered as an ITE/Computing Device. More details of EUT technical specification, please refer to the User's Manual.	
	Channel List	Please refer to the Note 2.
Ratings	DC 5V	
Adapter	N/A	
Battery	N/A	

Note:

1. For a more detailed features description, please refer to the manufacturer's specifications or the User's Manual.

2.

Channel List for 802.11b/g/n(20 MHz)							
Channel	Frequency (MHz)	Channel	Frequency (MHz)	Channel	Frequency (MHz)	Channel	Frequency (MHz)
01	2412	04	2427	07	2442	10	2457
02	2417	05	2432	08	2447	11	2462
03	2422	06	2437	09	2452		

Channel List for 802.11n(40MHz)							
Channel	Frequency (MHz)	Channel	Frequency (MHz)	Channel	Frequency (MHz)	Channel	Frequency (MHz)
03	2422	06	2437	09	2452		
04	2427	07	2442				
05	2432	08	2447				

3.

Table for Filed Antenna

Ant	Brand	Model Name	Antenna Type	Connector	Gain (dBi)	NOTE
A	N/A	N/A	PCB Antenna	N/A	1.0	Wifi Antenna

2.2 DESCRIPTION OF TEST MODES

To investigate the maximum EMI emission characteristics generates from EUT, the test system was pre-scanning tested base on the consideration of following EUT operation mode or test configuration mode which possible have effect on EMI emission level. Each of these EUT operation mode(s) or test configuration mode(s) mentioned above was evaluated respectively.

Pretest Mode	Description
Mode 1	802.11b CH1/ CH6/ CH11
Mode 2	802.11g CH1/ CH6/ CH11
Mode 3	802.11n/20MHz CH1/ CH6/ CH11
Mode 4	802.11n/40MHz CH3/ CH6/ CH9
Mode 5	Link Mode

For Conducted Emission	
Final Test Mode	Description
Mode 5	Link Mode

For Radiated Emission	
Final Test Mode	Description
Mode 1	802.11b CH1/ CH6/ CH11
Mode 2	802.11g CH1/ CH6/ CH11
Mode 3	802.11n/20MHz CH1/ CH6/ CH11
Mode 4	802.11n/40MHz CH3/ CH6/ CH9

Note:

- (1) The measurements are performed at the highest, middle, lowest available channels.
- (2) The measurements are performed at all Bit Rate of Transmitter, the worst data was reported

2.3 BLOCK DIGRAM SHOWING THE CONFIGURATION OF SYSTEM TESTED

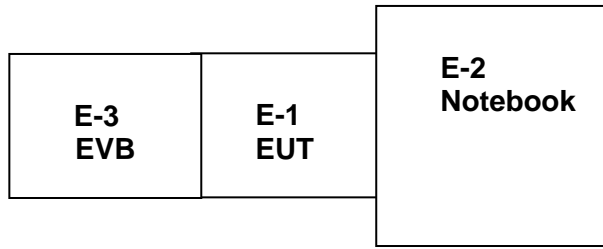

2.4 DESCRIPTION OF SUPPORT UNITS(CONDUCTED MODE)

The EUT has been tested as an independent unit together with other necessary accessories or support units. The following support units or accessories were used to form a representative test configuration during the tests.

Item	Equipment	Brand	Model/Type No.	Series No.	Note
E-1	wifi module	SKYLAB	WG209	N/A	EUT
E-2	Notebook	DELL	PP10L	N/A	
E-3	EVB	N/A	N/A	N/A	

Item	Shielded Type	Ferrite Core	Length	Note

Note:

- (1) The support equipment was authorized by Declaration of Confirmation.
- (2) For detachable type I/O cable should be specified the length in cm in 『Length』 column.

2.5 EQUIPMENTS LIST FOR ALL TEST ITEMS

Radiation Test equipment

Item	Kind of Equipment	Manufacturer	Type No.	Serial No.	Last calibration	Calibrated until	Calibration period
1	Spectrum Analyzer	Agilent	E4407B	MY45108040	2013.07.06	2014.07.05	1 year
2	Test Receiver	R&S	ESPI	101318	2014.06.07	2015.06.06	1 year
3	Bilog Antenna	TESEQ	CBL6111D	31216	2013.07.06	2014.07.05	1 year
4	50Ω Coaxial Switch	Anritsu	MP59B	6200264416	2014.06.07	2015.06.06	1 year
5	Spectrum Analyzer	ADVANTEST	R3132	150900201	2014.06.07	2015.06.06	1 year
6	Horn Antenna	EM	EM-AH-10180	2011071402	2013.07.06	2014.07.05	1 year
7	Horn Ant	Schwarzbeck	BBHA 9170	9170-181	2013.07.06	2014.07.05	1 year
8	Amplifier	EM	EM-30180	060538	2013.12.22	2014.12.21	1 year
9	Loop Antenna	ARA	PLA-1030/B	1029	2014.06.08	2015.06.07	1 year
10	Power Meter	R&S	NRVS	100696	2013.07.06	2014.07.05	1 year
11	Power Sensor	R&S	URV5-Z4	0395.1619.05	2013.07.06	2014.07.05	1 year

Conduction Test equipment

Item	Kind of Equipment	Manufacturer	Type No.	Serial No.	Last calibration	Calibrated until	Calibration period
1	Test Receiver	R&S	ESCI	101160	2014.06.06	2015.06.05	1 year
2	LISN	R&S	ENV216	101313	2013.08.24	2014.08.23	1 year
3	LISN	EMCO	3816/2	00042990	2013.08.24	2014.08.23	1 year
4	50Ω Coaxial Switch	Anritsu	MP59B	6200264417	2014.06.07	2015.06.06	1 year
5	Passive Voltage Probe	R&S	ESH2-Z3	100196	2014.06.07	2015.06.06	1 year
6	Absorbing clamp	R&S	MOS-21	100423	2014.06.08	2015.06.07	1 year

1	Attenuation	MCE	24-10-34	BN9258	2014.06.08	2015.06.07	1 year
---	-------------	-----	----------	--------	------------	------------	--------

3. EMC EMISSION TEST

3.1 CONDUCTED EMISSION MEASUREMENT

3.1.1 POWER LINE CONDUCTED EMISSION Limits (Frequency Range 150KHz-30MHz)

FREQUENCY (MHz)	Class A (dBuV)		Class B (dBuV)		Standard
	Quasi-peak	Average	Quasi-peak	Average	
0.15 -0.5	79.00	66.00	66 - 56 *	56 - 46 *	CISPR
0.50 -5.0	73.00	60.00	56.00	46.00	CISPR
5.0 -30.0	73.00	60.00	60.00	50.00	CISPR

0.15 -0.5	79.00	66.00	66 - 56 *	56 - 46 *	FCC
0.50 -5.0	73.00	60.00	56.00	46.00	FCC
5.0 -30.0	73.00	60.00	60.00	50.00	FCC

Note:

- (1) The tighter limit applies at the band edges.
- (2) The limit of " * " marked band means the limitation decreases linearly with the logarithm of the frequency in the range.

The following table is the setting of the receiver

Receiver Parameters	Setting
Attenuation	10 dB
Start Frequency	0.15 MHz
Stop Frequency	30 MHz
IF Bandwidth	9 kHz

3.1.2 TEST PROCEDURE

- a. The EUT was placed 0.8 meters from the horizontal ground plane with EUT being connected to the power mains through a line impedance stabilization network (LISN). All other support equipments powered from additional LISN(s). The LISN provide 50 Ohm/ 50uH of coupling impedance for the measuring instrument.
- b. Interconnecting cables that hang closer than 40 cm to the ground plane shall be folded back and forth in the center forming a bundle 30 to 40 cm long.
- c. I/O cables that are not connected to a peripheral shall be bundled in the center. The end of the cable may be terminated, if required, using the correct terminating impedance. The overall length shall not exceed 1 m.
- d. LISN at least 80 cm from nearest part of EUT chassis.
- e. For the actual test configuration, please refer to the related Item –EUT Test Photos.

3.1.3 DEVIATION FROM TEST STANDARD

No deviation

3.1.4 TEST SETUP

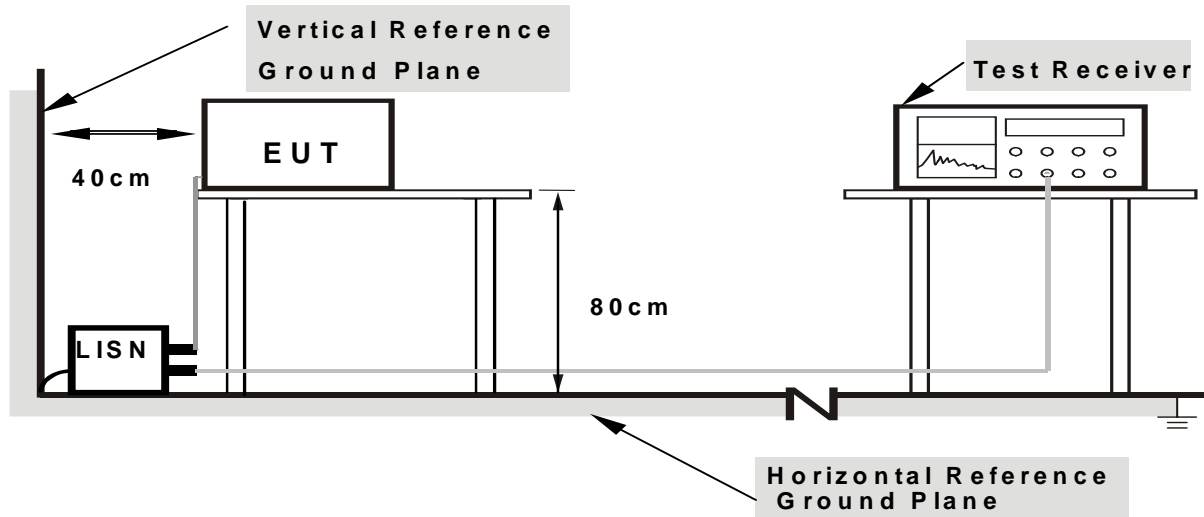

- Note:**
- 1. Support units were connected to second LISN.
 - 2. Both of LISNs (AMN) are 80 cm from EUT and at least 80 from other units and other metal planes

3.1.5 EUT OPERATING CONDITIONS

The EUT was configured for testing in a typical fashion (as a customer would normally use it). The EUT has been programmed to continuously transmit during test. This operating condition was tested and used to collect the included data.

3.1.6 TEST RESULTS

EUT :	wifi module	Model Name. :	WG209
Temperature :	26 °C	Relative Humidity :	56%
Pressure :	1010hPa	Phase :	L
Test Voltage :	DC 5.0V form Adapter AC 120V/60Hz	Test Mode :	Mode 5

Frequency (MHz)	Meter Reading (dBμV)	Factor (dB)	Emission Level (dBμV)	Limits (dBμV)	Margin (dB)	Detector Type
0.1499	33.83	0.00	33.83	66.00	-32.17	peak
0.1499	13.77	0.00	13.77	56.00	-42.23	AVG
0.2300	31.39	0.00	31.39	62.45	-31.06	peak
0.2300	17.84	0.00	17.84	52.45	-34.61	AVG
0.3420	29.15	0.00	29.15	59.15	-30.00	peak
0.3420	17.44	0.00	17.44	49.15	-31.71	AVG
0.5660	30.69	0.00	30.69	56.00	-25.31	peak
0.5660	17.02	0.00	17.02	46.00	-28.98	AVG
0.6780	30.37	0.00	30.37	56.00	-25.63	peak
0.6780	16.81	0.00	16.81	46.00	-29.19	AVG
3.8460	25.04	0.00	25.04	56.00	-30.96	peak
3.8460	12.84	0.00	12.84	46.00	-33.16	AVG

Remark:

1. All readings are Quasi-Peak and Average values.
2. Factor = Insertion Loss + Cable Loss.

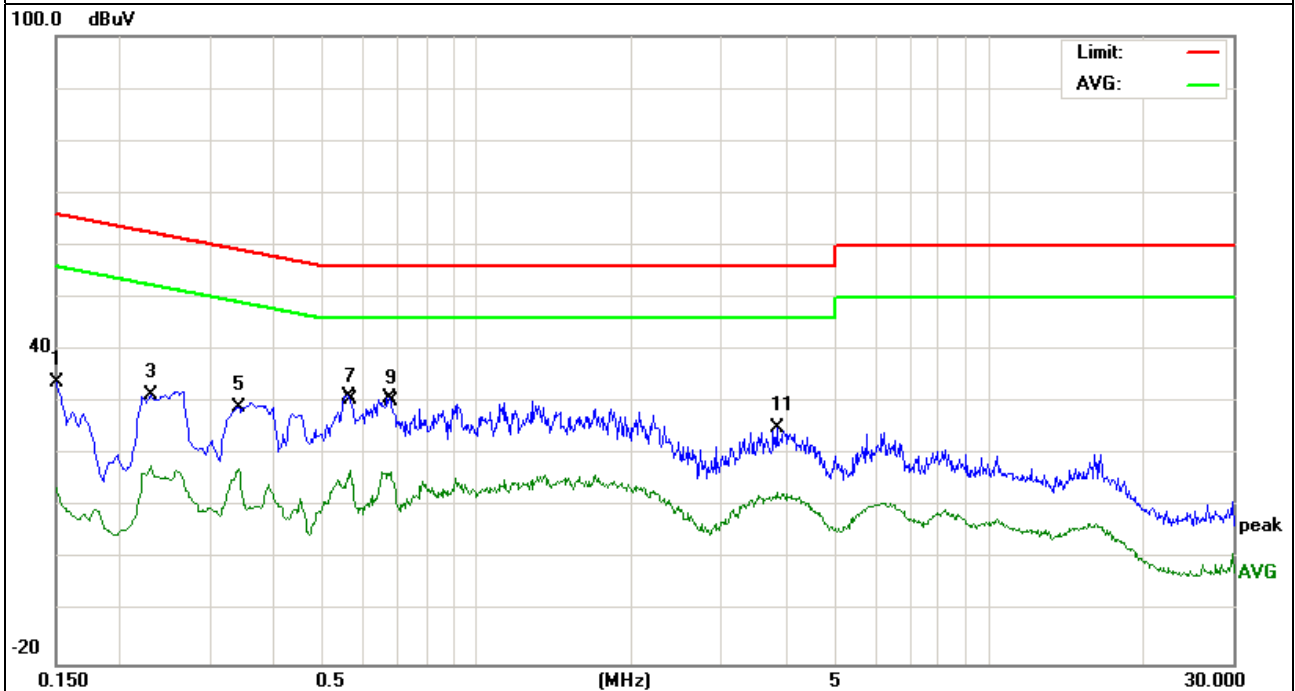

EUT :	wifi module	Model Name. :	WG209
Temperature :	26 °C	Relative Humidity :	56%
Pressure :	1010hPa	Phase :	N
Test Voltage :	DC 5.0V form Adapter AC 120V/60Hz	Test Mode :	Mode 5

Frequency (MHz)	Meter Reading (dBμV)	Factor (dB)	Emission Level (dBμV)	Limits (dBμV)	Margin (dB)	Detector Type
0.2300	33.05	0.00	33.05	62.45	-29.40	peak
0.2300	21.83	0.00	21.83	52.45	-30.62	AVG
0.3379	30.99	0.00	30.99	59.25	-28.26	peak
0.3379	18.59	0.00	18.59	49.25	-30.66	AVG
0.5700	32.23	0.00	32.23	56.00	-23.77	peak
0.5700	17.26	0.00	17.26	46.00	-28.74	AVG
0.6700	32.59	0.00	32.59	56.00	-23.41	peak
0.6780	18.45	0.00	18.45	46.00	-27.55	AVG
1.3660	25.86	0.00	25.86	56.00	-30.14	peak
1.3660	15.00	0.00	15.00	46.00	-31.00	AVG
3.8540	22.56	0.00	22.56	56.00	-33.44	peak
3.8540	12.04	0.00	12.04	46.00	-33.96	AVG

Remark:

1. All readings are Quasi-Peak and Average values.
2. Factor = Insertion Loss + Cable Loss.

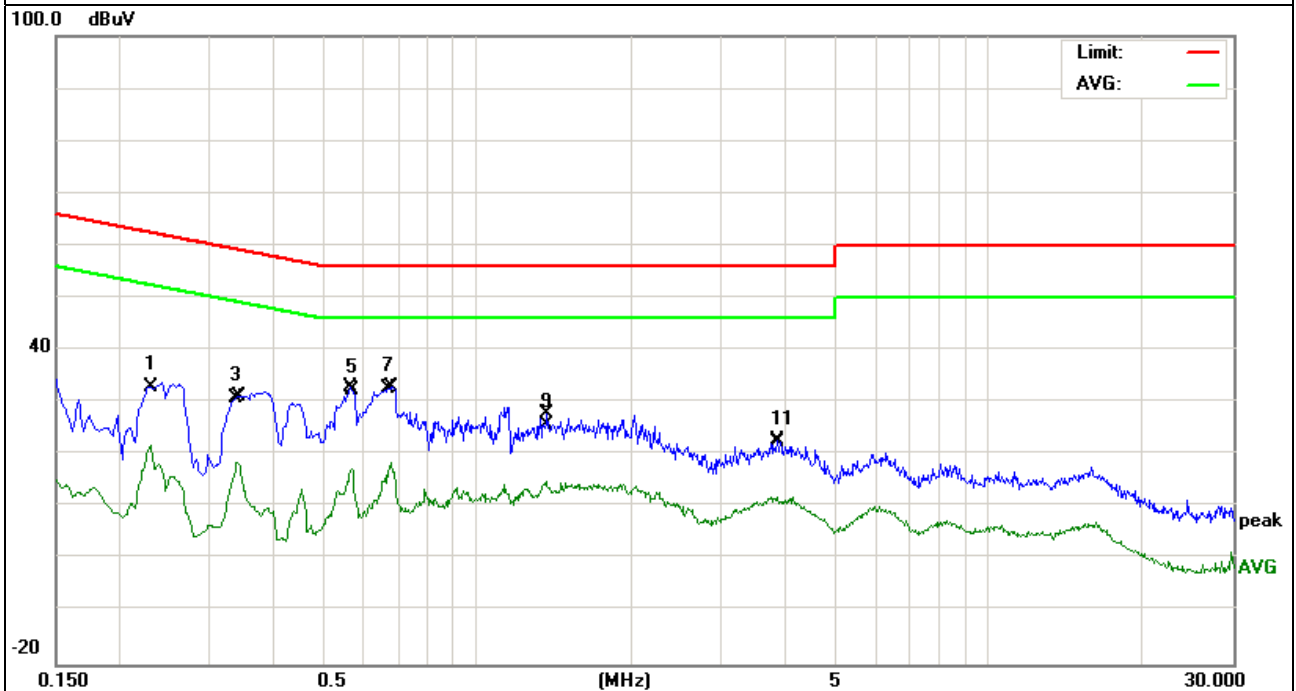

3.2 RADIATED EMISSION MEASUREMENT

3.2.1 RADIATED EMISSION LIMITS (Frequency Range 9kHz-1000MHz)

20dBc in any 100 kHz bandwidth outside the operating frequency band. In case the emission fall within the restricted band specified on 15.205(a), then the 15.209(a) limit in the table below has to be followed.

Frequencies (MHz)	Field Strength (micorvolts/meter)	Measurement Distance (meters)
0.009~0.490	2400/F(KHz)	300
0.490~1.705	24000/F(KHz)	30
1.705~30.0	30	30
30~88	100	3
88~216	150	3
216~960	200	3
Above 960	500	3

LIMITS OF RADIATED EMISSION MEASUREMENT (Above 1000MHz)

FREQUENCY (MHz)	Class A (dBuV/m) (at 3M)		Class B (dBuV/m) (at 3M)	
	PEAK	AVERAGE	PEAK	AVERAGE
Above 1000	80	60	74	54

Notes:

- (1) The limit for radiated test was performed according to FCC PART 15C.
- (2) The tighter limit applies at the band edges.
- (3) Emission level (dBuV/m)=20log Emission level (uV/m).

Spectrum Parameter	Setting
Attenuation	Auto
Start Frequency	1000 MHz
Stop Frequency	10th carrier harmonic
RB / VB (emission in restricted band)	1 MHz / 1 MHz for Peak, 1 MHz / 10Hz for Average

Receiver Parameter	Setting
Attenuation	Auto
Start ~ Stop Frequency	9kHz~150kHz / RB 200Hz for QP
Start ~ Stop Frequency	150kHz~30MHz / RB 9kHz for QP
Start ~ Stop Frequency	30MHz~1000MHz / RB 120kHz for QP

3.2.2 TEST PROCEDURE

- a. The measuring distance of at 3 m shall be used for measurements at frequency up to 1GHz. For frequencies above 1GHz, any suitable measuring distance may be used.
- b. The EUT was placed on the top of a rotating table 0.8 meters above the ground at a 3 meter open area test site. The table was rotated 360 degrees to determine the position of the highest radiation.
- c. The height of the equipment or of the substitution antenna shall be 0.8 m; the height of the test antenna shall vary between 1 m to 4 m. Both horizontal and vertical polarizations of the antenna are set to make the measurement.
- d. The initial step in collecting conducted emission data is a spectrum analyzer peak detector mode pre-scanning the measurement frequency range. Significant peaks are then marked and then Quasi Peak detector mode re-measured.
- e. If the Peak Mode measured value compliance with and lower than Quasi Peak Mode Limit, the EUT shall be deemed to meet QP Limits and then no additional QP Mode measurement performed.
- f. For the actual test configuration, please refer to the related Item –EUT Test Photos.

Note:

Both horizontal and vertical antenna polarities were tested and performed pretest to three orthogonal axis. The worst case emissions were reported

During the radiated emission test, the Spectrum Analyzer was set with the following configurations:

Frequency Band (MHz)	Function	Resolution bandwidth	Video Bandwidth
30 to 1000	Peak	100 kHz	100 kHz
Above 1000	Peak	1 MHz	1 MHz
	Average	1 MHz	10 Hz

3.2.3 DEVIATION FROM TEST STANDARD

No deviation

3.2.4 TEST SETUP

(A) Radiated Emission Test-Up Frequency Below 30MHz

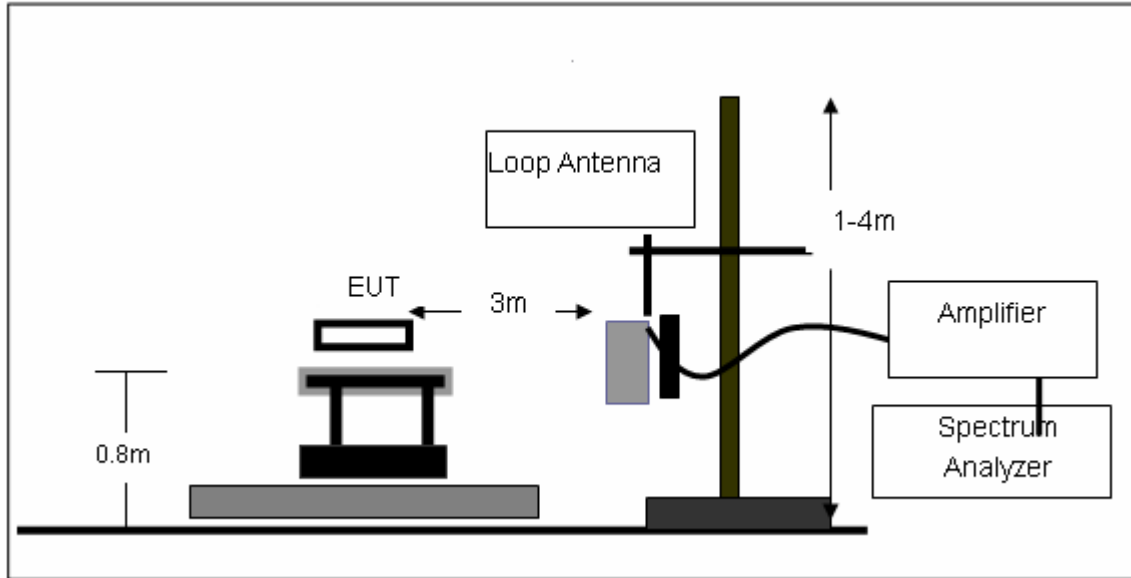

(B) Radiated Emission Test-Up Frequency 30MHz~1GHz

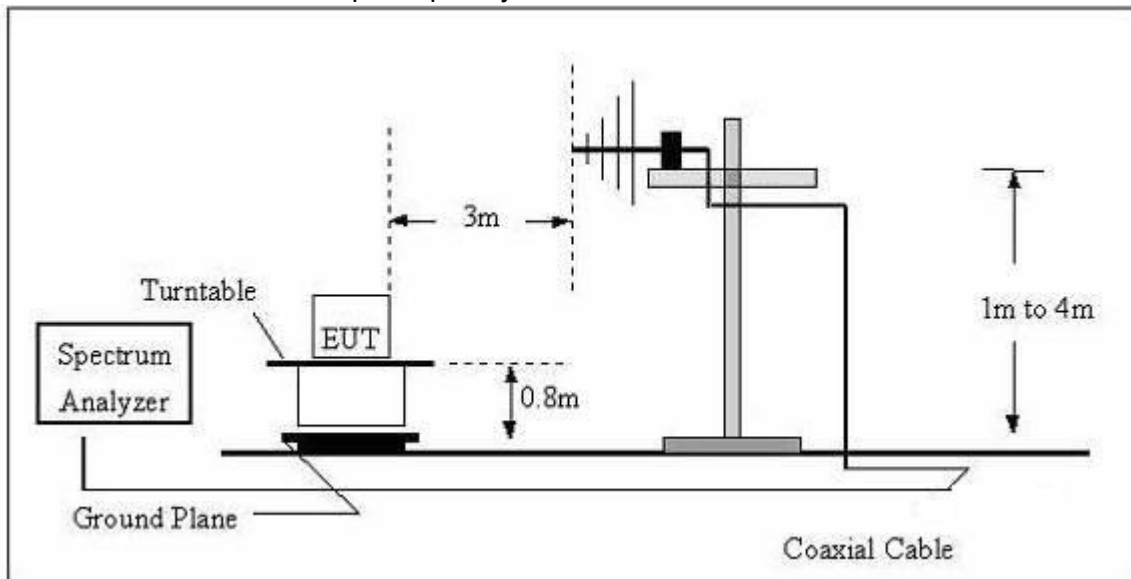

(C) Radiated Emission Test-Up Frequency Above 1GHz

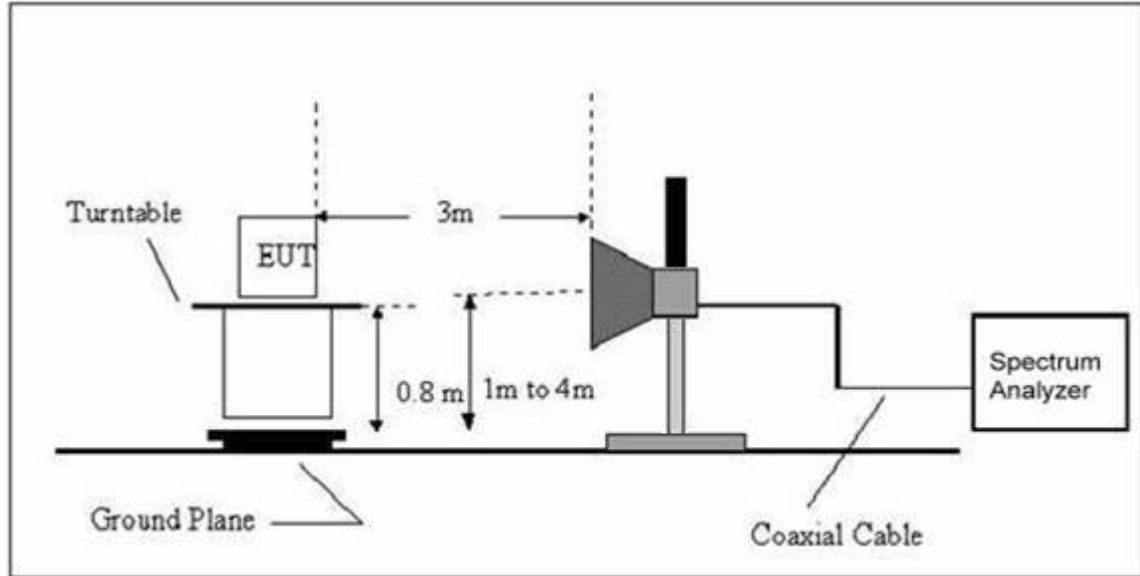

3.2.5 EUT OPERATING CONDITIONS

The EUT tested system was configured as the statements of 2.4 Unless otherwise a special operating condition is specified in the follows during the testing.

3.2.6 TEST RESULTS (BETWEEN 9KHZ – 30 MHZ)

EUT:	wifi module	Model Name. :	WG209
Temperature:	20 °C	Relative Humidity:	48%
Pressure:	1010 hPa	Test Voltage :	DC 5.0V
Test Mode :	TX	Polarization :	--

Freq.	Reading	Limit	Margin	State
(MHz)	(dBuV/m)	(dBuV/m)	(dB)	P/F
--	--	--	--	N/A
--	--	--	--	N/A

NOTE:

The amplitude of spurious emissions which are attenuated by more than 20dB below the permissible value has no need to be reported.

Distance extrapolation factor = $40 \log(\text{specific distance}/\text{test distance})$ (dB);

Limit line = specific limits(dBuv) + distance extrapolation factor.

3.2.7 TEST RESULTS (BETWEEN 30MHZ – 1GHZ)

EUT :	wifi module	Model Name :	WG209
Temperature :	20 °C	Relative Humidity :	48%
Pressure:	1010 hPa	Test Voltage :	DC 5V
Test Mode :	TX		

Frequency (MHz)	Meter Reading (dBµV)	Factor (dB)	Emission Level (dBµV/m)	Limits (dBµV/m)	Margin (dB)	Detect or Type	Comment
Below 1G							
154.8204	13.25	10.45	23.70	43.50	-19.80	QP	Vertical
233.3487	12.71	13.04	25.75	46.00	-20.25	QP	Vertical
425.0280	11.69	18.81	30.50	46.00	-15.50	QP	Vertical
495.9343	13.09	20.21	33.30	46.00	-12.70	QP	Vertical
668.1422	17.24	23.91	41.15	46.00	-4.85	QP	Vertical
869.1301	8.30	27.15	35.45	46.00	-10.55	QP	Vertical
160.3456	12.35	10.48	22.83	43.50	-20.67	QP	Horizontal
212.2694	19.80	11.61	31.41	43.50	-12.09	QP	Horizontal
319.9370	17.57	14.98	32.55	46.00	-13.45	QP	Horizontal
423.5403	18.25	18.78	37.03	46.00	-8.97	QP	Horizontal
665.8034	17.48	23.85	41.33	46.00	-4.67	QP	Horizontal
848.0562	9.71	27.24	36.95	46.00	-9.05	QP	Horizontal

3.2.8 TEST RESULTS (ABOVE 1000 MHZ)

EUT :	wifi module	Model Name :	WG209
Temperature :	20 °C	Relative Humidity :	48%
Pressure:	1010 hPa	Test Voltage :	DC 5V
Test Mode :	TX		

Frequency (MHz)	Meter Reading (dBµV)	Factor (dB)	Emission Level (dBµV/m)	Limits (dBµV/m)	Margin (dB)	Detect or Type	Comment
Low Channel (2412 MHz)-Above 1G							
4824	50.32	10.44	60.76	74	-13.24	Pk	Vertical
4824	32.27	10.44	42.71	54	-11.29	AV	Vertical
7236	45.19	12.39	57.58	74	-16.42	Pk	Vertical
7236	28.36	12.39	40.75	54	-13.25	AV	Vertical
4824	50.18	10.44	60.62	74	-13.38	Pk	Horizontal
4824	33.16	10.44	43.6	54	-10.4	AV	Horizontal
7236	45.08	12.39	57.47	74	-16.53	Pk	Horizontal
7236	30.41	12.39	42.8	54	-11.2	AV	Horizontal
4824	50.32	10.44	60.76	74	-13.24	Pk	Vertical
4824	32.27	10.44	42.71	54	-11.29	AV	Vertical
Mid Channel (2437 MHz)-Above 1G							
4874	50.23	10.4	60.63	74	-13.37	Pk	Vertical
4874	32.61	10.4	43.01	54	-10.99	AV	Vertical
7311	44.74	12.75	57.49	74	-16.51	Pk	Vertical
7311	27.89	12.75	40.64	54	-13.36	AV	Vertical
4874	50.37	10.4	60.77	74	-13.23	Pk	Horizontal
4874	33.25	10.4	43.65	54	-10.35	AV	Horizontal
7311	45.13	12.75	57.88	74	-16.12	Pk	Horizontal
7311	28.85	12.75	41.6	54	-12.4	AV	Horizontal
4874	50.23	10.4	60.63	74	-13.37	Pk	Vertical
4874	32.61	10.4	43.01	54	-10.99	AV	Vertical
High Channel (2462 MHz)- Above 1G							
4924	50.28	10.39	60.67	74	-13.33	Pk	Vertical
4924	33.13	10.39	43.52	54	-10.48	AV	Vertical
7386	45.18	12.68	57.86	74	-16.14	Pk	Vertical
7386	28.76	12.68	41.44	54	-12.56	AV	Vertical
4924	50.03	10.39	60.42	74	-13.58	Pk	Horizontal
4924	33.19	10.39	43.58	54	-10.42	AV	Horizontal
7386	44.01	12.68	56.69	74	-17.31	Pk	Horizontal
7386	29.26	12.68	41.94	54	-12.06	AV	Horizontal
4924	50.28	10.39	60.67	74	-13.33	Pk	Vertical
4924	33.13	10.39	43.52	54	-10.48	AV	Vertical

Note: "802.11b" mode is the worst mode.

Conducted Spurious Emissions at Antenna Port:
802.11b Low Channel

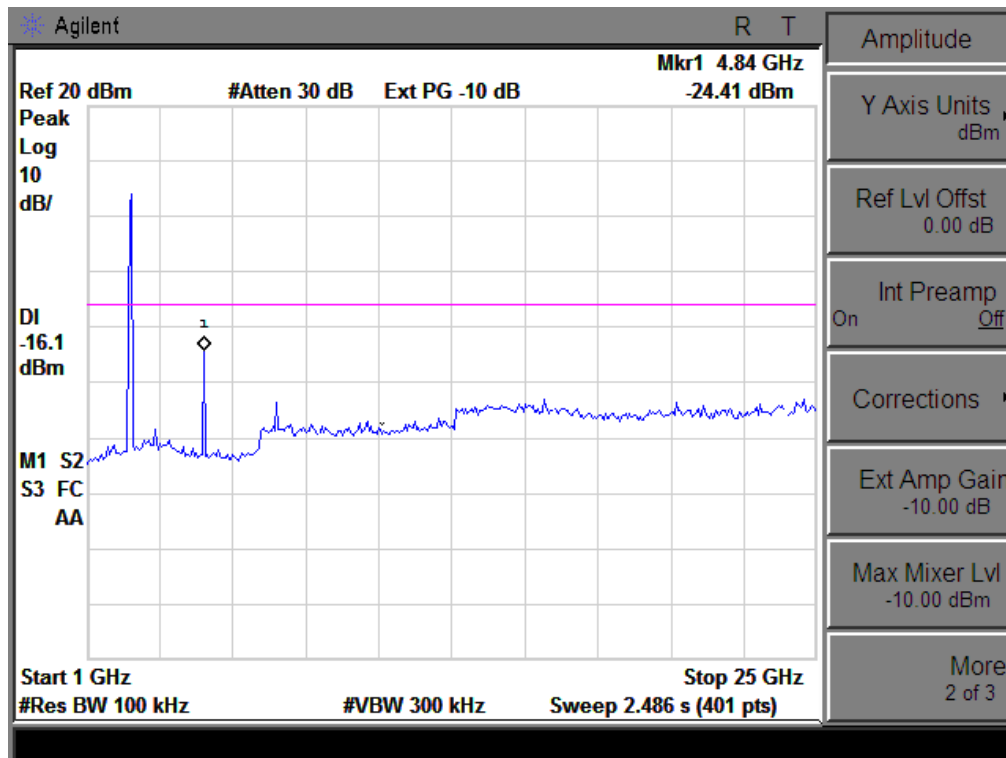
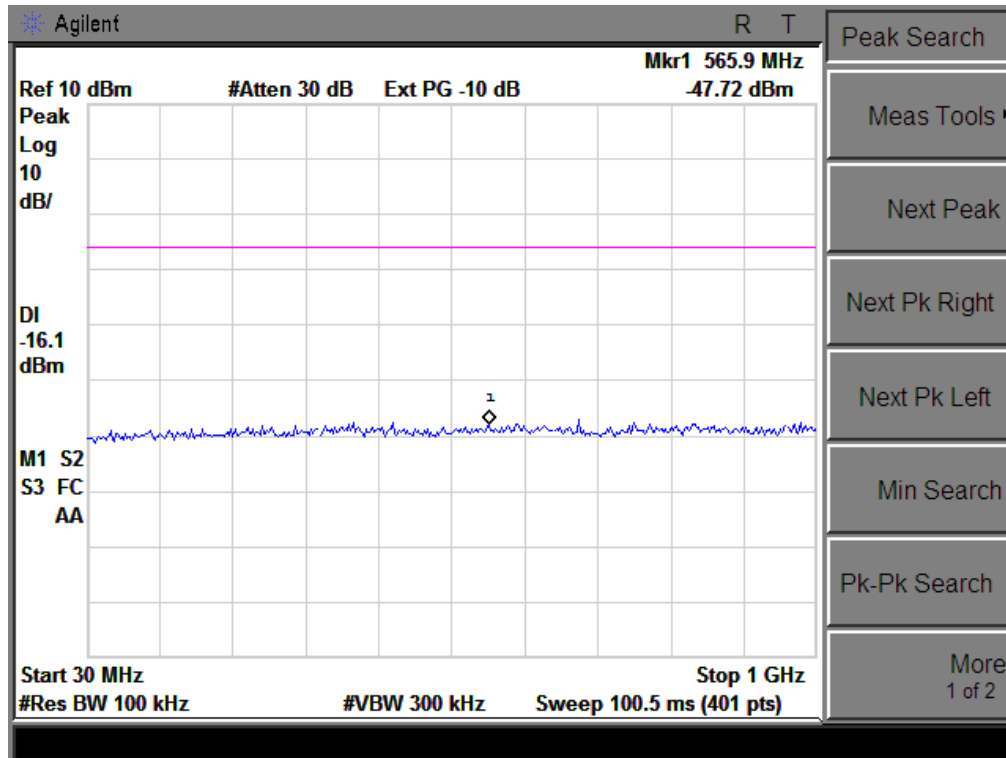

802.11b Middle Channel

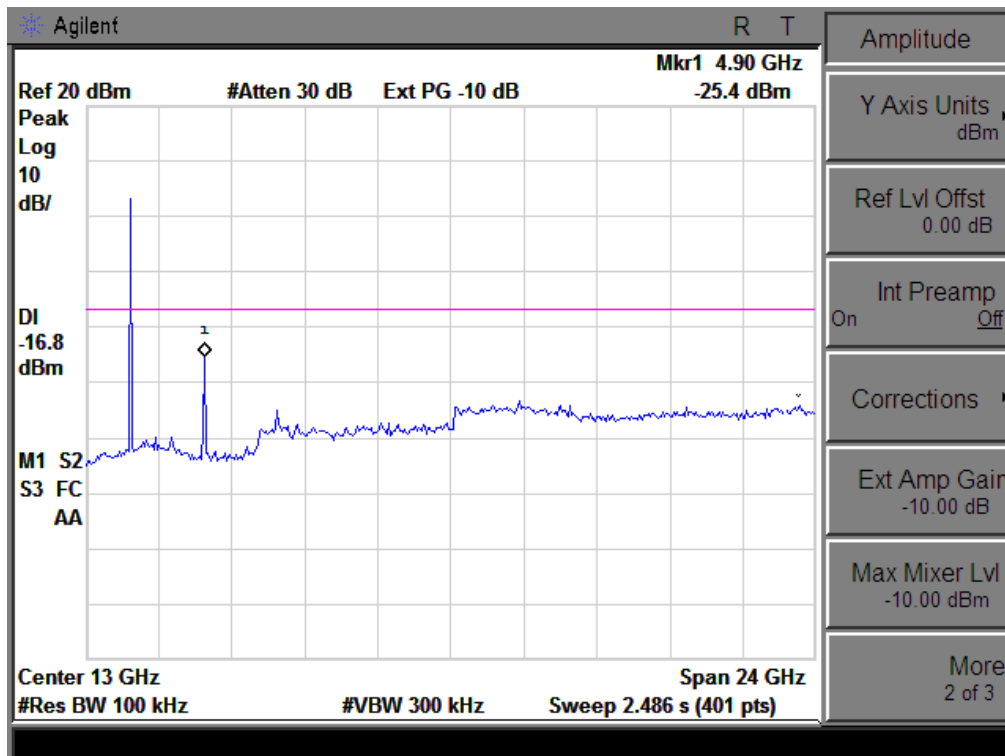
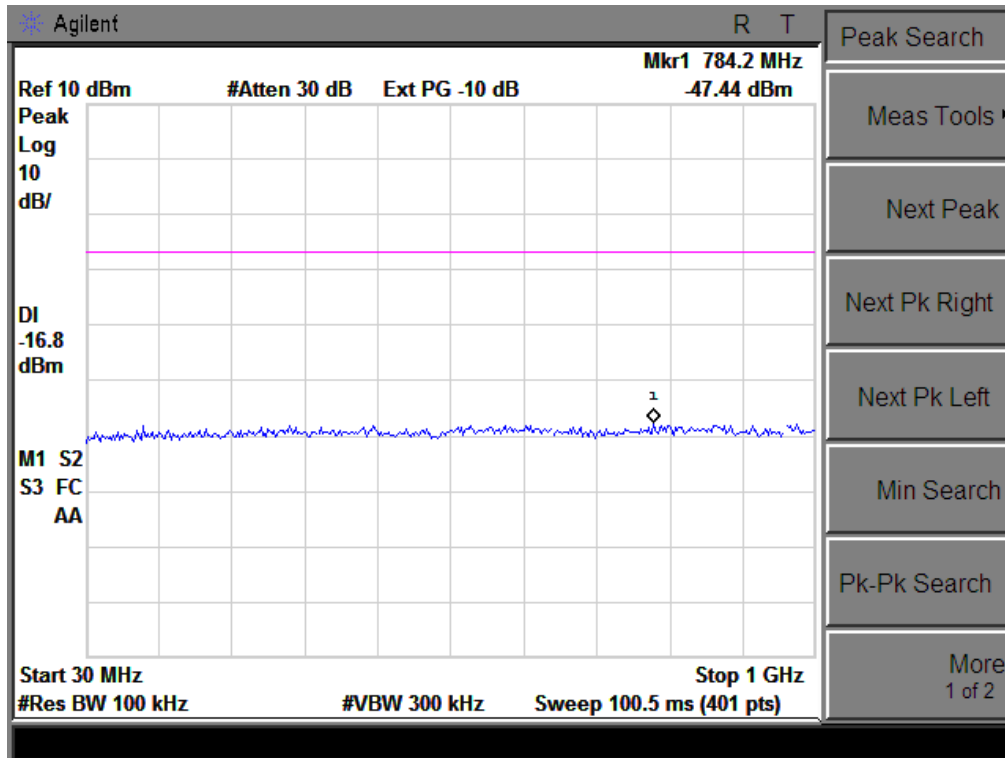

802.11b High Channel

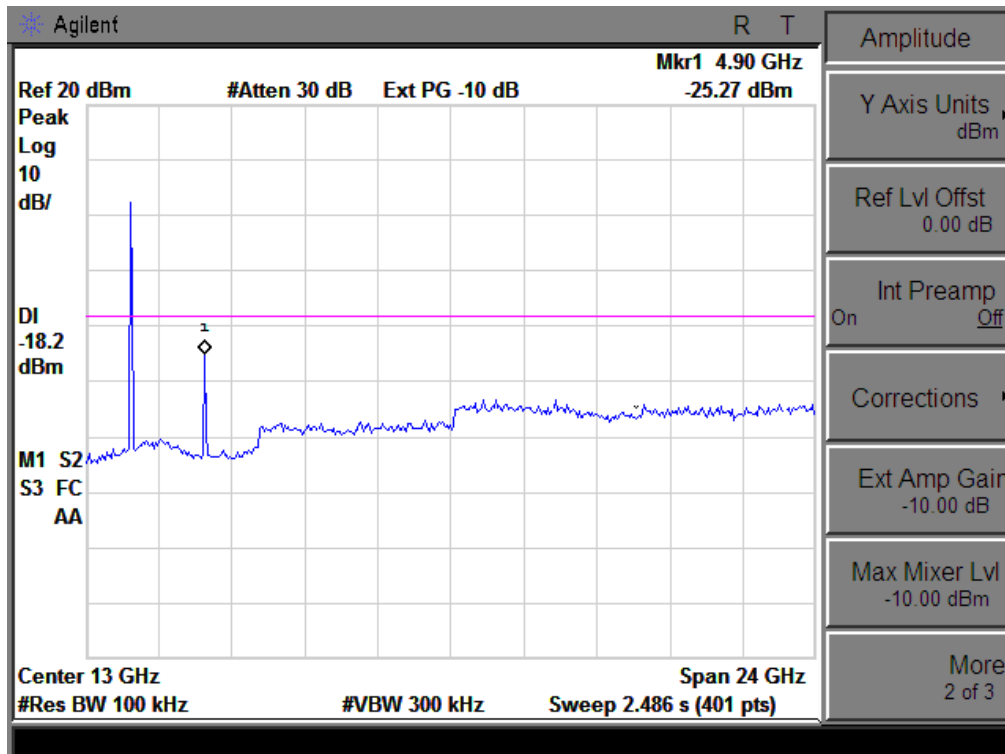
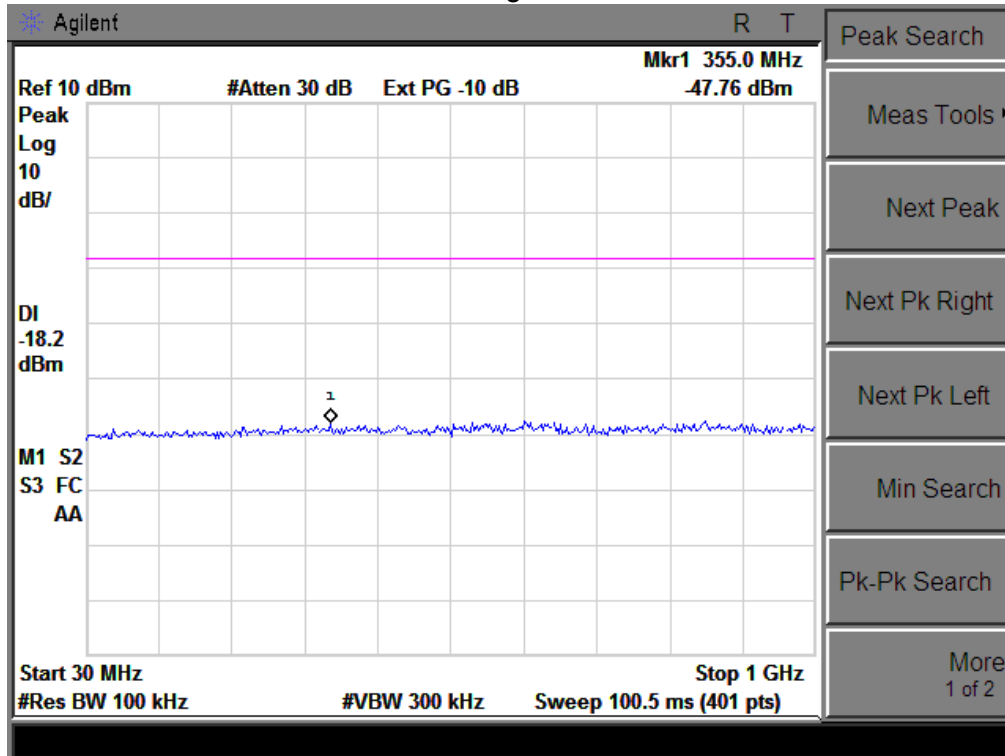

802.11g Low Channel

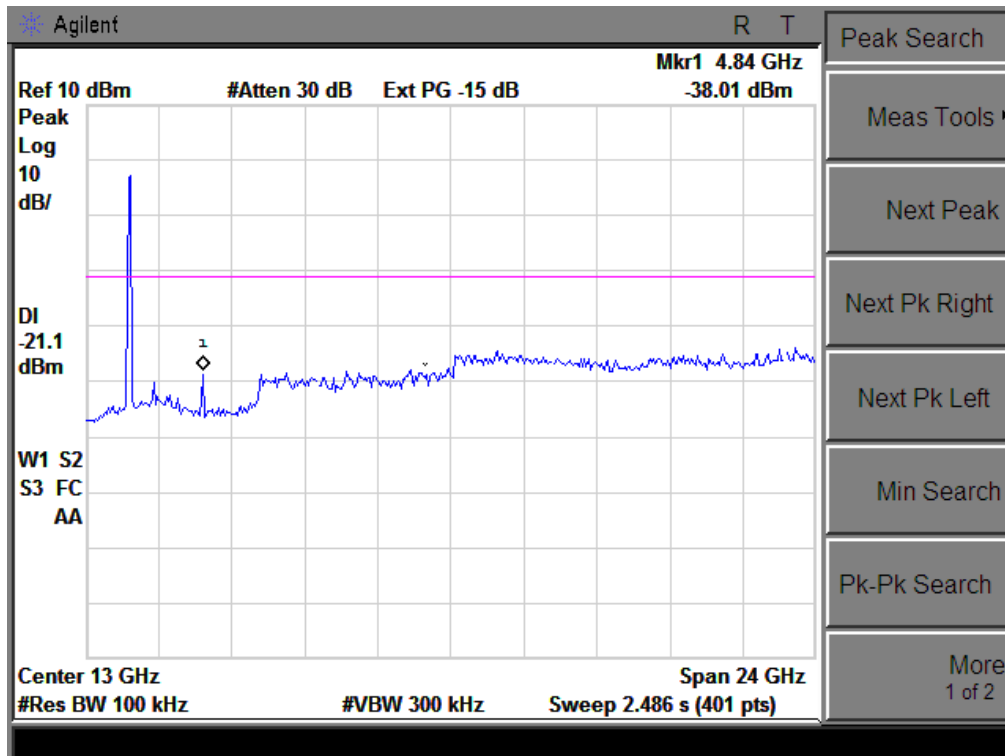
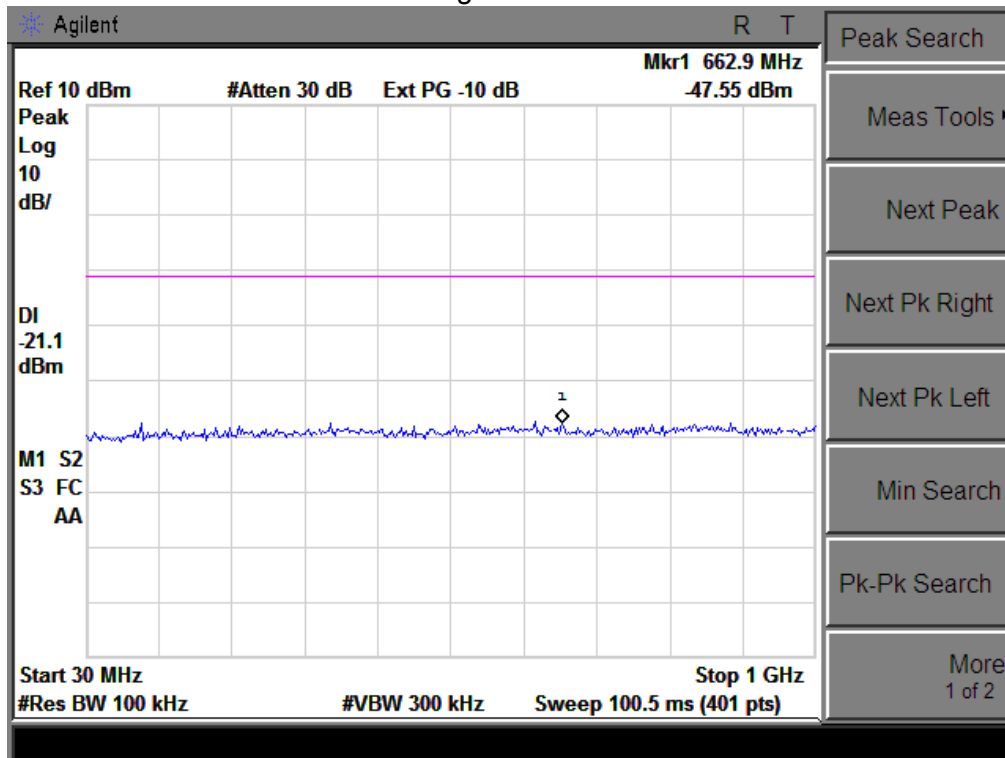

802.11g Middle Channel

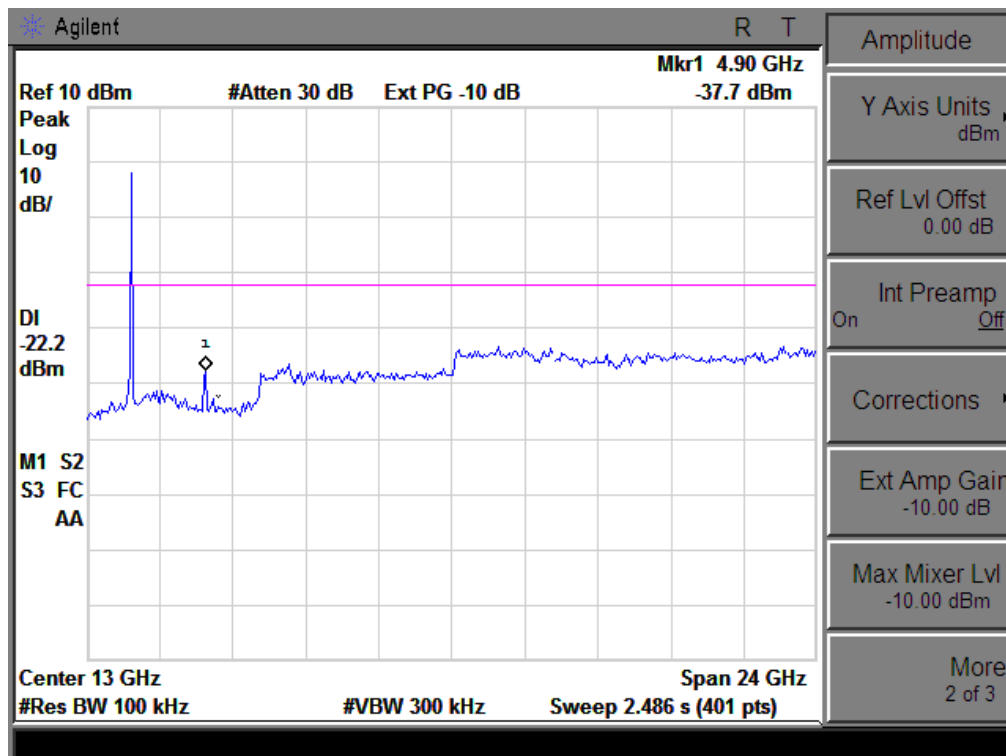
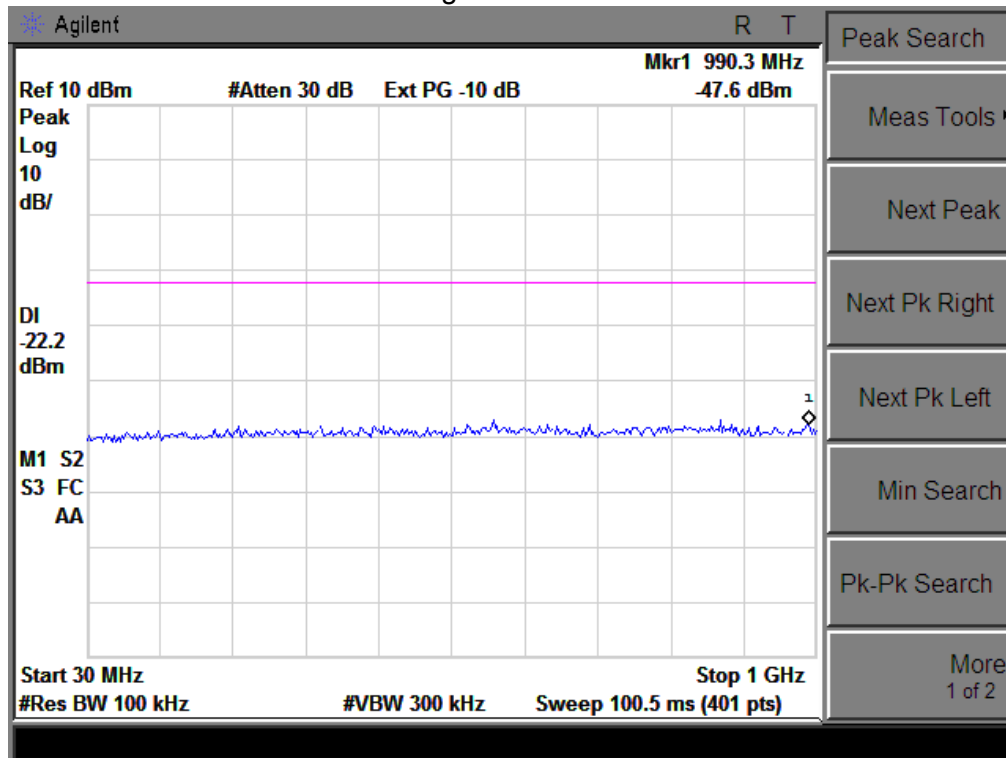

802.11g High Channel

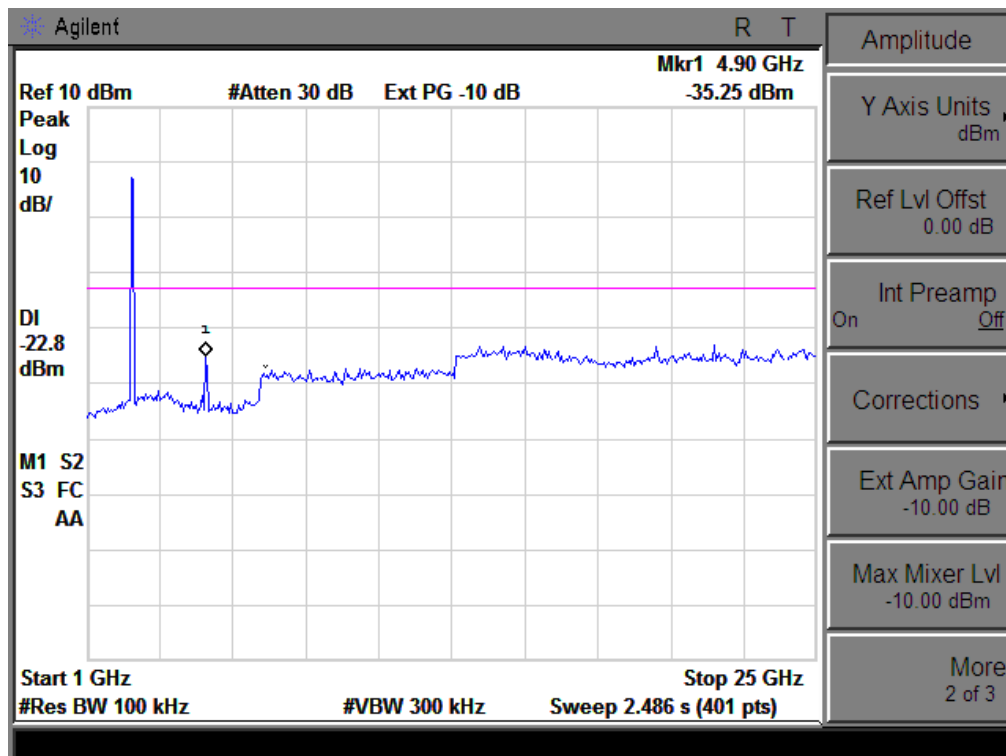
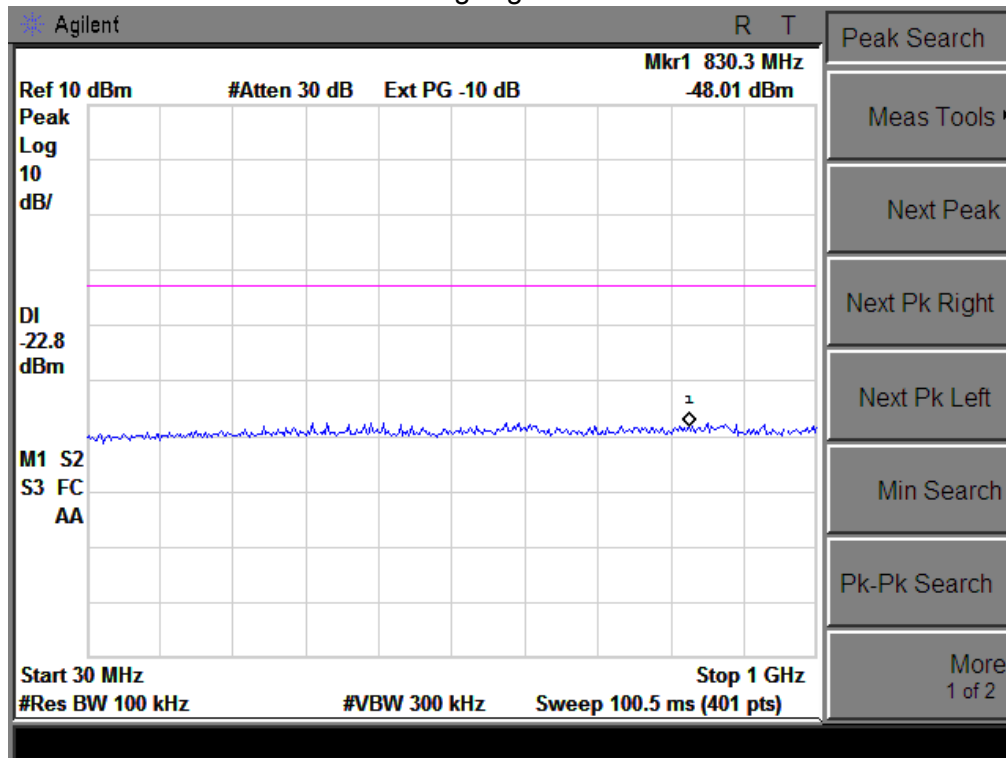

802.11n-HT20 Low Channel

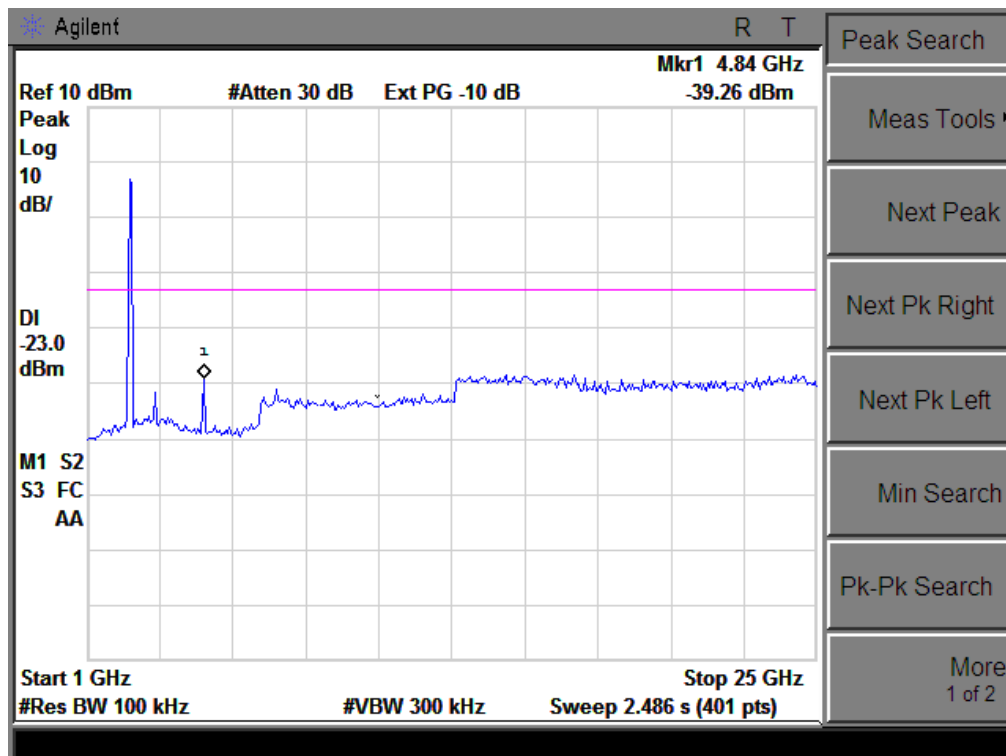
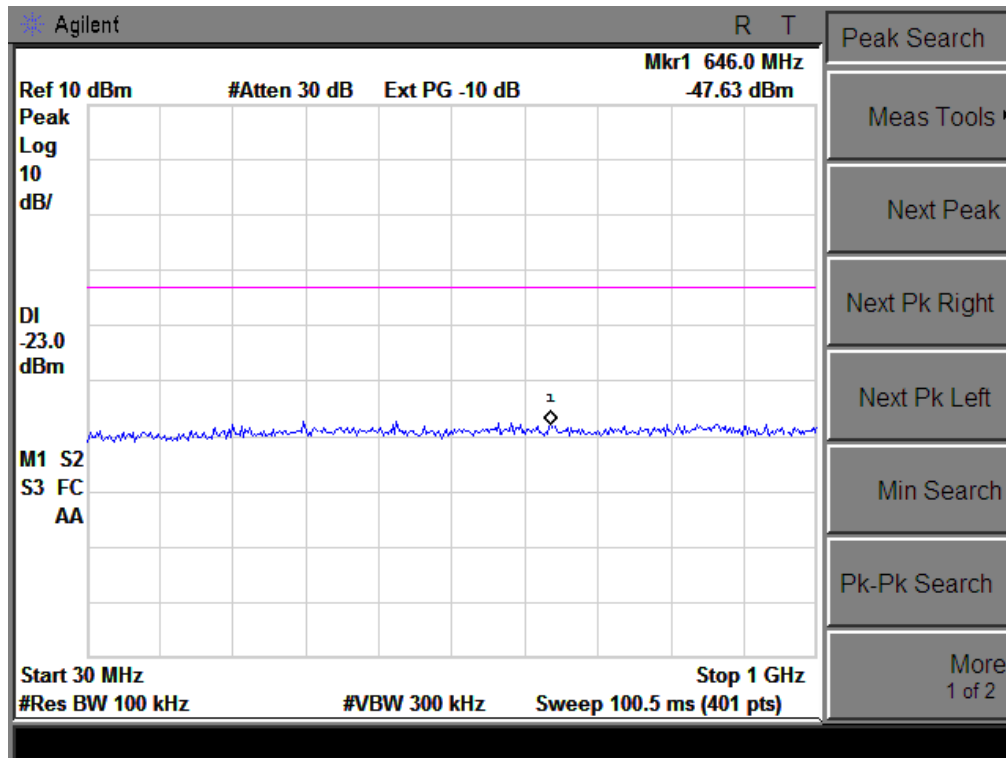

802.11n-HT20 Middle Channel

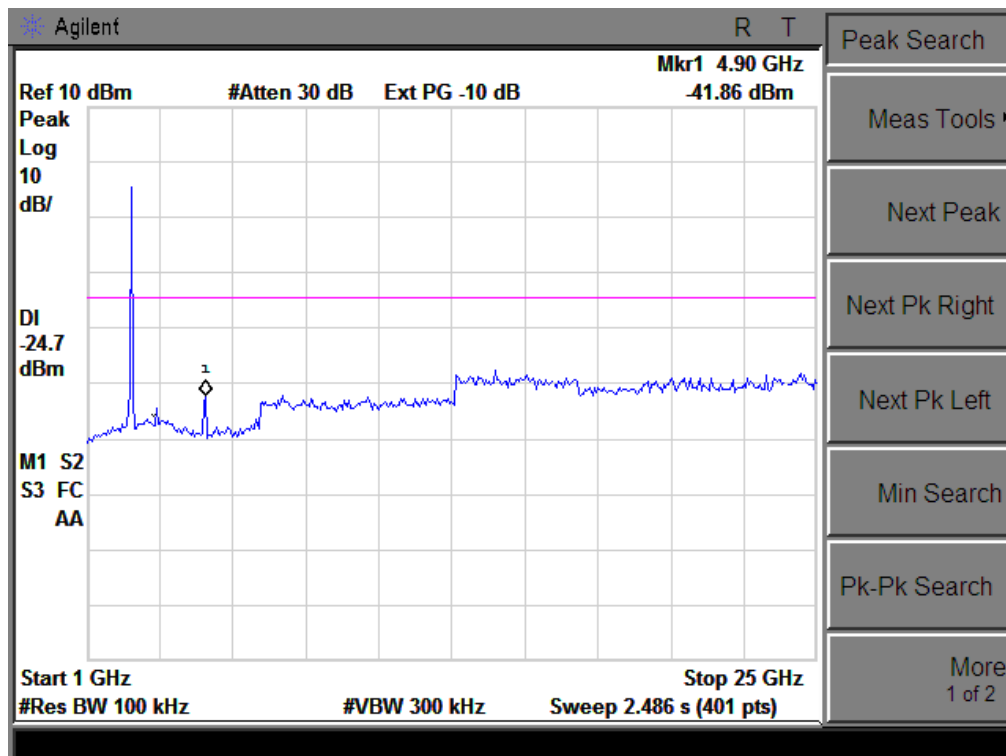
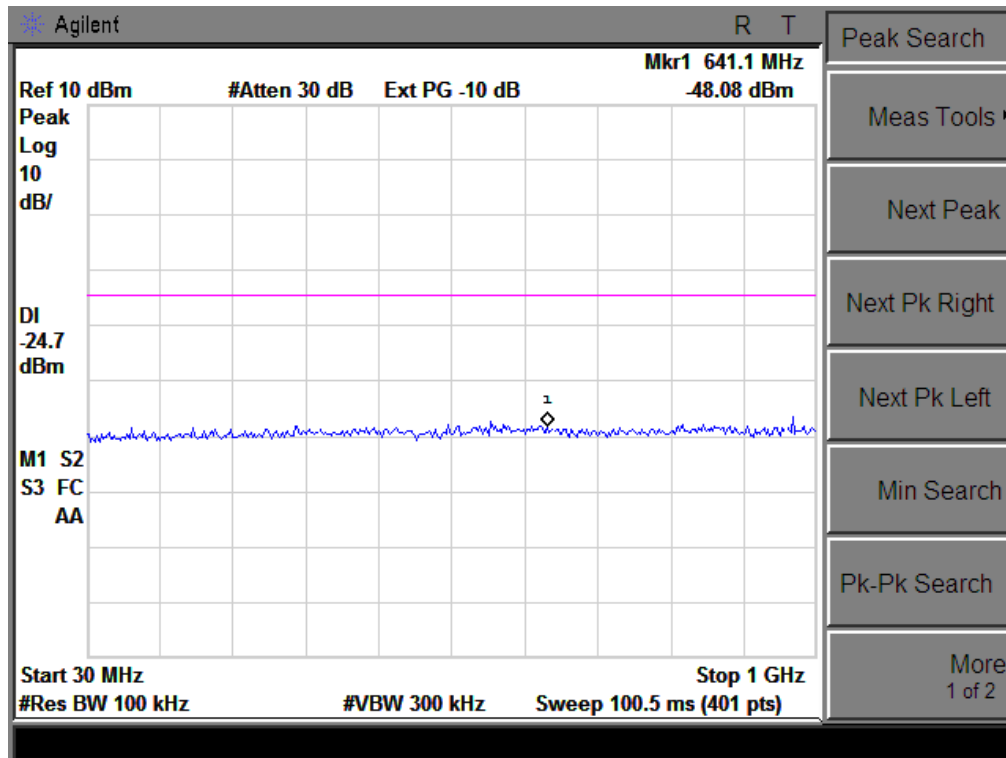

802.11n-HT20 High Channel

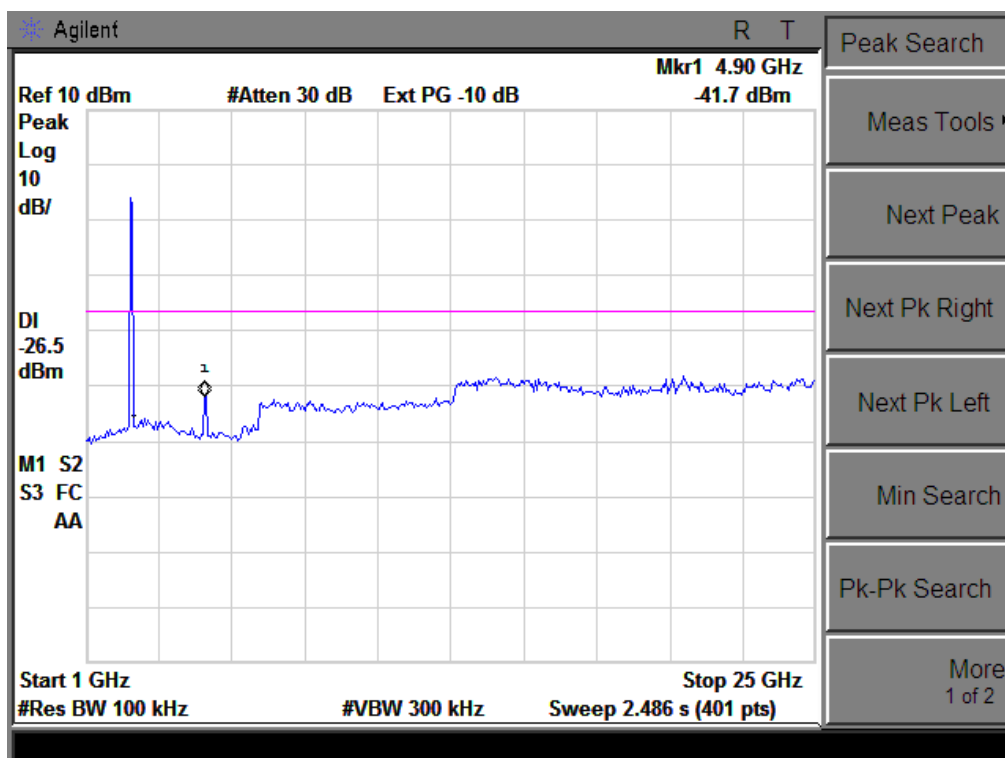
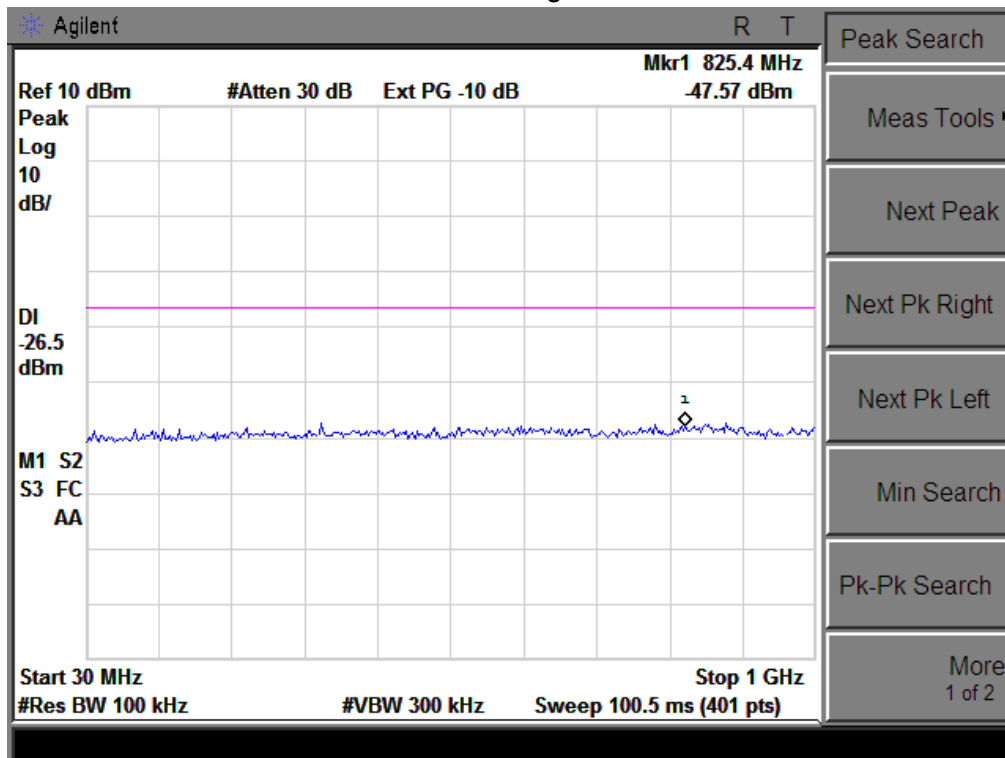

802.11n-HT40 Low Channel

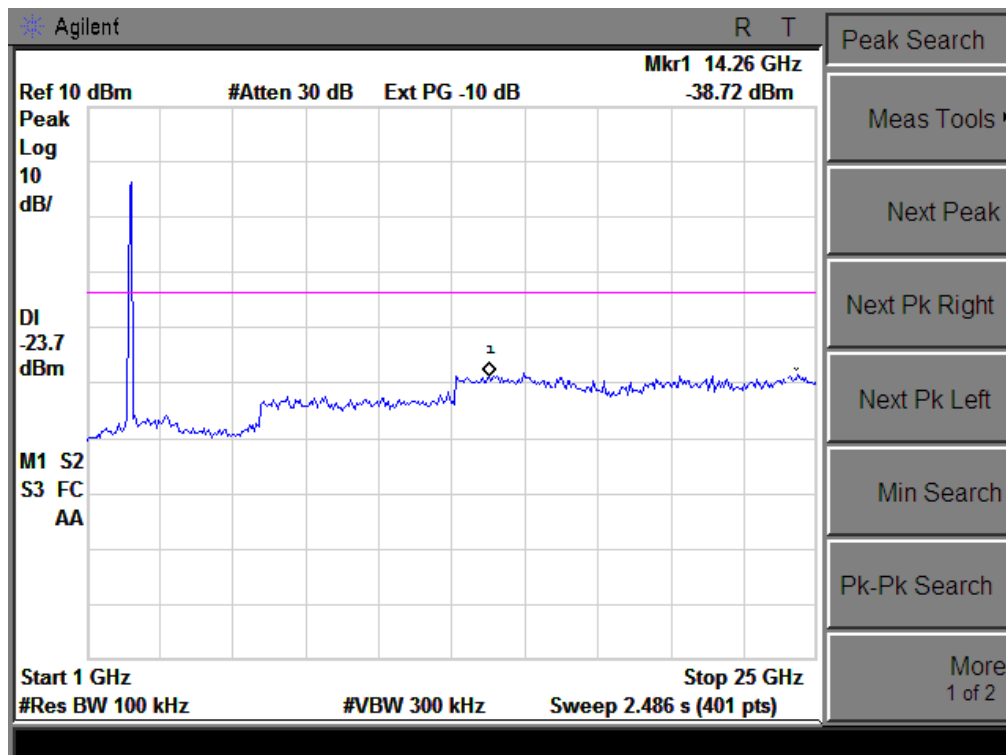
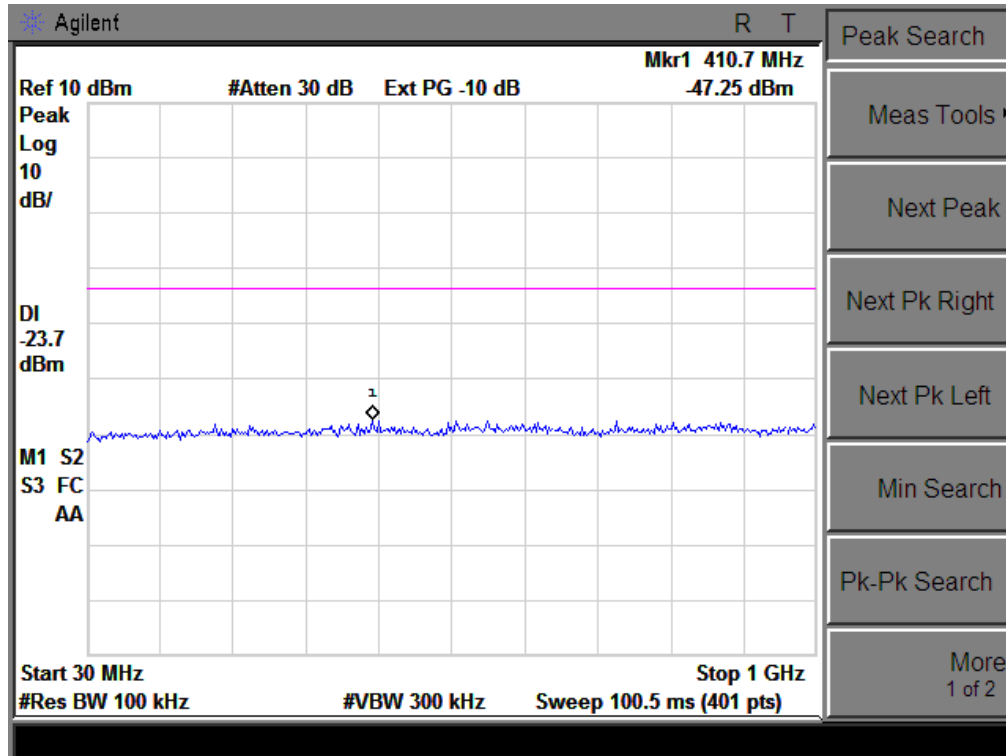

802.11n-HT40 Middle Channel

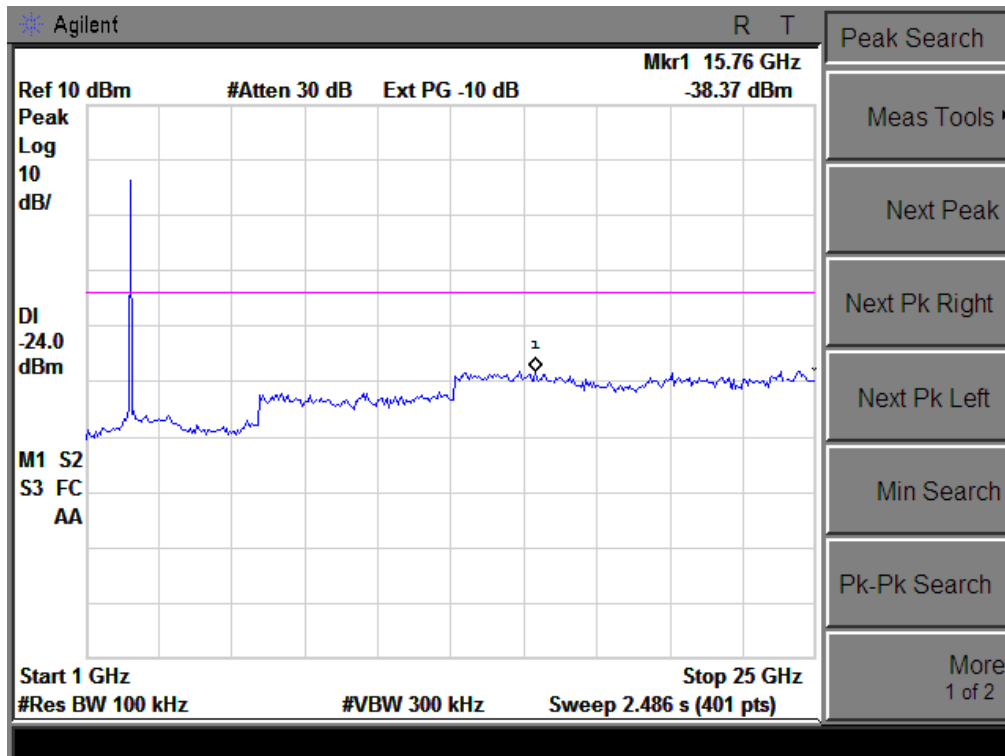
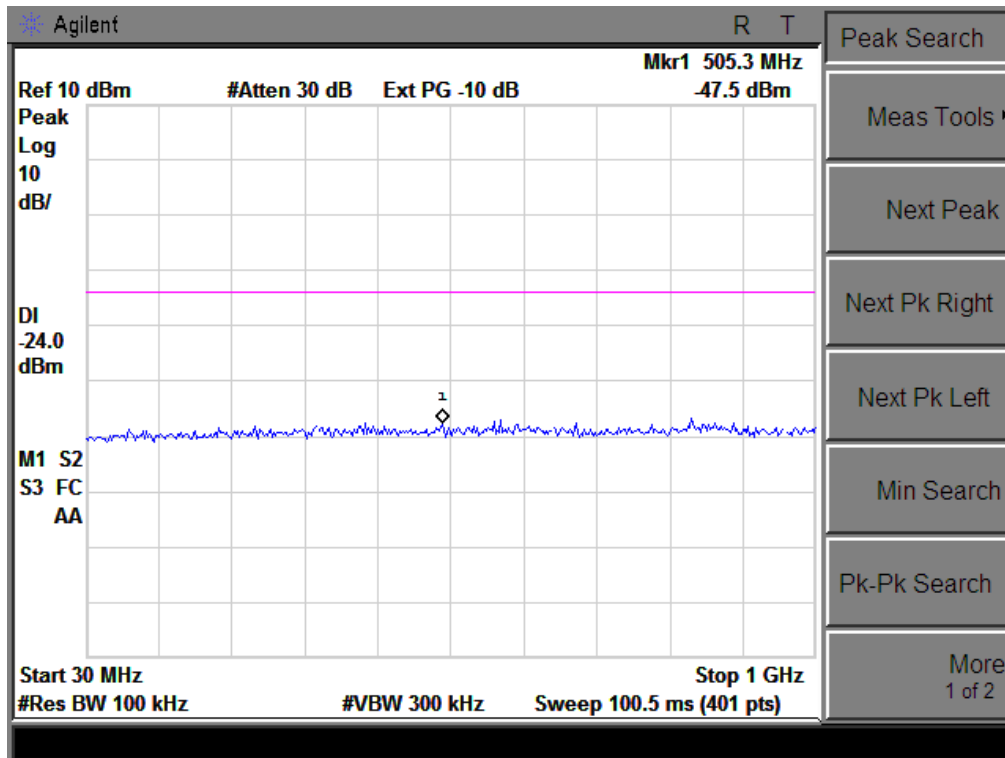

802.11n-HT40 High Channel

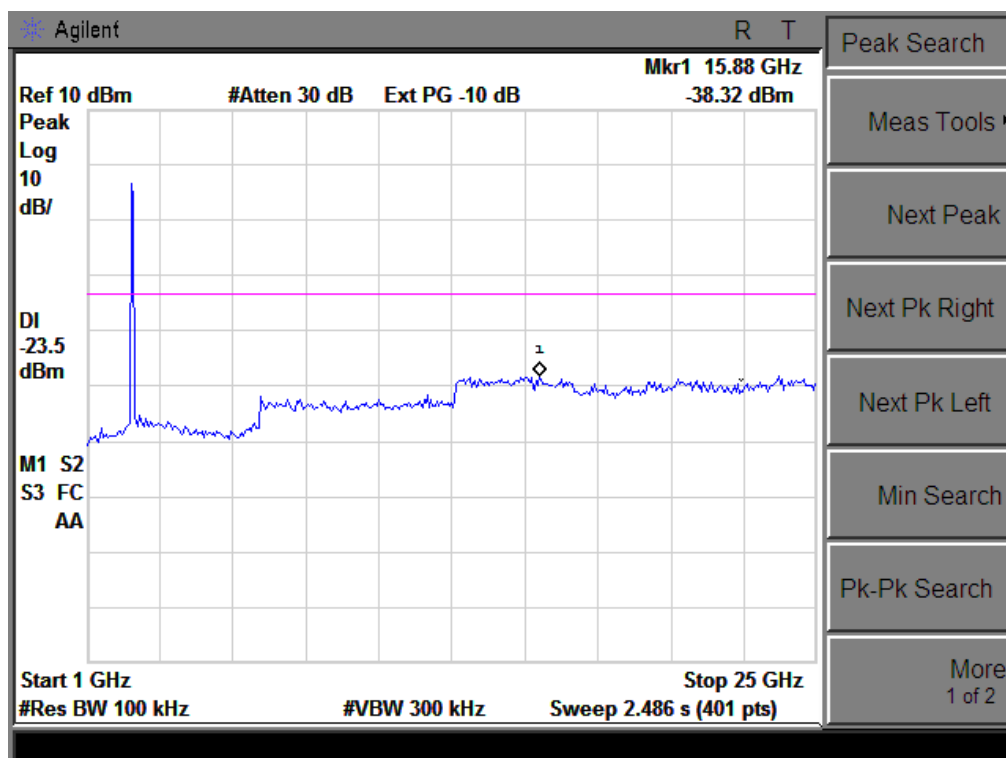
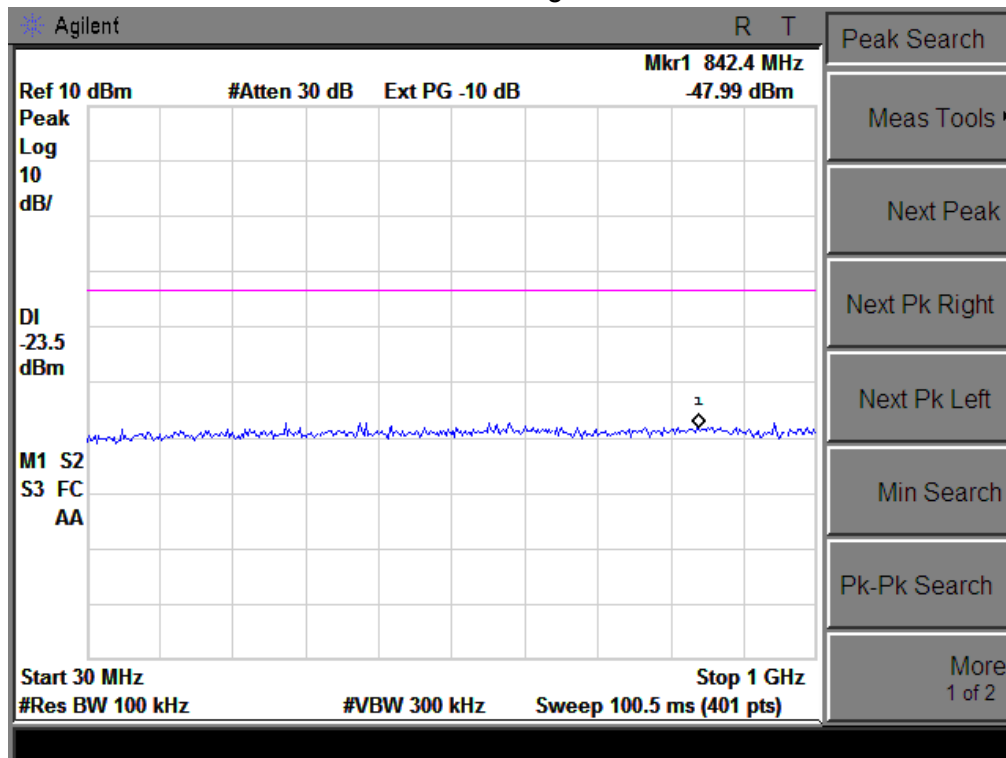

4. POWER SPECTRAL DENSITY TEST

4.1 APPLIED PROCEDURES / LIMIT

FCC Part15 (15.247) , Subpart C				
Section	Test Item	Limit	Frequency Range (MHz)	Result
15.247	Power Spectral Density	8 dBm (in any 3KHz)	2400-2483.5	PASS

4.1.1 TEST PROCEDURE

1. Set analyzer center frequency to DTS channel center frequency.
2. Set the span to 1.5 times the DTS channel bandwidth.
3. 3 kHz ≤Set the RBW≤100 kHz.
4. Set the VBW ≥ 3 x RBW.
5. Detector = peak.
6. Sweep time = auto couple.
7. Trace mode = max hold.
8. Allow trace to fully stabilize.
9. Use the peak marker function to determine the maximum amplitude level within the RBW.
10. If measured value exceeds limit, reduce RBW (no less than 3 kHz) and repeat.

4.1.2 DEVIATION FROM STANDARD

No deviation.

4.1.3 TEST SETUP

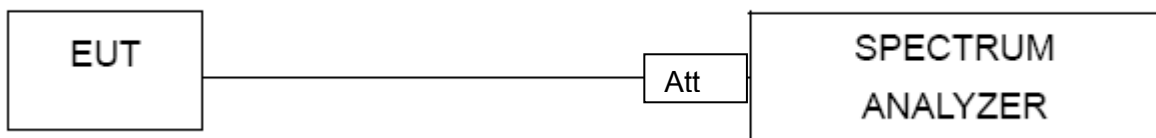

4.1.4 EUT OPERATION CONDITIONS

The EUT tested system was configured as the statements of 2.1 Unless otherwise a special operating condition is specified in the follows during the testing.

4.1.5 TEST RESULTS

EUT :	wifi module	Model Name :	WG209
Temperature :	25 °C	Relative Humidity :	56%
Pressure :	1015 hPa	Test Voltage :	DC 5V
Test Mode :	TX b Mode /CH01, CH06, CH11		

Frequency	Power Density (dBm)	Limit (dBm)	Result
2412 MHz	-12.91	8	PASS
2437 MHz	-12.58	8	PASS
2462 MHz	-14.63	8	PASS

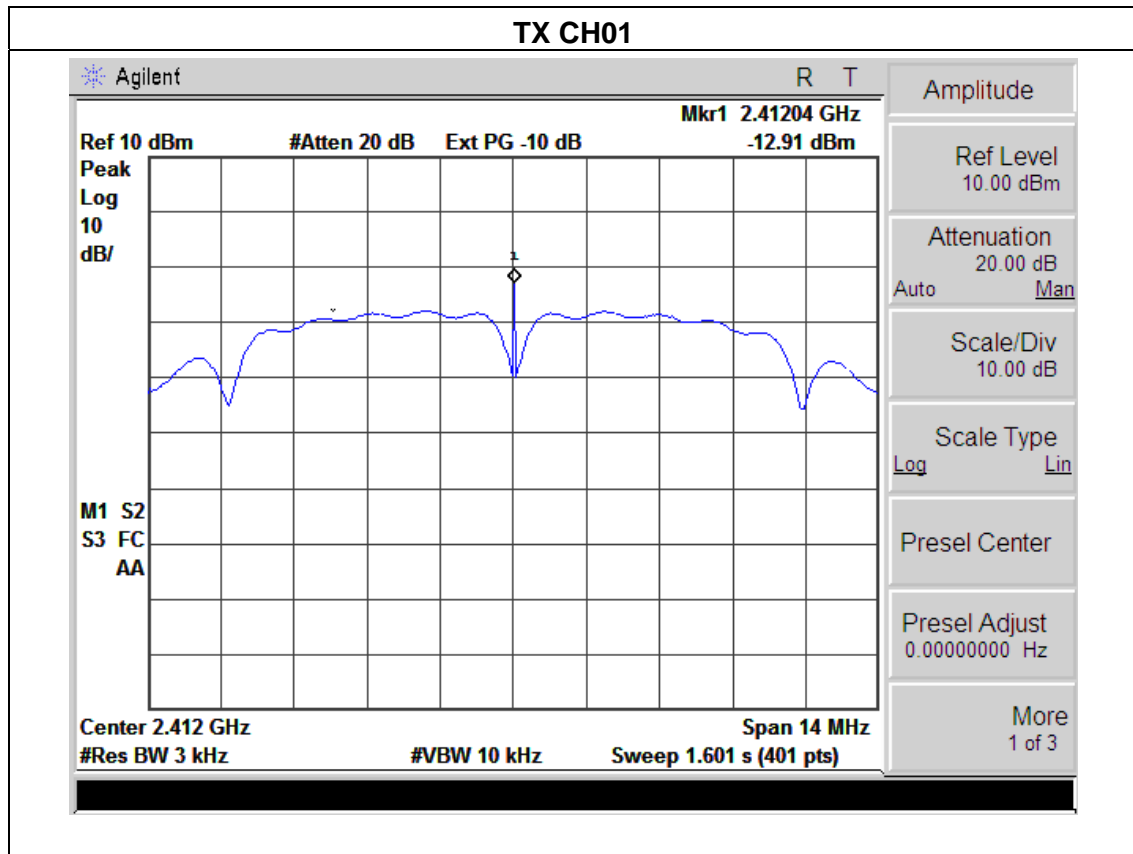

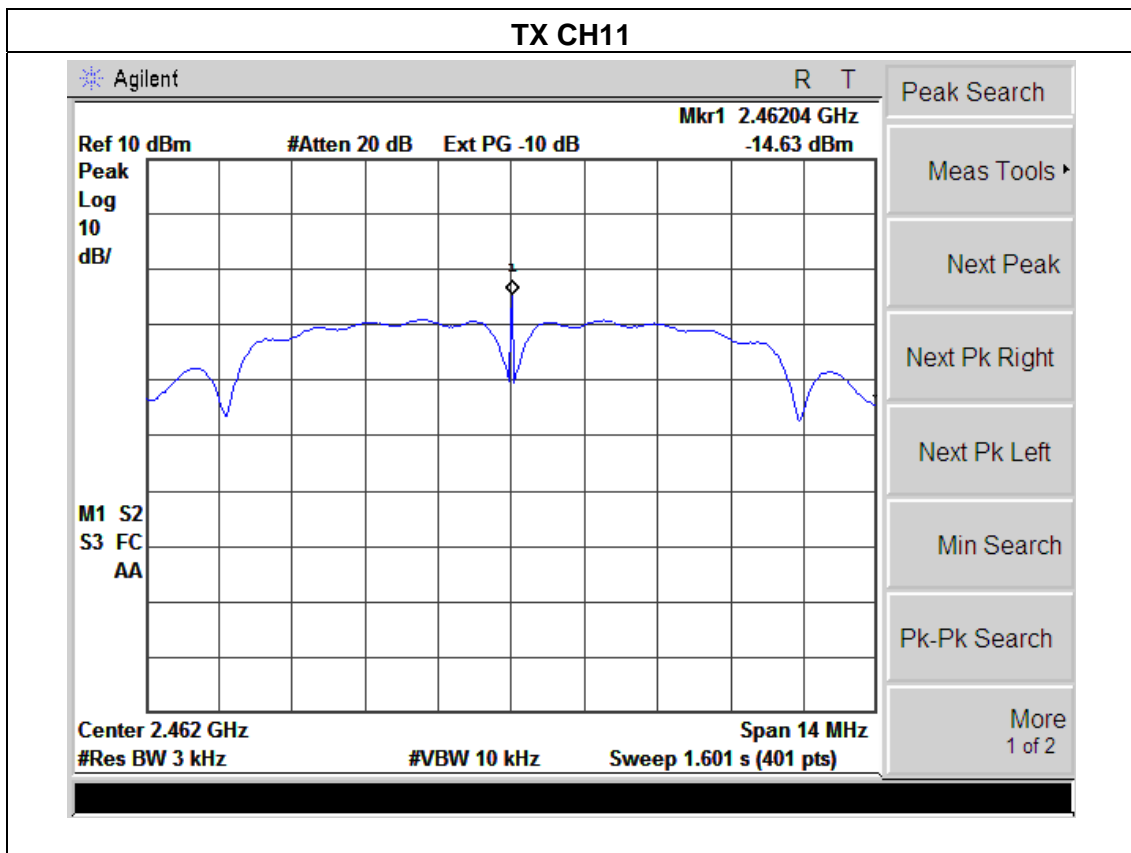
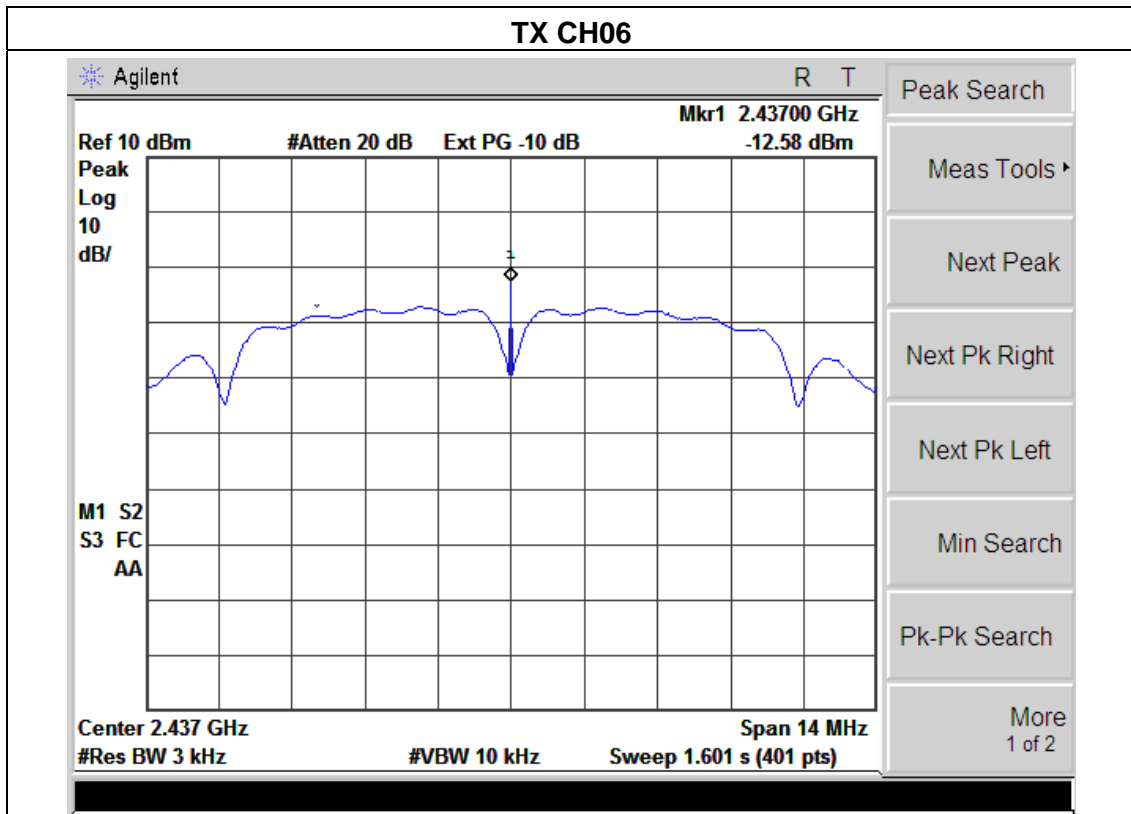

EUT :	wifi module	Model Name :	WG209
Temperature :	25 °C	Relative Humidity :	56%
Pressure :	1015 hPa	Test Voltage :	DC 5V
Test Mode :	TX g Mode /CH01, CH06, CH11		

Frequency	Power Density (dBm)	Limit (dBm)	Result
2412 MHz	-19.80	8	PASS
2437 MHz	-20.99	8	PASS
2462 MHz	-21.82	8	PASS

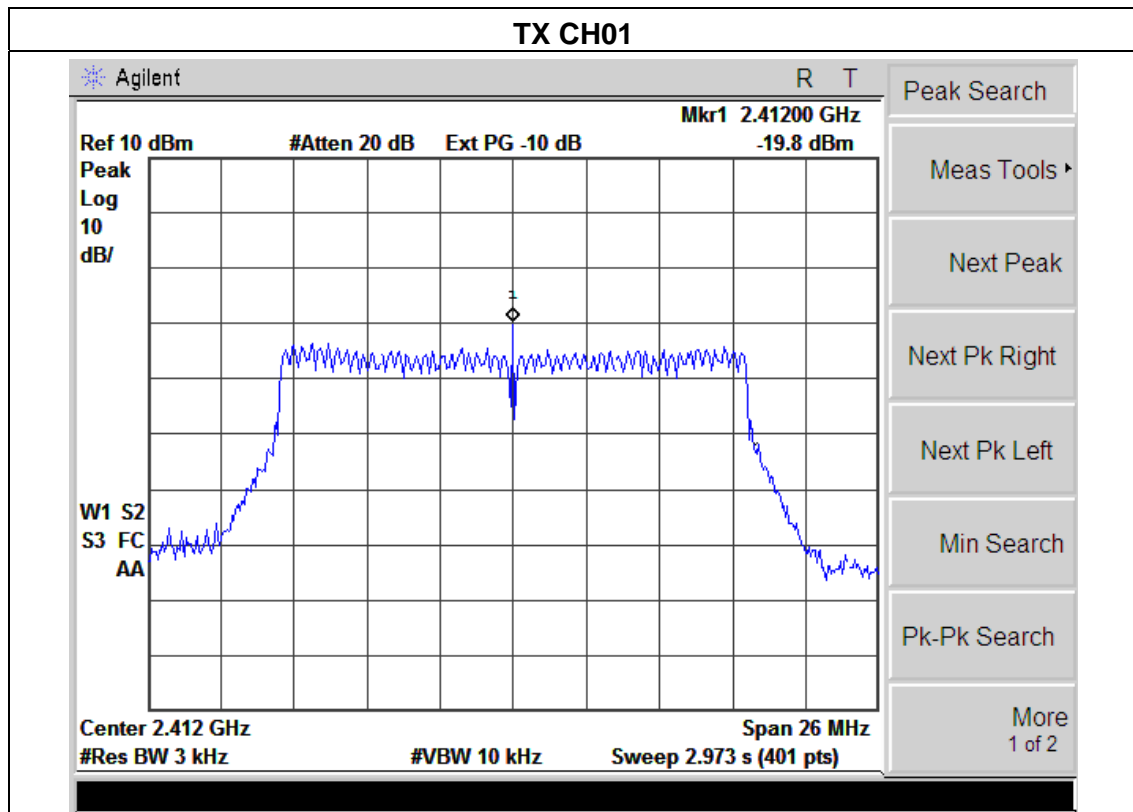

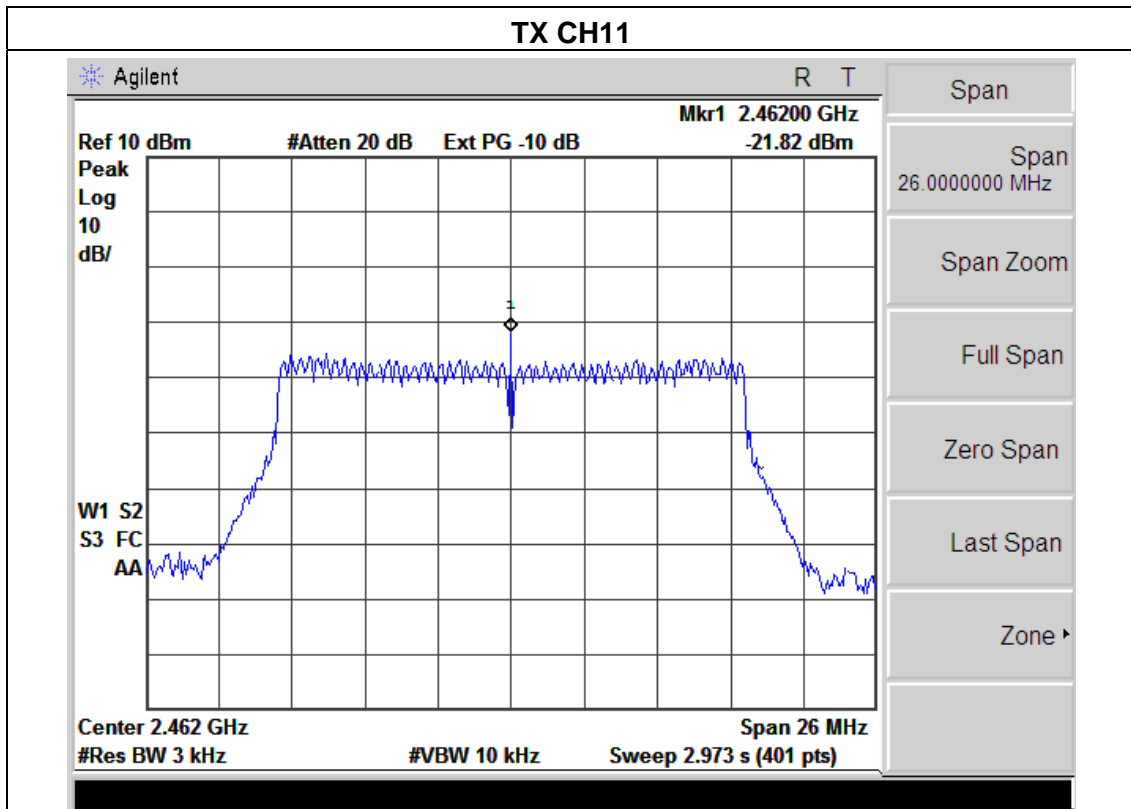
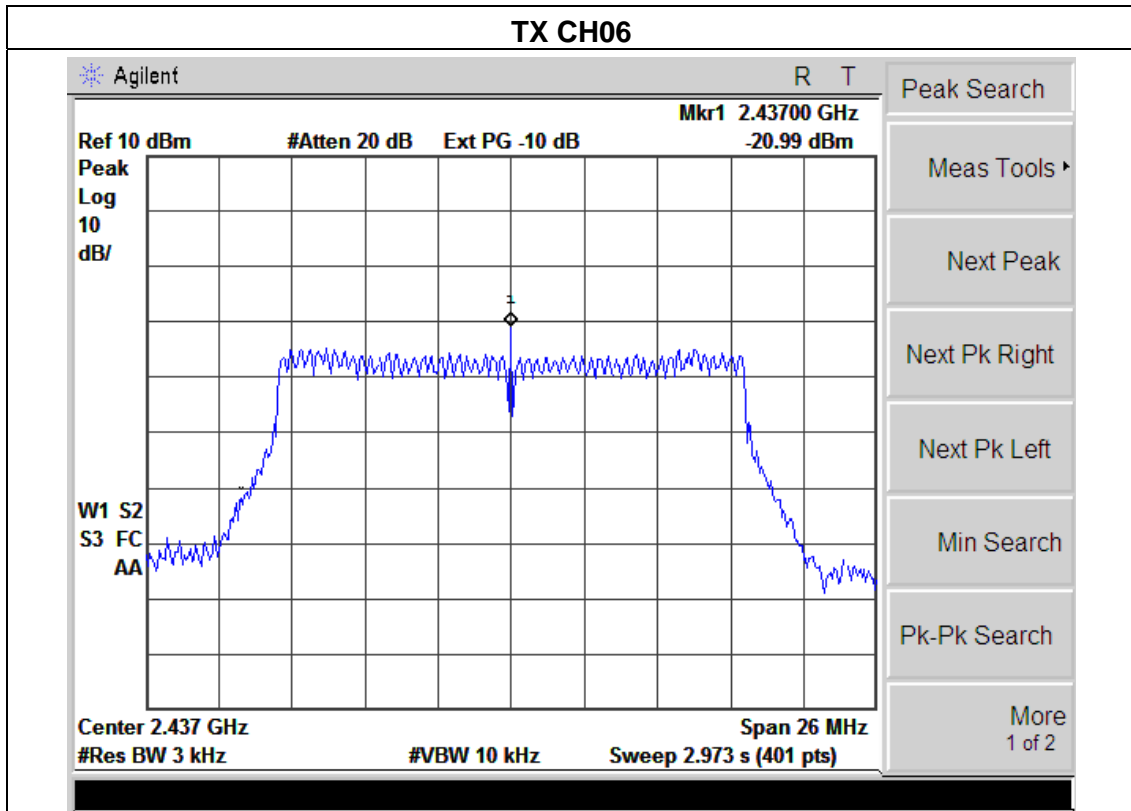

EUT :	wifi module	Model Name :	WG209
Temperature :	25 °C	Relative Humidity :	56%
Pressure :	1015 hPa	Test Voltage :	DC 5V
Test Mode :	TX n Mode(20M) /CH01, CH06, CH11		

Frequency	Power Density (dBm)	Limit (dBm)	Result
2412 MHz	-19.44	8	PASS
2437 MHz	-20.52	8	PASS
2462 MHz	-21.54	8	PASS

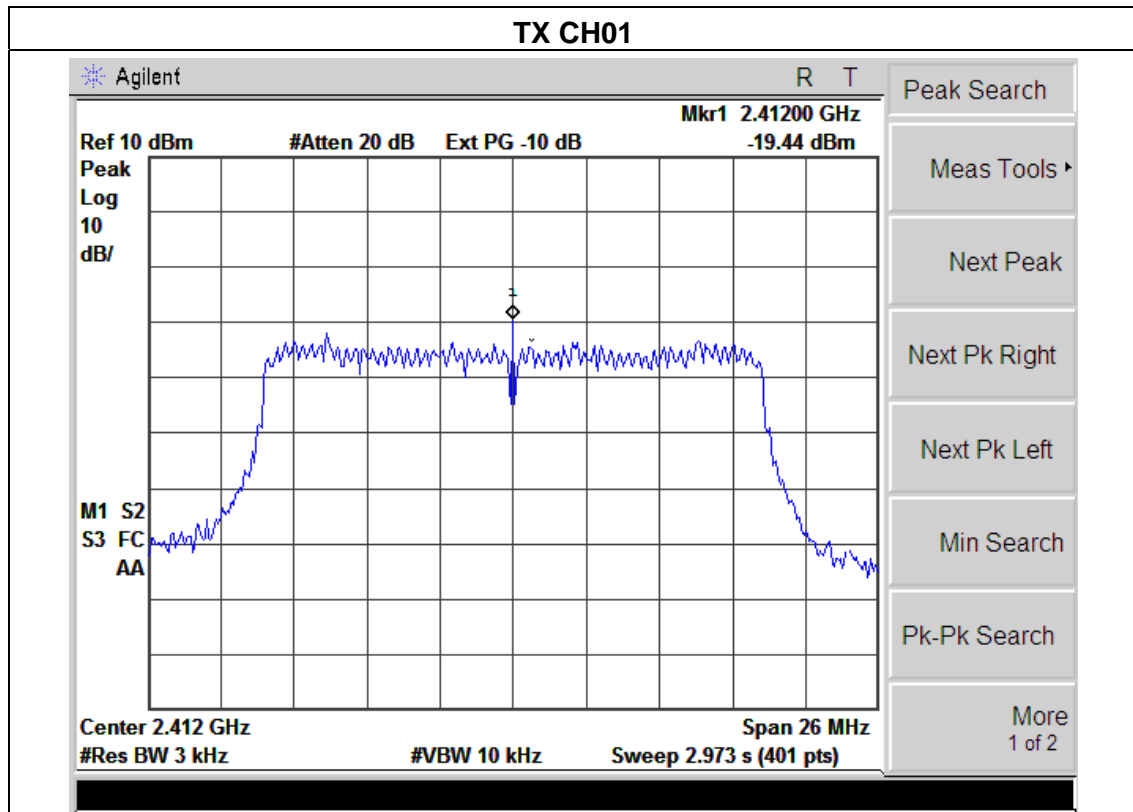

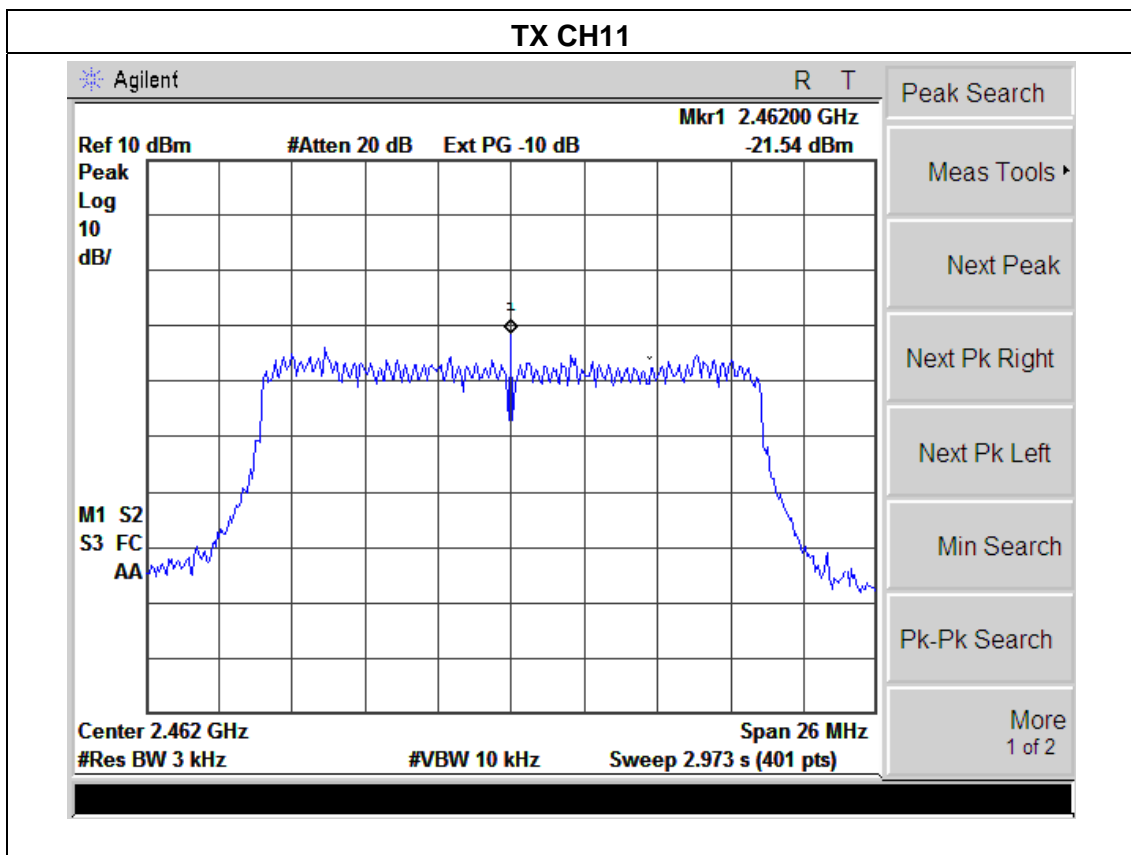
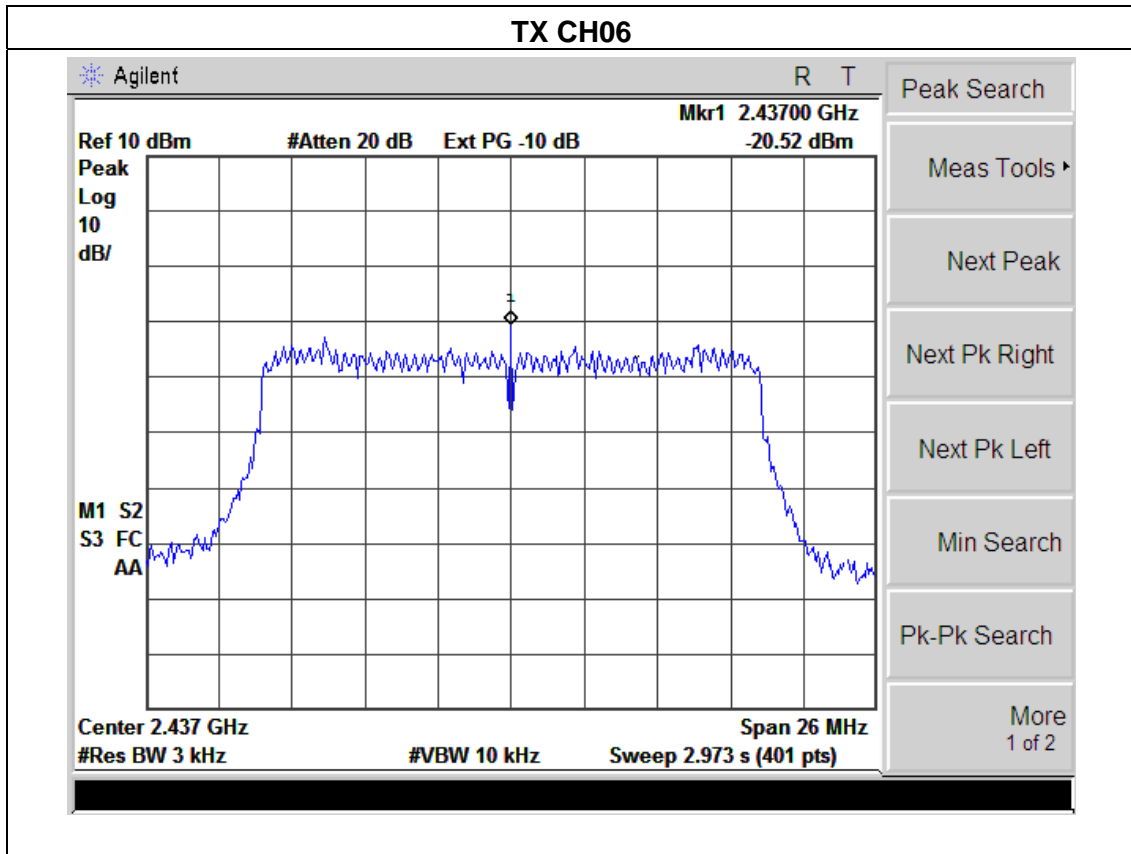

EUT :	wifi module	Model Name :	WG209
Temperature :	25 °C	Relative Humidity :	56%
Pressure :	1015 hPa	Test Voltage :	DC 5V
Test Mode :	TX n Mode(40M) /CH03, CH06, CH09		

Frequency	Power Density (dBm)	Limit (dBm)	Result
2422 MHz	-19.91	8	PASS
2437 MHz	-20.56	8	PASS
2452 MHz	-21.07	8	PASS

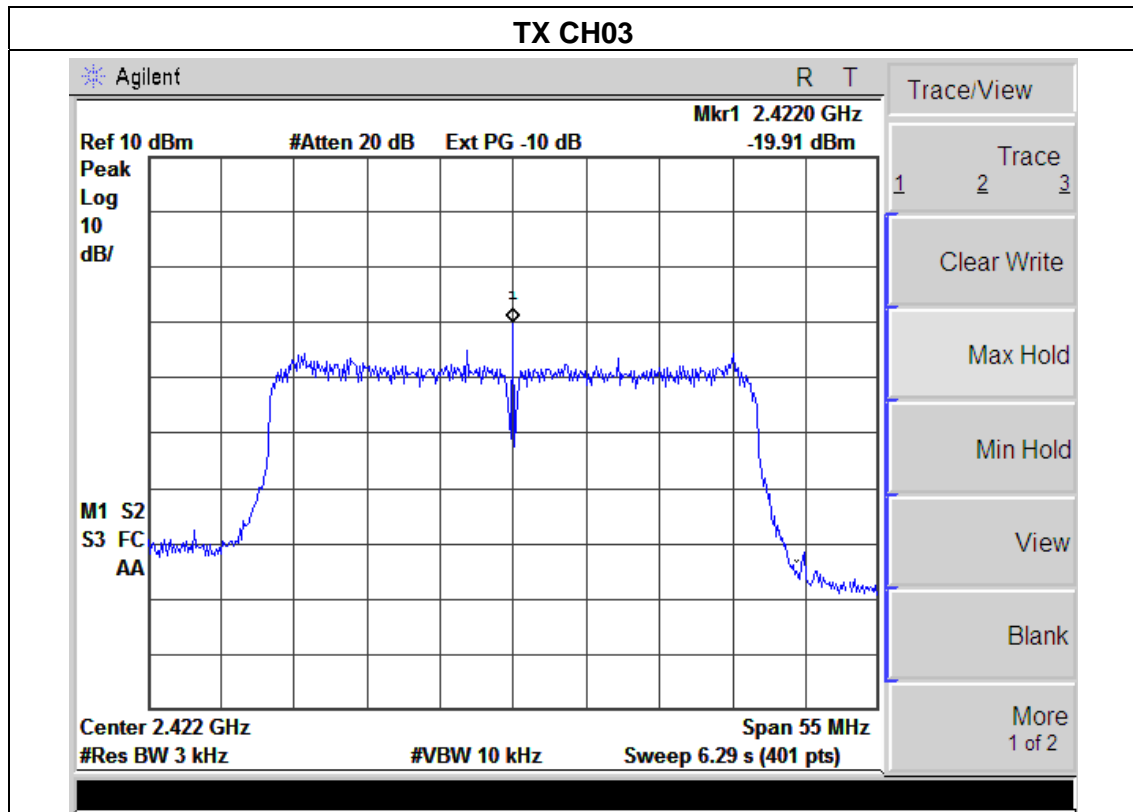

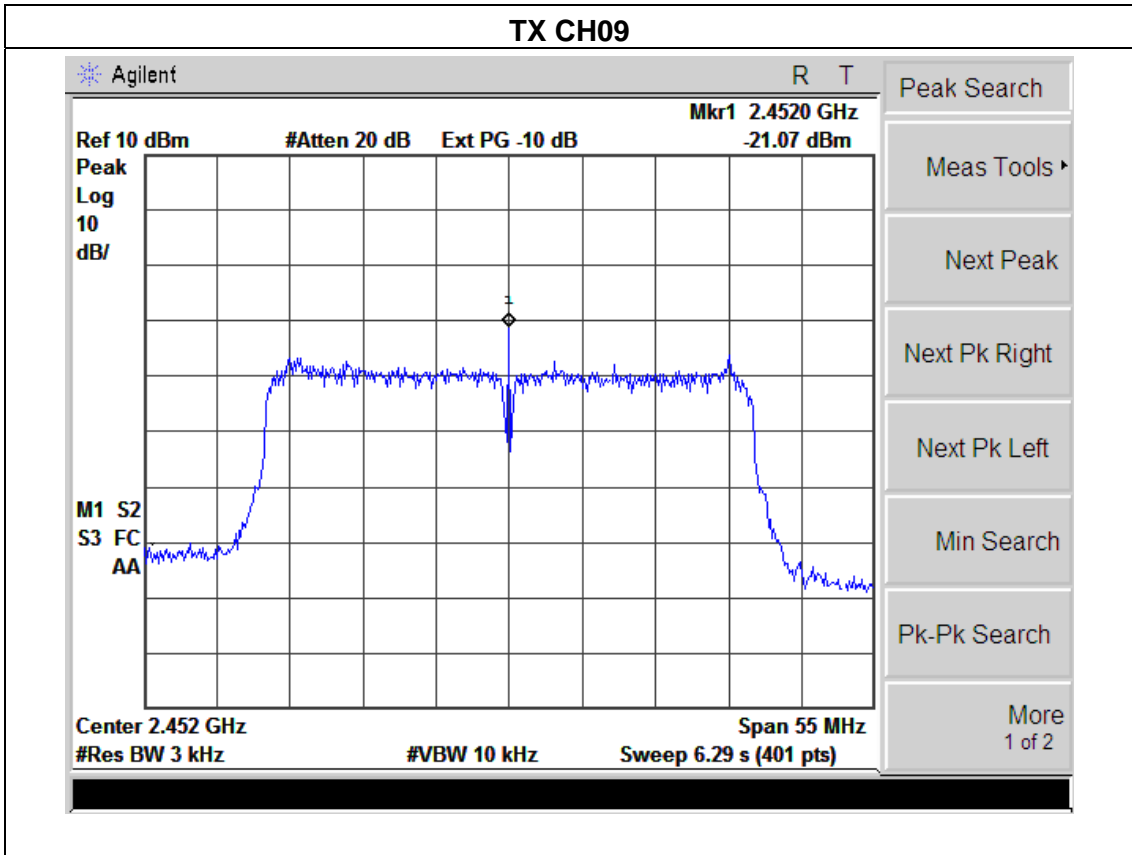
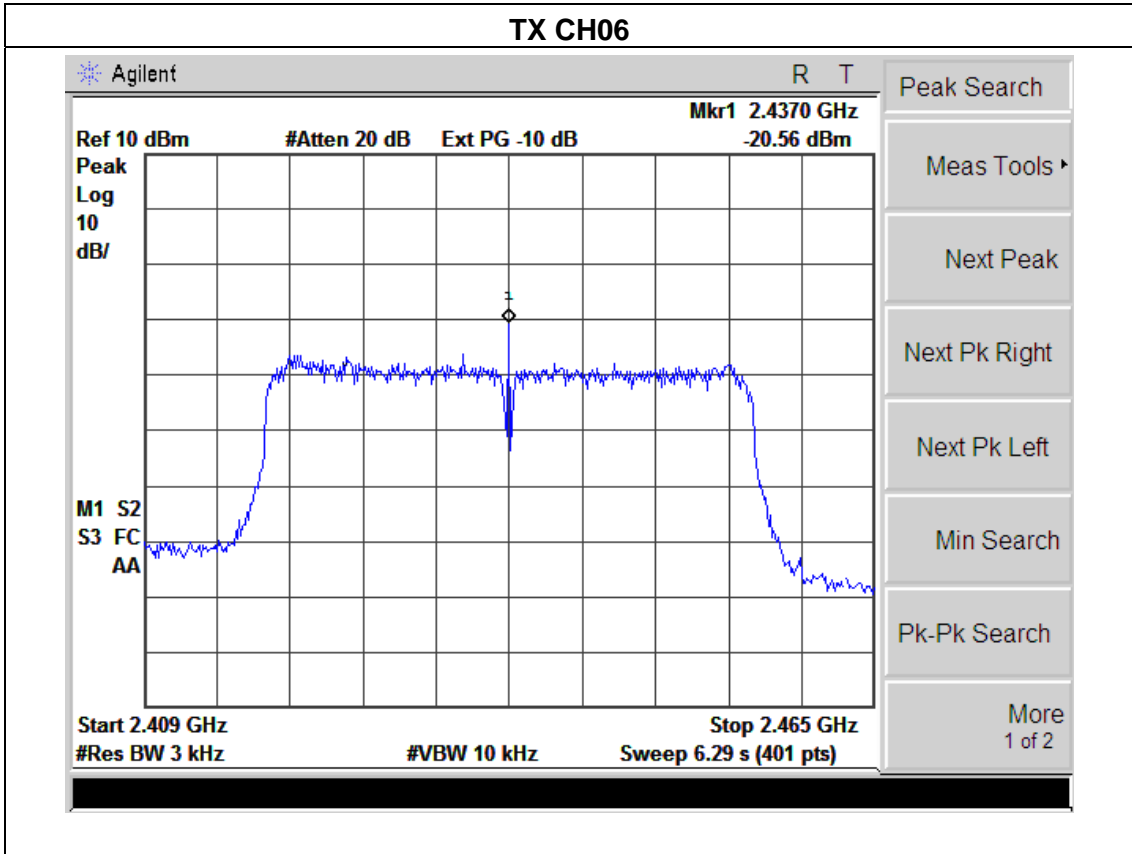

5. BANDWIDTH TEST

5.1 APPLIED PROCEDURES / LIMIT

FCC Part15 (15.247) , Subpart C				
Section	Test Item	Limit	Frequency Range (MHz)	Result
15.247(a)(2)	Bandwidth	$\geq 500\text{KHz}$ (6dB bandwidth)	2400-2483.5	PASS

5.1.1 TEST PROCEDURE

1. Set RBW = 100 kHz.
2. Set the video bandwidth (VBW) $\geq 3 \times$ RBW.
3. Detector = Peak.
4. Trace mode = max hold.
5. Sweep = auto couple.
6. Allow the trace to stabilize.
7. Measure the maximum width of the emission that is constrained by the frequencies associated with the two outermost amplitude points (upper and lower) that are attenuated by 6 dB relative to the maximum level measured in the fundamental emission.

TEST SETUP

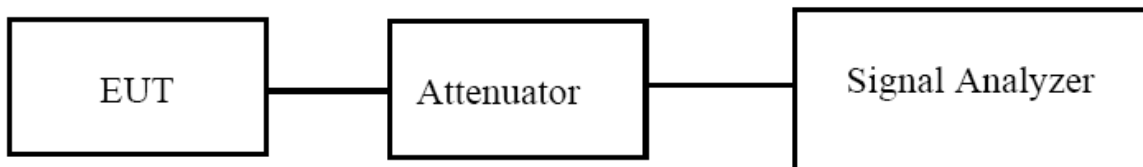

5.1.2 EUT OPERATION CONDITIONS

The EUT tested system was configured as the statements of 2.4 Unless otherwise a special operating condition is specified in the follows during the testing.

5.1.3 TEST RESULTS

EUT :	wifi module	Model Name :	WG209
Temperature :	25 °C	Relative Humidity :	56%
Pressure :	1012 hPa	Test Voltage :	DC 5V
Test Mode :	TX b Mode /CH01, CH06, CH11		

Channel	Frequency (MHz)	6dB bandwidth (MHz)	Limit (kHz)	Result
Low	2412	10.101	500	Pass
Middle	2437	10.113	500	Pass
High	2462	10.111	500	Pass

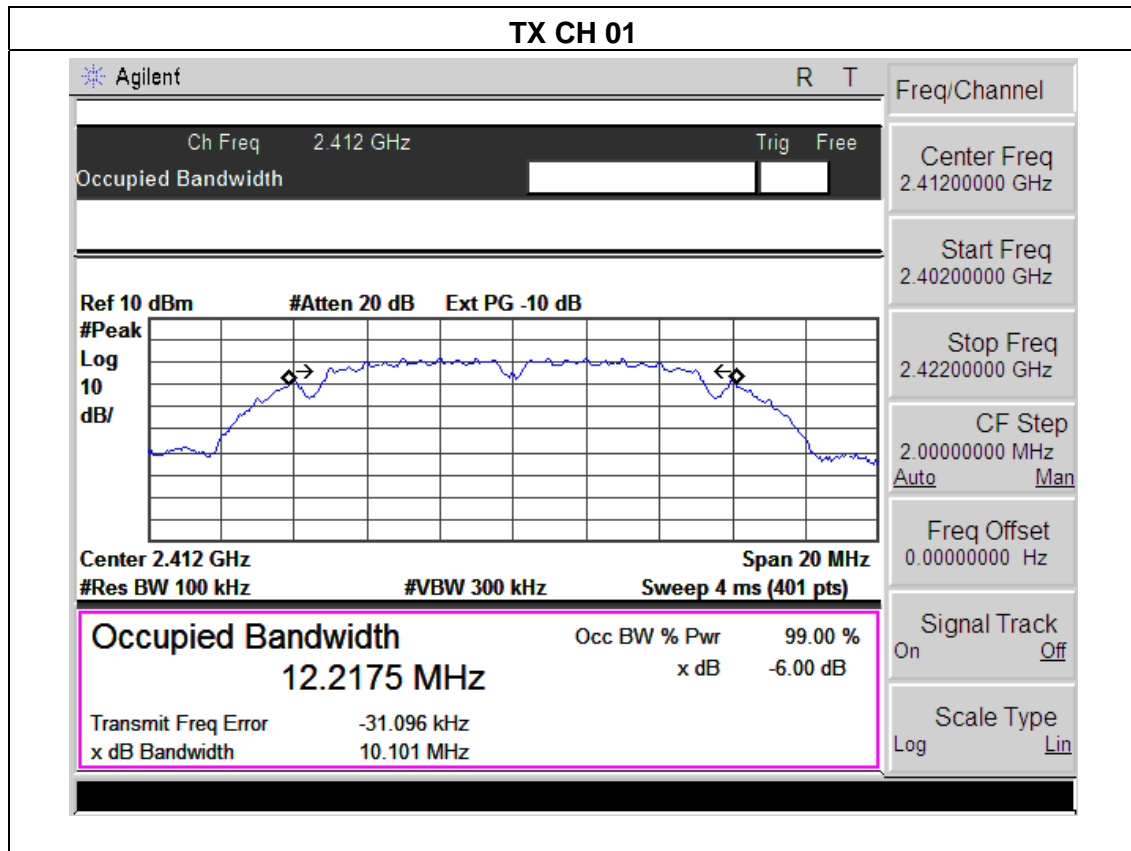

TX CH 06

Agilent
R T

Ch Freq 2.437 GHz
Trig Free

Occupied Bandwidth

Center 2.437000000 GHz

Ref 10 dBm
#Atten 20 dB
Ext PG -10 dB

#Peak
Log
10
dB/

Center 2.437 GHz Span 20 MHz

#Res BW 100 kHz #VBW 300 kHz Sweep 4 ms (401 pts)

Occupied Bandwidth	Occ BW % Pwr	99.00 %
12.2255 MHz	x dB	-6.00 dB
Transmit Freq Error	-42.207 kHz	
x dB Bandwidth	10.113 MHz	

Freq/Channel

Center Freq 2.43700000 GHz

Start Freq 2.42700000 GHz

Stop Freq 2.44700000 GHz

CF Step 2.00000000 MHz
Auto Man

Freq Offset 0.00000000 Hz

Signal Track On Off

Scale Type Log Lin

TX CH 11

Agilent
R T

Ch Freq 2.462 GHz
Trig Free

Occupied Bandwidth

Ref 10 dBm
#Atten 20 dB
Ext PG -10 dB

#Peak
Log
10
dB/

Center 2.462 GHz Span 20 MHz

#Res BW 100 kHz #VBW 300 kHz Sweep 4 ms (401 pts)

Occupied Bandwidth	Occ BW % Pwr	99.00 %
12.2288 MHz	x dB	-6.00 dB
Transmit Freq Error	-42.371 kHz	
x dB Bandwidth	10.111 MHz	

Trace/View

Trace 1 2 3

Clear Write

Max Hold

Min Hold

View

Blank

More 1 of 2

EUT :	wifi module	Model Name :	WG209
Temperature :	25 °C	Relative Humidity :	60%
Pressure :	1012 hPa	Test Voltage :	DC 5V
Test Mode :	TX g Mode /CH01, CH06, CH11		

Channel	Frequency (MHz)	6dB bandwidth (MHz)	Limit (kHz)	Result
Low	2412	16.565	500	Pass
Middle	2437	16.590	500	Pass
High	2462	16.533	500	Pass

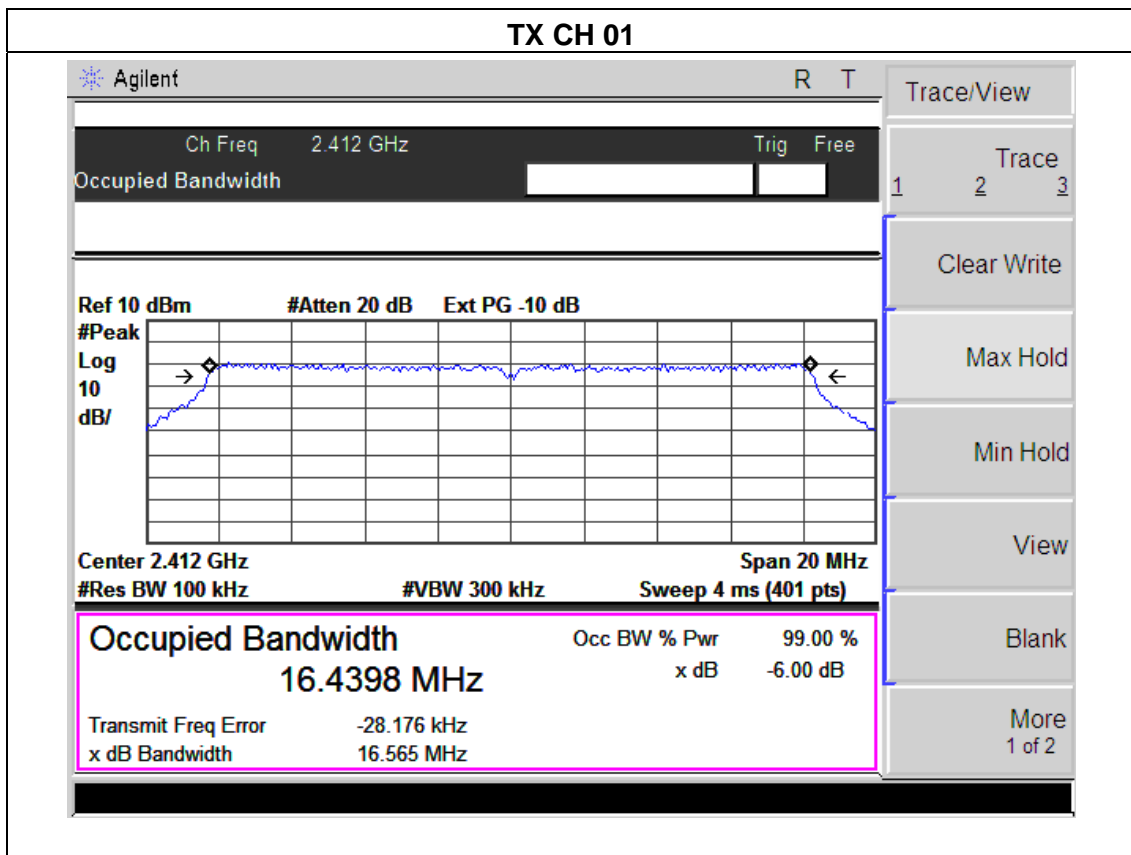

TX CH 06

Agilent
R T

Ch Freq 2.437 GHz
Trig Free

Occupied Bandwidth

Ref 10 dBm
#Atten 20 dB
Ext PG -10 dB

#Peak
Log
10
dB/

Center 2.437 GHz Span 20 MHz

#Res BW 100 kHz #VBW 300 kHz

Occupied Bandwidth

16.4298 MHz

Transmit Freq Error -23.785 kHz

x dB Bandwidth 16.590 MHz

Freq/Channel

Center Freq 2.43700000 GHz

Start Freq 2.42700000 GHz

Stop Freq 2.44700000 GHz

CF Step 2.00000000 MHz

Auto Man

Freq Offset 0.00000000 Hz

Signal Track On Off

Scale Type Log Lin

TX CH 11

Agilent
R T

Ch Freq 2.462 GHz
Trig Free

Occupied Bandwidth

Ref 10 dBm
#Atten 20 dB
Ext PG -10 dB

#Peak
Log
10
dB/

Center 2.462 GHz Span 20 MHz

#Res BW 100 kHz #VBW 300 kHz

Occupied Bandwidth

16.4203 MHz

Transmit Freq Error -16.655 kHz

x dB Bandwidth 16.533 MHz

Freq/Channel

Center Freq 2.46200000 GHz

Start Freq 2.45200000 GHz

Stop Freq 2.47200000 GHz

CF Step 2.00000000 MHz

Auto Man

Freq Offset 0.00000000 Hz

Signal Track On Off

Scale Type Log Lin

EUT :	wifi module	Model Name :	WG209
Temperature :	25 °C	Relative Humidity :	56%
Pressure :	1012 hPa	Test Voltage :	DC 5V
Test Mode :	TX n Mode(20M) /CH01, CH06, CH11		

Channel	Frequency (MHz)	6dB bandwidth (MHz)	Limit (kHz)	Result
Low	2412	17.647	500	Pass
Middle	2437	17.625	500	Pass
High	2462	17.649	500	Pass

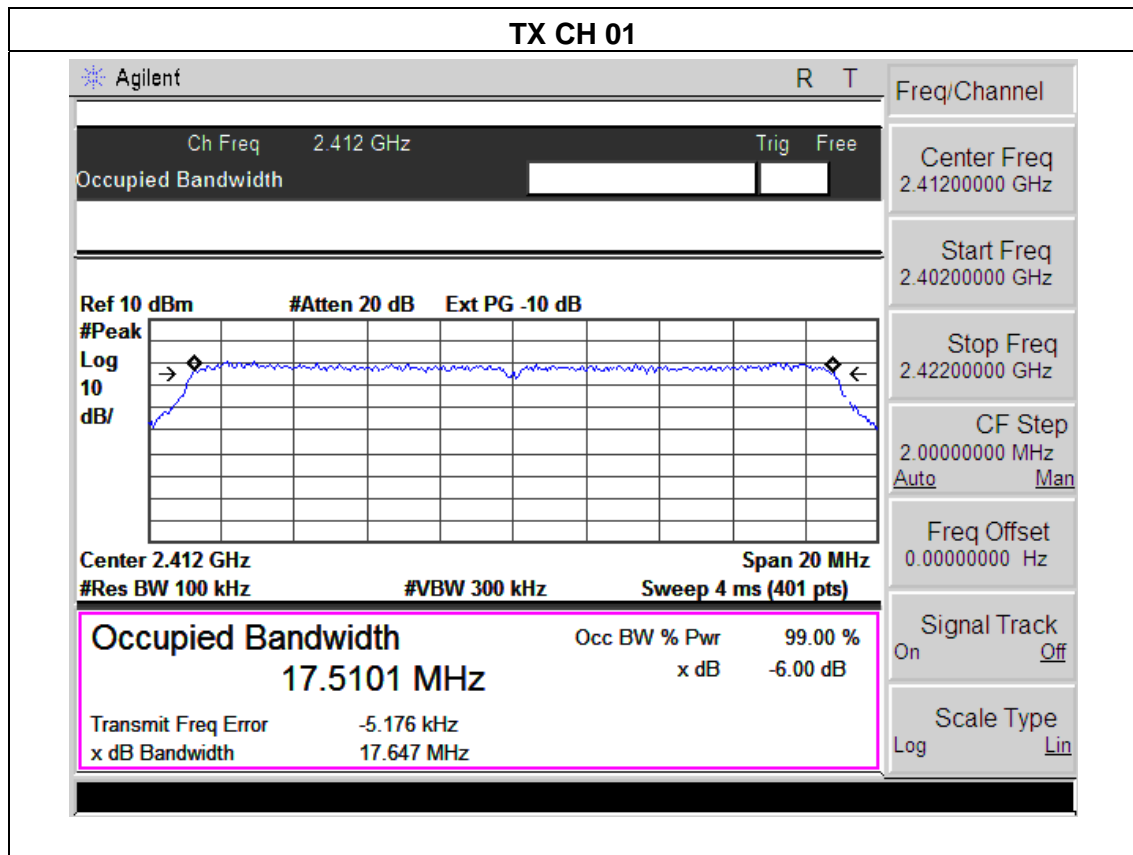

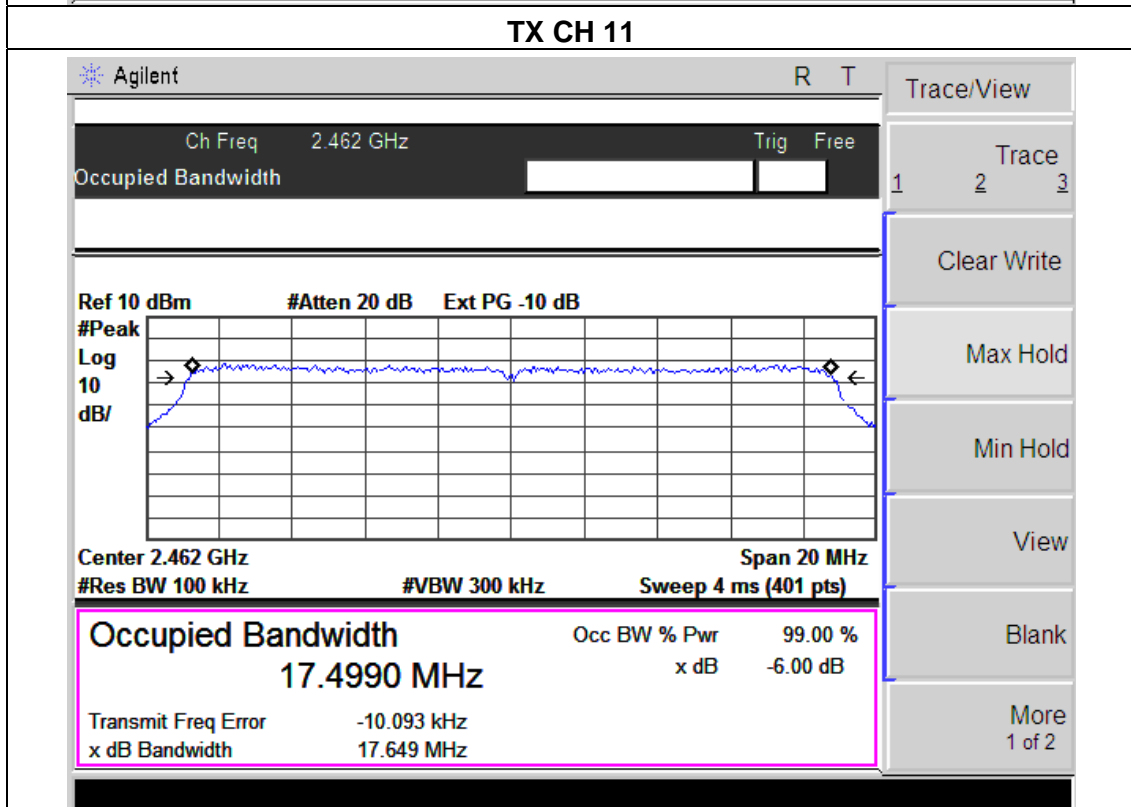
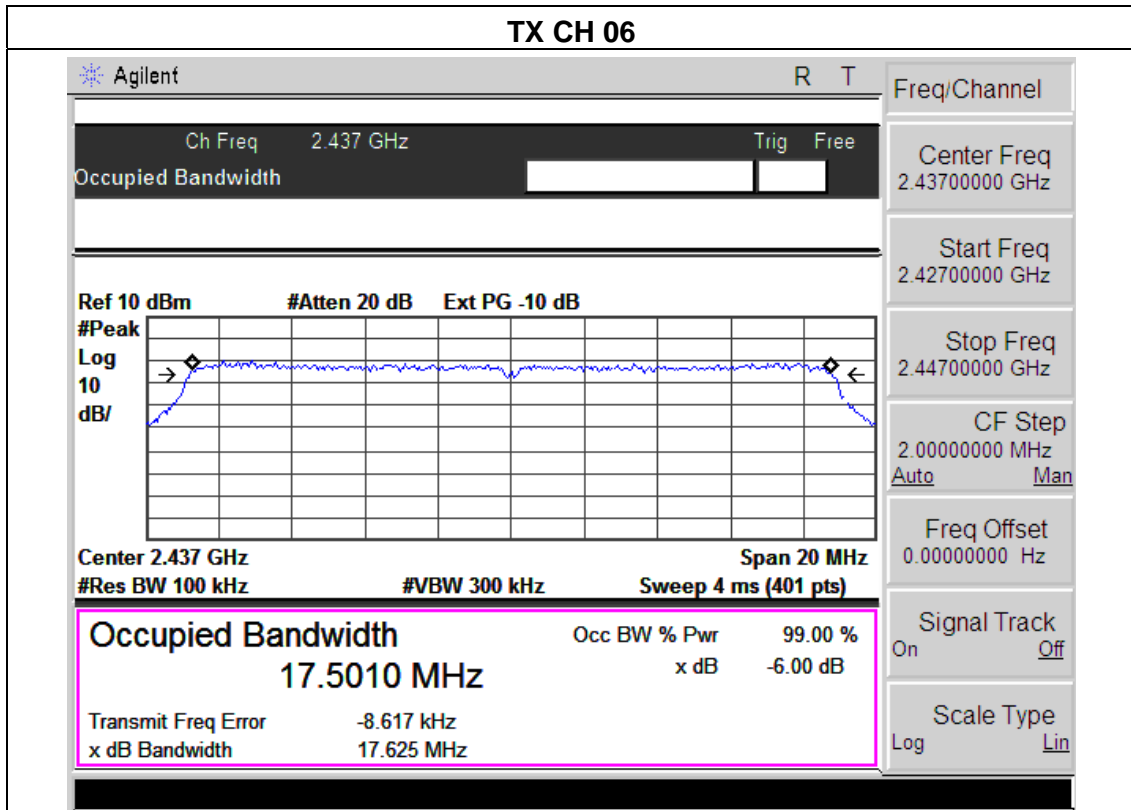

EUT :	wifi module	Model Name :	WG209
Temperature :	25 °C	Relative Humidity :	56%
Pressure :	1012 hPa	Test Voltage :	DC 5V
Test Mode :	TX n Mode(40M) /CH03, CH06, CH09		

Channel	Frequency (MHz)	6dB bandwidth (MHz)	Limit (kHz)	Result
Low	2422	36.304	500	Pass
Middle	2437	36.161	500	Pass
High	2452	36.050	500	Pass

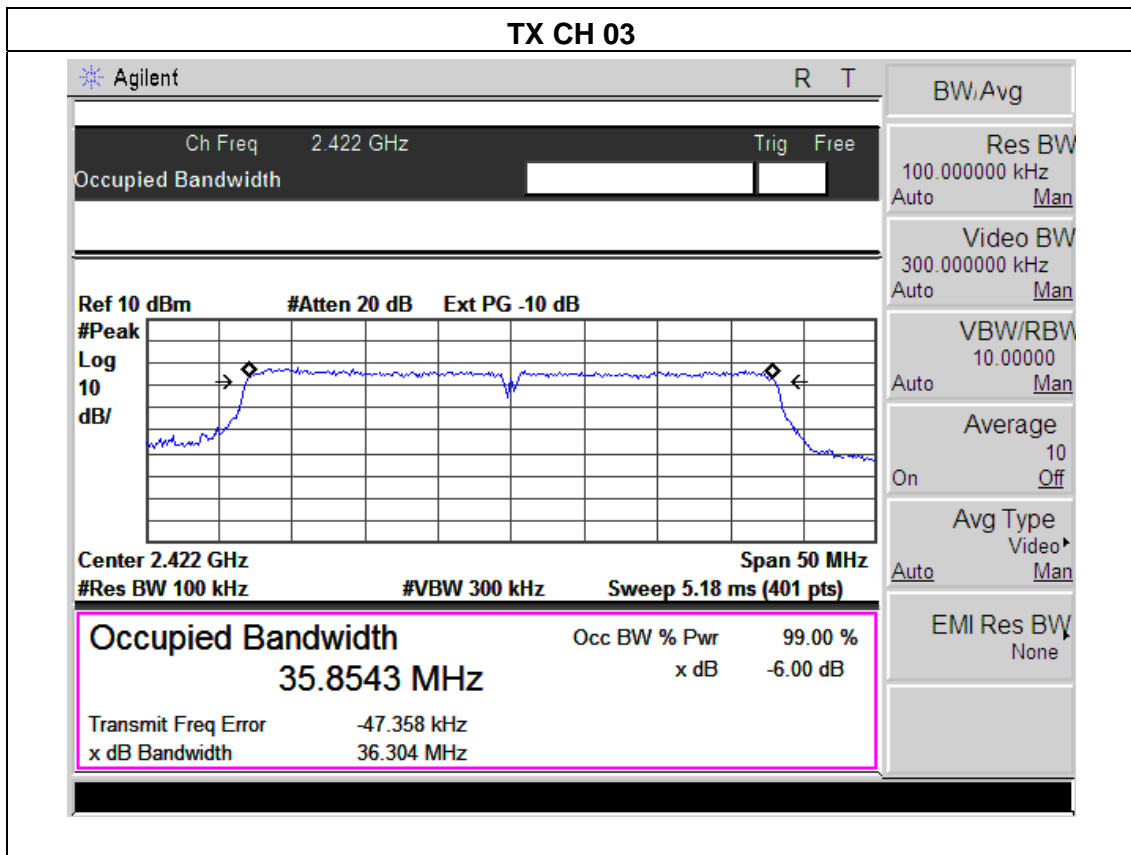

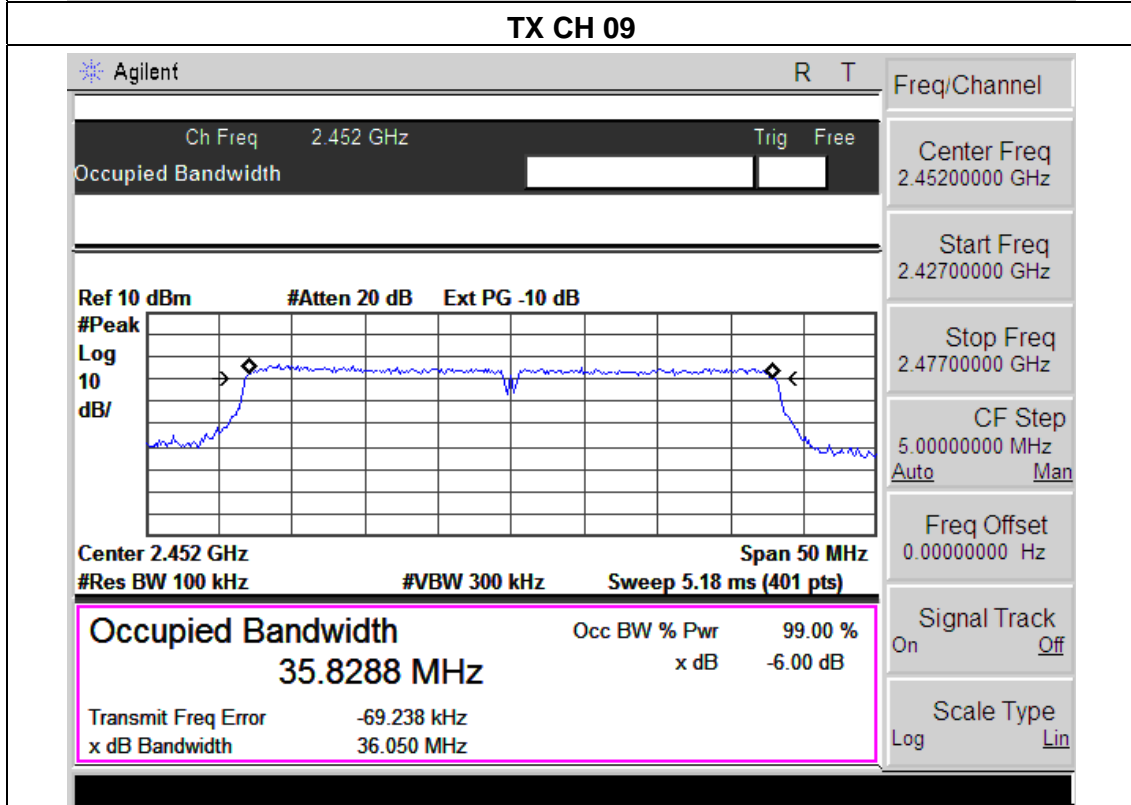
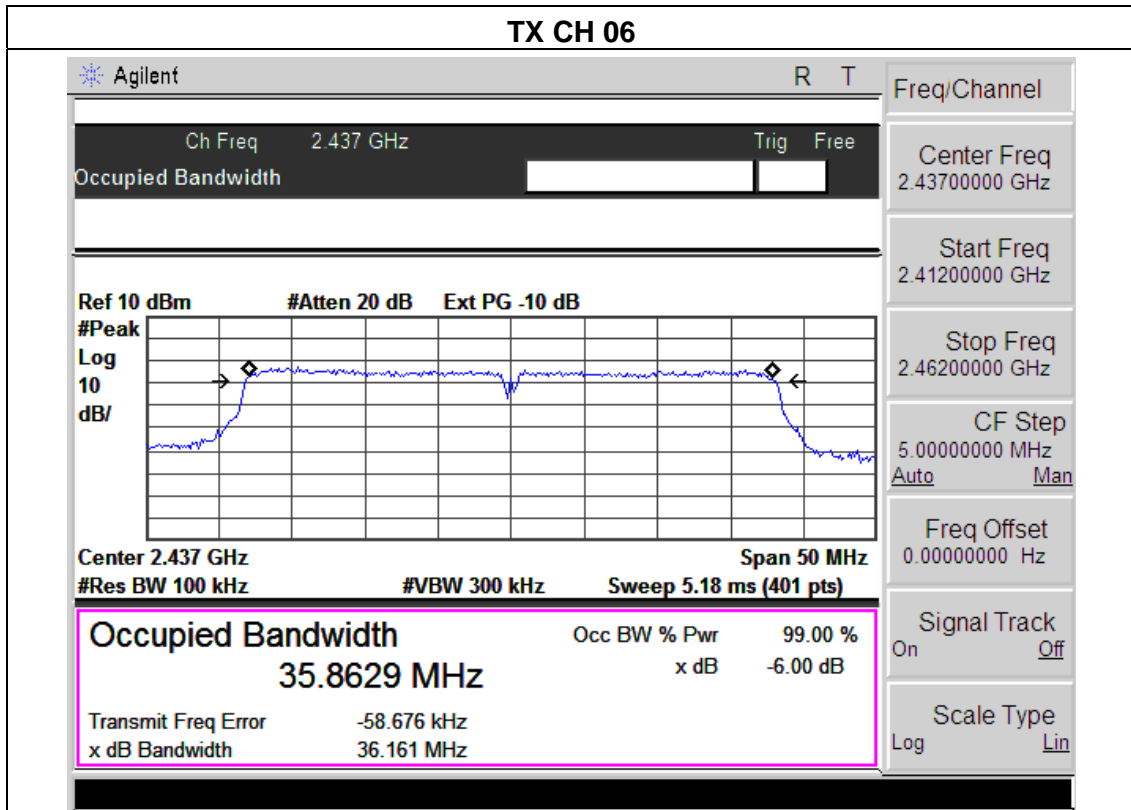

6. PEAK OUTPUT POWER TEST

6.1 APPLIED PROCEDURES / LIMIT

FCC Part15 (15.247) , Subpart C				
Section	Test Item	Limit	Frequency Range (MHz)	Result
15.247(b)(3)	Peak Output Power	1 watt or 30dBm	2400-2483.5	PASS

6.1.1 TEST PROCEDURE

- a. The EUT was directly connected to the Power meter

6.1.2 DEVIATION FROM STANDARD

No deviation.

6.1.3 TEST SETUP



6.1.4 EUT OPERATION CONDITIONS

The EUT tested system was configured as the statements of 2.4 Unless otherwise a special operating condition is specified in the follows during the testing.

6.1.5 TEST RESULTS

EUT :	wifi module	Model Name :	WG209
Temperature :	25 °C	Relative Humidity :	60%
Pressure :	1012 hPa	Test Voltage :	DC 5V
Test Mode :	TX b/g/n20/n40 Mode		

TX 802.11b Mode			
Test Channel	Frequency	Maximum Conducted Output Power	LIMIT
	(MHz)	(dBm)	(dBm)
CH01	2412	17.33	30
CH06	2437	17.42	30
CH11	2462	17.11	30
TX 802.11g Mode			
CH01	2412	15.22	30
CH06	2437	15.19	30
CH11	2462	15.05	30
TX 802.11n-HT20 Mode			
CH01	2412	14.88	30
CH06	2437	14.91	30
CH11	2462	14.96	30
TX 802.11n-HT40 Mode			
CH03	2422	14.66	30
CH06	2437	14.52	30
CH09	2452	14.85	30

7. 100 KHZ BANDWIDTH OF FREQUENCY BAND EDGE

APPLICABLE STANDARD

In any 100 kHz bandwidth outside the frequency band in which the spread spectrum or digitally modulated intentional radiator is operating, the radio frequency power that is produced by the intentional radiator shall be at least 20 dB below that in the 100 kHz bandwidth within the band that contains the highest level of the desired power, based on either an RF conducted or a radiated measurement, provided the transmitter demonstrates compliance with the peak conducted power limits. If the transmitter complies with the conducted power limits based on the use of RMS averaging over a time interval, as permitted under paragraph (b)(3) of this section, the attenuation required under this paragraph shall be 30 dB instead of 20 dB. Attenuation below the general limits specified in §15.209(a) is not required. In addition, radiated emissions which fall in the restricted bands, as defined in §15.205(a), must also comply with the radiated emission limits specified in §15.209(a) (see §15.205(c)).

TEST PROCEDURE

- a) Check the calibration of the measuring instrument using either an internal calibrator or a known signal from an external generator.
- b) Position the EUT without connection to measurement instrument. Turn on the EUT and connect its antenna terminal to measurement instrument via a low loss cable. Then set it to any one measured frequency within its operating range, and make sure the instrument is operated in its linear range.
- c) Set RBW to 100 kHz and VBW of spectrum analyzer to 300 kHz with a convenient frequency span including 100 kHz bandwidth from band edge.
- d) Measure the highest amplitude appearing on spectral display and set it as a reference level. Plot the graph with marking the highest point and edge frequency.
- e) Repeat above procedures until all measured frequencies were complete.

7.1 DEVIATION FROM STANDARD

No deviation.

7.2 TEST SETUP

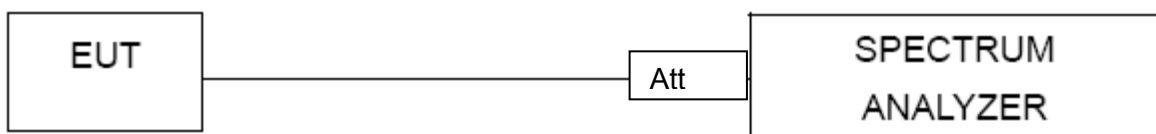

7.3 EUT OPERATION CONDITIONS

The EUT tested system was configured as the statements of 2.4 Unless otherwise a special operating condition is specified in the follows during the testing.

7.4 TEST RESULTS

EUT :	wifi module	Model Name :	WG209
Temperature :	25 °C	Relative Humidity :	56%
Pressure :	1012 hPa	Test Voltage :	DC 5V

Frequency Band	Delta Peak to band emission (dBc)	> Limit (dBc)	Result
802.11b			
Left-band	48.42	20	Pass
Right-band	52.73	20	Pass
802.11g			
Left-band	37.87	20	Pass
Right-band	47.20	20	Pass
802.11n20			
Left-band	39.05	20	Pass
Right-band	46.53	20	Pass
802.11n40			
Left-band	35.68	20	Pass
Right-band	40.54	20	Pass

Radiated band edge:

Frequency (MHz)	Meter Reading (dBµV)	Factor (dB)	Emission Level (dBµV/m)	Limits (dBµV/m)	Margin (dB)	Detector Type	Comment
802.11b							
2390	61.37	-13.06	48.31	74	-25.69	peak	Vertical
2390	62.21	-13.06	49.15	74	-24.85	peak	Horizontal
2483.5	62.21	-12.78	49.43	74	-24.57	peak	Vertical
2483.5	58.75	-12.78	45.97	74	-28.03	peak	Horizontal
802.11g							
2390	61.42	-13.06	48.36	74	-25.64	peak	Vertical
2390	58.3	-13.06	45.24	74	-28.76	peak	Horizontal
2483.5	62.52	-12.78	49.74	74	-24.26	peak	Vertical
2483.5	62.2	-12.78	49.42	74	-24.58	peak	Horizontal
802.11n(20)							
2390	59.95	-13.06	46.89	74	-27.11	peak	Vertical
2390	61.03	-13.06	47.97	74	-26.03	peak	Horizontal
2483.5	61.22	-12.78	48.44	74	-25.56	peak	Vertical
2483.5	58.52	-12.78	45.74	74	-28.26	peak	Horizontal
802.11n(40)							
2390	58.9	-13.06	45.84	74	-28.16	peak	Vertical
2390	60.2	-13.06	47.14	74	-26.86	peak	Horizontal
2483.5	60.17	-12.78	47.39	74	-26.61	peak	Vertical
2483.5	58.47	-12.78	45.69	74	-28.31	peak	Horizontal

Note: Test method to see chapter 3.2 . When PK value is lower than the Average value limit, average not record.

802.11b: Band Edge, Left Side

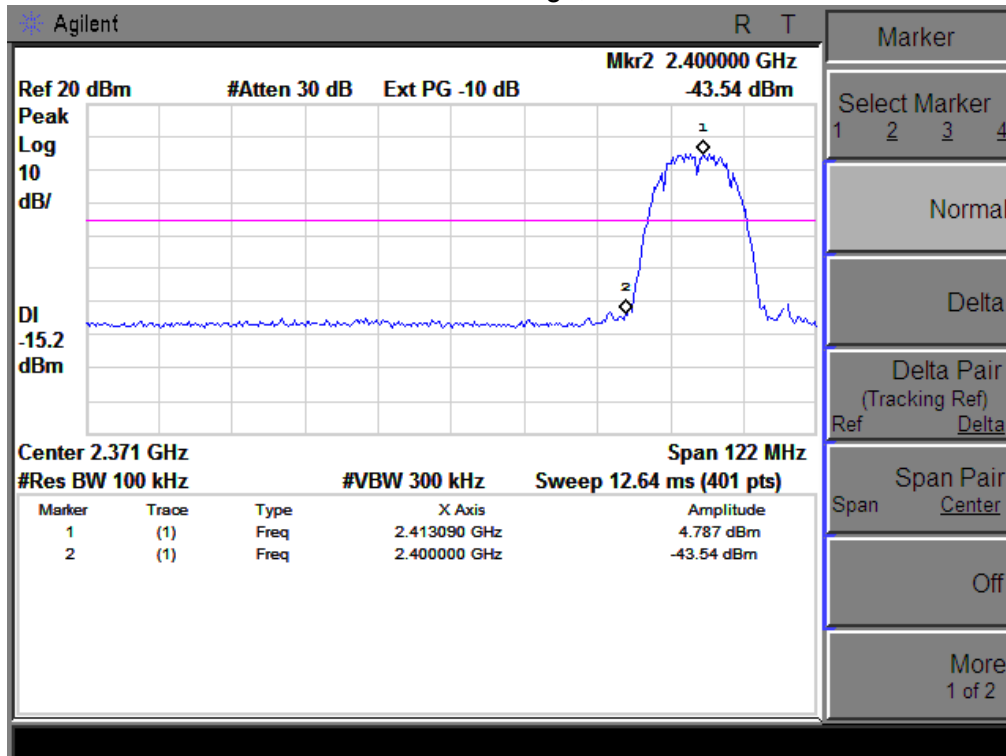

802.11b: Band Edge, Right Side

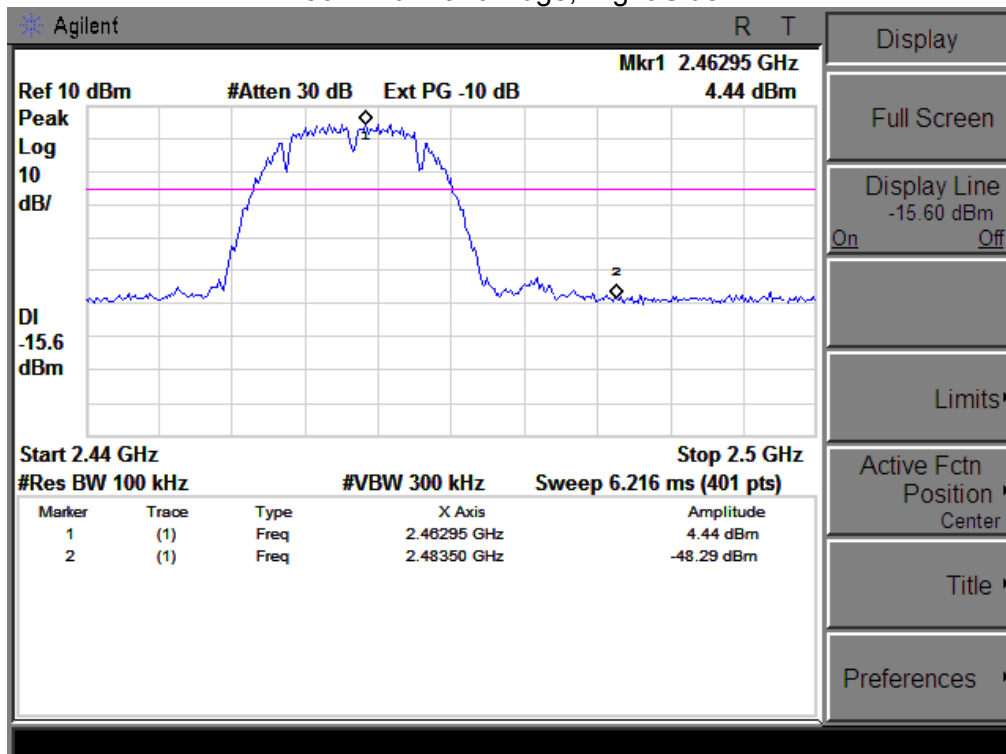

802.11g: Band Edge, Left Side

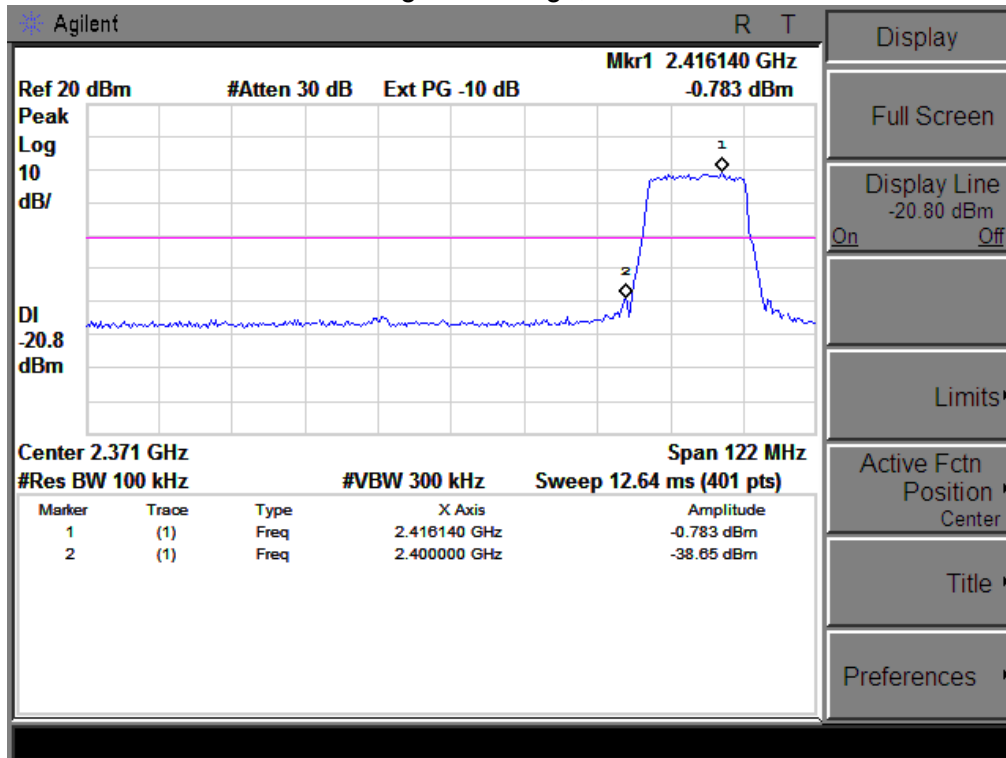

802.11g: Band Edge, Right Side

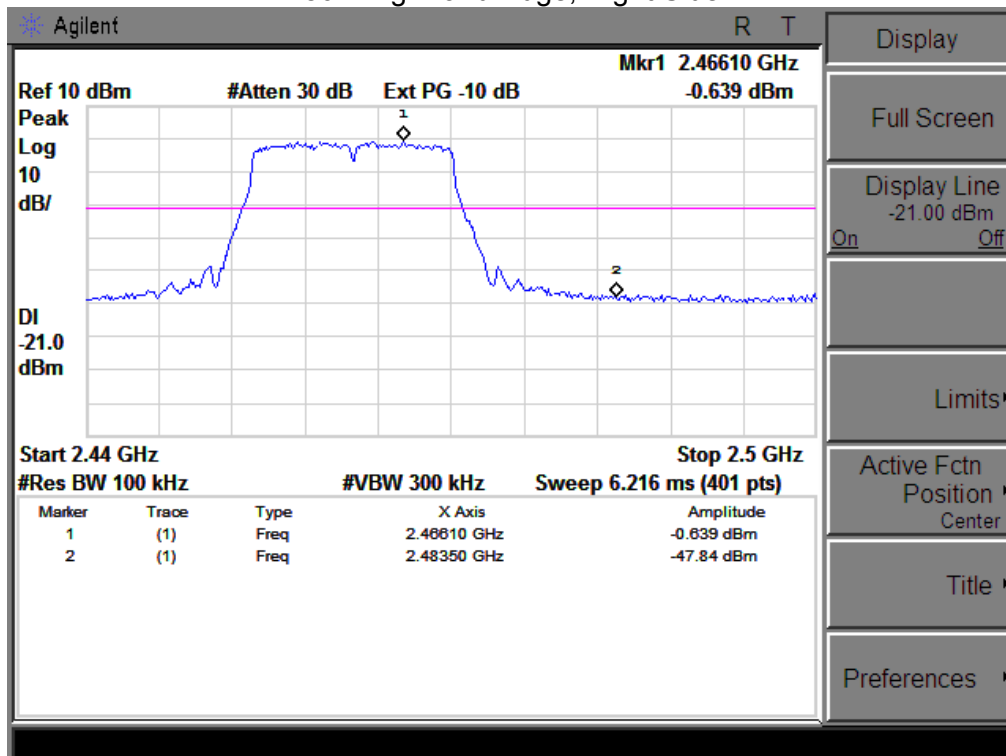

802.11n-HT20: Band Edge, Left Side

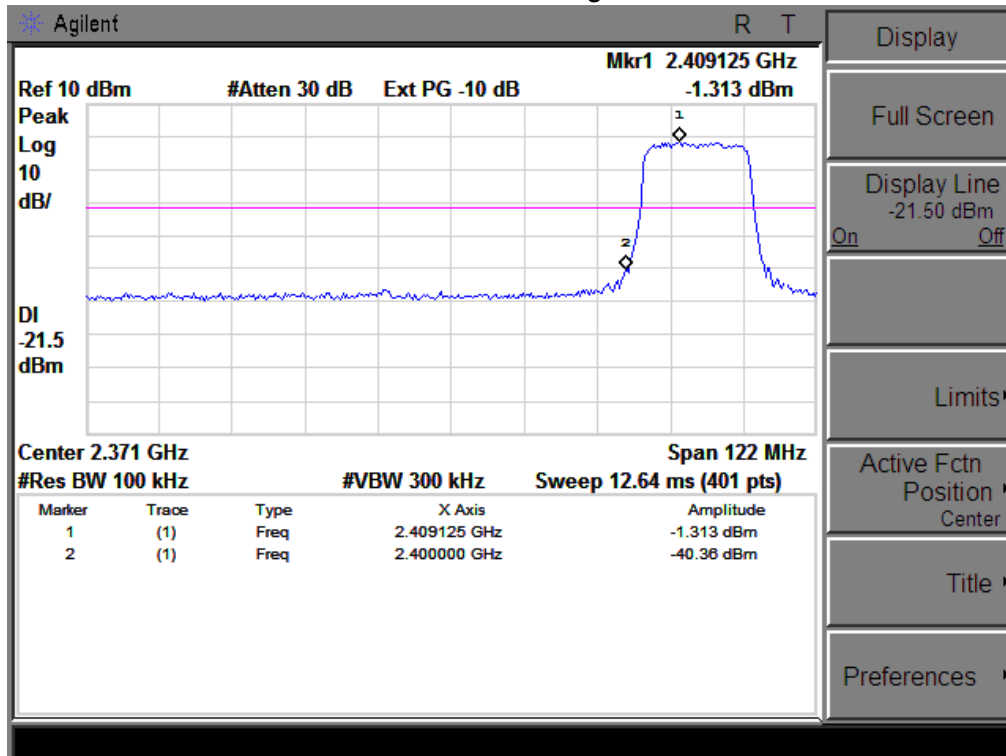

802.11n-HT20: Band Edge, Right Side

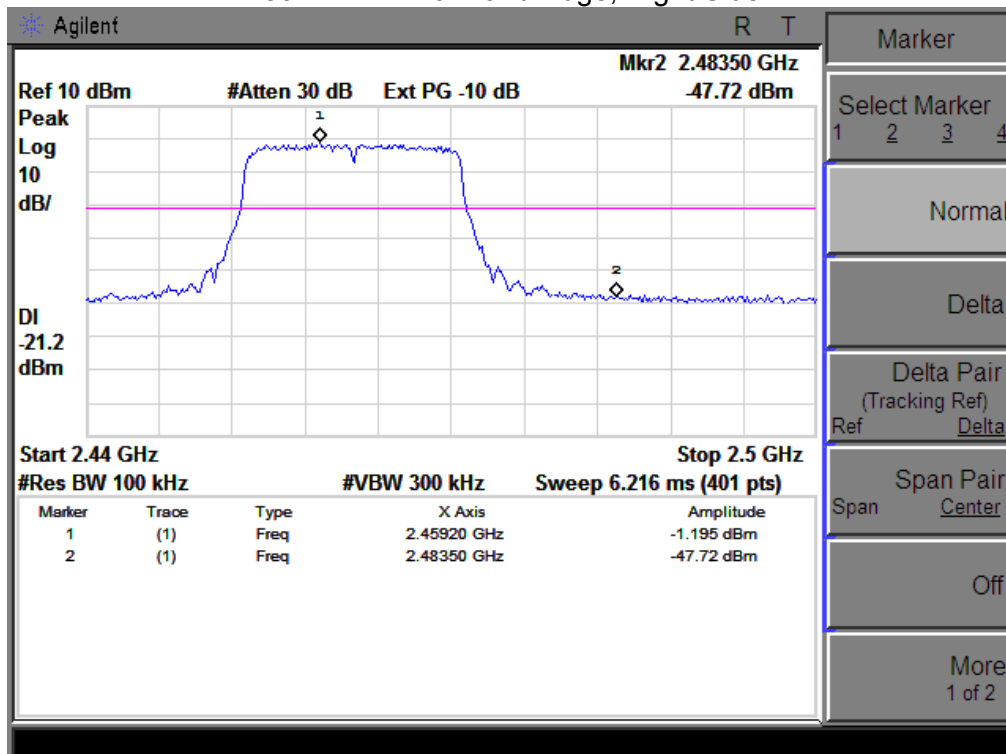

802.11n-HT40: Band Edge, Left Side

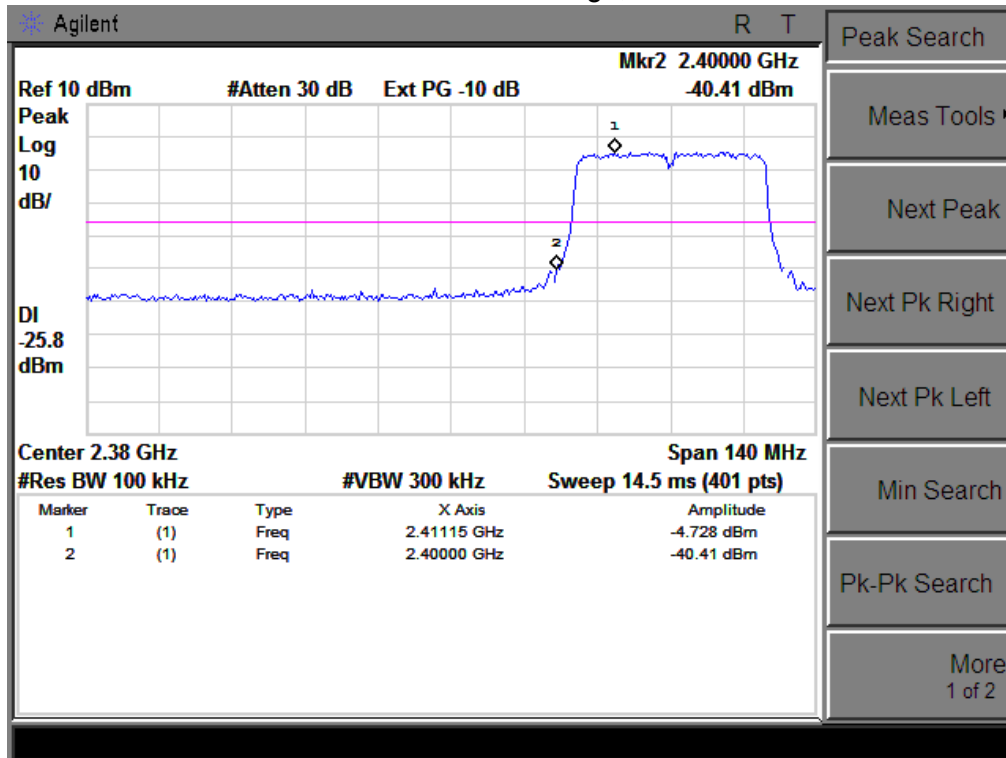

802.11n-HT40: Band Edge, Right Side

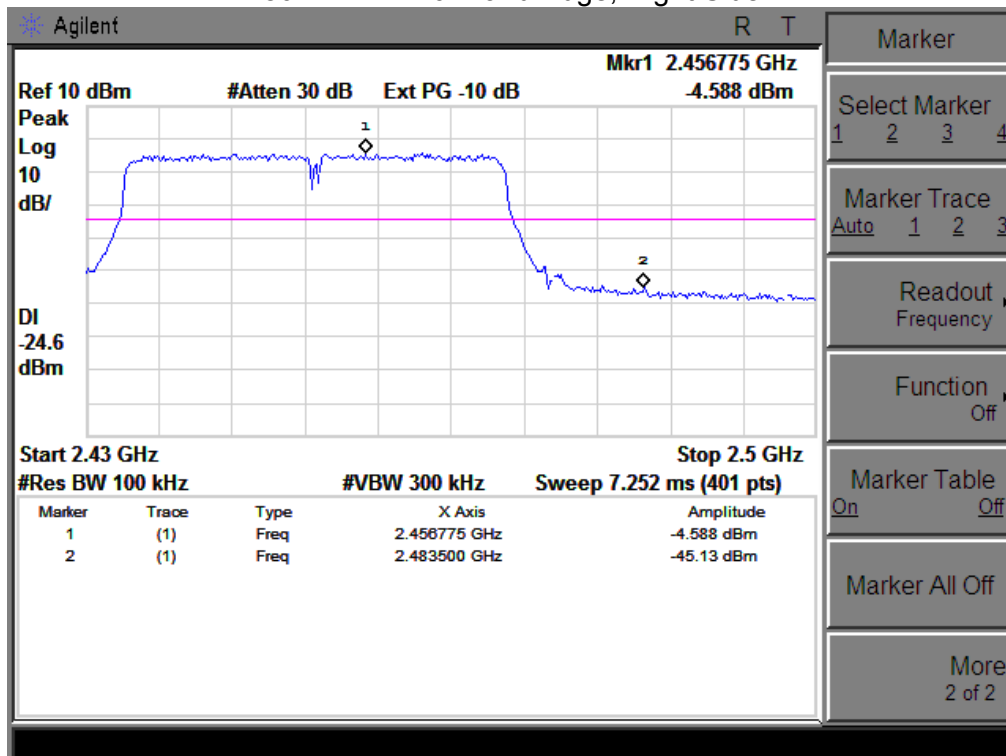

8. ANTENNA REQUIREMENT

8.1 STANDARD REQUIREMENT

15.203 requirement: For intentional device, according to 15.203: an intentional radiator shall be designed to ensure that no antenna other than that furnished by the responsible party shall be used with the device.

8.2 EUT ANTENNA

The EUT antenna is PCB Antenna. It comply with the standard requirement.

9. EUT TEST PHOTO

Radiated Measurement Photos

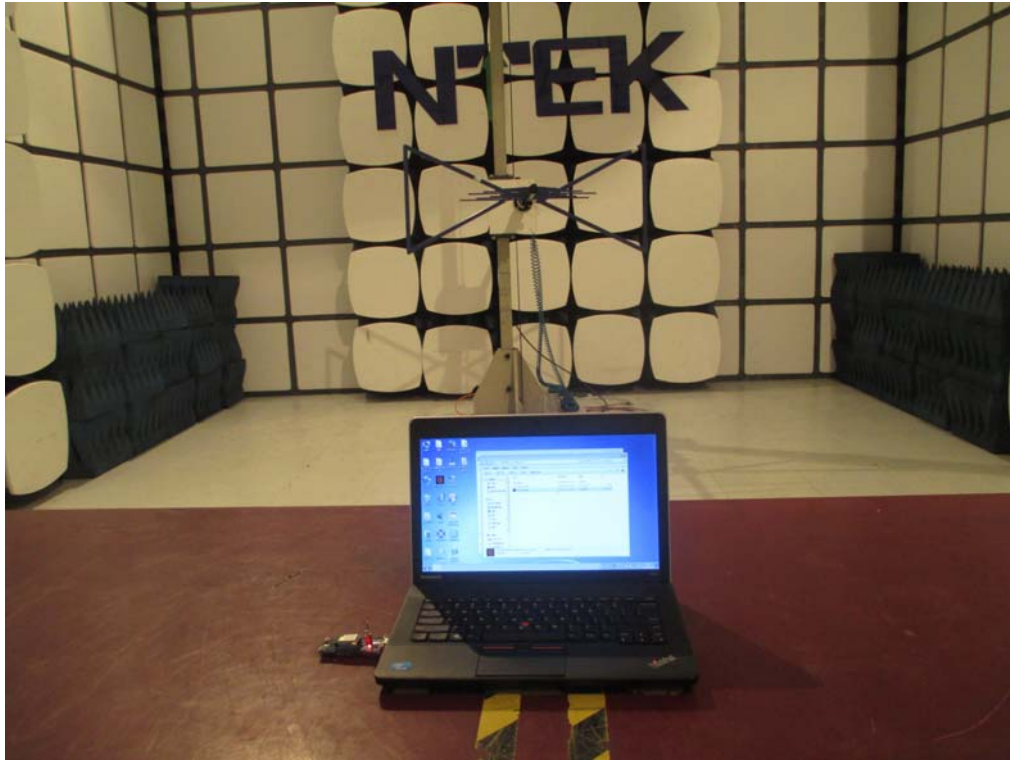

Conducted Measurement Photos

