

# SKW71 User Manual

## General Description

The module SKW71 compliant to 802.11 b/g/n Wi-Fi Solution for low power, low-cost, and highly integrated AP and consumer electronic devices, the module requiring only a external 3.3V power supply and connection to antenna.

The module based on the single chip AR9331 which integrates an 802.11n 1x1 MAC/BB/radio with internal PA and LNA. It supports 802.11n operations up to 72 Mbps for 20 MHz and 150 Mbps for 40 MHz channel respectively, and IEEE 802.11b/g data rates.

The module support AP mode and client mode and repeater mode and UART wifi.

## Applications

- AP WIFI
- UART WIFI
- Repeater WIFI
- IP TV
- IP DVD(Internet VOD Player)
- Set Top Box
- Home Gateways
- Gaming Consoles
- DVR

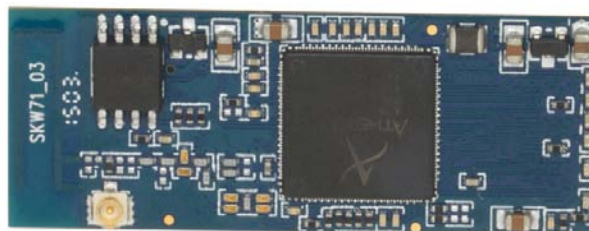

Figure 1: SKW71 Top View

## Features

- Compliant to IEEE 802.11b/g/n 1x1WLANs
- DDR2 memory up to 512Mb
- Flash memory up to 64Mb
- 1LAN ports and 1 WAN port
- High-speed UART
- USB 2.0 host device mode support
- Support AP/Client/Repeater mode
- Support UART to wifi transparent
- Security: WEP 64/128, WPA, WPA2, TKIP, AES, WAPI
- RoHS compliance meets environment-friendly requirement.
- 45(L) x 17.3(W) x 9.0(H) mm small dimension

## Module Pinout

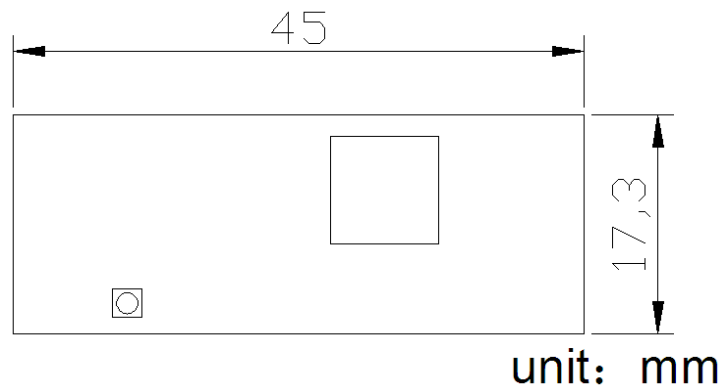

Figure 2: SKW71 Dimensions

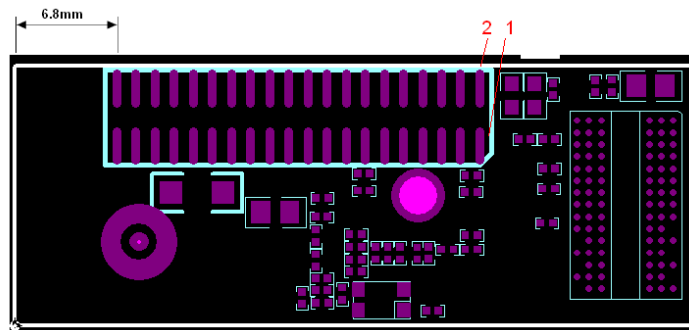

Figure 3: SKW71 Pin Package

## Pin Description

1	VDD_3.3V	3.3V input 1000mA, recommended voltage 3.3V,Min2.97V, MAX 3.63V
2	GND	Ground
3	GPIO_23	KEY_INPUT, be free for customer defined.
4	WAN_PORT_RX+	Ethernet port
5	I2S_WS(GPIO_19)	Word select for stereo
6	WAN_PORT_RX-	Ethernet port
7	I2S_MICIN(GPIO_22)	I2S Data input
8	WAN_PORT_TX+	Ethernet port
9	I2S_MCK(GPIO_21)	Master clock
10	WAN_PORT_TX-	Ethernet port
11	I2S_SD(GPIO_20)	Serial data input/output
12	LAN_PORT0_RX+	Ethernet port
13	I2S_CK(GPIO_18)	Stereo clock
14	LAN_PORT0_RX-	Ethernet port
15	USB +	USB signal, carries USB data to and from the USB 2.0 PHY
16	LAN_PORT0_TX+	Ethernet port
17	USB -	USB signal, carries USB data to and from the USB 2.0 PHY
18	LAN_PORT0_TX-	Ethernet port
19	LED7(GPIO_27)	SYSTEM LED
20	GND	Ground
21	LED8(GPIO_26)	JMP_START LED
22	VDD_2.0V OUTPUT	Power supply output for peripheral network transformer
23	RESET_CONFIG (UART_CTS) (GPIO_12)	resets the firmware to its default configuration, it has a internal 10k drop down resistance, and trigger while Pulling up
24	VDD_2.0V OUTPUT	Power supply output for peripheral network transformer
25	JUMPSTART (UART_RTS) (GPIO_11)	KEY_INPUT to start WPS function, it has a internal 10k drop down resistance, and trigger while Pulling up
26	GND	Ground
27	GND	Ground
28	SPI_MISO	SPI serial interface
29	VDD_3.3V	3.3V input 1000mA, recommended voltage 3.3V,Min2.97V, MAX 3.63V
30	SPI_CLK	SPI serial interface
31	VDD_3.3V	3.3V input 1000mA, recommended voltage 3.3V, Min2.97V, MAX 3.63V
32	SPI_MOSI	SPI serial interface
33	LED6 (GPIO_17)	WLAN LED

34	LED2 (GPIO_13)	LAN_PORT0_LED
35	LED1 (GPIO_1)	USB LED
36	LED0 (GPIO_0)	Wireless LED
37	UART_RX (SPI_CS1)	Serial data in
38	UART_TX (SPI_CS2)	Serial data out
39	GND	Ground
40	GND	Ground

**PCB Footprint and Dimensions**

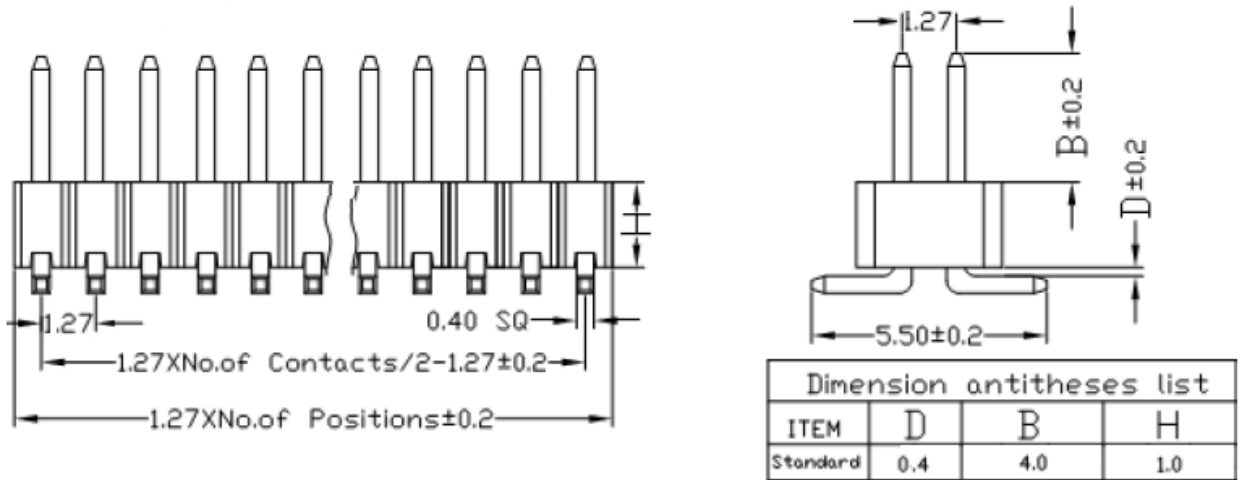
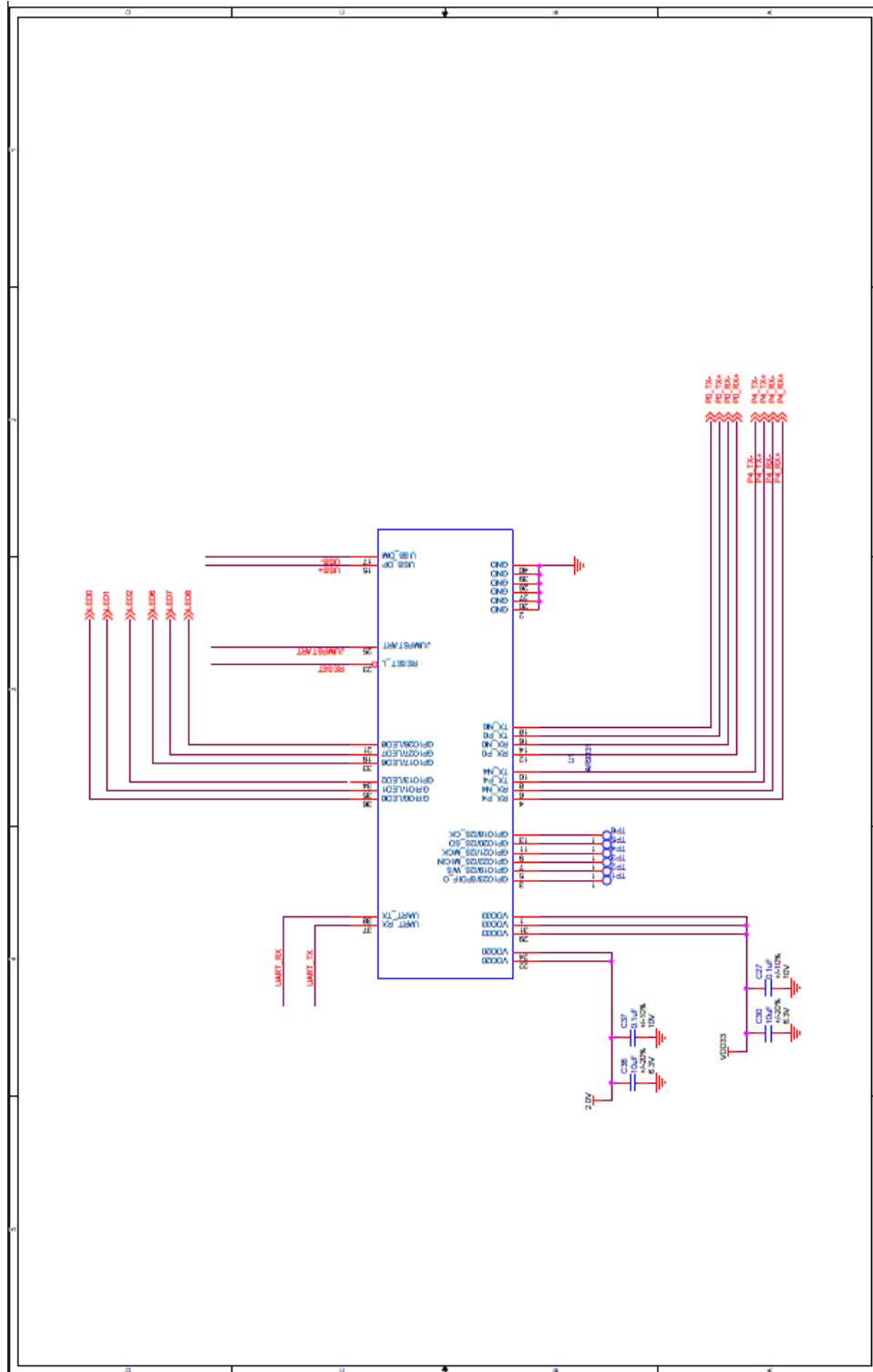
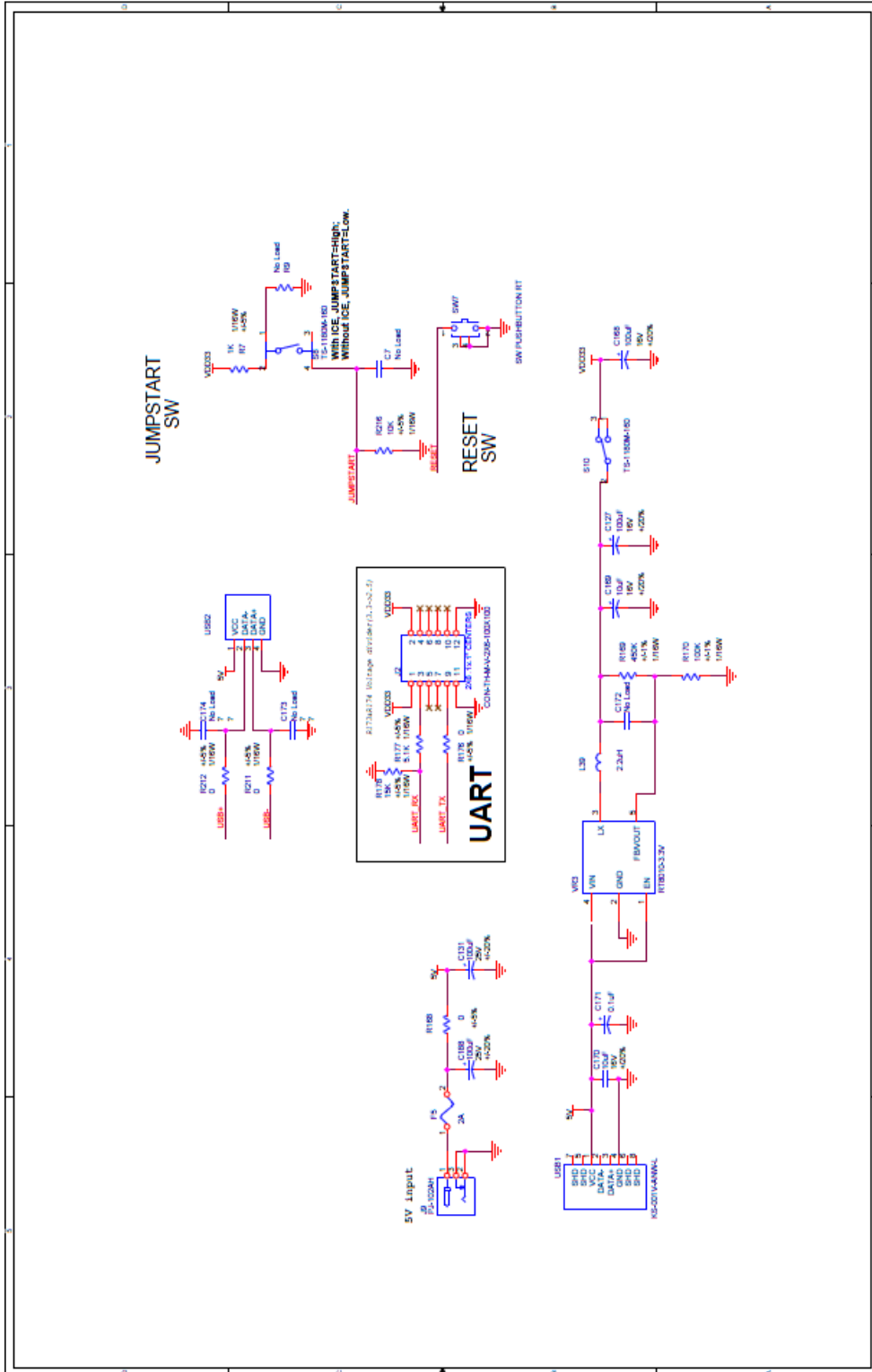
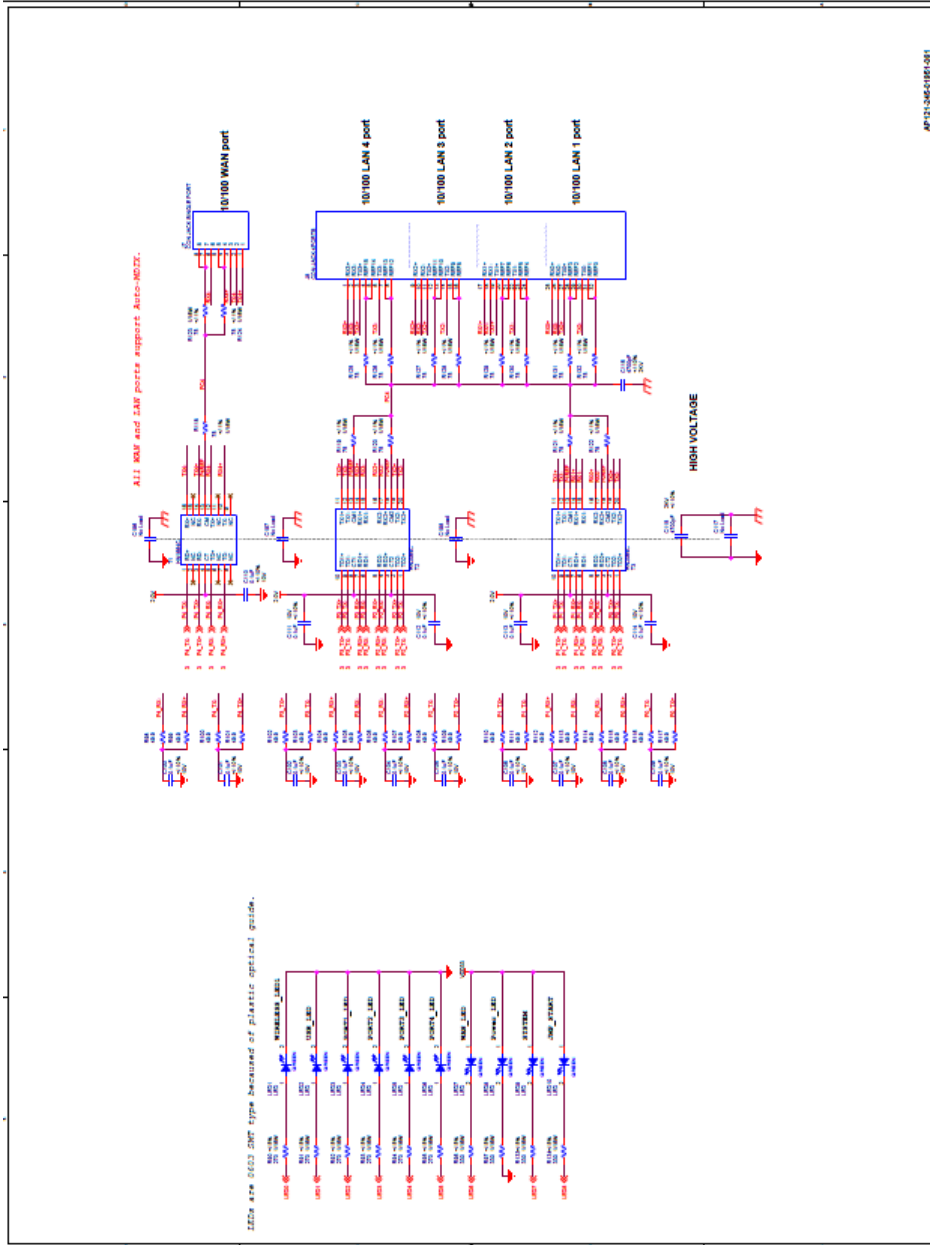

Figure 4: SKW71 Footprint

Reference design schematic







## Warning:

Changes or modifications not expressly approved by the party responsible for compliance could void your authority to operate the equipment.

NOTE: This equipment has been tested and found to comply with the limits for a Class B digital device, pursuant to Part 15 of the FCC Rules. These limits are designed to provide reasonable protection against harmful interference in a residential installation.

This equipment generates uses and can radiate radio frequency energy and, if not installed and used in accordance with the instructions, may cause harmful interference to radio communications.

However, there is no guarantee that interference will not occur in a particular installation. If this equipment does cause harmful interference to radio or television reception, which can be determined by turning the equipment off and on, the user is encouraged to try to correct the interference by one or more of the following measures:

- 1.Reorient or relocate the receiving antenna.
- 2.Increase the separation between the equipment and receiver.
- 3.Connect the equipment into an outlet on a circuit different from that to which the receiver is connected.
- 4.Consult the dealer or an experienced radio/TV technician for help.

Any company of the host device which install this modular with limit modular approval should perform the test of radiated emission and spurious emission according to FCC part 15C : 15.247 ; IC RSS 247 ;15.209 ; RSS GEN requirement , Only if the test result comply with FCC part 15C : 15.247 ; IC RSS 247 ;15.209 ; RSS GEN requirement , then the host can be sold legally.

## Skylab M&C Technology Co., Ltd.

Address: 9<sup>th</sup> Floor, Zhongguang Building, Yayuan Road, Bantian, Shenzhen

Phone: **86-755 8340 8210** (Sales Support)

Phone: **86-755 8340 8510** (Technical Support)

Fax: **86-755-8340 8560**

E-Mail: [sales1@skylab.com.cn](mailto:sales1@skylab.com.cn)

Website: [www.skylab.com.cn](http://www.skylab.com.cn)



## FCC Statement

This device complies with part 15 of the FCC Rules. Operation is subject to the following two conditions: (1) This device may not cause harmful interference, and (2) this device must accept any interference received, including interference that may cause undesired operation.

Changes or modifications not expressly approved by the party responsible for compliance could void the user's authority to operate the equipment.

NOTE: This equipment has been tested and found to comply with the limits for a Class B digital device, pursuant to Part 15 of the FCC Rules.

These limits are designed to provide reasonable protection against harmful interference in a residential installation. This equipment generates, uses and can radiate radio frequency energy and, if not installed and used in accordance with the instructions, may cause harmful interference to radio communications. However, there is no guarantee that interference will not occur in a particular installation. If this equipment does cause harmful interference to radio or television reception, which can be determined by turning the equipment off and on, the user is encouraged to try to correct the interference by one or more of the following

measures:

- Reorient or relocate the receiving antenna.
- Increase the separation between the equipment and receiver.
- Connect the equipment into an outlet on a circuit different from that to which the receiver is connected.
- Consult the dealer or an experienced radio/TV technician for help.

### FCC Radiation Exposure Statement

The modular can be installed or integrated in mobile or fix devices only. This modular cannot be installed in any portable device, for example, USB dongle like transmitters is forbidden.

This modular complies with FCC RF radiation exposure limits set forth for an uncontrolled environment. This transmitter must not be co-located or operating in conjunction with any other antenna or transmitter. This modular must be installed and operated with a minimum distance of 20 cm between the radiator and user body.

If the FCC identification number is not visible when the module is installed inside another device, then the outside of the device into which the module is installed must also display a label referring to the enclosed module. This exterior label can use wording such as the following:  
"Contains Transmitter Module FCC ID:2ACOE-SKW71 Or Contains FCC ID:2ACOE-SKW71"

when the module is installed inside another device, the user manual of this device must contain below warning statements;

1. This device complies with Part 15 of the FCC Rules. Operation is subject to the following two conditions:

- (1) This device may not cause harmful interference.
- (2) This device must accept any interference received, including interference that may cause undesired operation.

2. Changes or modifications not expressly approved by the party responsible for compliance could void the user's authority to operate the equipment.

The devices must be installed and used in strict accordance with the manufacturer's instructions as described in the user documentation that comes with the product

# IC STATEMENT

This device complies with Industry Canada's licence-exempt RSSs. Operation is subject to the following two conditions:

- (1) This device may not cause interference; and
- (2) This device must accept any interference, including interference that may cause undesired operation of the device.

Cet appareil est conforme aux CNR exemptes de licence d'Industrie Canada . Son fonctionnement est soumis aux deux conditions suivantes :

- ( 1 ) Ce dispositif ne peut causer d'interférences ; et
- ( 2 ) Ce dispositif doit accepter toute interférence , y compris les interférences qui peuvent causer un mauvais fonctionnement de l'appareil.

## IC Radiation Exposure Statement

The modular can be installed or integrated in mobile or fix devices only. This modular cannot be installed in any portable device, for example, USB dongle like transmitters is forbidden.

This modular complies with IC RF radiation exposure limits set forth for an uncontrolled environment. This transmitter must not be co-located or operating in conjunction with any other antenna or transmitter. This modular must be installed and operated with a minimum distance of 20 cm between the radiator and user body. Cette modulaire doit être installé et utilisé à une distance minimum de 20 cm entre le radiateur et le corps de l'utilisateur.

If the IC number is not visible when the module is installed inside another device, then the outside of the device into which the module is installed must also display a label referring to the enclosed module. This exterior label can use wording such as the following:

"Contains IC:20742-SKW71"

when the module is installed inside another device, the user manual of this device must contain below warning statements;

1. This device complies with Industry Canada's licence-exempt RSSs. Operation is subject to the following two conditions:

- (1) This device may not cause interference; and
- (2) This device must accept any interference, including interference that may cause undesired operation of the device.

2. Cet appareil est conforme aux CNR exemptes de licence d'Industrie Canada . Son fonctionnement est soumis aux deux conditions suivantes :

- ( 1 ) Ce dispositif ne peut causer d'interférences ; et
- ( 2 ) Ce dispositif doit accepter toute interférence , y compris les interférences qui peuvent causer un mauvais fonctionnement de l'appareil.

The devices must be installed and used in strict accordance with the manufacturer's instructions as described in the user documentation that comes with the product